

THE
ENCYCLOPEDIA
BRITANNICA
ELEVENTH
EDITION

VOL. XXII.
POL. TO REE

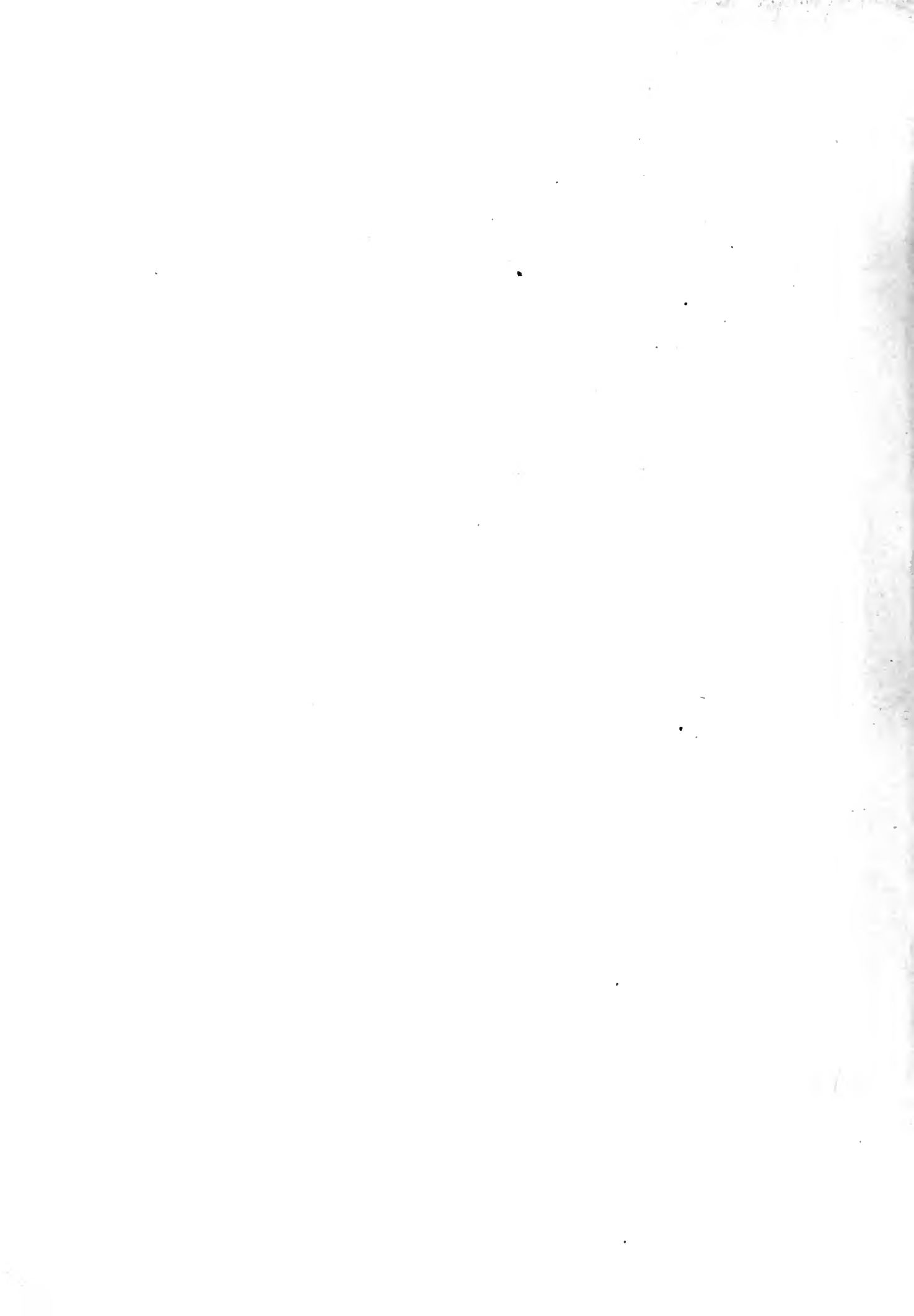

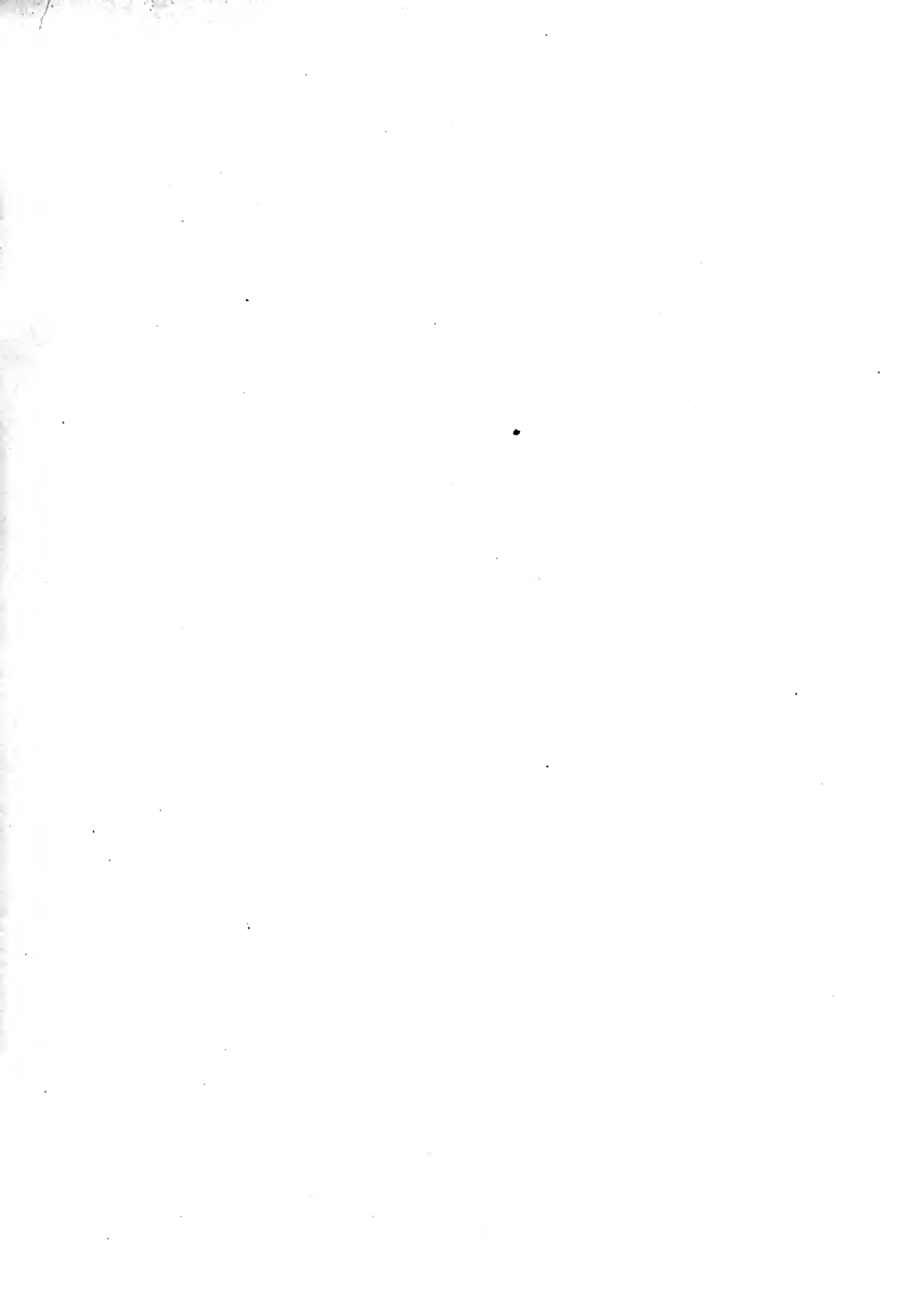

THE
ENCYCLOPÆDIA BRITANNICA

ELEVENTH EDITION

FIRST	edition, published in three	volumes,	1768—1771.
SECOND	„ „ ten	„	1777—1784.
THIRD	„ „ eighteen	„	1788—1797.
FOURTH	„ „ twenty	„	1801—1810.
FIFTH	„ „ twenty	„	1815—1817.
SIXTH	„ „ twenty	„	1823—1824.
SEVENTH	„ „ twenty-one	„	1830—1842.
EIGHTH	„ „ twenty-two	„	1853—1860.
NINTH	„ „ twenty-five	„	1875—1889.
TENTH	„ ninth edition and eleven supplementary volumes,		1902—1903.
ELEVENTH	„ published in twenty-nine volumes,		1910—1911.

COPYRIGHT
in all countries subscribing to the
Bern Convention
by
THE CHANCELLOR, MASTERS AND SCHOLARS
of the
UNIVERSITY OF CAMBRIDGE

All rights reserved

THE
ENCYCLOPÆDIA BRITANNICA

A
DICTIONARY
OF
ARTS, SCIENCES, LITERATURE AND GENERAL
INFORMATION

ELEVENTH EDITION

VOLUME XXII
POLL to REEVES



Cambridge, England:
at the University Press
New York, 35 West 32nd Street

1911

AE 5
• E 3
NR

Copyright, in the United States of America, 1911,
by
The Encyclopædia Britannica Company.

INITIALS USED IN VOLUME XXII. TO IDENTIFY INDIVIDUAL
CONTRIBUTORS,¹ WITH THE HEADINGS OF THE
ARTICLES IN THIS VOLUME SO SIGNED.

A. Bo.*	AUGUSTE BOUDINHON, D.D., D.C.L. Professor of Canon Law at the Catholic University of Paris. Honorary Canon of Paris. Editor of the <i>Canoniste Contemporain</i> .	{ Pope.
A. C. G.	ALBERT CHARLES LEWIS GOTTHILF GUENTHER, M.A., M.D., PH.D., F.R.S. Keeper of Zoological Department, British Museum, 1875-1895. Gold Medallist, Royal Society, 1878. Author of <i>Catalogues of Colubrine Snakes, Batrachia, Salientia and Fishes in the British Museum</i> ; &c.	{ Ray (<i>in part</i>).
A. C. McG.	REV. ARTHUR CUSHMAN MCGIFFERT, M.A., PH.D., D.D. Professor of Church History, Union Theological Seminary, New York. Author of <i>History of Christianity in the Apostolic Age</i> ; &c. Editor of the <i>Historia Ecclesia</i> of Eusebius.	{ Prophet (<i>in part</i>).
A. D.	AUSTIN DOBSON, LL.D., D.C.L. See the biographical article: DOBSON, HENRY AUSTIN.	{ Prior, Matthew.
A. de W. F.	ARTHUR DE WINT FOOTF. Superintendent of North Star Mining Company, California.	{ Power Transmission: Pneumatic.
A. E. G.*	REV. ALFRED ERNEST GARVIE, M.A., D.D. Principal of New College, Hampstead. Member of the Board of Theology and the Board of Philosophy, London University. Author of <i>Studies in the Inner Life of Jesus</i> ; &c.	{ Predestination.
A. E. H.	A. E. HOUGHTON. Formerly Correspondent of the <i>Standard</i> in Spain. Author of <i>Restoration of the Bourbons in Spain</i> .	{ Quesada y Matheus.
A. E. S.	ARTHUR EVERETT SHIPLEY, M.A., D.Sc., F.R.S. Master of Christ's College, Cambridge. Reader in Zoology, Cambridge University. Joint-editor of the <i>Cambridge Natural History</i> .	{ Priapuloida.
A. G.	MAJOR ARTHUR GEORGE FREDERICK GRIFFITHS (d. 1908). H.M. Inspector of Prisons, 1878-1896. Author of <i>The Chronicles of Newgate</i> ; <i>Secrets of the Prison House</i> ; &c.	{ Prison.
A. Ha.	ADOLF HARNACK, PH.D. See the biographical article: HARNACK, ADOLF.	{ Prophet (<i>in part</i>).
A. J. G.	REV. ALEXANDER JAMES GRIEVE, M.A., B.D. Professor of New Testament and Church History, Yorkshire United Independent College, Bradford. Sometime Registrar of Madras University, and Member of Mysore Educational Service.	{ Preaching; Primitive Methodist Church; Priscillian.
A. L.	ANDREW LANG. See the biographical article: LANG, ANDREW.	{ Poltergeist; Prometheus; Psychical Research.
A. McA.	ALEXANDER MCAULAY, M.A. Professor of Mathematics and Physics, University of Tasmania. Author of <i>Utility of Quaternions in Physics</i> ; &c.	{ Quaternions (<i>in part</i>).
A. M. Cl.	AGNES MURIEL CLAY (Mrs Edward Wilde). Formerly Resident Tutor of Lady Margaret Hall, Oxford. Joint-author of <i>Sources of Roman History, 133-70 B.C.</i>	{ Publicani.
A. N.	ALFRED NEWTON, F.R.S. See the biographical article: NEWTON, ALFRED.	{ Pratincole; Quail; Quezal; Rail (<i>in part</i>); Raven; Razorbill; Redshank; Redstart; Redwing.

¹ A complete list, showing all individual contributors, appears in the final volume.

vi INITIALS AND HEADINGS OF ARTICLES

A. Sl.	ARTHUR SHADWELL, M.A., M.D., LL.D. Member of Council of Epidemiological Society. Author of <i>The London Water-Supply; Industrial Efficiency; Drink, Temperance and Legislation.</i>	Prostitution.
A. S. P.-P.	ANDREW SETH PRINGLE-PATTISON, M.A., LL.D., D.C.L. Professor of Logic and Metaphysics in the University of Edinburgh. Gifford Lecturer in the University of Aberdeen, 1911. Fellow of the British Academy. Author of <i>Man's Place in the Cosmos; The Philosophical Radicals; &c.</i>	Pythagoras (in part).
A. S. Wo.	ARTHUR SMITH WOODWARD, LL.D., F.R.S. Keeper of Geology, Natural History Museum, South Kensington. Secretary of the Geological Society of London.	Pterodactyles.
A. T. H.	ARTHUR TWINING HADLEY, LL.D. See the biographical article: HADLEY, ARTHUR TWINING.	Railways: Economics.
A. Wi.*	ANEURIN WILLIAMS, M.A. Barrister-at-Law of the Inner Temple. Chairman of Executive, International Co-operative Alliance. M.P. for Plymouth, 1910. Author of <i>Twenty-eight Years of Co-partnership at Guise; &c.</i>	Profit-sharing.
A. W. Po.	ALFRED WILLIAM POLLARD, M.A. Assistant Keeper of Printed Books, British Museum. Fellow of King's College, London. Hon. Secretary, Bibliographical Society. Editor of <i>Books about Books and Bibliographica</i> . Joint-editor of the <i>Library</i> . Chief Editor of the "Globe" <i>Chaucer</i> .	Polyglott.
A. W. R.	ALEXANDER WOOD RENTON, M.A., LL.B. Puisne Judge of the Supreme Court of Ceylon. Editor of <i>Encyclopaedia of the Laws of England</i> .	Proclamation.
B. B. A.	BRAMAN BLANCHARD ADAMS. Associate Editor of the <i>Railway Age Gazette</i> , New York.	Railways: Accident Statistics.
C. B.*	CHARLES BÉMONT, D.LITT. See the biographical article: BÉMONT, C.	Quicherat.
C. E. W.	C. E. WEBBER, C.B., M.INST.C.E., M.I.E.E. (1838-1905). Major-General, Royal Engineers. Served in Indian Mutiny, 1857-1860; Egyptian Expedition, 1882; &c. Founder (with late Sir Francis Bolton) and Past President of the Institute of Electrical Engineers.	Railways: Light Railways (in part).
C. F. A.	CHARLES FRANCIS ATKINSON. Formerly Scholar of Queen's College, Oxford. Captain, 1st City of London (Royal Fusiliers). Author of <i>The Wilderness and Cold Harbour</i> .	Ravenna: Battle of 1512.
C. G. Cr.	CHARLES GEORGE CRUMP, M.A. Balliol College, Oxford. Clerk in H.M. Public Record Office, London. Editor of <i>Landor's Works; &c.</i>	Record.
C. Hi.	CHARLES HIAIT. Author of <i>Picture Posters; &c.</i>	Poster.
C. H. Ha.	CARLTON HUNTLEY HAYES, A.M., PH.D. Assistant Professor of History in Columbia University, New York City. Member of the American Historical Association.	Purgatory.
C. H. T.*	CRAWFORD HOWELL TOY, A.M., LL.D. See the biographical article: TOY, CRAWFORD HOWELL.	Proverbs, Book of.
C. R. B.	CHARLES RAYMOND BEAZLEY, M.A., D.LITT., F.R.G.S., F.R.HIST.S. Professor of Modern History in the University of Birmingham. Formerly Fellow of Merton College, Oxford, and University Lecturer in the History of Geography. Lothian Prizeman, Oxford, 1889. Lowell Lecturer, Boston, 1908. Author of <i>Henry the Navigator; The Dawn of Modern Geography; &c.</i>	Polo, Marco (in part); Ptolemy (in part); Pytheas (in part).
C. T. J.	CHARLES T. JACOBI. Managing Partner of the Chiswick Press, London. Author of <i>Printing; &c.</i>	Printing.
D. B. Ma.	DUNCAN BLACK MACDONALD, M.A., D.D. Professor of Semitic Languages, Hartford Theological Seminary, Hartford, Conn. Author of <i>Development of Muslim Theology, Jurisprudence and Constitutional Theory; Selections from Ibn Khaldun; Religious Attitude and Life in Islam; &c.</i>	Ramadān.
D. C. B.	DEMETRIUS CHARLES BOULGER. Author of <i>England and Russia in Central Asia; History of China; Life of Gordon; India in the 19th Century; History of Belgium; &c.</i>	Raffles, Sir Thomas.
D. D. A.	REV. DANIEL DULANY ADDISON, D.D. Rector of All Saints' Church, Brookline, Mass. Examining Chaplain to Bishop of Massachusetts. Secretary, Cathedral Chapter of Diocese of Massachusetts. Author of <i>The Episcopalians; &c.</i>	Protestant Episcopal Church.
D. F. T.	DONALD FRANCIS TOVEY. Author of <i>Essays in Musical Analysis</i> : comprising <i>The Classical Concerto, The Goldberg Variations</i> , and analyses of many other classical works.	Programme Music.
D. G. H.	DAVID GEORGE HOGARTH, M.A. Keeper of the Ashmolean Museum, Oxford. Fellow of Magdalen College, Oxford. Fellow of the British Academy. Excavated at Paphos, 1888; Naucratis, 1899 and 1903; Ephesus, 1904-1905; Assiut, 1906-1907. Director, British School at Athens, 1897-1900. Director, Cretan Exploration Fund, 1899.	Prlene; Pteria.

- D. H.** DAVID HANNAY.
Formerly British Vice-Consul at Barcelona. Author of *Short History of the Royal Navy*; *Life of Emilio Castelar*; &c. { **Quiberon, Battle of;**
Raleigh, Sir Walter.
- D. H. S.** DUKINFIELD HENRY SCOTT, M.A., PH.D., LL.D., F.R.S.
President of the Linnean Society. Professor of Botany, Royal College of Science, London, 1885-1892. Author of *Structural Botany*; *Studies in Fossil Botany*; &c. { **Pringsheim, Nathanael.**
- D. W. T.** D'ARCY WENTWORTH THOMPSON, C.B., M.A.
Professor of Natural History, University College, Dundee. British Delegate, Bering Sea Fisheries and other Conferences. Author of *A Glossary of Greek Birds*; &c. { **Ray, John.**
- E. A. J.** E. ALFRED JONES.
Author of *Old English Gold Plate*; *Old Church Plate of the Isle of Man*; *Old Silver Sacramental Vessels of Foreign Protestant Churches in England*; *Illustrated Catalogue of Leopold de Rothschild's Collection of Old Plate*; *A Private Catalogue of the Royal Plate at Windsor Castle*; &c. { **Qualch.**
- E. A. M.** EDWARD ALFRED MINCHIN, M.A., F.Z.S.
Professor of Protozoology in the University of London. Formerly Fellow of Merton College, Oxford, and Jodrell Professor of Zoology and Comparative Anatomy, University College, London. { **Polyp;**
Protoplasm;
Protozoa.
- E. Ba.** EDWIN BALE, R.I.
Art Director, Cassell & Company, Ltd. Member of the Royal Institute of Painters in Water Colours. Hon. Sec., Artists' Copyright Committee. { **Process.**
- E. Br.** ERNEST BARKER, M.A.
Fellow and Lecturer in Modern History, St John's College, Oxford. Formerly Fellow and Tutor of Merton College. Craven Scholar, 1895. { **Raymund of Antioch;**
Raymund of Toulouse;
Raymund of Tripoli;
Raynald of Châtillon.
- E. B. E.** EDWARD B. ELLINGTON.
Founder and Chief Engineer of the General Hydraulic Power Co., Ltd. Author of Contributions to *Proceedings* of Institutions of Civil Engineers and of Mechanical Engineers. { **Power Transmission:**
Hydraulic.
- E. C. B.** RIGHT REV. EDWARD CUTHBERT BUTLER, M.A., O.S.B., LITT.D.
Abbot of Downside Abbey, Bath. Author of "The Lausiac History of Palladius" in *Cambridge Texts and Studies*. { **Premonstratensians;**
Rance, Armand de.
- E. G.** EDMUND GOSSE, LL.D., D.C.L.
See the biographical article: GOSSE, EDMUND. { **Prologue; Prosc.**
- E. Ga.** EMILE GARCKE, M.INST.E.E.
Managing Director of British Electric Traction Co., Ltd. Author of *Manual of Electrical Undertakings*; &c. { **Railways: Light Railways (in part).**
- E. Gr.** ERNEST ARTHUR GARDNER, M.A.
See the biographical article: GARDNER, PERCY. { **Propylaea.**
- E. G. C.** ERNEST GEORGE COKER, M.A., D.Sc., F.R.S.(Edin.), M.Sc., M.I.MECH.E.
Professor of Mechanical Engineering in the City and Guilds of London Technical College. Author of various papers in *Transactions* of the Royal Societies of London, Edinburgh and Canada; &c. { **Pulley.**
- E. H. B.** SIR EDWARD HERBERT BUNBURY, Bart., M.A., F.R.G.S. (d. 1895).
M.P. for Bury St Edmunds, 1847-1852. Author of *A History of Ancient Geography*; &c. { **Pompeii (in part);**
Ptolemy (in part);
Pytheas (in part).
- E. J. J.** EDMUND JANES JAMES, A.M., PH.D., LL.D.
President of the University of Illinois; President of American Economic Association. Author of *History of American Tariff Legislation*, and Essays and Monographs on Economic, Financial, Political and Educational subjects. { **Protection.**
- E. O'N.** ELIZABETH O'NEILL, M.A. (Mrs H. O. O'Neill).
Formerly University Fellow and Jones Fellow of the University of Manchester. { **Prebendary; Prelate;**
Prior; Procurator.
- E. Pr.** EDGAR PRESTAGE.
Special Lecturer in Portuguese Literature in the University of Manchester. Examiner in Portuguese in the Universities of London, Manchester, &c. Commendador, Portuguese Order of S Thiago. Corresponding Member of Lisbon Royal Academy of Sciences, Lisbon Geographical Society; &c. Editor of *Letters of a Portuguese Nun*; *Azurara's Chronicle of Guinea*; &c. { **Portugal: Literature.**
- E. Ru.** ERNEST RUTHERFORD, F.R.S., D.Sc., LL.D., PH.D.
Langworthy Professor of Physics, University of Manchester. Nobel Prize for Chemistry, 1908. Author of *Radio-activity*; *Radio-active Transformations*; &c. { **Radio-activity.**
- E. R. B.** EDWYN ROBERT BEVAN, M.A.
New College, Oxford. Author of *The House of Seleucus*; *Jerusalem under the High Priests*. { **Ptolemies.**
- F. C. C.** FREDERICK CORNWALLIS CONYBEARE, M.A., D.TII.
Fellow of the British Academy. Formerly Fellow of University College, Oxford. Editor of *The Ancient Armenian Texts of Aristotle*. Author of *Myth, Magic and Morals*; &c. { **Purification.**

INITIALS AND HEADINGS OF ARTICLES

- F. C. S. S.** FERDINAND CANNING SCOTT SCHILLER, M.A., D.Sc.
Fellow and Tutor of Corpus Christi College, Oxford. Author of *Riddles of the Sphinx*; *Studies in Humanism*; &c. } **Pragmatism.**
- F. Dr.** FRANCIS M. D. DRUMMOND. } **Precedence (in part).**
- F. D. A.** FRANK DAWSON ADAMS, PH.D., D.Sc., F.G.S., F.R.S.
Dean of the Faculty of Applied Science and Logan Professor of Geology, McGill University, Montreal; President of Canadian Mining Institute. Author of Papers dealing with problems of Metamorphism, &c., also Researches on Experimental Geology; &c. } **Quebec (in part);
Queen Charlotte Islands.**
- F. E. W.** REV. FREDERICK EDWARD WARREN, M.A., F.S.A.
Rector of Bardwell, Bury St Edmunds, and Honorary Canon of Ely. Fellow of St John's College, Oxford, 1865-1882. Author of *The Old Catholic Ritual done into English and compared with the Corresponding Offices in the Roman and Old German Manuals*; *The Liturgy and Ritual of the Celtic Church*; &c. } **Prayer, Book of Common.**
- F. G. P.*** FRANK GEORGE POPE.
Lecturer on Chemistry, East London College (University of London). } **Purin.**
- F. H. D.*** FRANK HAIGH DIXON, PH.D., A.M.
Professor of Economics, Dartmouth College, Hanover, N.H. Member of the National Waterways Commission. Author of *State Railroad Control*. } **Railways: American Railway
Legislation.**
- F. J. H. M.** HON. FREDERICK JAMES HAMILTON MERRILL, PH.D., F.G.S.(America), M.
AMERICAN INST.M.E., &c.
Consulting Geologist and Mining Engineer. State Geologist of New York, 1899-1904. Author of *Reports of New Jersey and New York Geological Surveys*; &c. } **Quarrying.**
- F. K.*** FERNAND KHNOPFF.
See the biographical article: KHNOPFF, F. E. J. M. } **Portaels, J. F.**
- F. LL. G.** FRANCIS LLEWELLYN GRIFFITH, M.A., PH.D., F.S.A.
Reader in Egyptology, Oxford University. Editor of the Archaeological Survey and Archaeological Reports of the Egypt Exploration Fund. Fellow of Imperial German Archaeological Institute. Author of *Stories of the High Priests of Memphis*; &c. } **Psammetichus;
Rameses (in part).**
- F. M. L.*** FRANCIS MANLEY LOWE.
Major R.A. (retired). Member of the Staff of Sir W. G. Armstrong, Whitworth & Co., Ltd., Elswick Works. Assistant-Superintendent of Experiments, Shoeburyness, 1898-1903. Author of articles in the *Proceedings of the Royal Artillery Institution*; &c. } **Range-finder.**
- F. P.** FRANK PODMORE, M.A. (d. 1910).
Pembroke College, Oxford. Author of *Studies in Psychological Research*; *Modern Spiritualism*; &c. } **Premonition.**
- F. R. C.** FRANK R. CANA.
Author of *South Africa from the Great Trek to the Union*. } **Portuguese East Africa;
Rabah Zobeir.**
- F. Wa.** FRANCIS WATT, M.A.
Barrister-at-Law, Middle Temple. Author of *Law's Lumber Room*. } **Pound (in part).**
- F. W. R.*** FREDERICK WILLIAM RUDLER, I.S.O., F.G.S.
Curator and Librarian of the Museum of Practical Geology, London, 1879-1902. President of the Geologists' Association, 1887-1889. } **Pyrites;
Pyrope.**
- F. Y. E.** FRANCIS YSIDRO EDGEWORTH, M.A., D.C.L.
Professor of Political Economy in the University of Oxford. Fellow of All Souls' College, Oxford, and of King's College, London. Editor of the *Economic Journal*. Author of *Mathematical Psychics*, and numerous papers on the Calculus of Probabilities in the *Philosophical Magazine*; &c. } **Probability.**
- G. A. Gr.** GEORGE ABRAHAM GRIERSON, C.I.E., PH.D., D.LITT.
Indian Civil Service, 1873-1903. In charge of Linguistic Survey of India, 1898-1902. Gold Medallist, Royal Asiatic Society, 1909. Vice-President of the Royal Asiatic Society. Formerly Fellow of Calcutta University. Author of *The Languages of India*; &c. } **Prakrit;
Rajasthani.**
- G. C. W.** GEORGE CHARLES WILLIAMSON, LITT.D.
Chevalier of the Legion of Honour. Author of *Portrait Miniatures*; *Life of Richard Cosway, R.A.*; *George Engleheart*; *Portrait Drawings*; &c. Editor of New Edition of Bryan's *Dictionary of Painters and Engravers*. } **Prieur, Pierre.**
- G. E.*** ROBERT GEOFFREY ELLIS.
Peterhouse, Cambridge. Barrister-at-Law, Inner Temple. Joint-editor of *English Reports*. Author of *Peerage Law and History*. } **Privy Council.**
- G. G. S.** GEORGE GREGORY SMITH, M.A.
Professor of English Literature, Queen's University, Belfast. Author of *The Days of James IV.*; *The Transition Period*; *Specimens of Middle Scots*; &c. } **Ramsay, Allan.**
- G. J. A.** GEORGE JOHNSTON ALLMAN, M.A., LL.D., F.R.S., D.Sc. (1824-1905).
Professor of Mathematics in Queen's College, Galway, and in Queen's University of Ireland, 1853-1893. Author of *Greek Geometry from Thales to Euclid*; &c. } **Ptolemy (in part);
Pythagoras: Geometry.**
- G. J. T.** GEORGE JAMES TURNER.
Barrister-at-Law, Lincoln's Inn. Editor of *Select Pleas of the Forests for the Selden Society*. } **Provision;
Rape.**

- G. Re.** SIR GEORGE REID, LL.D.
See the biographical article: REID, SIR GEORGE. { **Portraiture.**
- G. Sa.** GEORGE SAINTSBURY, LL.D., D.C.L.
See the biographical article: SAINTSBURY, GEORGE E. B. { **Quinet; Rabelais;
Racine.**
- G. W. T.** REV. GRIFFITHS WHEELER THATCHER, M.A., B.D.
Warden of Camden College, Sydney, N.S.W. Formerly Tutor in Hebrew and Old
Testament History at Mansfield College, Oxford. { **Rāwendis.**
- H. A. Y.** HORATIO ARTHUR YORKE, C.B.
Lieut.-Colonel, R.E. (retired). Chief Inspecting Officer of Railways, Board of
Trade. Served in Afghan War, 1879-1880; Nile Expedition, 1884-1885. { **Railways: British Railway
Legislation.**
- H. D. W.** SIR HENRY DRUMMOND WOLFF, G.C.B., G.C.M.G. (1830-1908).
Ambassador Extraordinary and Plenipotentiary at Madrid, 1892-1900. M.P. for
Christchurch, 1874-1880; for Portsmouth, 1880-1885. Author of *A Life of
Napoleon at Elba*; &c. { **Primrose League.**
- H. Fr.** HENRI FRANTZ.
Art Critic, *Gazette des beaux arts*, Paris. { **Puvis de Chavannes.**
- H. F. G.** HANS FRIEDRICH GADOW, F.R.S., PH.D.
Strickland Curator and Lecturer on Zoology in the University of Cambridge. Author
of "Amphibia and Reptiles" in the *Cambridge Natural History*; &c. { **Python;
Ratitae;
Rattlesnake (in part).**
- H. F. P.** HENRY FRANCIS PELHAM, LL.D., D.C.L.
See the biographical article: PELHAM, H. F. { **Polybius (in part).**
- H. M. R.** HUGH MUNRO ROSS.
Formerly Exhibitioner of Lincoln College, Oxford. Editor of *The Times Engineering
Supplement*. Author of *British Railways*. { **Railways: Introduction, Con-
struction, Rolling Stock.**
- H. N. D.** HENRY NEWTON DICKSON, M.A., D.Sc., F.R.S. (Edin.), F.R.G.S.
Professor of Geography at University College, Reading. Formerly Vice-President,
Royal Meteorological Society. Lecturer in Physical Geography, Oxford University.
Author of *Meteorology*; *Elements of Weather and Climate*; &c. { **Red Sea.**
- H. O.** HERMANN OELSNER, M.A., PH.D.
Taylorian Professor of the Romance Languages in the University of Oxford. Mem-
ber of Council of the Philological Society. Author of *A History of Provençal Litera-
ture*; &c. { **Provençal Literature:
Modern.**
- H. R. L.** THE REV. HENRY RICHARDS LUARD, M.A., D.D. (1825-1891).
Registrary of the University of Cambridge, 1862-1891. Formerly Fellow, Bursar
and Lecturer at Trinity College. Honorary Fellow of King's College, London.
Editor of the *Annales Monastici*; the *Historia* of Matthew Paris and other works
for the "Rolls" Series. { **Porson (in part).**
- H. Ti.** HENRY TIEDEMANN.
London Editor of the *Nieuwe Rotterdamsche Courant*. Author of a Dutch biography,
and various pamphlets and travel works, including *Via Flushing*. { **Potgieter.**
- H. T. A.** REV. HERBERT THOMAS ANDREWS.
Professor of New Testament Exegesis, New College, London. Author of "The
Commentary on Acts" in the *Westminster New Testament*; *Handbook on the
Apocryphal Books* in the "Century" Bible. { **Polycarp;
Presbyter.**
- H. W. C. D.** HENRY WILLIAM CARLESS DAVIS, M.A.
Fellow and Tutor of Balliol College, Oxford. Fellow of All Souls' College, Oxford,
1895-1902. Author of *England under the Normans and Angevins*; *Charlemagne*. { **Ralph of Coggeshall.**
- H. Y.** SIR HENRY YULE, K.C.S.I., C.B.
See the biographical article: YULE, SIR HENRY. { **Polo, Marco (in part);
Prester John; Ramusio.**
- I. A.** ISRAEL ABRAHAMS, M.A.
Reader in Talmudic and Rabbinic Literature in the University of Cambridge.
Formerly President, Jewish Historical Society of England. Author of *A Short
History of Jewish Literature*; *Jewish Life in the Middle Ages*; *Judaism*; &c. { **Proselyte; Qaraites; Qaro;
Raba Ben Joseph Ben Hama
Rabbah Bar Nahmani;
Rapoport, Samuel;
Rashbam; Rashl.**
- J. A. B.** SIR JERVOISE ATHEISTANE BAINES, C.S.I.
President, Royal Statistical Society, 1909-1910. Census Commissioner under
the Government of India, 1889-1893. Secretary to Royal Commission on Opium,
1894-1895. Author of *Official Reports on Provincial Administration of Indian
Census Operations*; &c. { **Population.**
- J. A. Bl.** JOHN A. BLACK.
Press reader of the New Volumes of the *Encyclopaedia Britannica* (10th ed.). { **Proof-reading (in part).**
- J. A. H.** JOHN ALLEN HOWE, B.Sc.
Curator and Librarian of the Museum of Practical Geology, London. Author of
The Geology of Building Stones. { **Pre-Cambrian.**
- J. A. S.** JOHN ADDINGTON SYMONDS, LL.D.
See the biographical article: SYMONDS, JOHN A. { **Pontanus, Jovianus.**
- J. E. S.*** JOHN EDWIN SANDYS, M.A., LITT.D., LL.D.
Public Orator in the University of Cambridge. Fellow of St John's College,
Cambridge. Fellow of the British Academy. Author of *A History of Classical
Scholarship*; &c. { **Porson (in part).**

INITIALS AND HEADINGS OF ARTICLES

- J. F.-K.** JAMES FITZMAURICE-KELLY, LITT.D., F.R.HIST.S.
Gilmour Professor of Spanish Language and Literature, Liverpool University. Norman McColl Lecturer, Cambridge University. Fellow of the British Academy. Member of the Royal Spanish Academy. Knight Commander of the Order of Alphonso XII. Author of *A History of Spanish Literature*; &c. } **Quevedo y Villegas.**
- J. G. C. A.** JOHN GEORGE CLARK ANDERSON, M.A.
Student, Censor and Tutor of Christ Church, Oxford. Formerly Fellow of Lincoln College. Craven Fellow, Oxford, 1896. Conington Prizeman, 1893. } **Pontus.**
- J. G. F.** SIR JOSHUA GIRLING FITCH, LL.D.
See the biographical article: FITCH, SIR JOSHUA GIRLING. } **Polytechnic (in part).**
- J. G. Fr.** JAMES GEORGE FRAZER, M.A., D.C.L., LL.D., LITT.D.
Professor of Social Anthropology, Liverpool University. Fellow of Trinity College, Cambridge. Fellow of the British Academy. Author of *The Golden Bough*; &c. } **Praefect (in part);
Praeneste (in part);
Praetor (in part);
Proserpine (in part);
Province (in part).**
- J. G. K.** JOHN GRAHAM KERR, M.A., F.R.S.
Regius Professor of Zoology in the University of Glasgow. Formerly Demonstrator in Animal Morphology in the University of Cambridge. Fellow of Christ's College, Cambridge, 1898-1904. Walsingham Medallist, 1898. Neill Prizeman, Royal Society of Edinburgh, 1904. } **Ray (in part).**
- J. G. Sc.** SIR JAMES GEORGE SCOTT, K.C.I.E.
Superintendent and Political Officer, Southern Shan States. Author of *Burma; The Upper Burma Gazetteer.* } **Rangoon.**
- J. Hn.** JÜSTÜS HASHAGEN, PH.D.
Privatdozent in Medieval and Modern History, University of Bonn. Author of *Das Rheinland unter der Französische Herrschaft.* } **Puttkammer.**
- J. H. M.** JOHN HENRY MIDDLETON, M.A., LITT.D., F.S.A., D.C.L. (1846-1896).
Slade Professor of Fine Art in the University of Cambridge, 1886-1895. Director of the Fitzwilliam Museum, Cambridge, 1889-1892. Art Director of the South Kensington Museum, 1892-1896. Author of *The Engraved Gems of Classical Times; Illuminated Manuscripts in Classical and Mediaeval Times.* } **Raphael.**
- J. Ja.** JOSEPH JACOBS, LITT.D.
Professor of English Literature in the Jewish Theological Seminary, New York. Formerly President of the Jewish Historical Society of England. Corresponding Member of the Royal Academy of History, Madrid. Author of *Jews of Angevin England; Studies in Biblical Archaeology*; &c. } **Purim.**
- J. L.*** SIR JOSEPH LARMOR, M.A., D.Sc., LL.D., F.R.S.
Fellow of St John's College, Cambridge, and Lucasian Professor of Mathematics in the University. Secretary of the Royal Society. Professor of Natural Philosophy, Queen's College, Galway, 1880-1885. Author of *Ether and Matter*, and various memoirs on Mathematics and Physics. } **Radiation, Theory of;
Radiometer.**
- J. M.** SIR JOHN MACDONELL, C.B., LL.D.
Master of the Supreme Court. Counsel to the Board of Trade and London Chamber of Commerce. Formerly Quain Professor of Comparative Law, University College, London. Editor of *State Trials; Civil Judicial Statistics*; &c. Author of *Survey of Political Economy; The Land Question*; &c. } **Protectorate.**
- J. M. M.** JOHN MALCOLM MITCHELL.
Sometime Scholar of Queen's College, Oxford. Lecturer in Classics, East London College (University of London). Joint-editor of Grote's *History of Greece.* } **Pomponazzi, Pietro;
Price, Richard.**
- J. P. E.** JEAN PAUL HIPPOLYTE EMMANUEL ADHÉMAR ESMEIN.
Professor of Law in the University of Paris. Officer of the Legion of Honour. Member of the Institute of France. Author of *Cours élémentaire d'histoire du droit français*; &c. } **Prefect;
Provost (in France).**
- J. P. P.** JOHN PERCIVAL POSTGATE, M.A., LITT.D.
Professor of Latin in the University of Liverpool. Fellow of Trinity College, Cambridge. Fellow of the British Academy. Editor of the *Classical Quarterly*. Editor-in-chief of the *Corpus Poetarum Latinorum*; &c. } **Propertius, Sextus.**
- J. R.*** JOHN RANDALL.
Formerly Secretary of the London Association of Correctors of the Press. Sub-editor of the *Athenaeum* and *Notes and Queries.* } **Proof-reading (in part).**
- J. S. F.** JOHN SMITH FLETT, D.Sc., F.G.S.
Petrographer to the Geological Survey. Formerly Lecturer on Petrology in Edinburgh University. Neill Medallist of the Royal Society of Edinburgh. Bigsby Medallist of the Geological Society of London. } **Porphyry; Pumice;
Pyroxenite;
Quartzite; Quartz-Porphyry.**
- J. S. R.** JAMES SMITH REID, M.A., LL.D., LITT.D.
Professor of Ancient History and Fellow and Tutor of Gonville and Caius College, Cambridge. Browne's and Chancellor's Medals. Editor of editions of Cicero's *Academia, De Amicitia*; &c. } **Quintilian.**
- J. T. Be.** JOHN THOMAS BEALBY.
Joint-author of Stanford's *Europe*. Formerly Editor of the *Scottish Geographical Magazine*. Translator of Sven Hedin's *Through Asia, Central Asia and Tibet*; &c. } **Poltava (in part);
Pskov (in part);
Radom (in part).**

- J. T. Cr.** JAMES TROUBRIDGE CRITCHELL.
London Correspondent of the *Australasian Pastoralists' Review*, *North Queensland Herald*; &c. Fellow of the Royal Colonial Institute. Author of *Polynesian Labour in Queensland*; *Guide to Queensland*; &c. } Queensland: *History*.
- J. W.** JAMES WILLIAMS, D.C.L., LL.D.
All Souls' Reader in Roman Law in the University of Oxford. Fellow of Lincoln College. Author of *Wills and Succession*; &c. } Possession (*law*);
Prescription (*in part*)
- J. W.*** JAMES WARD, LL.D.
See the biographical article: WARD, JAMES. } Psychology.
- J. W. G.** JOHN WALTER GREGORY, D.Sc., F.R.S.
Professor of Geology at the University of Glasgow. Professor of Geology and Mineralogy at the University of Melbourne, 1900-1904. Author of *The Dead Heart of Australia*; &c. } Queensland: *Geology*
- K. G. J.** KINGSLEY GARLAND JAYNE.
Sometime Scholar of Wadham College, Oxford. Matthew Arnold Prizeman, 1903. Author of *Vasco da Gama and his Successors*. } Portugal: *Geography and History*.
- K. S.** KATHLEEN SCHLESINGER.
Editor of the *Portfolio of Musical Archaeology*. Author of *The Instruments of the Orchestra*. } Pommer; Portative Organ;
Positive Organ; Psaltery;
Rackett; Ravanastron;
Rebab; Rebec;
Recorder (*music*);
Reed Instruments.
- L.** COUNT LÜTZOW, LITT.D. (Oxon.), D.Ph. (Prague), F.R.G.S.
Chamberlain of H.M. the Emperor of Austria, King of Bohemia. Hon. Member of the Royal Society of Literature. Member of the Bohemian Academy, &c. Author of *Bohemia: a Historical Sketch*; *The Historians of Bohemia* (Ilchester Lecture, Oxford, 1904); *The Life and Times of John Hus*; &c. } Prague.
- L. Bl.** LOUIS BELL, Ph.D.
Consulting Engineer, Boston, U.S.A. Chief Engineer, Electric Power Transmission Department, General Electric Co., Boston. Formerly Editor of *Electrical World*, New York. Author of *Electric Power Transmission*; &c. } Power Transmission:
Electrical.
- L. J. S.** LEONARD JAMES SPENCER, M.A.
Assistant in Department of Mineralogy, British Museum. Formerly Scholar of Sidney Sussex College, Cambridge, and Harkness Scholar. Editor of the *Mineralogical Magazine*. } Proustite; Pyrargyrite;
Pyrolusite; Pyromorphite;
Pyrrhotite; Quartz; Realgar.
- L. Wr.** LEWIS WRIGHT.
Author of *The Practical Poultry Keeper*; *The New Book of Poultry*; &c. } Poultry and Poultry-farming.
- L. W. V.-H.** L. W. VERNON-HARCOURT (d. 1909).
Barrister-at-Law. Author of *His Grace the Steward and the Trial of Peers*. } Reclamation of Land.
- M. Br.** MARGARET BRYANT. } Pope, Alexander (*in part*).
- M. Ha.** MARCUS HARTOG, M.A., D.Sc., F.L.S.
Professor of Zoology, University College, Cork. Formerly Fellow of the Royal University of Ireland. Author of "Protozoa" in *Cambridge Natural History*; and papers for various scientific journals. } Proteomyxa;
Radiolaria.
- M. M. Bh.** SIR MANCHERJEE MERWANJEE BHOWNAGGREE, K.C.I.E.
Fellow of Bombay University. M.P. for N.E. Bethnal Green, 1895-1906. Author of *History of the Constitution of the East India Company*; &c. } Readymoney,
Sir Cowasji Jehangir.
- M. N. T.** MARCUS NIEBUHR TOD, M.A.
Fellow and Tutor of Oriol College, Oxford. University Lecturer in Epigraphy. Joint-author of *Catalogue of the Sparta Museum*. } Pylos.
- M. O. B. C.** MAXIMILIAN OTTO BISMARCK CASPARI, M.A.
Reader in Ancient History at London University. Lecturer in Greek at Birmingham University, 1905-1908. } Polycrates;
Punic Wars.
- N. M.** NORMAN M'LEAN, M.A.
Lecturer in Aramaic, Cambridge University. Fellow and Hebrew Lecturer, Christ's College, Cambridge. Joint-editor of the larger Cambridge *Septuagint*. } Rabbūlā.
- N. W. T.** NORTHCOTE WHITRIDGE THOMAS, M.A.
Government Anthropologist to Southern Nigeria. Corresponding Member of the Société d'Anthropologie de Paris. Author of *Thought Transference*; *Kinship and Marriage in Australia*; &c. } Possession (*Psychology*).
- O. C. W.** REV. OWEN CHARLES WHITEHOUSE, M.A., D.D.
Senior Theological Tutor and Lecturer in Hebrew, Cheshunt College, Cambridge. Formerly Principal and Professor of Biblical Exegesis and Theology in the Countess of Huntingdon's College, Cheshunt. Author of *Primer of Hebrew Antiquities*; &c. } Priest (*in part*);
Prophet (*in part*).
- O. H.** OLAUS MAGNUS FRIEDRICH HENRICI, Ph.D., LL.D., F.R.S.
Professor of Mechanics and Mathematics in the Central Technical College of the City and Guilds of London Institute. Author of *Vectors and Rotors*; *Congruent Figures*; &c. } Projection.
- P. A. K.** PRINCE PETER ALEXEJVITCH KROPOTKIN.
See the biographical article: KROPOTKIN, PRINCE P. A. } Poltava (*in part*);
Pskov (*in part*);
Radom (*in part*).

- P. C. Y.** PHILIP CHESNEY YORKE, M.A.
Magdalen College, Oxford. Editor of *Letters of Princess Elizabeth of England*. { Prynne, William (*in part*);
Pym, John.
- P. G.** PERCY GARDNER, LITT.D., LL.D., F.S.A.
See the biographical article: GARDNER, PERCY. { Polyclitus; Polygnotus;
Praxiteles.
- P. GI.** PETER GILES, M.A., LL.D., LITT.D.
Fellow and Classical Lecturer of Emmanuel College, Cambridge, and University
Reader in Comparative Philology. Formerly Secretary of the Cambridge Philological
Society. { Q; R.
- P. G. K.** PAUL GEORGE KONODY.
Art Critic of the *Observer* and the *Daily Mail*. Formerly Editor of the *Artist*.
Author of *The Art of Walter Crane*; *Velasquez, Life and Work*; &c. { Potter, Paul.
- P. G. T.** PETER GUTHRIE TAIT, LL.D.
See the biographical article: TAIT, PETER GUTHRIE. { Quaternions (*in part*).
- P. M.** PAUL MEYER.
See the biographical article: MEYER, PAUL HYACINTHE. { Provençal Language;
Provençal Literature (*in part*).
- P. McC.** PRIMROSE MCCONNELL, F.G.S.
Member of the Royal Agricultural Society. Author of *Diary of a Working Farmer*;
&c. { Reaping.
- R. H. K.** REV. ROBERT HATCH KENNETT, M.A., D.D.
Regius Professor of Hebrew, Cambridge, and Canon of Ely. Formerly Fellow and
Lecturer in Hebrew and Syriac, Queens' College, and University Lecturer in
Aramaic. Author of *A Short Account of the Hebrew Tenses*; *In our Tongues*; &c. { Psalms, Book of (*in part*).
- R. I. P.** REGINALD INNES POCOCK, F.Z.S.
Superintendent of the Zoological Gardens, London. { Pycnogonida.
- R. J. M.** RONALD JOHN MCNEILL, M.A.
Christ Church, Oxford. Barrister-at-Law. Formerly Editor of the *St James's*
Gazette, London. { Racquets.
- R. L.*** RICHARD LYDEKKEK, F.R.S., F.Z.S., F.G.S.
Member of the Staff of the Geological Survey of India, 1874-1882. Author of
Catalogues of Fossil Mammals, Reptiles and Birds in the British Museum; *The Deer*
of all Lands; &c. { Porcupine (*in part*);
Porpoise; Primates;
Proboscidea; Prongbuck;
Rabbit (*in part*);
Rat; Ratel.
- R. Mo.** RAY MORRIS, M.A.
Formerly Managing Editor, *Railway Age Gazette*, New York. Author of *Railroad*
Administration. { Railways: General Statistics
and Financial Organization.
- R. M. L.** ROBERT MURRAY LESLIE, M.A., M.D., M.R.C.P.
Senior Physician, Prince of Wales's General Hospital, London. Lecturer on
Medicine, London Post-Graduate College. Author of *Clinical Types of Pneu-*
monia; &c. { Pygmy.
- R. M. W.** R. MORTIMER WHEELER. { Punch.
- R. N. B.** ROBERT NISBET BAIN (d. 1909).
Assistant Librarian, British Museum, 1883-1909. Author of *Scandinavia: the*
Political History of Denmark, Norway and Sweden, 1513-1900; *The First Romanovs,*
1613-1725; *Slavonic Europe: the Political History of Poland and Russia from 1469*
to 1796; &c. { Poniatowski, Joseph A.;
Potemkin, Prince;
Potocki, Ignaty;
Potocki, Stanislaw F.;
Prokopovich; Pugachev;
Rakóczy; Razin.
- R. Po.** RENÉ POUPARDIN, D.-ÈS-L.
Secretary of the École des Chartes. Honorary Librarian at the Bibliothèque
Nationale, Paris. Author of *Le Royaume de Provence sous les Carolingiens*; *Recueil*
des chartes de Saint-Germain; &c. { Provence;
Quierzy, Capitulary of.
- R. P. S.** R. PHENÉ SPIERS, F.S.A., F.R.I.B.A.
Formerly Master of the Architectural School, Royal Academy, London. Past
President of Architectural Association. Associate and Fellow of King's College,
London. Corresponding Member of the Institute of France. Editor of Fergusson's
History of Architecture. Author of *Architecture: East and West*; &c. { Porch.
- R. R. M.** ROBERT RANULF MARETT, M.A.
Reader in Social Anthropology, Oxford University, and Fellow and Tutor of Exeter
College. Author of *The Threshold of Religion*. { Prayer.
- R. S. C.** ROBERT SEYMOUR CONWAY, M.A., D.LITT.
Professor of Latin and Indo-European Philology in the University of Manchester.
Formerly Professor of Latin in University College, Cardiff; and Fellow of Gonville
and Caius College, Cambridge. Author of *The Italic Dialects*. { Pompeii: Oscan Inscriptions;
Praeneste (*in part*);
Praetuttii.
- St C.** VISCOUNT ST CYRES.
See the biographical article: IDDESLEIGH, 1ST EARL OF. { Quesnel, Pasquier;
Quietism.
- S. F. H.** SIDNEY FREDERIC HARMER, D.Sc., F.R.S., F.Z.S.
Keeper of Zoology, Natural History Departments, British Museum. Fellow,
formerly Tutor and Lecturer, King's College, Cambridge. Joint-editor of *The*
Cambridge Natural History. { Polyzoa;
Pterobranchia.
- St G. M.** ST GEORGE JACKSON MIVART, M.D., F.R.S.
See the biographical article: MIVART, ST GEORGE JACKSON. { Rattlesnake (*in part*).
- S. R. G.** SAMUEL RAWSON GARDINER, LL.D., D.C.L.
See the biographical article: GARDINER, S. R. { Prynne, William (*in part*).

- T. As.** THOMAS ASHBY, M.A., D.LITT.
Director of British School of Archaeology at Rome. Formerly Scholar of Christ Church, Oxford. Craven Fellow, 1897. Conington Prizeman, 1906. Member of the Imperial German Archaeological Institute. Author of *The Classical Topography of the Roman Campagna*.
- T. A. C.** TIMOTHY AUGUSTINE COGILAN, I.S.O.
Agent-General for New South Wales. Government Statistician, New South Wales, 1886-1905. Honorary Fellow of the Royal Statistical Society. Author of *Wealth and Progress of New South Wales*; *Statistical Account of Australia and New Zealand*; &c.
- T. A. I.** THOMAS ALLAN INGRAM, M.A., LL.D.
Trinity College, Dublin.
- T. Ba.** SIR THOMAS BARCLAY.
Member of the Institute of International Law. Officer of the Legion of Honour. Author of *Problems of International Practice and Diplomacy*; &c. M.P. for Blackburn, 1910.
- T. F. D.** THOMAS F. DALE, M.A.
Queen's College, Oxford. Steward and Member of the Council of the Polo and Riding Pony Society. Author of *Polo, Past and Present*; &c.
- T. H.** THOMAS HODGKIN, D.C.L., LITT.D.
See the biographical article: HODGKIN, THOMAS.
- T. H. H.*** SIR THOMAS HUNGERFORD HOLDICH, K.C.M.G., K.C.I.E., D.Sc.
Superintendent, Frontier Surveys, India, 1892-1898. Gold Medallist, R.G.S., London, 1887. Author of *The Indian Borderland*; *The Countries of the King's Award*; *India*; *Tibet*.
- T. L. H.** SIR THOMAS LITTLE HEATH, K.C.B., Sc.D.
Assistant-Secretary to the Treasury, London. Fellow of Trinity College, Cambridge. Author of *Apollonius of Perga*; *Treatise on Conic Sections*; *The Thirteen Books of Euclid's Elements*; &c.
- T. Se.** THOMAS SECCOMBE, M.A.
Balliol College, Oxford. Lecturer in History, East London and Birkbeck Colleges, University of London. Stanhope Prizeman, Oxford, 1887. Assistant Editor of *Dictionary of National Biography*, 1891-1901. Author of *The Age of Johnson*; &c.
- T. Wo.** THOMAS WOODHOUSE.
Head of the Weaving and Textile Designing Department, Technical College, Dundee.
- W. A. B. C.** REV. WILLIAM AUGUSTUS BREVOORT COOLIDGE, M.A., F.R.G.S., PH.D.
Fellow of Magdalen College, Oxford. Professor of English History, St David's College, Lampeter, 1880-1881. Author of *Guide du Haut Dauphiné*; *The Range of the Todi*; *Guide to Grindelwald*; *Guide to Switzerland*; *The Alps in Nature and in History*; &c. Editor of the *Alpine Journal*, 1880-1881; &c.
- W. A. L.** WILLIAM ALEXANDER LINDSAY, K.C., M.A., J.P., D.L., F.S.A.
Windsor Herald. Bencher of the Middle Temple. Peerage Counsel. Author of *The Royal Household*, 1837-1897; &c.
- W. A. P.** WALTER ALISON PHILLIPS, M.A.
Formerly Exhibitioner of Merton College and Senior Scholar of St John's College, Oxford. Author of *Modern Europe*; &c.
- W. Ba.** WILHELM BACHER, PH.D.
Professor at the Rabbinical Seminary, Budapest. Knight of the Iron Crown. Author of *Die Agada der Tannaiten*; &c.
- W. B. P.** WILLIAM BARCLAY PARSONS, C.E., LL.D.
Formerly Chief Engineer, Rapid Transit Commission, New York. Advisory Engineer, Royal Commission on London Traffic. Author of *Track*; *Turnouts*; &c.
- W. E. D.** WILLIAM ERNEST DALBY, M.A., M.INST.C.E.
Professor of Civil and Mechanical Engineering at the City and Guilds of London Institute Central Technical College, South Kensington. Formerly University Demonstrator in the Engineering Department, Cambridge. Author of *The Balancing of Engines*; *Valves and Valve-Gear Mechanism*; &c.
- W. F. C.** WILLIAM FEILDEN CRAIES, M.A.
Barrister-at-Law, Inner Temple. Lecturer on Criminal Law, King's College, London. Editor of Archbold's *Criminal Pleading* (23rd edition).
- W. G.** WILLIAM GARNETT, M.A., D.C.L.
Educational Adviser to the London County Council. Formerly Fellow and Lecturer of St John's College, Cambridge. Principal and Professor of Mathematics, Durham College of Science, Newcastle-on-Tyne. Author of *Elementary Dynamics*; &c.
- W. H. F.** SIR WILLIAM HENRY FLOWER, F.R.S.
See the biographical article: FLOWER, SIR W. H.
- W. H. L.** WILLIAM H. LANG, M.B., D.Sc.
Barker Professor of Cryptogamic Botany, University of Manchester.
- Pompell (*in part*);
Pomposa; Pomptine Marshes;
Popilia, Via; Portus;
Postumia, Via;
Praeneste (*in part*);
Praenestina, Via;
Puteoli; Pyrgi;
Ravenna (*in part*).
- Queensland: *Geography and Statistics*.
- Post and Postal Service;
Pound (*in part*);
Praemunire.
- Privateer;
Prize: *War*;
Raid; Rebellion.
- Polo.
- Ravenna (*in part*).
- Quetta.
- Porism.
- Reeve, Henry.
- Ramie.
- Ragatz; Rambert.
- Precedence (*in part*).
- Prince;
Provost (*in part*).
- Rabbi.
- Railways: *Intra-Urban Railways*.
- Power Transmission: *Introductory and Mechanical*;
Railways: *Locomotive Power*.
- Quarter Sessions, Court of;
Recognizance.
- Polytechnic (*in part*).
- Porcupine (*in part*);
Rabbit (*in part*).
- Pteridophyta.

INITIALS AND HEADINGS OF ARTICLES

W. L. G.	WILLIAM LAWSON GRANT, M.A. Professor at Queen's University, Kingston, Canada. Formerly Beit Lecturer in Colonial History at Oxford University. Editor of <i>Acts of the Privy Council</i> (Colonial Series); <i>Canadian Constitutional Development</i> (in collaboration).	{ Prince Edward Island; Quebec: <i>Province (in part)</i> ; Quebec: <i>City</i> .
W. M.	WILLIAM MINTO, M.A., LL.D. See the biographical article: MINTO, WILLIAM.	{ Pope, Alexander (<i>in part</i>).
W. M. F. P.	WILLIAM MATTHEW FLINDERS PETRIE, F.R.S., D.C.L., LITT.D. See the biographical article: PETRIE, W. M. F.	{ Pyramid.
W. O. B.	VEN. WINFRID OLDFIELD BURROWS, M.A. Archdeacon of Birmingham. Student and Tutor of Christ Church, Oxford, 1884-1891. Principal of Leeds Clergy School, 1891-1900. Author of <i>The Mystery of the Cross</i> .	{ Prayers for the Dead.
W. R. M.	WILLIAM RICHARD MORFILL, M.A. (d. 1910). Formerly Professor of Russian and the other Slavonic Languages in the University of Oxford. Curator of the Taylorian Institution, Oxford. Author of <i>Russia</i> ; <i>Slavonic Literature</i> ; &c.	{ Pushkin.
W. R. S.	WILLIAM ROBERTSON SMITH, LL.D. See the biographical article: SMITH, WILLIAM ROBERTSON.	{ Priest (<i>in part</i>); Prophet (<i>in part</i>); Psalms, Book of (<i>in part</i>); Rameses (<i>in part</i>).
W. W. F.*	WILLIAM WARDE FOWLER, M.A. Fellow of Lincoln College, Oxford. Sub-Rector, 1881-1904. Gifford Lecturer, Edinburgh University, 1908. Author of <i>The City-State of the Greeks and Romans</i> ; <i>The Roman Festivals of the Republican Period</i> ; &c.	{ Pontifex.
W. Y.	REV. WILLIAM YOUNG. Minister, Higher Broughton Presbyterian Church, Manchester, 1877-1901, and Association Secretary for the Religious Tract Society in the North of England.	{ Presbyterianism.

PRINCIPAL UNSIGNED ARTICLES

Pollination.	Potentiometer.	Prussic Acid.	Quinine.
Polygon.	Prerogative.	Public Health.	Quinoline.
Polyhedron.	Press Laws.	Publishing.	Quinones.
Polynesia.	Primrose.	Puffin.	Radium.
Pomegranate.	Primulaceae.	Pugilism.	Rainbow.
Pomerania.	Princeton University.	Pump.	Ranunculaceae.
Pontoon.	Principal and Agent.	Punjab.	Rare Earths.
Poor Law.	Probate.	Pyrazoles.	Raspberry.
Poplar.	Procession.	Pyrenees.	Rationalism.
Porto Rico.	Proctor.	Pyridine.	Ravenna, Exarchate of
Portuguese Guinea.	Prohibition.	Pyrones.	Real Property.
Potassium.	Protestant.	Quarantine.	Red River.
Potato.	Prussia.		

ENCYCLOPÆDIA BRITANNICA

ELEVENTH EDITION

VOLUME XXII

POLL, strictly the head, in men or animals. Skeat connects the word with O. Swed. *kolle* (initial *p* and *k* being interchangeable) and considers a Celtic origin probable; cf. Irish *coll*, Welsh *col*, peak, summit. "Poll" is chiefly used in various senses derived from that of a unit in an enumeration of persons or things, e.g. poll-tax (*q.v.*), or "challenge to the polls" in the case of a jury (*q.v.*). The most familiar derivative uses are those connected with voting at parliamentary or other elections; thus "to poll" is to vote or to secure a number of votes, and "the poll," the voting, the number of votes cast, or the time during which voting takes place. The verb "to poll" also means to clip or shear the top of anything, hence "polled" of hornless cattle, or "deed-poll" (*i.e.* a deed with smooth or unindented edges, as distinguished from an "indenture"). A tree which has been "polled," or cut back close in order to induce it to make short bushy growth, is called a "pollard."

At the university of Cambridge, a "pass" degree is known as a "poll-degree." This is generally explained as from the Greek *πολλοί*, the many, the common people.

POLLACK (*Gadus pollachius*), a fish of the family *Gadidae*, abundant on rocky coasts of northern Europe, and extending as far south as the western parts of the Mediterranean, where, however, it is much scarcer and does not attain to the same size as in its real northern home. In Scotland and some parts of Ireland it is called lythe. It is distinguished from other species of the genus *Gadus* by its long pointed snout, which is twice as long as the eye, with projecting lower jaw, and without a barbel at the chin. The vent is below the anterior half of the first dorsal fin. A black spot above the base of the pectoral fin is another distinguishing mark. Although pollack are well-flavoured fish, and smaller individuals (from 12 to 16 in.) excellent eating, they do not form any considerable article of trade, and are not preserved, the majority being consumed by the captors. Specimens of 12 lb are common, but the species is said to attain occasionally as much as 24 lb in weight. (See also COALFISH.)

POLLAIUOLO, the popular name of the brothers Antonio and Piero di Jacobo Benci, Florentines who contributed much to Italian art in the 15th century. They were called Pollaiuolo because their father was a poulterer. The nickname was also extended to Simone, the nephew of Antonio.

ANTONIO (1429-1498) distinguished himself as a sculptor, jeweller, painter and engraver, and did valuable service in perfecting the art of enamelling. His painting exhibits an excess

of brutality, of which the characteristics can be studied in the "Saint Sebastian," painted in 1475, and now in the National Gallery, London. A "St Christopher and the Infant Christ" is in the Metropolitan Museum, New York. But it was as a sculptor and metal-worker that he achieved his greatest successes. The exact ascription of his works is doubtful, as his brother Piero did much in collaboration with him. The museum of Florence contains the bronze group "Hercules strangling Cacus" and the terra-cotta bust "The Young Warrior"; and in the South Kensington Museum, London, is a bas-relief representing a contest between naked men. In 1489 Antonio took up his residence in Rome, where he executed the tomb of Sixtus IV. (1493), a composition in which he again manifested the quality of exaggeration in the anatomical features of the figures. In 1496 he went to Florence in order to put the finishing touches to the work already begun in the sacristy of Santo Spirito. He died in 1498, having just finished his mausoleum of Innocent VIII., and was buried in the church of San Pietro in Vincula, where a monument was raised to him near that of his brother.

PIERO (1443-1496) was a painter, and his principal works were his "Coronation of the Virgin," an altar-piece painted in 1483, in the choir of the cathedral at San Gimignano; his "Three Saints," an altar-piece, and "Prudence" are both at the Uffizi Gallery.

SIMONE (1457-1508), nephew of Antonio Pollaiuolo, a celebrated architect, was born in Florence and went to Rome in 1484; there he entered his uncle's studio and studied architecture. On his return to Florence he was entrusted with the completion of the Strozzi palace begun by Benedetto de Maiano, and the cornice on the façade has earned him lasting fame. His highly coloured accounts of Rome earned for him the nickname of *il Cronaca* (chronicler). About 1498 he built the church of San Francesco at Monte and the vestibule of the sacristy of Santo Spirito. In collaboration with Giuliano da Sangallo he designed the great hall in the Palazzo Vecchio. He was a close friend and adherent of Savonarola.

See also Maud Cruttwell, *Antonio Pollaiuolo* (1907).

POLLAN (*Coregonus pollan*), the name given to a species of the Salmonoid genus *Coregonus* (whitefish) which has been found in the large and deep loughs of Ireland only. A full account of the fish by its first describer, W. Thompson, may be found in his *Natural History of Ireland*, iv. 168.

POLLARD, EDWARD ALBERT (1828-1872), American journalist, was born in Nelson county, Virginia, on the 27th of February 1828. He graduated at the university of Virginia in 1849, studied law at the College of William and Mary, and in Baltimore (where he was admitted to the bar), and was engaged in newspaper work in California until 1855. In 1857-1861 he was clerk of the judiciary committee of the National House of Representatives. By 1859 he had become an outspoken Secessionist, and during the Civil War he was one of the principal editors of the Richmond *Examiner*, which supported the Confederacy but was hostile to President Jefferson Davis. In 1864 Pollard sailed for England, but the vessel on which he sailed was captured as a blockade runner, and he was confined in Fort Warren in Boston Harbour from the 29th of May until the 12th of August, when he was paroled. In December he was placed in close confinement at Fort Monroe by order of Secretary Stanton, but was soon again paroled by General B. F. Butler, and in January proceeded to Richmond to be exchanged there for Albert D. Richardson (1833-1869), a well-known correspondent of the New York *Tribune*, who, however, had escaped before Pollard arrived. In 1867-1869 Pollard edited a weekly paper at Richmond, and he conducted the *Political Pamphlet* there during the presidential campaign of 1868.

His publications include *Black Diamonds Gathered in the Darkey Homes of the South* (1859), in which he advocated a reopening of the slave trade; *The Southern History of the War* (3 vols.: *First Year of the War*, with B. M. DeWitt, 1862; *Second Year of the War*, 1864; *Third Year of the War*, 1864); *Observations in the North: Eight Months in Prison and on Parole* (1865); *The Lost Cause* (1866); *Lee and His Lieutenants* (1867); *The Lost Cause Regained* (1868), a southern view of reconstruction urging the necessity of white supremacy; *The Life of Jefferson Davis* (1869), an arraignment of the Confederate president; and *The Virginia Tourist* (1870).

POLLENTIA (mod. *Pollenzo*), an ancient town of Liguria, Italy, 10 m. to the north of Augusta Bagiennorum, on the left bank of the Tanarus (mod. Tanaro). Its position on the road from Augusta Taurinorum to the coast at Vada Sabatia, at the point of divergence of a road to Hasta (Asti) gave it military importance. Decimus Brutus managed to occupy it an hour before Mark Antony in 43 B.C.; and it was here that Stilicho on the 29th of March 403 fought the battle with Alaric which though undecided led the Goths to evacuate Italy. The place was famous for its brown wool, and for its pottery. Considerable remains of ancient buildings, an amphitheatre, a theatre and a temple still exist. The so-called temple of Diana is more probably a tomb.

See G. Franchi-Pont in *Atti dell' accademia di Tornio* (1805-1808), p. 321 sqq.

POLLINATION, in botany, the transference of the pollen from the stamen to the receptive surface, or stigma, of the pistil of a flower. The great variety in the form, colour and scent of flowers (see FLOWER) is intimately associated with pollination which is effected by aid of wind, insects and other agencies. Pollen may be transferred to the stigma of the same flower—self-pollination (or *autogamy*), or to the stigma of another flower on the same plant or another plant of the same species—cross-pollination (or *allogamy*). Effective pollination may also occur between flowers of different species, or occasionally, as in the case of several orchids, of different genera—this is known as hybridization.

The method of pollination is to some extent governed by the distribution of the stamens and pistil. In the case of unisexual flowers, whether monoecious, that is, with staminate and pistillate flowers on one and the same plant, such as many of our native trees—oak, beech, birch, alder, &c., or dioecious with staminate and pistillate flowers on different plants, as in willows and poplars, cross pollination only is possible. In bisexual or hermaphrodite flowers, that is, those in which both stamens and pistil are present, though self-pollination might seem the obvious course, this is often prevented or hindered by various arrangements which favour cross-pollination. Thus the anthers and stigmas in any given flower are often mature at different times; this condition, which is known as dichogamy and was first

pointed out by Sprengel, may be so well marked that the stigma has ceased to be receptive before the anthers open, or the anthers have withered before the stigma becomes receptive, when cross-pollination only is possible, or the stages of maturity in the two organs are not so distinct, when self-pollination becomes possible later on. The flower is termed *proterandrous* or *proterogynous* according as anthers or stigmas mature first. The term *homogamy* is applied to the simultaneous maturity of stigma and anthers. Spontaneous self-pollination is rendered impossible in some homogamous flowers in consequence of the relative position of the anthers and stigma—this condition has been termed *herkogamy*. Flowers in which the relative position of the organs allows of spontaneous self-pollination may be all alike as regards length of style and stamens (*homomorphy* or *homostyly*), or differ in this respect (*heteromorphy*) the styles

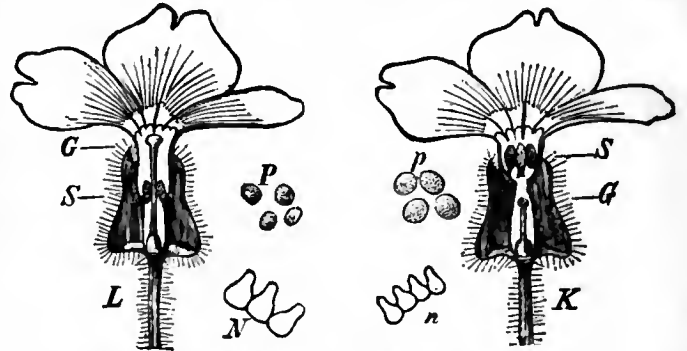

(From Strasburger's *Lehrbuch der Botanik*, by permission of Gustav Fischer.)

FIG. 1.—Long-styled, L, and short-styled, K, flowers of *Primula sinensis*.

G, Level of stigma; S, level of anthers; P, N, pollen grains and stigmatic papillae of long-styled form; p, n, ditto of short-styled form.

and stamens being of different lengths in different flowers (*heterostyly*) or the stamens only are of different lengths (*heter-anthery*). Flowers which are closed at the time of maturity of anthers and stigmas are termed cleistogamous.

Self-pollination is effected in very various ways. In the simplest case the anthers are close to the stigmas, covering these with pollen when they open; this occurs in a number of small annual plants, also in *Narcissus*, *Crocus*, &c. In snowdrop and other pendulous flowers the anthers form a cone around the style and the pollen falls on to the underlying stigmas, or in erect flowers the pollen may fall on to the stigmas which lie directly beneath the opening anthers (e.g. *Narthecium*). In very many cases the pollen is carried to the stigma by elongation, curvature or some other movement of the filament, the style or stigma, or corolla or some other part of the flower, or by correlated movements of two or more parts. For instance, in many flowers the filaments are at first directed outwards so that self-pollination is not possible, but later incline towards the stigmas and pollinate them (e.g. numerous Saxifragaceae, Cruciferae and others), or the style, which first projects beyond the anthers, shortens later on so that the anthers come into contact with the stigmas (e.g. species of Cactaceae), or the style bends so that the stigma is brought within the range of the pollen (e.g. species of *Oenothera*, *Epilobium*, most Malvaceae, &c.). In *Mirabilis Jalapa* and others the filaments and style finally become intertwined, so that pollen is brought in contact with the stigma. Self-pollination frequently becomes possible towards the end of the life of a flower which during its earlier stages has been capable only of cross-pollination. This is associated with the fact, so ably demonstrated by Darwin, that, at any rate in a large number of cases, cross-pollination yields better results, as measured by the number of seeds produced and the strength of the offspring, than self-pollination; the latter is, however, preferable to absence of pollination. In many cases pollen has no effect on the stigma of the same flower, the plants are self-sterile, in other cases external pollen is more effective (*pre-potent*) than pollen from the same flower; but in a very large number of cases experiment has shown that there is little or no difference

between the effects of external pollen and that from the same flower.

Cross-pollination may occur between two flowers on the same plant (*geitonogamy*) or between flowers on distinct plants (*xenogamy*). The former, which is a somewhat less favourable method than the latter, is effected by air-currents, insect agency, the actual contact between stigmas and anthers in neighbouring flowers, where, as in the family Compositae, flowers are closely crowded, or by the fall of the pollen from a

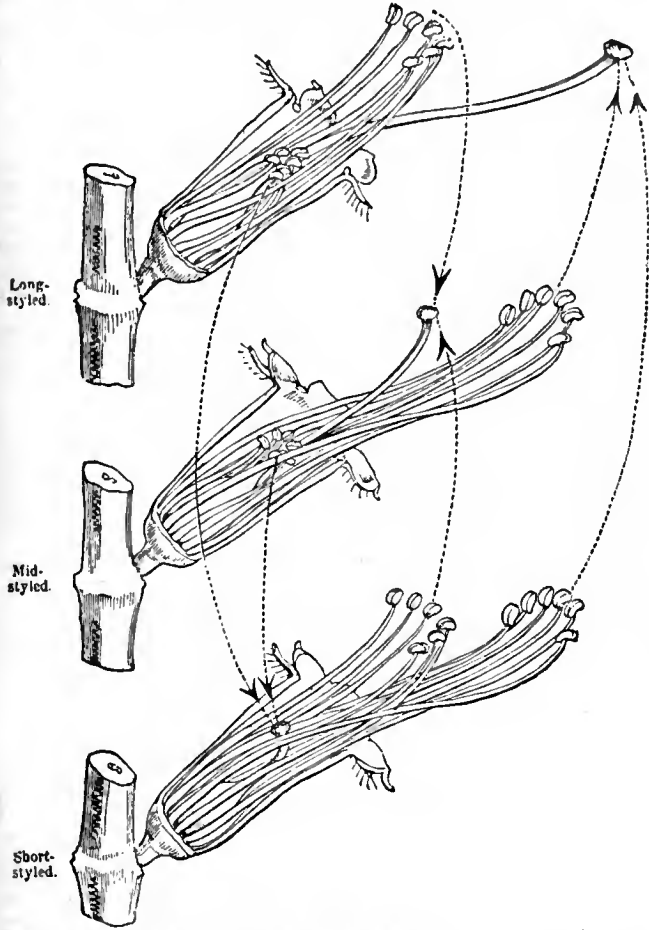

(From Darwin's *Different Forms of Flowers* by permission.)

FIG. 2.—Diagram of the flowers of the three forms of *Lythrum salicaria* in their natural position, with the petals and calyx removed on the near side. (X 6 times.)

The dotted lines with the arrow show the directions in which pollen must be carried to each stigma to ensure full fertility.

higher on to the stigmas of a lower flower. Anton Kerner has shown that crowded inflorescences such as those of Compositae and Umbelliferae are especially adapted for geitonogamy. Xenogamy is of course the only possible method in diclinous plants; it is also the usual method in monoclinous plants, owing to the fact that stamens and carpels often mature at different times (*dichogamy*), the plants being proterandrous or proterogynous. Even in homogamous flowers cross-pollination is in a large proportion of cases the effective method, at any rate at first, owing to the relative position of anther and stigma or the fact that the plant is self-sterile.

The subject of heterostyly was investigated by Darwin (see his *Forms of Flowers*) and later by Hildebrand. In the case of a dimorphic flower, such as *Primula*, four modes of pollination are possible, two distinguished by Darwin as legitimate, between anthers and stigmas on corresponding levels, and two so-called illegitimate unions, between anthers and stigmas at different levels (cf. fig. 1). In a trimorphic flower such as *Lythrum salicaria* there are six possible legitimate unions and twelve illegitimate (see fig. 2). Experiment showed that legitimate unions yield a larger quantity of seed than illegitimate.

Many plants produce, in addition to ordinary open flowers, so-called cleistogamous flowers, which remain permanently closed but which notwithstanding produce fruit; in these the corolla is inconspicuous or absent and the pollen grows from the anther on to the stigma of the same flower. Species of *Viola* (see fig. 3), *Oxalis acetosella* (wood sorrel) and *Lamium amplexicaule* are commonly occurring instances. The cleistogamous flowers are developed before or after the normal open flowers at seasons less favourable for cross-pollination. In some cases flowers, which open under normal circumstances, remain closed owing to unfavourable circumstances, and self-pollination occurs as in a typical cleistogamous flower—these have been distinguished as pseudo-cleistogamous. Instances occur in water plants, where flowers are unable to reach the surface (e.g. *Alisma natans*, water buttercup, &c.) or where flowers remain closed in dull or cold weather.

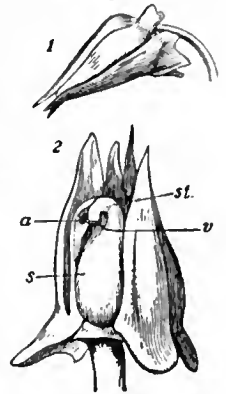

FIG. 3.—Cleistogamous flower of *Viola sylvatica*. 1, flower X 4. 2, flower more highly magnified and cut open. a, anther; s, pistil; st, style; v, stigmatic surface.

Systems of classification of flowers according to the agency by which pollination is effected have been proposed by Delpino, H. Müller and other workers on the subject. Knuth suggests the following, which is a modification of the systems proposed by Delpino and Müller.

- A. *Water-pollinated plants, Hydrophilae.* A small group which is subdivided thus:—
 - a. *Pollinated under the water; e.g. Najas* where the pollen grains are rather heavier than water, and sinking down are caught by the stigmas of the extremely simple female flowers.
 - b. *Pollination on the surface*, a more frequent occurrence than (a). In these the pollen floats on the surface and reaches the stigmas of the female flowers as in *Callitriche*, *Ruppia*, *Zostera*, *Elodea*. In *Vallisneria* (fig. 4) the male flowers become detached and float on the surface of the water; the anthers are thus brought in contact with the stigmas of the female flowers.
- B. *Wind-pollinated plants, Anemophilae.*—In these the pollen grains are smooth and light so as to be easily blown about, and are produced in great quantity; the stigmas are brush-like or feathery, and usually long and protruding so as readily to catch the pollen. As no means of attraction are required the flowers are inconspicuous and without scent or nectar. The male inflorescence is often a pendulous catkin, as in hazel and many native English trees (fig. 5); or the anthers are loosely fixed on long thread-like filaments as in grasses (fig. 6).

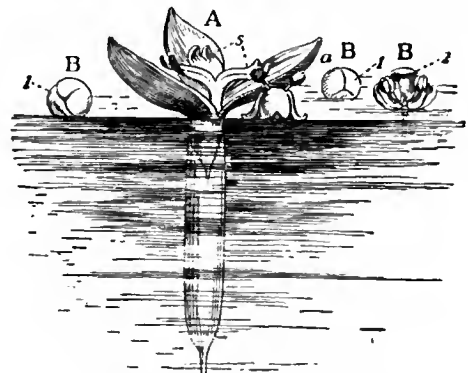

FIG. 4.—*Vallisneria spiralis*.

- A, female flower; s, stigmas.
- B, male flowers; 1 before; 2, after spreading of the petals. A male flower has floated alongside a female and one of its anthers, which have opened to set free the pollen, is in contact with a stigma. a, anther.
- C. *Animal-pollinated plants, Zoidiophilae*, are subdivided according to the kind of animal by agency of which pollination is effected, thus:—
 - a. *Bat-pollinated, Chiropterophilae.*—A *Freycinetia*, native of Java, and a species of *Bauhinia* in Trinidad are visited by bats which transfer the pollen.

b. *Bird-pollinated, Ornithophilae*.—Humming-birds and honey-suckers are agents of pollination in certain tropical plants; they visit the generally large and brightly-coloured flowers either for the honey which is secreted in considerable quantity or for the insects which have been attracted by the honey (fig. 7).

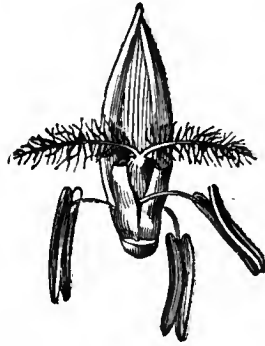

FIG. 5.—Catkin of Male Flowers of Hazel.

FIG. 6.—Grass Flower showing pendulous anthers and protruding hairy stigmas.

c. *Snail or slug-pollinated flowers, Malacophilae*.—In small flowers which are crowded at the same level or in flat flowers in which the stigmas and anthers project but little, slugs or snails creeping over their surface may transfer to the stigma the pollen which clings to the slimy foot. Such a transfer has been described in various Aroids, *Rohdea japonica* (Liliaceae), and other plants.



(From a drawing in the Botanical Gallery at the British Museum.)

FIG. 7.—Flower of *Datura sanguinea* visited by humming-bird *Docimastes ensiferus*. (About $\frac{1}{3}$ nat. size.)

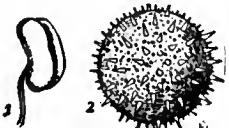

FIG. 8.—1, anther; 2, pollen grain of Hollyhock (*Althaea rosea*) enlarged. The pollen grain bears numerous spines, the dark spots indicate thin places in the outer wall.

d. *Insect-pollinated, Entomophilae*, a very large class characterized by sticky pollen grains, the surface of which bears spines, warts or other projections (fig. 8) which facilitate adhesion to some part of the insect's body, and a relatively small stigma with a sticky surface. The flowers have an attractive floral envelope, are scented and often contain honey or a large amount of pollen; by these means the insect is enticed to visit it. The form, colour and scent of the flower vary widely, according to the class of insect whose

aid is sought, and there are also numerous devices for protecting the pollen and nectar from rain and dew or from the visits of those insects which would not serve the purpose of pollen-transference (unbidden guests).¹ The following subdivisions have been suggested

- A. *Pollen Flowers*.—These offer only pollen to their visitors, as species of anemone, poppy, rose, tulip, &c. They are simple in structure and regular in form, and the generally abundant pollen is usually freely exposed.
- B. *Nectar Flowers*.—These contain nectar and include the following groups:—
1. *Flowers with exposed nectar*, readily visible and accessible to all visitors. These are very simple, open and generally regular flowers, white, greenish-yellow or yellow in colour and are chiefly visited by insects with a short proboscis, such as short-tongued wasps and flies, also beetles and more rarely bees. Examples are Umbelliferae as a family, saxifrages, holly, *Acer*, *Rhamnus*, *Euonymus*, *Euphorbia*, &c.
 2. *Flowers with nectar partly concealed* and visible only in bright sunshine. The generally regular flowers are completely open only in bright sunshine, closing up into cups at other times. Such are most Cruciferae, buttercups, king-cup (*Caltha*), *Potentilla*. White and yellow colours predominate and insects with a proboscis of medium length are the common pollinating agents, such as short-tongued bees.
 3. *Flowers with nectar concealed* by pouches, hairs, &c. Regular flowers predominate, e.g. *Geranium*, *Cardamine pratensis*, mallows, *Rubus*, *Oxalis*, *Epilobium*, &c., but many species show more or less well-marked median symmetry (zygomorphism) as *Euphrasia*, *Orchis*, thyme, &c., and red, blue and violet are the usual colours. Long-tongued insects such as the honey-bee are the most frequent visitors.
 4. *Social flowers*, whose nectar is concealed as in (3), but the flowers are grouped in heads which render them strikingly conspicuous, and several flowers can be simultaneously pollinated. Such are Compositae as a class, also *Scabiosa*, *Armeria* (sea-pink) and others.
 5. *Hymenopterid flowers*, which fall into the following groups: Bee-flowers proper, humble-bee flowers requiring a longer proboscis to reach the nectar, wasp-flowers such as fig-wort (*Scrophularia nodosa*) and ichneumon flowers such as tway-blade (*Listera ovata*).

The shapes and colours are extremely varied; bilaterally symmetrical forms are most frequent with red, blue or violet colours. Such are Papilionaceae or flowers, Violaceae, many Labiatae, Scrophulariaceae and others. Many are highly specialized so that pollination can be effected by a few species only. Examples of more special mechanisms are illustrated by *Salvia* (fig. 9). The long connective of the single stamen is hinged to the short filament and has a shorter arm ending in a blunt process and a longer arm bearing a half-anther. A large bee in probing for honey comes in contact with the end of the short arm of the lever and causes the longer arm to descend and the pollen is deposited on the back of the insect (fig. 9, 1). In a later stage (fig. 9, 2) the style elongates and the forked stigma occupies the same position as the anther in fig. 9, 1.



(From Strasburger's *Lehrbuch der Botanik*, by permission of Gustav Fischer.)

FIG. 9.—Pollination of *Salvia pratensis*.

- 1, Flower visited by a humble-bee, showing the projection of the curved connective bearing the anther from the helmet-shaped upper lip and the deposition of the pollen on the back of the humble-bee.
- 2, Older flower, with connective drawn back, and elongated style.
- 3, The same, when disturbed by the entrance of the proboscis of the bee in the direction of the arrow; *f*, filament; *c*, connective; *s*, the obstructing half of the anther.
- 4, The staminal apparatus at rest, with connective enclosed within the upper lip.

¹ See A. Kerner, *Plants and their Unbidden Guests*.

In Broom there is an explosive mechanism; the pressure of the insect visitor on the keel of the corolla causes a sudden release of the stamens and the scattering of a cloud of pollen over its body.

6. *Lepidopterid flowers*, visited chiefly by Lepidoptera, which are able to reach the nectar concealed in deep,



FIG. 10.—Spadix of *Arum maculatum* from which the greater part of the spathe has been cut away.

p, Pistillate, s, staminate flowers; h, sterile flowers forming a circle of stiff hairs closing the mouth of the chamber formed by the lower part of the spathe.

narrow tubes or spurs by means of their long slender proboscis. Such are: (a) Butterfly-flowers, usually red in colour, as *Dianthus carthusianorum*; (b) Moth-flowers, white or whitish, as honeysuckle (*Lonicera periclymenum*).

7. *Fly flowers*, chiefly visited by Diptera, and including very different types:—

a. Nauseous flowers, dull and yellowish and dark purple in colour and often spotted, with a smell attractive to carrion flies and dung flies, e.g. species of *Saxifraga*.

b. Pitfall flowers such as *Asarum*, *Aristolochia* and *Arum maculatum*, when the insect is caught and detained until pollination is effected (fig. 10).

c. Pinch-trap flowers, as in the family *Asclepiadaceae*, where the proboscis, claw or bristle of the insect is caught in the clip to which the pairs of pollinia are attached. Bees, wasps and larger insects serve as pollinating agents



FIG. 11.—Grass of Parnassus (*Parnassia palustris*). Half nat. size.

1, One of the scales which form the coronet in the flower, enlarged.

d. Deceptive flowers such as *Parnassia*, where the conspicuous coronet of glistening yellow balls suggests a plentiful supply of nectar drops (fig. 11).

e. Hoverfly flowers, small flowers which are beautifully coloured with radiating streaks pointing to a sharply-defined centre in which is the nectar, as in *Veronica chamaedrys* (fig. 12).

LITERATURE.—Joseph Gottlieb Kölreuter¹ (d. 1806) was the first to study the pollination of flowers and to draw attention to the

necessity of insect visits in many cases; he gave a clear account of cross-pollination by insect aid. He was followed by Christian Konrad Sprengel, whose work *Das entdeckte Geheimniss der Natur im Bau und in der Befruchtung der Blumen* (Berlin, 1793), contains a description of floral adaptations to insect visits in nearly 500 species of plants. Sprengel came very near to appreciating the meaning of cross-pollination in the life of plants when he states that "it seems that Nature is unwilling that any flower should be fertilized by its own pollen." In 1799 an Englishman, Thomas Andrew Knight, after experiments on the cross-fertilization of cultivated plants, formulated the conclusion that no plant fertilizes itself through many generations.

Sprengel's work, which had been almost forgotten, was taken up again by Charles Darwin, who concluded that no organic being can fertilize itself through an unlimited number of generations; but a cross with other individuals is occasionally—perhaps at very long intervals—indispensable. Darwin's works on dimorphic flowers and the fertilization of orchids gave powerful support to this statement. The study of the fertilization, or as it is now generally called "pollination," of flowers, was continued by Darwin and taken up by other workers, notably Friedrich Hildebrand, Federico Delpino and the brothers Fritz and Hermann Müller. Hermann Müller's work on *The Fertilization of Flowers by Insects and their Reciprocal Adaptations* (1873), followed by subsequent works on the same lines, brought together a great number of observations on floral mechanisms and their relation to insect-visits. Müller also suggested a modification of the Knight-Darwin law, which had left unexplained the numerous instances of continued successful self-pollination, and restated it on these terms: "Whenever offspring resulting from crossing comes into serious conflict with offspring resulting from self-fertilization, the former is victorious. Only where there is no such struggle for existence does self-fertilization often prove satisfactory for many generations." An increasing number of workers in this field of plant biology in England, on the Continent and in America has produced a great mass of observations, which have recently been brought together in Dr Paul Knuth's classic work, *Handbook of Flower Pollination*, an English translation of which has been published (1908) by the Clarendon Press.

POLLIO, GAIUS ASINIUS (76 B.C.—A.D. 5; according to some, 75 B.C.—A.D. 4), Roman orator, poet and historian. In 54 he impeached unsuccessfully C. Porcius Cato, who in his tribunate (56) had acted as the tool of the triumvirs. In the civil war between Caesar and Pompey Pollio sided with Caesar, was present at the battle of Pharsalus (48), and commanded against Sextus Pompeius in Spain, where he was at the time of Caesar's assassination. He subsequently threw in his lot with M. Antonius. In the division of the provinces, Gaul fell to Antony, who entrusted Pollio with the administration of Gallia Transpadana. In superintending the distribution of the Mantuan territory amongst the veterans, he used his influence to save from confiscation the property of the poet Virgil. In 40 he helped to arrange the peace of Brundisium by which Octavian (Augustus) and Antonius were for a time reconciled. In the same year Pollio entered upon his consulship, which had been promised him in 43. It was at this time that Virgil addressed the famous fourth eclogue to him. Next year Pollio conducted a successful campaign against the Parthini, an Illyrian people who adhered to Brutus, and celebrated a triumph on the 25th of October. The eighth eclogue of Virgil was addressed to Pollio while engaged in this campaign. From the spoils of the war he constructed the first public library at Rome, in the Atrium Libertatis, also erected by him (Pliny, *Nat. hist.* xxxv. 10), which he adorned with statues of the most celebrated

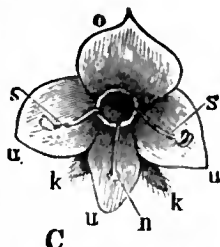

(From Vines's *Text Book of Botany*, by permission.)

FIG. 12.—Flower of *Veronica*.

k, Calyx.
u, u, u, The three lobes of the lower lip of the rotate corolla.
o, The upper lip.
s, s, s, The two stamens.
n, The stigma.

1 *Vorläufige Nachricht von einigen das Geschlecht der Pflanzen betreffenden Versuchen und Beobachtungen*, 3, 4, 6 (Leipzig, 1761).

authors, both Greek and Roman. Thenceforward he withdrew from active life and devoted himself to literature. He seems to have maintained to a certain degree an attitude of independence, if not of opposition, towards Augustus. He died in his villa at Tusculum, regretted and esteemed by all.

Pollio was a distinguished orator; his speeches showed ingenuity and care, but were marred by an affected archaism (Quintilian, *Inst.* x. 1, 113; Seneca, *Ep.* 100). He wrote tragedies also, which Virgil (*Ecl.* viii. 16) declared to be worthy of Sophocles, and a prose history of the civil wars of his time from the first triumvirate (60) down to the death of Cicero (43) or later. This history, in the composition of which Pollio received assistance from the grammarian Ateius Praetextatus, was used as an authority by Plutarch and Appian (Horace, *Odes*, ii. 1; Tacitus, *Annals*, iv. 34). As a literary critic Pollio was very severe. He censured Sallust (Suetonius, *Gram.* 10) and Cicero (Quintilian, *Inst.* xii. 1, 22) and professed to detect in Livy's style certain provincialisms of his native Padua (Quintilian, i. 5, 56, viii. 1, 3); he attacked the *Commentaries* of Julius Caesar, accusing their author of carelessness and credulity, if not of deliberate falsification (Suet. *Caesar*, 56). Pollio was the first Roman author who recited his writings to an audience of his friends, a practice which afterwards became common at Rome. The theory that Pollio was the author of the *Bellum africanum*, one of the supplements to Caesars's *Commentarii*, has met with little support. All his writings are lost except a few fragments of his speeches (H. Meyer, *Oral. rom. frag.*, 1842), and three letters addressed to Cicero (*Ad. Fam.* x. 31-33).

See Plutarch, *Caesar, Pompey*; Vell. Pat. ii. 36, 63, 73, 76; Florus iv. 12, 11; Dio Cassius xlv. 10, xlvi. 15; Appian, *Bell. civ.*; V. Gardthausen, *Augustus und seine Zeit* (1891), i.; P. Groebe, in Pauly-Wissowa's *Realencyclopädie* (1896), ii. pt. 2; Teuffel-Schwaben, *Hist. of Roman Literature* (Eng. trans.), § 221; M. Schanz, *Geschichte der römischen Literatur*, pt. 2, p. 20 (2nd ed., 1899); Cicero, *Letters*, ed. Tyrrell and Purser, vi. introd. p. 80.

PÖLLNITZ, KARL LUDWIG, FREIHERR VON (1692-1775), German adventurer and writer, was born at Issum on the 25th of February 1692. His father, Wilhelm Ludwig von Pöllnitz (d. 1693), was in the military service of the elector of Brandenburg, and much of his son's youth was passed at the electoral court in Berlin. He was a man of restless and adventurous disposition, unscrupulous even for the age in which he lived, visited many of the European courts, and served as a soldier in Austria, Italy and Spain. Returning to Berlin in 1735 he obtained a position in the household of King Frederick William I. and afterwards in that of Frederick the Great, with whom he appears to have been a great favourite; and he died in Berlin on the 23rd of June 1775.

Pöllnitz's *Mémoires* (Liège, 1734), which were translated into German (Frankfort, 1735), give interesting glimpses of his life and the people whom he met, but they are very untrustworthy. He also wrote *Nouveaux mémoires* (Amsterdam, 1737); *État abrégé de la cour de Saxe sous le règne d'Auguste III.* (Frankfort, 1734; Ger. trans., Breslau, 1736); and *Mémoires pour servir à l'histoire des quatre derniers souverains de la maison de Brandebourg*, published by F. L. Brunn (Berlin, 1791; Ger. trans., Berlin, 1791). Perhaps his most popular works are *La Saxe galante* (Amsterdam, 1734), an account of the private life of Augustus the Strong, elector of Saxony and king of Poland; and *Histoire secrète de la duchesse d'Hanovre, épouse de Georges I.* (London, 1732). There is an English translation of the *Mémoires* (London, 1738-1739). See P. von Pöllnitz, *Stammtafeln der Familie von Pöllnitz* (Berlin, 1894); and J. G. Droysen, *Geschichte der preussischen Politik*, pt. iv. (Leipzig, 1870).

POLLOCK, the name of an English family which has contributed many important members to the legal and other professions. David Pollock, who was the son of a Scotsman and built up a prosperous business in London as a saddler, had three distinguished sons: Sir David Pollock (1780-1847), chief justice of Bombay; Sir Jonathan Frederick Pollock, Bart. (1783-1870), chief baron of the exchequer; and Sir George Pollock, Bart. (1786-1872), field-marshal. Of these the more famous were the two last. Field Marshal Sir George Pollock, who rendered valuable military service in India, and especially in Afghanistan in 1841-1843, ended his days as constable of the Tower of London, and was buried in Westminster Abbey; his baronetcy, created in 1872, descended to his son Frederick (d. 1874), who assumed the name of Montagu-Pollock, and so to his heirs. Chief Baron Sir J. Frederick Pollock, who had been senior wrangler at Cambridge, and became F.R.S. in 1816, was raised to the bench in 1844, and created a baronet in 1866. He was twice married

and had eight sons and ten daughters, his numerous descendants being prominent in many fields. The chief baron's eldest son, Sir William Frederick Pollock, 2nd Bart. (1815-1888), became a master of the Supreme Court (1846) and queen's remembrancer (1874); his eldest son, Sir Frederick Pollock, 3rd Bart. (b. 1845), being the well-known jurist and legal historian, fellow of Trinity College, Cambridge, and Corpus professor of jurisprudence at Oxford (1883-1903), and the second son, Walter Herries Pollock (b. 1850), being a well-known author and editor of the *Saturday Review* from 1883 to 1894. The chief baron's third son, George Frederick Pollock (b. 1821), became a master of the Supreme Court in 1851, and succeeded his brother as queen's (king's) remembrancer in 1886; among his sons were Dr W. Rivers Pollock (1859-1909), Ernest Murry Pollock, K.C. (b. 1861), and the Rt. Rev. Bertram Pollock (b. 1863), bishop of Norwich, and previously head master of Wellington College from 1893 till 1910. The chief baron's fourth son, Sir Charles Edward Pollock (1823-1897), had a successful career at the bar and in 1873 became a judge, being the last survivor of the old barons of the exchequer; he was thrice married and had issue by each wife.

POLLOK, ROBERT (1798-1827), Scottish poet, son of a small farmer, was born at North Moorhouse, Renfrewshire, on the 19th of October 1798. He was trained as a cabinet-maker and afterwards worked on his father's farm, but, having prepared himself for the university, he took his degree at Glasgow, and studied for the ministry of the United Secession Church. He published *Tales of the Covenanters* while he was a divinity student, and planned and completed a strongly Calvinistic poem on the spiritual life and destiny of man. This was the *Course of Time* (1827), which passed through many editions and became a favourite in serious households in Scotland. It was written in blank verse, in ten books, in the poetic diction of the 18th century, but with abundance of enthusiasm, impassioned elevation of feeling and copious force of words and images. The poem at once became popular, but within six months of its publication, on the 18th of September 1827, its author died of consumption.

POLLOKSHAWES, a police burgh and burgh of barony of Renfrewshire, Scotland, on the White Cart, now virtually a suburb of Glasgow, with which it is connected by electric tramway and the Glasgow & South-Western and Caledonian railways. Pop. (1901), 11,183. It is named from the *shaws* or woods (and is locally styled "the Shaws") and the lands of Pollok, which have been held by the Maxwells since the 13th century. The family is now called Stirling-Maxwell, the estate and baronetcy having devolved in 1865 upon Sir William Stirling of Keir, who then assumed the surname of Maxwell. Pollok House adjoins the town on the west. The staple industries are cotton-spinning and weaving, silk-weaving, dyeing, bleaching, calico-printing and the manufacture of chenille and tapestry, besides paper mills, potteries and large engineering works. Pollokshaws was created a burgh of barony in 1813, and is governed by a council and provost. About 2 m. south-west is the thriving town of Thornliebank (pop. 2452), which owes its existence to the cotton-works established towards the end of the 18th century.

POLL-TAX, a tax levied on the individual, and not on property or on articles of merchandise, so-called from the old English poll, a head. Raised thus *per capita*, it is sometimes called a capitation tax. The most famous poll-tax in English history is the one levied in 1380, which led to the revolt of the peasants under Wat Tyler in 1381, but the first instance of the kind was in 1377, when a tax of a groat a head was voted by both clergy and laity. In 1379 the tax was again levied, but on a graduated scale. John of Gaunt, duke of Lancaster, paid ten marks, and the scale descended from him to the peasants, who paid one groat each, every person over sixteen years of age being liable. In 1380 the tax was also graduated, but less steeply. For some years after the rising of 1381 money was only raised in this way from aliens, but in 1513 a general poll tax was imposed. This, however, only produced about £50,000, instead of £160,000 as was expected, but a poll-tax levied in 1641 resulted in a revenue of about £400,600. During the reign of

Charles II. money was obtained in this way on several occasions, although in 1676-1677 especially there was a good deal of resentment against the tax. For some years after 1688 poll-taxes were a favourite means of raising money for the prosecution of the war with France. Sometimes a single payment was asked for the year; at other times quarterly payments were required. The poll-tax of 1697 included a weekly tax of one penny from all persons not receiving alms. In 1698 a quarterly poll-tax produced £321,397. Nothing was required from the poor, and those who were liable may be divided roughly into three classes. Persons worth less than £300 paid one shilling; those worth £300, including the gentry and the professional classes, paid twenty shillings; while tradesmen and shopkeepers paid ten shillings. Non-jurors were charged double these rates. Like previous poll-taxes, the tax of 1698 did not produce as much as was anticipated, and it was the last of its kind in England.

Many of the states of the United States of America raise money by levying poll-taxes, or, as they are usually called, capitation taxes, the payment of this tax being a necessary preliminary to the exercise of the suffrage.

See S. Dowell, *History of Taxation and Taxes in England* (1888), vol. iii.; and W. Stubbs, *Constitutional History* (1896), vol. ii.

POLLUX, JULIUS, of Naucratis in Egypt, Greek grammarian and sophist of the 2nd century A.D. He taught at Athens, where, according to Philostratus (*Vit. Soph.*), he was appointed to the professorship of rhetoric by the emperor Commodus on account of his melodious voice. Suidas gives a list of his rhetorical works, none of which has survived. Philostratus recognizes his natural abilities, but speaks of his rhetoric in very moderate terms. Pollux is probably the person attacked by Lucian in the *Lexiphanes* and *Teacher of Rhetoricians*. In the *Teacher of Rhetoricians* Lucian satirizes a worthless and ignorant person who gains a reputation as an orator by sheer effrontery; the *Lexiphanes*, a satire upon the use of obscure and obsolete words, may conceivably have been directed against Pollux as the author of the *Onomasticon*. This work, which we still possess, is a Greek dictionary in ten books, each dedicated to Commodus, and arranged not alphabetically but according to subject-matter. Though mainly a dictionary of synonyms and phrases, chiefly intended to furnish the reader with the Attic names for individual things, it supplies much rare and valuable information on many points of classical antiquity. It also contains numerous fragments of writers now lost. The chief authorities used were the lexicological works of Didymus, Tryphon, and Pamphilus; in the second book the extant treatise of Rufus of Ephesus *On the Names of the Parts of the Human Body* was specially consulted.

The chief editions of the *Onomasticon* are those of W. Dindorf (1824), with the notes of previous commentators, I. Bekker (1846), containing the Greek text only, and Bethe (1900). There are monographs on special portions of the vocabulary; by E. Rohde (on the theatrical terms, 1870), and F. von Stojentin (on constitutional antiquities, 1875).

POLLUX, or **POLLUCITE**, a rare mineral, consisting of hydrous caesium and aluminium silicate, $H_2Cs_4Al_4(SiO_3)_9$. Caesium oxide (Cs_2O) is present to the extent of 30-36 %, the amount varying somewhat owing to partial replacement by other alkalis, chiefly sodium. The mineral crystallizes in the cubic system. It is colourless and transparent, and has a vitreous lustre. There is no distinct cleavage and the fracture is conchoidal. The hardness is $6\frac{1}{2}$ and the specific gravity 2.90. It occurs sparingly, together with the mineral "castor" (see **PETALITE**), in cavities in the granite of the island of Elba, and with beryl in pegmatite veins at Rumford and Hebron in Maine.

POLO, GASPARD GIL (?1530-1591), Spanish novelist and poet, was born at Valencia about 1530. He is often confused with Gil Polo, professor of Greek at Valencia University between 1566 and 1573; but this professor was not named Gaspar. He is also confused with his own son, Gaspar Gil Polo, the author of *De origine et progressu juris romani* (1615) and other legal treatises, who pleaded before the Cortes as late as 1626. A notary by profession, Polo was attached to the treasury

commission which visited Valencia in 1571, became coadjutor to the chief accountant in 1572, went on a special mission to Barcelona in 1580, and died there in 1591. Timoneda, in the *Sarao de amor* (1561), alludes to him as a poet of repute; but of his miscellaneous verses only two conventional, eulogistic sonnets and a song survive. Polo finds a place in the history of the novel as the author of *La Diana enamorada*, a continuation of Montemayor's *Diana*, and perhaps the most successful continuation ever written by another hand. Cervantes, punning on the writer's name, recommended that "the *Diana enamorada* should be guarded as carefully as though it were by Apollo himself"; the hyperbole is not wholly, nor even mainly, ironical.

The book is one of the most agreeable of Spanish pastorals; interesting in incident, written in fluent prose, and embellished with melodious poems, it was constantly reprinted, was imitated by Cervantes in the *Canto de Caliope*, and was translated into English, French, German and Latin. The English version of Bartholomew Young, published in 1598 but current in manuscript fifteen years earlier, is said to have suggested the Felismena episode in the *Two Gentlemen of Verona*; the Latin version of Caspar Barth, entitled *Erotodidascalus* (Hanover, 1625), is a performance of uncommon merit as well as a bibliographical curiosity.

POLO, MARCO (c. 1254-1324), the Venetian, greatest of medieval travellers. Venetian genealogies and traditions of uncertain value trace the Polo family to Sebenico in Dalmatia, and before the end of the 11th century one Domenico Polo is found in the great council of the republic (1094). But the ascertained line of the traveller begins only with his grandfather. Andrea Polo of S. Felice was the father of three sons, Marco, Nicolo and Maffeo, of whom the second was the father of the subject of this article. They were presumably "noble," i.e. belonging to the families who had seats in the great council, and were enrolled in the Libro d' Oro; for we know that Marco the traveller is officially so styled (*nobilis vir*). The three brothers were engaged in commerce; the elder Marco, resident apparently in Constantinople and in the Crimea (especially at Sudak), suggests, by his celebrated will, a long business partnership with Nicolo and Maffeo.

About 1260, and even perhaps as early as 1250, we find Nicolo and Maffeo at Constantinople. Nicolo was married and had left his wife there. The two brothers went on a speculation to the Crimea, whence a succession of chances and openings carried them to the court of Barka Khan at Sarai, further north up to Bolghar (Kazan), and eventually across the steppes to Bokhara. Here they fell in with certain envoys who had been on a mission from the great Khan Kublai to his brother Hulagu in Persia, and by them were persuaded to make the journey to Cathay in their company. Under the heading CHINA the circumstances are noticed which in the last half of the 13th century and first half of the 14th threw Asia open to Western travellers to a degree unknown before and since—until the 19th century. Thus began the medieval period of intercourse between China and catholic Europe. Kublai, when the Polos reached his court, was either at Cambaluc (*Khanbaligh*, the Khan's city), i.e. Peking, which he had just rebuilt, or at his summer seat at Shangtu in the country north of the Great Wall. It was the first time that the khan, a man full of energy and intelligence, had fallen in with European gentlemen. He was delighted with the Venetian brothers, listened eagerly to all they had to tell of the Latin world, and decided to send them back as his envoys to the pope, with letters requesting the despatch of a large body of educated men to instruct his people in Christianity and the liberal arts. With Kublai, as with his predecessors, religion was chiefly a political engine. Kublai, the first of his house to rise above the essential barbarism of the Mongols, had perhaps discerned that the Christian Church could afford the aid he desired in taming his countrymen. It was only when Rome had failed to meet his advance that he fell back upon Buddhism as his chief civilizing instrument.

The brothers arrived at Acre in April 1269. They learned that Clement IV. had died the year before, and no new pope had yet been chosen. So they took counsel with an eminent churchman, Tedaldo, archdeacon of Liège and papal legate for the

whole realm of Egypt, and, being advised by him to wait patiently, went home to Venice, where they found that Nicolò's wife was dead, but had left a son Marco, now fifteen. The papal interregnum was the longest that had been known, at least since the dark ages. After the Polos had spent two years at home there was still no pope, and the brothers resolved on starting again for the East, taking young Marco with them. At Acre they again saw Tedaldo, and were furnished by him with letters to authenticate the causes that had hindered their mission. They had not yet left Lajazzo, Layas, or Ayas on the Cilician coast (then one of the chief points for the arrival and departure of the land trade of Asia), when they heard that Tedaldo had been elected pope. They hastened back to Acre, and at last were able to execute Kublai's mission, and to obtain a papal reply. But, instead of the hundred teachers asked for by the Great Khan, the new pope (styled Gregory X.) could supply but two Dominicans; and these lost heart and turned back, when they had barely taken the first step of their journey.

The second start from Acre must have taken place about November 1271; and from a consideration of the indications and succession of chapters in Polo's book, it would seem that the party proceeded from Lajazzo to Sivas and Tabriz, and thence by Yezd and Kirman down to Hormuz (Hurmuz) at the mouth of the Persian Gulf, with the purpose of going on to China by sea; but that, abandoning their naval plans (perhaps from fear of the flimsy vessels employed on this navigation from the Gulf eastwards), they returned northward through Persia. Traversing Kirman and Khorasan they went on to Balkh and Badakshan, in which last country young Marco recovered from illness. In a passage touching on the climate of the Badakshan hills, Marco breaks into an enthusiasm which he rarely betrays, but which is easily understood by those who have known what it is, with fever in the blood, to escape to the exhilarating mountain air and fragrant pine-groves. They then ascended the upper Oxus through Wakhan to the plateau of Pamir (a name first heard in Marco's book). These regions were hardly described again by any European traveller (save Benedict Goes) till the expedition in 1838 of Lieut. John Wood of the Indian navy, whose narrative abounds in incidental illustration of Marco Polo. Crossing the Pamir the travellers descended upon Kashgar, Yarkand and Khotan (Khutan). These are regions which remained almost absolutely closed to our knowledge till after 1860, when the temporary overthrow of the Chinese power, and the enterprise of British, Russian and other explorers, again made them known.

From Khotan the Polos passed on to the vicinity of Lop-Nor, reached for the first time since Polo's journey by Prjevalsky in 1871. Thence the great desert of Gobi was crossed to Tangut, as the region at the extreme north-west of China, both within and without the Wall, was then called.

In his account of the Gobi, or desert of Lop, as he calls it, Polo gives some description of the terrors and superstitions of the waste, a description which strikingly reproduces that of the Chinese pilgrim Suan T'sang, in passing the same desert in the contrary direction six hundred years before.

The Venetians, in their further journey, were met and welcomed by the Great Khan's people, and at last reached his presence at Shangtu, in the spring of 1275. Kublai received them with great cordiality, and took kindly to young Marco, by this time about twenty-one years old. The "young bachelor," as the book calls him, applied himself diligently to the acquisition of the divers languages and written characters chiefly in use among the multifarious nationalities subject to the Khan; and Kublai, seeing that he was both clever and discreet, soon began to employ him in the public service. G. Pauthier found in the Chinese annals a record that in the year 1277 a certain Polo was nominated as a second-class commissioner or agent attached to the imperial council, a passage which we may apply to the young Venetian. Among his public missions was one which carried him through the provinces of Shansi, Shensi, and Szechuen, and the wild country on the borders of Tibet, to the remote province of Yunnan, called by the Mongols *Karajang*,

and into northern Burma (Mien). Marco, during his stay at court, had observed the Khan's delight in hearing of strange countries, of their manners, marvels, and oddities, and had heard his frank expressions of disgust at the stupidity of envoys and commissioners who could tell of nothing but their official business. He took care to store his memory or his note-book with curious facts likely to interest Kublai, which, on his return to court, he related. This south-western journey led him through a country which till about 1860 was almost a *terra incognita*—though since the middle of the 19th century we have learned much regarding it through the journeys of Cooper, Garnier, Richthofen, Gill, Baber and others. In this region there existed and still exists in the deep valleys of the great rivers, and in the alpine regions which border them, a vast ethnological garden, as it were, of tribes of various origin, and in every stage of semi-civilization or barbarism; these afforded many strange products and eccentric traits to entertain Kublai.

Marco rose rapidly in favour and was often employed on distant missions as well as in domestic administration; but we gather few details of his employment. He held for three years the government of the great city of Yangchow; on another occasion he seems to have visited Kangchow, the capital of Tangut, just within the Great Wall, and perhaps Karakorom on the north of the Gobi, the former residence of the Great Khans: again we find him in Ciampa, or southern Cochin-China; and perhaps, once more, on a separate mission to the southern states of India. We are not informed whether his father and uncle shared in such employments, though they are mentioned as having rendered material service to the Khan, in forwarding the capture of Siang-yang (on the Han river) during the war against southern China, by the construction of powerful artillery engines—a story, however, perplexed by chronological difficulties.

All the Polos were gathering wealth which they longed to carry back to their home, and after their exile they began to dread what might follow Kublai's death. The Khan, however, was deaf to suggestions of departure and the opportunity only came by chance.

Arghun, khan of Persia, the grandson of Kublai's brother Hulagu, lost in 1286 his favourite wife, called by Polo *Balgana* (i.e. *Bulughan* or "Sable"). Her dying injunction was that her place should be filled only by a lady of her own Mongol tribe. Ambassadors were despatched to the court of Peking to obtain such a bride. The message was courteously received, and the choice fell on the lady Cocacin (Kukachin), a maiden of seventeen. The overland road from Peking to Tabriz was then imperilled by war, so Arghun's envoys proposed to return by sea. Having made acquaintance with the Venetians, and eager to profit by their experience, especially by that of Marco, who had just returned from a mission to the Indies, they begged the Khan to send the Franks in their company. He consented with reluctance, but fitted out the party nobly for the voyage, charging them with friendly messages to the potentates of Christendom, including the pope, and the kings of France, Spain and England. They sailed from *Zaiton* or Amoy Harbour in Fukien (a town corresponding either to the modern Changchow or less probably to Tswanchow or Chinchew), then one of the chief Chinese havens for foreign trade, in the beginning of 1292. The voyage involved long detention on the coast of Sumatra, and in south India, and two years or more passed before they arrived in Persia. Two of the three envoys and a vast proportion of their suite perished by the way; but the three Venetians survived all perils, and so did the young lady, who had come to look on them with filial regard. Arghun Khan had died even before they quitted China; his brother reigned in his stead; and his son Ghazan succeeded to the lady's hand. The Polos went on (apparently by Tabriz, Trebizond, Constantinople and Negropont) to Venice, which they seem to have reached about the end of 1295.

The first biographer of Marco Polo was the famous geographical collector John Baptist Ramusio, who wrote more than two centuries after the traveller's death. Facts and dates

sometimes contradict his statements, but he often adds detail, evidently authentic, of great interest and value, and we need not hesitate to accept as a genuine tradition the substance of his story of the Polos' arrival at their family mansion in St John Chrysostom parish in worn and outlandish garb, of the scornful denial of their identity, and the stratagem by which they secured acknowledgment from Venetian society.

We next hear of Marco Polo in a militant capacity. Jealousies had been growing in bitterness between Venice and Genoa throughout the 13th century. In 1298 the Genoese prepared to strike at their rivals on their own ground, and a powerful fleet under Lamba Doria made for the Adriatic. Venice, on hearing of the Genoese armament, equipped a fleet still more numerous, and placed it under Andrea Dandolo. The crew of a Venetian galley at this time amounted, all told, to 250 men, under a *comito* or master, but besides this officer each galley carried a *sopracomito* or gentleman-commander, usually a noble. On one of the galleys of Dandolo's fleet Marco Polo seems to have gone in this last capacity. The hostile fleets met before Curzola Island on the 6th of September, and engaged next morning. The battle ended in a complete victory for Genoa, the details of which may still be read on the façade of St Matthew's church in that city. Sixty-six Venetian galleys were burnt in Curzola Bay, and eighteen were carried to Genoa, with 7000 prisoners, one of whom was Marco Polo. The captivity was of less than a year's duration; by the mediation of Milan peace was made, on honourable terms for both republics, by July 1299; and Marco was probably restored to his family during that or the following month.

But his captivity was memorable as the immediate cause of his *Book*. Up to this time he had doubtless often related his experiences among his friends; and from these stories, and the frequent employment in them (as it would seem) of grand numerical expressions, he had acquired the nickname of *Marco Million*. Yet it would seem that he had committed nothing to writing. The narratives not only of Marco Polo but of several other famous medieval travellers (e.g. Ibn Batuta, Friar Odoric, Nicolo Conti) seem to have been extorted from them by a kind of pressure, and committed to paper by other hands. Examples, perhaps, of that intense dislike to the use of pen and ink which still prevails among ordinary respectable folk on the shores of the Mediterranean.

In the prison of Genoa Marco Polo fell in with a certain person of writing propensities, Rusticiano or Rustichello of Pisa, also a captive of the Genoese. His name is otherwise known as that of a respectable literary hack, who abridged and recast several of the French romances of the Arthurian cycle, then in fashion. He wrote down Marco's experiences at his dictation.

We learn little of Marco Polo's personal or family history after this captivity; but we know that at his death he left a wife, Donata (perhaps of the Loredano family, but this is uncertain), and three daughters, Fantina and Bellela (married, the former to Marco Bragadino), and Moreta (then a spinster, but married at a later date to Ranuzzo Dolfino). One last glimpse of the traveller is gathered from his will, now in St Mark's library. On the 9th of January 1324 the traveller, in his seventieth year, sent for a neighbouring priest and notary to make his testament. We do not know the exact time of his death, but it fell almost certainly within the year 1324, for we know from a scanty series of documents, beginning in June 1325, that he had at the latter date been some time dead. He was buried, in accordance with his will, in the Church of St Lorenzo, where the family burying-place was marked by a sarcophagus, erected by his filial care for his father Nicolo, which existed till near the end of the 16th century. On the renewal of the church in 1502 this seems to have disappeared.

The archives of Venice have yielded a few traces of our traveller. Besides his own will just alluded to, there are the wills of his uncle Marco and of his younger brother Maffeo; a few legal documents connected with the house property in St John Chrysostom, and other papers of similar character; and

two or three entries in the record of the *Maggior Consiglio*. We have mentioned the sobriquet of Marco Million. Ramusio tells us that he had himself noted the use of this name in the public books of the commonwealth, and this statement has been verified in an entry in the books of the Great Council (dated April 10, 1305), which records as one of the securities in a certain case the "*Nobilis vir Marchus Paulo MILION.*" It is alleged that long after the traveller's death there was always in the Venetian masques one individual who assumed the character of Marco Million, and told Munchausen-like stories to divert the vulgar. There is also a record (March 9, 1311) of the judgment of the court of requests (*Curia Petitionum*) upon a suit brought by the "*Nobilis vir Marcus Polo*" against Paulo Girardo, who had been an agent of his, to recover the value of a certain quantity of musk for which Girardo had not accounted. Another document is a catalogue of certain curiosities and valuables which were collected in the house of Marino Faliero, and this catalogue comprises several objects that Marco Polo had given to one of the Faliero family.

The most tangible record of Polo's memory in Venice is a portion of the Ca' Polo—the mansion (there is reason to believe) where the three travellers, after their long absence, were denied entrance. The court in which it stands was known in Ramusio's time as the *Corte del millioni*, and now is called *Corte Sabbionera*. That which remains of the ancient edifice is a passage with a decorated archway of Italo-Byzantine character pertaining to the 13th century.

No genuine portrait of Marco Polo exists. There is a medallion portrait on the wall of the Sala dello Scudo in the ducal palace, which has become a kind of type; but it is a work of imagination no older than 1761. The oldest professed portrait is one in the gallery of Monsignor Badia at Rome, which is inscribed *Marcus Polus venetus totius orbis et Indie peregrator primus*. It is a good picture, but evidently of the 16th century at earliest. The Europeans at Canton have absurdly attached the name of Marco Polo to a figure in a Buddhist temple there containing a gallery of "Arhans" or Buddhist saints, and popularly known as the "temple of the five hundred gods." The Venetian municipality obtained a copy of this on the occasion of the geographical congress at Venice in 1881.

The book indited by Rusticiano is in two parts. The first, or prologue, as it is termed, is unfortunately the only part which consists of actual personal narrative. It relates in an interesting though extremely brief fashion the circumstances which led the two elder Polos to the Khan's court, together with those of their second journey (when accompanied by Marco), and of the return to the west by the Indian seas and Persia. The second and staple part consists of a series of chapters of unequal length and unsystematic structure, descriptive of the different states and provinces of Asia (certain African islands and regions included), with occasional notices of their sights and products, of curious manners and remarkable events, and especially regarding the Emperor Kublai, his court, wars and administration. A series of chapters near the close treats of sundry wars that took place between various branches of the house of Jenghiz in the latter half of the 13th century. This last series is either omitted or greatly curtailed in all the MS. copies and versions except one (Paris, National Library, Fonds Fr. 1116).

It was long doubtful in what language the work was originally written. That this had been some dialect of Italian was a natural presumption, and a contemporary statement could be alleged in its favour. But there is now no doubt that the original was French. This was first indicated by Count Baldelli-Boni, who published an elaborate edition of two of the Italian texts at Florence in 1827, and who found in the oldest of these indisputable signs that it was a translation from the French. The argument has since been followed up by others; and a manuscript in rude and peculiar French, belonging to the National Library of Paris (Fonds Fr. 1116), which was printed by the *Société de géographie* in 1824, is evidently either the original or a close transcript of the original dictation. A variety of its characteristics are strikingly indicative of the unrevised product of dictation, and are such as would necessarily have disappeared either in a translation or in a revised copy. Many illustrations could be adduced of the fact that the use of French was not a circumstance of surprising or unusual nature; for the language had at that time, in some points of view, even a wider diffusion than at present, and examples of its literary employment by writers who were not Frenchmen (like Rusticiano himself, a compiler of French romances) are very numerous.

Eighty-five MSS. of the book are known, and their texts exhibit considerable differences. These fall under four principal types. Of these, type i. is found completely only in that old French codex which has been mentioned (Paris, National Library, Fr. 1116). Type ii. is shown by several valuable MSS. in purer French (Paris, Nat. Libr., Fr. 2810; Fr. 5631; Fr. 5649; Bern, Canton Library, 125), which formed the basis of the edition prepared by the late M. Pauthier in 1865. It exhibits a text condensed and revised from the rude original, but without any exactness, though perhaps under some general direction by Marco Polo himself, for an inscription prefixed to certain MSS. (Bern, Canton Libr. 125; Paris, Nat. Libr., Fr. 5649) records the presentation of a copy by the traveller himself to the Seigneur Thiébauld de Cépo, a distinguished Frenchman known to history, at Venice in the year 1306. Type iii. is that of a Latin version prepared in Marco Polo's lifetime, though without any sign of his cognisance, by Francesco Pipino, a Dominican of Bologna, and translated from an Italian copy. In this, condensation and curtailment are carried a good deal further than in type ii. Some of the forms under which this type appears curiously illustrate the effects of absence of effective publication, not only before the invention of the press, but in its early days. Thus the Latin version published by Grynaeus at Basel in the *Novus Orbis* (1532) is different in its language from Pipino's, and yet is clearly traceable to that as its foundation. In fact it is a retranslation into Latin from some version of Pipino (Marsden thinks the Portuguese printed one of 1502). It introduces changes of its own, and is worthless as a text; yet Andreas Müller, who in the 17th century took so much trouble with Polo, unfortunately chose as his text this fifth-hand version. The French editions published in the middle of the 16th century were translations from Grynaeus's Latin. Hence they complete this curious and vicious circle of transmission—French, Italian, Pipino's Latin, Portuguese, Grynaeus's Latin, French.

Type iv. deviates largely from those already mentioned; its history and true character are involved in obscurity. It is only represented by the Italian version prepared for the press by John Baptist Ramusio, with interesting preliminary dissertations, and published at Venice two years after his death, in the second volume of the *Navigazioni e viaggi*. Its peculiarities are great. Ramusio seems to imply that he made some use of Pipino's Latin, and various passages confirm this. But many new circumstances, and anecdotes occurring in no other copy, are introduced; many names assume a new shape; the whole style is more copious and literary than that of any other version. While a few of the changes and interpolations seem to carry us farther from the truth, others contain facts of Asiatic nature or history, as well as of Polo's alleged experiences, which it is difficult to ascribe to any hand but the traveller's own.

We recognize to a certain extent tampering with the text, as in cases where Polo's proper names have been identified, and more modern forms substituted. In some other cases the editorial spirit has gone astray. Thus the age of young Marco has been altered to correspond with a date which is itself erroneous. Ormuz is described as an island, contrary to the old texts, and to the fact in Polo's time. In speaking of the oil-springs of Caucasus the phrase "camel-loads" has been substituted for "ship-loads," in ignorance that the site was Baku on the Caspian.

But, on the other hand, there are a number of new circumstances certainly genuine, which can hardly be ascribed to any one but Polo himself. Such is the account which Ramusio's version gives of the oppressions exercised by Kublai's Mahomedan minister Ahmad, telling how the Cathayans rose against him and murdered him, with the addition that Messer Marco was on the spot when all this happened. Not only is the whole story in substantial accordance with the Chinese annals, even to the name of the chief conspirator (*Vanchu* in Ramusio, *Wangcheu* in the Chinese records), but the annals also tell of the frankness of "Polo, assessor of the privy council," in opening Kublai's eyes to the iniquities of his agent.

Polo was the first traveller to trace a route across the whole longitude of Asia, naming and describing kingdom after kingdom which he had seen; the first to speak of the new and brilliant court which had been established at Peking; the first to reveal China in all its wealth and vastness, and to tell of the nations on its borders; the first to tell more of Tibet than its name, to speak of Burma, of Laos, of Siam, of Cochin-China, of Japan, of Java, of Sumatra and of other islands of the archipelago, of the Nicobar and Andaman Islands, of Ceylon and its sacred peak, of India but as a country seen and partially explored; the first in medieval times to give any distinct account of the secluded Christian Empire of Abyssinia, and of the semi-Christian island of Sokotra, and to speak, however dimly, of Zanzibar, and of the vast and distant Madagascar; whilst he carries us also to the remotely opposite region of Siberia and the Arctic shores, to speak of dog-sledges, white bears and reindeer-riding Tunguses.

The diffusion of the book was hardly so rapid as has been sometimes alleged. We know from Gilles Mallet's catalogue of the books collected in the Louvre by Charles V., dating c. 1370-1375, that five copies of Marco Polo's work were then in the collection; but on the other hand, the 202 known MSS. and the numerous early printed

editions of "Mandeville," with his lying wonders, indicates a much greater popularity. Dante, who lived twenty-three years after the book was dictated, and who touches so many things in the seen and unseen worlds, never alludes to Polo, nor, we believe, to anything that can be connected with him; nor can any trace of Polo be discovered in the book of his contemporary, Marino Sanudo the Elder, though this worthy is well acquainted with the work, later by some years, of Hayton the Armenian, and though many of the subjects on which he writes in his own book (*Secreta Fidelium Crucis*)¹ challenge a reference to Polo's experiences. "Mandeville" himself, who plundered right and left, hardly ever plunders Polo (see one example in *Dawn of Modern Geography*, iii. 323, note). The only literary works we know of the 14th century which show acquaintance with Polo's book or achievements are Pipino's *Chronicle*, Villani's *Florentine History*, Pietro d'Abano's *Conciliator*, the *Chronicle* of John of Ypres, and the poetical romance of *Baudouin de Sebourc*, which last borrows themes largely from Polo.

Within the traveller's own lifetime we find the earliest examples of the practical and truly scientific coast-charts (*Portolani*), based upon the experience of pilots, mariners, merchants, &c. In two of the most famous of the 14th century *Portolani*, we trace Marco Polo's influence—first, very slightly in the *Laurentian* or *Medicean Portolano* of 1351 (at Florence), but afterwards with clearness and in remarkable detail in the *Catalan Atlas* of 1375 (now at Paris). Both of these represent a very advanced stage of medieval knowledge, a careful attempt to represent the known world on the basis of collected fact, and a disregard for theological or pseudo-scientific theory; in the *Catalan Atlas*, as regards Central and Further Asia, and partially as regards India, Marco Polo's *Book* is the basis of the map. His names are often much perverted, and it is not always easy to understand the view that the compiler took of his itineraries. Still we have Cathay placed in the true position of China, as a great empire filling the south-east of Asia. The trans-Gangetic peninsula is absent, but that of India proper is, for the first time in the history of geography, represented with a fair approximation to correct form and position.

It is curious that, in the following age, owing partly to his unhappy reversion to the fancy of a circular disk, the map of Fra Mauro (1459), one of the greatest map-making enterprises in history, and the result of immense labour in the collection of facts and the endeavour to combine them, gives a much less accurate idea of Asia than the *Carta catalana*. Columbus possessed a printed copy of the Latin version of Polo's book made by Pipino, and on more than seventy pages of this there are manuscript notes in the admiral's handwriting, testifying, what is sufficiently evident from the whole history of the Columbian voyages, to the immense influence of the work of the Venetian merchant upon the discoverer of the new world.

When, in the 16th century, attempts were made to combine new and old knowledge, the results were unhappy. The earliest of such combinations tried to realize Columbus's ideas regarding the identity of his discoveries with the Great Khan's dominions; but even after America had vindicated its independent existence, and the new knowledge of the Portuguese had named *China* where the Catalan map had spoken of *Cathay*, the latter country, with the whole of Polo's nomenclature, was shunted to the north, forming a separate system. Henceforward the influence of Polo's work on maps was simply injurious; and when to his names was added a sprinkling of Ptolemy's, as was usual throughout the 16th century, the result was a hotchpotch conveying no approximation to facts (see further MAP).

As to the alleged introduction of important inventions into Europe by Polo—although the striking resemblance of early European block-books to those of China seems clearly to indicate the derivation of the art from that country, there is no reason for connecting this introduction (any more than that of gunpowder or the mariner's compass) with the name of Marco. In the 14th century not only were missions of the Roman Church established in some of the chief cities of eastern China, but a regular overland trade was carried on between Italy and China, by way of Tana (Azov), Astrakhan, Otrar, Kamul (Hami) and Kanchow. Many a traveller other than Marco Polo might have brought home the block-books, and some might have witnessed the process of making them. This is the less to be ascribed to Polo, because he so curiously omits to speak of the process of printing, when, in describing the block-printed paper-money of China, his subject seems absolutely to challenge a description of the art.

See the *Recueil* of the Paris Geographical Society (1824), vol. i., giving the text of the fundamental MS. (Nat. Libr. Paris, Fr. 1116; see above), as well as that of the oldest Latin version; G. Pauthier's edition, *Livre . . . de Marco Polo . . .* (Paris, 1865), based mainly upon the three Paris MSS. (Nat. Libr. Fr. 2810; Fr. 5631; Fr. 5649; see above) and accompanied by a commentary of great value; Baldelli-Boni's Italian edition, giving the oldest Italian version (Florence, 1827); Sir Henry Yule's edition, which in its final shape, as revised and augmented by Henri Cordier (. . . *Marco Polo* . . . London, 1903), is the most complete

¹ Printed by Bongars in the collection called *Gesta Dei per Francos* (1611), ii. 1-281.

storehouse of Polo learning in existence, embodying the labours of all the best students of the subject, and giving the essence of such works as those of Major P. Molesworth Sykes (*Ten Thousand Miles in Persia*, &c.) so far as these touch Marco Polo; the Archimandrite Palladius Katharov's "Elucidations of Marco Polo" (from vol. x. of the *Journal of the North China Branch of the Royal Asiatic Society* (1876), pp. 1-54; F. von Richthofen, *Letters to Shanghai Chamber of Commerce*; E. C. Baber, *Travels . . . in Western China*; G. Phillips, *Identity of . . . Zaitun with Chang-chau in T'oung Pao* (Oct. 1890), and other studies in *T'oung-Pao* (Dec. 1895 and July 1896). There are in all 10 French editions of Polo as well as 4 Latin editions, 27 Italian, 9 German, 4 Spanish, 1 Portuguese, 12 English, 2 Russian, 1 Dutch, 1 Bohemian (Chekh), 1 Danish and 1 Swedish. See also E. Bretschneider, *Mediaeval Researches from Eastern Asiatic Sources*, i. 239, 167; ii. 8, 71, 81-84, 184; Léon Cahun, *Introduction à l'histoire de l'Asie*, 339, 386; C. Raymond Beazley, *Dawn of Modern Geography*, iii. 15-160, 545-547, 554, 556-563. (H. Y.; C. R. B.)

POLO (Tibetan *pulu*, ball), the most ancient of games with stick and ball. Hockey, the Irish national game of hurling (and possibly golf and cricket) are derived from polo. **History.** The latter was called hockey or hurling on horseback in England and Ireland respectively, but historically hockey and hurling are polo on foot.

The earliest records of polo are Persian. From Persia the game spread westward to Constantinople, eastwards through Turkestan to Tibet, China and Japan. From Tibet polo travelled to Gilgit and Chitral, possibly also to Manipur. Polo also flourished in India in the 16th century. Then for 200 years its records in India cease, till in 1854 polo came into Bengal from Manipur by way of Cachar and in 1862 the game was played in the Punjab.

There have been twelve varieties of the game during its existence of at least 2000 years. (1) A primitive form consisting of feats of horsemanship and of skill with stick and ball. (2) Early Persian, described in *Shahnama*, a highly organized game with rules, played four aside. (3) Later Persian, 16th century, the grounds 300 by 170 yds. Sir Anthony Shirley says the game resembled the rough football of the same period in England. (4) The game in the 17th century in Persia. A more highly organized game than No. 3, as described by Chardin. (5) The Byzantine form played at Constantinople in the 12th century. A leathern ball the size of an apple and a racquet were used. (6) The Chinese game, about A.D. 600 played with a light wooden ball. The goal was formed by two posts with a boarding between, in the latter a hole being cut and a net attached to it in the form of a bag. The side which hit the ball into the bag were the winners. Another Chinese form was two teams ranged on opposite sides of the ground, each defending its own goal. The object of the game was to drive the ball through the enemy's goal. (7) The Japanese game, popular in feudal times, still survives under the name of Dakiu, or ball match. The Japanese game has a boarded goal; 5 ft. from the ground is a circular hole 1 ft. 2 in. in diameter with a bag behind. The balls are of paper with a cover of pebbles or bamboo fibre, diameter 1.7 in., weight 1½ oz. The sticks are racket shaped. The object is to lift over or carry the ball with the racket and place it in the bag. (8) Called *rāl*, played with a long stick with which the ball was dribbled along the ground. (9) Another ancient Indian form in which the sides ranged up on opposite sides of the ground and the ball was thrown in. This is probably the form of the game which reached India from Persia and is represented at the present day by Manipur and Gilgit polo, though these forms are probably rougher than the old Indian game. (10) Modern English with heavy ball and sticks, played in England and the colonies and wherever polo is played in Europe. Its characteristics are: offside; severe penalties for breach of the rules; close combination; rather short passing; low scoring, and a strong defence. (11) Indian polo has a lighter ball, no boards to the grounds, which are usually full-sized; a modified offside-rule, but the same system of penalties. It is a quicker game than the English. (12) The American game has no offside and no penalties, in the English sense. The attack is stronger, the passing longer, the pace greater and more sustained. American players are more certain

goal-bitters and their scoring is higher. They defeated the English players in 1909 with ease.

Polo was first played in England by the 10th Hussars in 1860. The game spread rapidly and some good play was seen at Lillie Bridge. But the organization of polo in England dates from its adoption by the Hurlingham Club in 1873. The ground was boarded along the sides, and this device, which was employed as a remedy for the irregular shape of the Hurlingham ground, has become almost universal and has greatly affected the development of the game. The club committee, in 1874, drew up the first code of rules, which reduced the number of players to five a side and included offside. The next step was the foundation of the Champion Cup, in 1877. Then came the rule dividing the game into periods of ten minutes, with intervals of two minutes for changing ponies after each period, and five minutes at half-time. The height of ponies was fixed at 14.2, and a little later an official measurer was appointed, no pony being allowed to play unless registered at Hurlingham. The next change was the present scale of penalties for offside, foul riding or dangerous play. A short time after, the crooking of the adversary's stick, unless in the act of hitting the ball, was forbidden. The game grew faster, partly as the result of these rules. Then the ten minutes' rule was revised. The period did not close until the ball went over the boundary. Thus the period might be extended to twelve or thirteen minutes, and although this time was deducted from the next period the strain of the extra minutes was too great on men and ponies. It was therefore laid down that the ball should go out of play on going out of bounds or striking the board, whichever happened first. In 1910 a polo handicap was established, based on the American system of estimating the number of goals a player was worth to his side. This was modified in the English handicap by assigning to each player a handicap number as at golf. The highest number is ten, the lowest one. The Hurlingham handicap is revised during the winter, again in May, June and July, each handicap coming into force one month after the date of issue. In tournaments under handicap the individual handicap numbers are added together, and the team with the higher aggregate concedes goals to that with the lower, according to the conditions of the tournament. The handicap serves to divide second from first class tournaments, for the former teams must not have an aggregate over 25.

The size of the polo ground is 300 yds. in length and from 160 to 200 yds. in width. The larger size is only found now where boards are not used. The ball is made of willow root, is 3½ in. in diameter, weight not over 5½ oz. The polo stick has no standard size or weight, and square or cigar-shaped heads are used at the discretion of the player. On soft grounds, the former, on hard grounds the latter are the better, but Indian and American players nearly always prefer the cigar shape.

The goal posts, now generally made of papier mâché, are 8 yds. apart. This is the goal line. Thirty yards from the goal line a line is marked out, nearer than which to the goal no one of a fouled side may be when the side fouling has to hit out, as a penalty from behind the back line, which is the goal line produced. At 50 yds. from each goal there is generally a mark to guide the man who takes a free hit as a penalty.

Penalties are awarded by the umpires, who should be two in number, well mounted, and with a good knowledge of the rules of the game. The Hurlingham and Ranelagh clubs appoint official umpires. There should also be a referee in case of disagreement between the umpires, and it is usual to have a man with a flag behind each goal to signal when a goal is scored. The Hurlingham club makes and revises the rules of the game, and its code is, with some local modifications, in force in the United Kingdom, English-speaking colonies, the Argentine Republic, California, and throughout Europe. America and India are governed by their own polo associations.

The American rules have no offside, and their penalties consist of subtracting a goal or the fraction of a goal, according to the offence, from the side which has incurred a penalty for fouling. The differences between the Hurlingham and Indian rules

are very slight, and they tend to assimilate more as time goes on.

Polo in the army is governed by an army polo committee, which fixes the date of the inter-regimental tournament. The semi-finals and finals are played at Hurlingham. The earlier ties take place at centres arranged by the army polo committee, who are charged by the military authorities with the duty of checking the expenditure of officers on the game. The value of polo as a military exercise is now fully recognized, and with the co-operation of Hurlingham, Ranelagh and Roehampton the expenses of inter-regimental tournaments have been regulated and restrained.

The County Polo Association has affiliated to it all the county clubs. It is a powerful body, arranging the conditions of county tournaments, constructing the handicaps for county players, and in conjunction with the Ranelagh club holding a polo week for county players in London. The London clubs are three—Hurlingham, Ranelagh and Roehampton. Except that they use Hurlingham rules the clubs are independent, and arrange the conditions and fix the dates of their own tournaments. Ranelagh has four, Roehampton three and Hurlingham two polo grounds. There are about 400 matches played at these clubs, besides members' games from May to July during the London season. At present the Meadowbrook still hold the cup which was won

by an English team in 1886. In 1902 an American **International Polo** team made an attempt to recover it and failed. They lacked ponies and combination; but they bought the first and learned the second, and tried again successfully in 1909, thus depriving English polo of the championship of the world.

Polo in England has passed through several stages. It was always a game of skill. The cavalry regiments in India in early polo days, the 5th, 9th, 12th and 17th Lancers, the

The Game. 10th Hussars and the 13th Hussars, had all learned the value of combination. In very early days regimental players had learned the value of the backhanded stroke, placing the ball so as to give opportunities to their own side. The duty of supporting the other members of the team and riding off opponents so as to clear the way for players on the same side was understood. This combination was made easier when the teams were reduced from five a side to four. Great stress was laid on each man keeping his place, but a more flexible style of play existed from early days in the 17th Lancers and was improved and perfected at the Rugby Club by the late Colonel Gordon Renton and Captain E. D. Miller, who had belonged to that regiment. For a long time the Rugby style of play, with its close combination, short passes and steady defence, was the model on which other teams formed themselves. The secret of the success of Rugby was the close and unselfish combination and the hard work done by every member of the team. After the American victories of 1909 a bolder, harder hitting style was adopted, and the work of the forwards became more important, and longer passes are now the rule. But the main principles are the same. The forwards lead the attack and are supported by the half-back and back when playing towards the adversaries' goal. In defence the forwards hamper the opposing No. 3 and No. 4 and endeavour to clear the way for their own No. 3 and No. 4, who are trying not merely to keep the ball out of their own goal but to turn defence into attack. Each individual player must be a good horseman, able to make a pony gallop, must have a control of the ball, hitting hard and clean and in the direction he wishes it to go. He must keep his eye on the ball and yet know where the goal-posts are, must be careful not to incur penalties and quick to take advantage of an opportunity. Polo gives no time for second thoughts. A polo player must not be in a hurry, but he must never be slow nor dwell on his stroke. He must be able to hit when galloping his best pace on to the ball and able to use the speed of his pony in order to get pace. He must be able to hit a backhander or to meet a ball coming to him, as the tactics of the game require.

Polo has given rise to a new type of horse, an animal of 14 hands 2 in. with the power of a hunter, the courage of a

racehorse and the docility of a pony. At first the ponies were small, but now each pony must pass the Hurlingham official measurer and be entered on the register. The English **The Polo system of measurement is the fairest and most humane possible.**

The pony stripped of his clothing is led by an attendant, not his own groom, into a box with a perfectly level floor and shut off from every distraction. A veterinary surgeon examines to see that the pony is neither drugged nor in any way improperly prepared. The pony is allowed to stand easily, and a measuring standard with a spirit-level is then placed on the highest point of the wither, and if the pony measures 14.2 and is five years old it is registered for life. Ponies are of many breeds. There are Arabs, Argentines, Americans, Irish and English ponies, the last two being the best. The Polo and Riding Pony Society, with headquarters at 12 Hanover Square, looks after the interests of the English and Irish pony and encourages their breeders. The English ponies are now bred largely for the game and are a blend of thoroughbred blood (the best are always the race-winning strains) or Arab and of the English native pony.

AUTHORITIES.—*Polo in England*: J. Moray Brown, *Riding and Polo*, Badminton Library, revised and brought up to date by T. F. Dale (Longmans, 1899); Captain Younghusband, *Polo in India*, (n.d.); J. Moray Brown, *Polo* (Vinton, 1896); T. F. Dale, *The Game of Polo* (A. Constable & Co., 1897); Captain Younghusband, *Tournament Polo* (1897); Captain de Lisle, Durham Light Infantry, *Hints to Polo Players in India* (1897); T. B. Drybrough, *Polo* (Vinton, 1898; revised, Longmans, 1906); Captain E. D. Miller, *Modern Polo* (1903); H. L. Fitzpatrick, *Equestrian Polo*, in Spalding's Athletic Library (1904); Major G. J. Younghusband, *Tournament Polo* (1904); T. F. Dale "Polo, Past and Present," *Country Life*; Walter Buckmaster, "Hints on Polo Combination," *Library of Sport* (George Newnes Ltd., 1905; Vinton & Co., 1909); Hurlingham Club, *Rules of Polo, Register of Ponies; Polo and Riding Pony Society Stud Book* (12 vols., 12 Hanover Square). *Annals*: American Polo Association, 143 Liberty Street, New York; Indian Polo Association, Lucknow, N. P.; Captain E. D. Miller, D.S.O., *The Polo Players' Guide and Almanack; The Polo Annual*, ed. by L. V. L. Simmonds. *Monthlies*: *Bailey's Magazine* (Vinton & Co.); *The Polo Monthly* (Craven House, Kingsway, London).

Polo in Persia: Firdousi's *Shahnama*, translated as *Le Livre des rois* by J. Mohl, with notes and comm.; Sir Anthony Shirley, *Travels in Persia* (1569); Sir John Chardin, *Voyages en Perse* (1686), ed. aug. de notes, &c. par L. Langles, 1811; Sir William Ouseley, *Travels in Various Countries of the East, particularly Persia* (1810).

There are many allusions to polo in the poets, notably Nizami, Jami and Omar Khayyam.

Polo in Constantinople: *Cinnamus Joannes epitome rerum ab Ioanne et Alexio Commenis gest.* (Bonn, 1836).

Polo in India: Ain-i-Akbari (1555); G. F. Vigne, *Travels in Kashmir* (Ladakh and Iskardo, 1842); Colonel Algernon Durand, *The Making of a Frontier* (1899).

Polo in Gilgit and Chitral: "Polo in Baltistan." *The Field* (1888); *Polo in Manipur*, Captain McCulloch, *Manipuris and the Adjacent Tribes* (1859). (T. F. D.)

POLONAISE (i.e. Polish, in French), a stately ceremonious dance, usually written in $\frac{3}{4}$ time. As a form of musical composition it has been employed by such composers as Bach, Handel, Beethoven, and above all by Chopin. It is usual to date the origin of the dance from the election (1573) of Henry duke of Anjou, afterwards Henry III. of France, to the throne of Poland. The ladies of the Polish nobility passed in ceremonial procession before him at Cracow to the sound of stately music. This procession of music became the regular opening ceremony at royal functions, and developed into the dance.

The term is also given to a form of skirted bodice, which has been fashionable for ladies at different periods.

POLONNARUWA, a ruined city and ancient capital of Ceylon. It first became a royal residence in A.D. 368, when the lake of Topawewa was formed, and succeeded Anuradhapura as the capital in the middle of the 8th century. The principal ruins date chiefly from the time of Prakrama Bahu (A.D. 1153-1186). The most imposing pile remaining is the Jetawanarama temple, a building 170 ft. in length, with walls about 80 ft. high and 12 ft. thick. The city is now entirely deserted, and, as in the case of Anuradhapura, its ruins have only recently been rescued from the jungle.

POLOTSK, a town of Russia, in the government of Vitebsk, at the confluence of the Polota with the Dvina, 62 m. by rail N.W. of the town of Vitebsk. Pop. 20,751. Owing to the continuous wars, of which, from its position on the line of communication between central Russia and the west it was for many centuries the scene, scarcely any of its remarkable antiquities remain. The upper castle, which stood at the confluence of the rivers and had a stone wall with seven towers, is in ruins, as is the lower castle formerly enclosed with strong walls and connected with the upper castle by a bridge. The cathedral of St Sophia in the upper castle, built in the 12th century, fell to ruins in the 18th century, whereupon the United Greek bishop substituted a modern structure. Upwards of two-thirds of the inhabitants are Jews; the remainder have belonged mostly to the Orthodox Greek Church since 1839, when they were compelled to abandon the United Greek Church. Flax, linseed, corn and timber are the leading articles of commerce.

Polotesk or Poltesk is mentioned in 862 as one of the towns given by the Scandinavian Rurik to his men. In 980 it had a prince of its own, Ragvald (Rogvolod or Rognvald), whose daughter is the subject of many legends. It remained an independent principality until the 12th century, resisting the repeated attacks of the princes of Kiev; those of Pskov, Lithuania, and the Livonian Knights, however, proved more effective, and Polotsk fell under Lithuanian rule in 1320. About 1385 its independence was destroyed by the Lithuanian prince Vitovt. It was five times besieged by Moscow in 1500-18, and was taken by Ivan the Terrible in 1563. Recaptured by Stephen Bathory, king of Poland, sixteen years later, it became Polish by the treaty of 1582. It was then a large and populous city, and carried on an active commerce. Pestilences and conflagrations were its ruin; the plague of 1566 wrought great havoc among its inhabitants, and that of 1600 destroyed 15,000. The castles, the town and its walls were burned in 1607 and 1642. The Russians continued their attacks, burning and plundering the town, and twice, in 1633 and 1705, taking possession of it for a few years. It was not definitely annexed, however, to Russia until 1772, after the first dismemberment of Poland. In 1812 its inhabitants resisted the French invasion, and the town was partially destroyed.

POLTAVA, a government of south-western Russia, bounded by the government of Chernigov on the N., Kharkov on the E., Ekaterinoslav and Kherson on the S., and Kiev on the W., and having an area of 19,260 sq. m. Its surface is an undulating plain 500 to 600 ft. above sea-level, with a few elevations reaching 670 ft. in the north, and gently sloping to 300 and 400 ft. in the south-west. Owing to the deep excavations of the rivers, their banks, especially those on the right, have the aspect of hilly tracts, while low plains stretch to the left. Almost the whole of the surface consists of Tertiary deposits; Cretaceous rocks appear in the north-east, at the bottom of the deeper ravines. The government touches the granitic region of the Dnieper only in the south, below Kremenchug. Limestone with dolerite veins occurs in the isolated hill of Isachek, which rises above the marshes of the Sula. The whole is covered with a layer, 20 to 60 ft. thick, of boulder clay, which again is often mantled with a thick sheet of loess. Sandstone (sometimes suitable for grindstones) and limestone are quarried, and a few beds of gypsum and peat-bog are known within the government. With the exception of some sandy tracts, the soil is on the whole very fertile. Poltava is drained by the Dnieper, which flows along its border, navigable throughout, and by its tributaries the Sula, Psiol, Vorskla, Orel, Trubezh, and several others, none of them navigable, although their courses vary from 150 to 270 m. each in length. Even those which used to be navigated within the historical period, such as the Trubezh and Supoi, are now drying up, while the others are being partially transformed into marshes. Deep sand-beds intersected by numberless ravines and old arms of the river stretch along the left bank of the Dnieper, where accordingly the settlements are few. Only 5% of the total area is under forest; timber, wooden wares, and pitch are imported.

The estimated population in 1906 was 3,312,400. The great majority are Little Russians. Agriculture is the principal pursuit, 60% of the total area being arable land. The crops chiefly grown are wheat, rye and oats; the sunflower is largely cultivated, especially for oil, and the growing of tobacco, always important, has made a great advance. Kitchen gardening, the cultivation of the plum, and the preparation of preserved fruits are important branches of industry. At Lubny, where an apothecaries' garden is maintained by the Crown, the collection and cultivation of medicinal plants are a speciality. The main source of wealth in Poltava always has been, and still is, its live-stock breeding—horses, cattle, sheep, pigs. Some of the wealthier landowners and many peasants rear finer breeds of horses. The land is chiefly owned by the peasants, who possess 52% of the cultivable area; 42% belongs to private persons, and the remainder to the Crown, the clergy, and the municipalities.

Among the manufactures distilleries hold the leading place, after which come flour-mills, tobacco factories, machine-making, tanneries, saw-mills, sugar-works and woollen manufactures. In the villages and towns several domestic trades are carried on, such as the preparation of sheepskins, plain woollen cloth, leather, boots and pottery. The fair of Poltava is of great importance for the whole woollen trade of Russia, and leather, cattle, horses, coarse woollen cloth, skins, and various domestic wares are exchanged for manufactures imported from Great Russia. The value of merchandise brought to the fair averages over £2,500,000. Several other fairs, the aggregate returns for which reach more than one-half of the above, are held at Romny (tobacco), Kremenchug (timber, corn, tallow and salt), and Kobelyaki (sheepskins). Corn is exported to a considerable extent to the west and to Odessa, as also saltpetre, spirits, wool, tallow, skins and woollen cloth. The Dnieper is the principal artery for the exports and for the import—timber. The chief river-ports are Kremenchug and Poltava. Steamers ply between Kiev and Ekaterinoslav; but the navigation is hampered by want of water and becomes active only in the south. Traffic mostly follows the railway. Poltava is divided into fifteen districts, of which the chief towns are Poltava, Gadyach, Khorol, Kobelyaki, Konstantinograd, Kremenchug, Lohvitsa, Lubny, Mirgorod, Pereyaslavl, Piryatin, Priluki, Romny, Zenkov and Zolotonosha.

History.—At the dawn of Russian history the region now occupied by Poltava was inhabited by the Slav tribe of the Syeveryanes. As early as 988 the Russians erected several towns on the Sula and the Trubezh for their protection against the Turkish Petchenegs and Polovtsi, who held the south-eastern steppes. Population extended, and the towns of Pereyaslavl, Lubny, Priluki, Piryatin, Romny, begin to be mentioned in the 11th and 12th centuries. The Mongol invasion of 1230-42 destroyed most of them, and for two centuries afterwards they disappear from Russian annals. About 1331 Gedimin, prince of Lithuania, annexed the so-called "Syeversk towns" and on the recognition of the union of Lithuania with Poland they were included in the united kingdom along with the remainder of Little Russia. In 1476 a separate principality of Kiev under Polish rule and Polish institutions was formed out of Little Russia, and remained so until the rising of the Cossack chief Bogdan Chmielnicki in 1654. By the Andrussowo Treaty, the left bank of the Dnieper being ceded to Russia, Poltava became part of the dominions of the Zaporogian Cossacks, and was divided into "regiments," six of which (Poltava, Pereyaslavl, Priluki, Gadyach, Lubny and Mirgorod) lay within the limits of the present government. They lost their independence in 1764. (P. A. K.; J. T. BE.)

POLTAVA, a town of Russia, capital of the government of the same name, on the right bank of the Vorskla, 88 m. by rail W.S.W. of Kharkov. Pop. 53,060. The town is built on a plateau which descends by steep slopes on nearly every side. Several suburbs, inhabited by Cossacks, whose houses are buried amid gardens, and a German colony, surround the town. The oldest buildings are a monastery, erected in 1650, and a wooden

church visited by Peter the Great after the battle of Poltava. There are a military school for cadets, a theological seminary and two girls' colleges; also flour-mills, tobacco works and a tannery.

Poltava is mentioned in Russian annals in 1174, under the name of Ltava, but does not again appear in history until 1430, when, together with Glinsk, it was given by Gedimin, prince of Lithuania, to the Tatar prince Leksada. Under the Cossack chief, Bogdan Chmielnicki, it was the chief town of the Poltava "regiment." Peter the Great of Russia defeated Charles XII. of Sweden in the immediate neighbourhood on the 27th of June 1709, and the victory is commemorated by a column over 50 ft. in height.

POLTERGEIST (Ger. for "racketing spirit"), the term applied to certain phenomena of an unexplained nature, such as movements of objects without any traceable cause, and noises equally untraced to their source; but in some cases exhibiting intelligence, as when raps answer a question by a code. In the word *Poltergeist*, the phenomena are attributed to the action of a *Geist*, or spirit: of old the popular explanation of all residuary phenomena. The hypothesis, in consequence of the diffusion of education, has been superseded by that of "electricity"; while sceptics in all ages and countries have accounted for all the phenomena by the theory of imposture. The last is at least a *vera causa*: imposture has often been detected; but it is not so certain that this theory accounts for all the circumstances. To the student of human nature the most interesting point in the character of poltergeist phenomena is their appearance in the earliest known stages of culture, their wide diffusion, and their astonishing uniformity. Almost all the beliefs usually styled "superstitious" are of early occurrence and of wide diffusion: the lowest savages believe in ghosts of the dead and in wraiths of the living. Such beliefs when found thriving in our own civilization might be explained as mere survivals from savagery, memories of all

"The superstitions idle-headed old
Received and did deliver to our age."

But we have not to deal only with a belief that certain apparently impossible things may occur and have occurred in the past. We are met by the evidence of sane and credible witnesses, often highly educated, who maintain that they themselves have heard and beheld the unexplained sounds and sights. It appears, therefore, that in considering the phenomena of the poltergeist we are engaged with facts of one sort or another; facts produced either by skilled imposture, or resting on hallucinations of the witnesses; or on a mixture of fraud and of hallucination caused by "suggestion." There remains the chance that some agency of an unexplored nature is, at least in certain cases, actually at work.

A volume would be needed if we were to attempt to chronicle the phenomena of the poltergeist as believed in by savages and in ancient and medieval times. But among savages they are usually associated with the dead, or with the medicine-men of the tribes. These personages are professional "mediums," and like the mediums of Europe and America, may be said to have domesticated the poltergeist. At their séances, savage or civilized, the phenomena are reported to occur—such as rappings and other noises, loud or low, and "movements of objects without physical contact." (See, for a brief account, A. Lang, *Cock Lane and Common Sense*, "Savage Spiritualism"; and see the Jesuit *Lettres édifiantes*, North America, 1620-1770, and Kohl's *Kitchi Gami*.) But "induced phenomena," where professional mediums and professional medical men are the agents, need not here be considered. The evidence, unless in the case of Sir William Crookes's experiments with Daniel Dunglas Home, is generally worthless, and the laborious investigations of the Society for Psychical Research resulted only in the detection of fraud as far as "physical" manifestations by paid mediums were concerned.

The spontaneous poltergeist, where, at least, no professional is present, and no séance is being held, is much more curious and

interesting than the simple tricks played in the dark by impudent charlatans. The phenomena are identical, as reported, literally "from China to Peru." The Cieza de Leon (1549) tells us that the cacique of Pirza, in Popyan, during his conversion to Christianity, was troubled by stones falling mysteriously through the air (the mysterious point was the question of whence they came, and what force urged them), while Christians saw at his table a glass of liquor raised in the air, by no visible hand, put down empty, and replenished! Mr Dennys (*Folk Lore of China*, 1876, p. 79) speaks of a Chinese householder who was driven to take refuge in a temple by the usual phenomena—throwing about of crockery and sounds of heavy footfalls—after the decease of an aggrieved monkey. This is only one of several Chinese cases of poltergeist; and the phenomena are described in Jesuit narratives of the 18th century, from Cochin China. In these papers no explanation is suggested. There is a famous example in a nunnery, recorded (1528) by a notable witness, Adrien de Montalembert, almoner to Francis I. The agent was supposed to be the spirit of a sister recently deceased.

Among multitudes of old cases, that of the "Drummer of Tedworth" (1662-1663; see Glanvil, *Sadducismus triumphatus*, 1666); that at Rerrick, recorded by the Rev. Mr Telfer in 1695; that of the Wesley household (1716-1717) chronicled in contemporary letters and diaries of the Wesley family (*Southey's Life of John Wesley*); that of Cideville (1851), from the records of the court which tried the law-suit arising out of the affair (*Proc. Soc. Psychological Research*, xviii. 454-463); and the Alresford case, attested by the great admiral, Lord St Vincent, are among the most remarkable. At Tedworth we have the evidence of Glanvil himself, though it does not amount to much; at Rerrick, Telfer was a good chronicler and gives most respectable signed vouchers for all the marvels: Samuel Wesley and his wife were people of sense, they were neither alarmed nor superstitious, merely puzzled; while the court which tried the Cideville case, only decided that "the cause of the events remains unknown." At Alresford, in Hampshire, the phenomena attested by Lord St Vincent and his sister Mrs Ricketts, who occupied the house, were peculiarly strange and emphatic: the house was therefore pulled down. At Willington Mill, near Morpeth (1831-1847), the phenomena are attested by the journal of Mr Procter, the occupant, a Quaker, a "tee-totaler," and a man of great resolution. He and his family endured unspeakable things for sixteen years, and could find no explanation of the sights and sounds, among which were phantasms of animals, as at Epworth, in the Wesley case.

Of all these cases that of the Wesleys has attracted most critical attention. It was not, in itself, an extreme instance of poltergeist: at Alresford, at the close of the 18th century, and at Willington Mill in the middle of the 19th the disturbances were much more violent and persistent than at Epworth, while our evidence is, in all three examples, derived from the contemporary narratives, letters and journals of educated persons. The Wesleys, however, were people so celebrated and so active in religion that many efforts have been made to explain their "old Jeffrey," as they called the disturbing agency. These attempts at explanation have been fruitless. The poet Coleridge, who said that he knew many cases, explained all by a theory of contagious epidemic hallucination of witnesses. Dr Salmon, of Trinity College, Dublin, set all down to imposture by Hetty Wesley, a vivacious girl (*Fortnightly Review*, 1866). The documents on which he relied, when closely studied, did not support his charges, for he made several important errors in dates, and on these his argument rested. F. Podmore, in several works (*e.g. Studies in Psychological Research*), adopted a theory of exaggerative memory in the narrators, as one element, with a dose of imposture and of hallucination begotten of excited expectation. The Wesley letters and journals, written from day to day, do not permit of exaggerative memory, and when the records of 1716-1717 are compared with the reminiscences collected from his family by John Wesley in 1726, the discrepancies are seen to be only such as occur in all human

evidence about any sort of events, remote by nine or ten years. Thus, in 1726, Mrs Wesley mentioned a visionary badger seen by her. She did not write about it to her son Samuel in 1717, but her husband and her daughter did then describe it to Samuel, as an experience of his mother at that date. The whole family, in 1717, became familiar with the phenomena, and were tired of them and of Samuel's questions. (Mr Podmore's arguments are to be found in the *Journal of the Studies of Psychological Research*, ix. 40-45. Some dates are misprinted.) The theory of hallucination cannot account for the uniformity of statements, in many countries and at many dates, to the effect that the objects mysteriously set in motion moved in soft curves and swerves, or "wobbled." Suppose that an adroit impostor is throwing them, suppose that the spectators are excited, why should their excitement everywhere produce a uniform hallucination as to the mode of motion? It is better to confess ignorance, and remain in doubt, than to invent such theories.

A modern instance may be analysed, as the evidence was given contemporaneously with the events (Podmore, *Proc. Soc. Psychological Research*, xii. 45-58: "Poltergeists"). On the 20th or 21st of February 1883 a Mrs White, in a cottage at Worksop, was "washing up the tea-things at the table," with two of her children in the room, when "the table tilted up at a considerable angle," to her amazement. On the 26th of February, Mr White being from home, Mrs White extended hospitality to a girl, Eliza Rose, "the child of an imbecile mother." Eliza is later described as "half-witted," but no proof of this is given. On the 1st of March, White being from home, at about 11.30 p.m. a number of things "which had been in the kitchen a few minutes before" came tumbling down the kitchen stairs. Only Mrs White and Eliza Rose were then in the kitchen. Later some hot coals made an invasion. On the following night, White being at home in the kitchen, with his wife and Eliza, a miscellaneous throng of objects came in, Mr White made vain research upstairs, where was his brother Tom. On his return to the kitchen "a little china woman left the mantelpiece and flew into the corner." Being replaced, it repeated its flight, and was broken. White sent his brother to fetch a doctor; there also came a policeman, named Higgs; and the doctor and policeman saw, among other things, a basin and cream jug rise up automatically, fall on the floor and break. Next morning, a clock which had been silent for eighteen months struck; a crash was heard, and the clock was found to have leapt over a bed and fallen on the floor. All day many things kept flying about and breaking themselves, and Mr White sent Miss Rose about her business. Peace ensued.

Mr Podmore, who visited the scene on the 7th and 8th of April and collected depositions, says (writing in 1883): "It may be stated generally that there was no possibility, in most cases, of the objects having been thrown by hand. . . . Moreover it is hard to conceive by what mechanical appliances, under the circumstances described, the movements could have been effected. . . . To suppose that these various objects were all moved by mechanical contrivances argues incredible stupidity, amounting almost to imbecility, on the part of all the persons present who were not in the plot," whereas Higgs, Dr Lloyd and a miner named Curass, all "certainly not wanting in intelligence," examined the objects and could find no explanation. White attested that fresh invasions of the kitchen by inanimate objects occurred as Eliza was picking up the earlier arrivals; and he saw a salt-cellar fly from the table while Eliza was in another part of the room. The amount of things broken was valued by White at £9. No one was in the room when the clock struck and fell. Higgs saw White shut the cupboard doors, they instantly burst open, and a large glass jar flew into the yard and broke. "The jar could not go in a straight line from the cupboard out of the door; but it certainly did go" (Higgs). The depositions were signed by the witnesses (April 1883).

In 1896, Mr Podmore, after thirteen years of experience in examining reports of the poltergeist, produced his explana-

tions. (1) The witnesses, though "honest and fairly intelligent," were "imperfectly educated, not skilled in accurate observation of any kind." (They described, like many others, in many lands, the "wobbling" movement of objects in flight.) (2) Mr Podmore took the evidence five weeks after date; there was time for exaggerated memories. (Mr Podmore did not consult, it seems, the contemporary evidence of Higgs in the *Retford and Gainsborough Times*, 9th of March 1883. On examination it proves to tally as precisely as possible with the testimonies which he gave to Mr Podmore, except that in March he mentioned one or two miracles which he omitted five weeks later! The evidence is published in Lang's *The Making of Religion*, 1898, p. 356.) (3) In the evidence given to Mr Podmore five weeks after date, there are discrepancies between Higgs and White as to the sequence of some events, and as to whether one Coulter was present when the clock fell: he asserts, Higgs and White deny it. (There is never evidence of several witnesses, five weeks after an event, without such discrepancies. If there were, the evidence would be suspected as "cooked." Higgs in April gave the same version as in March.) (4) As there are discrepancies, the statements that Eliza was not always present at the abnormal occurrences may be erroneous. "It is perhaps not unreasonable to conjecture that Eliza Rose herself, as the instrument of mysterious agencies, or simply as a half-witted girl gifted with abnormal cunning and love of mischief, may have been directly responsible for all that took place." (How, if, as we have seen, the theory of mechanical appliances is abandoned, "under the circumstances described"? We need to assume that all the circumstances are wrongly described. Yet events did occur, the breakages were lamentable, and we ask how could the most half-witted of girls damage so much property undetected, under the eyes of the owner, a policeman, a medical practitioner and others? How could she throw things from above into the room where she was picking up the things as they arrived? Or is that a misdescription? No evidence of Eliza's half-wittedness and abnormal cunning is adduced. If we call her "the instrument of mysterious agencies," the name of these agencies is—poltergeist! No later attempt to find and examine the abnormal girl is recorded.)

The explanations are not ideally satisfactory, but they are the result, in Mr Podmore's mind, of examination of several later cases of poltergeist.¹ In one a girl, carefully observed, was detected throwing things, and evidence that the phenomena occurred, in her absence, at another place and time, is discounted. In several other cases, exaggerations of memory, malobservation and trickery combined, are the explanations, and the conclusion is that there is "strong ground" for believing in trickery as the true explanation of all these eleven cases, including the Worksop affair. Mr Podmore asserts that, at Worksop, "the witnesses did not give their testimony until some weeks after the event." That is an erroneous statement as far as Higgs goes, the result apparently of malobservation of the local newspaper. More or less of the evidence was printed in the week when the events occurred. Something more than unconscious exaggeration, or malobservation, seems needed to explain the amazing statements made by Mr Newman, a gamekeeper of Lord Portman, on the 23rd of January 1895, at Durmeston in another case. Among other things, he said that on the 18th of December 1894, a boot flew out of a door. "I went and put my foot on the boot and said 'I defy anything to move this boot.' Just as I stepped off, it rose up behind me and knocked my hat off. There was nobody behind me." Gamekeepers are acute observers, and if the narrative be untrue, malobservation or defect of memory does not explain the fact. In this case, at Durmeston, the rector, Mr Anderson, gave an account of

¹ The present writer criticized Mr Podmore's explanation in *The Making of Religion*. Mr Podmore replied (*Proc. Soc. Psychological Research*, xiv. 133, 136), pointing out an error in the critic's presentation of his meaning. He, in turn, said that the writer "champions the supernatural interpretation," which is not exact, as the writer has no theory on the subject, though he is not satisfied that "a naughty little girl" is a uniformly successful solution of the poltergeist problem.

some of the minor phenomena. He could not explain them, and gave the best character to the Nonconformist mother of the child with whom the events were associated. No trickery was discovered.

The phenomena are frequently connected with a person, often a child, suffering from nervous malady or recent nervous shock. No such person appears in the Alresford, Willington, Epworth and Tedworth cases, and it is not stated that Eliza Rose at Worksop was subjected to a medical examination. In a curious case, given by Mrs Crewe, in *The Night Side of Nature*, the young person was the daughter of a Captain Molesworth. Her own health was bad, and she had been depressed by the death of a sister. Captain Molesworth occupied a semi-detached villa at Trinity, near Edinburgh; his landlord lived next door. The phenomena set in: the captain bored holes in the wall to discover a cause in trickery, and his landlord brought a suit against him in the sheriff's court at Edinburgh.

The papers are preserved, but the writer found that to discover them would be a herculean labour. He saw, however, a number of documents in the office of a firm of solicitors employed in the case. They proved the fact of the lawsuit but threw no other light on the matter. We often find that the phenomena occur after a nervous shock to the person who may be called the medium. The shock is frequently consequent on a threat from a supposed witch or wizard. This was the case at Cideville in 1850-1851. (See an abstract of the documents of the trial, *Proceedings S.P.R.* xviii. 454-463. The entire report was sent to the writer.) In 1901 there was a case at Great Grimsby; the usual flying of stones and other objects occurred. The woman of the house had been threatened by a witch, after that the poltergeist developed. No explanation was forthcoming. In *Proc. S.P.R.* xvii. 320 the Rev. Mr Deanley gives a curious parallel case with detection of imposture. In Miss O'Neal's *Devonshire Idylls* is an excellent account of the phenomena which occurred after a Devonshire girl of the best character, well known to Miss O'Neal, had been threatened by a witch. In the famous instance of Christian Shaw of Bargarran (1697) the child had been thrice formally cursed by a woman, who prayed to God that her soul "might be hurled through hell." Christian fell into a state which puzzled the medical faculty (especially when she floated in the air), and doubtless she herself caused, in an hysterical state, many phenomena which, however, were not precisely poltergeistish. A very marked set of phenomena, in the way of movements of objects, recently occurred in the Hudson Bay territory, after a half-breed girl had received a nervous shock from a flash of lightning that struck near her. Heavy weights automatically "tobogganed," as Red Indian spectators said, and there were the usual rappings in tent and wigwam. If we accept trickery as the sufficient explanation, the uniformity of tricks played by hysterical patients is very singular. Still more singular is a long series, continued through several years, of the same occurrences where no hysterical patient is known to exist. In a very curious example, a carpenter's shop being the scene, there was concerned nobody of an hysterical temperament, no young boy or girl, and there was no explanation (*Proc. S.P.R.* vii. 383-394). The events went on during six weeks. An excellent case of hysterical fraud by a girl in France is given by Dr Grasset, professor of clinical medicine at Montpellier (*Proc. S.P.R.* xviii. 464-480). But in this instance, though things were found in unusual places, nobody over eight years old saw them flying about; yet all concerned were deeply superstitious.

On the whole, while fraud, especially hysterical fraud, is a *vera causa* in some cases of poltergeist, it is not certain that the explanation fits all cases, and it is certain that detection of fraud has often been falsely asserted, as at Tedworth and Willington. No good chronic case, as at Alresford, Epworth, Spraiton (Bovet's *Pandæmonium*), Willington, and in other classical instances, has been for months sedulously observed by sceptics. In short-lived cases, as at Worksop, science appears on the scene long enough after date to make the theory of exaggeration of memory plausible. If we ask science to explain

how the more remarkable occurrences could be produced by a girl *ex hypothesi* half-witted, the reply is that the occurrences never occurred, they were only "described as occurring" by untrained observers with "patent double magnifying" memories; and with a capacity for being hallucinated in a uniform way all the world over. Yet great quantities of crockery and furniture were broken, before the eyes of observers, in a house near Ballarmina, in North Ireland, in January 1907. The experiment of exhibiting a girl who can break all the crockery without being detected, in the presence of a doctor and a policeman, and who can, at the same time, induce the spectators to believe that the flying objects waver, swerve and "wobble," has not been attempted.

An obvious difficulty in the search for authentic information is the circumstance that the poor and imperfectly educated are much more numerous than the well-to-do and well educated. It is therefore certain that most of the disturbances will occur in the houses of the poor and ill educated, and that their evidence will be rejected as insufficient. When an excellent case occurs in a palace, and is reported by the margravine of Bayreuth, sister of Frederick the Great, in her *Memoirs*, the objection is that her narrative was written long after the events. When we have contemporary journals and letters, or sworn evidence, as in the affairs of Sir Philip Francis, Cideville and Willington, criticism can probably find some other good reasons for setting these testimonies aside. It is certain that the royal, the rich and the well-educated observers tell, in many cases, precisely the same sort of stories about poltergeist phenomena as do the poor and the imperfectly instructed.

On the theory that there exist "mysterious agencies" which now and then produce the phenomena, we may ask what these agencies can possibly be? But no answer worthy of consideration has ever been given to this question. The usual reply is that some unknown but intelligent force is disengaged from the personality of the apparent medium. This apparent medium need not be present; he or she may be far away. The Highlanders attribute many poltergeist phenomena, inexplicable noises, sounds of viewless feet that pass, and so forth, to *tàradh*, an influence exerted unconsciously by unduly strong wishes on the part of a person at a distance. The phrase *salbh air fàrsaing* ("going uncontrolled") is also used (Campbell, *Witchcraft and Second Sight in the Scottish Highlands*, 1902, pp. 144-147). The present writer is well acquainted with cases attributed to *tàradh*, in a house where he has often been a guest. They excite no alarm, their cause being well understood. We may call this kind of thing *telethoryby*, a racket produced from a distance. A very marked case in Illinois would have been attributed in the Highlands to the *tàradh* of the late owner of the house, a dipsomaniac in another state. On his death the disturbances ceased (first-hand evidence from the disturbed lady of the house, May 1907). It may be worth while to note that the phenomena are often regarded as death-warnings by popular belief. The early incidents at the Wesleys' house were thought to indicate the death of a kinsman; or to announce the approaching decease of Mr Wesley *père*, who at first saw and heard nothing unusual. At Worksop the doctor was called in, because the phenomena were guessed to be "warnings" of the death of a sick child of the house. The writer has first-hand evidence from a lady and her son (afterwards a priest) of very singular movements of untouched objects in their presence, which did coincide with the death of a relation at a distance.

BIBLIOGRAPHY.—The literature of the subject is profuse, but scattered. For modern instances the *Proceedings of the Society for Psychical Research* may be consulted, especially an essay by F. W. H. Myers, vii. 146-198, also iv. 29-38; with the essay by Podmore, already quoted. Books like Dale Owen's *Foolfalls on the Boundary of Another World*, and Fresnoy's *Recueil des dissertations sur les apparitions*, are stronger in the quantity of anecdotes than in the quality of evidence. A. Lang's *Book of Dreams and Ghosts*, contains outlandish and Celtic examples, and Telfair's (Telfer's) *A True Relation of an Apparition* (1694-1696) shows unusual regard for securing signed evidence. Kiesewetter's *Geschichte des neueren Occultismus* and Graham Dalryell's *Darker Superstitions of Scotland*, with any collections of trials for witchcraft.

may be consulted, and Bovey's *Pandaemonium* (1684) is very rich in cases. The literature of the famous drummer of Tedworth (March 1662–April 1663) begins with an abstract of the sworn deposition of Mr Mompesson, whose house was the scene of the disturbances. The abstract is in the *Mercurius publicus* of April 1663, the evidence was given in a court of justice on the 15th of April. There is also a ballad, a rhymed news-sheet of 1662 (Anthony Wood's Collection 401 (193), Bodleian Library). Pepys mentions "books" about the affair in his *Diary* for June 1663. Glanvil's first known version is in his *Sadducismus triumphatus* of 1666. The sworn evidence of Mompesson proves at least that he was disturbed in an intolerable manner, certainly beyond any means at the disposal of his two daughters, aged nine and eleven or thereabouts. The agent may have been the *tàradh* of the drummer whom Mompesson offended. Glanvil in 1666 confused the dates, and, save for his own experiences, merely repeats the statements current in 1662–1663. The ballad and Mompesson's deposition are given in *Proc. S.P.R.* xvii. 304–336, in a discussion between the writer and Mr Podmore. The dated and contemporary narrative of Procter in the Willington Mill case (1835–1847), is printed in the *Journ. S.P.R.* (Dec. 1892), with some contemporary letters on the subject. Mr Procter endured the disturbances for sixteen years before he retreated from the place. There was no naughty little girl in the affair; no nervous or hysterical patient. The Celtic hypothesis of *tàradh*, exercised by "the spirit of the living," includes visual apparitions, and many a so-called "ghost" of the dead may be merely the *tàradh* of a living person. (A. L.)

POLTROON, a coward, a worthless rogue without courage or spirit. The word comes through Fr. *poltron* from Ital. *poltrone*, an idle fellow, one who lolls in a bed or couch (Milanese *potter*, Venetian *poltrona*, adapted from Ger. *Polster*, a pillow; cf. English "bolster"). The old guess that it was from Lat. *pollice truncus*, maimed in the thumb, and was first applied to those who avoided military service by self-mutilation, gave rise probably to the French application of *poltron* to a falcon whose talons were cut to prevent its attacking game.

POLTROT, JEAN DE (c. 1537–1565), sieur de Méré or Mérey, a nobleman of Angoumois, who murdered Francis, duke of Guise. He had lived some time in Spain, and his knowledge of Spanish, together with his swarthy complexion, which earned him the nickname of the "Espagnolet," procured him employment as a spy in the wars against Spain. Becoming a fanatical Huguenot, he determined to kill the duke of Guise, and gained admission as a deserter to the camp of the Catholics who were besieging Orleans. In the evening of the 18th of February 1563 he hid by the side of a road along which he knew the duke would pass, fired a pistol at him, and fled. But he was captured the next day, and was tried, tortured several times, and sentenced to be drawn and quartered. On the 18th of March 1563 he underwent a frightful punishment. The horses not being able to drag off his limbs, he was hacked to pieces with cutlasses. He had made several contradictory declarations regarding the complicity of Coligny. The admiral protested emphatically against the accusation, which appears to have had no foundation.

See *Mémoires du prince de Condé* (London, 1743); T. A. D'Aubigné, *Histoire universelle* (ed. by de Ruble, *Soc. de l'histoire de France*, 1886); A. de Ruble, *L'Assassinat du duc François de Lorraine* (Paris, 1897).

POLYAENUS, a Macedonian, who lived at Rome as a rhetorician and pleader in the 2nd century A.D. When the Parthian War (162–5) broke out, Polyænus, too old to share in the campaign, dedicated to the emperors Marcus Aurelius and Lucius Verus a work, still extant, called *Strategica* or *Strategemata*, a historical collection of stratagems and maxims of strategy written in Greek and strung together in the form of anecdotes. It is not strictly confined to warlike stratagems, but includes also examples of wisdom, courage and cunning drawn from civil and political life. The work is uncritically written, but is nevertheless important on account of the extracts it has preserved from histories now lost. It is divided into eight books (parts of the sixth and seventh are lost), and originally contained nine hundred anecdotes, of which eight hundred and thirty-three are extant. Polyænus intended to write a history of the Parthian War, but there is no evidence that he did so. His works on Macedonia, on Thebes, and on tactics (perhaps identical with the *Strategica*) are lost.

His *Strategica* seems to have been highly esteemed by the Roman emperors, and to have been handed down by them as a sort of

heirloom. From Rome it passed to Constantinople; at the end of the 9th century it was diligently studied by Leo VI., who himself wrote a work on tactics; and in the middle of the 10th century Constantine Porphyrogenitus mentioned it as one of the most valuable books in the imperial library. It was used by Stobæus, Suidas, and the anonymous author of the work *Περὶ ἀριστων* (see PALAEPHATUS). It is arranged as follows: bks. i., ii., iii., stratagems occurring in Greek history; bk. iv., stratagems of the Macedonian kings and successors of Alexander the Great; bk. v., stratagems occurring in the history of Sicily and the Greek islands and colonies; bk. vi., stratagems of a whole people (Carthaginians, Lacedæmonians, Argives), together with some individuals (Philopœmen, Pyrrhus, Hannibal); bk. vii., stratagems of the barbarians (Medes, Persians, Egyptians, Thracians, Scythians, Celts); bk. viii., stratagems of Romans and women. This distribution is not, however, observed very strictly. Of the negligence or haste with which the work was written there are many instances: e.g. he confounds Dionysius the elder and Dionysius the younger, Mithradates satrap of Artaxerxes and Mithradates the Great, Scipio the elder and Scipio the younger, Perseus, king of Macedonia and Perseus the companion of Alexander; he mixes up the stratagems of Caesar and Pompey; he brings into immediate connexion events which were totally distinct; he narrates some events twice over, with variations according to the different authors from whom he draws. Though he usually abridges, he occasionally amplifies arbitrarily the narratives of his authorities. He never mentions his authorities, but amongst authors still extant he used Herodotus, Thucydides, Xenophon, Polybius, Diodorus, Plutarch, Frontinus and Suetonius; amongst authors of whom only fragments now remain he drew upon Ctesias, Ephorus, Timæus, Phylarchus and Nicolaus Damascenus. His style is clear, but monotonous and inelegant. In the forms of his words he generally follows Attic usage.

The best edition of the text is Wölfflin and Melber (Teubner Series, 1887, with bibliography and editio princeps of the *Strategemata* of the emperor Leo); annotated editions by Isaac Casaubon (1589) and A. Coraës (1809); I. Melber, *Ueber die Quellen und Werth der Strategemensammlung Polyæni* (1885); Knott, *De fide et fontibus Polyæni* (1883), who largely reduces the number of the authorities consulted by Polyænus. Eng. trans. by R. Shepherd (1793).

POLYANDRY (Gr. *πολύς*, many, and *ἀνὴρ*, man), the system of marriage between one woman and several men, who are her husbands exclusively (see FAMILY). The custom locally legalizing the marriage of one woman to more than one husband at a time has been variously accounted for as the result of poverty and of life in unfertile lands, where it was essential to check population as the consequence of female infanticide, or, in the opinion of J. F. McLennan and L. H. Morgan, as a natural phase through which human progress has necessarily passed. Polyandry is to be carefully differentiated from communal marriage, where the woman is the property of any and every member of the tribe. Two distinct kinds of polyandry are practised: one, often called Nair, in which, as among the Nairs of India, the husbands are not related to each other; and the second, the Tibetan or fraternal polyandry, in which the woman is married to all the brothers of one family. Polyandry is practised by the tribes of Tibet, Kashmir and the Himalayan regions, by the Todas, Koorgs, Nairs and other peoples of India, in Ceylon, New Zealand, by some of the Australian aborigines, in parts of Africa, in the Aleutian archipelago, among the Koryaks and on the Orinoco.

See McLennan's *Primitive Marriage* (London, 1885); *Studies in Ancient History* (London, 1886); "The Levirate and Polyandry," in *The Fortnightly Review*, new series, vol. xxi. (London, 1877); L. H. Morgan, *System of Consanguinity and Affinity of the Human Family* (Washington, 1869); Lord Avebury, *Origin of Civilization*; E. Westermarck, *History of Human Marriage*.

POLYANTHUS, one of the oldest of the florists' flowers, is probably derived from *P. variabilis*, itself a cross between the common primrose and the cowslip; it differs from the primrose in having the umbels of flowers carried up on a stalk. The florists' polyanthus has a golden margin, and is known as the gold-laced polyanthus, the properties being very distinctly laid down and rigidly adhered to. The chief of these are a clear, unshaded, blackish or reddish ground colour, an even margin or lacing of yellow extending round each segment and cutting through its centre down to the ground colour, and a yellow band surrounding the tube of exactly the same hue as the yellow of the lacing. The plants are quite hardy, and grow best in strong, loamy soil tolerably well enriched with well-decayed dung and leaf-mould;

they should be planted about the end of September or not later than October. Plants for exhibition present a much better and cleaner appearance if kept during winter in a cold well-aired frame.

For the flower borders what are called fancy polyanthus are adopted. These are best raised annually from seed, the young crop each year blooming in succession. The seed should be sown as soon as ripe, the young plants being allowed to stand through the winter in the seed bed. In April or May they are planted out in a bed of rich garden soil, and they will bloom abundantly the following spring. A few of the better "thrum-eyed" sorts (those having the anthers in the eye, and the pistil sunk in the tube) should be allowed to ripen seed; the rest may be thrown away. In some remarkable forms which have been cultivated for centuries the ordinarily green calyx has become petaloid; when this is complete it forms the hose-in-hose primrose of gardeners. There are also a few well-known double-flowered varieties.

POLYBIUS (c. 204-122 B.C.), Greek historian, was a native of Megalopolis in Arcadia, the youngest of Greek cities (Paus. viii. 9), which, however, played an honourable part in the last days of Greek freedom as a staunch member of the Achaean League (q.v.). His father, Lycortas, was the intimate friend of Philopoemen, and on the death of the latter, in 182, succeeded him as leader of the league. The date of Polybius's birth is doubtful. He tells us himself that in 181 he had not yet reached the age (? thirty years, Polyb. xxix. 9) at which an Achaean was legally capable of holding office (xxiv. 6). We learn from Cicero (*Ad Fam.* v. 12) that he outlived the Numantine War, which ended in 132, and from Lucian (*Macrob.* 22) that he died at the age of eighty-two. The majority of authorities therefore place his birth between 214 and 204 B.C. Little is known of his early life. As the son of Lycortas he was naturally brought into close contact with the leading men of the Achaean League. With Philopoemen he seems to have been on intimate terms. After Philopoemen's tragic death in Messenia (182) he was entrusted with the honourable duty of conveying home the urn in which his ashes had been deposited (Plut. *Phil.* 21). In 181, together with his father, Lycortas and the younger Aratus, he was appointed, in spite of his youth, a member of the embassy which was to visit Ptolemy Epiphanes, king of Egypt, a mission, however, which the sudden death of Ptolemy brought to a premature end (xxv. 7). The next twelve years of his life are a blank, but in 169 he reappears as a trusted adviser of the Achaeans at a difficult crisis in the history of the League. In 171 war had broken out between Rome and the Macedonian king Perseus, and the Achaean statesmen were divided as to the policy to be pursued; there were good reasons for fearing that the Roman senate would regard neutrality as indicating a secret leaning towards Macedon. Polybius therefore declared for an open alliance with Rome, and his views were adopted. It was decided to send an Achaean force to cooperate with the Roman general, and Polybius was selected to command the cavalry. The Roman consul declined the proffered assistance, but Polybius accompanied him throughout the campaign, and thus gained his first insight into the military system of Rome. In the next year (168) both Lycortas and Polybius were on the point of starting at the head of 1200 Achaeans to take service in Egypt against the Syrians, when an intimation from the Roman commander that armed interference was undesirable put a stop to the expedition (xxix. 23). The success of Rome in the war with Perseus was now assured. The final victory was rapidly followed by the arrival in Achaea of Roman commissioners charged with the duty of establishing Roman interests there. Polybius was arrested with 1000 of the principal Achaeans, but, while his companions were condemned to a tedious incarceration in the country towns of Italy, he obtained permission to reside in Rome. This privilege he owed to the influence of L. Aemilius Paullus and his two sons, Scipio and Fabius (xxxii. 9). Polybius was received into Aemilius's house, and became the instructor of his sons. Between Scipio (P. Cornelius Scipio Africanus the younger), the future conqueror of Carthage, and himself a friendship soon sprang up,

which ripened into a lifelong intimacy, and was of inestimable service to him throughout his career. It protected him from interference, opened to him the highest circles of Roman society, and enabled him to acquire a personal influence with the leading men, which stood him in good stead when he afterwards came forward to mediate between his countrymen and Rome. It placed within his reach opportunities for a close study of Rome and the Romans such as had fallen to no historian before him, and secured him the requisite leisure for using them, while Scipio's liberality more than once supplied him with the means of conducting difficult and costly historical investigations (Pliny, *N.H.* v. 9). In 151 the few surviving exiles were allowed to return to Greece. But the stay of Polybius in Achaea was brief. The estimation in which he was held at Rome is clearly shown by the anxiety of the consul Marcus (or Manlius) Manilius (149) to take him as his adviser on his expedition against Carthage. Polybius started to join him, but broke off his journey at Corcyra on learning that the Carthaginians were inclined to yield (xxxvi. 3). But when, in 147, Scipio himself took the command in Africa, Polybius hastened to join him, and was an eye-witness of the siege and destruction of Carthage. During his absence in Africa the Achaeans had made a last desperate attempt to assert their independence of Rome. He returned in 146 to find Corinth in ruins, the fairest cities of Achaea at the mercy of the Roman soldiery, and the famous Achaean League shattered to pieces (see ACHAEAN LEAGUE). All the influence he possessed was freely spent in endeavouring to shield his countrymen from the worst consequences of their rashness. The excesses of the soldiery were checked, and at his special intercession the statues of Aratus and Philopoemen were preserved (xxxix. 14). An even more difficult task was that entrusted to him by the Roman authorities themselves, of persuading the Achaeans to acquiesce in the new régime imposed upon them by their conquerors, and of setting the new machinery in working order. With this work, which he accomplished so as to earn the heartfelt gratitude of his countrymen (xxxix. 16), his public career seems to have closed. The rest of his life was, so far as we know, devoted to the great history which is the lasting monument of his fame. He died, at the age of eighty-two, of a fall from his horse (Lucian, *Macrob.* 22). The base of a statue erected to him by Elis was found at Olympia in 1877. It bears the inscription ἡ πόλις ἡ Ἰλλεῖων Πολύβιον Λυκόρτα Μεγαλοπολίτην.

Of the forty books which made up the history of Polybius, the first five alone have come down to us in a complete form; of the rest we have only more or less copious fragments. But the general plan and scope of the work are explained by Polybius himself. His intention was to make plain how and why it was that "all the known regions of the civilized world had fallen under the sway of Rome" (iii. 1). This empire of Rome, unprecedented in its extent and still more so in the rapidity with which it had been acquired, was the standing wonder of the age, and "who," he exclaims (i. 1), "is so poor-spirited or indolent as not to wish to know by what means, and thanks to what sort of constitution, the Romans subdued the world in something less than fifty-three years?" These fifty-three years are those between 220 (the point at which the work of Aratus ended) and 168 B.C., and extend therefore from the outbreak of the Hannibalic War to the defeat of Perseus at Pydna. To this period then the main portion of his history is devoted from the third to the thirtieth book inclusive. But for clearness' sake he prefixes in bks. i. and ii. such a preliminary sketch of the earlier history of Rome, of the First Punic War, and of the contemporary events in Greece and Asia, as will enable his readers more fully to understand what follows. This seems to have been his original plan, but at the opening of bk. iii., written apparently after 146, he explains that he thought it desirable to add some account of the manner in which the Romans exercised the power they had won, of their temperament and policy and of the final catastrophe which destroyed Carthage and for ever broke up the Achaean League (iii. 4, 5). To this appendix, giving the history from 168-146, the last ten books are devoted.

Whatever fault may be found with Polybius, there can be no question that he had formed a high conception of the task before him. He lays repeated stress on two qualities as distinguishing his history from the ordinary run of historical compositions. The first of these, its synoptic character, was partly necessitated by the nature of the period. The various states fringing the basin of the Mediterranean had become so inextricably interwoven that it was no longer possible to deal with them in isolation. Polybius therefore claims for his history that it will take a comprehensive

view of the whole course of events in the civilized world, within the limits of the period (i. 4). He thus aims at placing before his readers at each stage a complete survey of the field of action from Spain to Syria and Egypt. This synoptic method proceeds from a true appreciation of what is now called the unity of history, and to Polybius must be given the credit of having first firmly grasped and clearly enforced a lesson which the events of his own time were especially well calculated to teach. It is the great merit of his work that it gives such a picture of the 2nd and 3rd centuries B.C. as no series of special narratives could have supplied.

The second quality upon which Polybius insists as distinguishing his history from all others is its "pragmatic" character. It deals, that is, with events and with their causes, and aims at an accurate record and explanation of ascertained facts. This "pragmatic method" (ix. 2) makes history intelligible by explaining the how and the why; and, secondly, it is only when so written that history can perform its true function of instructing and guiding those who study it. For the great use of history, according to Polybius, is to contribute to the right conduct of human life (i. 35). But this it can do only if the historian bears in mind the true nature of his task. He must remember that the historian should not write as the dramatist does to charm or excite his audience for the moment (ii. 56). He will aim simply at exhibiting events in their true light, setting forth "the why and the how" in each case, not confusing causes and occasions, or dragging in old wives' fables, prodigies and marvels (ii. 16, iii. 48). He will omit nothing which can help to explain the events he is dealing with: the genius and temperament of particular peoples, their political and military systems, the characters of the leading men, the geographical features of the country, must all be taken into account. To this conception of history Polybius is on the whole consistently faithful. It is true that his anxiety to instruct leads often to a rather wearisome iteration of his favourite maxims, and that his digressions, such as that on the military art, are occasionally provokingly long and didactic. But his comments and reflections are for the most part sound and instructive (e.g. those on the lessons to be learnt from the revolt of the mercenaries in Africa, i. 65; from the Celtic raids in Italy, ii. 35; and on the Roman character), while among his digressions are included such invaluable chapters as those on the Roman constitution (bk. vi.), the graphic description of Cisalpine Gaul (bk. ii.) and the account of the rise and constitution of the Achaean League (ii. 38 seq.). To his anxiety again to trace back events to their first causes we owe, not only the careful inquiry (bk. iii.) into the origin of the Second Punic War, but the sketch of early Roman history in bk. i., and of the early treaties between Rome and Carthage in iii. 22 seq. Among the many defects which he censures in previous historians, not the least serious in his eyes are their inattention to the political and geographical surroundings of the history (ii. 16, iii. 36), and their neglect duly to set forth the causes of events (iii. 6).

Polybius is equally explicit as regards the personal qualifications necessary for a good historian, and in this respect too his practice is in close agreement with his theory. Without a personal knowledge of affairs a writer will inevitably distort the true relations and importance of events (xii. 28). Such experience would have saved accomplished and fluent Greek writers like Timaeus from many of their blunders (xii. 25a), but the shortcomings of Roman soldiers and senators like Q. Fabius Pictor show that it is not enough by itself. Equally indispensable is careful painstaking research. All available evidence must be collected, thoroughly sifted, soberly weighed, and, lastly, the historian must be animated by a sincere love of truth and a calm impartiality.

It is important to consider how far Polybius himself comes up to his standard. In his personal acquaintance with affairs, in the variety of his experience, and in his opportunities for forming a correct judgment on events he is without a rival among ancient historians. A great part of the period of which he treats fell within his own lifetime (iv. 2). He may just have remembered the battle of Cynoscephalae (197), and, as we have seen, he was actively engaged in the military and political affairs of the Achaean League. During his exile in Rome he was able to study the Roman constitution, and the peculiarities of the Roman temperament; he made the acquaintance of Roman senators, and became the intimate friend of the greatest Roman of the day. Lastly, he was able to survey with his own eyes the field on which the great struggle between Rome and Hannibal was fought out. He left Rome only to witness the crowning triumph of Roman arms in Africa, and to gain a practical acquaintance with Roman methods of government by assisting in the settlement of Achaia. When, in 146, his public life closed, he completed his preparation of himself for his great work by laborious investigations of archives and monuments, and by a careful personal examination of historical sites and scenes. To all this we must add that he was deeply read in the learning of his day, above all in the writings of earlier historians.

Of Polybius's anxiety to get at the truth no better proof can be given than his conscientious investigation of original documents and monuments, and his careful study of geography and topography—both of them points in which his predecessors, as well as his successor Livy, conspicuously failed. Polybius is careful constantly to remind us that he writes for those who are φιλομαθείς

lovers of knowledge, with whom truth is the first consideration. He closely studied the bronze tablets in Rome on which were inscribed the early treaties concluded between Romans and Carthaginians. He quotes the actual language of the treaty which ended the First Punic War (i. 62), and of that between Hannibal and Philip of Macedon (vii. 9). In xvi. 15 he refers to a document which he had personally inspected in the archives at Rhodes, and in iii. 33 to the monument on the Lacinian promontory, recording the number of Hannibal's forces. According to Dionysius, i. 17, he got his date for the foundation of Rome from a tablet in the pontifical archives. As instances of his careful attention to geography and topography we have not only the fact of his widely extended travels, from the African coast and the Pillars of Hercules in the west, to the Euxine and the coasts of Asia Minor in the east, but also the geographical and topographical studies scattered throughout his history.

Next to the duty of original research, Polybius ranks that of impartiality. Some amount of bias in favour of one's own country may, he thinks, be pardoned as natural (xvi. 14); but it is unpardonable, he says, for the historian to set anything whatever above the truth. And on the whole, Polybius must be allowed here again to have practised what he preached. It is true that his affection for and pride in Arcadia appear in more than one passage (iv. 20, 21), as also does his dislike of the Aetolians (ii. 45, iv. 3, 16). His treatment of Aratus and Philopoemen, the heroes of the Achaean League, and of Cleomenes of Sparta, its most constant enemy, is perhaps open to severer criticism. Certainly Cleomenes does not receive full justice at his hands. Similarly his views of Rome and the Romans may have been influenced by his firm belief in the necessity of accepting the Roman supremacy as inevitable, and by his intimacy with Scipio. He had a deep admiration for the great republic, for her well-balanced constitution, for her military system, and for the character of her citizens. But just as his patriotism does not blind him to the faults and follies of his countrymen (xxxviii. 4, 5, 6), so he does not scruple to criticize Rome. He notices the incipient degeneracy of Rome after 146 (xviii. 35). He endeavours to hold the balance evenly between Rome and Carthage; he strongly condemns the Roman occupation of Sardinia as a breach of faith (iii. 28, 31); and he does full justice to Hannibal. Moreover, there can be no doubt that he sketched the Roman character in a masterly fashion.

His interest in the study of character and his skill in its delineation are everywhere noticeable. He believes, indeed, in an overruling fortune, which guides the course of events. It is fortune which has fashioned anew the face of the world in his own time (iv. 2), which has brought the whole civilized world into subjection to Rome (i. 4); and the Roman Empire itself is the most marvellous of her works (viii. 4). But under fortune not only political and geographical conditions but the characters and temperaments of nations and individuals play their part. The Romans had been fitted by their previous struggles for the conquest of the world (i. 63); they were chosen to punish the treachery of Philip of Macedon (xv. 4); and the greatest of them, Scipio himself, Polybius regards as the especial favourite of fortune (xxxii. 15; x. 5).

In respect of form, Polybius is far the inferior of Livy, partly owing to his very virtues. His laudable desire to present a picture of the whole political situation at each important moment is fatal to the continuity of his narrative. Thus the thrilling story of the Second Punic War is broken in upon by digressions on the contemporary affairs in Greece and Asia. More serious, however, than this excessive love of synchronism is his almost pedantic anxiety to edify. For grace and elegance of composition, and for the artistic presentation of events, he has a hardly concealed contempt. Hence a general and almost studied carelessness of effect, which mars his whole work. On the other hand he is never weary of preaching. His favourite theories of the nature and aims of history, of the distinction between the universal and special histories, of the duties of an historian, sound as most of them are in themselves, are enforced with wearisome iteration; more than once the effect of a graphic picture is spoilt by obtrusive moralizing. Nor, lastly, is Polybius's style itself such as to compensate for these defects. It is, indeed, often impressive from the evident earnestness of the writer, and from his sense of the gravity of his subject, and is unspoilt by rhetoric or conceit. It has about it the ring of reality; the language is sometimes pithy and vigorous; and now and then we meet with apt metaphors, such as those borrowed from boxing (i. 57), from cock-fighting (i. 58), from draughts (i. 84). But, in spite of these redeeming features, the prevailing baldness of Polybius's style excludes him from the first rank among classical writers; and it is impossible to quarrel with the verdict pronounced by Dionysius of Halicarnassus, who places him among those authors of later times who neglected the graces of style, and who paid for their neglect by leaving behind them works "which no one was patient enough to read through to the end."

It is to the value and variety of his matter, to his critical insight, breadth of view and wide research, and not least to the surpassing importance and interest of the period with which he deals, that Polybius owes his place among the writers of history. What is known as to the fortunes of his histories, and the reputation they enjoyed, fully bears out this conclusion. The silence respecting

him maintained by Quintilian and by Lucian may reasonably be taken to imply their agreement with Dionysius as to his merits as a master of style. On the other hand, Cicero (*De off.* iii. 32) describes him as "bonus auctor in primis"; in the *De republica* (ii. 14) he praises highly his accuracy in matters of chronology; and Cicero's younger contemporary, Marcus Brutus, was a devoted student of Polybius, and was engaged on the eve of the battle of Pharsalia in compiling an epitome of his histories (Suidas, s.v.; Plutarch, *Brut.* 4). Livy, however, notwithstanding the extent to which he used his writings (see LIVY), speaks of him in such qualified terms as to suggest the idea that his strong artistic sensibilities had been wounded by Polybius's literary defects. He has nothing better to say of him than that he is "by no means contemptible" (xxx. 45), and "not an untrustworthy author" (xxviii. 10). Posidonius and Strabo, both of them Stoics like Polybius himself, are said to have written continuations of his history (Suidas, s.v.; Strabo p. 515). Arrian in the early part of the 2nd and Aelian in the 3rd century both speak of him with respect, though with reference mainly to his excellence as an authority on the art of war. In addition to his *Histories* Polybius was the author of the following smaller works: a life of Philopoemen (Polyb. x. 24), a history of the Numantine War (Cic. *Ad Fam.* v. 12), a treatise on tactics (Polyb. ix. 20; Arrian, *Tactica*; Aelian, *Tact.* i.). The geographical treatise, referred to by Geminus, is possibly identical with the thirty-fourth book of the *Histories* (Schweighäuser, *Praef.* p. 184).

AUTHORITIES.—The complete books (i.-v.) of the *Histories* were first printed in a Latin translation by Nicholas Perotti in 1473. The date of the first Greek edition, that by Obsopaeus, is 1530. For a full account of these and of later editions, as well as of the extant MSS., see Schweighäuser's Preface to his edition of Polybius. Our knowledge of the contents of the fragmentary books is derived partly from quotations in ancient writers, but mainly from two collections of excerpts; one, probably the work of a late Byzantine compiler, was first printed at Basel in 1549 and contains extracts from books vi.-xviii. (*περί προβέλων, περί αφερίσ και κακίας*); the other consists of two fragments from the "select passages" from Greek historians compiled by the directions of Constantine Porphyrogenitus in the 10th century. To these must be added the Vatican excerpts edited by Angelo Mai in the present century.

The following are the more important modern editions of Polybius: Ernesti (3 vols., 1763-1764); Schweighäuser (8 vols., 1793, and Oxford, 1823); Bekker (2 vols., 1844); L. Dindorf (4 vols., 1866-1868, 2nd ed., T. Büttner-Wobst, 5 vols., Leipzig, 1882-1904); Hultsch (4 vols., 1867-1871); J. L. Strachan-Davidson, *Selections from Polybius* (Oxford, 1888). For the literature of the subject, see Engelmann, *Biblioth. script. class.: Script. graeci*, pp. 646-650 (8th ed. Leipzig, 1880). See also W. W. Capes, *The History of the Achaean League* (London, 1888); F. Susemihl, *Gesch. d. griech. Litteratur in d. Alexandrinerzeit*, ii. 80-128 (Leipzig, 1891-1892); O. Cuntz, *Polybios und sein Werk* (Leipzig, 1902); R. v. Scala, *Die Studien des Polybios* (Stuttgart, 1890); J. B. Bury, *Ancient Greek Historians* (1909), "a whole-hearted appreciation of Polybius"; J. L. Strachan-Davidson, in *Hellenica*, pp. 353-387 (London, 1898), and in Appendix II. to *Selections from Polybius* pp. 642-668 (Oxford, 1888). (H. F. P.; X.)

POLYCARP (c. 69-c. 155), bishop of Smyrna and one of the Apostolic Fathers, derives much of his importance from the fact that he links together the apostolic age and that of nascent Catholicism. The sources from which we derive our knowledge of the life and activity of Polycarp are: (1) a few notices in the writings of Irenaeus, (2) the Epistle of Polycarp to the Church at Philippi, (3) the Epistle of Ignatius to Polycarp, (4) the Epistle of the Church at Smyrna to the Church at Philomelium, giving an account of the martyrdom of Polycarp. Since these authorities have all been more or less called in question and some of them entirely rejected by recent criticism, it is necessary to say a few words about each.

1. *The Statements of Irenaeus* are found (a) in his *Adversus haereses*, iii. 3, 4, (b) in the letter to Victor, where Irenaeus gives an account of Polycarp's visit to Rome, (c) in the letter to Florinus—a most important document which describes the intercourse between Irenaeus and Polycarp and Polycarp's relation with St John. No objection has been made against the genuineness of the statements in the *Adversus haereses*, but the authenticity of the two letters has been stoutly contested in recent times by van Manen.¹ The main attack is directed against the Epistle to Florinus, doubtless because of its importance. "The manifest exaggerations," says van Manen, "coupled with the fact that Irenaeus never shows any signs of acquaintance with Florinus . . . enable us to perceive clearly that a writer otherwise unknown is speaking to us here." The criticism of van Manen has, however, found no supporters outside the Dutch school. The epistle is quoted by Eusebius

(v. 20), and is accepted as genuine by Harnack² and Krüger.³ The relevant statements in the letter, moreover, are supported by the references to Polycarp which we find in the body of Irenaeus's great work.

2. *The Epistle of Polycarp*.—Though Irenaeus states that Polycarp wrote many "letters to the neighbouring churches or to certain of the brethren"⁴ only one has been preserved, viz. the well-known letter to the Philippians. The epistle is largely involved in the Ignatian controversy (see IGNATIUS). The testimony which it affords to the Ignatian Epistles is so striking that those scholars who regard these letters as spurious are bound to reject the Epistle of Polycarp altogether, or at any rate to look upon it as largely interpolated. The former course has been adopted by Schwegler,⁵ Zeller,⁶ and Hilgenfeld,⁷ the latter by Ritschl⁸ and Lipsius.⁹ The rehabilitation of the Ignatian letters in modern times has, however, practically destroyed the attack on the Epistles of Polycarp. The external evidence in its favour is of considerable weight. Irenaeus (iii. 3, 4) expressly mentions and commends a "very adequate" (*καυωάρη*) letter of Polycarp to the Philippians, and we have no reason for doubting the identity of this letter mentioned by Irenaeus with our epistle. Eusebius (iii. 36) quotes extracts from the epistle, and some of the extracts contain the very passages which the critics have marked as interpolations, and Jerome (*De Vir. Ill.* xvii.) testifies that in his time the epistle was publicly read in the Asiatic churches. The internal evidence is equally strong. There is absolutely no motive for a forgery in the contents of the epistle. As Harnack says, "There is no trace of any tendency beyond the immediate purpose of maintaining the true Christian life in the church and warning it against covetousness and against an unbrotherly spirit. The occasion of the letter was a case of embezzlement, the guilty individual being a presbyter at Philippi. It shows a fine combination of mildness with severity; the language is simple but powerful, and, while there is undoubtedly a lack of original ideas, the author shows remarkable skill in weaving together pregnant sentences and impressive warnings selected from the apostolic epistles and the first Epistle of Clement. In these circumstances it would never have occurred to any one to doubt the genuineness of the epistle or to suppose that it had been interpolated, but for the fact that in several passages reference is made to Ignatius and his epistles." The date of the epistle depends upon the date of the Ignatian letters and is now generally fixed between 112 and 118. An attempt has been made in some quarters to prove that certain allusions in the epistle imply the rise of the heresy of Marcion and that it cannot therefore be placed earlier than 140. Lightfoot, however, has proved that Polycarp's statements may equally well be directed against Corinthianism or any other form of Docetism, while some of his arguments are absolutely inapplicable to Marcionism.

3. *The Epistle of Ignatius to Polycarp*.—This epistle has of course been subjected to the same criticism as has been directed against the other epistles of Ignatius (see IGNATIUS). Over and above the general criticism, which may now be said to have been completely answered by the investigations of Zahn, Lightfoot and Harnack, one or two special arguments have been brought against the Epistle to Polycarp. Ussher, for instance, while accepting the other six epistles, rejected this on the ground that Jerome says that Ignatius only sent one letter to Smyrna—a mistake due to his misinterpretation of Eusebius. Some modern scholars (among whom Harnack was formerly numbered, though he has modified his views on the point) feel a difficulty about the peremptory tone which Ignatius adopts towards Polycarp. There was some force in this argument when the Ignatian Epistles were dated about 140, as in that case Polycarp would have been an old and venerable man at the time. But now that the date is put back to about 112 the difficulty vanishes, since Polycarp was not much over forty when he received the letter. We must remember, too, that Ignatius was writing under the consciousness of impending martyrdom and evidently felt that this gave him the right to criticize the bishops and churches of Asia.

4. *The Letter of the Church at Smyrna to the Philomelians* is a most important document, because we derive from it all our information with regard to Polycarp's martyrdom. Eusebius has preserved the greater part of this epistle (iv. 15), but we possess it entire with various concluding observations in several Greek MSS., and also in a Latin translation. The epistle gives a minute description of the persecution in Smyrna, of the last days of Polycarp and of his trial and martyrdom; and as it contains many instructive details and professes to have been written not long after the events to which it refers, it has always been regarded as one of the most precious remains of the 2nd century. Certain recent critics, however, have questioned the authenticity of the narrative.

² *Geschichte der altchristlichen Litteratur*, i. 593-594.

³ *Early Christian Literature* (Eng. trans., 1897), p. 150.

⁴ Letter to Florinus ap. Euseb. v. 20.

⁵ *Nachapostolisches Zeitalter*, ii. 154.

⁶ *Apostolgeschichte*, p. 52.

⁷ *Apostolische Väter*, p. 272.

⁸ *Entstehung der altkatholischen Kirche*, p. 584.

⁹ *Ueber das Verhältniss, &c.*, p. 14.

Lipsius brings¹ the date of the epistle down to about 260, though he admits many of the statements as trustworthy. Keim, too,² endeavours to show that, although it was based on good information, it could not have been composed till the middle of the 3rd century. A similar position has also been taken up by Schürer,³ Holtzmann,⁴ Gebhardt,⁵ Réville,⁶ and van Manen.⁷ The last named regards the document "as a decorated narrative of the saint's martyrdom framed after the pattern of Jesus' martyrdom," though he thinks that it cannot be put as late as 250, but must fall within the limits of the 2nd century. It cannot be said, however, that the case against the document has been at all substantiated, and the more moderate school of modern critics (e.g. Lightfoot,⁸ Harnack,⁹ Krüger)¹⁰ is unanimous in regarding it as an authentic document, though it recognizes that here and there a few slight interpolations have been inserted.¹¹ Besides these we have no other sources for the life of Polycarp; the *Vita S. Polycarpi auctore Pionio* (published by Duchesne, Paris, 1881, and Lightfoot *Ignatius and Polycarp*, 1885, ii. 1015-1047) is worthless.

Assuming the genuineness of the documents mentioned, we now proceed to collect the scanty information which they afford with regard to Polycarp's career. Very little is known about his early life. He must have been born not later than the year 69, for on the day of his death (c. 155) he declared that he had served the Lord for eighty-six years (*Martyrium*, 9). The statement seems to imply that he was of Christian parentage; he cannot have been older than eighty-six at the time of his martyrdom, since he had paid a visit to Rome almost immediately before. Irenaeus tells us that in early life Polycarp "had been taught by apostles and lived in familiar intercourse with many that had seen Christ" (iii. 3, 4). This testimony is expanded in the remarkable words which Irenaeus addresses to Florinus: "I saw thee when I was still a boy (παῖς ἔτι ὄν) in Lower Asia in company with Polycarp . . . I can even now point out the place where the blessed Polycarp used to sit when he discoursed, and describe his goings out and his comings in, his manner of life and his personal appearance and the discourses which he delivered to the people, how he used to speak of his intercourse with John and with the rest of those who had seen the Lord, and how he would relate their words. And everything that he had heard from them about the Lord, about His miracles and about His teaching, Polycarp used to tell us as one who had received it from those who had seen the Word of Life with their own eyes, and all this in perfect harmony with the Scriptures. To these things I used to listen at the time, through the mercy of God vouchsafed to me, noting them down, not on paper but in my heart, and constantly by the grace of God I brood over my accurate recollections." These are priceless words, for they establish a chain of tradition (John-Polycarp-Irenaeus) which is without a parallel in early church history. Polycarp thus becomes the living link between the Apostolic age and the great writers who flourished at the end of the 2nd century. Recent criticism, however, has endeavoured to destroy the force of the words of Irenaeus. Harnack, for instance, attacks this link at both ends.¹² (a) The connexion of Irenaeus and Polycarp, he argues, is very weak, because Irenaeus was only a boy (παῖς) at the time, and his recollections therefore carry very little weight. The fact too that he never shows any signs of having been influenced by Polycarp and never once quotes his writings is a further proof that the relation between them was slight. (b) The connexion which Irenaeus tries to establish between Polycarp and John the apostle is probably due to a blunder. Irenaeus has confused John the apostle and John the presbyter. Polycarp was the disciple of the latter, not the former. In this second

argument Harnack has the support of a considerable number of modern scholars who deny the Ephesian residence of John the apostle. But, as Gwatkin¹³ has pointed out, Harnack's arguments are by no means decisive. (a) When Irenaeus describes himself as a boy (παῖς), he need not have meant a very young lad, under thirteen, as Harnack makes out. Lightfoot has cited many instances which prove that the word could be used of a man of thirty.¹⁴ Nor does the alternative phrase which Irenaeus uses in iii. 3, 4 (ὄν καὶ ἡμεῖς ἐωράκαμεν ἐν τῇ πρώτῃ ἡμῶν ἡλικίᾳ) militate against this interpretation, for elsewhere Irenaeus himself distinctly says "triginta annorum aetas prima indoles est juvenis" (ii. 22, 5). It is true that Harnack has adduced arguments which cannot be discussed here to prove that Irenaeus was not born till about 140;¹⁵ but against this we may quote the decision of Lipsius, who puts the date of his birth at 130,¹⁶ while Lightfoot argues for 120.¹⁷ The fact that Irenaeus never quotes Polycarp does not count for much. Polycarp wrote very little. He does not seem to have been a man of great mental capacity. "His influence was that of saintliness rather than that of intellect." (b) A discussion of Harnack's second line of argument is impossible here. His theory with regard to the confusion of names is a gratuitous assumption and cannot be proved. The tradition of St John's residence at Ephesus is too strong to be easily set aside. In spite therefore of much modern criticism there seems to be no solid reason for rejecting the statements of Irenaeus and regarding Polycarp as the link between the Apostolic age and the first of the Catholic fathers.

Though Polycarp must have been bishop of Smyrna for nearly half a century we know next to nothing about his career. We get only an occasional glimpse of his activity, and the period between 115 and 155 is practically a blank. The only points of sure information which we possess relate to (1) his relations with Ignatius, (2) his protests against heresy, (3) his visit to Rome in the time of Anicetus, (4) his martyrdom.

1. *His Relations with Ignatius.*—Ignatius, while on his way to Rome to suffer martyrdom, halted at Smyrna and received a warm welcome from the church and its bishop. Upon reaching Troas he despatched two letters, one to the church at Smyrna, another addressed personally to Polycarp. In these letters Ignatius charged Polycarp to write to all the churches between Smyrna and Syria (since his hurried departure from Troas made it impossible for him to do so in person) urging them to send letters and delegates to the church at Antioch to congratulate it upon the cessation of the persecution and to establish it in the faith. The letters of Ignatius illustrate the commanding position which Polycarp had already attained in Asia. It was in the discharge of the task which had been laid upon him by Ignatius that Polycarp was brought into correspondence with the Philippians. The Church at Philippi wrote to Polycarp asking him to forward their letters to Antioch. Polycarp replied, promising to carry out their request and enclosing a number of the letters of Ignatius which he had in his possession.

2. *Polycarp's Attack on Heresy.*—All through his life Polycarp appears to have been an uncompromising opponent of heresy. We find him in his epistle (ch. vii.) uttering a strong protest against certain false teachers (probably the followers of Cerinthus).

For every one who shall not confess that Jesus Christ is come in the flesh is antichrist; and whosoever shall not confess the testimony of the Cross is of the devil; and whosoever shall pervert the oracles of the Lord to his own lusts and say that there is neither resurrection nor judgment, that man is the first-born of Satan. Wherefore let us forsake their vain doing and their false teaching and turn unto the word which was delivered unto us from the beginning."

Polycarp lived to see the rise of the Marcionite and Valentinian sects and vigorously opposed them. Irenaeus tells us that on

¹³ *Contemp. Review*, February 1897.

¹⁴ *Ignatius and Polycarp*, i. 432, for instance, Constantine (Euseb. V.C. ii. 51) describes himself as κομιδῆ παῖς, though he must have been over thirty at the time.

¹⁵ *Chronologie*, i. 325-333.

¹⁶ See Lightfoot, *op. cit.* i. 432.

¹⁷ *Essays on Supernatural Religion*, 264, 265.

¹ *Zeitschr. f. wissenschaftl. Theol.* (1874), p. 200 seq.

² *Aus dem Urchristenthum* (1878), p. 90.

³ *Zeitschr. f. hist. Theol.* (1870), p. 203 seq.

⁴ *Zeitschr. f. wissenschaftl. Theol.* (1877).

⁵ *Zeitschr. f. hist. Theol.* (1875).

⁶ *De anno Polycarpi* (1881).

⁷ *Oud-Christ* (1861), and *Ency. Bib.* iii. 3479.

⁸ *Ignatius and Polycarp*, i. 589 seq.

⁹ *Gesch. d. altchrist. Lit.* II. i. 341.

¹⁰ *Early Christian Lit.* (Eng. trans., 1897), p. 380.

¹¹ Amongst these we ought probably to include the expression ἡ καθολικὴ ἐκκλησία (xvi. 19), καθολικός being here used in the sense of orthodox—a usage which is not found elsewhere at so early a date.

¹² *Chronologie*, i. 325-329.

one occasion Marcion endeavoured to establish relations with him and accosted him with the words, "Recognize us." But Polycarp displayed the same uncompromising attitude which his master John had shown towards Cerinthus and answered, "I recognize you as the first-born of Satan." The steady progress of the heretical movement in spite of all opposition was a cause of deep sorrow to Polycarp, so that in the last years of his life the words were constantly on his lips, "Oh good God, to what times hast thou spared me, that I must suffer such things!"

3. *Polycarp's Visit to Rome.*—It is one of the most interesting and important events in the church history of the 2nd century that Polycarp, shortly before his death, when he was considerably over eighty years old, undertook a journey to Rome in order to visit the bishop Anicetus. Irenaeus, to whom we are indebted for this information (*Haer.* iii. 3, 4; *Epist. ad victorem, ap.* Euseb. v. 24), gives as the reason for the journey the fact that differences existed between Asia and Rome "with regard to certain things" and especially about the time of the Easter festival. He might easily have told us what these "certain things" were and given us fuller details of the negotiations between the two great bishops, for in all probability he was himself in Rome at the time. But unfortunately all he says is that with regard to the certain things the two bishops speedily came to an understanding, while as to the time of Easter, each adhered to his own custom, without breaking off communion with the other. We learn further that Anicetus as a mark of special honour allowed Polycarp to celebrate the Eucharist in the church, and that many Marcionites and Valentinians were converted by him during his stay in Rome.

4. *Polycarp's Martyrdom.*—Not many months apparently after Polycarp's return from Rome a persecution broke out in Asia. A great festival was in progress at Smyrna. The proconsul Statius Quadratus was present on the occasion, and the asiarch Philip of Tralles was presiding over the games. Eleven Christians had been brought, mostly from Philadelphia, to be put to death. The appetite of the populace was inflamed by the spectacle of their martyrdom. A cry was raised "Away with the atheists. Let search be made for Polycarp." Polycarp took refuge in a country farm. His hiding-place, however, was betrayed and he was arrested and brought back into the city. Attempts were made by the officials to induce him to recant, but without effect. When he came into the theatre the proconsul urged him to "revile Christ," and promised, if he would consent to abjure his faith, that he would set him at liberty. To this appeal Polycarp made the memorable answer, "Eighty and six years have I served Him and He hath done me no wrong. How then can I speak evil of my King who saved me?" These words only intensified the fury of the mob. They clamoured for a lion to be let loose upon him there and then. The asiarch however refused, urging as an excuse that the games were over. When they next demanded that their victim should be burned, the proconsul did not interfere. Timber and faggots were hastily collected and Polycarp was placed upon the pyre. With calm dignity and unflinching courage he met his fate and crowned a noble life with an heroic death.

The question as to the date of the martyrdom has evoked considerable controversy. Eusebius in his *Chronicon* gives A.D. 166 as the date of Polycarp's death, and until the year 1867 this statement was never questioned. In that year appeared Waddington's *Mémoire sur la chronologie de la vie du rhéteur Aélius Aristide*, in which it was shown from a most acute combination of circumstances that the Quadratus whose name is mentioned in the *Martyrium* was proconsul of Asia in 155-156, and that consequently Polycarp was martyred on the 23rd of February 155. Waddington's conclusion has received overwhelming support amongst recent critics. His views have been accepted by (amongst many others) Renan,¹ Hilgenfeld,² Gebhardt,³ Lipsius,⁴ Harnack,⁵ Zahn,⁶ Lightfoot,⁷ Randell.⁸ Against this

array of scholars only the following names of importance can be quoted in support of the traditional view—Keim,⁹ Wieseler¹⁰ and Uhlhorn.¹¹ The problem is too complex to admit of treatment here. There seems to be little doubt that the case for the earlier date has been proved. The only point upon which there is division of opinion is as to whether Waddington's date 155, or—as is suggested by Lipsius and supported by C. H. Turner¹²—the following year 156 is the more probable. The balance of opinion seems to favour the latter alternative, because it leaves more room for Polycarp's visit to Anicetus, who only became bishop of Rome in 154. Harnack, however, after careful investigation, prefers 155.

The significance of Polycarp in the history of the Church is out of all proportion to our knowledge of the facts of his career. The violent attack of the Smyrnaean mob is an eloquent tribute to his influence in Asia. "This is the teacher of Asia," they shouted, "this is the father of the Christians: this is the destroyer of our gods: this is the man who has taught so many no longer to sacrifice and no longer to pray to the gods."¹³ And after the execution they refused to deliver up his bones to the Christians for burial on the ground that "the Christians would now forsake the Crucified and worship Polycarp."¹⁴ Polycarp was indeed, as Polycrates says,¹⁵ "one of the great luminaries" (*μεγάλα στοιχεία*) of the time. It was in no small degree due to his staunch and unwavering leadership that the Church was saved from the peril of being overwhelmed by the rising tide of the pagan revival which swept over Asia during the first half of the 2nd century, and it was his unflinching allegiance to the Apostolic faith that secured the defeat of the many forms of heresy which threatened to destroy the Church from within. Polycarp had no creative genius. He was a "transmitter, not a maker," but herein lies his greatness. Much occurred between the Apostolic age and the age when the faith of the Church was fixed in the earliest creed and protected by the determination of the canon of the New Testament. This intervening period was the most perilous epoch in the history of the ante-Nicene Church. The Apostolic tradition might have been perverted and corrupted. The purity of the Gospel might have been defiled. The Christian ideal might have been lost. That the danger was so largely averted is to no small extent the result of the faithful witness of Polycarp. As Irenaeus says (iii. 3, 4), "Polycarp does not appear to have possessed qualifications for successfully conducting a controversial discussion with erroneous teachers... but he could not help feeling how unlike their speculations were to the doctrines which he had learned from the Apostles, and so he met with indignant reprobation their attempt to supersede Christ's gospel with fictions of their own devising." It is this that constitutes Polycarp's service to the Church, and no greater service has been rendered by any of its leaders in any age.

BIBLIOGRAPHY.—J. B. Lightfoot, *Apostolic Fathers*, pt. ii. (2nd ed., 1889). Polycarp is dealt with in i. 417-459, 530-704; ii. 897-1086; G. Volkmar, *Epistula Polycarpi Smyrnaei genuina* (Zürich, 1885); T. Zahn, *Forschungen zur Geschichte des Kanons, &c.*, iv. 249, 279; J. M. Cotterill, "The Epistle of Polycarp to the Philippians," *Journ. of Philol.* (1891), xix., 241-285; Harnack, *Chronologie der altchristlichen Litteratur* (1897). See also APOSTOLIC FATHERS. (H. T. A.)

POLYCLITUS, the name of two Greek sculptors of the school of Argos; the first belonging to the fifth century, the second to the early part of the fourth.

1. The elder and best known Polyclitus was a contemporary of Pheidias, and in the opinion of the Greeks his equal. He made a figure of an Amazon for Ephesus which was regarded as superior to the Amazon of Pheidias made at the same time; and his colossal Hera of gold and ivory which stood in the temple near Argos was considered as worthy to rank with the Zeus of Pheidias.

⁹ *Aus dem Urchristentum*, p. 90.

¹⁰ *Die Christenverfolgungen der Caesaren* (1878), p. 34.

¹¹ *Studia biblica* (1890), ii. 105-156.

¹² *Realencyk. f. prot. Theol.*, 2nd ed. xii. 105.

¹³ *Martyrium*, ch. 12.

¹⁴ *Ibid.* 17.

¹⁵ *Ap.* Euseb. v. 24.

¹ *Antichrist* (1873), p. 207. ² *Zeitschr. f. wiss. Theol.* (1874), p. 325.

³ *Zeitschr. f. hist. Theol.* (1875), p. 356.

⁴ *Jahrb. f. prot. Theol.* (1883), p. 525. ⁵ *Chronologie*, i. 334-356.

⁶ *Zeitschr. f. wiss. Theol.* (1882), p. 227; (1884), p. 216.

⁷ *Ignatius and Polycarp*, i. 629-702. ⁸ *Studia biblica* (1885), i. 175.

It would be hard for a modern critic to rate Polyclitus so high: the reason is that balance, rhythm and the minute perfection of bodily form, which were the great merits of this sculptor, do not appeal to us as they did to the Greeks of the 5th century. He worked mainly in bronze.

As regards his chronology we have data in a papyrus published by Grenfell and Hunt containing lists of athletic victors. From this it appears that he made a statue of Cyniscus, a victorious athlete of 464 or 460 B.C., of Pythocles (452) and Aristion (452). He thus can scarcely have been born as late as 480 B.C. His statue of Hera is dated by Pliny to 420 B.C. His artistic activity must thus have been long and prolific.

Copies of his spearman (doryphorus) (see GREEK ART, Plate VI, fig. 80), and his victor winding a ribbon round his head (diadumenus) have long been recognized in our galleries. We see their excellence, but they inspire no enthusiasm, because they are more fleshy than modern figures of athletes, and want charm. They are chiefly valuable as showing us the square forms of body affected by Polyclitus, and the scheme he adopted, throwing the weight of the body (as Pliny says of him) on one leg. We must not, however, judge of a great Greek sculptor by Roman copies of his works. This has been enforced by the discovery at Delos, by the French excavators, of a diadumenus of far more pleasing type and greater finish, which also goes back to Polyclitus. The excavations at Olympia have also greatly widened our knowledge of the sculptor. Among the bases of statues found on that site were three signed by Polyclitus, still bearing on their surface the marks of attachment of the feet of the statues. This at once gives us their pose; and following up the clue, A. Furtwangler has identified several extant statues as copies of figures of boy athletes victorious at Olympia set up by Polyclitus. Among these the Westmacott athlete in the British Museum is conspicuous. And it is certain that these boys, although the anatomy of their bodies seems to be too mature, yet have a real charm, combining beauty of form with modesty and unaffected simplicity. They enable us better to understand the merit of the sculptor.

The Amazon of Polyclitus survives in several copies, among the best of which is one in the British Museum (for its type see GREEK ART, fig. 40). Here again we find a certain heaviness; and the womanly character of the Amazon scarcely appears through her robust limbs. But the Amazon of Pheidias, if rightly identified, is no better. The masterpiece of Polyclitus, his Hera of gold and ivory, has of course totally disappeared. The coins of Argos give us only the general type. Many archaeologists have tried to find a copy of the head. The most defensible of all these identifications is that of C. Waldstein, who shows that a head of a girl in the British Museum (labelled as Polyclitan) corresponds so nearly with that of Hera on 5th century coins of Argos that we must regard it as a reflex of the head of the great statue. It seems very hard and cold beside such noble heads of the goddess as those in the Ludovisi Gallery (Terme Museum) Rome. American archaeologists have in recent years conducted excavations on the site of the Argive temple of Hera (ARGOS and GREEK ART, fig. 39); but the sculptural fragments, heads and torsos, which seem to belong to the temple erected in the time of Polyclitus, have no close stylistic resemblance to other statues recognized as his; and at present their position in the history of art is matter of dispute.

The want of variety in the works of Polyclitus was brought as a reproach against him by ancient critics. Varro says that his statues were square and almost of one pattern. We have already observed that there was small variety in their attitudes. Except for the statue of Hera, which was the work of his old age, he produced scarcely any notable statue of a deity. His field was narrowly limited; but in that field he was unsurpassed.

2. The younger Polyclitus was of the same family as the elder, and the works of the two are not easily to be distinguished. Some existing bases, however, bearing the name are inscribed in characters of the 4th century, at which time the elder sculptor cannot have been alive. The most noted work of the younger artist was a statue in marble of Zeus Milichius (the Merciful)

set up by the people of Argos after a shameful massacre which took place in 370 B.C. The elder artist is not known to have worked in marble.

(P. G.)

POLYCRATES, tyrant of Samos (c. 535-515 B.C.). Having won popularity by donations to poorer citizens, he took advantage of a festival of Hera, which was being celebrated outside the walls, to make himself master of the city (about 535 B.C.). After getting rid of his brothers Pantagnotus and Syloson, who had at first shared his power, he established a despotism which is of great importance in the history of the island. Realizing clearly the value of sea-power for a Greek state, he equipped a fleet of 100 ships, and so became master of the Aegean basin. This ascendancy he abused by numerous acts of piracy which made him notorious throughout Greece; but his real purpose in building his navy was to become lord of all the islands of the archipelago and the mainland towns of Ionia. The details of his conquests are uncertain, but it is known that in the Cyclades he maintained an alliance with the tyrant Lygdamis of Naxos, and curried favour with the Delian Apollo by dedicating to him the island of Rheneia. He also encountered and heavily defeated a coalition of two great naval powers of the Asiatic coast, Miletus and Lesbos. Doubtless with the object of expanding the flourishing foreign trade of Samos, he entered into alliance with Amasis, king of Egypt, who, according to Herodotus, renounced his ally because he feared that the gods, in envy of Polycrates' excessive good fortune, would bring ruin upon him and his allies. It is more probable that the breach of the compact was due to Polycrates, for when Cambyses of Persia invaded Egypt (525) the Samian tyrant offered to support him with a naval contingent. This squadron never reached Egypt, for the crews, composed as they were of Polycrates' political enemies, suspecting that Cambyses was under agreement to slay them, put back to Samos and attacked their master. After a defeat by sea, Polycrates repelled an assault upon the walls, and subsequently withstood a siege by a joint armament of Spartans and Corinthians assembled to aid the rebels. He maintained his ascendancy until about 515, when Oroetes, the Persian governor of Lydia, who had been reproached for his failure to reduce Samos by force, lured him to the mainland by false promises of gain and put him to death by crucifixion.

Beside the political and commercial pre-eminence which he conferred upon Samos, Polycrates adorned the city with public works on a large scale—an aqueduct, a mole and a temple of Hera (see SAMOS; AQUEDUCTS). The splendour of his palace is attested by the proposal of the Roman emperor Caligula to rebuild it. Foreign artists worked for him at high wages; from Athens he brought Democedes, the greatest physician of the age, at an exceptional salary. He was also a patron of letters: he collected a library and lived on terms of intimate friendship with the poet Anacreon, whose verses were full of references to his patron. The philosopher Pythagoras, however, quitted Samos in order to escape his tyranny. (M. O. B. C.)

POLYCRATES, Athenian sophist and rhetorician, flourished in the 4th century B.C. He taught at Athens, and afterwards in Cyprus. He composed declamations on paradoxical themes—an *Encomium on Clytemnestra*, an *Accusation of Socrates*, an *Encomium on Busiris* (a mythical king of Egypt, notorious for his inhumanity); also declamations on mice, pots and counters. His *Encomium on Busiris* was sharply criticized by Isocrates, in a work still extant, and Dionysius of Halicarnassus characterizes his style as frigid, vulgar and inelegant.

POLYGAMY (Gr. *πολὸς*, many, and *γάμος*, marriage), or as it is sometimes termed, *POLYGYNV* (*γυνή*, woman), the system under which a man is married to several women at the same time. Derivatively it includes the practice of polyandry, but it has become definitely restricted to expressing what has been, and still is, far the commonest type of relations between the sexes (see FAMILY and MARRIAGE). Among Oriental nations plurality of legal wives is customary. Mahomedans are allowed four. A Hindu can have as many as he pleases: the high-caste sometimes having as many as a hundred. Polygamy is the rule among

African tribes, and is common among those of Australia and Polynesia. In China, however, only one wife is lawful. In many polygamous countries the practical obstacle of expense prevents men from taking advantage of their privileges. While polygamy was the rule in biblical days among the ancient Jews, and was permitted and even enjoined in certain cases by the Mosaic law, the Christian Church, though it is nowhere forbidden, except for "bishops," in the New Testament, has always set its face against it. There have, however, been divines who dissented from this general disapproval. The Anabaptists insisted on freedom in the matter, and Bernardino Ochino conditionally defended plurality of wives. When in 1540 Philip the Magnanimous, the reforming Landgrave of Hesse, determined (with his wife's approval, she being a confirmed invalid) to marry a second wife, Luther and Melancthon approved "as his personal friends, though not as doctors of theology"; while Martin Bucer assisted at the marriage. In later times the Mormons (*q.v.*) in America provide the most notable instance of the revival of polygamy.

POLYGENISTS, the term applied to those anthropologists who contend that the several primary races of mankind are separate species of independent origin. (See **MONOGENISTS**.)

POLYGLOTT (Gr. *πολύς*, many, and *γλῶττα*, tongue), the term for a book which contains side by side versions of the same text in several different languages; the most important polyglotts are editions of the Bible, or its parts, in which the Hebrew and Greek originals are exhibited along with the great historical versions, which are of value for the history of the text and its interpretation. The first enterprise of this kind is the famous *Hexapla* of Origen in which the Old Testament Scriptures were written in six parallel columns, the first containing the Hebrew text, the second a transliteration of this in Greek letters, the third and fourth the Greek translations by Aquila and Symmachus, the fifth the Septuagint version as revised by Origen, the sixth the translation by Theodotion. Inasmuch, however, as only two languages, Hebrew and Greek, were employed the work was rather diglott than polyglott in the usual sense. After the invention of printing and the revival of philological studies, polyglotts became a favourite means of advancing the knowledge of Eastern languages (for which no good helps were available) as well as the study of Scripture. The series began with the *Complutensian* printed by Arnaldus Guilhelmus de Brocario at the expense of Cardinal Ximenes at the university at Alcalá de Henares (Complutum). The first volume of this, containing the New Testament in Greek and Latin, was completed on the 10th of January 1514. In vols. ii.-v. (finished on July 10, 1517) the Hebrew text of the Old Testament was printed in the first column of each page, followed by the Latin Vulgate and then by the Septuagint version with an interlinear Latin translation. Below these stood the Chaldee, again with a Latin translation. The sixth volume containing an appendix is dated 1515, but the work did not receive the papal sanction till March 1520, and was apparently not issued till 1522. The chief editors were Juan de Vergara, Lopez de Zuñiga (Stunica), Nuñez de Guzman (Pincianus), Antonio de Librixa (Nebrissensis), and Demetrius Ducas. About half a century after the *Complutensian* came the *Antwerp Polyglott*, printed by Christopher Plantin (1569-1572, in 8 vols. folio). Of this the principal editor was Arias Montanus aided by Guido Fabricius Boderianus, Raphaelengius, Masius, Lucas of Bruges and others. This work was under the patronage of Philip II. of Spain; it added a new language to those of the *Complutensian* by including the Syriac New Testament; and, while the earlier polyglott had only the Targum of Onkelos on the Pentateuch, the Antwerp Bible had also the Targum on the Prophets, and on Esther, Job, Psalms and the Salomonic writings. Next came Le Jay's *Paris Polyglott* (1645), which embraces the first printed texts of the Syriac Old Testament (edited by Gabriel Sionita, a Maronite, but the book of Ruth by Abraham Echeleensis, also a Maronite) and of the Samaritan Pentateuch and version (by Morinus). It has also an Arabic version, or rather a series of various Arabic versions. The last great polyglott is Brian Walton's (London, 1657), which is much less beautiful than Le Jay's but more complete

in various ways, including, among other things, the Syriac of Esther and of several apocryphal books for which it is wanting in the Paris Bible, Persian versions of the Pentateuch and Gospels, and the Psalms and New Testament in Ethiopic. Walton was aided by able scholars, and used much new manuscript material. His prolegomena, too, and collections of various readings mark an important advance in biblical criticism. It was in connexion with this polyglott that E. Castell produced his famous *Heptaglott Lexicon* (2 vols. folio, London, 1669), an astounding monument of industry and erudition even when allowance is made for the fact that for the Arabic he had the great MS. lexicon compiled and left to the university of Cambridge by the almost forgotten W. Bedwell. The liberality of Cardinal Ximenes, who is said to have spent half a million ducats on it, removed the *Complutensian* polyglott from the risks of commerce. The other three editions all brought their promoters to the verge of ruin. The later polyglotts are of little scientific importance, the best recent texts having been confined to a single language; but every biblical student still uses Walton and, if he can get it, Le Jay. Of the numerous polyglott editions of parts of the Bible it may suffice to mention the Genoa psalter of 1516, edited by Giustiniani, bishop of Nebbio. This is in Hebrew, Latin, Greek, Chaldee and Arabic, and is interesting from the character of the Chaldee text, being the first specimen of Western printing in the Arabic character, and from a curious note on Columbus and the discovery of America on the margin of Psalm xix. (A. W. Po.)

POLYGNOTUS, Greek painter in the middle of the 5th century B.C., son of Aglaophon, was a native of Thasos, but was adopted by the Athenians, and admitted to their citizenship. He painted for them in the time of Cimon a picture of the taking of Ilium on the walls of the Stoa Poecile, and another of the marriage of the daughters of Leucippus in the Anaceum. In the hall at the entrance to the Acropolis other works of his were preserved. The most important, however, of his paintings were his frescoes in a building erected at Delphi by the people of Cnidus. The subjects of these were the visit to Hades by Odysseus, and the taking of Ilium. Fortunately the traveller Pausanias has left us a careful description of these paintings, figure by figure (Paus. x. 25-31). The foundations of the building have been recovered in the course of the French excavations at Delphi. From this evidence, some modern archaeologists have tried to reconstruct the paintings, excepting of course the colours of them. The best of these reconstructions is by Carl Robert, who by the help of vase-paintings of the middle of the fifth century has succeeded in recovering both the perspective of Polygnotus and the character of his figures (see **GREEK ART**, fig. 29). The figures were detached and seldom overlapping, ranged in two or three rows one above another; and the farther were not smaller nor dimmer than the nearer. The designs are repeated in Frazer's *Pausanias*, v. 360 and 372. It will hence appear that paintings at this time were executed on almost precisely the same plan as contemporary sculptural reliefs. We learn also that Polygnotus employed but few colours, and those simple. Technically his art was primitive. His excellence lay in the beauty of his drawing of individual figures; but especially in the "ethical" and ideal character of his art. The contemporary, and perhaps the teacher, of Pheidias, he had the same grand manner. Simplicity, which was almost childlike, sentiment at once noble and gentle, extreme grace and charm of execution, marked his works, in contrast to the more animated, complicated and technically superior paintings of a later age. (P. G.)

POLYGON (Gr. *πολύς*, many, and *γωνία*, an angle), in geometry, a figure enclosed by any number of lines—the sides—which intersect in pairs at the corners or vertices. If the sides are coplanar, the polygon is said to be "plane"; if not, then it is a "skew" or "gauche" polygon. If the figure lies entirely to one side of each of the bounding lines the figure is "convex"; if not it is "re-entrant" or "concave." A "regular" polygon has all its sides and angles equal, *i.e.* it is equilateral and equiangular; if the sides and angles be not equal the polygon is "irregular." Of polygons inscriptible in a circle an equilateral

figure is necessarily equiangular, but the converse is only true when the number of sides is odd. The term regular polygon is usually restricted to "convex" polygons; a special class of polygons (regular in the wider sense) has been named "star polygons" on account of their resemblance to star-rays; these are, however, concave.

Polygons, especially of the "regular" and "star" types, were extensively studied by the Greek geometers. There are two important corollaries to prop. 32, book i., of Euclid's *Elements* relating to polygons. Having proved that the sum of the angles of a triangle is a straight angle, i.e. two right angles, it is readily seen that the sum of the internal angles of a polygon (necessarily convex) of n sides is $n - 2$ straight angles ($2n - 4$ right angles), for the polygon can be divided into $n - 2$ triangles by lines joining one vertex to the other vertices. The second corollary is that the sum of the supplements of the internal angles, measured in the same direction, is 4 right angles, and is thus independent of the number of sides.

The systematic discussion of regular polygons with respect to the inscribed and circumscribed circles is given in the fourth book of the *Elements*. (We may note that the construction of an equilateral triangle and square appear in the first book.) The triangle is discussed in props. 2-6; the square in props. 6-9; the pentagon (5-side) in props. 10-14; the hexagon (6-side) in prop. 15; and the quindecagon in prop. 16. The triangle and square call for no special mention here, other than that any triangle can be inscribed or circumscribed to a circle. The pentagon is of more interest. Euclid bases his construction upon the fact that the isosceles triangle formed by joining the extremities of one side of a regular pentagon to the opposite vertex has each angle at the base double the angle at the vertex. He constructs this triangle in prop. 10, by dividing a line in medial section, i.e. the square of one part equal to the product of the other part and the whole line (a construction given in book ii. 11), and then showing that the greater segment is the base of the required triangle, the remaining sides being each equal to the whole line. The inscription of a pentagon in a circle is effected by inscribing an isosceles triangle similar to that constructed in prop. 10, bisecting the angles at the base and producing the bisectors to meet the circle. Euclid then proves that these intersections and the three vertices of the triangle are the vertices of the required pentagon. The circumscription of a pentagon is effected by constructing an inscribed pentagon, and drawing tangents to the circle at the vertices. This supplies a general method for circumscribing a polygon if the inscribed be given, and conversely. In book xiii., prop. 10, an alternative method for inscribing a pentagon is indicated, for it is there shown that the sum of the squares of the sides of a square and hexagon inscribed in the same circle equals the square of the side of the pentagon. It may be incidentally noticed that Euclid's construction of the isosceles triangle which has its basal angles double the vertical angle solves the problem of quinquesectioning a right angle; moreover, the base of the triangle is the side of the regular decagon inscribed in a circle having the vertex as centre and the sides of the triangle as radius. The inscription of a hexagon in a circle (prop. 15) reminds one of the Pythagorean result that six equilateral triangles placed about a common vertex form a plane; hence the bases form a regular hexagon. The side of a hexagon inscribed in a circle obviously equals the radius of the circle. The inscription of the quindecagon in a circle is made to depend upon the fact that the difference of the arcs of a circle intercepted by covertical sides of a regular pentagon and equilateral triangle is $\frac{1}{5} - \frac{1}{3} = \frac{2}{15}$, of the whole circumference, and hence the bisection of this intercepted arc (by book iii., 30) gives the side of the quindecagon.

The methods of Euclid permit the construction of the following series of inscribed polygons: from the square, the 8-side or octagon, 16-, 32- . . . , or generally $4 \cdot 2^n$ -side; from the hexagon, the 12-side or dodecagon, 24-, 48- . . . , or generally the $6 \cdot 2^n$ -side; from the pentagon, the 10-side or decagon, 20-, 40- . . . , or generally $5 \cdot 2^n$ -side; from the quindecagon, the 30-, 60- . . . , or generally $15 \cdot 2^n$ -side. It was long supposed that no other inscribed polygons were possible of construction by elementary methods (i.e. by the ruler and compasses); Gauss disproved this by forming the 17-side, and he subsequently generalized his method for the $(2^n + 1)$ -side, when this number is prime.

The problem of the construction of an inscribed heptagon, nonagon, or generally of any polygon having an odd number of sides, is readily reduced to the construction of a certain isosceles triangle. Suppose the polygon to have $(2n + 1)$ sides. Join the extremities of one

side to the opposite vertex, and consider the triangle so formed. It is readily seen that the angle at the base is n times the angle at the vertex. In the heptagon the ratio is 3, in the nonagon 4, and so on. The Arabian geometers of the 9th century showed that the heptagon required the solution of a cubic equation, thus resembling the Pythagorean problems of "duplicating the cube" and "trisectioning an angle." Edmund Halley gave solutions for the heptagon and nonagon by means of the parabola and circle, and by a parabola and hyperbola respectively.

Although rigorous methods for inscribing the general polygons in a circle are wanting, many approximate ones have been devised. Two such methods are here given: (1) Divide the diameter of the circle into as many parts as the polygon has sides. On the diameter construct an equilateral triangle; and from its vertex draw a line through the *second* division along the diameter, measured from an extremity, and produce this line to intercept the circle. Then the chord joining this point to the extremity of the diameter is the side of the required polygon. (2) Divide the diameter as before, and draw also the perpendicular diameter. Take points on these diameters beyond the circle and at a distance from the circle equal to one division of the diameter. Join the points so obtained; and draw a line from the point nearest the divided diameter where this line intercepts the circle to the *third* division from the produced extremity; this line is the required length.

The construction of any regular polygon on a given side may be readily performed with a protractor or scale of chords, for it is only necessary to lay off from the extremities of the given side lines equal in length to the given base, at angles equal to the interior angle of the polygon, and repeating the process at each extremity so obtained, the angle being always taken on the same side; or lines may be laid off at one half of the interior angles, describing a circle having the meet of these lines as centre and their length as radius, and then measuring the given base around the circumference.

Star Polygons.—These figures were studied by the Pythagoreans, and subsequently engaged the attention of many geometers—Boethius, Athelard of Bath, Thomas Bradwardine, archbishop of Canterbury, Johannes Kepler and others. Mystical and magical properties were assigned to them at an early date; the Pythagoreans regarded the pentagram, the star polygon derived from the pentagon, as the symbol of health, the Platonists of well-being, while others used it to symbolize happiness. Engraven on metal, &c., it is worn in almost every country as a charm or amulet.

The pentagon gives rise to one star polygon, the hexagon gives none, the heptagon two, the octagon one, and the nonagon two. In general, the number of star polygons which can be drawn with the vertices of an n -point regular polygon is the number of numbers which are not factors of n and are less than $\frac{1}{2}n$.



Pentagrams. Heptagrams. Nonagrams.

Number of n-point and n-side Polygons. A polygon may be regarded as determined by the joins of points or the meets of lines. The termination *-gram* is often applied to the figures determined by lines, e.g. pentagram, hexagram. It is of interest to know how many polygons can be formed with n given points as vertices (no three of which are collinear), or with n given lines as sides (no two of which are parallel). Considering the case of points it is obvious that we can join a chosen point with any one of the remaining $(n - 1)$ points; any one of these $(n - 1)$ points can be joined to any one of the remaining $(n - 2)$, and by proceeding similarly it is seen that we can pass through the n points in $(n - 1)(n - 2) \dots 2 \cdot 1$ or $(n - 1)!$ ways. It is obvious that the *direction* in which we pass is immaterial; hence we must divide this number by 2, thus obtaining $(n - 1)!/2$ as the required number. In a similar manner it may be shown that the number of polygons determined by n lines is $(n - 1)!/2$. Thus five points or lines determine 12 pentagons, 6 points or lines 60 hexagons, and so on.

Mensuration.—In the regular polygons the fact that they can be inscribed and circumscribed to a circle affords convenient expressions for their area, &c. In a n -gon, i.e. a polygon with n -sides, each side subtends at the centre the angle $2\pi/n$, i.e. $360^\circ/n$, and each internal angle is $(n - 2)\pi/n$ or $(n - 2)180^\circ/n$. Calling the length of side a we may derive the following relations: Area

Number of sides.	3 Triangle.	4 Square.	5 Pentagon.	6 Hexagon.	7 Heptagon.	8 Octagon.	9 Nonagon.	10 Decagon.	11 Undecagon.	12 Dodecagon.
α	60°	90°	108°	120°	$128\frac{4}{5}^\circ$	135°	140°	144°	$147\frac{8}{11}^\circ$	150°
β	120°	90°	72°	60°	$51\frac{2}{7}^\circ$	45°	40°	36°	$32\frac{2}{11}^\circ$	30°
A	0.43301	1	1.72048	2.59808	3.63391	4.82843	6.18182	7.69421	9.36564	11.19615
R	0.57735	0.70710	0.85065	1	1.1523	1.3065	1.4619	1.6180	1.7747	1.9318
r	0.28867	0.5	0.68819	0.86602	1.0383	1.2071	1.3737	1.5388	1.7028	1.8660

(A) = $\frac{1}{2} a^2 n \cot (\pi/n)$; radius of circum-circle (R) = $\frac{1}{2} a \operatorname{cosec} (\pi/n)$
 radius of in-circle (r) = $\frac{1}{2} a \cot (\pi/n)$.

The table at foot of p. 1592 gives the value of the internal angle (α), the angle β subtended at the centre by a side, area (A), radius of the circum-circle (R), radius of the inscribed circle (r) for the simpler polygons, the length of the side being taken as unity.

POLYGONACEAE, in botany, a natural order of Dicotyledons, containing 30 genera with about 700 species, chiefly in the north temperate zone, and represented in Great Britain by three genera, *Polygonum*, *Rumex* (Dock, *q.v.*) and *Oxyria*. They are mostly herbs characterized by the union of the stipules into a sheath or *ocrea*, which protects the younger leaves in the bud stage (fig. 1). Some are climbers, as, for instance, the British *Polygonum Convolvulus* (black bindweed). In *Muehlenbeckia platyclada*, a native of the Solomon Islands, the stem and branches are flattened, forming ribbon-like cladodes jointed at the nodes. The leaves are alter-

the three inner leaves enlarge and envelope the fruit as three membranous wings one or more of which bear on the back large fleshy warts. Less often, as in the South American genus *Triplaris*, the three outer perianth leaves form the agent of distribution, developing into long flat membranous wings, the whole mechanism suggesting a shuttlecock. The number of the carpels is indicated by the three-sided (in dimerous flowers two-sided) ovary, and the number of the styles; the ovary is unilocular and contains a single erect ovule springing from the top of the floral axis (fig. 7). The fruit is a dry one-seeded nut, two-



FIG. 1.—Leaf of *Polygonum*, with part of stem (g, ocrea).

nate, simple and generally entire; the edges are rolled back in the bud. They are generally smooth, but sometimes, especially in mountain species, woolly. The small regular, generally hermaphrodite flowers are borne in large numbers in compound inflorescences, the branches of which are cymose. The parts of the flower are whorled (cyclic) or acyclic. The former arrangement may be derived from a regular trimerous flower with two whorls of perianth leaves, two staminal whorls and a three-sided ovary—such a flower occurs in the Californian genus *Pterostegia* (fig. 2). The flower of rhubarb (*Rheum*) is derived from this by doubling in the outer staminal whorl (fig. 3), and



FIG. 8. *Rumex obtusifolius*, Common Dock.

1. Upper part of plant, showing the flowers (about $\frac{1}{2}$ nat. size).
2. Leaf from base of the stem ($\frac{1}{2}$ nat. size).
3. Fruit enlarged.
4. Fruit of *Rumex Acetosae* (sorrel) (enlarged).



FIG. 2.—*Pterostegia*. FIG. 3.—*Rheum*. FIG. 4.—*Rumex*.

that of the dock (*Rumex*) by doubling in the outer staminal whorl and suppression of the inner (fig. 4). In *Koenigia*, a tiny annual less than an inch high, native in the arctic and sub-arctic regions and the Himalayas, there is one perianth and one staminal whorl only. Dimerous whorled flowers occur in *Oxyria* (mountain sorrel), another arctic and alpine genus, the flowers of which resemble those of *Rumex* but are dimerous (fig. 5). In the acyclic flowers a 5-merous perianth is followed

by 5 to 8 stamens as in *Polygonum* (fig. 6). The perianth leaves are generally uniform and green, white or red in colour. They are free or more or less united, and persist till the fruit is ripe, often playing a part in its distribution, and affording useful characters for distinguishing genera or species. Thus in the docks sided in bicarpellary flowers, as in *Oxyria*. The straight or curved embryo is embedded in a mealy endosperm. The flowers are wind-pollinated, as in the docks (*Rumex*), where they are pendulous on long slender stalks and have large hairy stigmas; or insect-pollinated, as in *Polygonum* or rhubarb (*Rheum*), where the stigmas are capitate and honey is secreted by glands near the base of the stamens. Insect-pollinated flowers are rendered conspicuous chiefly by their aggregation in large numbers, as for instance in Bistort (*Polygonum Bistorta*), where the perianth is red and the flowers are crowded in a spike. In buckwheat (*q.v.*, *P. Fagopyrum*) the numerous flowers have a white or red perianth and are perfumed; they are dimorphic, *i.e.* there are two forms of flowers, one with long styles and short stamens, the other with short styles and long stamens. In other cases self-pollination is the rule, as in knot-grass (*P. aviculare*), where the very small, solitary odourless flowers are very rarely visited by insects and pollinate themselves by the incurving of the three inner stamens on to the styles.

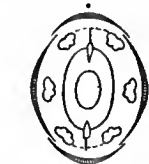

FIG. 5.—*Oxyria*.



FIG. 6.—*Polygonum*.

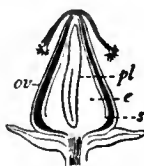

FIG. 7.—Dry one-seeded fruit of dock (*Rumex*) cut vertically (enlarged).
 ov, Pericarp formed from ovary wall.
 s, Seed.
 e, Endosperm.
 pl, Embryo with radicle pointing upwards and cotyledons downwards.

by 5 to 8 stamens as in *Polygonum* (fig. 6). The perianth leaves are generally uniform and green, white or red in colour. They are free or more or less united, and persist till the fruit is ripe, often playing a part in its distribution, and affording useful characters for distinguishing genera or species. Thus in the docks

Polygonaceae is mainly a north temperate order. A few genera are tropical, *e.g.* *Coccoloba*, which has 125 species restricted to tropical and sub-tropical America. *Polygonum* has a very wide distribution spreading from the limits of vegetation in the northern hemisphere to the mountains of tropical Africa and South Africa, through the highlands of tropical Asia to Australia, and in America as far south as Chile. Most of the genera have, however, a limited distribution. Of the three which are native in the British Isles, *Polygonum* has

12 species; *Rumex* (fig. 8) (11 species) includes the various species of dock (*q.v.*) and sorrel (*R. Acetosae*); and *Oxyria digyna*, an alpine plant (mountain sorrel), takes its generic name (Gr. *ὄξυς*, sharp) from the acidity of its leaves. *Rheum* (Rhubarb, *q.v.*) is central Asiatic.

POLYGONAL NUMBERS, in mathematics. Suppose we have a number of equal circular counters, then the number of counters which can be placed on a regular polygon so that the tangents to the outer rows form the regular polygon and all the internal counters are in contact with its neighbours, is a "polygonal number" of the order of the polygon. If the polygon be a triangle then it is readily seen that the numbers are 3, 6, 10, 15, . . . and generally $\frac{1}{2}n(n+1)$; if a square, 4, 9, 16, . . . and generally n^2 ; if a pentagon, 5, 12, 22, . . . and generally $n(3n-1)$; if a hexagon, 6, 15, 28, . . . and generally $n(2n-1)$; and similarly for a polygon of r sides, the general expression for the corresponding polygonal number is $\frac{1}{2}n[(n-1)(r-2)+2]$.

Algebraically, polygonal numbers may be regarded as the sums of consecutive terms of the arithmetical progressions having 1 for the first term and 1, 2, 3, . . . for the common differences. Taking unit common difference we have the series 1; $1+2=3$; $1+2+3=6$; $1+2+3+4=10$; or generally $1+2+3+\dots+n=\frac{1}{2}n(n+1)$; these are triangular numbers. With a common difference 2 we have 1; $1+3=4$; $1+3+5=9$; $1+3+5+7=16$; or generally $1+3+5+\dots+(2n-1)=n^2$; and generally for the polygonal number of the r th order we take the sums of consecutive terms of the series

$$1, 1+(r-2), 1+2(r-2), \dots, 1+n-1.r-2;$$

and hence the n th polygonal number of the r th order is the sum of n terms of this series, *i.e.*,

$$1+1+(r-2)+1+2(r-2)+\dots+(1+n-1.r-2) = n+\frac{1}{2}n.n-1.r-2.$$

The series 1, 2, 3, 4, . . . or generally n , are the so-called "linear numbers" (cf. FIGURATE NUMBERS).

POLYHEDRAL NUMBERS, in mathematics. These numbers are related to the polyhedra (see POLYHEDRON) in a manner similar to the relation between polygonal numbers (see above) and polygons. Take the case of tetrahedral numbers. Let AB, AC, AD be three covertical edges of a regular tetrahedron. Divide AB, . . . into parts each equal to A1, so that tetrahedra having the common vertex A are obtained, whose linear dimensions increase arithmetically. Imagine that we have a number of spheres (or shot) of a diameter equal to the distance A1. It is seen that 4 shot having their centres at the vertices of the tetrahedron A1 will form a pyramid. In the case of the tetrahedron of edge A2 we require 3 along each side of the base, *i.e.* 6, 3 along the base of A1, and 1 at A, making 10 in all. To add a third layer, we will require 4 along each base, *i.e.* 9, and 1 in the centre. Hence in the tetrahedron A3 we have 20 shot. The numbers 1, 4, 10, 20 are polyhedral numbers, and from their association with the tetrahedron are termed "tetrahedral numbers."

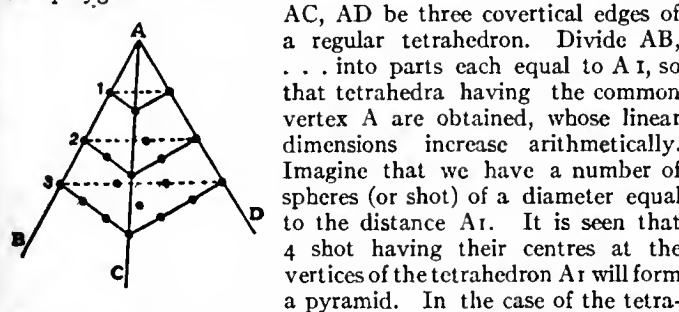

This illustration may serve for a definition of polyhedral numbers: a polyhedral number represents the number of equal spheres which can be placed within a polyhedron so that the spheres touch one another or the sides of the polyhedron.

In the case of the tetrahedron we have seen the numbers to be 1, 4, 10, 20; the general formula for the n th tetrahedral number is $\frac{1}{6}n(n+1)(n+2)$. Cubic numbers are 1, 8, 27, 64, 125, &c.; or generally n^3 . Octahedral numbers are 1, 6, 19, 44, &c.; or generally $\frac{1}{3}n(2n^2+1)$. Dodecahedral numbers are 1, 20, 84, 220, &c.; or generally $\frac{1}{2}n(9n^2-9n+2)$. Icosahedral numbers are 1, 12, 48, 124, &c.; or generally $\frac{1}{2}n(5n^2-5n+2)$.

POLYHEDRON (Gr. *πολύς*, many, *ἔδρα*, a base), in geometry, a solid figure contained by plane faces. If the figure be entirely to one side of any face the polyhedron is said to be "convex," and it is obvious that the faces enwrap the centre once; if, on the other hand, the figure is to both sides of every face it is said to be "concave," and the centre is multiply enwrapped by the faces. "Regular polyhedra" are such as have their faces all equal regular polygons, and all their solid angles equal; the term is

usually restricted to the five forms in which the centre is singly enclosed, *viz.* the Platonic solids, while the four polyhedra in which the centre is multiply enclosed are referred to as the Kepler-Poinsot solids, Kepler having discovered three, while Poinsot discovered the fourth. Another group of polyhedra are termed the "Archimedean solids," named after Archimedes, who, according to Pappus, invented them. These have faces which are all regular polygons, but not all of the same kind, while all their solid angles are equal. These figures are often termed "semi-regular solids," but it is more convenient to restrict this term to solids having all their angles, edges and faces equal, the latter, however, not being regular polygons.

Platonic Solids. The names of these five solids are: (1) the tetrahedron, enclosed by four equilateral triangles; (2) the cube or hexahedron, enclosed by 6 squares; (3) the octahedron, enclosed by 8 equilateral triangles; (4) the dodecahedron, enclosed by 12 pentagons; (5) the icosahedron, enclosed by 20 equilateral triangles.

The first three were certainly known to the Egyptians; and it is probable that the icosahedron and dodecahedron were added by the Greeks. The cube may have originated by placing three equal squares at a common vertex, so as to form a trihedral angle. Two such sets can be placed so that the free edges are brought into coincidence while the vertices are kept distinct. This solid has therefore 6 faces, 8 vertices and 12 edges. The equilateral triangle is the basis of the tetrahedron, octahedron and icosahedron.¹ If three equilateral triangles be placed at a common vertex with their covertical sides coincident in pairs, it is seen that the base is an equal equilateral triangle; hence four equal equilateral triangles enclose a space. This solid has 4 faces, 4 vertices and 6 edges. In a similar manner, four covertical equilateral triangles stand on a square base. Two such sets placed base to base form the octahedron, which consequently has 8 faces, 6 vertices and 12 edges. Five equilateral triangles covertically placed would stand on a pentagonal base, and it was found that, by forming several sets of such pyramids, a solid could be obtained which had 20 triangular faces, which met in pairs to form 30 edges, and in fives to form 12 vertices. This is the icosahedron. That the triangle could give rise to no other solid followed from the fact that six covertically placed triangles formed a plane. The pentagon is the basis of the dodecahedron. Three pentagons may be placed at a common vertex to form a solid angle, and by forming several such sets and placing them in juxtaposition a solid is obtained having 12 pentagonal faces, 30 edges, and 20 vertices.

These solids played an important part in the geometry of the Pythagoreans, and in their cosmology symbolized the five elements: fire (tetrahedron), air (octahedron), water (icosahedron), earth (cube), universe or ether (dodecahedron). They were also discussed by the Platonists, so much so that they became known as the "Platonic solids." Euclid discusses them in the thirteenth book of his *Elements*, where he proves that no more regular bodies are possible, and shows how to inscribe them in a sphere. This latter problem received the attention of the Arabian astronomer Abul Wefa (10th century A.D.), who solved it with a single opening of the compasses.

Mensuration of the Platonic Solids.—The mensuration of the regular polyhedra is readily investigated by the methods of elementary geometry, the property that these solids may be inscribed in and circumscribed to concentric spheres being especially useful.

If F be the number of faces, n the number of edges per face, m the number of faces per vertex, and l the length of an edge, and if we denote the angle between two adjacent faces by α , the area by A , the volume by V , the radius of the circum-sphere by R , and of the in-sphere by r , the following general formulæ hold, α being written for $2\pi/n$, and β for $2\pi/m$:—

$$\begin{aligned} \sin \frac{1}{2}I &= \cos \beta / \sin \alpha; & \tan \frac{1}{2}I &= \cos \beta / (\sin^2 \alpha - \cos^2 \beta)^{\frac{1}{2}}. \\ A &= \frac{1}{2} l^2 n F \cot \alpha. \\ V &= \frac{1}{3} r A = \frac{1}{3} l^3 n F \tan \frac{1}{2}I \cot^2 \alpha \\ &= \frac{1}{3} l^3 n F \cot^2 \alpha \cos \beta / (\sin^2 \alpha - \cos^2 \beta)^{\frac{1}{2}}. \\ R &= \frac{1}{2} l \tan \frac{1}{2}I \tan \beta = \frac{1}{2} l \sin \beta / (\sin^2 \alpha - \cos^2 \beta)^{\frac{1}{2}}. \\ r &= \frac{1}{2} l \tan \frac{1}{2}I \cot \alpha = \frac{1}{2} l \cot \alpha \cos \beta / (\sin^2 \alpha - \cos^2 \beta)^{\frac{1}{2}}. \end{aligned}$$

¹ In the language of Proclus, the commentator: "The equilateral triangle is the proximate cause of the three elements, 'fire,' 'air' and 'water'; but the square is annexed to the 'earth.'"

The following Table gives the values of A, V, R, r for the five Polyhedra:—

	A. Area.	Volume V.	Radius of Circum-sphere. R.	Radius of In-sphere. r.
Tetrahedron	$l^2 \cdot \sqrt{3}$ (1.7321 l^2).	$l^3/6\sqrt{2}$ (0.11785 l^3)	$l \cdot \sqrt{6}/4$	$l \cdot \sqrt{6}/12$
Cube	$6l^2$	l^3	$l \cdot \sqrt{3}/2$	$l/3$
Octahedron	$l^2 \cdot 2\sqrt{3}$ (3.4642 l^2)	$l^3 \cdot \sqrt{2}/3$ (0.47140 l^3)	$l/\sqrt{2}$	$l/\sqrt{6}$
Dodecahedron	$l^2 \cdot 15\sqrt{(1+2\sqrt{5})}$ (20.64578 l^2)	$l^3 \cdot 5\sqrt{(47+21\sqrt{5})}/40$ (7.663119 l^3)	$l \cdot \frac{1}{2}\sqrt{(5+3\sqrt{5})}/2$	$l \cdot \sqrt{(20+11\sqrt{5})}/40$
Icosahedron	$l^2 \cdot 5\sqrt{3}$ (8.6605 l^2)	$l^3 \cdot \frac{5}{2}\sqrt{(7+3\sqrt{5})}/2$ (2.18169 l^3)	$l \cdot \frac{1}{2}\sqrt{(5+\sqrt{5})}/2$	$l \cdot \frac{1}{2}\sqrt{(7+3\sqrt{5})}/6$

Kepler-Poinsot Polyhedra.—These solids have all their faces equal regular polygons, and the angles at the vertices all equal. They bear a relation to the Platonic solids similar to the relation of “star polygons” to ordinary regular polygons, inasmuch as the centre is multiply enclosed in the former and singly in the latter. Four such solids exist: (1) small stellated dodecahedron; (2) great dodecahedron; (3) great stellated dodecahedron; (4) great icosahedron. Louis Poinsot discussed these solids in his memoir, “Sur les polygones et les polyédres” (*Journ. École poly.* [iv.] 1810), three of them having been previously considered by Kepler. They were afterwards treated by A. L. Cauchy (*Journ. École poly.* [ix.] 1813), who showed that they were derived from the Platonic solids, and that no more than four were possible. A. Cayley treated them in several papers (e.g. *Phil. Mag.*, 1859, 17, p. 123 seq.), considering them by means of their projections on the circumscribing sphere and not, as Cauchy, *in solido*.

The *small stellated dodecahedron* is formed by stellating the Platonic dodecahedron (by “stellating” is meant developing the faces contiguous to a specified base so as to form a regular pyramid). It has 12 pentagonal faces, and 30 edges, which intersect in fives to form 12 vertices. Each vertex is singly enclosed by the five faces; the centre of each face is doubly enclosed by the succession of faces about the face; and the centre of the solid is doubly enclosed by the faces. The *great dodecahedron* is determined by the intersections of the twelve planes which intersect the Platonic icosahedron in five of its edges; or each face has the same boundaries as the basal sides of five coverfaced faces of the icosahedron. It is the reciprocal (see below) of the small stellated dodecahedron. Each vertex is doubly enclosed by the succession of coverfaced faces, while the centre of the solid is triply enclosed by the faces. The *great stellated dodecahedron* is formed by stellating the faces of a great dodecahedron. It has 12 faces, which meet in 30 edges; these intersect in threes to form 20 vertices. Each vertex is singly enclosed by the succession of faces about it; and the centre of the solid is quadruply enclosed by the faces. The *great icosahedron* is the reciprocal of the great stellated dodecahedron. Each of the twenty triangular faces subtend at the centre the same angle as is subtended by four whole and six half faces of the Platonic icosahedron; in other words, the solid is determined by the twenty planes which can be drawn through the vertices of the three faces contiguous to any face of a Platonic icosahedron. The centre of the solid is septuply enclosed by the faces.

A connexion between the number of faces, vertices and edges of regular polyhedra was discovered by Euler, and the result, which assumes the form $E + 2z = F + V$, where E, F, V are the number of edges, faces and vertices, is known as Euler's theorem on polyhedra. This formula only holds for the Platonic solids. Poinsot gave the formula $E + 2k = eV + F$, in which k is the number of times the projections of the faces from the centre on to the surface of the circumscribing sphere make up the spherical surface, the area of a stellated face being reckoned once, and e is the ratio “angles at a vertex / 2π ” as projected on the sphere, E, V, F being the same as before. Cayley gave the formula $E + 2D = eV + e'F$, where e, E, V, F are the same as before, D is the same as Poinsot's k with the distinction that the area of a stellated face is reckoned as the sum of the triangles having their vertices at the centre of the face and standing on the sides, and e' is the ratio: “the angles subtended at the centre of a face by its sides / 2π .”

The following table gives these constants for the regular polyhedra; n denotes the number of sides to a face, n₁ the number of faces to a vertex:—

	F	V	E	n	n ₁	e	e'	D	k
Tetrahedron	4	4	6	3	3	1	1	1	1
Cube	6	8	12	4	3	1	1	1	1
Octahedron	8	6	12	3	4	1	1	1	1
Dodecahedron	12	20	30	5	3	1	1	1	1
Icosahedron	20	12	30	3	5	1	1	1	1
Small stellated dodecahedron	12	12	30	5	5	1	2	3	2
Great dodecahedron	12	12	30	5	5	2	1	3	3
Great stellated dodecahedron	12	20	30	5	3	1	2	7	4
Great icosahedron	20	12	30	3	5	2	1	7	7

Archimedean Solids.—These solids are characterized by having all their angles equal and all their faces regular polygons, which are not all of the same species. Thirteen such solids exist.

1. The *truncated tetrahedron* is formed by truncating the vertices of a regular tetrahedron so as to leave the original faces hexagons. (By the truncation of a vertex or edge we mean the cutting away of the vertex or edge by a plane making equal angles with all the faces composing the vertex or with the two faces forming the edge.) It is bounded by 4 triangular and 4 hexagonal faces; there are 18 edges, and 12 vertices, at each of which two hexagons and one triangle are coverfaced.

2. The *cuboctahedron* is a tesserescac-decahedron (Gr. τεσσαρες-καδεκα, fourteen) formed by truncating the vertices of a cube so as to leave the original faces squares. It is enclosed by 6 square and 8 triangular faces, the latter belonging to a coaxial octahedron. It is a common crystal form.

3. The *truncated cube* is formed in the same manner as the cuboctahedron, but the truncation is only carried far enough to leave the original faces octagons. It has 6 octagonal faces (belonging to the original cube), and 8 triangular ones (belonging to the coaxial octahedron).

4. The *truncated octahedron* is formed by truncating the vertices of an octahedron so as to leave the original faces hexagons; consequently it is bounded by 8 hexagonal and 6 square faces.

5, 6. *Rhombicuboctahedra.*—Two Archimedean solids of 26 faces are derived from the coaxial cube, octahedron and semi-regular (rhombic) dodecahedron (see below). The “small rhombicuboctahedron” is bounded by 12 pentagonal, 8 triangular and 6 square faces; the “great rhombicuboctahedra” by 12 decagonal, 8 triangular and 6 square faces.

7. The *icosidodecahedron* or dyocetracontahedron (Gr. δυο-κατ-τριakovτα, thirty-two), is a 32-faced solid, formed by truncating the vertices of an icosahedron so that the original faces become triangles. It is enclosed by 20 triangular faces belonging to the original icosahedron, and 12 pentagonal faces belonging to the coaxial dodecahedron.

8. The *truncated icosahedron* is formed similarly to the icosidodecahedron, but the truncation is only carried far enough to leave the original faces hexagons. It is therefore enclosed by 20 hexagonal faces belonging to the icosahedron, and 12 pentagonal faces belonging to the coaxial dodecahedron.

9. The *truncated dodecahedron* is formed by truncating the vertices of a dodecahedron parallel to the faces of the coaxial icosahedron so as to leave the former decagons. It is enclosed by 20 triangular faces belonging to the icosahedron and 12 decagons belonging to the dodecahedron.

10. The *snub cube* is a 38-faced solid having at each corner 4 triangles and 1 square; 6 faces belong to a cube, 8 to the coaxial octahedron, and the remaining 24 to no regular solid.

11, 12. The *rhombicosidodecahedra.*—Two 62-faced solids are derived from the dodecahedron, icosahedron and the semi-regular

sodium and alcohol (L. Bouveault and G. Blanc, *Comptes rendus*, 1903, 136, p. 1676; 137, p. 60); and by the addition of the elements of water to the unsaturated cyclic hydrocarbons on boiling with dilute acids.

Aldehydes and Ketones.—The aldehydes are prepared in the usual manner from primary alcohols and acids. The ketones are obtained by the dry distillation of the calcium salts of dibasic saturated aliphatic acids (J. Wislicenus, *Ann.*, 1893, 275, p. 309): $[\text{CH}_2\cdot\text{CH}_2\cdot\text{CO}_2]_2\text{Ca} \rightarrow [\text{CH}_2\cdot\text{CH}_2]_2\text{CO}$; by the action of sodium on the esters of acids of the adipic and pimelic acid series (W. Dieckmann, *Ber.*, 1894, 27, pp. 103, 2475):—

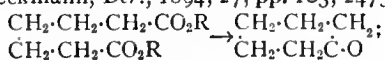

by the action of sodium ethylate on δ -ketoic acids (D. Vorländer, *Ber.*, 1895, 28, p. 2348):—

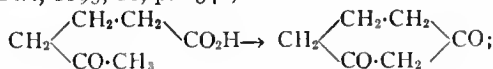

from sodio-malonic ester and $\alpha\beta$ -unsaturated ketones or ketoic esters:—

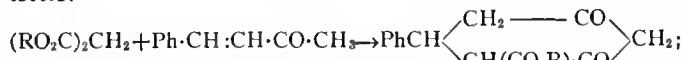

from aceto-acetic ester and esters of $\alpha\beta$ -unsaturated acids, followed by elimination of the carboxyl group:—

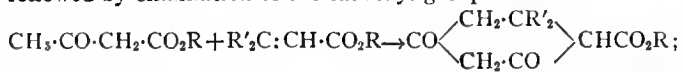

by the condensation of two molecules of aceto-acetic ester with aldehydes followed by saponification (E. Knoevenagel, *Ann.*, 1894, 281, p. 25; 1896, 288, p. 321; *Ber.*, 1904, 37, p. 4461):—

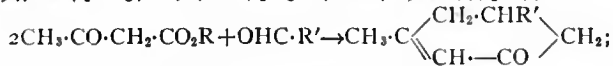

from 1.5-diketones which contain a methyl group next the keto-group (W. Kerp, *Ann.*, 1896, 290, p. 123):—

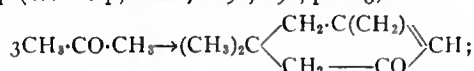

by the condensation of succinic acid with sodium ethylate, followed by saponification and elimination of carbon dioxide:—

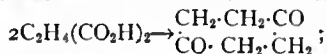

and from the condensation of ethyl oxalate with esters of other dibasic acids in presence of sodium ethylate (W. Dieckmann, *Ber.*, 1897, 30, p. 1470; 1899, 32, p. 1933):—

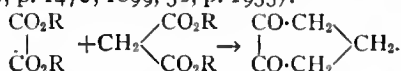

Acids may be prepared by the action of dihalogen paraffins on sodio-malonic ester, or sodio-aceto-acetic ester (W. H. Perkin, jun., *Journ. Chem. Soc.*, 1888, 53, p. 194):—

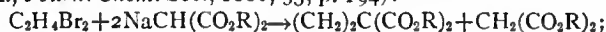

ethyl butane tetracarboxylate is also formed which may be converted into a tetramethylene carboxylic ester by the action of bromine on its disodium derivative (W. H. Perkin and Sinclair, *ibid.*, 1829, 61, p. 36). The esters of the acids may also be obtained by condensing sodio-malonic ester with α -halogen derivatives of unsaturated acids:—

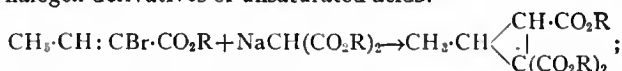

by the action of diazomethane or diazoacetic ester on the esters of unsaturated acids, the pyrazoline carboxylic esters so formed losing nitrogen when heated and yielding acids of the *cyclo*-propane series (E. Buchner, *Ber.*, 1890, 23, p. 703; *Ann.*, 1895, 284, p. 212; H. v. Pechmann, *Ber.*, 1894, 27, p. 1891):—

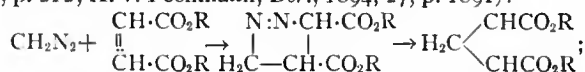

and by the Grignard reaction (S. Malmgren, *Ber.*, 1903, 36, pp. 668, 2622; N. Zelinsky, *ibid.*, 1902, 35, p. 2687).

Cyclo-propane Group.

Trimethylene, C_3H_6 , obtained by A. Freund (*Monats.*, 1882, 3, p. 625) by heating trimethylene bromide with sodium, is a gas, which may be liquefied, the liquid boiling at -35°C . (749 mm.). It dissolves gradually in concentrated sulphuric acid, forming propyl sulphate. Hydriodic acid converts it into *n*-propyl iodide. It is decomposed by chlorine in the presence of sunlight, with explosive violence. It is stable to cold potassium permanganate.

Cyclo-propane carboxylic acid, $\text{C}_3\text{H}_5\cdot\text{CO}_2\text{H}$, is prepared by heating the 1.1-dicarboxylic acid; and by the hydrolysis of its nitrile, formed by heating γ -chlorobutyro-nitrile with potash (L. Henry and P. Dalle, *Chem. Centralblatt*, 1901, 1, p. 1357; 1902, 1, p. 913). It is a colourless oil, moderately soluble in water.

The 1.1 *dicarboxylic acid* is prepared from ethylene dibromide and sodio-malonic ester. The ring is split by sulphuric or hydrobromic acids. The *cis* 1.2-*cyclo-propane dicarboxylic acid* is formed by eliminating carbon dioxide from *cyclo*-propane tricarboxylic acid -1.2.3 (from $\alpha\beta$ -dibromopropionic ester and sodio-malonic ester). The *trans*-acid is produced on heating pyrazolin-4.5-dicarboxylic ester, or by the action of alcoholic potash on α -bromoglutaric ester. It does not yield an anhydride.

Cyclo-butane Group.

Cyclo-butane, C_4H_8 , was obtained by R. Willstätter (*Ber.*, 1907, 40, p. 3979) by the reduction of cyclobutene by the Sabatier and Senderens method. It is a colourless liquid which boils at $11\text{--}12^\circ\text{C}$., and its vapour burns with a luminous flame. Reduction at $180\text{--}200^\circ\text{C}$. by the above method gives *n*-butane.

Cyclo-butene, C_4H_6 , formed by distilling trimethyl-*cyclo*-butyl-ammonium hydroxide, boils at $1.5\text{--}2.0^\circ\text{C}$. (see N. Zelinsky, *ibid.*, p. 4744; G. Schweter, *ibid.*, p. 1604).

When sodio-malonic ester is condensed with trimethylene bromide the chief product is ethyl pentane tetracarboxylate, *tetramethylene* 1.1-*dicarboxylic ester* being also formed, and from this the free acid may be obtained on hydrolysis. It melts at $154\text{--}156^\circ\text{C}$., losing carbon dioxide and passing into *cyclo*-butane carboxylic acid, $\text{C}_4\text{H}_7\cdot\text{CO}_2\text{H}$. This basic acid yields a monobrom derivative which, by the action of aqueous potash, gives the corresponding hydroxy-*cyclo*-butane carboxylic acid, $\text{C}_4\text{H}_7(\text{OH})\cdot\text{CO}_2\text{H}$. Attempts to eliminate water from this acid and so produce an unsaturated acid were unsuccessful; on warming with sulphuric acid, carbon monoxide is eliminated and *cyclo*-butanone (keto-tetramethylene) is probably formed.

The *truxillic acids*, $\text{C}_{13}\text{H}_{16}\text{O}_4$, which result by the hydrolytic splitting of truxilline, $\text{C}_{13}\text{H}_{16}\text{N}_2\text{O}_8$, are phenyl derivatives of *cyclo*-butane. Their constitution was determined by C. Liebermann (*Ber.*, 1888, 21, p. 2342; 1889, 22, p. 124 seq.). They are polymers of cinnamic acid, into which they readily pass on distillation. The α -acid on oxidation yields benzoic acid, whilst the β -acid yields benzil in addition. The α -acid is diphenyl-2.4-*cyclo*-butane dicarboxylic acid -1.3; and the β -acid diphenyl-3.4-*cyclo*-butane dicarboxylic acid -1.2. By alkalis they are transformed into stereo-isomers, the α -acid giving γ -truxillic acid, and the β -acid δ -truxillic acid. The α -acid was synthesized by C. N. Riiber (*Ber.*, 1902, 35, p. 2411; 1904, 37, p. 2274), by oxidizing diphenyl-2.4-*cyclo*-butane-bismethylene malonic acid (from cinnamic aldehyde and malonic acid in the presence of quinoline) with potassium permanganate.

Cyclo-pentane Group.

Derivatives may be prepared in many cases by the breaking down of the benzene ring when it contains an accumulation of negative atoms (T. Zincke, *Ber.*, 1886-1894; A. Hantzsch, *Ber.*, 1887, 20, p. 2780; 1889, 22, p. 1238), this type of reaction being generally brought about by the action of chlorine on phenols in the presence of alkalis (see CHEMISTRY: *Organic*). A somewhat related example is seen in the case of croconic acid, which is formed by the action of alkaline oxidizing agents on hexa-oxybenzene:—

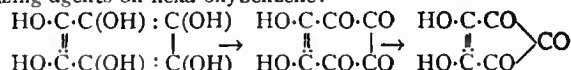

Hexa-oxybenzene. Rhodizonic acid. Croconic acid.

Cyclo-pentane, C_5H_{10} , is obtained from *cyclo*-pentanone by reducing it to the corresponding secondary alcohol, converting this into the iodo-compound, which is finally reduced to the hydrocarbon (J. Wislicenus, *Ann.*, 1893, 275, p. 327). It is a colourless liquid which boils at $50\text{--}51^\circ\text{C}$. *Methyl-cyclo-pentane*, $\text{C}_5\text{H}_9\text{CH}_3$, first obtained by F. Wreden (*Ann.*, 1877, 187, p. 163) by the action of hydriodic acid and red phosphorus on benzene, and considered to be hexahydrobenzene, is obtained synthetically by the action of sodium on 1.5-dibromohexane; and by the action of magnesium on acetylbutyl iodide (N. Zelinsky, *Ber.*, 1902, 35, p. 2684). It is a liquid boiling at 72°C . Nitric acid (sp. gr. 1.42) oxidizes it to succinic and acetic acids. *Cyclo-pentene*, C_5H_8 , a liquid obtained by the action of alcoholic potash on iodo-*cyclo*-pentane, boils at 45°C . *Cyclo-pentadiene*, C_5H_6 , is found in the first runnings from crude benzene distillations. It is a liquid which boils at 41°C . It rapidly polymerizes to di-*cyclo*-pentadiene. The $\cdot\text{CH}_2\cdot$ group is very reactive and behaves in a similar manner to the grouping $\cdot\text{CO}\cdot\text{CH}_2\cdot\text{CO}\cdot$ in open chain compounds, e.g. with aldehydes and ketones it gives the

fulvenes, substances characterized by their intense orange-red colour

(J. Thiele, *Ber.*, 1900, 33, p. 669). *Phenylfulven*, $\begin{matrix} \text{HC:CH} \\ | \\ \text{C:CHPh} \\ | \\ \text{HC:CH} \end{matrix}$

obtained from benzaldehyde and *cyclo*-pentadiene, forms dark red plates. *Diphenylfulven*, from benzophenone and *cyclo*-pentadiene, crystallizes in deep red prisms. *Dimethylfulven* is an orange-coloured oil which oxidizes rapidly on exposure. Concentrated sulphuric acid converts it into a deep red tar.

Cyclo-pentanone, $\text{C}_5\text{H}_8\text{O}$, first prepared pure by the distillation of calcium adipate (J. Wislicenus, *Ann.*, 1893, 275, p. 312), is also obtained by the action of sodium on the esters of pimelic acid; by the distillation of calcium succinate; and by hydrolysis of the *cyclo*-pentanone carboxylic acid, obtained by condensing adipic and oxalic esters in the presence of sodium ethylate. Reduction gives *cyclo*-pentanol, $\text{C}_5\text{H}_{10}\text{O}$.

Croconic acid (dioxy-*cyclo*-pentene-trione), $\text{C}_5\text{H}_2\text{O}_6$, is formed when triquinoyl is boiled with water, or by the oxidation of hexa-oxybenzene or dioxydiquinoyl in alkaline solution (T. Zincke, *Ber.*, 1887, 20, p. 1267). It has the character of a quinone. On oxidation it yields *cyclo*-pentane-pentanone (*leuconic acid*).

Derivatives of the *cyclo*-pentane group are met with in the breaking-down products of the terpenes (*q.v.*).

Campholactone, $\text{C}_9\text{H}_{14}\text{O}_2$, is the lactone of trimethyl-2-2-3-*cyclo*-pentanol-5-carboxylic acid-3. For an isomer, *isocampholactone* (the lactone of trimethyl-2-2-3-*cyclo*-pentanol-3-carboxylic acid-1) see W. H. Perkin, jun., *Proc. Chem. Soc.*, 1903, 19, p. 61. *Lauronic acid*, $\text{C}_9\text{H}_{18}\text{O}_2$, is trimethyl-2-2-3-*cyclo*-pentene-4-acid-1. *Isolauronic acid*, $\text{C}_9\text{H}_{16}\text{O}_2$, is trimethyl-2-2-3-*cyclo*-pentene-3-acid-4.

Campholic acid, $\text{C}_{10}\text{H}_{16}\text{O}_2$, is tetramethyl-1-2-2-3-*cyclo*-pentane acid-3. *Camphononic acid*, $\text{C}_9\text{H}_{14}\text{O}_2$, is trimethyl-2-2-3-*cyclo*-pentanone-1-carboxylic acid-3. *Camphorophorone*, $\text{C}_9\text{H}_{14}\text{O}$, is methyl-2-isobutylene-5-*cyclo*-pentanone-1. *Isotujone*, $\text{C}_{10}\text{H}_{16}\text{O}$, is dimethyl-1-2-isopropyl-3-*cyclo*-pentene-1-one-5. (F. W. Semmler, *Ber.*, 1900, 33, p. 275.)

L. Bouveault and G. Blanc (*Comptes rendus*, 1903, 136, p. 1460), prepared hydrocarbons of the *cyclo*-pentane series from *cyclo*-hexane compounds by the exhaustive methylation process of A. W. Hofmann (see PYRIDINE). For phenyl derivatives of the *cyclo*-pentane group see F. R. Japp, *Jour. Chem. Soc.*, 1897, 71, pp. 139, 144; H. Stobbe, *Ann.*, 1901, 314, p. 111; 315, p. 219 seq.; 1903, 326, p. 347.

Cyclo-hexane Group.

Hydrocarbons.—*Cyclo*-hexane, or hexahydro benzene, C_6H_{12} , is obtained by the action of sodium on a boiling alcoholic solution of 1-6-dibromhexane, and by passing the vapour of benzene, mixed with hydrogen, over finely divided nickel. It is a liquid with an odour like that of benzene. It boils at 80–81° C. Nitric acid oxidizes it to adipic acid. When heated with bromine in a sealed tube for some days at 150–200° C., it yields 1-2-4-5-tetrabrombenzene (N. Zelinsky, *Ber.*, 1901, 34, p. 2803). It is stable towards halogens at ordinary temperature. *Benzene hexachloride*, $\text{C}_6\text{H}_6\text{Cl}_6$, is formed by the action of chlorine on benzene in sunlight. By recrystallization from hot benzene, the α form is obtained in large prisms which melt at 157° C., and at their boiling-point decompose into hydrochloric acid and trichlorobenzene. The β form results by chlorinating boiling benzene in sunlight, and may be separated from the α variety by distillation in a current of steam. It sublimes at about 310° C. Similar varieties of benzene hexabromide are known.

Hexahydrocymene (methyl-1-isopropyl-4-*cyclo*-hexane), $\text{C}_{10}\text{H}_{20}$, is important since it is the parent substance of many terpenes (*q.v.*). It is obtained by the reduction of 1-4 dibrommenthane with sodium (J. de Montgolfer, *Ann. chim. phys.*, 1880 [5], 19, p. 158), or of cymene, limonene, &c., by Sabatier and Senderens's method. It is a colourless liquid which boils at 180° C.

Cyclo-hexene (tetrahydrobenzene), C_6H_{10} , was obtained by A. v. Baeyer by removing the elements of hydriodic acid from iodo-*cyclo*-hexane on boiling it with quinoline. It is a liquid which boils at 82° C. Hypochlorous acid converts it into 2-chlor-*cyclo*-hexanol-1, whilst potassium permanganate oxidizes it to *cyclo*-hexandi-ol.

Cyclo-hexadiene (dihydrobenzene), C_6H_8 .—Two isomers are possible, namely *cyclo*-hexadiene-1-3 and *cyclo*-hexadiene-1-4. A. v. Baeyer obtained what was probably a mixture of the two by heating 1-4 dibrom-*cyclo*-hexane with quinoline. C. Harries (*Ann.*, 1903, 328, p. 88) obtained them tolerably pure by the dry distillation of the phosphates of 1-3-diamino and 1-4-diamino-*cyclo*-hexane. The 1-3 compound boils at 81-82° C. and on oxidation yields succinic and oxalic acids. The 1-4 compound also boils at 81-82° C. and on oxidation gives succinic and malonic acids.

Alcohols.—*Cyclo*-hexanol, $\text{C}_6\text{H}_{12}\text{O}$, is produced by the reduction of the corresponding ketone, or of the iodhydrin of quinite. Nitric acid oxidizes it to adipic acid, and chromic acid to *cyclo*-hexanone. *Quinite* (*cyclo*-hexanediol-1-4) is prepared by reducing the corresponding ketone with sodium amalgam, *cis*-, and *trans*-modifications being obtained which may be separated by their acetyl derivatives. *Phloroglucite* (*cyclo*-hexane-triol-1-3-5) is obtained by reducing an aqueous solution of phloroglucin with sodium (W. Wislicenus, *Ber.*, 1894, 27, p. 357). *Quercite* (*cyclo*-hexane-pentol-1-2-3-4-5), isolated from acorns in 1849 by H. Braconnot (*Ann. chim. phys.* [3], 27,

p. 392), crystallizes in colourless prisms which melt at 234° C. When heated *in vacuo* to 240° C. it yields hydroquinone, quinone and pyrogallol. It is dextro-rotatory. A laevo-form occurs in the leaves of *Gymnema sylvestre* (F. B. Power, *Journ. Chem. Soc.*, 1904, 85, p. 624).

Inosite (*cyclo*-hexane-hexol), $\text{C}_6\text{H}_6(\text{OH})_6$.—The inactive form occurs in the muscles of the heart and in other parts of the human body. The *d*-form is found as a methyl ether in pinito (from the juice of *Pinus lambertina*, and of caoutchouc from *Mateza rorilina* of Madagascar), from which it may be obtained by heating with hydriodic acid. The *l*-form is also found as a methyl ether in quebrachite. By mixing the *d*- and *l*-forms, a racemic variety melting at 253° C. is obtained. A dimethyl ether of inactive inosite is dambonite which occurs in caoutchouc from Gabon.

Ketones.—*Cyclo*-hexanone, $\text{C}_6\text{H}_{10}\text{O}$, is obtained by the distillation of calcium pimelate, and by the electrolytic reduction of phenol, using an alternating current. It is a colourless liquid, possessing a peppermint odour and boiling at 155° C. Nitric acid oxidizes it to adipic acid. It condenses under the influence of sulphuric acid to form dodecahydrotriphenylene, $\text{C}_{12}\text{H}_{24}$, and a mixture of ketones (C. Mannul, *Ber.*, 1907, 40, p. 153). *Methyl-1-cyclo*-hexanone-3, $\text{CH}_3\text{C}_6\text{H}_9\text{O}$, is prepared by the hydrolysis of pulegone. It is an optically active liquid which boils at 168–169° C. Homologues of menthone may be obtained from the ketone by successive treatment with sodium amide and alkyl halides (A. Haller, *Comptes rendus*, 1905, 140, p. 127). On oxidation with nitric acid (sp. gr. 1.4) at 60-70° C., a mixture of —and—methyl adipic acids is obtained (W. Markownikoff, *Ann.*, 1905, 336, p. 299). It can be transformed into the isomeric *methyl-1-cyclo*-hexanone-2 (O. Wallach, *Ann.*, 1904, 329, p. 368). For *methyl-1-cyclo*-hexanone-4, obtained by distilling γ -methyl pimelate with lime, see O. Wallach, *Ber.*, 1906, 39, p. 1492.

Cyclo-hexane-dione-1-3 (dihydroresorcin), $\text{C}_6\text{H}_8\text{O}_2$, was obtained by G. Merling (*Ann.*, 1894, 278, p. 28) by reducing resorcin in hot alcoholic solution with sodium amalgam. *Cyclo*-hexane-dione-1-4 is obtained by the hydrolysis of succino-succinic ester. On reduction it yields quinite. It combines with benzaldehyde, in the presence of hydrochloric acid, to form 2-benzyl-hydroquinone. *Cyclo*-hexane-trione-1-3-5 (phloroglucin) is obtained by the fusion of many resins and of resorcin with caustic alkali. It may be prepared synthetically by fusing its dicarboxylic ester (from malonic ester and sodio malonic ester at 145° C.) with potash (C. W. Moore, *Journ. Chem. Soc.*, 1904, 85, p. 165). It crystallizes in prisms, which melt at 218° C. With ferric chloride it gives a dark violet coloration. It exhibits tautomerization, since in many of its reactions it shows the properties of a hydroxylic substance. *Rhodizonic acid* (dioxydiquinoyl), $\text{C}_6\text{H}_2\text{O}_6$, is probably the enolic form of an oxypentaketocyclo-hexane. It is formed by the reduction of triquinoyl by aqueous sulphurous acid, or in the form of its potassium salt by washing potassium hexa-oxybenzene with alcohol (R. Nietzki, *Ber.*, 1885, 18, pp. 513, 1838). *Triquinoyl* (hexaketocyclo-hexane) $\text{C}_6\text{O}_6\cdot 8\text{H}_2\text{O}$, is formed on oxidizing rhodizonic acid or hexa-oxybenzene. Stannous chloride reduces it to hexa-oxybenzene, and when boiled with water it yields croconic acid (dioxy-*cyclo*-pentene-trione).

Cyclo-hexenones.—Two types of ketones are to be noted in this group, namely the $\alpha\beta$ and $\beta\gamma$ ketones, depending upon the position of the double linkage in the molecule, thus:

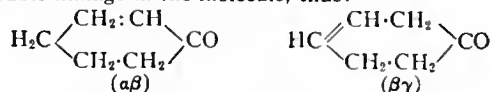

These two classes show characteristic differences in properties. For example, on reduction with zinc and alcoholic potash, the $\alpha\beta$ compounds give saturated ketones and also bi-molecular compounds, the $\beta\gamma$ being unaffected; the $\beta\gamma$ series react with hydroxylamine in a normal manner, the $\alpha\beta$ yield oxamino-oximes.

Methyl-1-cyclo-hexene-1-one-3, $\text{CH}_3\text{C}_6\text{H}_7\text{O}$, is obtained by condensing sodium aceto-acetate with methylene iodide, the ester so formed being then hydrolysed. *Isocamphorophorone*, $\text{C}_9\text{H}_{14}\text{O}$, is trimethyl 1-6-6-*cyclo*-hexene-1-one 6. *Isocamphor*, $\text{C}_{10}\text{H}_{16}\text{O}$, is methyl-1-isopropyl-3-*cyclo*-hexene-1-one 6.

Acids.—*Hexahydrobenzoic acid*, $\text{C}_6\text{H}_{11}\text{CO}_2\text{H}$, is obtained by the reduction of benzoic acid, or by the condensation of 1-5 dibrompentane with disodio-malonic ester. It crystallizes in small plates which melt at 30-31° C. and boil at 232-233° C. (J. C. Lumsden, *Journ. Chem. Soc.*, 1905, 87, p. 90). The sulphochloride of the acid on reduction with tin and hydrochloric acid gives *hexahydrothiophenol*, $\text{C}_6\text{H}_{11}\text{SH}$, a colourless oil which boils at 158-160° C. (W. Borsche, *Ber.*, 1906, 39, p. 392).

Quinic acid, $\text{C}_6\text{H}_7(\text{OH})_4\text{CO}_2\text{H}$ (tetra-oxy-*cyclo*-hexane carboxylic acid), is found in coffee beans and in quinia bark. It crystallizes in colourless prisms and is optically active. When heated to about 250° C. it is transformed into quinide, probably a lactone, which on heating with baryta water gives an inactive quinic acid.

Hexahydrophthalic acids, $\text{C}_6\text{H}_{10}(\text{CO}_2\text{H})_2$ (*cyclo*-hexanedicarboxylic acids).—Three acids of this group are known, containing the Carboxyl-groups in the 1-2, 1-3, and 1-4 positions, and each exists in two stereo-isomeric forms (*cis*- and *trans*-). The anhydride of the *cis*-1-2

acid, obtained by heating the anhydride of the *trans*-acid, forms prisms which melt at 192° C. When heated with hydrochloric acid it passes into the *trans*-variety. The racemic *trans*-acid is produced by the reduction of the dihydrobromide of Δ^5 -tetrahydrophthalic acid or $\Delta^{2,6}$ dihydrophthalic acid. It is split into its active components by means of its quinine salt (A. Werner and H. E. Conrad, *Ber.*, 1899, 32, p. 3046). *Hexahydroisophthalic acids* (cyclo-hexane-1,3-dicarboxylic acids) are obtained by the action of methylene iodide on disodio-pentane tetracarboxylic ester (W. H. Perkin, *Journ. Chem. Soc.*, 1891, 59, p. 798); by the action of trimethylene bromide on disodio-propane tetracarboxylic ester; and by the reduction of isophthalic acid with sodium amalgam, the tetrahydro acids first formed being converted into hydrobromides and further reduced (A. v. Baeyer and V. Villiger, *Ann.*, 1893, 276, p. 255). The *cis*- and *trans*-forms can be separated by means of their sodium salts. The *trans*-acid is a racemic compound, which on heating with acetyl chloride gives the anhydride of the *cis*-acid.

Hexahydroterephthalic acids (cyclo-hexane-1,4-dicarboxylic acids). These acids are obtained by the reduction of the hydrobromides of the di- and tetra-hydroterephthalic acids or by the action of ethylene dibromide on disodio-butane tetracarboxylic acid. An important derivative is *succino-succinic acid*, $C_6H_8O_2(CO_2H)_2$, or cyclo-hexanedione-2,5-dicarboxylic acid-1,4, which is obtained as its ester by the action of sodium or sodium ethylate on succinic ester (H. Fehling, *Ann.*, 1844, 49, p. 192; F. Hermann, *Ann.*, 1882, 211, p. 306). It crystallizes in needles or prisms, and dissolves in alcohol to form a bright blue fluorescent liquid, which on the addition of ferric chloride becomes cherry red. The acid on heating loses CO_2 and gives cyclo-hexanedione-1,4.

Tetrahydrobenzoic acid (cyclo-hexene-1-carboxylic acid-1), $C_6H_7CO_2H$. Three structural isomers are possible. The Δ^1 acid results on boiling the Δ^2 acid with alkalis, or on eliminating hydrobromic acid from 1-brom-cyclo-hexane-carboxylic acid-1. The Δ^2 acid is formed on the reduction of benzoic acid with sodium amalgam. The Δ^3 acid is obtained by eliminating the elements of water from 4-oxy-cyclo-hexene-1-carboxylic acid (W. H. Perkin, jun., *Journ. Chem. Soc.*, 1904, 85, p. 431). *Shikimic acid* (3,4,6-trioxy- Δ^1 -tetrahydrobenzoic acid) is found in the fruit of *Illicium religiosum*. On fusion with alkalis it yields para-oxybenzoic acid, and nascent hydrogen reduces it to hydroshikimic acid. *Sedanolic acid*, $C_{12}H_{20}O_2$, which is found along with sedanonic acid, $C_{12}H_{18}O_2$, in the higher boiling fractions of celery oil, is an ortho-oxyamyl- Δ^5 -tetrahydrobenzoic acid, sedanonic acid being ortho-valeryl- Δ^1 -tetrahydrobenzoic acid (G. Ciamician and P. Silber, *Ber.*, 1897, 30, pp. 492, 501, 1419 seq.). Sedanolic acid readily decomposes into water and its lactone sedanolid, $C_{12}H_{18}O_2$, the odorous constituent of celery oil.

Tetrahydrophthalic acids (cyclo-hexene dicarboxylic acids), $C_6H_5(CO_2H)_2$. Of the ortho-series four acids are known. The Δ^1 acid is obtained as its anhydride by heating the Δ^2 acid to 220° C., or by distilling hydroxypromellitic acid. Alkaline potassium permanganate oxidizes it to adipic acid. The Δ^2 acid is formed along with the Δ^4 acid by reducing phthalic acid with sodium amalgam in hot solutions. The Δ^4 acid exists in *cis*- and *trans*-forms. The *trans*-variety is produced by reducing phthalic acid, and the *cis*-acid by reducing $\Delta^{2,4}$ dihydrophthalic acid.

In the meta-series, four acids are also known. The Δ^2 acid is formed along with the Δ^4 (*cis*) acid by reducing isophthalic acid. The *trans* Δ^4 acid is formed by heating the *cis*-acid with hydrochloric acid under pressure. The Δ^3 acid is formed when the anhydride of tetrahydro rimesic acid is distilled (W. H. Perkin, jun., *Journ. Chem. Soc.*, 1905, 87, p. 293).

In the para-series, three acids are known. The Δ^1 acid is formed by the direct reduction of terephthalic acid; by boiling the Δ^2 acid with caustic soda; and by the reduction (in the heat) of $\Delta^{1,4}$ dihydroterephthalic acid. The Δ^2 acid exists in *cis*- and *trans*-forms; these are produced simultaneously in the reduction of $\Delta^{1,3}$ or $\Delta^{1,6}$ dihydroterephthalic acids by sodium amalgam.

There are five possible dihydrobenzoic acids. One was obtained in the form of its amide by the reduction of benzamide in alkaline solution with sodium amalgam (A. Hutchinson, *Ber.*, 1891, 24, p. 177). The $\Delta^{1,3}$ acid is obtained on oxidizing dihydrobenzaldehyde with silver oxide or by the reduction of meta-trimethylaminobenzoic acid (R. Willstätter, *Ber.*, 1904, 37, p. 1859).

Of the dihydrophthalic acids, five are known in the ortho-series, two of which are stereo-isomers of the *cis*- and *trans*-type, and a similar number are known in the para-series. The $\Delta^{1,4}$ acid is obtained as its anhydride by heating $\Delta^{2,4}$ dihydrophthalic anhydride

with acetic anhydride. When boiled with caustic soda it isomerizes to a mixture of the $\Delta^{2,4}$ and $\Delta^{2,6}$ dihydrophthalic acids. The $\Delta^{2,4}$ acid is obtained by boiling the dihydrobromide of the $\Delta^{2,6}$ acid with alcoholic potash or by continued boiling of the $\Delta^{2,6}$ acid with caustic soda.

The $\Delta^{2,6}$ acid is formed when phthalic acid is reduced in the cold by sodium amalgam or by heating the $\Delta^{2,4}$ and $\Delta^{3,6}$ acids with caustic soda. The *trans*-modification of $\Delta^{3,6}$ acid is produced when phthalic acid is reduced by sodium amalgam in the presence of acetic acid. When heated for some time with acetic anhydride it changes to the *cis*-form. The *trans*-acid has been resolved by means of its strychnine salts into two optically active isomerides, both of which readily pass to $\Delta^{2,6}$ dihydrophthalic acid (A. Neville, *Journ. Chem. Soc.*, 1906, 89, p. 1744).

Of the dihydroterephthalic acids, the $\Delta^{1,3}$ acid is obtained by heating the dibromide of the Δ^2 tetrahydro acid with alcoholic potash. It cannot be prepared by a direct reduction of terephthalic acid. On warming with caustic soda it is converted into the $\Delta^{1,4}$ acid. The $\Delta^{1,4}$ acid is also obtained by the direct reduction of terephthalic acid. It is the most stable of the dihydro acids. The $\Delta^{1,6}$ acid is obtained by boiling the *cis*- and *trans*- $\Delta^{2,5}$ acids with water, which are obtained on reducing terephthalic acid with sodium amalgam in faintly alkaline solution. The relationships existing between the various hydrophthalic acids may be shown as follows:—

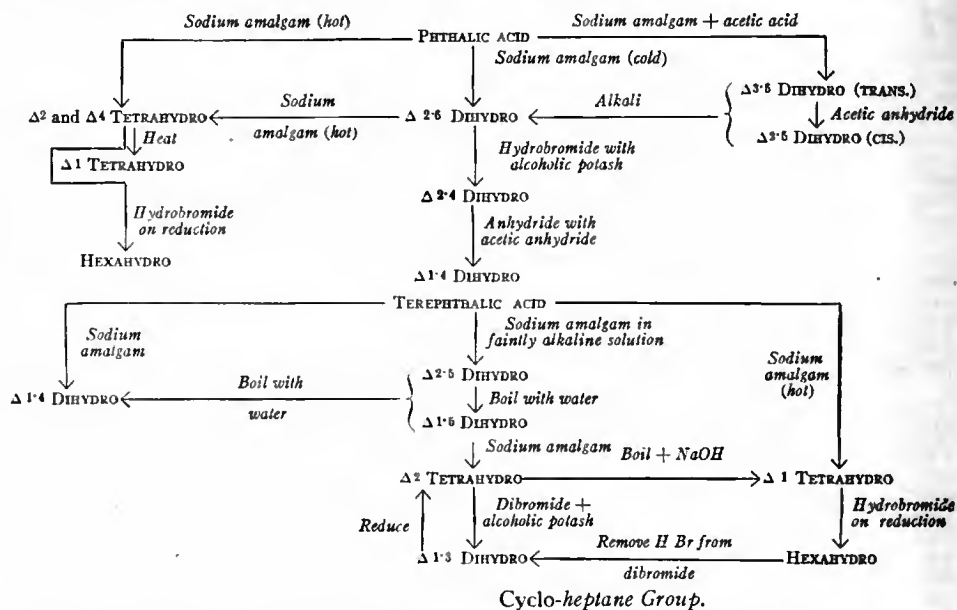

Cyclo-heptane (suberane), C_7H_{14} , obtained by the reduction of suberyl iodide, is a liquid which boils at 117° C. On treatment with bromine in the presence of aluminium bromide it gives chiefly pentabromtoluene. When heated with hydriodic acid to 230° C. it gives methylhexamethylene. On oxidation with nitric acid (sp. gr. 1.4) it yields pimelic acid. *Disuberyl*, $C_7H_{12} \cdot C_7H_{12}$, a thick oily liquid, boiling at 290–291° C., is obtained by the reduction of suberyl bromide.

Cyclo-heptene, C_7H_{12} , is obtained by the action of alcoholic potash on suberyl iodide; and from cyclo-heptane carboxylic acid, the amide of which by the action of sodium hypobromite is converted into cyclo-heptanamine, which, in its turn, is destructively methylated (R. Willstätter, *Ber.*, 1901, 34, 131). *Cyclo-heptadiene* 1,3, C_7H_{10} , is obtained from cyclo-heptene (Willstätter, *loc. cit.*). It is identical with the *hydrotropilidine*, which results by the destructive methylation of tropene.

Euterpene (trimethyl-1,4,4-cyclo-heptadiene 1,5), $C_{10}H_{16}$ is prepared from dihydroeucarveol. By the action of hydrobromic acid (in glacial acetic acid solution) and reduction of the resulting product it yields 1,2-dimethyl-4-ethylbenzene (A. v. Baeyer, *Ber.*, 1897, 30, p. 2075). *Cyclo-heptatriene* (tropilidine), C_7H_8 , is formed on distilling tropine with baryta; and from cyclo-heptadiene by forming its addition product with bromine and heating this with quinoline to 150–160° C. (R. Willstätter, *loc. cit.*). Chromic acid oxidizes it to benzoic acid and benzaldehyde. With bromine it forms a dibromide, which then heated to 110° C. decomposes into hydrobromic acid and benzyl bromide.

Cyclo-heptanol, $C_7H_{14}OH$, is formed by the reduction of suberone, and by the action of silver nitrite on the hydrochloride of cyclo-hexanamine (N. Demjanow, *Centralblatt*, 1904, i. p. 1214).

Cyclo-heptanone (suberone), $C_7H_{12}O$, is formed on the distillation of suberic acid with lime, and from α -brom-cyclo-heptane carboxylic acid by treatment with baryta and subsequent distillation over lead peroxide (R. Willstätter, *Ber.*, 1898, 31, p. 2507). It is a colourless liquid having a peppermint odour, and boiling at 178.5–179.5° C. Nitric acid oxidizes it to *n*-pimelic acid.

Tropilene, $C_7H_{10}O$, is obtained in small quantities by the distillation of α -methyltropine methyl hydroxide, and by the hydrolysis of β -methyltropidine with dilute hydrochloric acid. It is an oily liquid, with an odour resembling that of benzaldehyde. It forms a benzal compound, and gives an oxymethylene derivative and cannot be oxidized to an acid, reactions which point to it being a ketone containing the grouping $-CH_2-CO-$. It is thus to be regarded as a *cyclo-heptene-1-one-7*.

Cyclo-heptane carboxylic acid (suberanic acid), $C_7H_{12}CO_2H$, is obtained by the reduction of *cyclo-heptene-1-carboxylic acid*; from brom-*cyclo-heptane* by the Grignard reaction; and by the reduction of hydrotropilidene carboxylic acid by sodium in alcoholic solution (R. Willstätter, *Ber.*, 1898, 31, p. 2504). The corresponding oxyacid is obtained by the hydrolysis of the nitrile, which is formed by the addition of hydrocyanic acid to suberone (A. Spiegel, *Ann.*, 1882, 211, p. 117).

Four *cyclo-heptene carboxylic acids* are known. **Cyclo-heptene-1-carboxylic acid-1** is prepared from oxysuberanic acid. This acid when heated with concentrated hydrochloric acid to 120–130° C. yields a chlor-acid, which on warming with alcoholic potash is transformed into the *cyclo-heptene* compound. **Cyclo-heptene-2-carboxylic acid-1** is formed by the reduction of *cyclo-heptatriene 2:4:6-carboxylic acid-1*. On boiling with caustic soda it isomerizes to the corresponding 1-acid.

Cyclo-heptatriene carboxylic acids, $C_7H_7CO_2H$. All four are known. According to F. Buchner (*Ber.*, 1898, 31, p. 2242) they may be represented as follows:—

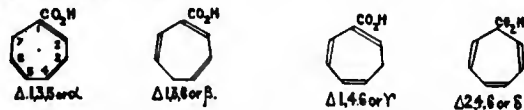

The α -acid (α -isophenylacetic acid) is obtained by the hydrolysis of pseudophenylacetamide, formed by condensing diazoacetic ester with benzene, the resulting pseudophenyl acetic ester being then left in contact with strong ammonia for a long time. β -Isophenylacetic acid is formed by strongly heating pseudophenylacetic ester in an air-free sealed tube and hydrolysing the resulting β -isophenylacetic ester. γ -Isophenylacetic acid is obtained by heating the β and δ acids for a long time with alcoholic potash (A. Einhorn, *Ber.*, 1894, 27, p. 2828; E. Buchner, *Ber.*, 1898, 31, p. 2249). δ -Isophenylacetic acid is obtained by heating the iodmethylate of anhydroegonine ester with dilute caustic soda (A. Einhorn, *Ber.*, 1893, 26, p. 329).

Numerous amino-derivatives of the *cyclo-heptane* series have been prepared by R. Willstätter in the course of his investigations on the constitution of tropine (*q.v.*). **Amino-cyclo-heptane** (suberylamine) is obtained by the reduction of suberone oxime or by the action of sodium hypobromite on the amide of cycloheptane carboxylic acid.

Cyclo-octane Group.

Few members of this group are known. By the distillation of the calcium salt of azelaic acid H. Mayer (*Ann.*, 1893, 275, p. 363) obtained azelain ketone, $C_8H_{14}O$, a liquid of peppermint odour. It boils at 90–91° C. (23 mm.) and is readily oxidized by potassium permanganate to oxysuberic acid. It is apparently *cyclo-octanone* (see also W. Miller and A. Tschitschkin, *Centralblatt*, 1899, 2., p. 181).

Pseudopelletierine (methyl granatonine), $C_9H_{15}NO$, an alkaloid of the pomegranate, is a derivative of *cyclo-octane*, and resembles tropine in that it contains a nitrogen bridge between two carbon atoms. It is an inactive base, and also has ketonic properties. On oxidation it yields methyl granatic ester, which, by the exhaustive methylation process, is converted into homopiperylene dicarboxylic ester, $HO_2C-CH:CH-CH_2-CH_2-CH:CH-CO_2H$, from which suberic acid may be obtained on reduction. When reduced in alcoholic solution by means of sodium amalgam it yields methyl granatoline, $C_8H_{13}OH-NCH_3$; this substance, on oxidation with cold potassium permanganate, is converted into granatoline, $C_8H_{15}NO$, which on distillation over zinc dust yields pyridine. Methyl granatoline on treatment with hydriodic acid and red phosphorus, followed by caustic potash, yields methyl granatinine, $C_9H_{15}N$, which when heated with hydriodic acid and phosphorus to 240° C. is converted into methyl granatanine, $C_8H_{14}NCH_3$, and granatanine, $C_8H_{14}NH$. The hydrochloride of the latter base when distilled over zinc dust yields α -propyl pyridine. By the electrolytic reduction of pseudopelletierine, *N*-methyl granatanine is obtained, and this by exhaustive methylation is converted into Δ^2 -dimethyl granatanine. This latter compound readily forms an iodmethylate, which on treatment with silver oxide yields the corresponding ammonium hydroxide. The ammonium hydroxide on distillation decomposes into trimethylamine, water and *cyclo-octadiene-1:3*.

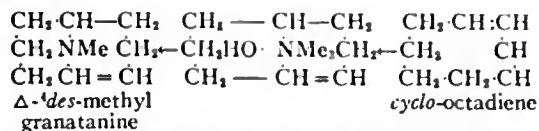
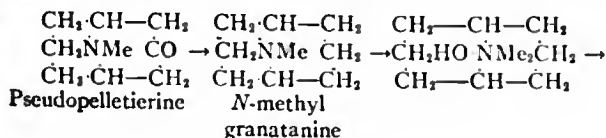

Cyclo-octadiene, C_8H_{12} , as above prepared, is a strong-smelling oil which decolorizes potassium permanganate solution instantaneously. It readily polymerizes to a di-*cyclo-octadiene* and polymer ($C_{16}H_{24}$). (R. Willstätter, *Ber.*, 1905, 38, pp. 1975, 1984; G. Ciamician and P. Silber, *Ber.*, 1893, 26, p. 2750; A. Piccinini, *Gazz.*, 1902, 32, 1 p. 260). β -*cyclo-octadiene* has been prepared from methyl granatinine iodmethylate.

Cyclo-octane, C_8H_{16} is obtained by the reduction of the above unsaturated hydrocarbon by the Sabatier and Senderens's method. It is a liquid which boils at 146.3–148° C. and possesses a strong camphor odour. On oxidation it yields suberic acid (R. Willstätter, *Ber.*, 1907, 40, pp. 957). O. Doebner (*Ber.*, 1902, 35, pp. 2129, 2538; 1903, 36, p. 4318) obtained compounds, which in all probability are *cyclo-octadienes*, by the distillation of β -vinylacrylic acid, sorbic acid, and cinnamyl acrylic acid with anhydrous baryta.

Cyclo-nonane Group.

According to N. Zelinsky (*Ber.*, 1907, 40, p. 780) *cyclononane*, $C_9H_{18}O$, a liquid boiling at 95–97° C., is formed on distilling sebacic acid with lime, and from this, by reduction to the corresponding secondary alcohol, conversion of the latter into the iodide, and subsequent reduction of this with zinc, *cyclo-nonane*, C_9H_{18} , a liquid boiling at 170–172° C. is obtained.

POLYNESIA, (Gr. *πολύς*, many, and *νήσος*, island), a term sometimes used to cover the whole of the oceanic islands in the central and western Pacific, but properly for the eastern of the three great divisions of these islands. The chief groups thus included are Hawaii, the Ellice, Phoenix, Union, Manihiki and Marquesas groups, Samoa and Tonga, the Cook, Society, Tubuai and Tuamotu groups, and many other lesser islands. (See PACIFIC OCEAN, section on *Island*, and separate articles on the principal groups, &c.)

The Polynesian Race.—For the ethnological problems offered by Polynesia no thoroughly satisfactory solutions have yet been found. By some the term Polynesian has been treated as a synonym for Malayo-Polynesian, and has been made to include all the brown races of Malaysia, Melanesia, Micronesia and Polynesia. Linguistically, physically and mentally this view is untenable. Whatever be the origin of the Polynesians, they are not Malays, though, themselves of mixed blood, they have probably certain racial elements in common with the latter, who are undoubtedly hybrids. There is every reason to believe that the Polynesians are ethnologically a far older race than the Malays, who, as they now exist, are a comparatively modern people; and thus Friedrich Müller's and D. G. Brinton's theory, that they form a branch of the Malays, fails. Joseph Deniker declares the Polynesians a separate ethnic group of the Indo-Pacific area, and in this view he is followed by A. H. Keane, who suggests that they are a branch of the Caucasian division of mankind who possibly migrated in the Neolithic period from the Asiatic mainland. Of the migration itself no doubt is now felt, but the first entrance of the Polynesians into the Pacific must have been an event so remote that neither by tradition nor otherwise can it be even approximately fixed. The journey of these Caucasians would naturally be in stages. Their earliest halting place was probably the Malay Archipelago, where a few of their kin linger in the Mentawi Islands on the west coast of Sumatra. Thence at a date within historic times a migration eastward took place. The absence of Sanskrit roots in the Polynesian languages appears to indicate that this migration was in pre-Sanskritic times. Whether anything like a definite date can be fixed for it may well be questioned. Abraham Fornander¹ has, however, with great probability, traced back the history of the Hawaiians to the 5th century. He has studied the folk-lore of those islands exhaustively, and from this source comes to the conclusion that the Polynesian migration from the Indian Archipelago may be approximately assigned to the close of the 1st or to the 2nd century. The traditions of many of the Polynesian peoples tend to make Savaii, the largest of the Samoan Islands, their ancestral home in the East Pacific, and linguistic and other evidence goes to

¹ *An Account of the Polynesian Race* (1878), i. 168.

support the theory that the first Polynesian settlement in the East Pacific was in Samoa, and that thence the various branches of the race made their way in all directions. Most likely Samoa was the first group permanently occupied by them. Owing to the admixture of the Polynesians with the Papuans in Fiji some authorities have thought the first settlement was in those islands, and that the settlers were eventually driven thence by the Papuan occupiers. We can, however, account for the presence of Polynesian blood in Fiji in another way, viz. by the intercourse that has been kept up between the people of Tonga and Fiji. If the first resting-place of the Polynesians was in that group, there is good reason to believe that Samoa was the first permanent home of the race.

It used to be doubted whether these people could have gone from the Indian archipelago so far eastward, because the prevailing winds and currents are from the east. But it is now well known that at times there are westerly winds in the region over which they would have to travel, and that there would be no insuperable difficulties in the way of such a voyage. The Polynesians are invariably navigators. There is ample evidence that in early times they were much better seamen than they are at present. Indeed their skill in navigation has greatly declined since they have become known to Europeans. They used to construct decked vessels capable of carrying one or two hundred persons, with water and stores sufficient for a voyage of some weeks duration. These vessels were made of planks well fitted and sewn together, the joints being caulked and pitched.¹ It is only in recent times that the construction of such vessels has ceased. The people had a knowledge of the stars, of the rising and setting of the constellations at different seasons of the year; by this means they determined the favourable season for making a voyage and directed their course.

The Polynesians were by no means a savage people when they entered the Pacific. Indeed their elaborate historical legends show that they possessed a considerable amount of civilization. Those who are familiar with these legends, and have studied native manners and customs, see many unmistakable proofs that the Polynesians had, at their migration, considerable knowledge and culture, and that the race has greatly deteriorated.

The Polynesians are physically a very fine race. On some islands they average 5 ft. 10 in. in height. De Quatrefages, in a table giving the stature of different races of men,² puts the natives of Samoa and Tonga as the tallest people in the world. He gives 5 ft. 9.92 in. as their average height. They are well developed in proportion to their height. Their colour is a brown, lighter or darker generally according to the amount of their exposure to the sun—being darker on some of the atolls where the people spend much time in fishing, and among fishermen on the volcanic islands, and lighter among women, chiefs and others less exposed than the bulk of the people. Their hair is dark brown or black; smooth and curly, very different from the frizzly mop of the Papuan or the lank straight locks of the Malay. They have very little beard. Their features are generally fairly regular and often beautiful; eyes invariably black, and in some persons oblique; jaws not projecting, except in a few instances; lips of medium thickness; the noses are naturally long, well shaped and arched, but many are artificially flattened at the bridge in infancy. Their foreheads are fairly high, but rather narrow. The young of both sexes are good-looking. The men often have more regular features than the women. Formerly the men paid more attention to personal appearance than the women. Polynesians generally are of singularly cleanly habits, love bathing, and have a taste for neatness and order. Their clothing is simple: a loin cloth for the men and for the women a girdle or petticoat of leaves. Sometimes women cover the shoulders, and on great occasions the men robe themselves in *tapa*, bark-cloth. The men are usually

tattooed in elaborate designs from the navel to the thigh, and often around mouth and eyes.

As a race the Polynesians are somewhat apathetic. An enervating climate and lavish natural resources incline them to lead easy lives. On the more barren islands, and on those more distant from the equator, they show more energy. Under certain circumstances they become excitable, and manifest a kind of care-for-nothing spirit. As savages they were strict in their religious observances and religion came into almost every action of life, and they have been, in most instances, easily led to accept Christianity. Their essential trait is their perennial cheerfulness, and their fondness for dance and song and every sort of amusement.³ They are shrewd, intelligent and possess much common sense. Where they have from early years enjoyed the advantages of a good education, Polynesian youths have proved themselves to possess intellectual powers of no mean order. They are almost invariably fluent speakers; with many of them oratory seems to be a natural gift; it is also carefully cultivated. An orator will hold the interest of his hearers for hours together at a political gathering, and in his speech he will bring in historical allusions and precedents, and will make apt quotations from ancient legends in a manner which would do credit to the best parliamentary orators. Many of them are very brave, and think little of self-sacrifice for others where duty or family honour is concerned.

Polynesian society is divided into the family and the clan. Each clan has a name which is usually borne by one of the oldest members, who is the chief or head for the time being. This clan system no doubt generally prevailed in early times, and was the origin of the principal chieftainships. But changes have been made in most of the islands. In some the head of one clan has become king over several. In many cases large clans have been divided into sections under secondary heads, and have even been subdivided.

As a rule near relations do not intermarry. In some islands this rule is rigidly adhered to. There have been exceptions, however, especially in the case of high chiefs; but usually great care is taken to prevent the union of those within the prescribed limits of consanguinity. Children generally dwell with their kin on the father's side, but they have equal rights on the mother's side, and sometimes they take up their abode with their mother's family. The only names used to express particular relationships are father and mother, son and daughter, brother and sister. There is usually no distinction between brothers (or sisters) and cousins, all the children of brothers and sisters speak of each other as brothers and sisters, and they call uncles and aunts fathers and mothers. Above the relationship of parents all are simply ancestors, no term being used for grandfather which would not equally apply to any more remote male ancestor. In the same way there is no distinctive term for grandchild. A man speaks of his grandchild as his son or daughter, or simply as his child.⁴ Polygamy was often practised, especially by chiefs, and also concubinage. In some places a widow was taken by the brother of her deceased husband, or, failing the brother, by some other relative of the deceased, as an additional wife. Divorce was an easy matter, and of frequent occurrence; but, as a rule, a divorced wife would not marry again without the consent of her former husband. An adulterer was always liable to be killed by the aggrieved husband, or by some member of his clan. If the culprit himself could not be reached, any member of the clan was liable to suffer in his stead. In some islands female virtue was highly regarded. Perhaps of all the groups Samoa stood highest in this respect. There was a special ordeal through which a bride passed to prove her virginity, and a proof of her immorality brought disgrace upon all her relatives. But in other islands there was much freedom in the relations of the sexes. Owing to the almost promiscuous intercourse which prevailed among a portion of the race, in some groups titles descended through the mother and not through the father. In Hawaii there was a peculiar system of marriage

³ Wrestling and boxing, a kind of hockey and football, canoe and foot races, walking-matches, swimming, archery, cockfighting, fishing-matches and pigeon-catching are among their pastimes. Of indoor games they have a number, many being of a gambling nature. Much time is spent, especially after the evening meal, in asking riddles, in rhyming, &c. The recital of songs and myths is a common amusement, and on special occasions there is dancing. The night-dances were generally accompanied by much indecency and immorality.

⁴ Dr Lewis H. Morgan, in *Ancient Society*, pp. 419-423, makes the Polynesians to have distinctive terms for grandfather, grandmother, grandson and granddaughter. In this he is mistaken. It is evident from his own lists that the Hawaiian *kupuna* means simply an ancestor. In like manner *moopuna* simply means a descendant of any generation after the first.

¹ Coco-nut fibre and the gum which exudes from the bread-fruit tree are generally used for "caulking" and "pitching" canoes.

² *The Human Species* (International Scientific Series), pp. 57-60.

relationship," brothers with their wives, and sisters with their husbands, possessing each other in common." There also, especially in the case of chiefs and chieftainesses, brothers and sisters sometimes intermarried. But these customs did not prevail in other groups. It is almost certain that they did not prevail in Hawaii in early times, but that they were the result of that deterioration in the race which their traditions and many of their customs indicate.¹

Women have always occupied a relatively high position among the Polynesians. In most groups they have great influence and are treated with much respect. In some cases they take hereditary titles and hold high offices. As among their congeners in Madagascar, so also in parts of Polynesia, there may be a queen or a chieftainess in her own right; and a woman in high position will command as much respect, and will exercise as great authority, as a man would in the same position. Everywhere infanticide prevailed; in some of the smaller islands it was regulated by law in order to prevent over-population. It was also a very common practice to destroy the foetus, but parents were affectionate towards their children. The practice of adopting children was, and still is, common. Often there is an exchange made between members of the same clan; but sometimes there is adoption from without. Tattooing generally prevailed among the men, different patterns being followed in different groups of islands. In some a larger portion of the body is tattooed than in others. A youth was considered to be in his minority until he was tattooed, and in former times he would have no chance of marrying until he had, by submitting to this process, proved himself to be a man. Puberty in the other sex was generally marked by feasting, or some other demonstration, among the female friends. Old age is generally honoured. Often an inferior chief will give up his title to a younger man, yet he himself will lose but little by so doing. The neglect of aged persons is extremely rare.

Property belonging to a clan is held in common. Each clan usually possesses land, and over this no one member has an exclusive right, but all have an equal right to use it. The chief or recognized head of the clan or section alone can properly dispose of it or assign its use for a time to an outsider; and even he is expected to obtain the consent of the heads of families before he alienates the property. Thus land is handed down through successive generations under the nominal control of the recognized head of the clan. Changes have been made in many islands in this respect; but there can be little reason to doubt that the joint ownership of property in clans was common among the entire race in former times.

In early times the head of each clan was supreme among his own people, but in all matters he had associated with him the principal men or heads of families in the clan. Their united authority extended over all the members and the possessions of the clan, and they were independent of every other clan. There are in some places vestiges of this primitive state of society still remaining; the transition to a limited or to a despotic monarchy may be traced by means of the ancient legends in some islands, and in others it is a matter of recent history. One clan being more numerous and stronger than another, and its chief being ambitious, it is easy to see how by conquering a neighbouring clan he increased the importance of his clan and extended his own power. In some of the islands this transition process has hardly yet developed into an absolute monarchy. We may even see two or three stages of the progress. In one instance a certain clan has the right to nominate the principal chief over an entire district; though it is known as the ruling clan, its rule is mainly confined to this nomination, and to decision for or against war. In all other respects the district enjoys the privilege of self-government. In another case the nominal king over a district, or over an entire island, can be elected only from among the members of a certain clan, the monarchy being elective within that alone; but this king has little authority. In other cases a more despotic monarchy has grown up—the prowess of one man leading to the subjugation of other clans. Even in this case the chiefs or

heads of clans sometimes still hold their property and rule over their own people, only rendering a kind of feudal service and paying tribute to the king.

The Polynesians are exceedingly fond of rank and of titles. Much deference is paid to chiefs and to persons of rank; and special terms are generally employed in addressing these. Every part of a chief's body and all his belongings have names different from those employed for common people. The grade of rank which a person occupies will often be indicated by the language in which he is addressed. Thus, in Samoa there are four different terms for *to come*: *sau* is for a common man; *malu mai* is a respectful term for a person without a title; *susu mai* for a titled chief; and *afio mai* for a member of the royal family. In addressing chiefs, or others to whom one wishes to be respectful, the singular number of the personal pronoun is rarely used; the dual is employed instead,—the dual of dignity or of respect.

Offices and titles are seldom hereditary in our sense of the term, as descending from father to son. They are rather elective within the limits of the clan, or the division of a clan. A common practice is for the holder of a high title to nominate a successor; and his nomination is generally confirmed by the chiefs, or heads of households, with whom the right of election rests. In ancient times the authority of a high chief or king did not usually extend to any details of government. But in Hawaii there are traditions of a wise king who interested himself in promoting the social well-being of the people, and made good laws for their guidance.² Usually all matters affecting a district or an island were settled by the chiefs of the district, while those of a single village were settled by a council consisting of the chiefs and heads of households in the village. In some islands each clan, or each village, would feel itself at liberty to make war on another clan or village without consulting the views of any higher authority. Indeed the rule was for each clan or district to settle its own affairs. In the case of offences against individuals, either the person injured, or another member of his clan, would avenge the injury done. For most offences there was some generally recognized punishment—such as death for murder or adultery; but often vengeance would fall upon another person instead of the wrongdoer. In avenging wrong, a member of the village or of the clan to which the offender belonged would serve equally well to satisfy their ideas of justice if the culprit himself could not be easily reached. Sometimes all the members of the family, or of a village, to which a culprit belonged would flee from their homes and take refuge in another village, or seek the protection of a powerful chief. In some places, in cases of crime, the members of the family or village would convey the culprit bound—sometimes even carrying him like a pig that is to be killed—and place him with apologies before those against whom he had transgressed. The ignominy of such a proceeding was generally considered sufficient atonement for the gravest offences. There were slaves in many islands, either persons conquered in war, or those who had been condemned to lose their personal liberty on account of evil conduct.

Pottery was not manufactured by the Polynesians: a fact which, it has been argued, goes far to prove the remoteness of the Polynesian migration from the Malay Archipelago, where there is not a single tribe which does not possess the art. It may, however, be that, moving among small coral islands for scores of generations and thus without materials, they lost the art. Those of them who possessed pottery obtained it from the Papuans. In most of their manufactures they were, however, in advance of the Papuans. They made use of the vegetable fibres abounding in the islands, the women manufacturing cloth, chiefly from the bark of the paper mulberry (*Morus papyrifera*), but also in some islands from the bark of the bread-fruit tree and the hibiscus. This in former times furnished them with most of their clothing. They also made various kinds of mats, baskets and fans from the leaves of the pandanus, the bark of the hibiscus, from species of böhmeria or other Urticaceous plants. Some of their mats are very beautifully made, and in some islands they are the most valuable property the people possess. The people also use the various fibre-producing plants for the manufacture of ropes, coarse string and fine cord, and for making fishing nets. The nets are often very large, and are netted with a needle and mesh as in hand-netting among ourselves.

The Polynesians, who have always been entirely without metals, are clever workers in wood. Canoe and house building are trades usually confined to certain families. The large canoes in which they formerly made long voyages are no longer built, but various kinds of smaller canoes are made, from the commonest, which is simply a hollowed-out tree cut into form, to the finely shaped one built upon a keel, the joints of the various pieces being nicely fitted, and the whole stitched together with cord made from the husk of coconuts. Some of the larger canoes are ornamented with rude carving; and in some islands they are somewhat elaborately decorated with inlaid mother-of-pearl. The houses are generally well and elaborately made, but nearly all the ornamentation is put on the inside of the roof.

They manufacture several wooden utensils for household use.

¹ Morgan has founded one of his forms of family—the consanguine—on the supposed existence in former times among the Malays and Polynesians of the custom of "intermarriage of brothers and sisters, own and collateral, in a group." All the evidence he finds in support of this is (1) the existence of the custom above mentioned in Hawaii; and (2) the absence of special terms for the relationship of uncle, aunt and cousin, this indicating, he thinks, that these were regarded as fathers, mothers, brothers and sisters. He admits that "the usages with respect to marriage which prevailed when the system was formed may not prevail at the present time." But he adds, "To sustain the deduction it is not necessary that they should" (*Ancient Society*, p. 408). Morgan has given special terms for grandfather and grandmother, because it would prove too much to show that the people had no grandfathers, &c. But these terms are used for ancestors of any generation. The terms used for grandchildren, in like manner, are used for any generation of descendants. He says (p. 406) the terms of husband and wife are used in common by a group of sisters or brothers, but the fact is that the words used for husband and wife in Hawaii simply mean male and female. In some islands there are terms used for wife in the most strict sense. The word wife is not used more exclusively among us than among some Polynesian people.

² See a remarkable example in Fornander's *Account of the Polynesian Race*, ii. 89.

such as dishes or deep bowls, head-rests and stools. Having no metal or other vessels in which to boil water, all cooking is done by baking, generally in holes in the ground. They also make wooden gongs, or drums. They used to make wooden fishhooks, clubs, spears and bows. They still make wooden fishspears and carved and inlaid combs. They employ the bamboo for making drums and flutes. Formerly knives were made of bamboo, which is still sometimes used for that purpose. In the manufacture of these things they employed adzes made of stone, shell or hard wood, and a wooden drill pointed with stone, shell or bone. They made mother-of-pearl fishhooks, and they still use a part of those old hooks—or artificial bait—in combination with steel hooks, the native-made portion being generally shaped like a small fish. For water-vessels, &c., they employ gourds and large coco-nut shells, in preparing which they pour in water and allow the pulp or the kernel to decay, so that it may be removed without breaking the rind or shell. Their drinking cups are made of half a coco-nut shell. Sharks' teeth, shells and bamboo were formerly generally used as cutting instruments for shaving and surgical operations. They employ vegetable dyes for painting their bark-cloth, calabashes, &c. In some islands they also use a red earth for this purpose. Their cloth is generally ornamented with geometrical patterns. Any drawings of animals, &c., which they make are exceedingly inartistic, and no attempt is made at perspective. Their musical instruments are few and rude—consisting of the drums and flutes already mentioned, and shell trumpets.

The Polynesians were all polytheists. Without doubt many of their gods are deified men; but it is clear that some are the forces of Nature personified, while others appear to represent human passions which have become identified with particular persons who have an existence in their historical myths.¹ But the conception which they had of Tangaloa (Taaroa and Kanaloa in some islands) is of a higher order. Among the Tahitians he was regarded as "the first and principal god, uncreated and existing from the beginning, or from the time he emerged from *po*, or the world of darkness."² "He was said to be the father of all the gods, and creator of all things, yet was scarcely reckoned an object of worship."³ Dr Turner says, "the unrestricted, or unconditioned, may fairly be regarded as the name of this Samoan Jupiter."⁴

The worship of certain of the great gods was common to all the people in a group of islands. Others were gods of villages or of families, while others were gods of individuals. The gods of clans were probably the spirits of the ancestors in their own line. In some islands, when the birth of a child was expected, the aid of the gods of the family was invoked, beginning with the god of the father. The god prayed to at the instant of birth became the god of the child. In other places the name of the child's god was declared when the umbilical cord was severed. The gods were supposed to dwell in various animals, in trees, or even in inanimate objects, as a stone, a shell, &c. In some islands idols bearing more or less resemblance to the human shape were made. But in all cases the material objects were regarded simply as the abodes of the immaterial spirits of the gods.

Their temples were either national, for a single village, or for the god of a family. They were sometimes large stone enclosures (*marae*), sometimes a grove, or a house. The principal priests were a particular order, the priesthood being hereditary. In some cases, however, the father of a family was priest in his own household and presented offerings and prayers to the family god.

In some islands human sacrifices were of frequent occurrence; in others they were offered only on very rare and exceptional occasions, when the demand was made by the priests for something specially valuable. The usual offerings to the gods were food. The system of *taboo* was connected with their religious rites. There were two ways by which things might become *taboo*: (1) by contact with anything belonging to the god, as his visible representation or his priest. Probably it was thought that a portion of the sacred essence of the god, or of a sacred person, was directly communicable to objects which they touched. (2) Things were made *taboo* by being dedicated to the god; and it is this form of *taboo* which is still kept up. If, e.g., any one wishes to preserve his coco-nuts from being taken, he will put something upon the trees to indicate that they are sacred or dedicated. They cannot then be used until the *taboo* is removed. Disease and death were often connected with the violation of *taboo*, the offended gods thus punishing the offenders. Disease was generally attributed to the anger of the gods. Hence offerings, &c., were made to appease their anger. The first-fruits of a crop were usually dedicated to the gods to prevent them from being angry; and new canoes, fishing-nets, &c., were dedicated by prayers and offerings, in order that the gods might be propitious to their owners in their use.

¹ The following books may be consulted on this subject: Rev. W. W. Gill's *Myths and Songs from the South Pacific*; Dr Turner's *Samoa*; and Mr Shortland's *Maori Religion and Mythology*; Sir George Grey, *Polynesian Mythology*.

² *Polynesian Researches* i. 323.

³ *Tahitian Dictionary*.

⁴ *Samoa*, p. 52.

The Polynesians invariably believe in the existence of the spirit of man after the death of the body. Their traditions on the condition of the dead vary considerably in different groups; yet there is a general agreement upon main points. Death is caused by the departure of the spirit from the body. The region of the dead is subterranean. When the spirit leaves the body it is conveyed by waiting spirits to the abode of spirits. In most islands the place of descent is known. It is generally towards the west. In some traditions there is a distinction between chief and common people in the spirit world. In others all are much alike in condition. Some traditions indicate a marked distinction between the spirits of warriors and those of others: the former go to a place where they are happy and are immortal, while the latter are devoured by the gods and are annihilated. In some, however, the spirits are said to live again after being eaten. Some speak of the abode of spirits as being in darkness; but usually the condition of things is similar to that which exists upon earth. Amongst all the people it is believed that the spirits of the dead are able to revisit the scenes of their earthly life. The visits are generally made in the night, and are often greatly dreaded, especially when there may be any supposed reason for spite on the part of the dead towards living relatives. Some writers have connected Polynesian cannibalism with religion. In the Cook and Society Islands, when a human being was offered as a sacrifice, the priest presented an eye of the victim to the king, who either ate it or pretended to do so. Probably the earliest human sacrifices were the bodies of enemies slain in battle. As it was supposed by some that the spirits of the dead were eaten by the gods, the bodies of those slain in battle may have been eaten by their victors in triumph. Mr Shortland appears to think that cannibalism among the Maories of New Zealand may have thus originated.⁵ Among the Polynesians generally it appears to have been the practice at times to eat a portion of a slain enemy to make his degradation the greater. But where cannibalism was practised as a means of subsistence, it probably originated in times of actual want, such as may have occurred during the long voyages of the people.

The Polynesian race has been continuously, and in some places rapidly, decreasing since their first contact with Europeans. Doubts have been thrown on the current statements regarding the rate of decrease, which some good authorities believe to be not so great as is commonly represented. They hold that former estimates of the number of inhabitants in the various insular groups were mere guesswork. Thus it is pointed out that Cook's estimate of 240,000 for the Society Archipelago (Tahiti) was at the time reduced by his associate, Forster, to 150,000, so that the 300,000 credited by him to the Sandwich Islands should also be heavily discounted. That is probably true, and it may be admitted that, as a rule, the early calculations erred on the side of excess. But when full allowance is made for all such exaggerations, the following facts will show that the decrease has been excessive. The Tahitians, 150,000 in 1774, fell from 17,000 in 1880 to 10,300 in 1899; and in this group, while the pure stock appears to be dying out, there is a small increase amongst the half-breeds. When New Zealand was occupied (1840) the Maori were said to number 120,000, and were doubtfully stated to be still 56,000 in 1857; since then the returns of the 1881 and 1891 censuses gave 44,000 and 40,000 respectively. During the last two decades of the 19th century the decrease has been from 30,000 to 17,500 in Tonga; from 11,500 to 8400 in the Cook group; from 8000 to 3600 in Wallis; from 1600 to 100 in Manahiki; from 1400 to 1000 in Tubuai; and from 600 to 100 in Easter Island. A general decline seems thus to be placed beyond doubt, though it may be questioned whether it is to be attributed to a decayed vitality, as some hold, or to external causes, as is the more general opinion. The prevalence of elephantiasis and the occurrence of leprosy, for instance, in Hawaii, would seem to point at least in some places to a racial taint, due perhaps to the unbridled licentiousness of past generations. On the other hand, such a decrease as has occurred in Tahiti and Tonga, can be accounted for only by an accumulation of outward causes, such as wars, massacres, and raidings for the Australian and South American labour markets before this traffic was suppressed or regulated. Other destructive agencies were epidemics, such especially as measles and small-pox, which swept away 30,000 Fijians in 1875; the introduction of strong drinks, including, besides vile spirits, a most pernicious concoction brewed in Tahiti from oranges;

⁵ *Maori Religion and Mythology*, p. 26.

the too sudden adoption of European clothing, rendering the body supersensitive to changes of temperature; lastly, the action of over-zealous missionaries in suppressing the dances, merry-making and free joyous life of pagan times, and the preaching of a sombre type of Christianity, with deadening effects on the buoyant temperament of these children of Nature. Most of these abuses have been checked or removed, and the results may perhaps be detected in a less accelerated rate of decline, which no longer proceeds in geometric proportion, and seems even almost arrested in some places, as in Samoa and New Zealand. If such be indeed the case, perhaps the noblest of all primitive races may yet be saved from what at one time seemed inevitable extinction; and the Maori, the Samoans, and Tahitians may, like the Hawaiians, take their place beside the Europeans as free citizens of the various states of which they are now subjects.

AUTHORITIES.—Jean L. A. de Quatrefages, *Les Polynésiens et leur migrations* (Paris, 1866); G. Turner, *Nineteen Years in Polynesia* (London, 1861); Pierre Adolphe Lesson, *Les Polynésiens, leur origine, &c.* (Paris, 1880-1884); Henri Mager, *Le Monde polynésien* (Paris, 1902); Maximilien Albert H. A. Le Grand, *Au pays des Canaques* (Paris, 1893); Sir George Grey, *Polynesian Mythology* (London, 1855); T. A. Moerenhout, *Voyages aux îles du Grand Océan, &c.* (Paris, 1837); Abraham Fornander, *An Account of the Polynesian Race* (1878). The account given above reproduces the main descriptive passages in the Rev. S. J. Whitmee's article in the 9th ed. of the *Ency. Brit.*

POLYP, the name given by zoologists to the form of animal especially characteristic of the subphylum Cnidaria of the Coelentera (*q.v.*). In the subdivision Anthozoa, comprising the sea-anemones and corals, the individual is always a polyp; in the Hydrozoa, however, the individual may be either a polyp or a medusa (*q.v.*).

A good example of a polyp may be seen in a common sea-anemone or in the well-known fresh-water polyp, *Hydra* (fig. 1). The body may be roughly compared in structure to

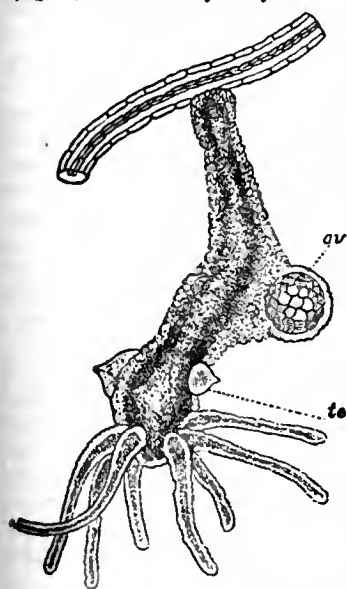

FIG. 1.—*Hydra viridis*, the fresh-water polyp. The animal is attached to the stem of a plant, and is represented with the base of attachment uppermost; the mouth, not actually seen in the drawing, is at the lower extremity of the body, surrounded by the circle of tentacles. *ov*, Ovary; *te*, testis.

some cases the tentacle may become solid by obliteration of its cavity. The tentacles are organs which serve both for the tactile sense and for the capture of food. By means of the stinging nettle-cells or nematocysts with which the tentacles are thickly covered, living organisms of various kinds are firmly held and at the same time paralysed or killed, and by means of longitudinal muscular fibrils formed from the cells of the ectoderm the

tentacles are contracted and convey the food to the mouth. By means of circularly disposed muscular fibrils formed from the endoderm the tentacles can be protracted or thrust out after contraction. By muscle-fibres belonging to the same two systems the whole body may be retracted or protruded.

We can distinguish therefore in the body of a polyp the column, circular or oval in section, forming the trunk, resting on a base or foot and surmounted by the crown of tentacles, which enclose an area termed the *peristome*, in the centre of which again is the mouth. As a rule there is no other opening to the body except the mouth, but in some cases excretory pores are known to occur in the foot, and pores may occur at the tips of the tentacles. Thus it is seen that a polyp is an animal of very simple structure.

The name polyp was given to these organisms from their supposed resemblance to an octopus (Fr. *poulpe*), with its circle of writhing arms round the mouth. This comparison, though far-fetched, is certainly more reasonable than the common name "coral-insects" applied to the polyps which form coral. It cannot be too emphatically stated that a coral-polyp is as far removed in organization from either an octopus or an insect as it is from man himself.

The external form of the polyp varies greatly in different cases. In the first place the column may be long and slender, or may be, on the contrary, so short in the vertical direction that the body becomes disk-like. The tentacles may number many hundreds or may be very few, in rare cases only one or two, or even absent altogether; they may be long and filamentous, or short and reduced to mere knobs or warts; they may be simple and unbranched, or they may be feathery in pattern. All these types are well illustrated by different species of British sea-anemones. The mouth may be level with the surface of the peristome, or may be projecting and trumpet-shaped. As regards internal structure, polyps exhibit two well-marked types of organization, each characteristic of one of the two classes, Hydrozoa and Anthozoa.

It is an almost universal attribute of polyps to possess the power of reproducing themselves non-sexually by the method of budding. This mode of reproduction may be combined with sexual reproductiveness, or may be the sole method by which the polyp produces offspring, in which case the polyp is entirely without sexual organs. In many cases the buds formed do not separate from the parent but remain in continuity with it, thus forming *colonies* or *stocks*, which may reach a great size and contain a vast number of individuals. Slight differences in the method of budding produce great variations in the form of the colonies, which may be distinguished in a general way as spreading, massive or arborescent. The reef-building corals are polyp-colonies, strengthened by the formation of a firm skeleton. For further details of colony-formation the reader is referred to the articles ANTHOZOA and HYDROMEDUSAE.

For figures of polyps see P. Gosse, *A History of the British Sea-Anemones and Corals* (London, 1860); A. Andres, "Le Attinie," in *Fauna and Flora des Golfes von Neapel*, ix. 1 (Leipzig, 1884); G. J. Allman, *A Monograph of the Gymnoblasic or Tubularian Hydroids* (Ray Society, 1871-1872). (E. A. M.)

POLYPERCHON (incorrectly Polysperchon), one of Alexander's generals, and the successor of Antipater as regent in Macedonia in 319 B.C. He was driven out by Cassander in 317 B.C. (See PHOCION.)

POLYPHEMUS, in Greek mythology, the most famous of the Cyclopes, son of Poseidon and the nymph Thoösa. He dwelt in a cave in the south-west corner of Sicily, and was the owner of large flocks and herds. He was of gigantic stature, with one eye in the middle of his forehead, a consumer of human flesh, without respect for the laws of god or man. Odysseus, having been cast ashore on the coast of Sicily, fell into the hands of Polyphemus, who shut him up with twelve of his companions in his cave, and blocked the entrance with an enormous rock. Odysseus at length succeeded in making the giant drunk, blinded him by plunging a burning stake into his eye while he lay asleep, and with six of his friends (the others having been

devoured by Polyphemus) made his escape by clinging to the bellies of the sheep let out to pasture. Euripides in the *Cyclops* essentially follows the Homeric account. A later story associates Polyphemus with Galatea (see ACIS).

Homer, *Odyssey*, ix.; Ovid, *Metam.* xiii. 749; Theocritus xi. See W. Grimm, *Die Sage von Polyphem.* (1857); G. R. Holland, in *Leipziger Studien* (1884), vii. 139-312.

POLYPODIUM, in botany, a large genus of true ferns (*q.v.*), widely distributed throughout the world, but specially developed in the tropics. The name is derived from Gr. *πολύς*, many, and *πόδιον*, a little foot, on account of the foot-like appearance of the rhizome and its branches. The species differ greatly in size and general appearance and in the character of the frond; the sori or groups of spore-cases (*sporangia*) are borne on the back of the leaf, are globose and naked, that is, are not covered with a membrane (*indusium*) (see fig. 1). The common polypody (fig. 2) (*P. vulgare*) is widely diffused in the British Isles, where it is found on walls, banks, trees, &c.; the creeping, densely-scaly rootstock bears deeply pinnately cut fronds, the fertile ones bearing on the back the bright yellow naked groups of sporangia (*sori*). It is also known as adder's foot, golden maidenhair and wood-fern, and is the oak-fern of the old herbals.

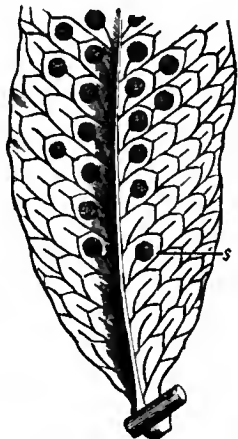

FIG. 1.—Portion of a pinna of leaf of *Polypodium* bearing sori, *s*, on its back.



FIG. 2.—*Polypodium vulgare*, common polypody (about $\frac{1}{4}$ nat. size).

1. Group of spore-cases (*sorus*) on back of leaf ($\times 4$).

There are a large number of varieties, differing chiefly in the form and division of the pinnae; var. *cambricum* (originally found in Wales) has the pinnae themselves deeply cut into narrow segments; var. *cornubiense* is a very elegant plant with finely-divided fronds; var. *cristatum* is a handsome variety with fronds forking at the apex and the tips of all the pinnae crested and curled. *P. dryopteris*, generally known as oak-fern, is a very graceful plant with delicate fronds, 6 to 12 in. long, the three main branches of which are themselves pinnately divided; it is found in dry, shady places in mountain districts in Great Britain, but is very rare in Ireland. *P. phegopteris* (beechnut) is a graceful species with a black, slender root-stock, from which the pinnate fronds rise on long stalks, generally about 12 in. long, including the stalk; it is characterized by having the lower pinnae of the frond deflexed; it is generally distributed in Britain, though not common. Many other species from different parts of the world are known in greenhouse cultivation.

POLYPUS, a term signifying a tumour which is attached by a narrow neck to the walls of a cavity lined with mucous

membrane. A polypus or polypoid tumour may belong to any variety of tumour, either simple or malignant. The most common variety is a polypus of the nose of simple character and easily removed. Polypi are also met with in the ear, larynx, uterus, bladder, vagina, and rectum. (See TUMOUR.)

POLYTECHNIC (Gr. *πολύς*, many, and *τέχνη*, an art), a term which may be held to designate any institution formed with a view to encourage or to illustrate various arts and sciences. It has, however, been used with different applications in several European countries. In France the first *école polytechnique* was founded by the National Convention at the end of the 18th century, as a practical protest against the almost exclusive devotion to literary and abstract studies in the places of higher learning. The institution is described as one "où l'on instruit les jeunes gens, destinés à entrer dans les écoles spéciales d'artillerie, du génie, des mines, des ponts et chaussées, créé en 1794 sous le nom d'école centrale des travaux publics, et en 1795 sous celui qu'elle porte aujourd'hui" (*Litttré*). In Germany there are nine technical colleges which, in like manner, have a special and industrial rather than a general educational purpose. In Switzerland the principal educational institution, which is not maintained or administered by the communal authorities, but is non-local and provided by the Federal government, is the Polytechnikum at Zurich. In all the important towns of the Federation there are trade and technical schools of a more or less special character, adapted to the local industries; e.g. schools for silk-weaving, wood-carving, watchmaking, or agriculture. But the Zurich Polytechnikum has a wider and more comprehensive range of work. It is a college designed to give instruction and practical training in those sciences which stand in the closest relation to manufactures and commerce and to skilled industry in general and its work is of university rank.

To the English public the word *polytechnic* has only recently become familiar, in connexion with some London institutions of an exceptional character. In the reign of William *The First* IV. there was an institution in London called after *Polytechnics* the name of his consort—"The Adelaide Gallery" *in England*.—and devoted rather to the display of new scientific inventions and curiosities than to research or to the teaching of science. It enjoyed an ephemeral popularity, and was soon imitated by an institution called the Polytechnic in Regent Street, with a somewhat more pretentious programme, a diving-bell, electrical and mechanical apparatus, besides occasional illustrated lectures of a popular and more or less recreative character. In the popular mind this institution is inseparably associated with "Professor" Pepper, the author of *The Boy's Playbook of Science* and of *Pepper's Ghost*. Both of these institutions, after a few years of success, failed financially; and in 1880 Mr Quintin Hogg, an active and generous philanthropist, purchased the disused building in Regent Street, and reopened it on an altered basis, though still retaining the name of Polytechnic, to which, however, he gave a new significance. He had during sixteen years been singularly successful in gathering together young shopmen and artisans in London in the evenings and on Sunday for religious and social intercourse, and in acquiring their confidence. But by rapid degrees his enterprise, which began as an evangelistic effort, developed into an educational institution of a novel and comprehensive character, with classes for the serious study of science, art, and literature, a gymnasium, library, reading circles, laboratories for physics and chemistry, conversation and debating clubs, organized country excursions, swimming, rowing, and natural history societies, a savings bank, and choral singing, besides religious services, open to all the members, though not obligatory for any. The founder, who from the first took the closest personal interest in the students, well describes his own aims: "What we wanted to develop our institute into was a place which should recognize that God had given man more than one side to his character, and where we could gratify any reasonable taste, whether athletic, intellectual, spiritual or social. The success of this effort was remarkable. In the first winter

6800 members joined, paying fees of 3s. per term, or 10s. 6d. per year; and the members steadily increased, until in 1900 they reached a total of 15,000. The average daily attendance is 4000; six hundred classes in different grades and subjects are held weekly; and upwards of forty clubs and societies have been formed in connexion with the recreative and social departments.

The precedent thus established by private initiative has since been followed in the formation of the public institutions which, under the name of "Polytechnics," have become so prominent and have exercised such beneficent influence among the working population of London. The principal resources for the foundation and maintenance of these institutions have been derived from two funds—that administered under the City Parochial Charities Act of 1883, and that furnished by the London County Council, at first under the terms of the Local Taxation (Customs and Excise) Act of 1890, and the Technical Instruction Act 1889, but since the 1st of May 1904 under the Education Act 1902, as applied to London by the act of 1903. More detailed reference to these two acts seems to be necessary in this place.

The royal commission of inquiry into the parochial charities of London was appointed in 1878, mainly at the instance of Mr James Bryce, and under the presidency of the Duke of Northumberland. Its report appeared in 1880, giving particulars of the income of the parishes, and revealing the fact that the funds had largely outgrown the original purposes of the endowments, which were ill adapted to the modern needs of the class for whose benefit they were intended. The act of parliament of 1883 was designed to give effect to the recommendations of the commissioners. It provided that while five of the largest parishes were to retain the management of their own charitable funds, the endowments of the remaining 107 parishes in the city should be administered by a corporate body, to be entitled "the Trustees of the London Parochial Charities" (otherwise known in relation to the polytechnics as "the Central Governing Body"), this body to include five nominees of the Crown and four of the corporation of London. The remaining members were to be chosen under a subsequent scheme of the charity commission, which added four nominees of the London County Council, two of the Ecclesiastical Commissioners, and one each appointed by the university of London, University College, King's College, the City and Guilds institute, and the governing bodies of the Bishopsgate and the Cripple-gate foundations. For the purpose of framing the scheme, a special commissioner, Mr James Anstie, Q.C., was temporarily attached to the charity commission, and it thus became the duty of the commission to prepare a statement of the charity property possessed by the 107 parishes, distinguishing between the secular and the ecclesiastical parts of the endowments. The annual income derived from the ecclesiastical fund was £35,000, and that from the secular portion of the fund £50,000. The scheme assigned capital grants amounting to £155,000 to the provision of open spaces, and £149,500 to various institutions, including free libraries in Bishopsgate and Cripple-gate, the People's Palace, the Regent Street and Northampton Institutes, and the Victoria Hall. A capital sum of £49,355 out of the ecclesiastical fund was devoted to the repair of city churches; and the balance of the annual income of this fund, after allowances for certain vested interests, was directed to be paid to the Ecclesiastical Commissioners. This balance has varied by slight increases from year to year, and amounted in 1906 to £20,875. The remaining fund thus set free for secular purposes was by the scheme largely devoted to the erection and maintenance of polytechnic institutions, or "industrial institutes," as they were at first called. It was the opinion of Mr Anstie and his fellow-commissioners that in this way it would be possible to meet one of the most urgent of the intellectual needs of the metropolis, and to render service nearly akin to the original purposes of the obsolete charitable endowments. For the year 1906-1907 the grants made to the polytechnics and kindred institutions (the Working Men's College, College for Working

Women, &c.) by the Central Governing Body amounted to £39,140, and the total amount contributed by the Central Governing Body since its creation amounts to £543,000.

The general scope and aims of the institutions thus contemplated by the commissioners are defined in the "general regulations for the management of an industrial institute," which are appended as a schedule to the several schemes, and which run as follows:—

A Typical Scheme under the Act.

The object of this institution is the promotion of the industrial skill, general knowledge, health and well-being of young men and women belonging to the poorer classes by the following means:—

- i. Instruction in—
 - a. The general rules and principles of the arts and sciences applicable to any handicraft, trade or business.
 - b. The practical application of such general rules and principles in any handicraft, trade or business.
 - c. Branches or details of any handicraft, trade or business, facilities for acquiring the knowledge of which cannot usually be obtained in the workshop or other place of business.
- The classes and lectures shall not be designed or arranged so as to be in substitution for the practical experience of the workshop or place of business, but so as to be supplementary thereto.
- ii. Instruction suitable for persons intending to emigrate.
- iii. Instruction in such other branches and subjects of art, science, language, literature and general knowledge as may be approved by the governing body.
- iv. Public lectures or courses of lectures, musical and other entertainments and exhibitions.
- v. Instruction and practice in gymnastics, drill, swimming and other bodily exercises.
- vi. Facilities for the formation and meeting of clubs and societies.
- vii. A library, museum and reading room or rooms.

Within the limits prescribed, the governing body may from time to time, out of the funds at their disposal, provide and maintain buildings and grounds, including workshops and laboratories suitable for all the purposes herein specified, and the necessary furniture, fittings, apparatus, models and books, and may provide or receive by gift or on loan works of art or scientific construction, or objects of interest and curiosity, for the purpose of the institute, and for the purpose of temporary exhibition.

Other provisions in the scheme require: (1) that the educational benefits of the institute shall be available for both sexes equally, but that common rooms, refreshment rooms, gymnasia and swimming-baths may be established separately, under such suitable arrangements as may be approved by the governing body; (2) that the fees and subscriptions shall be so fixed as to place the benefits of the institute within the reach of the poorer classes; (3) that no intoxicating liquors, smoking or gambling shall be allowed in any part of the building; (4) that the buildings, ground and premises shall not be used for any political, denominational or sectarian purpose, although this rule shall not be deemed to prohibit the discussion of political subjects in any debating society approved by the governing body; (5) that no person under the age of sixteen or above twenty-five shall be admitted to membership except on special grounds, and that the number thus specially admitted shall not exceed 5% of the total number of members.

These and the like provisions have formed the common basis for all the metropolitan polytechnics. In 1890 a large sum was placed by the Local Taxation (Customs and Excise) Act at the disposal of the county and county borough councils for the general purposes of technical education, and in 1893 the London County Council determined to devote a considerable portion of this revenue to the further development and sustentation of polytechnics. While the funds granted by the Central Governing Body may be employed in aid of the social and recreative as well as the educational purposes of the various institutes, it is a statutory obligation that the sums contributed by the London County Council should be applied to educational work only.

The Technical Board of the London County Council.

Dr William Garnett, the educational adviser of the London County Council, has, in a published lecture delivered before the international congress on technical education in June 1897, thus described the conditions under which the council offers financial help to the London polytechnics:—

The objects which the technical education board has had in view in its dealings with the polytechnics have been:—

1. To allow to the several governing bodies the greatest possible freedom in the conduct of social, recreative and even religious work within the provisions of the schemes of the Charity Commissioners.

2. To secure to each polytechnic the services of an educational principal, who should be responsible to his governing body for the organization and conduct of the whole of the work of the institution.

3. To provide in each polytechnic a permanent staff of teachers, who should be heads of their respective departments and give their whole time to the work of the institution, and thus to establish a corporate or collegiate life in the polytechnic.

4. To ensure that all branches of experimental science are taught experimentally, and that the students have the opportunity of carrying out practical laboratory work, at an inclusive fee not exceeding ten shillings for any one subject.

5. To provide efficient workshop instruction in all practical trade subjects.

6. To secure that the number of students under the charge of any one teacher in laboratory or workshop classes, or in other classes in which personal supervision is of paramount importance, shall not exceed a stated limit (fifteen in the workshop, or twenty in the laboratory).

7. To exclude from classes students who, for want of preliminary training, are incapable of profiting by the instruction provided; and to this end to restrict the attendance at workshop classes to those who are actually engaged in the trades concerned, and have thus opportunities of acquiring the necessary manual dexterity in the performance of their daily duties.

8. To furnish an adequate fixed stipend for all teachers, in place of a contingent interest in fees and grants.

9. To encourage private subscriptions and donations.

10. To establish an efficient system of inspection.

11. To facilitate the advertisement of polytechnic classes, and especially to invite the co-operation of trade societies in supporting their respective classes.

12. To encourage the higher development of some special branch of study in each polytechnic.

13. To utilize the polytechnic buildings as far as possible in the daytime by the establishment of technical day schools, or otherwise.

14. To secure uniformity in the keeping of accounts.

The regulations under which the council has attempted to secure its objects by means of grants have been changed from time to time as the work of the polytechnics has developed, but they provide that the council's aid should be partly in the form of a fixed grant to each institution, partly a share of the salaries of the principal and the permanent teachers, partly a grant on attendance, the scale depending on the subject and character of the instruction, and partly a subsidy (15%) on voluntary contributions. In addition to the annual grants for maintenance, substantial grants for building and equipment are made from time to time.

The scale of grants adopted by the council for the session 1907-1908 was the following:—

i. A fixed grant assigned to each polytechnic.

ii. Three-fourths of the salary of the principal (subject to certain conditions).

iii. Fifty per cent. of the salaries of heads of approved departments.

iv. Ten per cent. of the salaries of other teachers.

v. Fifteen per cent. on (voluntary) annual subscriptions or donations.

vi. Attendance grants on evening classes varying from 1d. to 6d. per student-hour (subject to certain conditions of minimum attendance, eligibility, &c.).

vii. Special grants not exceeding £50 for courses of lectures on particular subjects required or approved by the council.

viii. Special grants towards any departments which the council may desire to see established or maintained.

ix. Equipment grants and building grants in accordance with the special requirements of the institutions.

The above grants are independent of any contributions which the council may make towards secondary day schools or day schools of domestic economy or training colleges of domestic economy in the polytechnics.

With a view to a due division of labour, and also to the co-operation of the public bodies concerned, the "London Polytechnic Council" was created in 1894. It was composed of

representatives of the Central Governing Body, the technical education board of the London County Council, and the City and Guilds of London Institute, and its duty was to consult as to the appropriation of funds, the organization of teaching, the holding of needful examinations, and the supervision of the work generally.

After ten years of work the London polytechnic council was dissolved in the summer of 1904 in consequence of the abolition of the technical education board of the London County Council, when the council became responsible for all grades of education. A statement below shows the number and names of the several institutions, and the extent to which they have been severally aided by the Central Governing Body and the London County Council.

The "People's Palace" owes its origin in part to the popularity of a novel by Sir Walter Besant, entitled *All Sorts and Conditions of Men*, in which the writer pointed out the sore need of the inhabitants of East London for social improvement and healthy recreation, and set forth an imaginary picture of a "Palace of Delight," wherein this need might be partly satisfied. Much public interest was awakened, large subscriptions were given, and the Central Governing Body aided the project; but the munificence of the drapers' company in setting aside £7000 a year for its permanent maintenance released the London County Council from any obligation to make a grant. Apart from the social and recreative side of this popular institution, the educational section, under the name of the East London Technical College, steadily increased in numbers and influence under the fostering care of the drapers' company and has now been recognized as a "school" of the university of London under the title of "The East London College" and is being utilized by the London County Council in the same way as other "schools of the university."

Grants to the London Polytechnics during the Session 1906-1907.

	Central Governing Body. London County Council.			
	Under Scheme.	Voluntary Grants.	Buildings and Equipment.	Maintenance.
Battersea Polytechnic	2,500	1,701	1,545	4,760
Birkbeck College	1,000	1,005	445	3,450
Borough Road Polytechnic	2,500	1,563	820	5,285
City of London College	1,000	901	515	3,725
East London College	3,500	224	nil	nil
Northampton Institute	3,350	1,555	3,415	4,525
Northern Polytechnic	1,500	2,183	2,660	4,145
Regent Street Polytechnic	3,500	3,916	965	7,665
South-Western Polytechnic	1,500	2,091	1,275	6,265
Woolwich Polytechnic	nil	1,000	2,525	5,495
Sir John Cass's Institute	nil	50	510	2,400
Total £	20,350	16,189	14,675	47,715

In the above table the grants are given to the nearest pound. Up to July 1907 the total expenditure of the council upon the polytechnics, apart from the day schools, training colleges, &c., conducted in them, was about £525,000, almost exactly the same as that of the Central Governing Body. The voluntary grants from the central governing body include a contribution towards a compassionate fund, and a pension fund based on endowment assurances for all permanent officers of the polytechnics in receipt of salaries of not less than £100 a year.

The grants received from the board of education amount to about £30,000 a year, while the fees of students and members produce about £45,000. Voluntary subscriptions, including those from city companies and other sources of income, produce about £30,000 in addition, so that out of a total expenditure of about £200,000 a year the council now contributes 30%, the Central Governing Body 18%, fees 22½%, the board of education 15% and city companies and other subscribers 15%.

The Goldsmiths' Institute at New Cross owed its existence and its annual maintenance to the generous initiative of the ancient city gild whose name it bore. It was therefore entirely independent of pecuniary subsidy from any other public body. In the year 1900 the number of class entries to this institute was 7574. In 1904 the goldsmiths' company presented the premises, together with an annual subsidy, to the university of London for the purposes of a training college for teachers, so that from that date it ceased to be one of the London polytechnics, although, pending the provision of other premises, many of the technical evening classes have been continued under the London County Council by permission of the university with the approval of the company. The clothworkers' company has also contributed £18,000 to the Northern Polytechnic at Holloway.

In all these institutions the general aims have been practically the same, although special features have been differentiated *Aims and Methods.* in order to meet the local needs and the wishes of the inhabitants. In all there are laboratories and lecture rooms, trade classes, art studios, gymnasia, provision for manual training and domestic economy and applied science. In nearly all, at first, mechanical and manual instruction were the prominent objects in view, partly owing to the conditions under which grants were made by the science and art department. But of late increased attention has been paid year by year to literary and humaner studies, and to general mental cultivation, pursued *pari passu* with technical and scientific training. The aid of the London organization for university extension, now a department of the university, has been especially serviceable in providing courses of lectures and classes in literary subjects at nearly all the polytechnics. As subsidiary to their main work, some of them have established junior continuation schools, with a view to provide suitable instruction for scholars who have left the public elementary schools and are not yet prepared to enter the technical and trade classes. Although the workshops and the classes for artisans are used chiefly in the evenings, there is an increasing number of day students: e.g. at the Northampton Polytechnic Institute in Clerkenwell there is a very important day school of engineering conducted on the "sandwich system," the students entering engineering works for the summer months and returning to the polytechnic for the winter session; at the Battersea Polytechnic there is a very important training college for teachers of domestic economy; at Regent Street there are day schools in engineering, architecture, photo-process and carriage-building; at the South-Western Polytechnic there are important schools of mechanical and electrical engineering and a training college for women teachers of physical exercises; at the Northern Polytechnic, as at Battersea, there is a training college for teachers of domestic economy, and there are departments of commerce and of physics and chemistry, while the Woolwich Polytechnic receives in the daytime, by special arrangement with the war office, a large number of engineering apprentices employed in the arsenal. In short, the schemes of the several institutions are so elastic that the governing bodies are at liberty to open any classes or to try any educational or recreative experiment for which they can find a genuine local demand. The total number of scholars in the polytechnics and their branch institutions is variously estimated at from 40,000 to 50,000, and the total number of regular scholars in the evening schools of the council does not exceed 100,000. These figures may be usefully compared with the census returns, which show that within the metropolitan area there are 704,414 persons between the ages of thirteen and twenty-one. It is a noteworthy fact that, whereas in the population statistics for the whole of England and Wales the number at each year of age is regularly diminished by death from eight years onwards, there is a steady increase in London, year by year, from fourteen up to the age of thirty. This fact is owing to the constant immigration of young men and women from the provinces to the metropolis. The census commissioners in their report for 1901 (p. 15) computed that more than

one-third of the population of London were not natives. They show also that, if all England and Wales be taken together, the number of persons between twenty and twenty-one is less by 12.8% than the number between thirteen and fourteen; but that, taking London alone, the number of persons between twenty and twenty-one is greater by 14.4% than the number between thirteen and fourteen. Hence, the proportion of the inhabitants who are of an age to benefit by polytechnics and continuation schools is in London exceptionally large. It would not be right for Londoners to complain that there is thus cast upon them the duty of providing suitable instruction for so many immigrants, for if the great city drains the rural districts of some of their best brain and muscle, she gains much from their industry and productive power. The figures, however, point to the necessity for taking every means possible to raise the standard, both physical and intellectual, of the London boy. The immigration into London of youths and young men means to a great extent the substitution of the provincially trained improver or artisan for the less fit London boy, who consequently falls into the ranks of the unskilled, then of the unemployed and ultimately of the unemployable.

But it follows from the particulars thus given that neither the supply of suitable provision for mental improvement and rational recreation for the wage-earning classes, nor the demand for such provision on the part of the workers themselves is commensurate with the moral and intellectual needs of a community of nearly seven millions of people (four and a half millions within the administrative county). The provision in evening schools, institutes, classes and polytechnics is still in some respects far inferior to that which is to be found in most German and Swiss towns, and needs to be greatly increased. In matters relating to the higher life, demand does not always precede supply; it is simply which is needed not only to satisfy the public demand, but to create it. As new and well-devised opportunities for mental culture are placed within reach, they will be more and more appreciated, new and healthier appetites will be stimulated, the art of employing leisure wisely and happily will be more systematically studied, and the polytechnics will become still more important centres of civilizing and educating influence than they have hitherto been.

In particular, the reconstituted university of London has been placed in new and most helpful relation to the best of the polytechnics. By the statutes the senate of the university is empowered to include in the list of "schools of the university" all institutions which are duly equipped and able to furnish suitable instruction of an advanced and scholarly type; and also to recognize all thoroughly qualified professors in their several faculties and subjects as "teachers of the university," although some of their classes may meet in the evening only, and no student is to be prevented from taking a degree as an internal student of the university solely because he can attend classes only in the evening. There is thus a way open for the due recognition of the polytechnics as part of the teaching machinery of the university, and for the admission of the best students as undergraduates, with all the rights of internal students. The great possibilities of the metropolitan university under its new conditions were at first hardly revealed or accurately foreseen. But there were during the session 1906-1907 no less than eighty-six recognized "teachers of the university" on the staffs of the London polytechnics and more than 750 students who were working for London University degrees in the polytechnic classes. There is no reason to fear that the recreative, social, manual and industrial training, to which at first the special attention of the founder of the Regent Street Polytechnic was directed, will suffer from a fuller expansion of the academic and literary side of "polytechnic" life. Rather it may be hoped that the due co-ordination of the practical with the purely intellectual purposes of these institutions will serve to give to all the students, whatever their future destination may be, a truer and broader conception of the value of mental culture for its own sake.

See also a paper by Mr Sidney Webb, *The London Polytechnic Institutes*, in the second volume of special reports on educational subjects (1898) issued by the Education Department; the *Report of the Central Governing Body of the London Parochial Charities*; the *Annual Reports of the London County Council*; the *Polytechnic Magazine*, published from time to time at the institute in Regent Street; and various memoirs and papers contained in the *Proceedings of the International Congress on Technical Education* (1897), especially two—that by Mr Quintin Hogg, detailing his own early experience in founding the first polytechnic, and that of Dr William Garnett, then secretary of the Technical Education Board.

(J. G. F.; W. G.)

POLYXENA, in Greek legend, daughter of Priam, king of Troy, and Hecuba. She had been betrothed to Achilles, who was slain by Paris in the temple of Apollo Thymbraeus, where the marriage was to have been celebrated (Hyginus, *Fab.* 110). The shade of Achilles afterwards appeared to the returning Greeks in the Thracian Chersonese and demanded the sacrifice of Polyxena, who was put to death by Neoptolemus, son of Achilles, on his father's grave (Ovid, *Metam.* xiii. 440 sqq.). The tragic story is the subject of the *Hecuba* of Euripides, the *Troades* of Seneca and the *Polyxena* of Sophocles, of which only a few fragments remain. According to Philostratus (*Heroica*, 20, 18), Polyxena fled to the Greeks after the murder of Achilles and committed suicide on his tomb.

POLYZOA, in zoology, a term (introduced by J. V. Thompson, 1830) synonymous with Bryozoa (Ehrenberg, 1831) for a group commonly included with the Brachiopoda in the Molluscoidea (Milne Edwards, 1843). The correctness of this association is questionable, and the Polyzoa are here treated as a primary division or phylum of the animal kingdom. They may be defined as aquatic animals, forming colonies by budding; with ciliated retractile tentacles and a U-shaped alimentary canal. The phylum is subdivided as follows.

Class I. ENTOPROCTA (Nitsche). Lophophore circular, including both mouth and anus. Tentacles infolded, during retraction, into a vestibule which can be closed by a sphincter. Body-wall not calcified, body-cavity absent. Definite excretory organs present. Reproductive organs with ducts leading to the vestibule. Zooids possessing a high degree of individuality. *Loxosoma Pedicellina* (fig. 1), *Urratella*.



(After van Beneden.)

FIG. 1.—Part of the creeping stolon, with zooids, of *Pedicellina belgica*.

a, c, Stalks of zooids of different ages; b, bud.

by transverse diaphragms, most numerous in the distal portion. Orifices of the zoecia often separated by pores (mesopores).

Sub-order 2. CRYPTOSTOMATA (Vine); Fossil.—Zoecia usually short. Orifice concealed at the bottom of a vestibular shaft, surrounded by a solid or vesicular calcareous deposit.

Sub-order 3. CYCLOSTOMATA (Busk).—Zoecia prismatic or cylindrical, with terminal, typically circular orifice, not protected by any special organ. The ovicells are modified zoecia, and contain numerous embryos which in the cases so far investigated arise by fission of a primary embryo developed from an egg. *Crisia* (fig. 2), *Tubulipora*, *Hornera*, *Lichenopora*.

Sub-order 4. CTENOSTOMATA (Busk).—Zoecia with soft uncalci-

fied walls, the external part of the introvert being closed during retraction by a membranous collar. Zoecia either arising from a stolon, without lateral connexion with one another, or laterally united to form sheets. *Alcyonidium*, *Flustrella*, *Bowerbankia* (fig. 3), *Farrella*, *Victorella*, *Paludicella*.



(After Hincks.)

FIG. 2.—Part of a Branch of *Crisia eburnea*. g, zoocia; x, imperfectly developed ovicell.

Sub-order 5. CHEILOSTOMATA (Busk).—Zoecia with more or less calcified walls. Orifice closed by a lid-like operculum. Polymorphism usually occurs, certain individuals having the form of avicularia or vibracula. The ovicells commonly found as globular swellings surmounting the orifices are not direct modifications of zoecia, and each typically contains a single egg or embryo. *Membranipora*, *Flustra*, *Onychocella*, *Lunulites*, *Steganoporella*, *Scrupocellaria*, *Menipea*, *Caberea*, *Bicellaria*, *Bugula*, *Beania*,

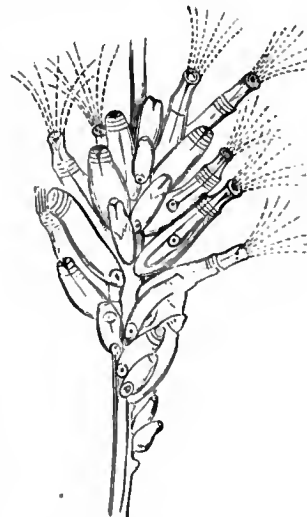

(After Hincks.)

FIG. 3.—Part of a branch of *Bowerbankia pustulosa*, showing the thread-like stolon from which arise young and mature zoecia. The tentacles are expanded in some of the latter.

Membraniporella, *Cribrilina*, *Cellaria*, *Micropora*, *Selenaria*, *Umbonula* (fig. 4), *Lepralia*, *Schizoporella*, *Cellepora*, *Mucronella*, *Smittia*, *Relepora*, *Calenicella*, *Microporella*, *Adeona*.

Order 2. PHYLACTOLAEMATA (Allman).—Lophophore horse-shoe shaped, or in *Fredericella* circular. Mouth guarded by an epistome. Body-cavities of zooids continuous with one another. Body-wall uncalcified and muscular. Reproduction sexual and by means of "statoblasts," peculiar internal buds protected by a chitinous shell. *Fredericella*, *Plumatella* (fig. 5), *Lophopus*, *Cristatella*, *Pectinatella*.

Hatschek (1888) treated the Entoprocta as a division of his group Scolecida, characterized by the possession of a primary body-cavity and of protonephridia; while he placed the Ectoprocta, with the Phoronida and Brachiopoda, in a distinct group, the Tentaculata. Against this view may be urged the essential similarity between the processes of budding in Entoprocta and Ectoprocta (cf. Seeliger, *Zeitschr. wiss. Zool.* xlix. 168; l., 560), and the resemblances in the development of the two classes.

Of the forms above indicated there is no palaeontological evidence with regard to the Entoprocta. The Trepostomata are in the main Palaeozoic, although *Heteropora*, of which recent species exist, is placed by Gregory in this division. The Cryptostomata are also Palaeozoic, and include the abundant and widely-distributed genus *Fenestella*. The Cyclostomata are numerous in Palaeozoic rocks, but attained a specially predominant position in the Cretaceous strata, where they are represented by a profusion of genera and species; while they still survive in considerable numbers at the present day. The Ctenostomata are ill adapted for preservation as fossils, though remains referred to this group have been

¹ Calcareous spicules have been described by Lomas in *Alcyonidium gelatinosum*.



(After Hincks.)

FIG. 4.—Zoecia of *Umbonula pavonella*, showing a pair of minute avicularia on either side of the orifice of each zoecium.

described from Palaeozoic strata. They constitute a small proportion of the recent Polyzoa. The Cheilostomata are usually believed to have made their appearance in the Jurassic period. They are the dominant group at the present day, and are represented by a large number of genera and species. The Phylactolaemata are a small group confined to fresh water, and possess clear indications of adaptation to that habitat. The fresh-water fauna also contains a representative of the Entoprocta (*Urnatella*), two or three Ctenostomes, such as *Victorella* and *Paludicella*, and one or two species of Cheilostomata. With these exceptions, the existing Polyzoa are marine forms, occurring from between tide-marks to abyssal depths in the ocean.



(After Allman.)

FIG. 5.—Zooid of *Plumatella*, with expanded tentacles.

- a, Anus;
- br, Tentacles, arranged on a horseshoe shaped lophophore;
- i, Ectocyst;
- v, Caecum of stomach.

The Polyzoa are colonial animals, the colony (zoarium) originating in most cases from a free-swimming larva, which attaches itself to some solid object and becomes metamorphosed into the primary individual, or "ancestrula." In the Phylactolaemata, however, a new colony may originate not only from a larva, but also from a peculiar form of bud known as a statoblast, or by the fission of a fully-developed colony. The ancestrula inaugurates a process of budding, continued by its progeny, and thus gives rise to the mature colony. In *Loxosoma* the buds break off as soon as they become mature, and a colonial form is thus hardly assumed. In other Entoprocta the buds retain a high degree of individuality, a thread-like stolon giving off the cylindrical stalks, each of which dilates at its end into the body of a zooid. In some of the Ctenostomata the colony is similarly constituted, a branched stolon giving off the zooids, which are not connected with one another. In the majority of Ectoprocta there is no stolon, the zooids growing out of one another and being usually apposed so as to form continuous sheets or branches. In the encrusting type, which is found in a large proportion of the genera, the zooids are usually in a single layer, with their orifices facing away from the substratum; but in certain species the colony becomes multilaminar by the continued superposition of new zooids over the free surfaces of the older ones, whose orifices they naturally occlude. The zoarium may rise up into erect growths composed of a single layer of zooids, the orifices of which are all on one surface, or of two layers of zooids placed back to back, with the orifices on both sides of the fronds or plates. The rigid Cheilostomes which have this habit were formerly placed in the genus *Eschara*, but the bilaminar type is common to a number of genera, and there can be no doubt that it is not in itself an indication of affinity. The body-wall is extensively calcified in the Cyclostomata and in most Cheilostomata, which may form elegant network-like colonies, as in the unilaminar genus *Kelepora*, or may consist of wavy anastomosing plates, as in the bilaminar *Lepralia foliacea* of the British coasts, specimens of which may have a diameter of many inches. In other Cheilostomes the amount of calcification may be much less, the supporting skeleton being largely composed of the organic material chitin. In *Flustra* and other forms belonging to this type, the zoarium is accordingly flexible, and either bilaminar or unilaminar. In many calcareous forms, both Cheilostomes and Cyclostomes, the zoarium is rendered flexible by the interposition of chitinous joints at intervals. This habit is characteristic of the genera *Crisia*, *Cellaria*, *Calenicella* and others, while it occurs in certain species of other genera. The form of the colony may thus be a good generic character, or, on the contrary, a single genus or even species may assume a variety of different forms. While nearly all Polyzoa are permanently fixed to one spot, the colonies of *Cristatella* and *Lophopus* among the Phylactolaemata can crawl slowly from place to place.

Anatomy.—The zooids of which the colonies of Ectoprocta are composed consist of two parts: the body-wall and the visceral mass (figs. 6, 9). These were at one time believed to represent two individuals of different kinds, together constituting a zooid. The visceral mass was accordingly termed the "polypide" and the body-wall which contains it the "zoecium." This view depended principally on the fact that the life of the polypide and of the zoecium are not coextensive. It is one of the most remarkable facts in the natural history of the Polyzoa that a single zoecium may be tenanted by several polypides, which successively degenerate. The periodical histolysis may be partly due to the absence of specific excretory organs and to the accumulation of pigmented excretory substances in the wall of the alimentary canal. On the degeneration of the polypide, its nutritive material is apparently absorbed for the benefit of the zooid, while the pig-

mented substances assume a spheroidal form, which either remains as an inert "brown body" in the body-cavity or is discharged to the exterior by the alimentary canal of the new polypide. This is formed as a two-layered "polypide-bud," which usually develops from the inner side of the zoecial wall, and soon occupies the place of the previous polypide. The inner layer of the polypide-bud gives rise to the structures usually regarded as ectodermic and endodermic, the outer layer to the mesodermic organs.

The polypide consists of a "lophophore" bearing a series of ciliated tentacles by which Diatoms and other microscopic bodies are collected as food, of a U-shaped alimentary canal, and of a central nervous system. While the mouth is invariably encircled by the bases of the tentacles, the anus lies within the series in the Entoprocta and outside it in the Ectoprocta. The lophophore is a simple circle in all Polyzoa except in the Phylactolaemata, where it typically has the form of a horse shoe outlined by the bases of the tentacles. In *Fredericella* belonging to this order it is, however, circular, but the systematic position of the genus is sufficiently indicated by its possession of an "epistome," a lip-like structure guarding the anal side of the mouth in all Phylactolaemata and absent throughout the Gymnolaemata. The cavities of the hollow tentacles open into a circular canal which surrounds the oesophagus at the base of the lophophore. This is continuous with the general body-cavity in the Phylactolaemata, while in the Gymnolaemata it develops in the bud as a part of the body-cavity, from which it becomes completely separated. In the Entoprocta the tentacles are withdrawn by being infolded into the "vestibule," a depression of the oral surface which can be closed by a sphincter muscle. In the Ectoprocta they are retractile into an introvert, the "tentacle-sheath" (fig. 9), the external opening of which is the "orifice" of the zoecium. In the Cyclostomata, further distinguished by the cylindrical or prismatic form of their highly calcified zoecia, the orifice is typically circular, without any definite closing organ. In the Cheilostomata it is closed by a chitinous (rarely calcareous) "operculum" (fig. 9, C), while in the Ctenostomata it is guarded by a delicate membrane similar to a piece of paper rolled into a longitudinally creased cylinder. During retraction this "collar" lies concealed in the beginning of the introvert. It becomes visible when the polypide begins to protrude its tentacles, making its appearance through the orifice as a delicate hyaline frill through which the tentacles are pushed.

In the Phylactolaemata the outermost layer of the body-wall is a flexible, uncalcified cuticle or "ectocyst," beneath which follow in succession the ectoderm, the muscular layers and the coelomic epithelium. In a few Gymnolaemata the ectocyst is merely chitinous, although in most cases the four vertical walls and the basal wall of the zoecium are calcareous. The free (frontal) wall may remain membranous and uncalcified, as in *Membranipora* (figs. 8 A, 9 A), but in many Cheilostomes the frontal surface is protected by a calcareous shield, which grows from near the free edges of the vertical walls and commonly increases in thickness as the zoecium grows older by the activity of the "epitheca," a layer of living tissue outside it. The body-wall is greatly simplified in the Gymnolaemata, in correlation with the functional importance of the skeletal part of the wall. Even the ectoderm can rarely be recognized as an obvious epithelium except in regions where budding is taking place, while muscular layers are always absent and a coelomic epithelium can seldom be observed. The body-cavity is, however, traversed by muscles, and by strands of mesodermic "funicular tissue," usually irregular, but sometimes constituting definite funiculi (fig. 6, x, x'). This tissue is continuous from zoecium to zoecium

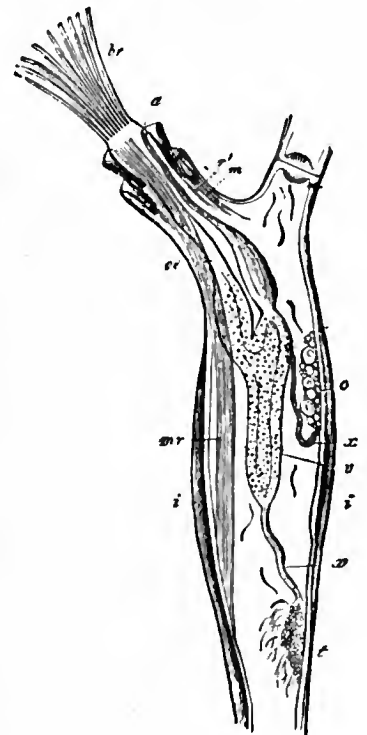

(After Allman.)

FIG. 6.—Zooid of *Paludicella articulata* (= *ehrenbergi*).

- a, Anus.
- br, Expanded tentacles.
- i, Ectocyst.
- m, m', Parietovaginal muscles.
- mr, Retractor muscle.
- o, Ovary.
- oe, Oesophagus.
- v, Caecum of stomach.
- t, testis.
- x, x', Funiculi.

through perforated "rosette-plates" in the dividing walls. In the Phylactolaemata a single definite funiculus passes from the body-wall to the apex of the stomach. This latter organ is pigmented in all Polyzoa, and is produced, in the Ectoprocta, beyond the point where the intestine leaves it into a conspicuous caecum (fig. 6, v). The nervous system is represented by a ganglion situated between the mouth and the anus. The ovary (o) and the testis (t) of Ectoprocta are developed on the body-wall, on the stomach, or on the funiculus. Both kinds of reproductive organs may occur in a single zoecium, and the reproductive elements pass when ripe into the body-cavity. Their mode of escape is unknown in most cases. In some Gymnolaemata, polypides which develop an ovary possess a flask-shaped "intertentacular organ," situated between two of the tentacles, and affording a direct passage into the introvert for the eggs or even the spermatozoa developed in the same zoecium. In other cases the reproductive cells perhaps pass out by the atrophy of the polypide, whereby the body-cavity may become continuous with the exterior. The statoblasts of the Phylactolaemata originate on the funiculus, and are said to be derived partly from an ectodermic core possessed by this organ and partly from its external mesoderm (Braem), the former giving rise to the chitinous envelope and to a nucleated layer (fig. 7, *ect.*), which later invaginates to form the inner vesicle of the polypide-bud. The mesodermic portion becomes charged with a yolk-like material (y), and, on the germination of the statoblast, gives rise to the outer layer (mes) of the bud. The production of a polypide by the statoblast thus differs in no essential respect from the formation of a polypide in an ordinary zoecium. The statoblasts require a period of rest before germination, and Braem has shown that their property of floating at the surface may be beneficial to them by exposing them to the action

of frost, which in some cases improves the germinating power. The occurrence of Phylactolaemata in the tropics would show, however, without further evidence, that frost is not a factor essential for germination. The withdrawal of the extended polypide is effected by the contraction of the retractor muscles (fig. 6, *mr.*), and must result in an increase in the volume of the contents of the body-cavity. The alternate increase and diminution of volume is easily understood in forms with flexible zoecia. Thus in the Phylactolaemata the contraction of the muscular

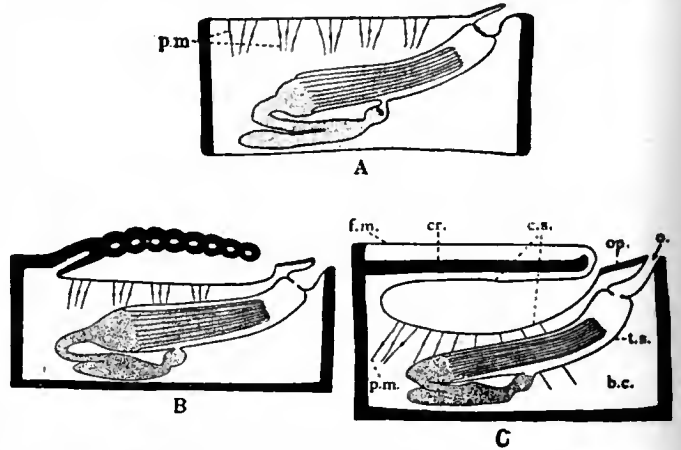
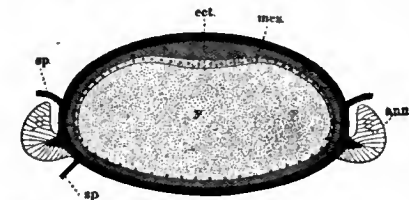

FIG. 9.—Diagrammatic Longitudinal Sections of Cheilostomatous Zoecia.

A, *Membranipora* (after Nitsche); B, *Cribrilina*; C, Some of the Lepralioid forms. *b.c.*, Body-cavity. *cr.*, Cryptocyst. *t.s.*, Compensation-sac. *f.m.*, Frontal membrane. *o.*, Orifice, through which the tentacles are protruded. *op.*, Operculum. *p.m.*, Parietal muscles. *t.s.*, Tentacle-sheath.

are developed in the young zoecium, but they soon unite with one another laterally, leaving rows of pores along the sutural lines (fig. 10). The operculum retains its continuity with the frontal membrane (fig. 9, B) into which the parietal muscles are still inserted. As indications that the conditions described in *Membranipora* and *Cribrilina* are of special significance may be noted the fact that the ancestrula of many genera which have well-developed compensation-sacs in the rest of their zoecia is a *Membranipora*-like individual with a series of marginal calcareous spines, and the further fact that a considerable proportion of the Cretaceous Cheilostomes belong either to the Membraniporidae or to the Cribrilinidae. (ii.) In *Scrupocellaria*, *Menipea* and *Caberea* a single, greatly dilated marginal spine, the "scutum" or "fornix," may protect the frontal membrane. (iii.) In *Umbonula* the frontal membrane and parietal muscles of the young zoecium are like those of *Membranipora*, but they become covered by the growth, from the proximal and lateral sides, of a calcareous lamina covered externally by a soft membrane. The arrangement is perhaps derivable from a *Cribrilina*-like condition in which the outer layer of the spines has become membranous while the spines themselves are laterally united from the first. (iv.) In the Microporidae and Steganoporellidae the body-cavity becomes partially subdivided by a calcareous lamina ("cryptocyst," Jullien) which grows from the proximal and lateral sides in a plane parallel to the frontal membrane and not far below it. The parietal muscles are usually reduced to a single pair, which may pass through foramina ("opesiules") in the cryptocyst to reach their insertion. There is no compensation-sac in these families. (v.) Many of the Lepralioid forms offer special difficulties, but the calcareous layer of the frontal surface is probably a cryptocyst (as in fig. 9, C), the compensation-sac being developed round its distal border. The "epitheca" noticed above is in this case the persistent frontal membrane. (vi.) In *Microporella* the opening of the compensation-sac has become separated from the operculum by calcareous matter, and is known as the "median pore." Jullien believed that this pore opens into the tentacle-sheath, but it appears probable that it really communicates with the compensation-sac and not with the tentacle-sheath. The mechanism of protrusion in the Cyclostomata is a subject which requires further examination.

The most singular of the external appendages found in the Polyzoa are the avicularia and vibracula of the Cheilostomata. The avicularium is so called from its resemblance, in its most highly differentiated condition, to the head of a bird. In *Bugula*, for instance, a calcareous avicularium of this type is attached by a narrow neck to each zoecium. The avicularium can move as a whole by means of special muscles, and its chitinous lower jaw



(After Braem.)
FIG. 7.—Section of a Germinating Statoblast of *Cristatella mucedo*.
ann., Chitinous annulus, containing air-cavities which enable the statoblast to float.
ect., Thickened part of the ectoderm, which will give rise to the inner layer of the polypide-bud.
mes., Mesoderm, forming the outer layer of the bud.
sp., Anchoring spines of the statoblast.
y., The yolk-like mesodermic mass.

body-wall exerts a pressure on the fluid of the body-cavity and is the cause of the protrusion of the polypide. In the Gymnolaemata protrusion is effected by the contraction of the parietal muscles, which pass freely across the body-cavity from one part of the body-wall to another. In the branching Ctenostomes the entire body-wall is flexible, so that the contraction of a parietal muscle acts equally on the two points with which it is connected. In encrusting Ctenostomes and in the *Membranipora*-like Cheilostomes (figs. 8 A, 9 A) the free surface

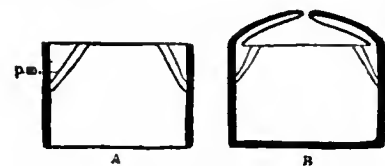

FIG. 8.—Diagrammatic Transverse Sections.
A, of *Membranipora*; B, of an immature zoecium of *Cribrilina*;
p.m., Parietal muscles.

or frontal wall is the only one in which any considerable amount of movement can take place. The parietal muscles (*p.m.*), which pass from the vertical walls to the frontal wall, thus act by depressing the latter and so exerting a pressure on the fluid of the body-cavity. In Cheilostomata with a rigid frontal wall Jullien showed that protrusion and retraction were rendered possible by the existence of a "compensation-sac," in communication with the external water.

In its most fully-developed condition (fig. 9, C) the compensation-sac (*c.s.*) is a large cavity which lies beneath the calcified frontal wall and opens to the exterior at the proximal border of the operculum (fig. 10). It is joined to the rigid body-wall by numerous muscle-fibres, the contraction of which must exert a pressure on the fluid of the body-cavity, thereby protruding the polypide. The exchange of fluid in the sac may well have a respiratory significance, in addition to its object of facilitating the movements of the tentacles.

The evolution of the arrangements for protruding the polypide seems to have proceeded along several distinct lines: (i.) In certain

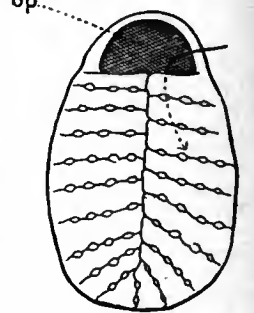

FIG. 10.—Zoecium of *Cribrilina*, showing the entrance to the compensation-sac on the proximal side of the operculum (*op*).

or "mandible" can be opened and closed. It is regarded as a modified zoecium, the polypide of which has become vestigial, although it is commonly represented by a sense-organ, bearing tactile hairs, situated on what may be termed the palate. The operculum of the normal zoecium has become the mandible, while the occlusor muscles have become enormous. In the vibraculum the part representing the zoecium is relatively smaller, and the mandible has become the "seta," an elongated chitinous lash which projects far beyond the zoecial portion of the structure. In *Caberea*, the vibracula are known to move synchronously, but co-ordination of this kind is otherwise unknown in the Polyzoa. The avicularia and vibracula give valuable aid to the systematic study of the Cheilostomata. In its least differentiated form the avicularium occupies the place of an ordinary zoecium ("vicarious avicularium"), from which it is distinguished by the greater development of the operculum and its muscles, while the polypide is normally not functional. Avicularia of this type occur in the common *Flustra foliacea*, in various species of *Membranipora*, and in particular in the Onychocellidae, a remarkable family common in the Cretaceous period and still existing. In the majority of Cheilostomes, the avicularia are, so to speak, forced out of the ordinary series of zoecia, with which they are rigidly connected. There are comparatively few cases in which, as in *Bugula*, they are mounted on a movable joint. Although at first sight the arrangement of the avicularia in Cheilostomes appears to follow no general law some method is probably to be made out on closer study. They occur in particular in relation with the orifice of the zoecium, and with that of the compensation-sac. This delicate structure is frequently guarded by an avicularium at its entrance, while avicularia are also commonly found on either side of the operculum or in other positions close to that structure. It can hardly be doubted that the function of these avicularia is the protection of the tentacles and compensation-sac. The suggestion that they are concerned in feeding does not rest on any definite evidence, and is probably erroneous. But avicularia or vibracula may also occur in other places—on the backs of unilaminar erect forms, along the sutural lines of the zoecia and on their frontal surface. These are probably important in checking overgrowth by encrusting organisms, and in particular by preventing larvae from fixing on the zoarium. Vibracula are of less frequent occurrence than avicularia, with which they may coexist as in *Scrupocellaria*, where they occur on the backs of the unilaminar branches. In the so-called Selenariidae, probably an unnatural association of genera which have assumed a free discoidal form of zoarium, they may reach a very high degree of development, but Busk's suggestion that in this group they "may be subservient to locomotion" needs verification.

Development and Affinities.—It is generally admitted that the larva of the Entoprocta (fig. 11) has the structure of a Trochosphere. This appears to indicate that the Polyzoa are remotely allied to other phyla in which this type of larva prevails, and in particular to the Mollusca and Chaetopoda, as well as to the Rotifera, which are regarded as persistent Trochospheres. The praecoral portion (lower in fig. 11) constitutes the greater part of the larva and contains most of the viscera. It is terminated by a well-developed structure (fg) corresponding with the apical sense-organ of ordinary Trochospheres, and an excretory organ (nph) of the type familiar in these larvae occurs on the ventral side of the stomach. The central nervous system (x) is highly developed, and in *Loxosoma* bears a pair of eyes. The larva swims by a ring of cilia, which corresponds with the praecoral cirrlet of a Trochosphere. The oral surface, on which are situated the mouth (m) and anus (a), is relatively small. The apical sense-organ is used for temporary attachment to the maternal vestibule in which development takes place, but permanent fixation is effected by the oral surface. This is followed by the atrophy of many of the larval organs, including the brain, the sense-organ and the ciliated ring. The alimentary canal persists and revolves in the median plane through an angle of 180°, accompanied by part of the larval vestibule, the space formed by the retraction of the oral surface. The vestibule breaks through to the exterior, and the tentacles, which have been developed within it, are brought into relation with the external water.

pora pilosa, the pelagic larva is known as *Cyphonautes*, and it has a structure not unlike that of the larval *Pedicellina*. The principal differences are the complication of the ciliated band, the absence of the excretory organ, the great lateral compression of the body, the possession of a pair of shells protecting the sides, the presence of an organ known as the "pyriform organ," and the occurrence of a sucker in a position corresponding with the depression seen between (m) and (a) in fig. 11. Fixation takes place by means of this sucker, which is everted for the purpose, part of its epithelium becoming the basal ectoderm of the ancestrula. The pyriform organ has probably assisted the larva to find an appropriate place for fixation (cf. Kupelwieser, 18); but, like the alimentary canal and most of the other larval organs, it undergoes a process of histolysis, and the larva becomes the ancestrula, containing the primary brown body derived from the purely larval organs. The polypide is formed, as in an ordinary zoecium after the loss of its polypide, from a polypide-bud.

The *Cyphonautes* type has been shown by Prouho (24) to occur in two or three widely different species of Cheilostomata and Ctenostomata in which the eggs are laid and develop in the external water. In most Ectoprocta, however, the development takes place internally or in an ovicell, and a considerable quantity of yolk is present. The alimentary canal, which may be represented by a vestigial structure, is accordingly not functional, and the larva does not become pelagic. A pyriform organ is present in most Gymnolaemata as well as the sucker by which fixation is effected. As in the case of *Cyphonautes*, the larval organs degenerate and the larva becomes the ancestrula from which a polypide is developed as a bud. In the Cyclostomata the primary embryo undergoes repeated fission without developing definite organs, and each of the numerous pieces so formed becomes a free larva, which possesses no alimentary canal. Finally, in the Phylactolaemata, the larva becomes an ancestrula before it is hatched, and one or several polypides may be present when fixation is effected.

The development of the Ectoprocta is intelligible on the hypothesis that the Entoprocta form the starting-point of the series. On the view that the Phylactolaemata are nearly related to *Phoronis* (see PHORONIDEA), it is extremely difficult to draw any conclusions with regard to the significance of the facts of development. If the Phylactolaemata were evolved from the type of structure represented by *Phoronis* or the Pterobranchia (q.v.), the Gymnolaemata should be a further modification of this type, and the comparative study of the embryology of the two orders would appear to be meaningless. It seems more natural to draw the conclusion that the resemblances of the Phylactolaemata to *Phoronis* are devoid of phylogenetic significance.

BIBLIOGRAPHY.—For general accounts of the structure and development of the Polyzoa the reader's attention is specially directed to 12, 14, 6, 25, 1, 2, 17, 26, 18, 23, 3, in the list given below; for an historical account to 1; for a full bibliography of the group, to 22; for fresh-water forms, to 1-3, 7-10, 17; for an indispensable synonymic list of recent marine forms, to 15; for Entoprocta, to 10, 11, 24; for the classification of Gymnolaemata, to 21, 14, 4, 13, 20; for Palaeontology, to 27, 22.

References to important works on the species of marine Polyzoa by Busk, Hincks, Jullien, Levensen, MacGillivray, Nordgaard, Norman, Waters and others are given in the Memoir (22) by Nickles and Bassler. (1) Allman, "Monogr. Fresh-water Polyzoa," *Ray Soc.* (1856). (2) Braem, "Bry. d. süßen Wassers," *Bibl. Zool.* Bd. ii. Heft 6 (1890). (3) Braem, "Entwickel. v. *Plumatella*," *ibid.*, Bd. x. Heft 23 (1897). (4) Busk, "Report on the Polyzoa," "Challenger" *Rep.* pt. xxx. (1884), 50 (1886). (5) Caldwell, "Phoronis," *Proc. Roy. Soc.* (1883), xxiv. 371. (6) Calvet, "Bry. Ectoproctes Marins," *Trav. Inst. Montpellier* (new series), *Mém.* 8 (1900). (7) Cori, "Nephridien d. *Cristatella*," *Zeitschr. wiss. Zool.* (1893), lv. 626. (8) Davenport, "Cristatella," *Bull. Mus. Harvard* (1890-1891), xx. 101. (9) Davenport, "Paludicella," *ibid.* (1891-1892), xxii. 1. (10) Davenport, "Urnatella," *ibid.* (1893), xxiv. 1. (11) Ehlers, "Pedicellineen," *Abh. Ges. Göttingen* (1890), xxxvi. (12) Harmer, "Polyzoa," *Cambr. Nat. Hist.* (1896), ii. 463; art. "Polyzoa," *Ency. Brit.* (10th ed., 1902), xxxi. 826. (13) Harmer, "Morph. Cheilostomata," *Quart. Journ. Mic. Sci.* (1903), xlvii. 263. (14) Hincks, "Hist. Brit. Mar. Pol." (1880). (15) Jelly, "Syn. Cat. Recent Mar. Bry." (1889). (16) Jullien and Calvet, "Bryozoa," *Rés. camp. sci. prince de Monaco* (1903), xxiii. (17) Kraepelin, "Deutsch. Süßwasser-Bry.," *Abh. Ver. Hamburg* (1887), x.; (1892), xii. (18) Kupelwieser, "Cyphonautes," *Zoologica* (1906), Bd. xix. Heft 47. (19) Lankester, art. "Polyzoa," *Ency. Brit.* (9th ed., 1885), xix. 429. (20) Levensen, "Bryozoa," *Vid. Medd. Naturh. Foren.* (Copenhagen, 1902). (21) MacGillivray, "Cat. Mar. Pol. Victoria," *P. Roy. Soc. Victoria* (1887), xxiii. 187. (22) Nickles and Bassler, "Synopsis Amer. Foss. Bry.," *Bull. U.S. Geol. Survey* (1900), No. 173. (23) Pace, "Dev. *Flustrilla*," *Quart. Journ. Mic. Soc.* (1906), 50, pt. 3. 435. (24) Prouho, "Loxosomas," *Arch. Zool. Exp.* (2) (1891), ix. 91. (25) Prouho, "Bryozoa," *ibid.* (2) (1892), x. 557. (26) Seeliger, "Larven'u. Verwandtschaft," *Zeitschr. wiss. Zool.* (1906), lxxxiv. 1. (27) Ulrich, "Fossil Polyzoa," in Zittel's *Text-book of Palaeontology*, Eng. ed. (1900), i. 257. (S. F. H.)

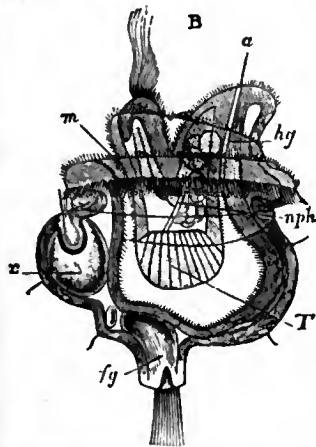

(After Hatschek.)
FIG. 11.—Larva of *Pedicellina*.

- a, Anus.
- fg, Apical sense-organ.
- hg, Intestine.
- l, Ventral wall of stomach.
- m, Mouth.
- nph, Excretory organ.
- x, Brain.

by the oral surface. This is followed by the atrophy of many of the larval organs, including the brain, the sense-organ and the ciliated ring. The alimentary canal persists and revolves in the median plane through an angle of 180°, accompanied by part of the larval vestibule, the space formed by the retraction of the oral surface. The vestibule breaks through to the exterior, and the tentacles, which have been developed within it, are brought into relation with the external water.

In the common and widely-distributed Cheilostome, *Membranipora*

POMADE, or **POMATUM**, a scented ointment, used formerly for softening and beautifying the skin, as a lip-salve, &c., but now principally applied to the hair. It was made originally from the juice of apples (Lat. *pomum*), whence the name.

POMANDER (from Fr. *pomme d'ambre*, i.e. apple of amber), a ball made of perfumes, such as ambergris (whence the name), musk, civet, &c., and formerly worn or carried in a case, also known by the same name, as a protection against infection in times of pestilence or merely as a useful article to modify bad smells. The globular cases which contained the "pomanders" were hung from a neck-chain or attached to the girdle, and were usually perforated and made of gold or silver. Sometimes they contained several partitions, in each of which was placed a different perfume. There is an early Spanish pomander set with emeralds, and a fine 16th-century one, dredged from the Thames, in the British Museum.

POMBAL, SEBASTIÃO JOSE DE CARVALHO E MELLO, MARQUESS OF (1699-1782), Portuguese statesman, was born at Soure near Pomba, on the 13th of May 1699. He was the son of Manoel de Carvalho e Athayde, a country gentleman (*fidalgos*) and of his wife D. Theresa Luiza de Mendonça e Mello. He studied law at Coimbra University, served for a short time as a private in the army, and afterwards lived the life of a man about town in Lisbon, sharing in the diversions of the "Mohocks" who then infested the streets. In 1733 he abducted and married D. Theresa de Noronha, a widow belonging to one of the most distinguished families in Portugal. He then retired to Soure, where, on the recommendation of Cardinal de Motta, King John V. commissioned him to write a series of biographical studies. In 1739 he was sent as Portuguese ambassador to London, where he remained until 1745. He was then transferred to Vienna. His first wife having died on the 7th of January 1739, he married, on the 18th of December 1745, Leonora Ernestine Daun, daughter of General Count Daun. In 1749 he was recalled to take up the post of secretary of state for foreign affairs and war. The appointment was ratified on the 3rd of August 1750, by King Joseph, who had succeeded John V. in that year. Carvalho's career from 1750 to 1777 is part of the history of Portugal. Though he came into power only in his 51st year, without previous administrative experience, he was able to reorganize Portuguese education, finance, the army and the navy. He also built up new industries, promoted the development of Brazil and Macao, and expelled the Jesuits. His complete ascendancy over the mind of King Joseph dates from the time of the great Lisbon earthquake (Nov. 1, 1755). Though the famous words "Bury the dead and feed the living" were probably not spoken by him, they summarize his action at this time of calamity. In June 1759 his suppression of the so-called "Tavora plot" gained for him the title of count of Oeyras; and in September 1770 he was made marquess of Pombal. His severe administration had made many enemies, and his life had been attempted in 1769. Soon after the death of King Joseph, in 1777, Pombal was dismissed from office; and he was only saved from impeachment by the death of his bitterest opponent, the queen-mother, Mariana Victoria, in January 1781. On the 16th of August a royal decree forbade him to reside within twenty leagues of the court. He died at Pombal on the 8th of May 1782.

See, in addition to the works dealing with the period 1750-1777 and quoted under PORTUGAL: *History*; S.J.C.M. (Pombal), *Relação abreviada*, &c. (Paris, 1758); *Memoirs of the Court of Portugal*, &c. (London, 1765); *Anecdotes du ministère de Pombal* (Warsaw, 1781); *Administration du marquis de Pombal* (4 vols., Amsterdam, 1787); *Cartas . . . do marquis de Pombal* (3 vols., Lisbon, 1820-1824); J. Smith, Count of Carnota, *Memoirs of the Marquess of Pombal*, &c. (London, 1843); F. L. Gomes, *Le Marquis de Pombal*, &c. (Paris, 1869); B. Duhr (S.J.), *Pombal*, &c. (Freiburg im Breisgau, 1891); C. J. de Menezes, *Os Jesuitas e o marquis de Pombal* (Oporto, 1893). See also articles in the *Revue des deux mondes* for September 1870; the *Revue bleue* for September 1889, and the *Revue historique* for September 1895 and January 1896.

POMEGRANATE. The pomegranate (*Punica Granatum*) is of exceptional interest by reason of its structure, its history, and its utility. It forms a tree of small stature, or a bush, with opposite or alternate, shining, lance-shaped leaves, from the

axils of some of which proceed the brilliant scarlet flowers. These are raised on a short stalk, and consist of a thick fleshy cylindrical or bell-shaped calyx-tube, with five to seven short lobes at the top. From the throat of the calyx proceed five to



FIG. 1.—Pomegranate, *Punica Granatum*, flowering branch, half natural size.

- 1, Flower cut lengthwise; the petals have been removed. 3, Same cut across, showing seeds.
2, Fruit, about one-third natural size. 4, Seed, natural size.

seven roundish, crumpled, scarlet or crimson petals, and below them very numerous slender stamens. The pistil consists of two rows of carpels placed one above another, both rows embedded in, and partially inseparable from, the inner surface of the calyx-tube. The styles are confluent into one slender column. The fruit, which usually attains the size of a large orange, consists



(After Eichler, from Strasburger's *Lehrbuch der Botanik*, by permission of Gustav Fischer.)

FIG. 2.—*Punica Granatum*.

A, Floral diagram. B, Longitudinal section of the ovary.

of a hard leathery rind, enclosing a quantity of pulp derived from the coats of the numerous seeds. This pulp, filled as it is with refreshing acid juice, constitutes the chief value of the tree. The more highly cultivated forms contain more of it than the wild or half-wild varieties. The great structural peculiarity consists in the presence of the two rows of carpels one above another (a state of things which occurs exceptionally in apples and oranges), and in the fact that, while in the lower series the seeds are attached to the inner border or lower angle of the cavity, they occupy the outer side in the upper series, as if during growth the upper whorl had become completely bent over.

By Bentham and Hooker the *Punica* is included as an anomalous genus in the order Lythraceae; others consider it more nearly allied to the myrtles; while its peculiarities are so great as, in the opinion of many botanists, to justify its inclusion in a

separate order, Punicaceae. Not only is the fruit valuable in hot countries for the sake of its pulp, but the rind and the bark and the outer part of the root (containing the alkaloid *peltierine*) are valuable as astringents. The bark of the root is likewise valued as an anthelmintic in cases of tape-worm.

The tree is wild in Afghanistan, north-western India, and the districts south and south-west of the Caspian, but it has been so long cultivated that it is difficult to say whether it is really native in Palestine and the Mediterranean region. It has been cited as wild in northern Africa, but this appears to be a mistake. Professor Bayley Balfour met with a wild species, heretofore unknown, in the island of Socotra, the flowers of which have only a single row of carpels, which suggests the inference that it may have been the source of the cultivated varieties. But, on the other hand, in Afghanistan, where Aitchison met with the tree truly wild, a double row of carpels was present as usual. The antiquity of the tree as a cultivated plant is evidenced by the Sanskrit name *Dādīmba*, and by the references to the fruit in the Old Testament, and in the *Odyssey*, where it is spoken of as cultivated in the gardens of the kings of Phœacia and Phrygia. The fruit is frequently represented on ancient Assyrian and Egyptian sculptures, and had a religious significance in connexion with several Oriental cults, especially the Phrygian cult of Cybele (Arnob. v. 5 seq.; see also Baudissin, *Studien*, ii. 207 seq.). It was well known to the Greeks and Romans, who were acquainted with its medicinal properties and its use as a tanning material. The name given by the Romans, *malum punicum*, indicates that they received it from Carthage, as indeed is expressly stated by Pliny; and this circumstance has given rise to the notion that the tree was indigenous in northern Africa. On a review of the whole evidence, botanical, literary and linguistic, Alphonse de Candolle (*Origin of Cultivated Plants*) pronounces against its African origin, and decides in favour of its source in Persia and the neighbouring countries. According to Saporta, the pomegranate existed in a fossil state in beds of the Pliocene epoch near Meximieux in Burgundy. The pomegranate is sometimes met with in cultivation against a wall in England, but it is too tender to withstand a severe winter. The double-flowered varieties are specially desirable for the beauty and long duration of their flowers.

POMERANIA (German, *Pommern*), a territory of Germany and a maritime province of Prussia, bounded on the N. by the Baltic, on the W. by Mecklenburg, on the S. by Brandenburg, and on the E. by West Prussia. Its area is 11,630 sq. m., and the population in 1905 was 1,684,125, showing a density of 145 inhabitants to the square mile. The province is officially divided into the three districts of Stralsund, Stettin and Köslin, but more historical interest attaches to the names of Vorpommern and Hinterpommern, or Hither and Farther Pomerania, the former being applied to the territory to the west, and the latter to that to the east of the Oder. Pomerania is one of the flattest parts of Germany, although east of the Oder it is traversed by a range of low hills, and there are also a few isolated eminences to the west. Off the west coast, which is very irregular, lie the islands of Rügen, Usedom and Wollin; the coast of Farther Pomerania is smooth in outline and is bordered with dunes, or sandbanks. Besides the Oder and its affluents, the chief of which are the Peene, the Ücker and the Ihna, there are several smaller rivers flowing into the Baltic; a few of these are navigable for ships, but the greater number only carry rafts. Many of them end in small lakes, which are separated from the sea by narrow strips of land, through which the water escapes by one or more outlets. The interior of the province is also thickly sprinkled with lakes, the combined area of which is equal to about one-twentieth of the entire surface.

The soil of Pomerania is for the most part thin and sandy, but patches of good land are found here and there. About 55% of the whole is under tillage, while 16% consists of meadow and pasture and 21% is covered by forests. The principal crops are potatoes, rye and oats, but wheat and barley are grown in the more fertile districts; tobacco, flax, hops and beetroot are also cultivated. Agriculture is still carried on in a somewhat

primitive fashion, and as a rule the livestock is of an inferior quality, though the breed of horses, of a heavy build and mostly used in agriculture, is held in high esteem. Large flocks of sheep are kept, both for their flesh and their wool, and there are in the province large numbers of horned cattle and of pigs. Geese and goose feathers form lucrative articles of export. Owing to the long line of coast and the numerous lakes, fishing forms an important industry, and large quantities of herrings, eels and lampreys are sent from Pomerania to other parts of Germany. With the exception of the almost inexhaustible layers of peat, the mineral wealth of the province is insignificant. Its industrial activity is not great, but there are manufactures of machinery, chemicals, paper, tobacco and sugar; these are made chiefly in or near the large towns, while linen-weaving is practised as a domestic industry. Ship-building is carried on at Stettin and at several places along the coast. The commerce of Pomerania is in a flourishing condition, its principal ports being Stettin, Stralsund and Swinemünde. Education is provided for by a university at Greifswald and by numerous schools. The province sends 14 members to the German Reichstag, and 26 to the Prussian house of representatives. The heir to the Prussian crown bears the title of governor of Pomerania.

History.—In prehistoric times the southern coast of the Baltic seems to have been occupied by Celts, who afterwards made way for tribes of Teutonic stock. These in their turn migrated to other settlements and were replaced, about the end of the 5th century of our era, by Slavonic tribes, the Wilzi and the Pomerani. The name of Pomore, or Pommern, meaning "on the sea," was given to the district by the latter of the tribes about the time of Charlemagne, and it has often changed its political and geographical significance. Originally it seems to have denoted the coast district between the Oder and the Vistula, a territory which was at first more or less dependent on Poland, but which, towards the end of the 12th century, was ruled by two native princes, who took the title of duke about 1170 and admitted the authority of the German king in 1181. Afterwards Pomerania extended much farther to the west, while being correspondingly curtailed on the east, and a distinction was made between Slavonia, or modern Pomerania, and Pomerellen. The latter, corresponding substantially to the present province of West Prussia, remained subject to Poland until 1309, when it was divided between Brandenburg and the Teutonic Order. Christianity was introduced in the 12th century, a bishopric being founded in the Island of Wollin, and its advance went rapidly hand in hand with the Germanizing of the district.

The history of Pomerania, as distinct from that of Pomerellen, consists mainly of an almost endless succession of divisions of territory among the different lines of the ducal house, and of numerous expansions and contractions of territory through constant hostilities with the elector of Brandenburg, who claimed to be the immediate feudal superior of Pomerania, and with other neighbouring rulers. The names of Vorpommern and Hinterpommern were at first synonymous with Pomerania proper, or Slavonia and Pomerellen, but towards the close of the 14th century they were transferred to the two duchies into which the former was divided. In 1625 the whole of Pomerania became united under the sway of Duke Bogislaus XIV., and on his death without issue, in 1637, Brandenburg claimed the duchy by virtue of a compact made in 1571. In the meantime, however, Pomerania had been devastated by the Thirty Years' War and occupied by the Swedes, who had taken possession of its towns and fortresses. At the peace of Westphalia they claimed the duchy, in opposition to the elector of Brandenburg, and the result was that the latter was obliged to content himself with eastern Pomerania (Hinterpommern), and to see the western part (Vorpommern) awarded to Sweden. In 1720, by the peace of Stockholm, Swedish Pomerania was curtailed by extensive concessions to Prussia, but the district to the west of the Peene remained in the possession of Sweden until the general European settlement of 1815. Then Sweden assigned her German possessions to Denmark in exchange for Norway, whereupon Prussia, partly by purchase and partly by the cession

of the duchy of Lauenburg, finally succeeded in uniting the whole of Pomerania under her rule.

For the history, see J. Bugenhagen, *Pomerania*, edited by O. Heinemann (Stettin, 1900); von Bohlen, *Die Erwerbung Pommerns durch die Hohenzollern* (Berlin, 1865); H. Berghaus, *Landbuch des Herzogtums Pommern* (Berlin, 1865-1876); the *Codex Pomeranicus diplomaticus*, edited by K. F. W. Hasselbach and J. G. L. Kosgarten (Greifswald, 1862); the *Pommersches Urkundenbuch*, edited by R. Klempin and others (Stettin, 1868-1896); W. von Sommerfeld, *Geschichte der Germanisierung des Herzogtums Pommern* (Leipzig, 1896); F. W. Barthold, *Geschichte von Rügen und Pommern* (Hamburg, 1839-1845); K. Mass, *Pommersche Geschichte* (Stettin, 1899); M. Wehrmann, *Geschichte von Pommern* (Gotha, 1904-1906); and Uecker, *Pommern in Wort und Bild* (Stettin, 1904). See also the publications of the *Gesellschaft für pommersche Geschichte und Altertumskunde*.

POMEROY, a village and the county-seat of Meigs county, Ohio, U.S.A., on the Ohio river, about 85 m. S.S.E. of Columbus. Pop. (1890) 4726; (1900) 4639, including 453 foreign-born and 280 negroes; (1910) 4023. Pomeroy is served by the Hocking Valley and (across the river) Baltimore & Ohio railways, by inter-urban electric railway, and by passenger and freight boats to the leading river ports. It occupies a strip of ground between the river and a range of steep hills. Bituminous coal and salt abound in the district, and there are deposits of building stone, fireclay and glass sand. The first settlement here was established in 1816, coal mining was begun three years later, and in 1827 a town was laid out and named Nyesville. There was little progress, however, until 1833, when Samuel W. Pomeroy (in whose honour the present name was adopted) formed a company, which began mining coal on a large scale. Pomeroy was incorporated as a village and was made the county-seat in 1841. In 1850 the first of several salt wells, from 1000 to 1200 ft. in depth, was operated.

POMFRET, JOHN (1667-1702), English poet, son of Thomas Pomfret, vicar of Luton, was born in 1667. He was educated at Bedford grammar school and at Queens' College, Cambridge. He became rector of Maulden, Bedfordshire, in 1695, and of Millbrook in the same county in 1702. Dr Johnson says that the bishop of London refused to sanction preferment for him because in his *Choice* he declared that he would have no wife, although he expressed a wish for the occasional company of a modest and sprightly young lady. The poet was married in real life all the same, and—while waiting to clear up the misunderstanding with the bishop—he died in November 1702. *The Choice or Wish: A Poem written by a Person of Quality* (1700) expresses the epicurean desires of a cultivated man of Pomfret's time. It is smoothly written in the heroic couplet, and was widely popular. His *Miscellany Poems* were published in 1702.

POMMEL (through O. Fr. *pomel*, from a diminutive *pomellus* of Lat. *pomum*, fruit, apple), any rounded object resembling an apple, e.g. the rounded termination of a saddle-bow; in architecture, any round knob, as a boss, finial, &c.; more particularly the rounded end to the hilt of a sword, dagger or other hand weapon, used to prevent the hand from slipping, and as a balance to the blade. "Pommel" is also a term used of a piece of grooved wood used in graining leather. This word may be the same in origin, or more probably from Fr. *paumelle*, from *paume*, the hand, palm.

POMMER, or **BOMBARD** (Fr. *hautbois*; Ital. *bombardo*, *bombardone*), the alto, tenor and basses of the shawm or *Schalmey* family, and the forerunners respectively of the cor-anglais, bassoon or fagotto, and double bassoon or contrafagotto. The main difference to the casual observer between the medieval instruments and those of our orchestra which were evolved from them would be one of size. In the Pommers no attempt had been made to bend the tube, and its length, equal to that of an open organ pipe of the same pitch, was outstretched in all its unwieldiness in an oblique position in front of the performer. The great contrabass Pommer was 9 ft. long without the crook and reed, which, however, were bent downwards. It had five open fingerholes and five keys working inside a perforated case; in order to bring the holes within reach of the finger, they were cut obliquely through the tube. The compass extended

from F below 8 ft. C to E or F in the bass staff, two octaves in all. The other members of the family were the bass Pommer, from 8 ft. C to middle C, corresponding to the modern bassoon or fagotto; the tenor or basset Pommer, a fifth higher in pitch; the alto pommer or *nicolo*, a fourth or a fifth above the tenor; and the high alto, or Klein Alt Pommer, an octave higher than the tenor, corresponding approximately to the cor-anglais.

For the history of the Pommer family see OBOE and BASSOON. (K. S.)

POMONA, an old Italian goddess of fruit and gardens. Ovid (*Met.* xiv. 623) tells the story of her courtship by the silvan deities and how Vertumnus, god of the turning year, wooed and won her. Corresponding to Pomona there seems to have been a male Italian deity, called Pomunus, who was perhaps identical with Vertumnus. Although chiefly worshipped in the country, Pomona had a special priest at Rome, the flamen Pomonalis, and a sacred grove near Ostia, called the Pomonal. She was represented as a beautiful maiden, with fruits in her bosom and a pruning-knife in her hand.

POMONA, a city of Los Angeles county, in southern California, U.S.A., about 33 m. E. of the city of Los Angeles. Pop. (1890) 3634; (1900) 5526 (567 foreign-born); (1910) 10,207. It is served by the Southern Pacific, the San Pedro, Los Angeles & Salt Lake, and the Atchison, Topeka & Santa Fe railways, and by an inter-urban electric line. The city is about 850 ft. above sea-level, and has a Carnegie library and several parks, including Ganesha park (45 acres), which commands a fine view. At Claremont, about 3 m. north, is Pomona College (1888, co-educational), which in 1908 had 34 instructors and 488 students. Pomona is in the midst of a prosperous fruit region, devoted especially to the growing of oranges. Orchards of oranges, lemons, apricots, peaches and prunes surround the city for miles, and some olives are grown; alfalfa and sugar-beets are raised in large quantities in the immediate neighbourhood. Pomona was settled by a colony of fruit-growers in 1875, and was chartered as a city in 1888.

POMONA, or **MAINLAND**, the 'central and largest island of the Orkneys, Scotland. Pop. (1901), 16,235. It is 25 m. long from N.W. to S.E. and 15 m. broad from E. to W.; area, 190 sq. m.; but where the coast is cut into, on the N. by Kirkwall Bay and on the S. by Scapa Flow, the land is less than 2 m. across. Consequently, the portion of the island to the west of the waist of Pomona is sometimes described as the West Island, and the portion to the East as the East Island. The west coast is almost unbroken, the bays of Birsay and Skailf being the only bays of any importance. The east and south shores, on the other hand, are extensively carved out. Thus on the east side are found Eynhallow Sound, Wood Wick, the bays of Isbister, Firth, Kirkwall, and Inganess and Dee Sound, and on the south Holm Sound, Scapa Bay, Swanbister Bay and Bay of Ireland. The highest points of the watershed from Costa Head to the Scapa shore are Milldoe (734 ft.) to the north-east of Isbister and Wideford Hill (740 ft.) to the west of Kirkwall. There are also a few eminences towards the south-west, Ward Hill (880 ft.) in the parish of Orphir being the highest peak in the island. There are numerous lakes, some of considerable size and most of them abounding with trout. Loch Harray is $4\frac{1}{2}$ m. long by from $\frac{1}{2}$ m. to about 2 m. wide, and Loch Stenness $3\frac{1}{4}$ m. long by from $\frac{1}{2}$ to $2\frac{1}{4}$ m. wide. Lochs Swannay, Boardhouse and Hundland are situated in the extreme north, while Loch Kirbister lies near the south coast and Loch Tankerness adjoins Deer Sound. Off the east coast lie the islands of Rousay, Egilshay, Viera, Eynhallow, Gairsay and Shapinsay, and off the south Copinsay and Lamb Holm. The hilly country is mostly moorland, and peat-mosses are met with in some of the low-lying land, but many of the valleys contain fertile soil, and there are productive tracts on the eastern and northern seaboard. Kirkwall, the capital of the Orkneys, and Stromness are the only towns.

In Harray, the only parish in the Orkneys not trenched at some point by the sea, Norse customs have survived longer than elsewhere in the group save in North Ronaldshay. In Deerness

the most easterly parish in Pomona, were buried 200 Covenanters, taken prisoners at the battle of Bothwell Brig. They were carried to Barbados, to be sold as slaves for the plantations, when the ship foundered in Deer Sound, and all were drowned. In Sandside Bay, in the same parish, the fleet of Malcolm Canmore was defeated by that of Jarl Thorfinn; and at Summersdale, towards the northern base of the hills of Orphir, Sir James Sinclair, governor of Kirkwall, vanquished Lord Sinclair and 500 Caithness men in 1529.

The antiquities of Pomona are of great interest. The examples of Pictish remains include *brochs* or round towers, chambered mounds, or buildings of stone covered in with earth, and weems, or underground dwellings afterwards roofed in. At Saverock, on the west wing of Kirkwall Bay, a good specimen of an earth-house will be found, and at Quanterness, 1 m. to the west of it, a chambered mound, containing seven rooms with beehive roofs. Farther west and 5 m. by road north-east of Stromness, and within a mile of the stone circles of Stenness, stands the great barrow or chambered mound of Maeshowe. The tumulus has the form of a blunted cone, is 36 ft. high, 300 ft. in circumference and 92 ft. in diameter, and at a distance of 90 ft. from its base is encircled by a moat 40 ft. wide and from 4 ft. to 8 ft. deep. The ground-plan shows that it was entered from the west by a passage, 54 ft. long, from 2 ft. to 3 ft. wide and from 2½ ft. to 4½ ft. high, which led to a central apartment about 15 ft. square, the walls of which ended in a beehive roof, the spring of which began at a height of 13 ft. from the floor. This room and the passage are built of undressed blocks and slabs of sandstone. About the middle of each side of the chamber, at a height of 3 ft. from the floor, there is an entrance to a small cell, 3 ft. high, 4½ ft. wide and from 5½ ft. to 7 ft. long. Mr James Farrer explored the mound in 1861, and discovered on the walls and certain stones rude drawings of crosses, a winged dragon, and a serpent curled round a pole, besides a variety of Runic inscriptions. One of these inscriptions stated that the tumulus had been rifled by Norse pilgrims (possibly crusaders) on their way to Jerusalem under Jarl Rognvald in the 12th century. There can be little doubt but that it was a sepulchral chamber. Joseph Anderson ascribes it to the Stone Age (that is, to the Picts), and James Fergusson to Norsemen of the 10th century.

The most interesting of all those links with a remote past are the stone circles forming the Ring of Brogar and the Ring of Stenness, often inaccurately described as the Stones of Stenness. The Ring of Brogar is situated to the north-west and the Ring of Stenness to the south-east of the Bridge of Brogar, as the narrow causeway of stone slabs is called which separates Loch Harray from Loch Stenness. The district lies some 4½ m. north-east of Stromness. The Ring of Brogar, once known as the Temple of the Sun, stands on a raised circular platform of turf, 340 ft. in diameter, surrounded by a moat about 6 ft. deep, which in turn is invested by a grassy rampart. The ring originally comprised 60 stones, set up at intervals of 17 ft. Only 13 are now erect. Ten, still entire, lie prostrate, while the stumps of 13 others can yet be recognized. The height of the stones varies from 9 ft. to 14 ft. The Ring of Stenness—the Temple of the Moon of local tradition—is of similar construction to the larger circle, except that its round platform is only 104 ft. in diameter. The stones are believed to have numbered 12, varying in height from 15 ft. to 17 ft. but only two remain upright. In the middle of the ring may be seen the relic of what was probably the sacrificial altar. The Stone of Odin, the great monolith, pierced by a hole at a height of 5 ft. from the ground, which figures so prominently in Scott's *Pirate*, stood 150 yds. to the north of the Ring of Stenness. The stones of both rings are of the native Old Red Sandstone.

POMPADOUR, JEANNE ANTOINETTE POISSON LE NORMANT D'ÉTOILES, MARQUISE DE (1721-1764), mistress of Louis XV., was born in Paris on the 29th of December 1721, and baptized as the legitimate daughter of François Poisson, an officer in the household of the duke of Orleans, and his wife, Madeleine de la Motte, in the church of St Eustache; but she

was suspected, as well as her brother, afterwards marquis of Marigny, to be the child of a very wealthy financier and farmer-general of the revenues, Le Normant de Tournem. He at any rate took upon himself the charge of her education; and, as from the beauty and wit she showed from childhood she seemed to be born for some uncommon destiny, he declared her "un morceau de roi," and specially educated her to be a king's mistress. This idea was confirmed in her childish mind by the prophecy of an old woman, whom in after days she pensioned for the correctness of her prediction. In 1741 she was married to a nephew of her protector and guardian, Le Normant d'Étioles, who was passionately in love with her, and she soon became a queen of fashion. Yet the world of the financiers at Paris was far apart from the court world, where she wished to reign; she could get no introduction at court, and could only try to catch the king's eye when he went out hunting. But Louis XV. was then under the influence of Mme de Mailly, who carefully prevented any further intimacy with "la petite Étioles," and it was not until after her death that the king met the fair queen of the financial world of Paris at a ball given by the city to the dauphin in 1744, and he was immediately subjugated. She at once gave up her husband, and in 1745 was established at Versailles as "maîtresse en titre." Louis XV. bought her the estate of Pompadour, from which she took her title of marquise (raised in 1752 to that of duchess). She was hardly established firmly in power before she showed that ambition rather than love had guided her, and began to mix in politics. Knowing that the French people of that time were ruled by the literary kings of the time, she paid court to them, and tried to play the part of a Mæcenæ. Voltaire was her poet in chief, and the founder of the physiocrats, Quesnay, was her physician. In the arts she was even more successful; she was herself no mean etcher and engraver, and she encouraged and protected Vanloo, Boucher, Vien, Greuze, and the engraver Jacques Guay. Yet this policy did not prevent her from being lampooned, and the famous *poissardes* against her contributed to the ruin of many wits suspected of being among the authors, and notably of the Comte de Maurepas. The command of the political situation passed entirely into her hands; she it was who brought Belle-Isle into office with his vigorous policy; she corresponded regularly with the generals of the armies in the field, as her letters to the Comte de Clermont prove; and she introduced the Abbé de Bernis into the ministry in order to effect a very great alteration of French politics in 1756. The continuous policy of France since the days of Richelieu had been to weaken the house of Austria by alliances in Germany; but Mme de Pompadour changed this hereditary policy because Frederick the Great wrote scandalous verses on her; and because Maria Theresa wrote her a friendly letter she entered into an alliance with Austria. This alliance brought on the Seven Years' War, with all its disasters, the battle of Rosbach and the loss of Canada; but Mme de Pompadour persisted in her policy, and, when Bernis failed her, brought Choiseul into office and supported him in all his great plans, the Pacte de Famille, the suppression of the Jesuits, and the peace of Versailles. But it was to internal politics that this remarkable woman paid most attention; no one obtained office except through her; in imitation of Mme de Maintenon, she prepared all business for the king's eye with the ministers, and contrived that they should meet in her room; and she daily examined the letters sent through the post office with Janelle, the director of the post office. By this continuous labour she made herself indispensable to Louis. Yet, when after a year or two she had lost the heart of her lover, she had a difficult task before her; to maintain her influence she had not only to save the king as much trouble as possible, but to find him fresh pleasures. When he first began to weary of her she remembered her talent for acting and her private theatricals at Étioles, and established the "théâtre des petits cabinets," in which she acted with the greatest lords about the court for the king's pleasure in tragedies and comedies, operas and ballets. By this means and the "concerts spirituels" she kept in favour for a time; but at last she found a

surcer way, by encouraging the king in his debaucheries, and Louis wept over her kindness to his various mistresses. Only once, when the king was wounded by Damiens in 1757, did she receive a serious shock, and momentarily left the court; but on his recovery she returned more powerful than ever. She even ingratiated herself with the queen, after the example of Mme de Maintenon, and was made a lady-in-waiting; but the end was soon to come. "Ma vie est un combat," she said, and so it was, with business and pleasure she gradually grew weaker and weaker, and when told that death was at hand she dressed herself in full court costume, and met it bravely on the 15th of April 1764, at the age of forty-two.

See Capefigue, *Madame la marquise de Pompadour* (1858); E. and J. de Goncourt, *Les Maîtresses de Louis XV.*, vol. ii. (1860); and Campardon, *Madame de Pompadour et la cour de Louis XV. au milieu du dix-huitième siècle* (1867). Far more valuable are Malassis's two volumes of correspondence, *Correspondance de Madame de Pompadour avec son père M. Poisson, et son frère M. de Vandières*, &c. (1878), and Bonhomme, *Madame de Pompadour, général d'armée* (1880), containing her letters to the Comte de Clermont. For her artistic and theatrical tastes see particularly J. F. Leturcq, *Notice sur Jacques Guay, graveur sur pierres fines du roi Louis XV.: Documents inédits émanant de Guay et notes sur les œuvres de gravure en taille douce et en pierres durs de la marquise de Pompadour* (1873); and Adolphe Jullien, *Histoire du théâtre de Madame de Pompadour, dit Théâtre des Petits Cabinets* (1874). See also P. de Nolhac, *La Marquise de Pompadour* (1903).

POMPEII,¹ an ancient town of Campania, Italy, situated near the river Sarnus, nearly 2 m. from the shore of the Bay of Naples, almost at the foot of Mt Vesuvius. Of its history before 79 B.C. comparatively little is recorded; but it appears that it had a population of a very mixed character, and passed successively into the hands of several different peoples, each of which contributed an element to its composition. Its foundation was ascribed by Greek tradition to Heracles, in common with the neighbouring city of Herculaneum, but it is certain that it was not a Greek colony, in the proper sense of the term, as we know to have been the case with the more important cities of Cumae and Neapolis. Strabo (v. 4, 8), in whose time it was a populous and flourishing place, tells us that it was first occupied by the Oscans² (to whom we must attribute the Doric temple in the Foro Triangolare), afterwards by the Tyrrhenians (*i.e.* Etruscans) and Pelasgians, and lastly, by the Samnites. The conquest of Campania by the last-mentioned people is an undoubted historical fact, and there can be no doubt that Pompeii shared the fate of the neighbouring cities on this occasion, and afterwards passed in common with them under the yoke of Rome. But its name is only once mentioned during the wars of the Romans with the Samnites and Campanians in this region of Italy, and then only incidentally (Liv. ix. 38), when a Roman fleet landed near Pompeii in 309 B.C. and made an unsuccessful marauding expedition up the river valley as far as Nuceria.³ At a later period, however, it took a prominent part in the outbreak of the nations of central Italy, known as the Social War (91-89 B.C.), when it withstood a long siege by Sulla, and was one of the last cities of Campania that were reduced by the Roman arms. The inhabitants were admitted to the Roman franchise, but a military colony was settled in their territory in 80 B.C. by Sulla (*Colonia Cornelia Veneria Pompeianorum*), and the whole population was rapidly Romanized. The municipal administration here, as elsewhere, was in the hands of two *duoviri iure dicundo* and two aediles, the supreme body being the city council (*decuriones*). Before the close of the republic it became a resort of the Roman nobles, many of whom acquired villas in the neighbourhood. Among them was Cicero, whose letters abound with allusions to his Pompeian villa. The same fashion continued under the empire, and there can be no doubt that, during the first century of the Christian era, Pompeii had become a flourishing place

¹ The etymology of the name is uncertain; the ancients derived it from *pompa* or *πέμπω* (Gr. send), in allusion to the journey of Heracles with the oxen of Geryon, but modern authorities refer it to the Oscan *pompa* (five).

² For the Oscan inscriptions found in Pompeii see below *ad fin.*

³ Pompeii was attacked as a member of the Nucernine League. See Conway, *Italic Dialects*, p. 51; J. Beloch, *Campanien*, 2nd ed., p. 239.

with a considerable population. Two events only are recorded of its history during this period. In A.D. 59 a tumult took place in the amphitheatre between the citizens and visitors from the neighbouring colony of Nuceria. Many were killed and wounded on both sides. The Pompeians were punished for this violent outbreak by the prohibition of all theatrical exhibitions for ten years (Tacitus, *Ann.* xiv. 17). A characteristic, though rude, painting, found on the walls of one of the houses gives a representation of this event.

Four years afterwards (A.D. 63) an earthquake, which affected all the neighbouring towns, vented its force especially upon Pompeii, a large part of which, including most of the public buildings, was either destroyed or so seriously damaged as to require to be rebuilt (Tac. *Ann.* xv. 22; Seneca, *Q.N.* vi. 1). From the existing remains it is clear that the inhabitants were still actively engaged in repairing and restoring the ruined edifices when the whole city was overwhelmed by the great eruption of A.D. 79. Vesuvius (*q.v.*), the volcanic forces of which had been slumbering for unknown ages, suddenly burst into violent eruption, which, while it carried devastation all around the beautiful gulf, buried the two cities of Herculaneum and Pompeii under dense beds of cinders and ashes. It is singular that, while we possess a detailed description of this famous eruption in two letters of the younger Pliny (*Epist.* vi. 16, 20), he does not even notice the destruction of Pompeii or Herculaneum, though his uncle perished in the immediate neighbourhood of the former city. But their fate is noticed by Dio Cassius, and its circumstances may be gathered with certainty from the condition in which the city has been found. These were such as to conduce to its preservation and interest as a relic of antiquity. Pompeii was merely covered with a bed of lighter substances, cinders, small stones and ashes, which fell in a dry state, while at Herculaneum the same substances, being drenched with water, hardened into a sort of tufa, which in places is 65 ft. deep. The whole of this superincumbent mass, attaining to an average thickness of from 18 to 20 ft., was the product of one eruption, though the materials may be divided generally into two distinct strata, the one consisting principally of cinders and small volcanic stones (called in Italian *lapilli*), and the other and uppermost layer of fine white ash, often consolidated by the action of water from above so as to take the moulds of objects contained in it (such as dead bodies, woodwork, &c.), like clay or plaster of Paris. It was found impossible to rebuild the town, and its territory was joined to that of Nola. But the survivors returned to the spot, and by digging down and tunnelling were able to remove all the objects of value, even the marble facing slabs of the large buildings.

In the middle ages, however, the very site was forgotten. Two inscriptions were found in making an underground aqueduct across the site in 1594-1600, but it was not until 1748 that a more careful inspection of this channel revealed the fact that beneath the vineyards and mulberry grounds which covered the site there lay entombed ruins far more accessible, if not more interesting, than those of Herculaneum. It was not till 1763 that systematic excavations were begun; and, though they were carried on during the rest of the 18th century, it was only in the beginning of the 19th that they assumed a regular character; the work, which had received a vigorous stimulus during the period of the French government (1806-1814), was prosecuted, though in a less methodical manner, under the rule of the Bourbon kings (1815-1861). Since 1861 it has been carried on under the Italian government in a more scientific manner, on a system devised by G. Fiorelli (d. 1896), according to which the town is for convenience divided into nine regions—though this rests on a misconception, for there is really no street between the Capua and the Nocera gates—and the results have been of the highest interest, though the rate of progress has been very slow.

The town was situated on rising ground less than a mile from the foot of Vesuvius. This eminence is itself due to an outflow of lava from that mountain, during some previous eruption in prehistoric times, for we know from Strabo that Vesuvius had

been quiescent ever since the first records of the Greek settlements in this part of Italy. Pompeii in ancient times was a prosperous seaport town situated close to the seashore, from which it is now nearly 2 m. distant, and adjoining the mouth of the river Sarnus or Sarno, which now enters the sea nearly 2 m. from its site. The present course of this stream is due in part to modern alteration of its channel, as well as to the effects of the great eruption. The prosperity of Pompeii was due partly to its commerce, as the port of the neighbouring towns, partly to the fertility of its territory, which produced strong wine, olive oil (a comparatively small quantity), and vegetables; fish sauces were made here. Millstones and pumice were also exported, but for the former the more gritty lava of Rocca Monfina was later on preferred.

The area occupied by the ancient city was of an irregular oval form, and about 2 m. in circumference. It was surrounded by a wall, which is still preserved for more than two-thirds of its extent, but no traces of this are found on the side towards the sea, and there is no doubt that on this side it had been already demolished in ancient times, so as to give room for the free extension of houses and other buildings in that direction.¹ These walls are strengthened at intervals by numerous towers, occupying the full width of the wall, which occur in some parts at a distance of only about 100 yds., but in general much less frequently. They are, however, of a different style of construction from the walls, and appear to have been added at a later period, probably that of the Social War. Similar evidences of the addition of subsequent defences are to be traced also in the case of the gates, of which no less than eight are found in the existing circuit of the walls. Some of these present a very elaborate system of defence, but it is evident from the decayed condition of others, as well as of parts of the walls and towers, that they had ceased to be maintained for the purposes of fortification long before the destruction of the city. The names by which the gates and streets are known are entirely of modern origin.

The general plan of the town is very regular, the streets being generally straight, and crossing one another at right angles or nearly so. But exceptions are found on the west in the street leading from the Porta Ercolanese (gate of Herculaneum) to the forum, which, though it must have been one of the principal thoroughfares in the city, was crooked and irregular, as well as very narrow, in some parts not exceeding 12 to 14 ft. in width, including the raised footpaths on each side, which occupy a considerable part of the space, so that the carriage-way could only have admitted of the passage of one vehicle at a time. The explanation is that it follows the line of the demolished city wall. Another exception is to be found in the Strada Stabiana (Stabian Street) or *Cardo*, which, owing to the existence of a natural depression which affects also the line of the street just east of it, is not parallel to the other north and south streets. The other main streets are in some cases broader, but rarely exceed 20 ft. in width, and the broadest yet found is about 32, while the back streets running parallel to the main lines are only about 14 ft. (It is to be remembered, however, that the standard width of a Roman highroad in the neighbourhood of Rome itself is about 14 ft.) They are uniformly paved with large polygonal blocks of hard basaltic lava, fitted very closely together, though now in many cases marked with deep ruts from the passage of vehicles in ancient times. They are also in all cases bordered by raised footways on both sides, paved in a similar manner; and for the convenience of foot-passengers, which was evidently a more important consideration than the obstacle which the arrangement presented to the passage of vehicles, which indeed were probably only allowed for goods traffic, these are connected from place to place by stepping-stones raised above the level of the carriage-way. In other respects they must have resembled those of Oriental cities—the living apartments all opening towards the interior, and showing only blank walls towards

¹ It consisted of two parallel stone walls with buttresses, about 15 ft. apart and 28 in. thick, the intervening space being filled with earth, and there being an embankment on the inner side.

the street; while the windows were generally to be found only in the upper storey, and were in all cases small and insignificant, without any attempt at architectural effect. In some instances indeed the monotony of their external appearance was broken by small shops, occupying the front of the principal houses, and let off separately; these were in some cases numerous enough to form a continuous façade to the street. This is seen especially in the case of the street from the Porta Ercolanese to the forum and the Strada Stabiana (or *Cardo*), both of which were among the most frequented thoroughfares. The streets were also diversified by fountains, small water-towers and reservoirs (of which an especially interesting example was found in 1902 close to the Porta del Vesuvio) and street shrines. The source of the water-supply is unknown.

The first-mentioned of the two principal streets was crossed, a little before it reached the forum, by the street which led directly to the gate of Nola (Strada delle Terme, della Fortuna, and di Nola). Parallel to this last to the south is a street which runs from the Porta Marina through the forum, and then, with a slight turn, to the Sarno gate, thus traversing the whole area of the city from east to west (Via Marina, Strada dell' Abbondanza, Strada dei Diadumeni). These two east and west streets are the two *decumani*.

The population of Pompeii at the time of its destruction cannot be fixed with certainty, but it may very likely have exceeded 20,000. It was of a mixed character; both Oscan and Greek inscriptions are still found up to the last, and, though there is no trace whatever of Christianity, evidences of the presence of Jews are not lacking—such are a wall-painting, probably representing the Judgment of Solomon, and a scratched inscription on a wall, "Sodoma, Gomora." It has been estimated, from the number of skeletons discovered, that about 2000 persons perished in the city itself in the eruption of A.D. 79.

Almost the whole portion of the city which lies to the west of the Strada Stabiana, towards the forum and the sea, has been more or less completely excavated. It is over one-half of the whole extent, and that the most important portion, inasmuch as it includes the forum, with the temples and public buildings adjacent to it, the *thermae*, theatres, amphitheatre, &c. The greater part of that on the other side of the Strada Stabiana remains still unexplored, with the exception of the amphitheatre, and a small space in its immediate neighbourhood.

The forum at Pompeii was, as at Rome itself and in all other Italian cities, the focus and centre of all the life and movement of the city. Hence it was surrounded on all sides by public buildings or edifices of a commanding character. It was not, however, of large size, as compared to the open spaces in modern towns, being only 467 ft. in length by 126 in breadth (excluding the colonnades). Nor was it accessible to any description of wheeled carriages, and the nature of its pavement, composed of broad flags of travertine, shows that it was only intended for foot-passengers. It was adorned with numerous statues, some of the imperial family, others of distinguished citizens. Some of the inscribed pedestals of the latter have been found. It was surrounded on three sides by a series of porticos supported on columns; and these porticos were originally surmounted by a gallery or upper storey, traces of the staircases leading to which still remain, though the gallery itself has altogether disappeared. It is, however, certain from the existing remains that both this portico and the adjacent buildings had suffered severely from the earthquake of 63, and that they were undergoing a process of restoration, involving material changes in the original arrangements, which was still incomplete at the time of their final destruction. The north end of the forum, where alone the portico is wanting, is occupied in great part by the imposing temple of Jupiter, Juno and Minerva being also worshipped here. It was raised on a *podium* 10 ft. high, and had a portico with six Corinthian columns in front. This magnificent edifice had, however, been evidently overthrown by the earthquake of 63, and is in its present condition a mere ruin, the rebuilding of which had not been begun at the time of the eruption, so that the cult of

the three Capitoline divinities was then carried on in the so-called temple of Zeus Milichius. On each side of it were two arches, affording an entrance into the forum, but capable of being closed by gates. On the east side of the forum were four edifices; all of them are of a public character, but their names and attribution have been the subject of much controversy. The first (proceeding from the north), once known as the Pantheon, is generally regarded as a *macellum* or meat-market, consisting of a rectangular court surrounded by a colonnade, with a twelve-sided roofed building (*tholus*) in the centre. On the south side

and Q. Catulus (78 B.C.), and therefore belongs to the Oscan period of the city, before the introduction of the Roman colony. It was an oblong edifice divided by columns into a central hall and a corridor running round all the four sides with a tribunal opposite the main entrance; and, unlike the usual basilicae, it had, instead of a clerestory, openings in the walls of the corridor through which light was admitted, it being almost as lofty as the nave. The temple was an extensive edifice, having a comparatively small *cella*, raised upon a *podium*, and standing in the midst of a wide space surrounded by a portico of columns,

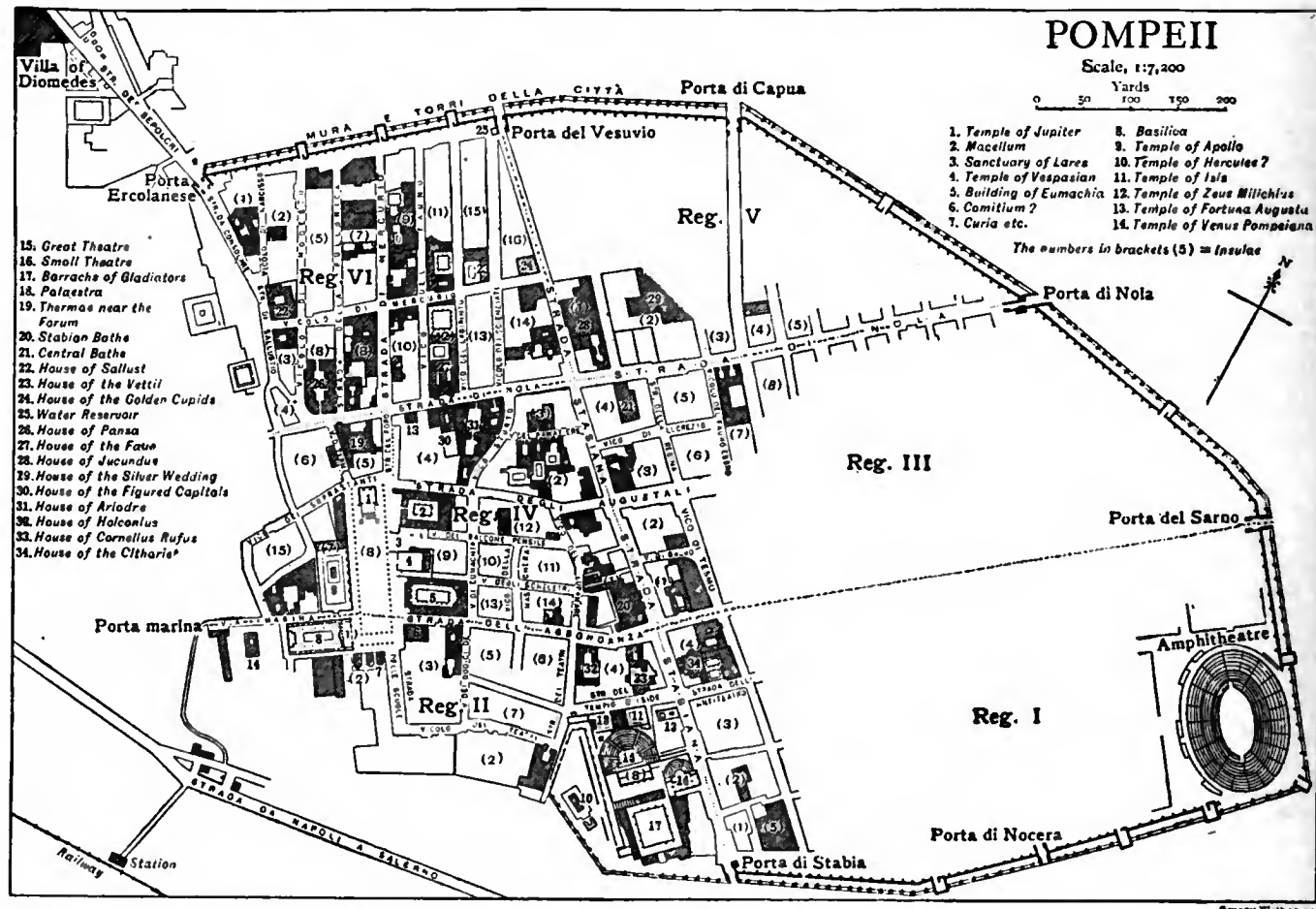

(Redrawn by permission from Baedeker's *Southern Italy*.)

were shops, and in the centre of the east side a chapel for the worship of the imperial house. Next to this comes the sanctuary of the Lares of the city, a square room with a large apse; and beyond this, as Mau proves, the small temple of Vespasian. Beyond this again, bounded on the south by the street known as the Strada dell' Abbondanza, is a large and spacious edifice, which, as we learn from an extant inscription, was erected by a priestess named Eumachia. Its purpose is uncertain—possibly a cloth-exchange, as the fullers set up a statue to Eumachia here. It is an open court, oblong, surrounded on all four sides by a colonnade; in front is a portico facing the forum, and on the other three sides there is a corridor behind the colonnade with windows opening on it. On the south side of the Strada dell' Abbondanza was a building which Mau conjectures to have been the Comitium. At the south end of the forum are three halls side by side, similar in plan with a common façade—the central one, the curia or council chamber, the others the offices respectively of the *dumvirs* and *aediles*, the principal officials of the city; while the greater part of the west side is occupied by two large buildings—a basilica, which is the largest edifice in Pompeii, and the temple of Apollo, which presents its side to the forum, and hence fills up a large portion of the surrounding space. The former, as we learn from an inscription scratched on its walls, was anterior in date to the consulship of M. Lepidus

outside which again is a wall, bounding the sacred enclosure. Between this temple and the basilica the Via Marina leads off direct to the Porta Marina.

Besides the temples which surrounded the forum, the remains of five others have been discovered, three of which are situated in the immediate neighbourhood of the theatres. Of these by far the most interesting, though the least perfect, is one which is commonly known as the temple of Hercules (an appellation wholly without foundation), and which is not only by far the most ancient edifice in Pompeii, but presents us with all the characters of a true Greek temple, resembling in its proportions that of the earliest temple of Selinus, and probably of as remote antiquity (6th century B.C.). Unfortunately only the foundation and a few Doric capitals and other architectural fragments remain; they were coated with stucco which was brightly painted. In front of the temple is a monument which seems to have been the tomb of the founder or founders of the city; so that for a time this must have been the most important temple. The period of its destruction is unknown, for it appears certain that it cannot be ascribed wholly to the earthquake of 63. On the other hand the reverence attached to it in the later periods of the city is evidenced by its being left standing in the midst of a triangular space adjoining the great theatre, which is surrounded by a portico, so as to constitute a kind of forum (the so-called Foro

Triangolare). Not far off, and to the north of the great theatre, stood a small temple, which, as we learn from the inscription still remaining, was dedicated to Isis, and was rebuilt by a certain Popidius Celsinus at the age of six (really of course by his parents), after the original edifice had been reduced to ruin by the great earthquake of 63. Though of small size, and by no means remarkable in point of architecture, it is interesting as the only temple that has come down to us in a good state of preservation of those dedicated to the Egyptian goddess, whose worship became so popular under the Roman Empire. The decorations were of somewhat gaudy stucco. The plan is curious, and deviates much from the ordinary type; the internal arrangements are adapted for the performance of the peculiar rites of this deity. Close to this temple was another, of very small size, commonly known as the temple of Aesculapius, but probably dedicated to Zeus Milichius. More considerable and important was a temple which stood at no great distance from the forum at the point where the so-called Strada di Mercurio was crossed by the wide line of thoroughfare (Strada della Fortuna) leading to the gate of Nola. We learn from an inscription that this was dedicated to the Fortune of Augustus (Fortuna Augusta), and was erected, wholly at his own cost, by a citizen of the name of M. Tullius. This temple appears to have suffered very severely from the earthquake, and at present affords little evidence of its original architectural ornament; but we learn from existing remains that its walls were covered with slabs of marble, and that the columns of the portico were of the same material. The fifth temple, that of Venus Pompeiana, lay to the west of the basilica; traces of two earlier periods underlie the extant temple, which was in progress of rebuilding at the time of the eruption. Before the earthquake of 63 it must have been the largest and most splendid temple of the whole city. It was surrounded by a large colonnade, and the number of marble columns in the whole block has been reckoned at 296.

All the temples above described, except that ascribed to Hercules, which was approached by steps on all four sides, agree in being raised on an elevated *podium* or basement—an arrangement usual with all similar buildings of Roman date. Neither in materials nor in style does their architecture exceed what might reasonably be expected in a second-rate provincial town; and the same may be said in general of the other public buildings. Among these the most conspicuous are the theatres, of which there were two, placed, as was usual in Greek towns, in close juxtaposition with one another. The largest of these which was partly excavated in the side of the hill, was a building of considerable magnificence, being in great part cased with marble, and furnished with seats of the same material, which have, however, been almost wholly removed. Its internal construction and arrangements resemble those of the Roman theatres in general, though with some peculiarities that show Greek influence, and we learn from an inscription that it was erected in Roman times by two members of the same family, M. Holconius Rufus and M. Holconius Celer, both of whom held important municipal offices at Pompeii during the reign of Augustus. It appears, however, from a careful examination of the remains that their work was only a reconstruction of a more ancient edifice, the date of the original form of which cannot be fixed; while its first alteration belongs to the "tufa" period, and three other periods in its history can be traced. Recent investigations in regard to the vexed question of the position of the actors in the Greek theatre have as yet not led to any certain solution.¹ The smaller theatre, which was erected, as we learn from an inscription, by two magistrates specially appointed for the purpose by the decuriones of the city, was of older date than the large one, and must have been constructed a little before the amphitheatre, soon after the establishment of the Roman colony under Sulla. We learn also that it was permanently covered, and it was probably used for musical entertainments, but in the case of the larger theatre also the arrangements for the occasional extension of an awning (*velarium*) over the whole are distinctly found. The

¹ See A. Mau, *Pompeii in Leben und Kunst* (Leipzig, 1908), pp. 150 sqq.

smaller theatre is computed to have been capable of containing fifteen hundred spectators, while the larger could accommodate five thousand.

Adjoining the theatres is a large rectangular enclosure, surrounded by a portico, at first the colonnade connected with the theatres, and converted, about the time of Nero, into the barracks of the gladiators, who were permanently maintained in the city with a view to the shows in the amphitheatre. This explains why it is so far from that building, which is situated at the south-eastern angle of the town, about 500 yds. from the theatres. Remains of gladiators' armour and weapons were found in some of the rooms, and in one, traces of the stocks used to confine insubordinate gladiators. The amphitheatre was erected by the same two magistrates who built the smaller theatre, C. Quinctius Valgus and M. Porcius (the former the father-in-law of that P. Servilius Kullus, in opposition to whose bill relating to the distribution of the public lands Cicero made his speech, *De lege agraria*), at a period when no permanent edifice of a similar kind had yet been erected in Rome itself, and is indeed the oldest structure of the kind known to us. But apart from its early date it has no special interest, and is wholly wanting in the external architectural decorations that give such grandeur of character to similar edifices in other instances. Being in great part excavated in the surface of the hill, instead of the seats being raised on arches, it is wanting also in the picturesque arched corridors which contribute so much to the effect of those other ruins. Nor are its dimensions (460 by 345 ft.) such as to place it in the first rank of structures of this class, nor are there any underground chambers below the arena, with devices for raising wild beasts, &c. But, as we learn from the case of their squabble with the people of Nuceria, the games celebrated in the amphitheatre on grand occasions would be visited by large numbers from the neighbouring towns. The seating capacity was about 20,000² (for illustration see AMPHITHEATRE).

Adjoining the amphitheatre was found a large open space, nearly square in form, which has been supposed to be a forum boarium or cattle-market, but, no buildings of interest being discovered around it, the excavation was filled up again, and this part of the city has not been since examined. Between the entrance to the triangular forum (so-called) and the temple of Isis is the Palaestra, an area surrounded by a colonnade; it is a structure of the pre-Roman period, intended for boys, not men.

Among the more important public buildings of Pompeii were the public baths (*thermae*). Three different establishments of this character have been discovered, of which the first, excavated in 1824, the baths near the forum, built about 80 B.C., was for a long time the only one known. Though the smallest of the three, it is in some respects the most complete and interesting; and it was until of late years the principal source from which we derived our knowledge of this important branch of the economy of Roman life. At Pompeii the baths are so well preserved as to show at a glance the purpose of all the different parts—while they are among the most richly decorated of all the buildings in the city. We trace without difficulty all the separate apartments that are described to us by Roman authors—the *apodyterium*, *frigidarium*, *tepidarium*, *caldarium*, &c. together with the apparatus for supplying both water and heat, the places for depositing the bather's clothes, and other minor details (see BATHS). The greater *thermae* (the so-called "Stabian" baths), which were originally built in the 2nd century B.C., and repaired about 80 B.C., are on a much more extensive scale than the others, and combine with the special purposes of the building a palaestra in the centre and other apartments for exercise or recreation. The arrangements of the baths themselves are, however, almost similar to those of the lesser *thermae*. In this case an inscription records the repair and restoration of the edifice after the

² The interest taken by the Pompeians in the sports of the amphitheatre is shown by the contents of the numerous painted and scratched inscriptions relating to them which have been found in Pompeii—notices of combats, laudatory inscriptions, including even references to the admiration which gladiators won from the fair sex, &c.

earthquake of 63. It appears, however, that these two establishments were found inadequate to supply the wants of the inhabitants, and a third edifice of the same character, the so-called central baths, at the corner of the Strada Stabiana and the Strada di Nola, but on a still more extensive scale, intended for men only, while the other two had separate accommodation for both sexes, was in course of construction when the town was overwhelmed.

Great as is the interest attached to the various public buildings of Pompeii, and valuable as is the light that they have in some instances thrown upon similar edifices in other ruined cities, far more curious and interesting is the insight afforded us by the numerous private houses and shops into the ordinary life and habits of the population of an ancient town. The houses at Pompeii are generally low, rarely exceeding two storeys in height, and it appears certain that the upper storey was generally of a slight construction, and occupied by small rooms, serving as garrets, or sleeping places for slaves, and perhaps for the females of the family. From the mode of destruction of the city these upper floors were in most cases crushed in and destroyed, and hence it was long believed that the houses for the most part had but one storey; but recent researches have in many cases brought to light incontestable evidence of the existence of an upper floor, and the frequent occurrence of a small staircase is in itself sufficient proof of the fact. The windows, as already mentioned, were generally small and insignificant, and contributed nothing to the external decoration or effect of the houses, which took both light and air from the inside, not from the outside. In some cases they were undoubtedly closed with glass, but its use appears to have been by no means general. The principal living rooms, as well as those intended for the reception of guests or clients, were all on the ground floor, the centre being formed by the *atrium*, or hall, which was almost always open above to the air, and in the larger houses was generally surrounded with columns. Into this opened other rooms, the entrances to which seem to have been rarely protected by doors, and could only have been closed by curtains. At the back was a garden. Later, under Greek influences, a peristyle with rooms round it was added in place of the garden. We notice that, as in modern Italy until quite recent years, elaborate precautions were taken against heat, but none against cold, which was patiently endured. Hypocausts are only found in connexion with bathrooms.

All the apartments and arrangements described by Vitruvius and other ancient writers may be readily traced in the houses of Pompeii, and in many instances these have for the first time enabled us to understand the technical terms and details transmitted to us by Latin authors. We must not, however, hastily assume that the examples thus preserved to us by a singular accident are to be taken as representing the style of building in all the Roman and Italian towns. We know from Cicero that Capua was remarkable for its broad streets and widespread buildings, and it is probable that the Campanian towns in general partook of the same character. At Pompeii indeed the streets were not wide, but they were straight and regular, and the houses of the better class occupied considerable spaces, presenting in this respect no doubt a striking contrast, not only with those of Rome itself, but with those of many other Italian towns, where the buildings would necessarily be huddled together from the circumstances of their position. Even at Pompeii itself, on the west side of the city, where the ground slopes somewhat steeply towards the sea, houses are found which consisted of three storeys or more.

The excavations have provided examples of houses of every description, from the humble dwelling-place of the artisan or proletarian, with only three or four small rooms, to the stately mansions of Sallust, of the Faun, of the Golden Cupids, of the Silver Wedding, of the Vettii, of Pansa,¹ &c.—the last of which is among the most regular in plan, and may be taken as an almost

¹ It may be observed that the names given in most cases to the houses are either arbitrary or founded in the first instance upon erroneous inferences.

perfect model of a complete Roman house of a superior class. But the general similarity in their plan and arrangement is very striking, and in all those that rise above a very humble class the leading divisions of the interior, the *atrium*, *tablinum*, *peristyle*, &c. may be traced with unfailing regularity. Another peculiarity that is found in all the more considerable houses in Pompeii is that of the front, where it faces one of the principal streets, being occupied with shops, usually of small size, and without any communication with the interior of the mansion. In a few instances indeed such a communication is found, but in these cases it is probable that the shop was used for the sale of articles grown upon the estate of the proprietor, such as wine, fruit, oil, &c., a practice that is still common in Italy. In general the shop had a very small apartment behind it, and probably in most cases a sleeping chamber above it, though of this the only remaining evidence is usually a portion of the staircase that led to this upper room. The front of the shop was open to the street, but was capable of being closed with wooden shutters, the remains of which have in a few instances been preserved. Not only have the shops of silversmiths been recognized by the precious objects of that metal found in them, but large quantities of fruits of various kinds preserved in glass vessels, various descriptions of corn and pulse, loaves of bread, moulds for pastry, fishing-nets and many other objects too numerous to mention, have been found in such a condition as to be identified without difficulty. Inns and wine-shops appear to have been numerous; one of the latter we can see to have been a *thermopolium*, where hot drinks were sold. Bakers' shops are also frequent, though arrangements for grinding and baking appear to have formed part of every large family establishment. In other cases, however, these were on a larger scale, provided with numerous querns or hand-mills of the well-known form, evidently intended for public supply. Another establishment on a large scale was a *fullonica* (fuller's shop), where all the details of the business were illustrated by paintings still visible on the walls. Dyers' shops, a tannery and a shop where colours were ground and manufactured—an important business where almost all the rooms of every house were painted—are of special interest, as is also the house of a surgeon, where numerous surgical instruments were found, some of them of a very ingenious and elaborate description, but all made of bronze. Another curious discovery was that of the abode of a sculptor, containing his tools, as well as blocks of marble and half-finished statues. The number of utensils of various kinds found in the houses and shops is almost endless, and, as these are in most cases of bronze, they are generally in perfect preservation.

Of the numerous works of art discovered in the course of the excavations the statues and large works of sculpture, whether in marble or bronze, are inferior to those found at Herculaneum, but some of the bronze statuettes are of exquisite workmanship, while the profusion of ornamental works and objects in bronze and the elegance of their design, as well as the finished beauty of their execution, are such as to excite the utmost admiration—more especially when it is considered that these are the casual results of the examination of a second-rate provincial town, which had, further, been ransacked for valuables (as Herculaneum had not) after the eruption of 79. The same impression is produced in a still higher degree by the paintings with which the walls of the private houses, as well as those of the temples and other public buildings, are adorned, and which are not merely of a decorative character, but in many instances present us with elaborate compositions of figures, historical and mythological scenes, as well as representations of the ordinary life and manners of the people, which are full of interest to us, though often of inferior artistic execution. It has until lately been the practice to remove these to the museum at Naples; but the present tendency is to leave them (and even the movable objects found in the houses) *in situ* with all due precautions as to their preservation (as in the house of the Vettii, of the Silver Wedding, of the Golden Cupids, &c.), which adds immensely to the interest of the houses; indeed, with the help of judicious restoration, their original condition is in large

measure reproduced.¹ In some cases it has even been possible to recover the original arrangement of the garden beds, and to replant them accordingly, thus giving an appropriate framework to the statues, &c. with which the gardens were decorated, and which have been found *in situ*. The same character of elaborate decoration, guided almost uniformly by good taste and artistic feeling, is displayed in the mosaic pavements, which in all but the humbler class of houses frequently form the ornament of their floors. One of these, in the House of the Faun, well known as the battle of Alexander, presents us with the most striking specimen of artistic composition that has been preserved to us from antiquity.

The architecture of Pompeii must be regarded as presenting in general a transitional character from the pure Greek style to that of the Roman Empire. The temples (as already observed) have always the Roman peculiarity of being raised on a *podium* of considerable elevation; and the same characteristic is found in most of the other public buildings. All the three orders of Greek architecture—the Doric, Ionic and Corinthian—are found freely employed in the various edifices of the city, but rarely in strict accordance with the rules of art in their proportions and details; while the private houses naturally exhibit still more deviation and irregularity. In many of these indeed we find varieties in the ornamentation, and even in such leading features as the capitals of the columns, which remind one rather of the vagaries of medieval architecture than of the strict rules of Vitruvius or the regularity of Greek edifices. One practice which is especially prevalent, so as to strike every casual visitor, and dates from the early years of the empire, is that of filling up the flutings of the columns for about one-third of their height with a thick coat of stucco, so as to give them the appearance of being smooth columns without flutings below, and only fluted above. The unpleasing effect of this anomalous arrangement is greatly aggravated by the lower part of each column being almost always coloured with red or yellow ochre, so as to render the contrast between the two portions still stronger. The architecture of Pompeii suffers also from the inferior quality of the materials generally employed. No good building stone was at hand; and the public as well as private edifices were constructed either of volcanic tufa, or lava, or Sarno limestone, or brick (the latter only used for the corners of walls). In the private houses even the columns are mostly of brick, covered merely with a coat of stucco. In a few instances only do we find them making use of a whitish limestone wrongly called travertine, which, though inferior to the similar material so largely employed at Rome, was better adapted than the ordinary tufa for purposes where great solidity was required. The portion of the portico surrounding the forum which was in the process of rebuilding at the time when the city was destroyed was constructed of this material, while the earlier portions, as well as the principal temples that adjoined it, were composed in the ordinary manner of volcanic tufa. Marble appears to have been scarce, and was sparingly employed. In some instances where it had been freely introduced, as in the great theatre, it would seem that the slabs must have been removed at a period subsequent to the entombment of the city.

These materials are used in several different styles of construction belonging to the six different periods which Mau traces in the architectural history of Pompeii.

1. That of the Doric temple in the Foro Triangolare (6th century B.C.) and an old column built into a house in Region vi., Insula 5; also of the older parts of the city walls—date uncertain (Sarno limestone and grey tufa).

2. That of the limestone atriums (outer walls of the houses of ashlar-work of Sarno limestone, inner walls with framework of limestone blocks, filled in with small pieces of limestone). Date, before 200 B.C.

3. Grey tufa period; ashlar masonry of tufa, coated with fine white stucco; rubble work of lava. The artistic character is still Greek, and the period coincides with the first (incrustation) style of mural decoration, which (probably originating in Alexandria) aimed at

¹The paintings of the house of the Vettii are perhaps the best-preserved in Pompeii, and extremely fine in conception and execution, especially the scenes in which Cupids take part.

the imitation in stucco of the appearance of a wall veneered with coloured marbles. No wall paintings exist, but there are often fine floor mosaics. To this belong a number of private houses (e.g. the House of the Faun), and the colonnade round the forum, the basilica, the temples of Apollo and Jupiter, the large theatre with the colonnades of the Foro Triangolare, and the barracks of the gladiators, the Stabian baths, the Palæstra, the exterior of the Porta Marina, and the interior of the other gates—all the public buildings indeed (except the Doric temple mentioned under (1), which do not belong to the time of the Roman colony). Date, 2nd century B.C.

4. The "quasi-reticulate" period—walling faced with masonry not yet quite so regular as *opus reticulatum*, and with brick quoins, coinciding with the second period of decoration (the architectural, partly imitating marble like the first style, but without relief, and by colour only, and partly making use of architectural designs). It is represented by the small theatre and the amphitheatre, the baths near the forum, the temple of Zeus Milichius, the Comitium and the original temple of Isis, but only a few private houses. The ornamentation is much less rich and beautiful than that of the preceding period. Date, from 80 B.C. until nearly the end of the Republic.

5. The period from the last decades of the Republic to the earthquake of A.D. 63. No homogeneous series of buildings—we find various styles of construction (quasi-reticulate, *opus reticulatum* of tufa with stone quoins, of the time of Augustus, *opus reticulatum* with brick quoins or with mingled stone and brick quoins, a little later); and three styles of wall decoration fall within its limits. The second, already mentioned, the third or ornate, with its freer use of ornament and its introduction of designs which suggest an Egyptian origin (originating in the time of Augustus), and the fourth or intricate, dating from about A.D. 50. Marble first appears as a building material in the temple of Fortuna Augusta (c. 3 B.C.).

6. The period from the earthquake of A.D. 63 to the final destruction of the city, the buildings of which can easily be recognized. The only wholly new edifice of any importance is the central baths.

Outside the Porta Ercolanese, or gate leading to Herculaneum, is found a house of a different character from all the others, which from its extent and arrangements was undoubtedly a suburban villa, belonging to a person of considerable fortune. It is called—as usual without any authority—the villa of Arrius Diomedes; but its remains are of peculiar interest to us, not only for comparison with the numerous ruins of similar buildings which occur elsewhere—often of greater extent, but in a much less perfect state of preservation—but as assisting us in understanding the description of ancient authors, such as Vitruvius and Pliny, of the numerous appurtenances frequently annexed to houses of this description.

In the cellar of this villa were discovered no less than twenty skeletons of the unfortunate inhabitants, who had evidently fled thither for protection, and fourteen in other parts of the house. Almost all the skeletons and remains of bodies found in the city were discovered in similar situations, in cellars or underground apartments—those who had sought refuge in flight having apparently for the most part escaped from destruction, or having perished under circumstances where their bodies were easily recovered by the survivors. According to Cassius Dio, a large number of the inhabitants were assembled in the theatre at the time of the catastrophe, but no bodies have been found there, and they were probably sought for and removed shortly afterwards. Of late years it has been found possible in many cases to take casts of the bodies found—a complete mould having been formed around them by the fine white ashes, partially consolidated by water.

An interesting farm-house (few examples have been so far discovered in Italy) is that at Boscoreale excavated in 1893-1894, which contained the treasure of one hundred and three silver vases now at the Louvre. The villa of P. Fannius Synistor, not far off, was excavated in 1900; it contained fine wall paintings, which, despite their importance, were allowed to be exported, and sold by auction in Paris (some now in the Louvre). (See F. Barnabei, *La Villa pompeiana di P. Fannio Sinistore*; Rome, 1901.)

The road leading from the Porta Ercolanese towards Herculaneum is bordered on both sides for a considerable extent by rows of tombs, as was the case with all the great roads leading into Rome, and indeed in all large Roman towns. These tombs are in many instances monuments of considerable pretension, and of a highly ornamental character, and naturally present in the highest degree the peculiar advantage common to all that remains of Pompeii, in their perfect preservation. Hardly any scene even in this extraordinary city is more striking than the *coup d'œil* of this long street of tombs, preserving uninjured the records of successive generations eighteen centuries ago. Unfortunately the names are all otherwise unknown; but we learn from the inscriptions that they are for the most part those of local magistrates and municipal dignitaries of Pompeii. Most of them belong to the early empire.

There appears to have been in the same quarter a considerable suburb, outside the gate, extending on each side of the road towards Herculaneum, apparently much resembling those which are now found throughout almost the whole distance from thence to Naples. It was known by the name of Pagus Augustus Felix

Suburbanus. Other suburbs were situated at the harbour and at the saltworks (*salinae*).

No manuscripts have been discovered in Pompeii. Inscriptions have naturally been found in considerable numbers, and we are indebted to them for much information concerning the municipal arrangements of the town, as well as the construction of various edifices and other public works. The most interesting of these are such as are written in the Oscan dialect, which appears to have continued in official use down to the time when the Roman colony was introduced by Sulla. From that time the Latin language was certainly the only one officially employed, though Oscan may have still been spoken by a portion at least of the population. Still more curious, and almost peculiar to Pompeii, are the numerous writings painted upon the walls, which have generally a semi-public character, such as recommendations of candidates for municipal offices, advertisements, &c., and the scratched inscriptions (*graffiti*), which are generally the mere expression of individual impulse and feeling, frequently amatory, and not uncommonly conveyed in rude and imperfect verses. In one house also a whole box was found filled with written tablets—diptychs and triptychs—containing the record of the accounts of a banker named L. Caecilius Jucundus.

See A. Mau, *Pompeii: its Life and Art* (trans. by F. W. Kelsey, 2nd ed., New York and London, 1902; 2nd revised edition of the German original, *Pompeii in Leben und Kunst*, Leipzig, 1908), the best general account written by the greatest authority on the subject, to which our description owes much, with full references to other sources of information; and, for later excavations, *Notizie degli Scavi and Römische Mitteilungen* (in the latter, articles by Mau), *passim*. For the inscriptions on the tablets and on the walls, *Corpus inscriptionum latinarum*, vol. iv. (ed. Zangemeister and Mau). Recent works on the Pompeian frescoes are those of Berger, in *Die Maltechnik des Alterthums*, and A. P. Laurie, *Greek and Roman Methods of Painting* (1910). (E. H. B.; T. As.)

Oscan Inscriptions.—The surviving inscriptions which can be dated, mainly by the gradual changes in their alphabet, are of the 3rd and 2nd centuries B.C., some certainly belonging to the Gracchan period. The oldest of the Latin inscriptions are *C.I.L.* x. 794, the record of the building of colonnades in the forum by the "quaestor" V. Popidius, and two or three election placards (*C.I.L.* iv. 29, 30, 36) of one R. Caecilius, a candidate for the same office. It cannot be an accident that the alphabet of these inscriptions belongs distinctly to Sullan or pre-Sullan times, while no such officer as a quaestor appears in any later documents (e.g. in *C.I.L.* x. 844, it is the duoviri who build the small theatre), but does appear in the Oscan inscriptions. Hence it has been inferred that these oldest Latin inscriptions are also older than Sulla's colony; if so, Latin must have been in use, and in fairly common use (if the *programmata* were to be of any service), in Pompeii at that date. On the other hand, the good condition of many of the painted Oscan inscriptions at the times when they were first uncovered (1797 onwards) and their subsequent decay and the number of Oscan graffiti appear to make it probable that at the Christian era Oscan was still spoken in the town. The two languages undoubtedly existed side by side during the last century B.C., Latin being alone recognized officially and in society, while Oscan was preserved mainly by intercourse with the country folk who frequented the market. Thus beside many Latin *programmata* later than those just mentioned we have similar inscriptions in Oscan, addressed to Oscan-speaking voters, where *IIIIner.* obviously relates to the quattuorvirate, a title characteristic of the Sullan and triumviral colonies. An interesting stone containing nine cavities for measures of capacity found in Pompeii and now preserved in the Naples Museum with Oscan inscriptions erased in antiquity shows that the Oscan system of measurement was modified so as to correspond more closely with the Roman, about 14 B.C., by the duoviri, who record their work in a Latin inscription (*C.I.L.* x. 793; for the Oscan see *Ital. Dial.* p. 67).

See further *OSCA LINGUA*, and R. S. Conway, *The Italic Dialects*, pp. 54 sqq.; Nissen, *Pompeianische Studien*; J. Beloch, *Campanien*, 2nd ed. (R. S. C.)

POMPEY, the common English form of Pompeius, the name of a Roman plebeian family.

1. GNAEUS POMPEIUS (106–48 B.C.), the triumvir, the first of his family to assume the surname MAGNUS, was born on the 30th of September in the same year as Cicero. When only seventeen he fought together with his father in the Social War.

He took the side of Sulla against Marius and Cinna, but for a time, in consequence of the success of the Marians, he kept in the background. On the return of Sulla from the Mithradatic War Pompey joined him with an army of three legions, which he had raised in Picenum. Thus early in life he connected himself with the cause of the aristocracy, and a decisive victory which he won in 83 over the Marian armies gained for him from Sulla the title of *Imperator*. He followed up his successes in Italy by defeating the Marians in Sicily and Africa, and on his return to Rome in 81, though he was still merely an *eques* and not legally qualified to celebrate a triumph, he was allowed by general consent to enjoy this distinction, while Sulla greeted him with the surname of *Magnus*, a title he always retained and handed down to his sons. Latterly, his relations with Sulla were somewhat strained, but after his death he resisted the attempt of the consul M. Aemilius Lepidus to repeal the constitution. In conjunction with A. Lutatius Catulus, the other consul, he defeated Lepidus when he tried to march upon Rome, and drove him out of Italy (77). With some fears and misgivings the senate permitted him to retain the command of his victorious army, and decided on sending him to Spain, where the Marian party, under Sertorius, was still formidable. Pompey was fighting in Spain from 76 to 71, and though at first he met with serious reverses he was ultimately successful. After Sertorius had fallen a victim to assassination, Pompey easily defeated his successor Perperna and put an end to the war. In 71 he won fresh glory by finally crushing the slave insurrection of Spartacus. That same year, amid great popular enthusiasm, but without the hearty concurrence of the senate, whom he had alarmed by talking of restoring the dreaded power of the tribunes, he was elected with M. Licinius Crassus to the consulship, and entered Rome in triumph (December 31) for his Spanish victories. He was legally ineligible for the consulship, having held none of the lower offices of state and being under age. The following year saw the work of Sulla undone; the tribunate was restored, and the administration of justice was no longer left exclusively to the senate, but was to be shared by it with the wealthier portion of the middle class, the equites (*q.v.*) and the *tribuni aerarii*.¹ The change was really necessary, as the provincials could never get justice from a court composed of senators, and it was carried into effect by Pompey with Caesar's aid. Pompey rose still higher in popularity, and on the motion of the tribune Aulus Gabinius in 67 he was entrusted with an extraordinary command over the greater part of the empire, specially for the extermination of piracy in the Mediterranean, by which the corn supplies of Rome were seriously endangered, while the high prices of provisions caused great distress. He was completely successful; the price of corn fell immediately on his appointment, and in forty days the Mediterranean was cleared of the pirates. Next year, on the proposal of the tribune Manilius, his powers were still further extended, the care of all the provinces in the East being put under his control for three years together with the conduct of the war against Mithradates VI., who had recovered from the defeats he had sustained from Lucullus and regained his dominions. Both Caesar and Cicero supported the tribune's proposal, which was easily carried in spite of the interested opposition of the senate and the aristocracy, several of whom held provinces which would now be practically under Pompey's command. The result of Pompey's operations was eminently satisfactory. The wild tribes of the Caucasus were cowed by the Roman arms, and Mithradates himself fled across the Black Sea to Panticapaeum (modern Kertch). In the years 64 and 63 Syria and Palestine were annexed to Rome's empire. After the capture of Jerusalem Pompey is said to have entered the Temple, and even the Holy of Holies. Asia and the East generally were left under the subjection of petty kings who were mere vassals of Rome. Several cities had been founded which became centres of Greek life and civilization.

Pompey, now in his forty-fifth year, returned to Italy in 61 to

¹ Their history and political character is obscure; they were at any rate connected with the knights (see *AERARIUM*).

celebrate the most magnificent triumph which Rome had ever witnessed, as the conqueror of Spain, Africa, and Asia (see A. Holm, *Hist. of Greece*, Eng. trans., vol. iv.). This triumph marked the turning-point of his career. As a soldier everything had gone well with him; as a politician he was a failure. He found a great change in public opinion, and the people indifferent to his achievements abroad. The optimates resented the extraordinary powers that had been conferred upon him; Lucullus and Crassus considered that they had been robbed by him of the honour of concluding the war against Mithradates. The senate refused to ratify the arrangements he made in Asia or to provide money and lands for distribution amongst his veterans. In these circumstances he drew closer to Caesar on his return from Spain, and became reconciled to Crassus. The result was the so-called first triumvirate (see *ROME: History*).

The remainder of his life is inextricably interwoven with that of Caesar. He was married to Caesar's daughter Julia, and as yet the relations between the two had been friendly. On more than one occasion Caesar had supported Pompey's policy, which of late had been in a decidedly democratic direction. Pompey was now in fact ruler of the greater part of the empire, while Caesar had only the two provinces of Gaul. The control of the capital, the supreme command of the army in Italy and of the Mediterranean fleet, the governorship of the two Spains, the superintendence of the corn supplies, which were mainly drawn from Sicily and Africa, and on which the vast population of Rome was wholly dependent, were entirely in the hands of Pompey, who was gradually losing the confidence of all political parties in Rome. The senate and the aristocracy disliked and distrusted him, but they felt that, should things come to the worst, they might still find in him a champion of their cause. Hence the joint rule of Pompey and Caesar was not unwillingly accepted, and anything like a rupture between the two was greatly dreaded as the sure beginning of anarchy throughout the Roman world. With the deaths of Pompey's wife Julia (54) and of Crassus (53) the relations between him and Caesar became strained, and soon afterwards he drew closer to what we may call the old conservative party in the senate and aristocracy. The end was now near, and Pompey blundered into a false political position and an open quarrel with Caesar. In 50 the senate by a very large majority revoked the extraordinary powers conceded to Pompey and Caesar in Spain and Gaul respectively, and called upon them to disband their armies. Pompey's refusal to submit gave Caesar a good pretext for declaring war and marching at the head of his army into Italy. At the beginning of the contest the advantages were decidedly on the side of Pompey, but the superior political tact of his rival, combined with extraordinary promptitude and decision in following up his blows, soon turned the scale against him. Pompey's cause, with that of the senate and aristocracy, was finally ruined by his defeat in 48 in the neighbourhood of the Thessalian city Pharsalus. That same year he fled with the hope of finding a safe refuge in Egypt, but was treacherously murdered by one of his old centurions as he was landing. He was five times married, and three of his children survived him—Gnaeus, Sextus, and a daughter Pompeia.

Pompey, though he had some great and good qualities, hardly deserved his surname of "the Great." He was certainly a very good soldier, and is said to have excelled in all athletic exercises, but he fell short of being a first-rate general. He won great successes in Spain and more especially in the East, but for these he was no doubt partly indebted to what others had already done. Of the gifts which make a good statesman he had really none. As plainly appeared in the last years of his life, he was too weak and irresolute to choose a side and stand by it. But to his credit be it said that in a corrupt time he never used his opportunities for plunder and extortion, and his domestic life was pure and simple.

AUTHORITIES.—*Ancient:* Plutarch, *Pompey*; Dio Cassius; Appian; Velleius Paterculus; Caesar, *De bello civili*; Strabo xiii., 555-560; Cicero, *passim*; Lucan, *Pharsalia*.

Modern: Histories of Rome in general (see *ROME: Ancient History, ad fin.*); works quoted under CAESAR and CICERO. Also

G. Boissier, *Cicero and His Friends* (Eng. trans., A. D. Jones, 1897); J. L. Strachan-Davidson's *Cicero* (1894); Warde Fowler's *Julius Caesar* (1892); C. W. Oman, *Seven Roman Statesmen of the Later Republic* (1902); notes in Tyrrell and Purser's *Correspondence of Cicero* (see index in vii. 80).

2. GNAEUS POMPEIUS, surnamed *Strabo* (squint-eyed), Roman statesman, father of the triumvir. He was successively quaestor in Sardinia (103 B.C.), praetor (94), propraetor in Sicily (93) and consul (89). He fought with success in the Social War, and was awarded a triumph for his services. Probably towards the end of the same year he brought forward the law (*lex Pompeia de Gallia Transpadana*), which conferred upon the inhabitants of that region the privileges granted to the Latin colonies. During the civil war between Marius and Sulla he seems to have shown no desire to attach himself definitely to either side. He certainly set out for Rome from the south of Italy (where he remained as proconsul) at the bidding of the aristocratic party, when the city was threatened by Marius and Cinna, but he displayed little energy, and the engagement which he fought before the Colline gate, although hotly contested, was indecisive. Soon afterwards he was killed by lightning (87). Although he possessed great military talents, Pompeius was the best-hated general of his time owing to his cruelty, avarice and perfidy. His body was dragged from the bier, while being conveyed to the funeral pile, and treated with the greatest indignity.

See Plutarch, *Pompey*, 1; Appian, *Bell. civ.* i. 50, 52, 66-68, 80; Vell. Pat. ii. 21; Livy, *Épit.* 74-79; Florus iii. 18.

3. GNAEUS POMPEIUS MAGNUS (c. 75-45 B.C.), the elder son of the triumvir. In 48 B.C. during the civil war he commanded his father's fleet in the Adriatic. After the battle of Pharsalus he set out for Africa with the remainder of the Pompeian party, but, meeting with little success, crossed over to Spain. Having been joined by his brother Sextus, he collected a considerable army, the numbers of which were increased by the Pompeians who fled from Africa after the battle of Thapsus (46). Caesar, who regarded him as a formidable opponent, set out against him in person. A battle took place at Munda on the 17th of March 45, in which the brothers were defeated. Gnaeus managed to make his escape after the engagement, but was soon (April 12) captured and put to death. He was generally unpopular owing to his cruelty and violent temper.

See Pseudo-Oppius, *Bellum hispaniense*, 1-39; Lucan, *Pharsalia*, ix. 120; Dio Cassius xliii. 28-40.

4. SEXTUS POMPEIUS MAGNUS (75-35 B.C.), the younger son of the triumvir. After his father's death he continued the struggle against the new rulers of the Roman Empire. From Cyprus, where he had taken refuge, he made his way to Africa, and after the defeat of the Pompeians at Thapsus (46) crossed over to Spain. After Caesar's victory at the battle of Munda (45), in which he took no actual part, he abandoned Corduba (Cordova), though for a time he held his ground in the south, and defeated Asinius Pollio, the governor of the province. In 43, the year of the triumvirate of Octavius, Antony, and Lepidus, he was proscribed along with the murderers of Caesar, and, not daring to show himself in Italy, he put himself at the head of a fleet manned chiefly by slaves or proscribed persons, with which he made himself master of Sicily, and from thence ravaged the coasts of Italy. Rome was threatened with a famine, as the corn supplies from Egypt and Africa were cut off by his ships, and it was thought prudent to negotiate a peace with him at Misenum (30), which was to leave him in possession of Sicily, Sardinia and Achaëa, provided he would allow Italy to be freely supplied with corn. But the arrangement could not be carried into effect, as Sextus renewed the war and gained some considerable successes at sea. However, in 36 his fleet was defeated and destroyed by Agrippa at Naulochus off the north coast of Sicily. After his defeat he fled to Mytilene, and from there to Asia Minor. In the attempt to make his way to Armenia he was taken prisoner by Antony's troops, and put to death at Miletus. Like his father, he was a brave soldier, but a man of little culture.

See Dio Cassius, xlvi-xlix.; Appian, *Bell. civ.* iv. 84-117, v. 2-143; Vell. Pat. ii. 73-87; Plutarch, *Antony*; Livy, *Epit.* 123, 128, 129, 131; Cicero, *Philippica*, xiii., and many references in *Letters to Atticus*.

POMPIGNAN, JEAN JACQUES LEFRANC, MARQUIS DE (1709-1784), French poet, was born on the 17th of August 1709, at Montauban, where his father was president of the *cour des aides*, and the son, who also followed the profession of the law, succeeded in 1745 to the same charge. The same year he was also appointed *conseiller d'honneur* of the parlement of Toulouse, but his courageous opposition to the abuses of the royal power, especially in the matter of taxation, brought down upon him so much vexation that he resigned his positions almost immediately, his marriage with a rich woman enabling him to devote himself to literature. His first play, *Didon* (1734), which owed much to Metastasio's opera on the same subject, gained a great success, and gave rise to expectations not fulfilled by the *Adieux de Mars* (1735) and some light operas that followed. His reputation was made by *Poésies sacrées et philosophiques* (1734), much mocked at by Voltaire who punned on the title: "*Sacrés ils sont, car personne n'y touche.*" Lefranc's odes on profane subjects hardly reach the same level, with the exception of the ode on the death of J. B. Rousseau, which secured him entrance to the Academy (1760). On his reception he made an ill-considered oration violently attacking the Encyclopaedists, many of whom were in his audience and had given him their votes. Lefranc soon had reason to repent of his rashness, for the epigrams and stories circulated by those whom he had attacked made it impossible for him to remain in Paris, and he took refuge in his native town, where he spent the rest of his life occupied in making numerous translations from the classics, none of great merit.

La Harpe, who is severe enough on Lefranc in his correspondence, does his abilities full justice in his *Cours littéraire*, and ranks him next to J. B. Rousseau among French lyric poets. With those of other 18th-century poets his works may be studied in the *Petits poètes français* (1838) of M. Prosper Poitevin. His *Œuvres complètes* (4 vols.) were published in 1781, selections (2 vols.) in 1800, 1813, 1822.

His brother, JEAN GEORGES LEFRANC DE POMPIGNAN (1715-1790), was the archbishop of Vienné against whose defence of the faith Voltaire launched the good-natured mockery of *Les Lettres d'un Quaker*. Elected to the Estates General, he passed over to the Liberal side, and led the 140 members of the clergy who united with the third estate to form the National Assembly. He was one of its first presidents, and was minister of public worship when the civil constitution was forced upon the clergy.

POMPONAZZI, PIETRO (PETRUS POMPONATIUS) (1462-1525), Italian philosopher, was born at Mantua on the 16th of September 1462, and died at Bologna on the 18th of May 1525. His education, begun at Mantua, was completed at Padua, where he became doctor of medicine in 1487. In 1488 he was elected extraordinary professor of philosophy at Padua, where he was a colleague of Achillini, the Averroist. From about 1495 to 1509 he occupied the chair of natural philosophy until the closing of the schools of Padua, when he took a professorship at Ferrara where he lectured on the *De anima*. In 1512 he was invited to Bologna where he remained till his death and where he produced all his important works. The predominance of medical science at Padua had cramped his energies, but at Ferrara, and even more at Bologna, the study of psychology and theological speculation were more important. In 1516 he produced his great work *De immortalitate animi*, which gave rise to a storm of controversy between the orthodox Thomists of the Catholic Church, the Averroists headed by Agostino Nifo, and the so-called Alexandrist School. The treatise was burned at Venice, and Pomponazzi himself ran serious risk of death at the hands of the Catholics. Two pamphlets followed, the *Apologia* and the *Defensorium*, wherein he explained his paradoxical position as Catholic and philosophic materialist. His last two treatises, the *De incantationibus* and the *De fato*, were posthumously published in an edition of his works printed at Basel.

Pomponazzi is profoundly interesting as the herald of the Renaissance. He was born in the period of transition when scholastic formalism was losing its hold over men both in the Church and outside. Hitherto the dogma of the Church had been based on Aristotle as interpreted by Thomas Aquinas. So close was this identification that any attack on Aristotle, or even an attempt to reopen the old discussions on the Aristotelian problems, was regarded as a dangerous heresy. Pomponazzi claimed the right to study Aristotle for himself, and devoted himself to the *De anima* with the view of showing that Thomas Aquinas had entirely misconceived the Aristotelian theory of the active and the passive intellect. The Averroists had to some extent anticipated this attitude by their contention that immortality does not imply the eternal separate existence of the individual soul, that the active principle which is common to all men alone survives. Pomponazzi's revolt went further than this. He held, with Alexander of Arodisias, that, as the soul is the form of the body (as Aquinas also asserted), it must, by hypothesis, perish with the body; form apart from matter is unthinkable. The ethical consequence of such a view is important, and in radical contrast to the practice of the period. Virtue can no longer be viewed solely in relation to reward and punishment in another existence. A new sanction is required. Pomponazzi found this criterion in *τοῦ καλοῦ ἕνεκα*—virtue for its own sake. "*Praemium essentielle virtutis est ipsamet virtus quae hominem felicem facit,*" he says in the *De immortalitate*. Consequently, whether or not the soul be immortal, the ethical criterion remains the same: "*Neque aliquo pacto declinandum est a virtute quicquid accidat post mortem.*" In spite of this philosophical materialism, Pomponazzi declared his adherence to the Catholic faith, and thus established the principle that religion and philosophy, faith and knowledge, may be diametrically opposed and yet coexist for the same thinker. This curious paradox he exemplifies in the *De incantatione*, where in one breath he sums up against the existence of demons and spirits on the basis of the Aristotelian theory of the cosmos, and, as a believing Christian, asserts his faith in their existence. In this work he insists emphatically upon the orderly sequence of nature, cause and effect. Men grow to maturity and then decay; so religions have their day and succumb. Even Christianity, he added (with the usual proviso that he is speaking as a philosopher) was showing indications of decline.

See A. H. Douglas, *Philosophy and Psychology of Pietro Pomponazzi* (1910); also Ritter, *Geschichte der Philosophie*; J. A. Symonds, *The Renaissance in Italy*; Windelband, *History of Philosophy* (trans. by James H. Tufts, pt. 4, c. 1); J. Burckhardt, *Die Kultur der Renaissance in Italien*; L. Ferri, *La Psicologia di P. Pomponazzi*.

POMPONIUS, LUCIUS, called *Bononiensis* from his birthplace Bononia, Latin comic poet, flourished about 90 B.C. (or earlier). He was the first to give an artistic form to the Atellanæ Fabulæ by arranging beforehand the details of the plot which had hitherto been left to improvisation, and providing a written text. The fragments show fondness for alliteration and playing upon words, skill in the use of rustic and farcical language, and a considerable amount of obscenity.

Fragments in O. Ribbeck, *Scenicae romanorum poesis fragmenta* (1897-1898); see Mommsen, *Hist. of Rome* (Eng. tr.), bk. iv. ch. 13; Teuffel-Schwabe, *Hist. of Roman Literature* (Eng. tr.), § 151.

POMPOSA, an abbey of Emilia, Italy, in the province of Ferrara, 2 m. from Codigoro, which is 30 m. E. of Ferrara in the delta of the Po. The fine church, a work of the 10th (?) century, with interesting sculptures on the façade and a splendid Romanesque campanile, contains a good mosaic pavement, and interesting frescoes of the 14th century—a "Last Judgment" of the school of Giotto and others; and there are also paintings in the refectory. It was abandoned in 1550 on account of malaria.

See G. Agnelli, *Ferrara e Pomposa* (Bergamo, 1902). (T. As.)

POMPTINE MARSHES, a low tract of land in the province of Rome, Italy, varying in breadth between the Volscian mountains and the sea from 10 to 16 m., and extending N.W. to S.E. from

Velletri to Terracina (40 m.). In ancient days this low tract was fertile and well-cultivated, and contained several prosperous cities (Suessa Pometia, Ulubrae—perhaps the mod. Cisterna—&c.), but, owing to the dying out of the small proprietors, it had already become unhealthy at the end of the Republican period. Attempts to drain the marshes were made by Appius Claudius in 312 B.C., when he constructed the Via Appia through them (the road having previously followed a devious course at the foot of the Volscian mountains), and at various times during the Roman period. A canal ran through them parallel to the road, and for some reason that is not altogether clear it was used in preference to the road during the Augustan period. Trajan repaired the road, and Theodoric did the same some four hundred years later. But in the middle ages it had fallen into disrepair. Popes Boniface VIII., Martin V., Sixtus V., and Pius VI. all attempted to solve the problem, the last-named reconstructing the road admirably. The difficulty arises from the lack of fall in the soil, some parts no less than 10 m. from the coast being barely above sea-level, while they are separated from the sea by a series of sand-hills now covered with forest, which rise at some points over 100 ft. above sea-level. Springs also rise in the district, and the problem is further complicated by the flood-water and solid matter brought down by the mountain torrents, which choke up the channels made. By a law passed in 1899, the proprietors are bound to arrange for the safe outlet of the water from the mountains, keep the existing canals open, and reclaim the district exposed to inundation, within a period of twenty-four years. The sum of £280,000 has been granted towards the expense by the government.

See T. Berti, *Paludi pontine* (Rome, 1884); R. de la Blanchère, *Un Chapitre d'histoire pontine* (Paris, 1889). (T. As.)

PONANI, a seaport on the west coast of India, in Malabar district, Madras, at a mouth of a river of the same name. Pop. (1901), 10,562. It is the headquarters of the Moplah or Mappilla community of Mahommedans, with a religious college and many mosques, one of which is said to date from 1510. There is a large export of coco-nut products.

PONCA, a tribe of North-American Indians of Siouan stock. They were originally part of the Omaha tribe, with whom they lived near the Red River of the North. They were driven westward by the Dakotas, and halted on the Ponca river, Dakota. After a succession of treaties and removals they were placed on a reservation at the mouth of the Niobrara, where they were prospering, when their lands were forcibly taken from them, and they were removed to Indian Territory (Oklahoma). During the march thither and in their new quarters, the tribe's health suffered, so that in 1878 they revolted and made their way back to the Omahas. They were recaptured, but public attention having been drawn to their hard case they were liberated in 1880, after a long trial, which resulted in their being declared United States citizens. They number some 700, mostly in Oklahoma.

PONCE, a seaport and the second largest city of Porto Rico, the seat of government of the Department of Ponce, on the south coast, about 50 m. (84 m. by the military road) S.W. of San Juan. Pop. (1899), 27,952, of whom 2554 were negroes and 9942 of mixed races; (1910), 35,027. It is served by the American Railroad of Porto Rico, by a railway to Guayama (1910), and by steamboats from numerous ports; an old military road connects it with San Juan. Ponce consists of two parts: Ponce, or the city proper, and Ponce Playa, or the seaport; they are separated by the Portuguese River and are connected by an electric street railway. Ponce Playa is on a spacious bay and is accessible to vessels drawing 25 ft. of water; Ponce is 2 m. inland at the interior margin of a beautiful plain, with hills in the rear rising to a height of 1000 to 2000 ft. The city is supplied with water by an aqueduct about 2 m. long. There are two attractive public squares in the heart of the city: Plaza Principal and Plaza de las Delicias. Among prominent public buildings are the city hall, the custom-house, the Pearl theatre, several churches—Roman Catholic (including a finely decorated cathedral) and Protestant; St Luke's hospital and insane asylum, an asylum

for the blind, a ladies' asylum, a home for the indigent and aged, and a military barracks. At the Quintana Baths near the city are thermal springs with medicinal properties. The surrounding country is devoted chiefly to the cultivation of sugar cane, tobacco, oranges and cacao, and to the grazing of cattle. Among the manufactures are sugar, molasses, rum, and ice, and prepared coffee for the market. Ponce, named in honour of Ponce de Leon, was founded in 1752 upon the site of a settlement which had been established in the preceding century, was incorporated as a town in 1848, and was made a city in 1878.

PONCELET, JEAN VICTOR (1788–1867), French mathematician and engineer, was born at Metz on the 1st of July 1788. From 1808 to 1810 he attended the *École polytechnique*, and afterwards, till 1812, the *École d'application* at Metz. He then became lieutenant of engineers, and took part in the Russian campaign, during which he was taken prisoner and was confined at Saratov on the Volga. It was during his imprisonment here that, "privé de toute espèce de livres et de secours, surtout distraité par les malheurs de ma patrie et les miens propres," as he himself puts it, he began his researches on projective geometry which led to his great treatise on that subject. This work, the *Traité des propriétés projectives des figures*, which was published in 1822 (2d ed., 2 vols. 1865–1866), is occupied with the investigation of the projective properties of figures (see GEOMETRY). This work entitles Poncelet to rank as one of the greatest of those who took part in the development of the modern geometry of which G. Monge was the founder. From 1815 to 1825 he was occupied with military engineering at Metz; and from 1825 to 1835 he was professor of mechanics at the *École d'application* there. In 1826, in his *Mémoire sur les roues hydrauliques à aubes courbes*, he brought forward improvements in the construction of water-wheels, which more than doubled their efficiency. In 1834 he became a member of the *Académie*; from 1838 to 1848 he was professor to the faculty of sciences at Paris, and from 1848 to 1850 commandant of the *École polytechnique*. At the London International Exhibition of 1851 he had charge of the department of machinery, and wrote a report on the machinery and tools on view at that exhibition. He died at Paris on the 23rd of December 1867.

See J. Bertrand, *Éloge historique de Poncelet* (Paris, 1875).

PONCHER, ÉTIENNE DE (1446–1524), French prelate and diplomatist. After studying law he was early provided with a prebend, and became councillor at the parlement of Paris in 1485 and president of the Chambre des Enquêtes in 1498. Elected bishop of Paris in 1503 at the instance of Louis XII., he was entrusted by the king with diplomatic missions in Germany and Italy. After being appointed chancellor of the duchy of Milan, he became keeper of the seals of France in 1512, and retained that post until the accession of Francis I., who employed him on various diplomatic missions. Poncher became archbishop of Sens in 1519. His valuable *Constitutions synodales* was published in 1514.

PONCHIELLI, AMILCARE (1834–1886), Italian musical composer, was born near Cremona on the 1st of September 1834. He studied at the Milan Conservatoire. His first dramatic work, written in collaboration with two other composers, was *Il Sindaco Babbeo* (1851). After completing his studies at Milan he returned to Cremona, where his opera *I Promessi sposi* was produced in 1856. This was followed by *La Sazojarda* (1861, produced in a revised version as *Lina* in 1877), *Roderigo, rè dei Goti* (1864), and *La Stella del monte* (1867). A revised version of *I Promessi sposi*, which was produced at Milan in 1872, was his first genuine success. After this came a ballet, *Le Due Gemelle* (1873), and an opera, *I Lituani* (1874, produced in a revised version as *Alduna* in 1884). Ponchielli reached the zenith of his fame with *La Gioconda* (1876), written to a libretto founded by Arrigo Boito upon Victor Hugo's tragedy, *Angelo, Tyran de Padoue*. *La Gioconda* was followed by *Il Figliuolo prodigo* (1880) and *Marion Delorme* (1885). Among his less

important works are *Il Parlatore eterno*, a musical farce (1873), and a ballet, *Clarina* (1873). In 1881 Ponchielli was made maestro di cappella of Piacenza Cathedral. His music shows the influence of Verdi, but at its best it has a distinct value of its own, and an inexhaustible flow of typically Italian melody. His fondness for fanciful figures in his accompaniments has been slavishly imitated by Mascagni, Leoncavallo, and many of their contemporaries. Ponchielli died at Milan on the 17th of January 1886.

PONCHO (a South American Spanish word, adopted from the Araucanian *poncho* or *pontho* in the 17th century), a form of cloak worn originally by the South American Indians, and afterwards adopted by the Spaniards living in South America. It is merely a long strip of cloth, doubled, with a hole for the head.

POND, JOHN (c. 1767–1836), English astronomer-royal, was born about 1767 in London, where his father made a fortune in trade. He entered Trinity College, Cambridge, at the age of sixteen, but took no degree, his course being interrupted by severe pulmonary attacks which compelled a long residence abroad. In 1800 he settled at Westbury near Bristol, and began to determine star-places with a fine altitude and azimuth circle of 2½ ft. diameter by E. Troughton. His demonstration in 1806 (*Phil. Trans.* xcvi. 420) of a change of form in the Greenwich mural quadrant led to the introduction of astronomical circles at the Royal Observatory, and to his own appointment as its head. He was elected a fellow of the Royal Society on the 26th of February 1807; he married and went to live in London in the same year, and in 1811 succeeded Maskelyne as astronomer-royal.

During an administration of nearly twenty-five years Pond effected a reform of practical astronomy in England comparable to that effected by Bessel in Germany. In 1821 he began to employ the method of observation by reflection; and in 1825 he devised means (see *Mem. Roy. Astron. Soc.* ii. 499) of combining two mural circles in the determination of the place of a single object, the one serving for direct and the other for reflected vision. Under his auspices the instrumental equipment at Greenwich was completely changed, and the number of assistants increased from one to six. The superior accuracy of his determinations was attested by S. C. Chandler's discussion of them in 1894, in the course of his researches into the variation of latitude (*Astron. Journ.* Nos. 313, 315). He persistently controverted (1810–1824) the reality of J. Brinkley's imaginary star-parallaxes (*Phil. Trans.* cviii. 477, cxiii. 53). Delicacy of health compelled his retirement in the autumn of 1835. He died at Blackheath on the 7th of September 1836, and was buried beside Halley in the churchyard of Lee. The Copley medal was conferred upon him in 1823, and the Lalande prize in 1817 by the Paris Academy, of which he was a corresponding member. He published eight folio volumes of *Greenwich Observations*, translated Laplace's *Système du monde* (in 2 vols. 8vo., 1809), and contributed thirty-one papers to scientific collections. His catalogue of 1112 stars (1833) was of great value.

See *Mem. Roy. Astron. Soc.* x. 357; *Proc. Roy. Soc.* iii. 434; *Penny Cyclopaedia* (De Morgan); F. W. Bessel, *Pop. Vorlesungen*, p. 543; *Report Brit. Assoc.* i. 128, 136 (Airy); Sir G. Airy's *Autobiography*, p. 127; *Observatory*, xiii. 204, xxii. 357; *Annual Biography and Obituary* (1837); R. Grant, *Hist. of Phys. Astron.* p. 491; *Royal Society's Cat. Scient. Papers*.

POND, a small pool or body of standing water, a word often applied to one for which the bed has been artificially constructed. The word is a variant of "pound" (*q.v.*), an enclosure.

PONDICHERRY, the capital of the French possessions in India, situated on the Coromandel or western coast, 122 m. by rail S. of Madras. The territory, which is entirely surrounded by the British district of South Arcot, has an area of 115 sq. m. with a population (1901) of 174,456. The chief crops are dry grains, rice, earth-nuts and a little indigo. The territory is traversed by a branch of the South Indian railway from Villapuram. The town has a population of 27,448. It is well laid

out with fine public buildings; the water-supply is derived from artesian wells. It has an open roadstead, with a small iron pier. The port is visited yearly by 500 vessels, and has trade of the value of about some £1,300,000. The principal imports are areca-nuts, wines and liqueurs, and the chief exports ground-nuts, oil, cotton fabrics and rice. Of the export trade more than one-half is with France, but of the import trade only one-fourth. The weaving of various fabrics forms the principal industry.

Pondicherry was founded in 1683 by François Martin, on the site of a village given him by the governor of Gingee. In 1693 the Dutch took Pondicherry, but restored it, with the fortifications greatly improved, in 1697, at the peace of Ryswick. In 1748 Admiral Boscawen laid siege to it without success, but in 1761 it was taken by Colonel Coote from Lally. In 1763 it was restored to the French. In 1778 it was again taken by Sir Hector Munro, and its fortifications destroyed. In 1783 it was retransferred to the French, and in 1793 recaptured by the English. The treaty of Amiens in 1802 restored it to the French, but it was retaken in 1803. In 1816 it was finally restored to the French.

PONDO, a Kaffir people who have given their name to Pondo-land, the country comprising much of the seaboard of Kaffraria, Cape province, immediately to the south-west of Natal. The Pondo, who number about 200,000, are divided into several tribal groups, but the native government, since the annexation of the country to Cape Colony in 1894, has been subject to the control of the colonial authorities. (See KAFFIRS.)

PONDWEED, a popular name for *Potamogeton natans*, a cosmopolitan aquatic plant found in ponds, lakes and ditches, with broad, more or less oblong-ovate, olive-green, floating leaves. The name is also applied to other species of *Potamogeton*, one of the characteristic genera of lakes, ponds and streams all over the world, but more abundant in temperate regions. It is the principal genus of the natural order of Monocotyledous Potamogetonaceae, and contains plants with slender branched stems, and submerged and translucent, or floating and opaque, alternate or opposite leaves, often with membranous united stipules. The small flowers are borne above the water in



(After Wossidlo. From Strasburger's *Lehrbuch der Botanik*.)
Potamogeton natans.

1, Apex of flowering shoot. 3, Flower viewed from the side.
2, Flower viewed from above. 4, Diagram of flower.

axillary or terminal spikes; they have four stamens, which bear at the back four small herbaceous petal-like structures, and four free carpels, which ripen to form four small green fleshy fruits, each containing one seed within a hard inner coat; the seed contains a large hooked embryo. An allied genus *Zannichellia* (named after Zanichelli, a Venetian botanist), occurring in fresh and brackish ditches and pools in Britain, and also widely distributed in temperate and tropical regions, is known as horned pondweed, from the curved fruit.

PONIARD, a dagger, particularly one of small size, used for stabbing at close quarters. The French word *poignard*, from

which the English is a 16th-century adaptation, is formed from *poing*, fist, the clenched hand in which the weapon is grasped. (See DAGGER.)

PONIATOWSKI, the name of a Polish princely family of Italian origin, tracing descent from Giuseppe Torelli, who married about 1650 an heiress of the Lithuanian family of Poniator, whose name he assumed.

The first of the Poniatorowskis to distinguish himself was STANISLAUS PONIATOWSKI (1677-1762), who only belonged to the family by adoption, being the reputed son of Prince Sapieha and a Jewess. He was born at Dereczyn in Lithuania, and was adopted by Sapieha's intendant, Poniatorowski. With his father he attached himself to the party of Stanislaus Leszczynski, and became major-general in the army of Charles XII. of Sweden. After the defeat of Pultowa he conveyed Charles XII. across the Dnieper, and remained with him at Bender. From there he was sent to Constantinople, where he extracted from the sultan Achmet III. a promise to march to Moscow. When the grand vizier, Baltagi Mehemet, permitted the tsar Peter I. to retreat unharmed from the banks of the Pruth, Poniatorowski exposed his treason. He rejoined Leszczynski in the duchy of Zweibrücken, Bavaria, of which he became governor. After the death of Charles XII. in 1718 he visited Sweden; and was subsequently reconciled with Leszczynski's rival on the throne of Poland, Augustus II., who made him grand treasurer of Lithuania in 1724. On the death of Augustus II. he tried to secure the reinstatement of Leszczynski, who then resumed his claims to the Polish crown. He was taken prisoner at Danzig by the Russians, and presently gave his allegiance to Augustus III., by whom he was made governor of Cracow. He died at Ryki on the 3rd of August 1762.

His second son Stanislaus Augustus became king of Poland (see STANISLAUS II.). Of the other sons, Casimir (1721-1780) was his brother's chancellor; Andrew (1735-1773) entered the Austrian service, rising to the rank of feldzeugmeister; and Michael (1736-1794) became archbishop of Gnesen and primate of Poland. Joseph Anthony Poniatorowski (*q.v.*), son of Andrew, became one of Napoleon's marshals.

STANISLAUS PONIATOWSKI (1757-1833), son of Casimir, shared in the aggrandisement of the family during the reign of Stanislaus II., becoming grand treasurer of Lithuania, starost of Podolia and lieutenant-general of the royal army. In 1793 he settled in Vienna, and subsequently in Rome, where he made a magnificent collection of antique gems in his house on the Via Flaminia. This collection was sold at Christie's in London in May 1839. He died in Florence on the 13th of February 1833, and with him the Polish and Austrian honours became extinct.

His natural, but recognized, son, JOSEPH MICHAEL XAVIER FRANCIS JOHN PONIATOWSKI (1816-1873), was born at Rome and in 1847 was naturalized as a Tuscan subject. He received the title of prince in Tuscany (1847) and in Austria (1850). He had studied music under Ceccherini at Florence, and wrote numerous operas, in the first of which, *Giovanni di Procida*, he sang the title rôle himself at Lucca in 1838. He represented the court of Tuscany in Paris from 1848, and he was made a senator by Napoleon III., whom he followed to England in 1871. His last opera, *Gelmina*, was produced at Covent Garden in 1872. He died on the 3rd of July 1873, and was buried at Chislehurst. His son, Prince Stanislaus Augustus, married and settled in Paris. He was equerry to Napoleon III., and died in January 1908.

PONIATOWSKI, JOSEPH ANTHONY (1763-1813), Polish prince and marshal of France, son of Andrew Poniatorowski and the countess Theresa Kinsky, was born at Warsaw in 1763. Adopting a military career, he joined the Imperial army when Austria declared war against the Turks in 1788, and distinguished himself at the storming of Sabac on the 25th of April, where he was seriously wounded. Recalled by his uncle King Stanislaus when the Polish army was reorganized, he received the rank of major-general, and subsequently that of lieutenant-general, and devoted himself zealously to the improvement of the

national forces. In 1789, when Poland was threatened by the armed intervention of Russia, he was appointed commander of the Ukraine division at Braclaw on Bug. After the proclamation of the constitution of the 3rd of May 1791 he was appointed commander-in-chief, with instructions to guard the banks of the Dniester and Dnieper. On the outbreak of the war with Russia, Prince Joseph, aided by Kosciuszko, displayed great ability. Obligated constantly to retreat, but disputing every point of vantage, he turned on the pursuer whenever he pressed too closely, and won several notable victories. At Polonna the Russians were repulsed with the loss of 3000 men; at Dubienka the line of the Bug was defended for five days against fourfold odds; at Zielence the Poles won a still more signal victory. Finally the Polish arms converged upon Warsaw, and were preparing for a general engagement when a courier from the capital informed the generals that the king had acceded to the confederation of Targowica (see POLAND: *History*) and had at the same time guaranteed the adhesion of the army. All hostilities were therefore to be suspended. After an indignant but fruitless protest, Poniatorowski and most of the other generals threw up their commissions and emigrated. During the Kosciuszko rising he again fought gallantly for his country under his former subordinate, and after the fall of the republic resided as a private citizen at Warsaw for the next ten years. After Jena and the evacuation of the Polish provinces by Prussia, Poniatorowski was offered the command of the National Guard; he set about reorganizing the Polish army, and on the creation of the grand duchy of Warsaw was nominated war minister. During the war of 1809, when an Austrian army corps under the archduke Ferdinand invaded the grand duchy, Poniatorowski encountered them at the bloody battle of Radzyn, and though compelled to abandon Warsaw ultimately forced the enemy to evacuate the grand duchy, and captured Cracow. In Napoleon's campaign against Russia in 1812 Poniatorowski commanded the fifth army corps; and after the disastrous retreat of the grand army, when many of the Poles began to waver in their allegiance to Napoleon, Poniatorowski remained faithful and formed a new Polish army of 13,000 men with which he joined the emperor at Lützen. In the campaign of 1813 he guarded the passes of the Bohemian mountains and defended the left bank of the Elbe. As a reward for his brilliant services at the three days' battle of Leipzig he was made a marshal of France and entrusted with the honourable but dangerous duty of covering the retreat of the army. Poniatorowski heroically defended Leipzig, losing half his corps in the attempt, finally falling back slowly upon the bridge over the Elster which the French in the general confusion blew up before he reached it. Contesting every step with the overwhelming forces of the pursuers, he refused to surrender, and covered with wounds plunged into the river, where he died fighting to the last. His relics were conveyed to Poland and buried in Cracow Cathedral, where he lies by the side of Tadeusz Kosciuszko and Jan Sobieski. Poniatorowski's *Mes souvenirs sur la campagne de 1792* (Lemberg, 1863) is a valuable historical document.

See Stanislaw Kostka Boguslawski, *Liste of Prince Joseph Poniatorowski* (Pol.; Warsaw, 1831); Franciszek Paszkowski, *Prince Joseph Poniatorowski* (Pol.; Cracow, 1898); *Correspondence of Poniatorowski* (ed. E. Raczynski, Posen, 1843); Bronislaw Dembinski, *Stanislaus Augustus and Prince Joseph Poniatorowski in the light of their Correspondence* (Fr.; Lemberg, 1904); Szymon Askenazy, *Prince Joseph Poniatorowski* (Pol.; Warsaw, 1905). (R. N. B.)

PONS, JEAN LOUIS (1761-1831), French astronomer, was born at Peyres (Hautes Alpes) on the 24th of December 1761. He entered the Marseilles observatory in 1789, and in 1819 became the director of the new observatory at Marlia near Lucca, which he left in 1825 for the observatory of the museum at Florence. Here he died on the 14th of October 1831. Between 1801 and 1827 Pons discovered thirty-seven comets, one of which (observed on the 26th of November 1818) was named after J. F. Encke, who determined its remarkably short period.

See M. R. A. Henrion, *Annuaire biographique*, i. 288 (Paris, 1834); *Memoirs Roy. Astron. Soc.* v. 410; R. Wolf, *Geschichte der Astronomie*, p. 709; J. C. Poggenдорff, *Biog. lit. Handwörterbuch*.

PONSARD, FRANÇOIS (1814-1867), French dramatist, was born at Vienne, department of Isère, on the 1st of June 1814. He was bred a lawyer, and his first performance in literature was a translation of *Manfred* (1837). His play *Lucrèce* was represented at the *Théâtre Français* on the 1st of April 1843. This date is a kind of epoch in literature and dramatic history, because it marked a reaction against the romantic style of Dumas and Hugo. He received in 1845 the prize awarded by the Academy for a tragedy "to oppose a dike to the waves of romanticism." Ponsard adopted the liberty of the romantics with regard to the unities of time and place, but he reverted to the more sober style of earlier French drama. The tastes and capacities of the greatest tragic actress of the day, Rachel, suited his methods, and this contributed greatly to his own popularity. He followed up *Lucrèce* with *Agnès de Méranie* (1846), *Charlotte Corday* (1850), and others. Ponsard accepted the empire, though with no very great enthusiasm, and received the post of librarian to the senate, which, however, he soon resigned, fighting a bloodless duel with a journalist on the subject. *L'Honneur et l'argent*, one of his most successful plays, was acted in 1853, and he became an Academician in 1855. For some years he did little, but in 1866 he obtained great success with *Le Lion amoureux*, another play dealing with the revolutionary epoch. His *Galilée*, which excited great opposition in the clerical camp, was produced early in 1867. He died in Paris on the 7th of July of the same year, soon after his nomination to the commandership of the Legion of Honour. Most of Ponsard's plays hold a certain steady level of literary and dramatic ability, but his popularity is in the main due to the fact that his appearance coincided with a certain public weariness of the extravagant and unequal style of 1830.

His *Œuvres complètes* were published in Paris (3 vols., 1865-1876). See *La Fin du théâtre romantique et François Ponsard d'après des documents inédits* (1899), by C. Latreille.

PONSONBY, JOHN (1713-1789), Irish politician, second son of Brabazon Ponsonby, 1st earl of Bessborough, was born on the 29th of March 1713. In 1739 he entered the Irish parliament and in 1744 he became first commissioner of the revenue; in 1746 he was appointed a privy councillor, and in 1756 Speaker of the Irish House of Commons. Belonging to one of the great families which at this time monopolized the government of Ireland, Ponsonby was one of the principal "undertakers," men who controlled the whole of the king's business in Ireland, and he retained the chief authority until the marquess Townshend became lord-lieutenant in 1767. Then followed a struggle for supremacy between the Ponsonby faction and the party dependent on Townshend, one result of this being that Ponsonby resigned the speakership in 1771. He died on the 12th of December 1789. His wife was Elizabeth, daughter of William Cavendish, 3rd duke of Devonshire, a connexion which was of great importance to the Ponsonbys.

Ponsonby's third son, George Ponsonby (1755-1817), lord chancellor of Ireland, was born on the 5th of March 1755 and was educated at Trinity College, Cambridge. A barrister, he became a member of the Irish parliament in 1776 and was chancellor of the Irish exchequer in 1782, afterwards taking a prominent part in the debates on the question of Roman Catholic relief, and leading the opposition to the union of the parliaments. After 1800 Ponsonby represented Wicklow and then Tavistock in the united parliament; in 1806 he was lord chancellor of Ireland, and from 1808 to 1817 he was the official leader of the opposition in the House of Commons. He left an only daughter when he died in London on the 8th of July 1817.

George Ponsonby's elder brother, William Brabazon Ponsonby, 1st Baron Ponsonby (1744-1806), was also a leading Whig politician, being a member of the Irish, and after 1800, of the British parliament. In 1806 shortly before his death he was created Baron Ponsonby of Imokilly. Three of his sons were men of note. The eldest was John (c. 1770-1855), who succeeded to the barony and was created a viscount in 1839; he was ambassador at Constantinople from 1832 to 1837 and at Vienna from 1846 to 1850. The second son was Major-

General Sir William Ponsonby (1772-1815), who, after serving in the Peninsular War, was killed at the battle of Waterloo whilst leading a brigade of heavy cavalry. Another son was Richard Ponsonby (1772-1853), bishop of Derry. Sir William Ponsonby's posthumous son William (1816-1861) became 3rd Baron Ponsonby on the death of his uncle John, Viscount Ponsonby; he died childless and was succeeded by his cousin William Brabazon Ponsonby (1807-1866), only son of the bishop of Derry, on whose death the barony of Ponsonby became extinct.

Among other members of this family may be mentioned Major-General Sir Frederick Cavendish Ponsonby (1783-1837), son of the 3rd earl of Bessborough, a soldier who distinguished himself at the battles of Talavera, Salamanca and Vittoria, in the Peninsular War, and was wounded at Waterloo; he was governor of Malta from 1826 to 1835. His eldest son, Sir Henry Frederick Ponsonby (1825-1895), a soldier who served in the Crimea, is best remembered as private secretary to Queen Victoria from 1870 until a few months before his death.

PONSON DU TERRAIL [PIERRE ALEXIS DE PONSON], VICOMTE DE (1829-1871), French romance writer, was born at Montmaur (Isère) on the 8th of July 1829. He was a prolific novelist, producing in the space of two years some seventy-three volumes. Among his most successful productions were *Les Coulisses du monde* (1853), *Exploits de Rocamboles* (1859), *Les Drames de Paris* (1865) and *Le Forgeron de la Cour-Dieu* (1869). He died at Bordeaux on the 20th of January 1871.

PONT (or KYLPONT), **ROBERT** (1524-1606), Scottish reformer, was educated at St Andrews. In 1562 he was appointed minister at Dunblane and then at Dunkeld; in 1563, commissioner for Moray, Inverness and Banff. Then in succession he became minister of Birnie (1567), provost of Trinity College near Edinburgh (1571), a lord of session (1572), minister of St Cuthbert's, Edinburgh (1573) and at St Andrews (1581). Pont was a strenuous champion of ecclesiastical independence, and for protesting against parliamentary interference in church government he was obliged to leave his country. From 1584 to 1586 he was in England, but returning north he resumed his prominence in church matters and kept it until his death in 1606. His elder son Timothy Pont (1560?-1614?) was a good mathematician, surveyor, and "the first projector of a Scottish atlas."

PONTA DELGADA, the capital of an administrative district, comprising the islands of St Michael's and St Mary in the Portuguese archipelago of the Azores. Pop. (1900), 17,620. Ponta Delgada is built on the south coast of St Michael's, in 37° 40' N. and 25° 36' W. Its mild climate, and the fine scenery of its mountain background, render it very attractive to visitors; it is the commercial centre, and the most populous city of the archipelago. Besides the cathedral, it contains several interesting churches and monasteries, and an observatory. Formerly its natural inner harbour only admitted vessels of light draught, while larger ships were compelled to anchor in an open roadstead, which was inaccessible during the prevalence of southerly gales. But great improvements were effected after 1860 by the construction of a breakwater 2800 ft. long.

PONT-À-MOUSSON, a town of northern France in the department of Meurthe-et-Moselle, 17 m. N.N.W. of Nancy by rail. Pop. (1906), 12,282. The Moselle, which is canalized, divides the town into two quarters, united by a bridge of the late 16th century. The church of St Martin, dating from the 13th, 14th and 15th centuries, has a handsome façade with two towers, and in the interior a choir screen and Holy Sepulchre of the 15th century. The lower ecclesiastical seminary occupies the building of an old Premonstratensian convent. There are several interesting old houses. The town has a communal college and engineering workshops, blast furnaces, and manufactures of lacquered ware, paper, cardboard, cables and iron-ware. Dating from the 9th or 10th century, Pont-à-Mousson constituted a lordship, which was made a marquise in 1354. It was from 1572 to 1763 the seat of a well-known university.

PONTANUS, JOVIANUS (1426-1503), Italian humanist and poet, was born in 1426 at Cerreto in the duchy of Spoleto,

where his father was murdered in one of the frequent civil brawls which then disturbed the peace of Italian towns. His mother escaped with the boy to Perugia, and it was here that Pontano received his first instruction in languages and literature. Failing to recover his patrimony, he abandoned Umbria, and at the age of twenty-two established himself at Naples, which continued to be his chief place of residence during a long and prosperous career. He here began a close friendship with the distinguished scholar, Antonio Beccadelli, through whose influence he gained admission to the royal chancery of Alphonso the Magnanimous. Alphonso discerned the singular gifts of the young scholar, and made him tutor to his sons. Pontano's connexion with the Aragonese dynasty as political adviser, military secretary and chancellor was henceforth a close one; and the most doubtful passage in his diplomatic career is when he welcomed Charles VIII. of France upon the entry of that king into Naples in 1495, thus showing that he was too ready to abandon the princes upon whose generosity his fortunes had been raised. Pontano illustrates in a marked manner the position of power to which men of letters and learning had arrived in Italy. He entered Naples as a penniless scholar. He was almost immediately made the companion and trusted friend of its sovereign, loaded with honours, lodged in a fine house, enrolled among the nobles of the realm, enriched, and placed at the very height of social importance. Following the example of Pomponio Leto in Rome and of Cosimo de' Medici at Florence, Pontano founded an academy for the meetings of learned and distinguished men. This became the centre of fashion as well as of erudition in the southern capital, and subsisted long after its founder's death. In 1461 he married his first wife, Adriana Sassone, who bore him one son and three daughters before her death in 1491. Nothing distinguished Pontano more than the strength of his domestic feeling. He was passionately attached to his wife and children; and, while his friend Beccadelli signed the licentious verses of *Hermaphroditus*, his own Muse celebrated in liberal but loyal strains the pleasures of conjugal affection, the charm of infancy and the sorrows of a husband and a father in the loss of those he loved. Not long after the death of his first wife Pontano took in second marriage a beautiful girl of Ferrara, who is only known to us under the name of Stella. Although he was at least sixty-five years of age at this period, his poetic faculty displayed itself with more than usual warmth and lustre in the glowing series of elegies, styled *Eridanus*, which he poured forth to commemorate the rapture of this union. Stella's one child, Lucilio, survived his birth but fifty days; nor did his mother long remain to comfort the scholar's old age. Pontano had already lost his only son by the first marriage; therefore his declining years were solitary. He died in 1503 at Naples, where a remarkable group of terra-cotta figures, life-sized and painted, still adorns his tomb in the church of Monte Oliveto. He is there represented together with his patron Alphonso and his friend Sannazzaro in adoration before the dead Christ.

As a diplomatist and state official Pontano played a part of some importance in the affairs of southern Italy and in the Barons' War, the wars with Rome, and the expulsion and restoration of the Aragonese dynasty. But his chief claim upon the attentions of posterity is as a scholar. His writings divide themselves into dissertations upon such topics as the "Liberality of Princes" or "Ferocity," composed in the rhetorical style of the day, and poems. He was distinguished for energy of Latin style, for vigorous intellectual powers, and for the faculty, rare among his contemporaries, of expressing the facts of modern life, the actualities of personal emotion, in language sufficiently classical yet always characteristic of the man. His prose treatises are more useful to students of manners than the similar lucubrations of Poggio. Yet it was principally as a Latin poet that he exhibited his full strength. An ambitious didactic composition in hexameters, entitled *Urania*, embodying the astronomical science of the age, and adorning this high theme with brilliant mythological episodes, won the admiration of Italy. It still remains a monument of fertile invention,

exuberant facility and energetic handling of material. Not less excellent is the didactic poem on orange trees, *De hortis Hesperidum*. His most original compositions in verse, however, are elegiac and hendecasyllabic pieces on personal topics—the *De conjugali amore*, *Eridanus*, *Tumuli*, *Naeniae*, *Baiae*, &c.—in which he uttered his vehemently passionate emotions with a warmth of southern colouring, an evident sincerity, and a truth of painting from reality which excuse their erotic freedom.

Pontano's prose and poems were printed by the Aldi at Venice. For his life see Ardito, *Giovanni Pontano e i suoi tempi* (Naples, 1871); for his place in the history of literature, Symonds, *Renaissance in Italy*. (J. A. S.)

PONTARLIER, a frontier town of eastern France, capital of an arrondissement in the department of Doubs, 36 m. S.E. of Besançon by road. Pop. (1906), 7896. It is situated 2750 ft. above sea-level on the Doubs, about four miles from the Swiss frontier, and forms an important strategic point at the mouth of the defile of La Cluse, one of the principal passes across the Jura. The pass is defended by the modern fort of Larmont, and by the Fort de Joux, which was originally built in the 10th century by the family of Joux and played a conspicuous part in the history of Franche-Comté. Pontarlier is the junction of railway lines to Neuchâtel, Lausanne, Lons-le-Saunier, Dôle and Besançon. A triumphal arch of the 18th century commemorates the reconstruction of the town after the destructive fire of 1736. It was at Pontarlier that the French army of the East made its last stand against the Prussians in 1871 before crossing the Swiss frontier. The distillation of herbs, extensively cultivated for the manufacture of absinthe, kirsch and other liqueurs, is the chief industry. The town is the seat of a sub-prefect and has a tribunal of first instance and a communal college.

PONT AUDEMER, a town of north-western France, capital of an arrondissement in the department of Eure, 39 m. N.W. of Evreux, on the Risle, a left-bank affluent of the Seine, and on the railway from Evreux to Honfleur. Pop. (1906), 5700. The church of St Ouen, which has fine stained glass of the 16th century, combines the late Gothic and Renaissance styles; its choir is Romanesque. Local institutions are the sub-prefecture, a tribunal of first instance, a board of trade-arbitration, a chamber and tribunal of commerce. Manufacturing industry is active, and includes the founding of malleable metal, a spur factory, the manufacture of glue and paper, cotton-spinning and various branches of leather manufacture. There is trade in flax, wool, grain, cattle, cider, paper, iron, wood and coal. The port has a length of over half a mile on the Risle, which is navigable for small vessels from this point to its mouth (10 m.). The town owes its name to Audomar, a Frank lord, who in the 7th or 8th century built a bridge over the Risle at this point. It was the scene of several provincial ecclesiastical councils in the 12th and 13th centuries and of meetings of the estates of Normandy in the 13th century.

PONTE (Ital. for "bridge"), a rough game peculiar to the city of Pisa, in which the players, divided into two sides and provided with padded costumes, contended for the possession of one of the bridges over the Arno. The weapon used, both for offence and defence, was a kind of shield which served as a club as well.

A history and description of the game may be found in William Heywood's *Palio and Ponte* (London, 1904).

PONTECORVO, a city of Campania, Italy, in the province of Caserta, on the Garigliano, about 48 m. from Caserta and 3 m. from Aquino on the railway from Rome to Naples. Pop. (1901), 10,518 (town); 12,492 (commune). The town is approached by a triumphal arch adorned with a statue of Pius IX. The principality of Pontecorvo (about 40 sq. m. in extent), once an independent state, belonged alternately to the Tomacelli and the abbots of Monte Cassino. Napoleon bestowed it on Bernadotte in 1806, and in 1810 it was incorporated with the French Empire.

PONTÉCOULANT, LOUIS GUSTAVE LE DOULCET, COMTE DE (1764–1853), French politician, was born at Caen on the 17th of November 1764. He began a career in the army in 1778.

A moderate supporter of the revolution, he was returned to the Convention for the department of Calvados in 1792, and became commissary with the army of the North. He voted for the imprisonment of Louis XVI. during the war, and his banishment after the peace. He then attached himself to the party of the Gironde, and in August 1793 was outlawed. He had refused to defend his compatriot Charlotte Corday, who wrote him a letter of reproach on her way to the scaffold. He returned to the Convention on the 8th of March 1795, and showed an unusual spirit of moderation by defending Prieur de la Marne and Robert Lindet. President of the Convention in July 1795, he was for some months a member of the council of public safety. He was subsequently elected to the council of five hundred, but was suspected of royalist leanings, and had to spend some time in retirement before the establishment of the consulate. Becoming senator in 1805, and count of the empire in 1808, he organized the national guard in Franche Comté in 1811, and the defence of the north-eastern frontier in 1813. At the first restoration Louis XVIII. made him a peer of France, and although he received a similar honour from Napoleon during the Hundred Days, he sat in the upper house under the Second Restoration. He died in Paris on the 3rd of April 1853, leaving memoirs and correspondence from which were extracted four volumes (1861-1865) of *Souvenirs historiques et parlementaires 1764-1848*.

His son Louis Adolphe Le Doulcet, comte de Pontécoulant (1794-1882), served under Napoleon in 1812 and 1814, and then emigrated to Brazil, where he took part in the abortive insurrection at Pernambuco in 1817. He also organized a French volunteer contingent in the Belgian revolution of 1830, and was wounded at Louvain. The rest of his life was spent in Paris in the study of ancient music and acoustics. Among his works was one on the *Musée instrumental du conservatoire de musique* (1864). A younger brother, Philippe Gustave Le Doulcet, comte de Pontécoulant (1795-1874), served in the army until 1849, when he retired to devote himself to mathematics and astronomy. His works include *Théorie analytique du système du monde* (Paris, 1829-1846) and *Traité élémentaire de physique céleste* (2 vols., Paris, 1840).

PONTEFRACT (pronounced and sometimes written "Pomfret"), a market town and municipal and parliamentary borough in the West Riding of Yorkshire, England, 21 m. S.S.W. from York, served by the Midland, North-Eastern and Lancashire & Yorkshire railways. Pop. (1891), 9702; (1901), 13,427. It is well situated, mainly on an eminence, near the junction of the Aire and the Calder. The most important of the antiquarian remains are the ruins of the famous castle situated on a rocky height, originally covering with its precincts an area of over 8 acres, and containing in all eight round towers. The remains are principally of Norman date, and an unusual feature of the stronghold is the existence of various subterranean chambers in the rock. Below the castle is All Saints church, which suffered severely during the siege of the castle, but still retains some work of the 12th century. In 1837 the tower and transepts were fitted for divine service. The church of St Giles, formerly a chapel of ease to All Saints, but made parochial in the 18th century, is of Norman date, but most of the present structure is modern. The 17th-century spire was removed in 1707, and replaced by a square tower, which was rebuilt in 1797; the chancel was rebuilt in 1869. In Southgate is an ancient hermitage and oratory cut out of the solid rock, which dates from 1306. On St Thomas's Hill, where Thomas, earl of Lancaster, was beheaded in 1322, a chantry was erected in 1373, the site of which is now occupied by a windmill built of its stones. At Monkhill there are the remains of a Tudor building called the Old Hall, probably constructed out of the old priory of St John's. A grammar school of ancient foundation, renewed by Elizabeth and George III., occupies modern buildings. The town-hall was built at the close of the 18th century on the site of one erected in 1656, which succeeded the old moot-hall dating from Saxon times. Among other buildings are the court house, the market hall, the assembly rooms (a handsome building adjoining the town-hall), and large barracks. The foundation of the

principal almshouse, that of St Nicholas, dates from before the Conquest. Trinity Hospital was founded by Sir Robert Knolles (d. 1407), an eminent military commander in the French wars of Edward III. At Ackworth, in the neighbourhood, there is a large school of the Society of Friends or Quakers (1778), in the foundation of which Dr John Fothergill (1712-1780) was a prime mover. There are extensive gardens and nurseries in the neighbourhood of Pontefract, and liquorice is largely grown for the manufacture of the celebrated Pomfret cakes. The town possesses ironfoundries, sack and matting manufactories, tanneries, breweries, corn mills and brick and terra-cotta works. The parliamentary borough, falling within the Osgoldcross division of the county, returns one member (before 1885 the number was two). The town is governed by a mayor, six aldermen and 18 councillors. Area, 4078 acres.

The remains of a Roman camp have been discovered near Pontefract, but there is no trace of settlement in the town itself until after the Conquest. At the time of the Domesday Survey Tateshall (now Tanshelf, a suburb of the town) was the chief manor and contained 60 burgesses, while Kirkby, which afterwards became the borough of Pontefract, was one of its members. The change was probably owing to the fact that Ilbert de Lacy, to whom the Conqueror had granted the whole of the honour of Pontefract, founded a castle at Kirkby, on a site said to have been occupied by a fortification raised by Ailric, a Saxon thane. Several reasons are given for the change of name but none is at all satisfactory. One account says that it was caused by a broken bridge which delayed the Conqueror's advance to the north, but this is known to have been at Ferrybridge, three miles away; a second says that the new name was derived from a Norman town called Pontfretre, which, however, never existed; and a third that it was caused by the breaking of a bridge in 1153 on the arrival of the archbishop of York, St William, when several people were miraculously preserved from drowning, although the town was already known as Pontefract in 1140 when Archbishop Thurstan died there. The manor remained in the Lacy family until it passed by marriage to Thomas, duke of Lancaster, who was beheaded on a hill outside the town after the battle of Boroughbridge. His estates were restored to his brother Henry, earl of Lancaster, on the accession of Edward III., and the manor has since then formed part of the duchy of Lancaster. The town took part in most of the rebellions in the north of England, and in 1399 Richard II. was imprisoned and secretly murdered in the castle. During the Wars of the Roses the town was loyal to Henry VI., and several of the Yorkist leaders were executed here after the battle of Wakefield. It was taken by Robert Aske, leader of the Pilgrimage of Grace, in 1536. In 1642 the castle was garrisoned for Charles I. and sustained four sieges, the second, in 1644, being successful, but two years later it was retaken by the royalists, who held it until after the execution of the king, when they surrendered to General Lambert and the castle was destroyed.

Roger de Lacy in 1194 granted a charter to the burgesses confirming their liberties and right to be a free borough at a fee-farm of 12d. yearly for every toft, granting them the same privileges as the burgesses of Grimsby, and that their reeve should be chosen annually by the lord of the manor at his court leet, preference being given to the burgesses if they would pay as much as others for the office. Henry de Lacy confirmed this charter in 1278 and in 1484 Richard III. incorporated the town under the title of mayor and burgesses and granted a gild merchant with a hanse. His charter was withdrawn on the accession of Henry VII. and a similar one was granted, while in 1489 the king gave the burgesses licence to continue choosing a mayor as they had done in the time of Richard III. In 1606-1607 James I. confirmed the charter of Henry VII. and regulated the choice of the mayor by providing that he should be elected from among the chief burgesses by the burgesses themselves. The privilege of returning two members to parliament which had belonged to Pontefract at the end of the 13th century was revived in 1620-1621 on the grounds that the charter of 1606-1607 had restored all their privileges to the burgesses. Since the

Redistribution of Seats Act of 1885 one member only has been returned. Liquorice was largely grown as early as 1700-1701, when the corporation prohibited the sale of buds or sets of the plant. Richard III. by his incorporation charter granted the market rights in the borough to the burgesses, who still hold them under his charter.

See *Victoria County History: Yorkshire; Eighth Report of the Royal Commission on Historical Manuscripts* (1870-1897); *Book of Entries of the Pontefract Corporation, 1653-1726* (ed. by Richard Holmes, 1882); Benjamin Boothroyd, *The History of the Ancient Borough of Pontefract* (1807); George Fox, *The History of Pontefract* (1827).

PONTEVEDRA, a maritime province of north-western Spain, formed in 1833 of districts taken from Galicia, and bounded on the N. by Corunna, E. by Lugo and Orense, S. by Portugal and W. by the Atlantic. Pop. (1900), 457,262; area, 1695 sq. m. Pontevedra is the smallest of the provinces of Spain except the three Basque Provinces; its density of population, 269.8 inhabitants per square mile, is only excelled in the provinces of Barcelona and Biscay (Vizcaya). Both of these are mining and manufacturing districts, while Pontevedra is dependent on agriculture and fisheries. The surface is everywhere mountainous, and consists almost entirely of arable land, pasture or forest. The coast-line is deeply indented; navigation is rendered difficult by the prevalence of fogs in summer and storms in winter. The river Miño (Portuguese Minho) forms the southern frontier, and is navigable by small ships as far as Salvatierra; and the province is watered by many smaller streams, all flowing, like the Miño, into the Atlantic. The largest of these are the Ulla, which separates Pontevedra from Corunna, the Umia and the Lerez. Pontevedra has a mild climate, a fertile soil and a very heavy rainfall. Large agricultural fairs are held in the chief towns, and there is a considerable export trade in cattle to Great Britain and Portugal, hams, salt meat and fish, eggs, breadstuffs, leather and wine. Vigo is the headquarters of shipping, and one of the chief ports of northern Spain. There are also good harbours at Bayona, Carril, Marin, Villagarcia and elsewhere among the deep estuaries of the coast. At Tuy the Spanish and Portuguese railways meet, and from this town one line goes up the Miño valley to Orense, and another northward along the coast to Santiago de Compostela.

PONTEVEDRA, the capital of the Spanish province of Pontevedra; on the Tuy-Corunna railway, and on the river Lerez, which here enters the Ria de Pontevedra, an inlet of the Atlantic. Pop. (1900), 22,330. The name of the town is derived from the ancient Roman bridge (*pons vetus*) of twelve arches, which spans the Lerez near its mouth. Pontevedra is a picturesque town, mainly built of granite, and still partly enclosed by medieval fortifications. It contains handsome provincial and municipal halls erected in the 19th century, and many convents, some of which have been converted into hospitals or schools. Marin and Sanguenjo are ports on the Ria de Pontevedra, which is the seat of a thriving sardine fishery. There is an active trade in grain, wine and fruit; cloth, hats, leather and pottery are manufactured.

PONTIAC (c. 1720-1769), Indian chief of the Ottawa and leader in the "Conspiracy of Pontiac" in 1763-64, was born between 1712 and 1720 probably on the Maumee river, near the mouth of the Auglaize. His father was an Ottawa, and his mother an Ojibwa. By 1755 he had become a chief of the Ottawa and a leader of the loose confederacy of the Ottawa, Potawatomi and Ojibwa. He was an ally of France and possibly commanded the Ottawa in the defeat (July 9, 1755) of General Edward Braddock. In November 1760 he met Major Robert Rogers, then on his way to occupy Michilimackinac and other forts surrendered by the French, and agreed to let the English troops pass unmolested on condition that he should be treated with respect by the British. Like other Indians he soon realized the difference between French and English rule—that the Indians were no longer welcomed at the forts and that they would ultimately be deprived of their hunting grounds by encroaching English settlements. French hunters and traders encouraged Indian disaffection with vague promises of help from France; in 1762 an Indian "prophet" among the Delawares on the Muskingum preached a union of the Indians to expel the

English; and in that year (as in 1761) there were abortive conspiracies to massacre the English garrisons of Detroit, Fort Niagara and Fort Pitt (now Pittsburg). Pontiac seems to have been chief of a magic association (the *Metai*), and he took advantage of the religious fervour and the general unrest among the Indians to organize in the winter of 1762-63 a simultaneous attack on the English forts to be made in May 1763 at a certain phase of the moon. On the 27th of April 1763, before a meeting near Detroit of delegates from most of the Algonquian tribes, he outlined his plans. On the 7th of May, with 60 warriors, he attempted unsuccessfully to gain admission to Detroit, which then had a garrison of about 160 under Major Henry Gladwin (1730-1791); and then besieged the fort from the 9th of May to the end of October. On the 28th of May reinforcements from Fort Niagara were ambuscaded near the mouth of the Detroit. In June the Wyandot and Potawatomi withdrew from the siege, but on the 29th of July they attacked reinforcements (280 men, including 20 of Rogers's rangers) from Fort Niagara under Captain James Dalyell (or Dalzell), who, however, gained the fort, and in spite of Gladwin's opposition on the 31st of July attacked Pontiac's camp, but was ambuscaded on Bloody Run and was killed, nearly 60 others being killed or wounded. On the 12th of October the Potawatomi, Ojibwa and Wyandot made peace with the English; with the Ottawa Pontiac continued the siege until the 30th of October, when he learned from Neyon de la Vallière, commandant of Fort Chartres (among the Illinois) that he would not be aided by the French. Pontiac then withdrew to the Maumee.

Fort Pitt with a garrison of 330 men under Captain Simeon Ecuyer was attacked on the 22nd of June and was besieged from the 27th of July to the 1st of August, when the Indians withdrew to meet a relief expedition of 500 men, mostly Highlanders, under Colonel Henry Bouquet (1719-1766), who had set out from Carlisle, Pennsylvania, on the 18th of July, and relieved Fort Ligonier (on the site of the borough of Ligonier, Westmoreland county, Penn.) on the 2nd of August, but was surprised on the 5th, and fought (5th and 6th) the battle of Bushy Run (25 m. S.E. of Fort Pitt), finally flanking and routing the Indians after tricking them by a feigned retreat of a part of his force. Bouquet reached Fort Pitt on the 10th of August. At Michilimackinac (Mackinac), Michigan, on the 4th of June, the Indians gained admission to the fort by a trick, killed nearly a score of the garrison and captured the remainder, including Captain George Etherington, the commander, besides several English traders, including Alexander Henry (1739-1824).¹ Some of the captives were seized by the Ottawa, who had taken no part in the attack; a part of these were released, and reached Montreal on the 13th of August. Seven of the prisoners kept by the Ojibwa were killed in cold blood by one of their chiefs. Fort Sandusky (on the site of Sandusky, Ohio) was taken on the 16th of May by Wyandot; and Fort St Joseph (on the site of the present Niles, Mich.) was captured on the 25th of May and 11 men (out of its garrison of 14) were massacred, the others with the commandant, Ensign Schlosser, being taken to Detroit and exchanged for Indian prisoners. On the 27th of May Fort Miami (on the site of Fort Wayne, Indiana) surrendered to the Indians after its commander, Ensign Holmes, had been treacherously killed. Fort Ouiatanon (about 5 m. south-west of the present Lafayette, Indiana) and Fort Presque Isle (on the site of Erie, Penn.) were taken by the Indians on the 1st and 16th of June respectively; and Fort Le Boeuf (on the site of Waterford,

¹ Henry, a native of New Brunswick, N.J., had become a fur-trader at Fort Michilimackinac in 1761. He was rescued by Wawatam, an Ottawa, who had adopted him as a brother; in 1764 he took part in Colonel John Bradstreet's expedition; in 1770, with Sir William Johnson, the duke of Gloucester and others, formed a Company to mine copper in the Lake Superior region; was a fur-trader again until 1796; and then became a merchant in Montreal. His *Travels and Adventures in Canada and the Indian Territories between the Years 1760 and 1776* (1809; reprinted 1901) is a valuable account of the fur trade and of his adventures at Michilimackinac. He is not to be confused with his nephew of the same name, also a fur-trader, whose journal was published in 1897 in 3 vols., as *New Light on the Early History of the Greater Northwest*.

Penn.) was surprised on the 18th, but its garrison escaped, and seven (out of 13) got safely to Fort Pitt. Fort Venango (near the site of the present Venango, Penn.) was taken and burnt about the same time by some Senecas (the only Iroquois in the conspiracy), who massacred the garrison and later burned the commander, Lieut. Gordon. About 500 Senecas on the 14th of September surprised a wagon train, escorted by 24 soldiers, from Fort Schlosser (2 m. above Niagara Falls), drove most of them over the brink of the Devil's Hole (below the cataract), and then nearly annihilated a party from Fort Niagara sent to the rescue.

In 1763, although the main attacks on Detroit and Fort Pitt had failed, nearly every minor fort attacked was captured, about 200 settlers and traders were killed, and in property destroyed or plundered the English lost about £100,000, the greatest loss in men and property being in western Pennsylvania.

In June 1764 Colonel John Bradstreet (1711-1774) led about 1200 men from Albany to Fort Niagara, where at a great gathering of the Indians several treaties were made in July; in August he made at Presque Isle a treaty (afterwards annulled by General Thomas Gage) with some Delaware and Shawnee chiefs; and in September made treaties (both unsatisfactory) with the Wyandot, Ottawa and Miami at Sandusky, and with various chiefs at Detroit. He sent Captain Howard to occupy the forts at Michilimackinac, Green Bay and Sault Ste Marie, and Captain Morris up the Maumee river, where he conferred with Pontiac, and then to Fort Miami, where he narrowly escaped death at the hands of the Miami; and with his men Bradstreet returned to Oswego in November, having accomplished little of value. An expedition of 1500 men under Colonel Bouquet left Carlisle, Pennsylvania, in August, and near the site of the present Tuscarawas, Ohio, induced the Indians to release their prisoners and to stop fighting—the practical end of the conspiracy. Pontiac himself made submission to Sir William Johnson on the 25th of July 1766 at Oswego, New York. In April 1769 he was murdered, when drunk, at Cahokia (nearly opposite St Louis) by a Kaskaskia Indian bribed by an English trader; and he was buried near the St Louis Fort. His death occasioned a bitter war in which a remnant of the Illinois was practically annihilated in 1770 at Starved Rock (between the present Ottawa and La Salle), Illinois, by the Potawatomi, who had been followers of Pontiac. Pontiac was one of the most remarkable men of the Indian race in American history, and was notable in particular for his power (rare among the Indians) of organization.

See Francis Parkman, *The Conspiracy of Pontiac* (2 vols., Boston, 1851; 10th ed., 1896).

PONTIAC, a city and the county-seat of Oakland county, Michigan, U.S.A., on the Clinton river, about 26 m. N.W. of Detroit. Pop. (1890), 6200; (1900) 9769, of whom 2020 were foreign-born; (1910 U.S. census) 14,532. It is served by the Grand Trunk and the Pontiac, Oxford & Northern railways (being the southern terminus of the latter), and by the Detroit & Pontiac and the North-Western electric inter-urban lines. In the surrounding country there are many small, picturesque lakes (the largest being Orchard, about 6 m. south-east of Pontiac, Cass and Elizabeth lakes), and there is good hunting and fishing in the vicinity. In Pontiac is the Eastern Michigan Asylum for the insane (1878), with grounds covering more than 500 acres. The city has various manufactures, and the value of the factory products increased from \$2,470,887 in 1900 to \$3,047,422 in 1904, or 23.3%. Agricultural products, fruit and wool from the surrounding country are shipped in considerable quantities. The municipality owns and operates its waterworks. Pontiac, named in honour of the famous Indian chief of that name, was laid out as a town in 1818, became the county-seat in 1820, was incorporated as a village in 1837, and was chartered in 1861.

PONTIANUS, pope from 230 to 235. He was exiled by the emperor Maximinus to Sardinia, and in consequence of this sentence resigned (Sept. 28, 235). He was succeeded by Anteros.

PONTIFEX. The collegium of the Pontifices was the most important priesthood of ancient Rome, being specially charged with the administration of the *jus divinum*, i.e. that part of the

civil law which regulated the relations of the community with the deities recognized by the state officially, together with a general superintendence of the worship of gens and family. The name is clearly derived from *pons* and *facere*, but whether this should be taken as indicating any special connexion with the sacred bridge over the Tiber (*Pons Sublucius*), or what the original meaning may have been, cannot now be determined. The college existed under the monarchy, when its members were probably three in number; they may safely be considered as legal advisers of the rex in all matters of religion. Under the republic they emerge into prominence under a *pontifex maximus*, who took over the king's duties as chief administrator of religious law, just as his chief sacrificial duties were taken by the *rex sacrorum*; his dwelling was the *regia*, "the house of the king." During the republican period the number of pontifices increased, probably by multiples of three, until after Sulla (82 B.C.) we find them fifteen; for the year 57 B.C. we have a complete list of them in Cicero (*Harusp. resp.* 6, 12). Included in the collegium were also the *rex sacrorum*, the *flamines*, three assistant pontifices (*minores*), and the *vestal virgins*, who were all chosen by the *pontifex maximus*. Vacancies in the body of pontifices were originally filled by co-optation; but from the second Punic War onwards the *pontifex maximus* was chosen by a peculiar form of popular election, and in the last age of the republic this held good for all the members. They all held office for life.

The immense authority of the college centred in the *pontifex maximus*, the other pontifices forming his *consilium* or advising body. His functions were partly sacrificial or ritualistic, but these were the least important; the real power lay in the administration of the *jus divinum*, the chief departments of which may briefly be described as follows: (1) the regulation of all expiatory ceremonies needed as the result of pestilence, lightning, &c.; (2) the consecration of all temples and other sacred places and objects dedicated to the gods by the state through its magistrates; (3) the regulation of the calendar both astronomically and in detailed application to the public life of the state; (4) the administration of the law relating to burials and burying-places, and the worship of the Manes, or dead ancestors; (5) the superintendence of all marriages by *confarreatio*, i.e. originally of all legal patrician marriages; (6) the administration of the law of adoption and of testamentary succession. They had also the care of the state archives, of the lists of magistrates, and kept records of their own decisions (*commentarii*) and of the chief events of each year (*annales*).

It is obvious that a priesthood having such functions as these, and holding office for life, must have been a great power in the state, and for the first three centuries of the republic it is probable that the *pontifex maximus* was in fact its most powerful member. The office might be combined with a magistracy, and, though its powers were declaratory rather than executive, it may fairly be described as quasi-magisterial. Under the later republic it was coveted chiefly for the great dignity of the position; Julius Caesar held it for the last twenty years of his life, and Augustus took it after the death of Lepidus in 12 B.C., after which it became inseparable from the office of the reigning emperor. With the decay of the empire the title very naturally fell to the popes, whose functions as administrators of religious law closely resembled those of the ancient Roman priesthood, hence the modern use of "pontiff" and "pontifical."

For further details consult Marquardt, *Staatsverwaltung*, iii. 235 seq.; Wissowa, *Religion und Kultus der Römer*, 430 seq.; Bouché-Leclercq, *Les Pontifes*, *passim*. (W. F. F.)*

PONTIVY, a town of western France, chief town of an arrondissement in the department of Morbihan, 46 m. N.N.W. of Vannes by rail. Pop. (1906), 6312 (town); 9506 (commune). The town, situated on the Blavet, at its confluence with the Nantes-Brest canal, comprises two distinct parts—the old town and that to the south known as Napoléonville. The latter, built by order of Napoleon I., who desired to make it the military headquarters for Brittany, and consisting chiefly of barracks, subsequently gave its name to the whole town, but in 1871 the old name was resumed. The ancient castle (1485) of the dukes

of Roban, whose capital the town was, is occupied by the Musée le Brigant of art and archaeology. A monument to commemorate the Breton-Angevin Union, the deputies of which met at Pontivy in 1790, was erected in 1894, and there are statues of Dr Guépin, a democrat, and General de Lourmel (d. 1854). The town has a sub-prefecture, a tribunal of first instance, and a lycée for boys. Pontivy had its origin in a monastery founded in the 7th century by St Ivy, a monk of Lindisfarne.

PONT-L'ABBÉ, a town of western France in the department of Finistère, 13 m. S.W. of Quimper by rail. Pop. (1906), of the town 4485, of the commune 6432. The town is situated on the right bank of the estuary or river of Pont-l'Abbé, 2 m. from the sea. Its port carries on fishing, imports timber, coal, &c., and exports mine-props and the cereals and vegetables of the neighbourhood. Of the old buildings of the town the chief is a church of the 14th, 15th and 16th centuries, once attached to a Carmelite convent; an old castle is occupied by the hôtel de ville. The local costumes, trimmed with the bright-coloured embroideries for which the town is noted, are among the most striking in Brittany; the *bigouden* or head-dress of the women has given its name to the inhabitants. Pont-l'Abbé carries on flour-milling and the extraction of chemicals from seaweed.

PONTMARTIN, ARMAND AUGUSTIN JOSEPH MARIE FERRARD, COMTE DE (1811-1890), French critic and man of letters, was born at Avignon (Vaucluse) on the 16th of July 1811. Imbued by family tradition with legitimist sympathies, he began by attacking the followers of the encyclopaedists and their successors. In the *Assemblée nationale* he published his *Causeries littéraires*, a series of attacks on prominent Liberals, which created some sensation. Pontmartin was an indefatigable journalist, and most of his papers were eventually published in volume form: *Contes et rêveries d'un planteur de choux* (1845); *Causeries du samedi* (1857-1860); *Nouveaux samedis* (1865-1881), &c. But the most famous of all his books is *Les Jeudis de Mme. Charbonneau* (1862), which under the form of a novel offered a series of malicious and witty portraits of contemporary writers. Pontmartin died at Avignon on the 29th of March 1890.

See Hatzfeld and Meunier, *Les Critiques littéraires du XIX^e siècle* (1894).

PONTOISE, a town of northern France, capital of an arrondissement of the department of Seine-et-Oise, 18 m. N.W. of Paris on the railway to Dieppe. Pop. (1906), 7963. Pontoise is picturesquely situated on the right bank of the Oise where it is joined by the Viosne. The traffic on the main river is large, and the tributary drives numerous mills. Of the many churches that used to exist in the town two only remain: St Maclou, a church of the 12th century, altered and restored in the 15th and 16th centuries by Pierre Lemercier, the famous architect of St Eustache at Paris, and containing a fine holy sepulchre of the 16th century; and Notre-Dame, of the close of the 16th century, which contains the tomb of St Gautier, abbot of Meulan in the 12th century. At the top of the flight of steps by which St Maclou is approached is the statue of General Leclerc, a native of the town and husband of Pauline Bonaparte. Grain and flour are the principal staples of the trade; a well-known fair is held in November. The town has a sub-prefecture, tribunals of first instance and of commerce and a communal college. At Mériel, near Pontoise, there are interesting remains of the Cistercian abbey of Le Val. Pontoise existed in the time of the Gauls as *Briaa Isarae* (Bridge of the Oise). It was destroyed by the Normans in the 9th century, united with Normandy in 1032, and acquired by Philip I. in 1064. Capital of the French Vexin, it possessed an important stronghold and played a conspicuous part in the wars between the French and the dukes of Normandy and in the Hundred Years' War. The English took it in 1419, and again in 1437. In 1441 Charles VII. took it by storm after a three months' siege. After belonging to the count of Charolais down to the treaty of Conflans, it was given as a dowry to Jeanne of France when she was divorced by Louis XII. The parlement of Paris several times met in the town; and in 1561 the states-general convoked at Orleans removed thither after the death of

Francis II. During the Fronde it offered a refuge to Louis XIV. and Mazarin. Henry III. made it an apanage for his brother the duke of Anjou. At a later period it passed to the duke of Conti. Down to the Revolution it remained a monastic town.

PONTOON (Fr. *ponton*, from Lat. *pons*, a bridge), a flat-bottomed boat, used as a ferry boat or lighter; especially a boat of particular design intended to form part of a military bridge. In modern hydraulic engineering the words ponton and pontoon are used to designate hollow water-tight structures which are secured to sunken wrecks and bring them up to the surface, and also the hollow chambers which serve as gates for docks and sluices, and are lowered and raised by the admission and pumping out of water.

Military Pontoon Bridges.—From time immemorial floating bridges of vessels bearing a roadway of beams and planks have been employed to facilitate the passage of rivers and arms of the sea. Xerxes crossed the Hellespont on a double bridge, one line supported on three hundred and sixty, the other on three hundred and fourteen vessels, anchored head and stern with their keels in the direction of the current. Darius threw similar bridges across the Bosphorus and the Danube in his war against the Scythians, and the Ten Thousand employed a bridge of boats to cross the river Tigris in their retreat from Persia. Floating bridges have been repeatedly constructed over rivers in Europe and Asia, not merely temporarily for the passage of an army, but permanently for the requirements of the country; and to this day many of the great rivers in India are crossed, on the lines of the principal roads, by floating bridges, which are for the most part supported on boats such as are employed for ordinary traffic on the river.

But light vessels which can be taken out of the water and lifted on to carriages are required for transport with an army in the field. Alexander the Great occasionally carried with his army vessels divided into portions, which were put together on reaching the banks of a river, as in crossing the Hydaspes; he is even said to have carried his army over the Oxus by means of rafts made of the hide tents of the soldiers stuffed with straw, when he found that all the river boats had been burnt. Cyrus crossed the Euphrates on stuffed skins. The practice of carrying about skins to be inflated when troops had to cross a river, which was adopted by both Greeks and Romans, still exists in the East. In the 4th century the emperor Julian crossed the Tigris, Euphrates and other rivers by bridges of boats made of skins stretched over osier frames. In the wars of the 17th century pontoons are found as regular components of the trains of armies, the Germans using a leather, the Dutch a tin and the French a copper "skin" over stout timber frames.

Modern military pontoons have been made of two forms, open as an undecked boat, or closed as a decked canoe or cylinder. During the Peninsular War the English employed open bateaux; but the experience gained in that war induced them to introduce the closed form. General Colleton devised a buoy pontoon, cylindrical with conical ends and made of wooden staves like a cask. Then General Sir Charles Pasley introduced demi-pontoons, like decked canoes with pointed bows and square sterns, a pair, attached sternwise, forming a single "pier" of support for the roadway; they were constructed of light timber frames covered with sheet copper and were decked with wood; each demi-pontoon was divided internally into separate compartments by partitions which were made as water-tight as possible, and also supplied with the means of pumping out water; when transported overland with an army a pair of demi-pontoons and the superstructure of one bay formed the load for a single carriage weighing 27.75 cwt. when loaded. The Pasley was superseded by the Blanshard pontoon, a tin coated cylinder with hemispherical ends, for which great mobility was claimed, two pontoons and two bays superstructure being carried on one waggon, giving a weight of about 45 cwt., which was intended to be drawn by four horses. The Blanshard pontoon was long used in the British army, but was ultimately discarded; and British engineers came to the conclusion that it was desirable to return to the form of the open bateau to which the engineers of all the

Continental armies had meanwhile constantly adhered. Captain Fowke, R.E., invented a folding open bateau, made of water-proof canvas attached to sliding ribs, so that for transport it could be collapsed like the bellows of an accordion and for use could be extended by a pair of stretchers. This was followed by the pontoon designed by Colonel Blood, R.E., an open bateau with decked ends and sides partly decked where the rowlock blocks were fixed. It consisted of six sets of framed ribs connected by a deep keelson, two side streaks, and three bottom streaks. The sides and bottom were of thin yellow pine with canvas secured to both surfaces by india-rubber solution, and coated outside with marine glue. The central interval between the pontoons in forming a bridge was invariably maintained at 15 ft.; for the support of the roadway five baulks were ordinarily employed, but nine for the passage of siege artillery and the heaviest loads; they fitted on to saddles resting on central saddle beams. The pontoons were not immersed to within 1 ft. of the tops of their "coamings" when carrying ordinary loads, as of infantry in marching order "in fours" crowded at a check, or the 16-pounder R.M.L. gun of position weighing 43 cwt.; nor were they immersed to within 6 in. when carrying extraordinary loads, such as disorganized infantry, or the 64-pounder R.M.L. gun weighing 98 cwt. In designing this pontoon the chief points attended to were—(1) improvement in power of support, (2) simplification in bridge construction, (3) reduction of weight in transport, and (4) adaptation for use singly as boats for ferrying purposes. One pontoon with the superstructure for a single bay constituted a load for one waggon, with a total weight behind horses of about 40 cwt.

The following table (from *Ency. Brit.* 9th ed.) shows the powers of various pontoons in use by different nations in the past. Modern improvements are comparatively few. The "working power of support" has been calculated in most instances by deducting from the "available buoyancy" one-fourth for open and one-tenth for closed vessels:—

In the English and French equipment the pontoons were originally made of two sizes, the smaller and lighter for the "advanced guard," the larger and heavier for the "reserve;" in both equipments the same size pontoon is now adopted for general requirements, the superstructure being strengthened when necessary for very heavy weights. The German army has an undivided galvanized iron pontoon, 24 ft. 6 in. long, handy as a boat, but of inadequate buoyancy for heavy traffic, with the result that the span has to be diminished and *ipso facto* the waterway obstructed. The Austrian and Italian pontoons are made in three pieces, two with bows and a middle piece without; not less than two pieces are ordinarily employed, and the third is introduced when great supporting power is required, but in all cases a constant interval is maintained between the pontoons. On the other hand, in the greater number of pontoon equipments greater supporting power is obtained not by increasing the number of supports but by diminishing the central interval between the pontoons. Within certain limits it does not matter whether the buoyancy is made up of a large number of small or a small number of large vessels, so long as the waterway is not unduly contracted and the obstruction offered to a swift current dangerously increased; but it is to be remembered that pontoon bridges have failed as frequently from being washed away as from insufficient buoyancy. In Austria efforts have been made to diminish the weight of the Birago equipment by the substitution of steel for iron. The present pontoon, in three pieces, is of steel, and 39 ft. 4 in. long, like the old pattern.

In the British army Colonel Blood's equipment was later modified by the introduction of a bipartite pontoon designed in 1889 by Lieut. Clauson, R.E. Each pontoon is carried on one waggon with a bay of superstructure, and consists of two sections, a bow-piece and a stern-piece, connected together by easily manipulated couplings of phosphor bronze. Decks and "coamings" are dispensed with, and the rowlock holes are sunk in a strong gunwale. The detachable saddle-beam, which receives the load on the centre of the thwarts, is made in sections, so as to form a continuous saddle of any length required. The baulks (or road-bearers) and chesses (or planks) remain unaltered, but chess-holders and chess-bearers are added for use in constructing light bridges for infantry in file. In this kind of bridge each pontoon section is used separately, with a roadway of chesses placed longitudinally four abreast. In the normal or medium bridge two sections, and in heavy bridge three sections are joined together. The chief advantages of the

Pontoon.	Length.	Displacement of Pontoon.	Actual Buoyancy of Pontoon.	Weight of Pontoon and one Bay of Superstructure.	Available Buoyancy.	Working Power of Support.	Central Interval in Bridge.	Power per lineal foot of Roadway.	Greatest ordinary Load per foot lineal.	Width of Roadway.	Greatest possible load at 100 lb per foot superficial of roadway.
	Ft.	Cub. Ft.	lb	lb	lb	lb	Ft.	lb	lb	Ft.	lb
Gribeauval: open bateau, oak	36.3	593	45,044	8,044	37,000	27,750	22.8	1,215	840	15.6	35,568
Austrian: open, wooden, 1799	27.0	354	22,123	3,332	18,791	14,093	16.6	849	560	11.4	18,924
Aust.-Birago: open, wooden; two pieces	28.0	303	18,907	3,249	15,658	11,744	21.7	542	560	9.3	20,181
" " " three "	39.4	445	27,791	3,884	23,907	17,930	21.7	827	560	9.3	20,181
" " iron; two pieces	28.0	353	22,090	3,698	18,392	13,794	21.7	636	560	9.3	20,181
" " " three "	39.4	530	33,135	4,501	28,634	21,476	21.7	991	560	9.3	20,181
French: open, wooden; reserve	30.9	325	20,286	3,608	16,678	12,509	19.7	635	560	10.5	20,685
" " advanced guard	19.7	156	9,734	1,506	8,228	6,171	16.4	376	560	9.3	15,252
" " general	30.9	321	20,065	3,153	16,912	12,684	19.7	644	560	9.8	19,306
Prussian: open, wooden; open order	23.7	164	10,226	2,393	7,833	5,875	15.3	384	560	9.9	15,147
" " close order	23.7	164	10,226	2,213	8,013	6,010	11.2	535	560	9.9	11,088
" " iron; open order	24.7	214	13,385	2,209	11,176	8,382	15.3	561	560	9.9	15,147
" " close order	24.7	214	13,385	2,029	11,356	8,517	11.2	759	560	9.9	11,088
Italian: open wooden; one piece	19.6	283	17,660	3,582	14,078	10,559	26.3	402	560	9.8	25,774
" " two pieces	39.2	565	35,320	4,572	30,748	23,061	26.3	878	560	9.8	25,774
" modified; one piece	24.6	325	20,290	3,401	16,889	12,669	23.0	551	560	9.8	22,540
" " two pieces	49.2	649	40,580	4,489	36,091	27,068	23.0	1,178	560	9.8	22,540
Russian { open, canvas on } open order	21.0	209	13,042	2,355	10,687	8,015	16.6	493	560	10.4	17,264
{ wooden framework; } close order	21.0	209	13,042	2,083	10,959	8,219	11.7	705	560	10.4	12,168
Belgian: open, iron; one piece	24.8	297	18,584	3,336	15,248	11,436	19.7	580	560	9.5	18,715
" " two pieces	49.2	595	37,168	4,548	32,620	24,465	19.7	1,244	560	9.5	18,715
American { india-rubber, three; } open order	20.0	130	8,125	1,980	6,145	5,530	18.0	307	580	11.0	19,800
{ cylinders connected; } close order	20.0	130	8,125	1,824	6,301	5,761	14.7	393	560	11.0	18,370
<i>English Pontoons.</i>											
Peninsular { open, tin; reserve	18.9	209	13,092	2,374	10,718	8,039	16.8	477	560	10.0	16,800
equipment { " advanced guard	15.1	120	7,520	1,654	5,866	4,400	14.0	314	560	9.0	12,600
Pasley: closed demi-canoe; copper	25.0	141	8,781	2,103	6,678	6,010	12.5	481	560	10.0	12,500
Blanshard: cylinder, tin; open order	22.5	109	6,785	1,600	5,185	4,667	12.5	373	560	10.0	12,500
" " close order	22.5	109	6,785	1,408	5,377	4,839	8.3	581	560	10.0	8,300
" " light pattern	15.5	26	1,640	340	1,300	1,170	5.3	220	280	7.0	3,710
Fowke: open, collapsible, canvas; open order	22.0	134	8,460	1,246	7,214	5,411	10.0	541	560	10.0	10,000
Forbes: closed, spherangular, tin; open order	24.2	128	7,977	1,689	6,288	5,659	11.0	514	560	10.0	11,000
Blood: open, wooden; general	21.6	280	17,500	2,300	15,200	13,350	15.0	890	560	10.0	15,000

equipment are (1) the buoyancy of the piers can be proportioned to the weight of traffic and to the roughness of the water; (2) owing to the special design of the bows, boats and rafts are easy to row, while the pontoons in bridge oppose little resistance to the current, and so require less anchor power; (3) transport rafts, pier-heads and flying bridges can be constructed with great ease, owing to the flush gunwales on which baulks can rest if necessary; (4) the pontoon sections are convenient to handle, easy to ship or to transport by rail, and can readily be replaced singly if damaged in bridge. A canoe pontoon and superstructure adapted for pack transport has also been adopted from designs by Colonel (Sir) Elliott Wood, C.B., R.E. The pontoon consists of four sections laced together, each section being a framework of wood covered with waterproof sheeting. Three pontoons and eight composite planks form a "unit," from which can be constructed 48 ft. of bridge for infantry in file, 84 ft. for infantry in single file, or a raft to carry 15 men or an empty wagon.

For the British army in India the standard pontoon for many years was the Pasley; it was seldom used, however, for boats could almost always be procured on the spot in sufficient numbers wherever a floating bridge had to be constructed. Later an equipment was prepared for the Indian army of demi-pontoons, similar to the Blood pontoon cut in half, and therefore more mobile; each has a bow and a square stern, and they are joined at the sterns when required to form a "pier"; they are fitted with movable covers and can therefore be used in much rougher water than pontoons of the home pattern, and their power of support and breadth of roadway are the same. The Chitral Relief Expedition of 1895, however, revealed certain defects. The shape of the bow was unsuited to rapid currents; the balance was not satisfactory, and the copper sheathing cracked. Experiments were then undertaken with the bipartite pontoon.

The india-rubber pontoon does not appear to have been generally employed even in America, where it was invented. The engineer officers with the army of the Potomac, after full experience of the india-rubber pontoon and countless other inventions of American genius, adopted the French equipment, which they found "most excellent, useful and reliable for all military purposes." The Russians, in crossing the Danube in their war with Turkey in 1878, employed the Austrian equipment. Aluminium pontoons have been tried in Germany, but have not been adopted.

For light bridging work the Berthon and other collapsible boats have been adopted in Germany and Great Britain, especially for cavalry work in advance of the army. The German folding boat is made of wood framework and canvas skin; two boats are easily carried on one "folding-boat wagon." The total length of the three sections together is 21 ft. 6 in. The British field troop R.E., attached to cavalry, carries two collapsible boats 18 ft. 6 in. long.

The methods of constructing pontoon bridges have been simplified of late years in most armies, and are usually restricted to (1) adding pontoons one by one to the head of the bridge; (2) connecting rafts of two or more pontoons into bridge by intermediate bays of superstructure; and (3) swinging across the river a bridge previously prepared alongside the shore. The formation of a bridge from rafts touching one another consumes an excessive amount of equipment, and opposes unnecessary resistance to the stream; it is therefore being discarded in most armies. "Booming out" the bridge bay by bay from the shore until the head reaches the opposite bank is unsuited for rapid currents, and is almost obsolete except for light infantry bridges.

In every army the pontoon service is in the hands of technical specialists.¹ But there are many other forms of military bridging, in which the specialist only supervises the work of the ordinary soldier, or indeed, takes no part whatever. Troops of all arms are expected to be familiar with certain methods of rough temporary bridging. In the British service the forms of temporary timber bridge usually employed are called trestle, lock and floating. The trestle bridge in its various forms consists of a series of two-legged or three-legged trestles carrying the road-bearers and chesses which form the roadway. Trestles can be improvised, but some are carried, ready for use, by mobile engineer units and they are frequently combined with pontoon bridges at the shore ends, where holding ground for the feet of the trestles is found. Lock bridges never touch water, forming single spans over a chasm. These consist of spars made into frames of which the feet rest in the banks of the river and the heads are interlocked, the whole being securely lashed. Another type of frame-bridge is the cantilever, which has been used in Indian frontier expeditions to bridge swift

¹In Germany, however, as mentioned below, light bridging material has been placed in the hands of the cavalry. This tendency, in accordance with the needs of modern armies, will probably become more pronounced in the future. It began with the provision of demolition equipment for the cavalry pioneers.

steep-banked streams. Improvised suspension bridges are also used. Floating bridges are made not only of pontoons but also of boats of all sorts, casks lashed together, and rafts. They are almost always combined with one or two bays of trestle bridging at the shore ends.

The organization of bridging personnel in different armies shows as much divergence of opinion as the design of pontoon equipment. In Great Britain, since the divisional reorganization, the bridging trains have been assigned to the "army troops," which include two "bridging trains," totalling 14 officers and 454 men with 92 vehicles, most of them six-horsed. Each train carries 32 pontoons and 32 bays of superstructure, as well as 16 trestles and 8 bays of the appropriate superstructure, and can construct 200 yds. of medium bridge in all. Besides these trains the divisional engineer units (2 field companies per division) bear with them in all 4 pontoons and 4 trestles, with the necessary bays of superstructure, their total bridging capacity being about 40 yds. of medium bridge. In France each army corps has a bridging train which admits of the construction of bridges to the extent of about 120 yds. of medium and 140 yds. of light bridging and bears besides 2 "advanced guard" trains which can provide 33 yds. of medium bridging each. Besides the corps trains there are also "army" trains, five in all, which can furnish 280 yds. of medium bridging apiece. These would be allotted in accordance with the requirements of particular campaigns. In Germany the increasing importance attached to independent cavalry operations has led to the assignment of a folding-boat wagon to every cavalry regiment. The regimental equipment provides for a ferry, capable of taking 25 to 30 infantrymen, one artillery vehicle or four horses at one journey, a foot-bridge 22 to 35 yds. in length, or a light bridge of 8 to 13 yds. By assembling the material of a whole cavalry division of 6 regiments, a foot-bridge of 110 to 210 yds. or a light bridge of 57 to 70 yds. can be constructed. The corps bridging train of a German army corps can construct 140 yds. of medium or 170 yds. of light bridging, and each of the two divisional trains, 40 yds. of medium and 48 yds. of light bridging.

PONTOPPIDAN, ERIK (1698-1764), Danish author, was born at Aarhus on the 24th of August 1698. He studied divinity at the university of Copenhagen, and for some time acted as a travelling tutor. In 1735 he became one of the chaplains of the king. In 1738 he was made professor extraordinary of theology at Copenhagen, and in 1745 bishop of Bergen, Norway, where he died on the 20th of December 1764.

His principal works are: *Theatrum Daniae veteris et modernae* (4to, 1730), a description of the geography, natural history, antiquities, &c., of Denmark; *Gesta et vestigia danorum extra Daniam* (3 vols. 8vo, 1740), a laborious but uncritical work; *Annales ecclesiae danicae* (3 vols., 1741-1747); *Marmora danica selectiora* (2 vols. fol., 1739-1741); *Glossarium norvegicum* (1749); *Det første forsøg Norges naturlige historie* (4to, 1752-1754); Eng. trans., *Natural History of Norway* (2 vols., 1755), containing curious accounts, often referred to, of the Kraaken, sea-serpent, and the like; *Origines hafnienses* (1760); *Menoza* (3 vols., 1742-1743), a religious novel. His *Danske Atlas* (7 vols. 4to), an historical and topographical account of Denmark, was mostly posthumous.

See an article by S. M. Gjellerup in *Danish Biografisk Lexikon* (vol. xiii., 1899).

PONTOPPIDAN, HENRIK (1857-), Danish author, son of a pastor, was born at Fredericia on the 24th of July 1857. He studied physics and mathematics at the university of Copenhagen, and when he was eighteen he travelled on foot through Germany and Switzerland. His novels show an intimate acquaintance with peasant life and character, the earlier ones showing clear evidence of the influence of Kjelland. An excellent example of his work is in the trilogy dealing with the history of Emanuel Hansted, a theorizing radical parson who marries a peasant wife. These three stories, *Muld* ("Soil," 1891), *Det Forjaettede Land* ("The Promised Land," 1892), and *Dommens Dag* (1893) are marked by fine discrimination and great narrative power. Among his other works are *Fra Hytterne* (1887), *Folkeliivsskildringer* (2 parts, 1888-1890), and *Skyer* (1890). He began in 1898 a new series in *Lykke Per*, the story of a typical Jutlander.

See an article of Niels Möller in *Dansk Biografisk Lexikon* (vol. xiii., 1899).

PONTORMO, JACOPO DA (1494-1557), whose family name was Carucci, Italian painter of the Florentine school, was born at Pantormo in 1494, son of a painter of ordinary ability, was apprenticed to Leonardo da Vinci, and afterwards took lessons from Piero di Cosimo. At the age of eighteen he became a

journeyman to Andrea del Sarto, and was remarked as a young man of exceptional accomplishment and promise. Later on, but still in early youth, he executed, in continuation of Andrea's labours, the "Visitation," in the cloister of the Servi in Florence—one of the principal surviving evidences of his powers. The most extensive series of works which he ever undertook was a set of frescoes in the church of S. Lorenzo, Florence, from the "Creation of Man to the Deluge," closing with the "Last Judgment." By this time, towards 1546, he had fallen under the dangerous spell of Michelangelo's colossal genius and superhuman style; and Pontormo, after working on at the frescoes for eleven years, left them incomplete, and the object of general disappointment and disparagement. They were finished by Angelo Bronzino, but have long since vanished under whitewash. Among the best works of Pontormo are his portraits, which include the likenesses of various members of the Medici family; they are vigorous, animated and highly finished. He was fond of new and odd experiments both in style of art and in method of painting. From Da Vinci he caught one of the marked physiognomic traits of his visages, smiles and dimples. At one time he took to direct imitation or reproduction of Albert Dürer, and executed a series of paintings founded on the Passion subjects of the German master, not only in composition, but even in such peculiarities as the treatment of draperies, &c. Pontormo died of dropsy on the 2nd of January 1557, mortified at the ill success of his frescoes in S. Lorenzo; he was buried below his work in the Servi.

PONTREMOLI, a town and bishop's see of the province of Massa and Carrara, Tuscany, Italy, in the upper valley of the Magra, 25 m. N. by E. of Spezia by rail and 49 m. S.S.W. of Parma, 843 ft. above sea-level. Pop. (1901), 4107 (town); 14,570 (commune). It has a 17th-century cathedral. The church of the Annunziata with its Augustinian monastery is interesting. There are also mineral springs. The town, which is well situated among the mountains, was an independent republic in the 12th and 13th centuries, and in 1495 was sacked by the troops of Charles VIII. of France. It was much damaged by an earthquake in 1834.

PONTUS, a name applied in ancient times to extensive tracts of country in the north-east of Asia Minor bordering on the Euxine (Black Sea), which was often called simply *Pontus* (the Main), by the Greeks. The exact signification of this purely territorial name varied greatly at different times. The Greeks used it loosely of various parts of the shores of the Euxine, and the term did not get a definite connotation till after the establishment of the kingdom founded beyond the Halys during the troubled period following the death of Alexander the Great, about 301 B.C., by Mithradates I., *Klistes*, son of a Persian satrap in the service of Antigonos, one of Alexander's successors, and ruled by a succession of kings, mostly bearing the same name, till 64 B.C. As the greater part of this kingdom lay within the immense region of Cappadocia, which in early ages extended from the borders of Cilicia to the Euxine, the kingdom as a whole was at first called "Cappadocia towards the Pontus" (*πρὸς τῷ Πόντῳ*), but afterwards simply "Pontus," the name Cappadocia being henceforth restricted to the southern half of the region previously included under that title. Under the last king, Mithradates Eupator, commonly called the Great, the realm of Pontus included not only Pontic Cappadocia but also the seaboard from the Bithynian frontier to Colchis, part of inland Paphlagonia, and Lesser Armenia (see under *MITHRADATES*). With the destruction of this kingdom by Pompey in 64 B.C., the meaning of the name Pontus underwent a change. Part of the kingdom was now annexed to the Roman Empire, being united with Bithynia in a double province called "Pontus and Bithynia": this part included (possibly from the first, but certainly from about 40 B.C. onwards) only the seaboard between Heracleia (*Eregli*) and Amisus (*Samsun*), the *ora Pontica*. Hereafter the simple name Pontus without qualification was regularly employed to denote the half of this dual province, especially by Romans and people speaking from the Roman point of view; it is so used almost always in the New Testament.

But it was also frequently used to denote (in whole or part) that portion of the old Mithradatic kingdom which lay between the Halys (roughly) and the borders of Colchis, Lesser Armenia, Cappadocia and Galatia—the region properly designated by the title "Cappadocia towards the Pontus," which was always the nucleus of the Pontic kingdom.

This region is regarded by the geographer Strabo (A.D. 19–20), himself a native of the country, as Pontus in the strict sense of the term (*Geogr.* p. 678). Its native population was of the same stock as that of Cappadocia, of which it had formed a part, an Oriental race often called by the Greeks *Leucosyri* or White Syrians, as distinguished from the southern Syrians, who were of a darker complexion, but their precise ethnological relations are uncertain. Geographically it is a table-land, forming the north-east corner of the great plateau of Asia Minor, edged on the north by a lofty mountain rim, along the foot of which runs a fringe of coast-land. The table-land consists of a series of fertile plains, of varying size and elevation separated from each other by upland tracts or mountains, and it is drained almost entirely by the river Iris (*Yeshil Irmak*) and its numerous tributaries, the largest of which are the Scylax (*Tchekerek Irmak*) with many affluents and the Lycus (*Kalkid Irmak*), all three rising in the highlands near, or on, the frontier of Armenia Minor and flowing first in a westerly and then in a north-westerly direction to merge their waters in a joint stream, which (under the name of the Iris) pierces the mountain-wall and emerges on the east of Amisus (*Samsun*). Between the Halys and the Iris the mountain rim is comparatively low and broken, but east of the Iris it is a continuous lofty ridge (called by the ancients *Paryadres* and *Scydises*), whose rugged northern slopes are furrowed by torrent beds, down which a host of small streams (among them the *Thermodon*, famed in Amazon story) tumble to the sea. These inaccessible slopes were inhabited even in Strabo's time by wild, half-barbarous tribes, of whose ethnical relations we are ignorant—the *Chalybes* (identified by the Greeks with Homer's *Chalybes*), *Tibareni*, *Mosynocci* and *Macrones*, on whose manners and condition some light is thrown by Xenophon (*Anab.* V). But the fringe of coast-land from *Trebizond* westward is one of the most beautiful parts of Asia Minor and is justly extolled by Strabo for its wonderful productiveness.

The sea-coast, like the rest of the south shore of the Euxine, was studded with Greek colonies founded from the 6th century onwards: Amisus, a colony of Miletus, which in the 5th century received a body of Athenian settlers, now the port of *Samsun*; *Cotyora*, now *Ordu*; *Cerasus*, the later *Pharnacia*, now *Kerasund*; and *Trapezus* (*Trebizond*), a famous city from Xenophon's time till the end of the middle ages. The last three were colonies of Sinope, itself a Milesian colony. The chief towns in the interior were Amasia, on the Iris, the birthplace of Strabo, the capital of Mithradates the Great, and the burial-place of the earlier kings, whose tombs still exist; *Comana*, higher up the river, a famous centre of the worship of the goddess *Ma* (or *Cybele*); *Zela*, another great religious centre, refounded by Pompey, now *Zileh*; *Eupatoria*, refounded by Pompey as *Magnopolis* at the junction of the Lycus and Iris; *Cabira*, Pompey's *Diospolis*, afterwards *Neocaesarea*, now *Niksar*; *Sebastopolis* on the Scylax, now *Sulu Seraï*; *Sebasteia*, now *Sivas*; and *Megalopolis*, a foundation of Pompey, somewhere in the same district.

The history of this region is the history of the advance of the Roman Empire towards the Euphrates. Its political position between 64 and 41 B.C., when Mark Antony became master of the East, is not quite certain. Part of it was handed over by Pompey to client princes: the coast-land east of the Halys (except the territory of Amisus) and the hill-tribes of *Paryadres* were given, with Lesser Armenia, to the Galatian chief *Deiotarus*, with the title of king; *Comana* was left under the rule of its high-priest. The rest of the interior was partitioned by Pompey amongst the inland cities, almost all of which were founded by him, and, according to one view, was included together with the seaboard west of Amisus and the corner of north-east Paphlagonia possessed by Mithradates in his new province

Pontus-Bithynia. Others maintain that only the seaboard was included in the province, the inland cities being constituted self-governing, "protected" communities. The latter view is more in conformity with Roman policy in the East, which did not usually annex countries till they reached (under the rule of client princes) a certain level of civilization and order, but it is difficult to reconcile with Strabo's statements (p. 541 sqq.). In any case, during the years following 40 B.C. all inland Pontus was handed over, like north-east Paphlagonia, to native dynasts. The Pontic possessions of Deiotarus (d. 40 B.C.) were given with additions (e.g. Cabira) in 39 B.C. to Darius, son of Pharnaces, and in 36 B.C. to Polemon, son of a rhetorician of Laodicea on the Lycus. The high-priest of Comana, Lycomedes, received an accession of territory and the royal title. The territories of Zela and Megalopolis were divided between Lycomedes, the high-priest of Zela and Ateporix, who ruled the principality of Carana (later Sebastopolis). Amasia and Amisus were also given to native princes.

After the battle of Actium (31 B.C.) Augustus restored Amisus as a "free city" to the province of Bithynia-Pontus, but made no other serious change. Polemon retained his kingdom till his death in 8 B.C., when it passed to his widow Pythodoris. But presently the process of annexation began and the Pontic districts were gradually incorporated in the empire, each being attached to the province of Galatia, then the centre of Roman forward policy. (1) The western district was annexed in two sections, Sebastopolis and Amasia in 3-2 B.C., and Comana in A.D. 34-35. To distinguish this district from the province Pontus and Polemon's Pontus, it was henceforth called *Pontus galaticus* (as being the first part attached to Galatia). (2) Polemon's kingdom, ruled since A.D. 38 by Polemon II., grandson of the former king, was annexed by Nero in A.D. 64-65, and distinguished by the title of *Pontus polemoniacus*, which survived for centuries. [But the simple name Pontus, hitherto commonly used to designate Polemon's realm, is still employed to denote this district by itself or in conjunction with Pontus Galaticus, where the context makes the meaning clear (e.g. in inscriptions and on coins).] Polemoniacus included the sea-coast from the Thermodon to Cotyora and the inland cities Zela, Magnopolis, Megalopolis, Neocaesarea and Sebasteia (according to Ptolemy, but apparently annexed since 2 B.C., according to its coins). (3) Finally, at the same time (A.D. 64) was annexed the remaining eastern part of Pontus, which formed part of Polemon's realm but was attached to the province Cappadocia and distinguished by the epithet *cappadocius*. These three districts formed distinct administrative divisions within the provinces to which they were attached, with separate capitals Amasia, Neocaesarea and Trapezus; but the first two were afterwards merged in one, sometimes called *Pontus mediterraneus*, with Neocaesarea as capital, probably when they were definitively transferred (about A.D. 114) to Cappadocia, then the great frontier military province.

With the reorganization of the provincial system under Diocletian (about A.D. 295), the Pontic districts were divided up between four provinces of the *diocesis pontica*: (1) Paphlagonia, to which was attached most of the old province Pontus; (2) Diospontus, re-named Helenopontus by Constantine, containing the rest of the province Pontus and the adjoining district, eight cities in all (including Sinope, Amisus and Zela) with Amasia as capital; (3) Pontus Polemoniacus, containing Comana, Polemonium, Cerasus and Trapezus with Neocaesarea as capital; and (4) Armenia Minor, five cities, with Sebasteia, as capital. This rearrangement gave place in turn to the Byzantine system of military districts (*themes*).

Christianity was introduced into the province Pontus (the *Ora pontica*) by way of the sea in the 1st century after Christ and was deeply rooted when Pliny governed the province (A.D. 111-113). But the Christianization of the inland Pontic districts began only about the middle of the 3rd century and was largely due to the missionary zeal of Gregory Thaumaturgus, bishop of Neocaesarea.

See Ramsay, *Histor. Geogr. of Asia Minor* (1890); Anderson and Cumont, *Studia pontica* (1903 et seq.); Babelon and Reinach, *Recueil des monnaies d'Asie min.*, t. i. (1904); H. Grégoire, "Voyage dans le Pont" &c. in *Bull. de corres. hell.* (1909). (J. G. C. A.)

PONTUS DE TYARD (c. 1521-1605), French poet and member of the Pléiade (see DAURAT), was seigneur of Bissy in Burgundy, where he was born in or about 1521. He was a friend of Antoine Héroët and Maurice Scève, and to a certain extent anticipated Ronsard and Joachim Du Bellay. His *Erreurs amoureuses*, originally published in 1549, was augmented with other poems in successive editions till 1573. On the whole his poetry is inferior to that of his companions, but he was one of the first to write sonnets in French (the actual priority belongs to Melin de St Gelais). It is also said that he introduced the sestet into France, or rather reintroduced it, for it was originally a Provençal invention. In his later years he gave himself up to the study of mathematics and philosophy. He became bishop of Châlons-sur-Saône in 1578, and in 1587 appeared his *Discours philosophiques*. He was a zealous defender of the cause of Henry III. against the pretensions of the Guises. This attitude brought down on him the vengeance of the league; he was driven from Châlons and his château at Bissy was plundered. He survived all the members of the Pléiade and lived to see the onslaught made on their doctrines by Malherbe. Pontus resigned his bishopric in 1594, and retired to the château de Bragny, where he died on the 23rd of September 1605.

His *Oeuvres poétiques* may be found in the *Pléiade française* (1875) of M. Ch. Marty-Laveaux.

PONTYPOOL, a market town in the northern parliamentary division of Monmouthshire, England, 8 m. N. of Newport, served by the Great Western, London & North-Western, and Rhymney railways. Pop. of urban district (1901), 6126. It is beautifully situated on an acclivity above the Afon Lwyd, a tributary of the Usk. Its prosperity is due to its situation on the edge of the great coal- and iron-field of Monmouthshire and Glamorganshire. The earliest record of trade in iron is in 1588, but it was developed chiefly in the beginning of the 18th century by the family of Hanbury, the proprietors of Pontypool Park. Pontypool was formerly famed for its japanned goods, invented by Thomas Allwood, a native of Northampton, who settled in the town in the reign of Charles II., but the manufacture has long been transferred elsewhere. The town and neighbourhood contain large forges and iron mills for the manufacture of iron-work and tin-plate. Water communication is afforded with Newport by the Monmouthshire Canal. On the south-east of Pontypool is the urban district of Panteg, including Griffithstown, with a population (1901) of 7484.

PONTYPRIDD, a parish, market town, and urban district, in the eastern parliamentary division of Glamorganshire, Wales, situated on the Taff at its junction with the Rhondda, on the Taff Vale railway, and on the Glamorganshire Canal, 12 m. N.N.W. from Cardiff, 12 S. from Merthyr-Tydfil, and 160 by rail from London. It is also connected with Newport by a Great Western line 18¼ m. long. Pop. (1901), 32,316. It receives its name from a remarkable bridge of one arch spanning the Taff, erected in 1755 by William Edwards, a self-taught mason. The bridge is a perfect segment of a circle, the chord being 140 ft., and the height at low water 36 ft. A three-arched bridge was erected close to it in 1857. The town is built at the junction of the three parishes of Llanwonno, Llantwit Fardre and Eglwysilan, out of portions of which Glyn-taff was formed into an ecclesiastical parish in 1848, and from this Pontypridd was carved in 1884. The urban district was constituted into a civil parish in 1894. The church of St Catherine, built in 1868, enlarged in 1885, is in early Decorated style; other places of worship are the Baptist, Calvinistic Methodist, Congregational, and Wesleyan chapels. The principal secular buildings are a masonic hall, town-hall built above the market, free library (1890), county intermediate school (1895) and court-house. Near the town is a far-famed rocking-stone 9½ tons in weight, known as the Maen Chwyf, round which a circle of small stones was set up in the middle of the 19th century under the direction

of Myvyr Morganwg, who used to style himself archdruid of Wales. The place became, for a time, famous as a meeting place for neo-Druidic gatherings. Pontypridd was an insignificant village till the opening of the Taff Vale railway into the town in 1840, and it owed its progress chiefly to the development of the coal areas of the Rhondda Valley, for which district it serves as the market town and chief business centre. It also possesses anchor, chain, and cable works, chemical works, and iron and brass foundries. Pontypridd has, jointly with Rhondda, a stipendiary magistrate since 1872.

PONY (from the Lowland Scots *powney*, probably from O. Fr. *pouleriet*, diminutive of *poulain*, a colt or foal; Late Lat. *pullanus*, Lat. *pullus*, a young animal), a horse of a small breed, sometimes confined to such as do not exceed 13 hands in height, but generally applied to any horse under 14 hands (see HORSE). The word is of frequent use as a slang term—e.g. for a sum of £25; for a liquor measure or glass containing less than a half-pint; and in America for a literal translation of a foreign or classical author, a "crib."

PONZA (anc. *Pontiae*), the principal of a small group of islands belonging to Italy. Pop. (1901), 4621. The group is of volcanic origin, and includes Palmarola (anc. Palmaria), Zannone (Sinonia), Ventotene (Pandateria, pop. in 1901, 1986) and San Stefano. It is situated about 20 m. S. of Monte Circeo and 70 m. W. of Naples, and belongs partly to the province of Caserta and partly to that of Naples (Ventotene). There is regular communication with Naples by steamer, and in summer with Anzio. The islands rise to a height of about 70 ft. above sea-level. They are now penal settlements, and their isolated character led to their being similarly used in ancient times. A colony with Latin rights was founded on Pontiae in 313 B.C. Nero, Germanicus's eldest son, and the sisters of Caligula, were confined upon it; while Pandateria was the place of banishment of Julia, daughter of Augustus, of her daughter Agrippina the elder, and of Octavia, the divorced wife of Nero.

POOD, a Russian weight, equivalent to 40 lb Russian and about 36 lb avoirdupois. A little more than 62 poods go to the ton. The word is an adaptation of the Low German or Norse *pund*, pound.

POOL. (1) A pond, or a small body of still water; also a place in a river or stream where the water is deep and still, so applied in the Thames to that part of the river known as The Pool, which reaches from below London Bridge to Limehouse. The word in Old English was *pól*, which may be related to *pull* or *pyll*, and the similar Celtic words, e.g. Cornish *pol*, a creek, common on the Bristol Channel and estuary of the Severn, on the English side in the form "pill." A further connexion has been suggested with Lat. *palus*, marsh; Gr. *πηλός*, mud. (2) A name for the stakes, penalties, &c., in various card and other games when collected together to be paid out to the winners; also the name of a variety of games of billiards (*q.v.*). This word has a curious history. It is certainly adapted from Fr. *poule*, hen, chicken, apparently a slang term for the stakes in a game, possibly, as the *New English Dictionary* suggests, used as a synonym for plunder, booty. "Chicken-hazard" might be cited as a parallel, though that has been taken to be a corruption of "chequeen," a form of the Turkish coin, a sequin. When the word came into use in English at the end of the 17th century, it seems to have been at once identified with "pool," pond, as Fr. *fiche* (*ficher*, to fix), a counter, was with "fish," counters in card games often taking the form of "fish" made of mother-of-pearl, &c. "Pool," in the sense of a common fund, has been adopted as a commercial term for a combination for the purpose of speculating in stocks and shares, the several owners of securities "pooling" them and placing them under a single control, and sharing all losses and profits. Similarly the name is given to a form of trade combination, especially in railway or shipping companies, by which the receipts or profits are divided on a certain agreed-upon basis, for the purpose of avoiding competition (see TRUSTS).

POOLE, MATTHEW (1624–1679), English Nonconformist theologian, was born at York, educated at Emmanuel College,

Cambridge, and from 1649 till the passing of the Act of Uniformity (1662) held the rectory of St Michael le Querne, London. Subsequent troubles led to his withdrawal to Holland, and he died at Amsterdam in 1679. The work with which his name is principally associated is the *Synopsis criticorum biblicorum* (5 vols. fol., 1669–1676), in which he summarizes the views of one hundred and fifty biblical critics. He also wrote *English Annotations on the Holy Bible*, as far as Isa. lviii.—a work which was completed by several of his Nonconformist brethren, and published in 2 vols. fol. in 1683.

POOLE, PAUL FALCONER (1806–1879), English painter, was born at Bristol in 1806. Though self-taught his fine feeling for colour, poetic sympathy and dramatic power gained for him a high position among British artists. He exhibited his first work in the Royal Academy at the age of twenty-five, the subject being "The Well," a scene in Naples. There was an interval of seven years before he next exhibited his "Farewell, Farewell" in 1837, which was followed by the "Emigrant's Departure," "Hermann and Dorothea" and "By the Waters of Babylon." In 1843 his position was made secure by his "Solomon Eagle," and by his success in the Cartoon Exhibition, in which he received from the Fine Art Commissioners a prize of £300 sterling. After his exhibition of the "Surrender of Syon House" he was elected an associate of the Royal Academy in 1846, and was made an academician in 1861. He died in 1879.

Poole's subjects divide themselves into two orders—one idyllic, the other dramatic. Of the former his "May Day" (1852) is a typical example. Of both styles there were excellent examples to be seen in the small collection of his works shown at Burlington House in the Winter Exhibition of 1883–1884. Among his early dramatic pictures was "Solomon Eagle exhorting the People to Repentance during the Plague of 1665," painted in 1843. To this class belongs also the "Messenger announcing to Job the Irruption of the Sabeans and the Slaughter of the Servants" (exhibited in 1850), and "Robert, Duke of Normandy and Arletta" (1848). Finer examples of his more mature power in this direction are to be found in his "Prodigal Son," painted in 1869; the "Escape of Glaucus and Ione with the blind girl Nydia from Pompeii" (1860); and "Cunstanee sent adrift by the Constable of Alla, King of Northumberland," painted in 1868. More peaceful than these are the "Song of Troubadours" (painted in 1854) and the "Goths in Italy" (1851), the latter an important historical work of great power and beauty. Of a less lofty strain, but still more beautiful in its workmanship, is the "Seventh Day of the Decameron," painted in 1857. In this picture Poole rises to his full height as a colourist. In his pastorals he is soft and tender, as in the "Mountain Path" (1853), the "Water-cress Gatherers" (1870), the "Shepston Maiden" (1872). But when he turns to the grander and more sublime views of nature his work is bold and vigorous. Fine examples of this style may be seen in the "Vision of Ezekiel" of the National Gallery, "Solitude" (1876), the "Entrance to the Cave of Mammon" (1875), the "Dragon's Cavern" (1877), and perhaps best of all in the "Lion in the Path" (1873), a great representation of mountain and cloud form.

POOLE, REGINALD STUART (1832–1895), English archaeologist and orientalist, was born in London on the 27th of January 1832. His father was the Rev. Edward Poole, a well-known bibliophile. His mother, Sopha, authoress of *The Englishwoman in Egypt* (1844), was the sister of E. W. Lane, the Arabic scholar, with whom R. S. Poole lived in Cairo from 1842 to 1849, thus imbibing an early taste for Egyptian antiquities. In 1852 he became an assistant in the British Museum, and was assigned to the department of coins and medals, of which in 1870 he became keeper. In that capacity he did work of the highest value, alike as a writer, teacher and administrator. In 1882 he was largely responsible for founding the Egypt Exploration Fund, and in 1884 for starting the Society of English Medallists. He retired in 1893, and died on the 8th of February 1895. Some of Poole's best work was done in his articles for the *Ency. Brit.* (9th ed.) on Egypt, Hieroglyphics

and Numismatics, and considerable portions have been retained in the present edition, even though later research has been active in his sphere of work; he also wrote for Smith's *Dictionary of the Bible*, and published several volumes dealing with his special subjects. He was for some time professor of archaeology at University College, London, and also lecturer at the Royal Academy.

His elder brother, EDWARD STANLEY POOLE (1830-1867), who was chief clerk in the science and art department at South Kensington, was an Arabic scholar, whose early death cut short a promising career. His two sons, Stanley Lane-Poole (b. 1854), professor of Arabic in Trinity College, Dublin, and Reginald Lane-Poole (b. 1857), keeper of the archives at Oxford, lecturer in diplomatic, and author of various historical works, carried on the family tradition of scholarship.

POOLE, a municipal borough, county in itself, market town and seaport in the eastern parliamentary division of Dorsetshire, England, 113½ m. S.W. by W. from London by the London & South-Western railway. Pop. (1901), 19,463. It is picturesquely situated on a peninsula between Holes Bay and the shallow irregular inlet of Poole Harbour. There are several modern churches, a guildhall, public library and school of art. Poole Harbour, extending inland 6 m., with a general breadth of 4 m., has a very narrow entrance, and is studded with low islands, on the largest of which, Brownsea or Branksea, is a castle, transformed into a residence, erected as a defence of the harbour in Tudor times, and strengthened by Charles I. Potters' clay is worked here. At low water the harbour is entirely emptied except a narrow channel, when there is a depth of 8½ ft. There are some valuable oyster beds. There is a considerable general coasting trade, and clay is exported to the Staffordshire potteries. Some shipbuilding is carried on, and there are manufacturers of cordage, netting and sail-cloth. The town also possesses potteries, decorative tileworks, iron foundries, agricultural implement works and flour-mills. Poole Park, containing 40 acres of land and 62 acres of water, was acquired in 1887 and 1889, and Branksome Park, of 40 acres, in 1895. The borough is under a mayor, 6 aldermen and 18 councillors. Area, 5333 acres.

Although the neighbourhood abounds in British earth-works and barrows, and there are traces of a Roman road leading from Poole to Wimborne, Poole (La Pole) is not mentioned by the early chroniclers or in Domesday Book. The manor, part of that of Canford, belonged in 1086 to Edward of Salisbury, and passed by marriage to William Longespée, earl of Salisbury, thence to Edmund de Lacy, earl of Lincoln, and with his heiress to Thomas, earl of Lancaster, and so to the Crown. Poole is first mentioned in a writ of 1224, addressed to the bailiffs and good men of La Pole, ordering them to retain all ships within their port. Entries in the Patent Rolls show that Poole had considerable trade before William de Longespée, earl of Salisbury, granted the burgesses a charter about 1248 assuring to them all liberties and free customs within his borough. The bailiff was to be chosen by the lord from six men elected by the burgesses, and was to hold pleas for breach of measures and assizes. It is uncertain when the burgesses obtained their town at the fee-farm rent of £8, 13s. 4d. mentioned in 1312. The mayor, bailiffs and good men are first mentioned in 1311 and were required to provide two ships for service against Robert de Brus. In 1372 the burgesses obtained assize of bread and ale, and right to hold the courts of the lord of the manor, the prepositus being styled his mayor. The burgesses were licensed in 1433 to fortify the town; this was renewed in 1462, when the mayor was given cognisance of the staple. Elizabeth incorporated Poole in 1569 and made it a separate county; Charles II. gave a charter in 1667. The corporation was suspended after a writ of *quo warranto* in 1686, the town being governed by the commission of the peace until the charters were renewed in 1688. Poole returned two members to parliament in 1362 and 1368, and regularly from 1452 to 1867, when the representation was reduced, ceasing in 1885. It is uncertain when the Thursday market was granted, but the

present fairs on the Feasts of SS Philip and James and All Saints were granted in 1453. Poole, as the headquarters of the Parliamentary forces in Dorset during the Civil War, escaped the siege that crippled so many of its neighbours. When Charles II. visited the town in 1665 a large trade was carried on in stockings, though the prosperity of Poole still depended on its usefulness as a port.

POONA, or PUNA, a city and district of British India, in the Central division of Bombay. The city is at the confluence of the Mutha and Mula rivers, 1850 ft. above sea-level and 119 m. S.E. from Bombay on the Great Indian Peninsula railway. Municipal area, about 4 sq. m.; pop. (1901), 153,320. It is pleasantly situated amid extensive gardens, with a large number of modern public buildings, and also many temples and palaces dating from the 16th to the 19th century. The palace of the peshwas is a ruin, having been destroyed by fire in 1827. From its healthy situation Poona has been chosen not only as the headquarters of the 6th division of the Southern army, but also as the residence of the governor of Bombay during the rainy season, from June to September. The native town, along the river bank, is somewhat poorly built. The European quarter, including the cantonment, extends north-west towards Kirkee. The waterworks were constructed mainly by the munificence of Sir Jamssetjee Jeejeebhoy. Poona was never a great centre of trade or manufacture though still noted for brass-work, jewelry and other articles of luxury. Cotton-mills, paper-mills, a brewery (at Dapuri), flour-mills, factories of ice and mineral waters, and dairy farms furnish the chief industries. Educational institutions are numerous. They include the government Deccan College, with a law class; the aided Ferguson college; the government colleges of science and agriculture; high schools; training schools for masters and mistresses; medical school; and municipal technical school. The recent history of Poona has been painfully associated with the plague. During 1897, when the city was first attacked, the death-rate rose to 93 per 1000 in Poona city, 71 per 1000 in the cantonment, and 93 per 1000 in Kirkee.

The DISTRICT OF POONA has an area of 5349 sq. m. Population (1901), 995,330, showing an increase of 18% after the disastrous famine of 1876-1877, but a decrease of 7% in the last decade. Towards the west the country is undulating, and numerous spurs from the Western Ghats enter the district; to the east it opens out into plains. It is watered by many streams which, rising in the ghats, flow eastwards until they join the Bhima, a river which intersects the district from north to south. The principal crops are millets, pulses, oil-seeds, wheat, rice, sugarcane, vegetables and fruit (including grapes). The two most important irrigation works in the Deccan are the Mutha canal, with which the Poona waterworks are connected, and the Nira canal. There are manufactures of cotton, silk and blankets. The district is traversed by the Great Indian Peninsula railway, and also by the Southern Mahratta line, which starts from Poona city towards Satara. It is liable to drought, from which it suffered severely in 1866-1867, 1876-1877, and again in 1896-1897.

In the 17th century the district formed part of the Mahomedan kingdom of Ahmadnagar. Sivaji was born within its boundaries at Junnar in 1627, and he was brought up at Poona town as the headquarters of the hereditary fief of his father. The district thus was the early centre of the Mahratta power; and when Satara became first the capital and later the prison of the descendants of Sivaji, Poona continued to be the seat of government under their hereditary ministers, with the title of peshwa. Many stirring scenes in Mahratta history were enacted here. Holkar defeated the last peshwa under its walls, and his flight to Bassein led to the treaty by which he put himself under British protection. He was reinstated in 1802, but, unable to maintain friendly relations, he attacked the British at Kirkee in 1817, and his kingdom passed from him.

POOP (Lat. *puppis*, stern), the stern or after-part of a ship; in the 16th and 17th centuries a lofty and castellated deck. The verb "to poop" is used of a wave breaking over the stern of a vessel.

POORE (or **POOR**), **RICHARD** (d. 1237), English bishop, was a son of Richard of Ilchester, bishop of Winchester. About 1197 he was chosen dean of Sarum and, after being an unsuccessful candidate for the bishoprics of Winchester and of Durham, he became bishop of Chichester in 1214. In 1217 he was translated to Salisbury, where he succeeded his elder brother, Herbert Poore, and in 1228 to Durham. He died at Tarrant Monkton, Dorset, said by some to be his birthplace, on the 15th of April 1237. Poore took some part in public affairs, under Henry III., but the great work of his life was done at Salisbury. Having in 1219 removed his see from Old to New Sarum, or Salisbury, he began the building of the magnificent cathedral there; he laid the foundation stone in April 1220, and during his episcopate he found money and forwarded the work in other ways. For the city the bishop secured a charter from Henry III. and he was responsible for the plan on which it was built, a plan which to some extent it still retains. He had something to do with drawing up some statutes for his cathedral; he is said to be responsible for the final form of the "use of Sarum," and he was probably the author of the *Ancien Rule*, a valuable "picture of contemporary life, manners and feeling" written in Middle English. His supposed identity with the jurist, Ricardus Anglicus, is more doubtful.

POOR LAW. The phrase "poor law" in English usage denotes the legislation embodying the measures taken by the state for the relief of paupers and its administration. The history of the subject and its problems generally are dealt with in the article **CHARITY AND CHARITIES**, and other information will be found in **UNEMPLOYMENT** and **VAGRANCY**. This article will deal only with the practice in the United Kingdom as adopted after the reform of the poor law in 1834 and amended by subsequent acts. This reform was brought about mainly by the rapid increase of the poor rate at the beginning of the 19th century, showing that a change was necessary either in the poor law as it then existed or in the mode of its administration.

A commission was appointed in 1832 "to make diligent and full inquiry into the practical operation of the laws for the relief of the poor in England and Wales, and into the manner in which those laws were administered, and to report their opinion as to what beneficial alterations could be made." The commissioners reported "fully on the great abuse of the legislative provision for the poor as directed to be employed by the statute of Elizabeth," finding "that the great source of abuse was the outdoor relief afforded to the able-bodied on their own account or on that of their families, given either in kind or in money." They also reported that "great maladministration existed in the workhouses." To remedy the evils they proposed considerable alterations in the law, and the principal portion of their suggestions was embodied in the Poor Law Amendment Act 1834. By virtue of this act three commissioners were appointed (originally for five years, but subsequently continued from time to time), styled "the poor law commissioners for England and Wales," sitting as a board, and appointing assistant commissioners and other officers. The administration of relief according to the existing laws was subject to their direction and control, and to their orders and regulations for the government of workhouses and the guidance and control of guardians and vestries and the keeping and allowing of accounts and contracts, without interfering with ordinary relief in individual cases. The whole of England and Wales was divided into twenty-one districts, to each of which an assistant commissioner was appointed. The commissioners under their powers formed poor law unions by uniting parishes for general administration, and building workhouses, guardians elected by the ratepayers (or *ex officio*) having the general government and administration of relief. The expense was apportioned to each parish on settled principles and rules, with power, however, to treat the united parishes as one for certain purposes. Outdoor relief might be given, on the order of two justices, to poor persons wholly unable to work from old age or infirmity.

The obstacles which the act had to contend with in London

chiefly arose from the confusion and perplexity of jurisdiction which existed in the one hundred and seventy parishes comprised within the city of London and the metropolitan district, some of these containing governing bodies of their own; in some the parish business was professedly managed by open vestries, in others by select vestries, and in addition to these there were elective vestries, while the majority of the large parishes were managed under local acts by boards of directors, governors and trustees. These governing bodies executed a great variety of functions besides regulating the management of the poor. The power, patronage and the indirect advantages which arose from the administration of the local funds were so great that much opposition took place when it was proposed to interfere by constituting a board to be annually chosen and freely elected by the ratepayers, on which the duty of regulating the expenditure for the relief of the poor was to depend. The general management of the poor was, however, on a somewhat better footing in London than in the country.

The act of 1834 was rather to restore the scope and intention of the statute of Elizabeth by placing its administration in the hands of responsible persons chosen by the ratepayers, and themselves controlled by the orders of a central body, than to create a new system of poor laws. The agents and instruments by which the administration of relief is afforded are the following. The description applies to the year 1910, but, as noticed below, the question of further reform was already to the fore, and the precise direction in which changes should go was a highly controversial matter.

The guardians of the poor regulate the cases and description of relief within the union; a certain number of guardians are elected from time to time by the ratepayers. The number was formerly determined by the central *Guardians* board,¹ by whom full directions as to the mode of election were given. In addition to those elected there were *ex officio* guardians, principally local magistrates. However, both these and nominated guardians were done away with by the Local Government Act 1894. The plural vote (which gave to the votes of the larger ratepayers a higher value) was also abolished; and in place of the old property qualification for the office of guardian a ratepaying or residential qualification was substituted. In urban districts the act in other respects left the board of guardians untouched, but in rural districts it inaugurated a policy of consolidating local authorities. In the rural districts the district council is practically amalgamated with the guardians, for, though each body retains a separate corporate existence, the district councillors are the guardians, and guardians as such are no longer elected. These electoral changes, extremely democratic in their character, brought about no marked general change in poor law administration. Here and there abrupt changes of policy were made, but the difficulty of bringing general principles to bear on the administration of the law remained much as before.

The guardians hold their meetings frequently, according to the exigencies of the union. Individual cases are brought to their notice—most cases of resident poor by the relieving officer of the union; the case of casual paupers by him or by the workhouse officers by whom they were admitted in the first instance. The resident poor frequently appear in person before the guardians. The mode of voting which the guardians follow in respect to any matter they differ on is minutely regulated, and all their proceedings, as well as those of their officers, are entered in prescribed books and forms. They have a clerk, generally a local solicitor of experience, who has a variety of responsible duties in advising, conducting correspondence and keeping books of

¹ After an intermediate transfer in 1847 of the powers of the poor law commissioners, and the constitution of a fresh board styled "commissioners for administering the laws for relief of the poor in England," it was found expedient to concentrate in one department of the government the supervision of the laws relating to the public health, the relief of the poor and local government; and this concentration was in 1871 carried out by the establishment (by Act of Parliament 34 & 35 Vict. c. 70) of the local government board.

accounts, and carrying out the directions of the guardians, who in their turn are subject to the general or special regulations of the local government board.

It may be mentioned here that the chief difficulty in understanding the English poor law arises from the fact that there are three authorities, each of them able to alter its administration fundamentally. The poor law is not only the creation of statutes passed by parliament; it is also controlled by the subordinate jurisdiction of the local government board, which in virtue of various acts has the power to issue orders. In a single year the local government board may issue nearly two thousand orders, over a thousand of them having special reference to the poor law. It is not possible therefore even to summarize the mass of subordinate legislation. A third source of authority is the local board of guardians, which, within the discretion allowed to it by statutes and orders, can so variously administer the law that it is difficult to understand how procedure so fundamentally different can be based on one and the same law. This elasticity, admirable or mischievous, as we choose to regard it, is the most characteristic feature of the English poor law system. The various officers of the union, from the medical officers to workhouse porters, including masters and matrons of workhouses, are generally appointed by the guardians, and the areas, duties and salaries of all the paid officers may be prescribed by the local government board.

Among a multitude of miscellaneous duties and powers of the guardians, apart from the ordinary duties of ordering or refusing relief in individual cases and superintending the officers of the union, the duties devolve on them of considering the adjustment of contributions to the common fund whether of divided or added parishes, and matters affecting other unions, the building of workhouses and raising of money for that and other purposes, the taking of land on lease, the hiring of buildings, special provisions as to superannuation and allowances to officers, the maintenance and orders as to lunatics apart from individual instances, and the consideration of questions of settlement and removal. A paramount obligation rests on the guardians to attend to the actual visitation of workhouses, schools and other institutions and places in which the poor are interested, and to call attention to and report on any irregularity or neglect of duty. Guardians may charge the rates with the expenses of attending conferences for the discussion of matters connected with their duties (Poor Law Conferences Act 1883). In relation to expenditure the guardians have very considerable but restricted powers. Their accounts are audited by district auditors appointed by the local government board.

Overseers of the poor are still appointed under the statute of Elizabeth, and the guardians cannot interfere with the appointment. As, however, the relief of the poor is administered by boards of guardians, the principal duties of overseers relate to the making and collection of rates and payments. The guardians, by order of the local government board, may appoint assistant overseers and collectors.

The conditions of persons entitled to relief are indicated by the terms of the statute of Elizabeth. If they fall within the definitions there given they have right to relief.

Conditions of Relief.

A fundamental principle with respect to legal relief of the poor is that the condition of the pauper ought to be, on the whole, less eligible than that of the independent labourer. The pauper has no just ground for complaint, if, while his physical wants are adequately provided for, his condition is less eligible than that of the poorest class of those who contribute to his support. If a state of destitution exists, the failure of third persons to perform their duty, as a husband, or relative mentioned in the statute of Elizabeth, neglecting those he is under a legal obligation to support, is no answer to the application. The relief should be afforded, and is often a condition precedent to the right of parish officers to take proceedings against the relatives or to apply to other poor unions. The duty to give immediate relief must, however, vary with the circumstances. The case of wanderers under circumstances not admitting of delay may be different from

that of persons resident on the spot where inquiry as to all the circumstances is practicable. The statute of Elizabeth contemplated that the relief was to be afforded to the poor resident in the parish, but it is contrary to the spirit of the law that any person shall be permitted to perish from starvation or want of medical assistance. Whoever is by sudden emergency or urgent distress deprived of the ordinary means of subsistence has a right to apply for immediate relief where he may happen to be. Persons comprehended within this class are called "casual poor," although the term "casuals" is generally used in reference to vagrants who take refuge for a short time in the "casual wards" of workhouses. Various tests are applied to ascertain whether applicants are really destitute. Labour tests are applied to the able-bodied, and workhouse tests are applied to those to whom entering a workhouse is made a condition of relief.

As to the nature and kind of relief given under the poor laws the great distinction restored rather than introduced by the amendment of the poor law system in 1834 was *Nature and Kind of Relief*, giving all relief to able-bodied persons of their families in well-regulated workhouses (that is to say, places where they may be set to work according to the spirit and intention of the statute of Elizabeth), and confining outdoor relief to the impotent—that is, all except the able-bodied and their families. Although workhouses formed a conspicuous feature in legislation for the poor from an early period, the erection of those buildings for unions throughout the country where not already provided followed immediately on the amendment of the system in 1834. Since that time there has been a constant struggle between the pauper class and the administrators of the law, the former naturally wishing to be relieved at their own homes, and in many instances choosing rather to go without aid than to remove within the walls of the workhouse. Relief given in a workhouse is termed "in (or indoor) maintenance" relief, and when given at the homes of the paupers is termed "outdoor relief."

Admission to a workhouse may be by a written order of the board of guardians, or by the master or matron (or in their absence by the porter) without an order in any case of sudden or urgent necessity, or provisionally by a relieving officer, or overseer or churchwarden. Any person who is brought by a policeman as having been found wandering in a state of destitution may be admitted. It is to be observed generally, with respect to all persons who may apply for admission into the workhouse under circumstances of urgent necessity, that their destitution, coupled with the fact of being within the union or parish, entitles them to relief, altogether independently of their settlement, if they have one, which is a matter for subsequent inquiry.

The regulations for the government of workhouses fall under two classes: (1) those which are necessary for the maintenance of good order in any building in which considerable numbers of persons of both sexes and of different ages reside; (2) those which are necessary in order that these establishments may not be almshouses, but workhouses in the proper meaning of the term.

The inmates of a workhouse are necessarily separated into certain classes. In no well-managed institution of this sort, in any country, are males and females, the old and the young, the healthy and the sick, indiscriminately mixed together. Guardians are required to divide the paupers into certain classes, and to subdivide any one or more of these classes in any manner which may be advisable, and which the internal arrangements of the workhouse admit; and the guardians are required from time to time, after consulting the medical officer, to make necessary arrangements with regard to persons labouring under any disease of body or mind, and, so far as circumstances permit, to subdivide any of the enumerated classes with reference to the moral character or behaviour or the previous habits of the inmates, or to such other grounds as may seem expedient.

The separation of married couples was long a vexed question, the evils on the one hand arising from the former unrestricted practice being very great, while on the other hand the separation of old couples was felt as a great hardship, and by express statutory provision in 1847 husband and wife, both being above the age of sixty, received into a workhouse cannot be compelled to live separate and apart from each other (10 & 11 Vict. c. 109, § 23). This exemption was carried somewhat further by contemporaneous orders of the board, under which guardians were not compelled to separate infirm couples, provided they had a sleeping apartment separate from that of other paupers; and in 1876 guardians were empowered, at their discretion, to permit husband and wife where either of them is

infirm, sick or disabled by any injury, or above sixty years of age to live together, but every such case must be reported to the local government board (39 & 40 Vict. c. 61, § 10).

The classification of children apart from adult paupers is peremptory. Even in those unions where what is called a workhouse school is maintained the children are kept in detached parts of the building, and do not associate with the adult paupers. The separate school is built on a separate and often distant site. Sometimes the separate school is one building, sometimes detached "blocks," and sometimes a group of cottage homes. There still remain ten district schools. In some places an experiment which is called the scattered homes system has been adopted. This consists in lodging-homes for the children placed in different parts of the town, from which the children attend the local public elementary schools. In the rural districts and in less populous unions the children generally attend the local public elementary school. To these expedients boarding-out must be added. The above refers of course only to those children who as inmates are under the charge of the guardians. Outdoor paupers are responsible for the education of their children, but guardians cannot legally continue outdoor relief if the children are not sent regularly to school.

The tendency too has been to improve administrative methods with reference to children.

Two important orders on the subject of the boarding-out of poor-law children were issued in 1889. By the Boarding of Children in Unions Order, orphan and deserted children can be boarded out with suitable foster-parents in the union by all boards of guardians except those in the metropolis. This can be done either through a voluntary committee or directly. By the Boarding Out Order, orphan and deserted children may be boarded out by all boards of guardians without the limits of their own unions, but in all cases this must be done through the offices of properly constituted local boarding-out committees. The sum payable to the foster-parents is not to exceed 4s. per week for each child. The local committee require to be approved by the Local Government Board.

The question of the education of poor law children was much discussed in later years. During the early years of the central authority, it was the object of the commissioners to induce boards of guardians to unite in districts for educational purposes. This was advocated on grounds of efficiency and economy. It was very unpopular with the local authorities, and the number of such districts has never exceeded a dozen. In London, where this aggregation was certainly less desirable than in rural unions, several districts were formed and large district schools were built. Adverse criticism, by Mrs Nassau Senior in 1874, and by a department committee appointed twenty years later, was directed against these large, or, as they are invidiously called, barrack schools. The justice of this condemnation has been disputed, but it seems probable that some of these schools had grown too large. Many of these have been dissolved by order of the local government board on the application of the unions concerned. This condemnation of some schools has in certain quarters been extended to all schools, and is construed by others as an unqualified recommendation of boarding out, a method of bringing up poor law children obviously requiring even more careful supervision than is needed in the publicity of a school.

Other acts to be noted are the Poor Law Act 1889 and the Custody of Children Act 1891, § 3. The evil of allowing children who have been reputably brought up in poor law schools to relapse into vicious habits on return to the custody of unworthy parents has been the subject of frequent remark. By the act of 1889, guardians are authorized to detain children who are under their charge, as having been deserted by their parents, up to the age of 16 if boys and of 18 if girls. By the Poor Law Act 1899 the principle is extended to orphans and the children of bad parents chargeable to the rates. The act of 1891 goes further, and enacts that where a parent has (a) abandoned or deserted his child, or (b) allowed his child to be brought up by another person at that person's expense, or by the guardians of a poor law union for such a length of time and in such circumstances as to satisfy the court that the parent was unmindful of his parental duties, the court shall not make an order for the delivery of the child to the parent unless the parent has satisfied the court that, having regard to the welfare of the child, he is a fit person to have the custody of the child.

Casual and poor wayfarers admitted by the master and matron are kept in a separate ward and dieted and set to work in such manner as the guardians by resolution direct; and whenever any vagrants or mendicants are received into a workhouse they are usually (as a precaution necessary for preventing the introduction of infectious or contagious diseases) kept entirely separate from the other inmates, unless their stay exceeds a single night.

For the guidance of guardians an important circular was issued from the local government board on the 15th of March 1886. It stated that while "the board have no doubt that the powers which the guardians possess are fully sufficient to enable them to deal with ordinary pauperism, and to meet the demand for relief from the classes who usually seek it," yet "these provisions do not in all cases meet the emergency. What is required to relieve artisans and others who have hitherto avoided poor law assistance, and who

are temporarily deprived of employment, is—(1) Work which will not involve the stigma of pauperism; (2) work which all can perform, whatever may have been their previous occupations; (3) work which does not compete with that of other labourers at present in employment; and lastly, work which is not likely to interfere with the resumption of regular employment in their own trades by those who seek it."

The circular went on to recommend that guardians should confer with the local authorities, "and endeavour to arrange with the latter for the execution of works on which unskilled labour may be immediately employed." The conditions of such work were (1) the men to be employed must be recommended by the guardians; (2) the wages must be less than the wages ordinarily paid for such work.

The circular was widely distributed. Many boards that were inclined in that direction regarded it as an encouragement to open or to promote the opening of relief works. Others, again, looked closely at the conditions, and declared roundly that it was impossible to fulfil them. A poor law authority, they said, cannot give relief which will not subject the recipients to the legal (if any) and economic disabilities attaching to the receipt of poor law relief. Work which all can perform can only be found in the shape of task-work under adequate supervision. If the work is of a useful and necessary character, it must compete with the labour of others belonging to the trades affected. If the relief works are opened by authorities other than the poor law guardians, the conditions that the men were only to be employed when recommended by the guardians, and then paid less than the current rate of wages, were calculated, it was urged, to secure bad work, discontent, and all the "stigma of pauperism." The ambiguity of the circular indeed was such, that both action and inaction seem amply justified by it.

In the administration of medical relief to the sick, the objects kept in view are: (1) to provide medical aid for persons who are really destitute, and (2) to prevent medical relief from generating or encouraging pauperism, and with this **Medical Relief.** view to withdraw from the labouring classes, as well as from the administrators of relief and the medical officers, all motives for applying for or administering medical relief, unless where the circumstances render it absolutely necessary.

Unions are formed into medical districts limited in area and population, to which a paid medical officer is appointed, who is furnished with a list of all such aged and infirm persons and persons permanently sick or disabled as are actually receiving relief and residing within the medical officer's district. Every person named in the list receives a ticket, and on exhibiting it to the medical officer is entitled to advice, attendance and medicine as his case may require. Medical outdoor relief in connexion with dispensaries is regulated in asylum districts of the metropolis by the Metropolitan Poor Act 1867 (30 & 31 Vict. c. 6). In connexion with medical relief must be noted the Medical Relief Disqualification Removal Act 1885. This act relieved voters from disqualification which would otherwise attach in consequence of the receipt by them or their families of medical or surgical assistance, or of medicine, at the expense of the poor rate. This does not apply to guardian elections, and it does not include persons who, in addition to medical relief, receive nourishment or other relief from the poor rate. The provisions which require the removal of the names of paupers from the electoral roll are, it is understood, very perfunctorily carried out. The Outdoor Relief Friendly Societies Act 1894 authorized guardians, in calculating the proper allowance to be made, to disregard an income derived from a friendly society, and to give relief as if the applicant in receipt of such an allowance was wholly destitute. This act is a curious illustration of the English poor law system. In earlier years, notably in what is known as Paget's letter (22nd Rep. Poor Law Board, p. 108), the central board, had, in answer to inquiry, pointed out that such preferential treatment given to men receiving benefit, insufficient to maintain them, from a friendly society, could not in equity be withheld from persons in receipt of an adequate benefit, or from those whose savings took the form of a deposit in a bank, of a share in a co-operative society, or of cottage property; and further, that an engagement on the part of guardians to supplement insufficient allowance from a friendly society was a bounty on inadequate and insolvent friendly society finance. The central board went so far as to say that relief given in such disregard of the pauper's income was illegal. They had, however, issued no peremptory order on the subject, nor had guardians been surcharged for neglect of the rule. The local authorities followed their own discretion, and a very general practice was to reckon friendly society allowances at half their value. The above act set aside the central board's earlier interpretation of the law. It made, however, no attempt to enforce its procedure on the numerous boards of guardians who regard the course thereby authorized as contrary to public policy.

A lunatic asylum is required to be provided by a county or borough for the reception of pauper lunatics, with a committee of visitors who, among other duties, fix a weekly sum to be charged for the lodging, maintenance, medicine and **Lunatics.** clothing of each pauper lunatic confined in such asylum. Several acts were passed. The Lunacy Act 1890 consolidated the acts affecting lunatics. It was further amended by the Lunacy Act 1891.

An explanatory letter issued by the local government board will be found in the 20th Annual Report, p. 23. The tendency of this and of all recent legislation for an afflicted class has been to increase the care and the safeguards for their proper treatment.

A settlement is the right acquired in any one of the modes pointed out by the poor laws to become a recipient of the benefit of those laws in that parish or place where the right has been last acquired.

No relief is given from the poor rates of a parish to any person who does not reside within the union, except where such person being casually within a parish becomes destitute by sudden distress, or where such person is entitled to receive relief from any parish where non-resident under justice's order (applicable to persons under orders of removal and to non-resident lunatics), and except to widows and legitimate children where the widow was resident with her husband at the time of his death out of the union in which she was not settled, or where a child under sixteen is maintained in a workhouse or establishment for the education of pauper children not situate in the union, and in some other exceptional cases.

Immediately before the passing of the Poor Law Amendment Act 1834 settlements were acquired by birth, hiring and service, apprenticeship, renting a tenement, estate, office or payment of rates. In addition to these an acknowledgment (by certificate), by relief or acts of acquiescence has practically the effect of a settlement, for, if unexplained, such an acknowledgment stops the parish from disputing a settlement in the parish acknowledging. The Poor Law Amendment Act 1834 abolished settlement by hiring and service (or by residence under it) and by serving an office, and by apprenticeship in the sea service. Moreover the guardians of a union might agree (subject to the approval of the commissioners) that all the parishes forming it should for the purposes of settlement be considered as one parish.

It is to be observed that, for the purposes of relief, settlement and removal and burial, the workhouse of any parish is considered as situated in the parish to which each poor person is chargeable.

There may be a settlement by parentage, for legitimate children take the settlement of their father, or if he has no settlement they are entitled to the settlement of their mother; and it is only when both these sources fail discovery that their right of settlement by birth accrues; for until the settlement of the father or mother has been ascertained the settlement of a legitimate child, like that of a bastard, is in the place where the birth took place.

A settlement attaches to those persons who have a settlement of some kind. Foreigners born out of the country and not acquiring any in one of the modes pointed out must be provided for, if requiring relief, where they happen to be.

As the burden of maintaining the poor is thrown on the parish of settlement, when the necessity for immediate relief arises in another parish, the important question arises whether the pauper can be removed; for, although the parish where the pauper happens to be must afford immediate relief without waiting for removal, the parish of settlement cannot in general be charged with the cost unless the pauper is capable of being removed. The question of removability is distinct from settlement. A pauper often acquires a status or irremovability without gaining a settlement.

Irremovability is a principle of great public importance quite irrespective of the incident of cost as between one parish or another. Before the introduction of a status of irremovability removal might take place (subject to powers of suspension in case of sickness and otherwise) after any interval during which no legal settlement was obtained; mere length of residence without concurrent circumstances involving the acquisition of a settlement on obtaining relief gave no right to a person to remain in the parish where he resided.

In 1846 it was enacted that no person should be removed nor any warrant granted for the removal of any person from any parish in which such persons had resided for five years (9 & 10 Vict. c. 66). In 1861 three years was substituted for five (24 & 25 Vict. c. 55); and only four years later one year was substituted for three (28 & 29 Vict. c. 79). Apart from these reductions of time in giving the status of irremovability, actual removals to the parish of settlement were narrowed by provisions giving to residence in any part of a union the same effect as a residence in any parish of that union (24 & 25 Vict. c. 55). On the other hand the time during which parish relief is received, or during which the person is in any poorhouse or hospital or in a prison, is excluded from the computation of time (9 & 10 Vict. c. 66).

The removability as well as the settlement of the family, *i.e.* of the wife and unemancipated children, are practically subject to one and the same general rule. Wherever any person has a wife or children having another settlement, they are removable where he is removable, and are not removable from any parish or place from which he is not removable (11 & 12 Vict. c. 211).

It is to be borne in mind that no person exempted from liability to be removed acquires, by reason of such exemption, any settlement in any parish; but a residence for three years gives a qualified settlement (39 & 40 Vict. c. 61).

The cost of relief of paupers rendered irremovable is borne by the common fund of the union (11 & 12 Vict. c. 110. § 3) as union expenses (§ 6), and any question arising in the union with reference to the

charging relief may be referred to and decided by the local government board (§ 4).

The poor rate is the fund from which the cost of relief is principally derived. The statute of Elizabeth (extended in some respects as to places by 13 & 14 Charles II. c. 12) embraced two classes of persons subject to taxation—occupiers of real property and inhabitants in respect of personal property, although the rateability under the latter head was reluctantly conceded by the courts of law, and was in practice only partially acted upon.

As regards occupiers of land and houses, the correct principles as to the persons liable to be rated were, after many erroneous views and decisions, established by the House of Lords in 1865 in the case of the Mersey docks. The only occupier exempt from the operation of the act of Elizabeth is the Crown, on the general principle that such liabilities are not imposed on the sovereign unless expressly mentioned, and that principle applies to the direct and immediate servants of the Crown, whose occupation is the occupation of the Crown itself. If there is a personal private beneficial occupation, so that the occupation is by the subject, that occupation is rateable. Thus for apartments in a royal palace, gratuitously assigned to a subject, who occupies them by permission of the sovereign but for the subject's benefit, the latter is rateable; on the other hand, where a lease of private property is taken in the name of a subject, but the occupation is by the sovereign or his subjects on his behalf, no rate can be imposed.

So far the ground of exemption is perfectly intelligible, but it has been carried a good deal further, and applied to many cases in which it can scarcely be said naturally, but only theoretically, that the sovereign or the servants of the sovereign are in occupation. A long series of cases have established that when property is occupied for the purposes of the government of the country, including under that head the police, and the administration of justice, no one is rateable in respect of such occupation. And this applies not only to property occupied for such purposes by the servants of the great departments of state and the post office, the Horse Guards, and the Admiralty, in all which cases the occupiers might strictly be called the servants of the Crown, but to county buildings occupied for the assizes and for the judge's lodgings, to stations for the local constabulary, to jails and to county courts where undertakings are carried out by or for the government and the government is in occupation; the same principles of exemption have been applied to property held by the office of works.

When the property is not *de facto* occupied by the Crown or for the Crown, it is rateable; and, although formerly the uses of property for public purposes, even where the Crown was not constructively interested in the way above pointed out, was treated as a ground for exemption, it is now settled that trustees who are in law the tenants and occupiers of valuable property in trust for public and even charitable purposes, such as hospitals or lunatic asylums, are in principle rateable notwithstanding that the buildings are actually occupied by paupers who are sick or insane, and that the notion that persons in the legal occupation of valuable property are not rateable if they occupy in a merely fiduciary character cannot be sustained.

With respect to the particular person to be rated where there is a rateable occupation, it is to be observed that the tenant, as distinguished from the landlord, is the person to be rated under the statute of Elizabeth; but occupiers of tenements let for short terms may deduct the poor rate paid by them from their rents, or the vestries may order such owners to be rated instead of the occupiers; such payments or deductions do not affect qualification and franchises depending on rating (Poor Rate Assessment and Collection Act 1869 and Amendment Act 1882).

To be rated the occupation must be such as to be of value, and in this sense the word beneficial occupation has been used in many cases. But it is not necessary that the occupation should be beneficial to the occupier; for, if that were necessary, trustees occupying for various purposes, having no beneficial occupation, would not be liable, and their general liability has been established as indicated in the examples just given.

As to the mode and amount of rating it is no exaggeration to say that the application of a landlord-and-tenant valuation in the terms already given in the Parochial Assessment Act, with the deductions there mentioned, has given rise to litigation on which millions of pounds have been spent with respect to the rating of railways alone, although the established principle applied to them, after much consideration, is to calculate the value of the land as increased by the line.

The Parochial Assessment Act referred to (6 & 7 Will. IV. c. 96), comprising various provisions as to the mode of assessing the rate so far as it authorized the making of a valuation, was repealed in 1869, in relation to the metropolis, and other provisions made for securing uniformity of the assessment of rateable property there (32 & 33 Vict. c. 67).

The mode in which a rate is made and recovered may be concisely stated thus. The guardians appoint an assessment committee of their body for the investigation and supervision of valuations, which are made out in the first instance by the overseers according to specific regulations and in a form showing among other headings the gross

estimated rental of all property and the names of occupiers and owners, and the rateable value after the deductions specified in the Assessment Act already mentioned, and as prescribed by the central board. This valuation list, made and signed by the overseers, is published, and all persons assessed or liable to be assessed, and other interested parties, may, including the officers of other parishes, inspect and take copies of and extracts from that list. A multitude of provisions exist in relation to the valuation and supplemental valuation lists. Objections on the ground of unfairness or incorrectness are dealt with by the committee, who hold meetings to hear and determine such objections. The valuation list, where approved by the committee, is delivered to the overseers, who proceed to make the rate in accordance with the valuation lists and in a prescribed form of rate book. The parish officers certify to the examination and comparison of the rate book with the assessments, and obtain the consent of justices as required by the statute of Elizabeth. This consent or allowance of the rate is merely a ministerial act, and if the rate is good on the face of it the justices cannot inquire into its validity.

The rate is then published and open to inspection. Appeals may be made to special or quarter sessions against the rate, subject to the restriction that, if the objection were such that it might have been dealt with on the valuation lists, no appeal to sessions is permitted unless the valuation list has been duly objected to and the objector had failed to obtain such relief in the matter as he deemed to be just.

In the metropolis a common basis of value for the purposes of government and local taxation is provided, including the promotion of uniformity in the assessment of rateable property. Provision is made for the appointment of an assessment committee by guardians or vestries, and for the preparation of valuation lists, and the deposit and distribution of valuation lists, and for the periodical revision of valuation lists.

Many endeavours have been made to readjust the burden of local expenditure. The system of making grants from the national taxes in aid of local rates has been extended. The principle of the metropolitan common poor fund, a device for giving metropolitan grants assessed on the whole of London in aid of the London local poor law authorities, has been followed, *mutatis mutandis*, in the relations between the national and the local exchequers. At the time of the repeal of the corn laws, Sir Robert Peel expressed an opinion that this fiscal change necessitated some readjustment of local rates. In that year, 1846, a beginning of grants from the national exchequer in aid of local expenditure was made. The salaries of poor-law teachers, medical officers and auditors were provided from the larger area of taxation, and in 1867 the salaries of public vaccinators were added to the list. In 1874 a grant of 4s. per head per week was made for each pauper lunatic passed by the guardians to the care of a lunatic asylum. By the Local Government Act 1888, supplemented by the Local Taxation (Customs and Excise) Act 1890, this principle was more widely extended. The various grants in aid were abolished, and in substitution the proceeds of certain specified taxes were set aside for local purposes. From this source, the gross amount of which of course varies, there are now distributed to local poor-law authorities some 4s. a week for lunatics in asylums, and allowances based on their average expenditure in previous years in salaries of officials and other specified charges. In London, in order not to conflict with the operation of the common poor fund, which had already spread these charges over a wide area, the grant takes the form of a sum equivalent to about 4d. per diem for each indoor pauper. The number on which this calculation is based is not, however, to be the actual number, but the average of the last five years previous to the passing of the act. By this legislation something like one-quarter of the total expenditure on poor law relief is obtained from national taxes as opposed to local rates. By the Agricultural Rates Act 1896 the occupier of agricultural land was excused one-half of certain rates, including the poor rate. The deficiency is supplied by a contribution from the national exchequer. Meanwhile, the spending authority continue to be elected by the local ratepayers. In this connexion two further anomalies deserve notice. By the Poor Rate Assessment and Collection Act 1869 owners who compound to pay the rates in respect of tenement property are entitled to certain deductions by way of commission. Such payments by the owner are constructively payments by the occupier, who thereby is to be deemed duly rated for any qualification or franchise. Under these arrangements a large number of electors do not contribute directly to the rate. A converse process is also going on, whereby the ownership of an important and increasing body of property is practically unrepresented. This is due to the great growth of property in the hands of railway companies, docks and limited liability companies generally. The railways alone are said to pay considerably over 13% of the local taxation of the country, and they have no local representation. There is, in fact, in local administration a divorce between representation and taxation to a greater extent than is generally supposed, and it is impossible not to connect the fact with the rapid growth of local expenditure and indebtedness.

Royal Commission of 1905-1909.—The main points of the system of English poor relief, as still in force in 1910, are as

outlined above. That it has been inadequate in dealing with the various problems of unemployment and pauperism, which the constantly changing conditions of the industrial world necessarily evolve had however been long acknowledged. Accordingly, in 1905 a royal commission was appointed to inquire into the working of the law relating to the relief of poor persons, and into the various means adopted outside of the poor laws for meeting distress arising from want of employment, particularly during the periods of severe industrial depression. The commission took voluminous evidence¹ and its report was issued in

¹ The appendix volumes to the Report of the Royal Commission number thirty-four. Their contents are as follows: vol. i. English Official Evidence, minutes of evidence mainly of the officers of the Local Government Board for England and Wales; vol. ii. London Evidence, minutes of evidence mainly of London witnesses; vol. iii. Associations and Critics, minutes of evidence mainly of critics of the Poor Law and of witnesses representing Poor Law and Charitable Associations; vol. iv. Urban Centres, minutes of evidence containing the oral and written evidence of the British Medical Association and of witnesses from the following provincial urban centres—Liverpool and Manchester districts, West Yorkshire, Midland Towns; vol. v. Minutes of Evidence containing the oral and written evidence of witnesses from urban centres in the following districts—South Wales and North Eastern Counties; vol. vi. Minutes of Evidence relating to Scotland; vol. vii. Minutes of Evidence containing the oral and written evidence of witnesses from various rural centres in the South Western, Western and Eastern Counties, from the parish of Poplar Borough and from the National Conference of Friendly Societies; vol. viii. Minutes of Evidence containing the oral and written evidence of witnesses relating chiefly to the subject of "unemployment"; vol. ix. Evidence of further witnesses on the subject of unemployment; vol. x. Minutes of Evidence relating to Ireland; vol. xi. Miscellaneous Papers. Communications from Boards of Guardians and others, &c., vol. xii. Reports, Memoranda and Tables prepared by certain of the Commissioners; vol. xiii. Diocesan Reports on the Methods of administering charitable assistance and the extent and intensity of poverty in England and Wales; vol. xiv. Report on the Methods and Results of the present system of administering indoor and outdoor poor law medical relief in certain unions in England and Wales, by Dr J. C. McVail; vol. xv. Report on the Administrative Relation of Charity and the Poor Law, and the extent and the actual and potential utility of Endowed and Voluntary Charities in England and Scotland, by A. C. Kay and H. V. Toynbee; vol. xvi. Reports on the Relation of Industrial and Sanitary Conditions to Pauperism, by Steel Maitland and Miss R. E. Squire; vol. xvii. Reports on the effect of Outdoor Relief on Wages and the Conditions of Employment, by Thomas Jones and Miss Williams; vol. xviii. Report on the Condition of the Children who are in receipt of the various forms of Poor Law Relief in certain Unions in London and in the Provinces, by Dr Ethel Williams and Miss Longman and Miss Phillips; vol. xix. Reports on the Effects of Employment or Assistance given to the Unemployed since 1886 as a means of relieving distress outside the Poor Law in London, and generally throughout England and Wales, and in Scotland and Ireland, by Cyril Jackson and Rev. J. C. Pringle; vol. xx. Report on Boy Labour in London and certain other typical towns, by Cyril Jackson, with a Memorandum from the General Post Office on the Conditions of Employment of Telegraph Messengers; vol. xxi. Reports on the Effect of the Refusal of Out-Relief on the Applicants for such Relief, by Miss G. Harlock; vol. xxii. Report on the Overlapping of the work of the Voluntary General Hospitals with that of Poor Law Medical Relief in certain districts of London, by Miss M. B. Roberts; vol. xxiii. Report on the Condition of the Children who are in receipt of the various forms of Poor Law Relief in certain parishes in Scotland, by Dr C. T. Parsons and Miss Longman and Miss Phillips; vol. xxiv. Report on a Comparison of the Physical Condition of "Ordinary" Paupers in certain Scottish Poorhouses with that of the Able-bodied Paupers in certain English Workhouses and Labour Yards, by Dr C. T. Parsons; vol. xxv. Statistical Memoranda and Tables relating to England and Wales, prepared by the Staff of the Commission and by Government Departments and others, and Actuarial Reports; vol. xxvi. Documents relating more especially to the administration of charities; vol. xxvii. Replies by Distress Committees in England and Wales to Questions circulated on the subject of the Unemployed Workmen Act 1905; vol. xxviii. Reports of Visits to Poor Law and Charitable Institutions and to Meetings of Local Authorities in the United Kingdom; vol. xxix. Report on the Methods of Administering Charitable Assistance and the extent and intensity of Poverty in Scotland, prepared by the Committee on Church Interests appointed by the General Assembly of the Church of Scotland; vol. xxx. Documents relating especially to Scotland; vol. xxxi. Statistical Memoranda and Tables relating to Ireland, &c.; vol. xxxii. Report on Visits paid by the Foreign Labour Colonies Committee of the Commission to certain Institutions in Holland, Belgium, Germany and Switzerland; vol. xxxiii. Foreign and Colonial Systems of Poor

1909. It consists of a majority report, signed by the chairman and 13 other members, and a minority report signed by 4 dissentient members. To this report and its appendices those who wish to obtain an exhaustive account of the working of the English poor law must necessarily have recourse.

The "majority" report opens with a statistical survey of poor law problems, gives an historical sketch of the poor laws down to 1834, and proceeds to deal in detail with the historical development and present condition of the various branches of the poor law under their appropriate headings: (a) the central authority; (b) the local authority; (c) the officers of the local authority; (d) areas of administration; (e) indoor relief; (f) outdoor relief; (g) the aged; (h) the children; (i) the able-bodied under the poor law and (j) the causes of pauperism. Other portions of the report deal with medical relief, distress due to unemployment, and charities and the relief of distress. In reviewing these various subjects the commission lay bare the main defects of the present system, which they briefly summarize as follows:—

- i. The inadequacy of existing poor law areas to meet the growing needs of administration.
- ii. The excessive size of many boards of guardians.
- iii. The absence of any general interest in poor law work and poor law elections, due in great part to the fact that poor law stands in no organic relation to the rest of local government.
- iv. The lack of intelligent uniformity in the application of principles and in general administration.
- v. The want of proper investigation and discrimination in dealing with applicants.
- vi. The tendency in many boards of guardians to give outdoor relief without plan or purpose.
- vii. The unsuitability of the general workhouse as a test or deterrent for the able-bodied; the aggregation in it of all classes without sufficient classification; and the absence of any system of friendly and restorative help.
- viii. The lack of co-operation between poor law and charity.
- ix. The tendency of candidates to make lavish promises of out-relief and of guardians to favour their constituents in its distribution.
- x. General failure to attract capable social workers and leading citizens.
- xi. The general rise in expenditure, not always accompanied by an increase of efficiency in administration.
- xii. The want of sufficient control and continuity of policy on the part of the central authority.

The commission stated that these defects have produced a want of confidence in the local administration of the poor law, and that they have been mainly the cause of the introduction of other forms of relief from public funds which are unaccompanied by such conditions as are imperatively necessary as safeguards.

The commission proceed to formulate a scheme of reform, the main features of which are summarized below:—

Public Assistance.—The commissioners state that the name "poor law" has gathered about it associations of harshness, and still more of hopelessness, which might seriously obstruct the reforms they recommend, and they suggest that the title "public assistance" better expresses the system of help outlined in their report. They propose the abolition of the existing boards of guardians, the separation of their duties into two categories, and the calling into existence of two bodies for the discharge of the two sets of functions, viz. a local authority, known as the public assistance authority, with an area coterminous with the area of the county or county borough, for central administration and control; and local committees in existing union area for dealing with applications, investigating and supervising cases and undertaking such other duties as may be delegated by the public assistance authority. They recommend that the public assistance authority should be a statutory committee of the County Council, with one-half of its members appointed by the council from persons who are members of the council, and the other half of its members appointed by the council from outside their number, and to consist of persons experienced in the local administration of public assistance or

Relief, with a memorandum on the Relief of Famines in India; vol. xxxiv. Alphabetical Lists of Oral and Non-oral Witnesses.

other cognate work, women to be eligible for appointment in either case.

Working in co-operation with the public assistance authorities are to be voluntary aid councils and committees (the former supervising, the latter executive) for aiding persons in distress whose cases do not appear to be suitable for treatment by the public assistance committee. The commission epitomize what they consider to be the main principles of a reformed poor law. They are (1) that the treatment of the poor who apply for public assistance should be adapted to the needs of the individual, and, if institutional, should be governed by classification; (2) that the public administration established for the assistance of the poor should work in co-operation with the local and private charities of the district; (3) that the system of public assistance thus established should include processes of help which would be preventive, curative, and restorative, and (4) that every effort should be made to foster the instincts of independence and self-maintenance amongst those assisted. They proceed to recommend:—

Indoor or "Institutional" Relief.—That general workhouses should be abolished. That indoor relief should be given in separate institutions appropriate to the following classes of applicants, viz. (a) children, (b) aged and infirm, (c) sick, (d) able-bodied men, (e) able-bodied women, (f) vagrants, and (g) feeble-minded and epileptics. Powers of removal to and detention in institutions should be given, with proper safeguards, to the public assistance authority. The treatment of inmates should be made as far as possible curative and restorative.

Outdoor Relief or "Home Assistance."—This should be given only after thorough inquiry, except in cases of sudden and urgent necessity; it should be adequate to meet the needs of those to whom it is given; persons so assisted should be subject to supervision; that such supervision should include in its purview the conditions, moral and sanitary, under which the recipient is living; that voluntary agencies should be utilized as far as possible for the personal care of individual cases, and that there should be one uniform order governing outdoor relief or home assistance.

Children.—Effective steps should be taken to secure that the maintenance of children in the workhouse be no longer recognized as a legitimate way of dealing with them. Boarding-out might and should be greatly extended. Power to adopt children of vicious parents should be more frequently exercised and accompanied by a strict dealing with the parent, and the public assistance authorities should retain supervision of adopted children up to the age of twenty-one. A local government board circular of June 1910 to boards of guardians embodied many of the recommendations of the commission. Some recommendations, of course, the guardians are not empowered, under existing legislation, to carry out.

The Aged.—As regards institutional relief, the aged should have accommodation and treatment apart from the able-bodied, and be housed on a separate site, and be further subdivided into classes as far as practicable with reference to their physical condition and their moral character. As regards outdoor relief, greater care should be taken to ensure adequacy of relief.

Medical Relief or Assistance.—A general system of provident dispensaries should be established, of which existing voluntary outdoor medical organizations should be invited to form an integral part, and every inducement should be offered to the working classes below a certain wage to become, or continue to be, members of a provident dispensary.

Unemployment.—The commission review the social and industrial developments since 1834, deal with the new problems, criticize the existing methods of relief, and on their summing up of the new factors and developments, arrive at the conclusions: (a) that there is an increasing aggregation of unskilled labour at the great ports and in certain populous districts; (b) that this aggregation of low-grade labour is so much in excess of the normal local wants as to promote and perpetuate under-employment, and (c) that this normal condition of under-employment, when aggravated by periodic contraction of trade or by inevitable changes in methods of production, assumes such dimensions as to require special machinery and organization for its relief and treatment. The commission proceed to make the following recommendations:—

Labour Exchanges.—A national system of labour exchanges should be established and worked by the board of trade for the general purpose of assisting the mobility of labour and of collecting accurate information as to unemployment. (These were established by the Labour Exchanges Act 1909; see UNEMPLOYMENT.)

Education and Training of the Young for Industrial Life.—The education in the public elementary schools should be much less literary and more practical, and better calculated than at present to adapt the child to its future occupation. Boys should be kept at school until the age of fifteen; exemption below fifteen should be granted only for boys leaving to learn a skilled trade, and there should be school supervision till sixteen and replacing in school if not properly employed.

Regularization of Employment.—Government departments and local and public authorities should be enjoined to regularize their work as far as possible, and to endeavour, as far as possible, to undertake their irregular work when the general demand for labour is slack.

Unemployment Insurance.—The establishment and promotion of unemployment insurance, especially amongst unskilled and unorganized labour, is of paramount importance in averting distress arising from unemployment, and is of such national importance as to justify, under specified conditions, contributions from public funds towards its furtherance. The commission further state that this insurance can best be promoted by utilizing the agency of existing trade organizations, or of organizations of a similar character. They are of opinion that no scheme of unemployment insurance, either foreign or British, which has been brought before them, is so free from objections as to justify them in recommending it for general adoption.

Labour Colonies.—The commission recommend their establishment and use. (For these see VAGRANCY.)

Four out of the seventeen members of the commission, being unable to agree with their colleagues, issued a separate report, which is very nearly as voluminous as that of the majority. Their recommendations were more drastic than those of the majority, and had for their aim not a reform of the poor law as it exists, but its entire break-up. The minority agree with the majority in recommending the abolition of workhouses, but instead of setting up new authorities, they consider that the duties of the guardians should be transferred to the county authorities, with an appropriate distribution among four existing committees of the county council. They recommend that the education committee become responsible for the entire care of children of school age. That the health committee should care for the sick and permanently incapacitated, infants under school age, and the aged requiring institutional care. The asylums committee should have charge of the mentally defective and the pension committee of the aged to whom pensions are awarded.

The minority consider there should be some systematic co-ordination, within each local area, of all forms of public assistance and, if possible, of all assistance dispensed by voluntary agencies, and they recommend the appointment, by the county or county borough council, of one or more responsible officers, called "registrars of public assistance." Their duties would be to keep a register of all persons receiving any form of public assistance within their districts; they would assess the charge to be made on individuals liable to pay any part of the cost of the service rendered to them or their dependants, and recover the amount thus due. They would also have to consider the proposals of the various committees of the council for the payment of out-relief, or, as the minority prefer to term it, "home aliment." Other various duties are allotted to them in the report.

The subject of unemployment was considered by the minority and they made the following recommendations:—

Ministry of Labour.—The duty of organizing the national labour market should be placed upon a minister responsible to parliament. The ministry of labour should have six distinct and separately organized divisions; viz. the national labour exchange; the trade insurance division; the maintenance and training division; the industrial regulation division; the emigration and immigration division, and the statistical division.

National Labour Exchange.—The function of the national labour exchange should be, not only, (a) to ascertain and report the surplus or shortage of labour of particular kinds, at particular places; and (b) to diminish the time and energy now spent in looking for work, and the consequent leaking between jobs; but also (c) so to dovetail casual and seasonal employments as to arrange for practical continuity of work for those now chronically unemployed.

Absorption of Surplus Labour.—To reduce the surplus of labour the minority recommend (a) that no child should be employed, in any occupation whatsoever, below the age of fifteen; no young person under eighteen for more than thirty hours per week, and all so employed should be required to attend some suitable public institution for not less than thirty hours per week for physical training and technical education; (b) the hours of labour of railway, omnibus and tramway employees should be reduced to a maximum of sixty, if not of forty-eight in any one week; and (c) wage-earning mothers of young children should be withdrawn from the industrial world by giving them sufficient public assistance for the support of their families.

Regularization of the National Demand for Labour.—In order to meet the periodically recurrent general depressions of trade the government should take advantage of there being at these periods as much unemployment of capital as there is unemployment of labour; that it should definitely undertake, as far as practicable,

the regularization of the national demand for labour; and that it should, for this purpose, and to the extent of at least £4,000,000 a year, arrange a portion of the ordinary work required by each department on a ten years' programme; £40,000,000 worth of work for the decade being then put in hand, not by equal annual instalments, but exclusively in the lean years of the trade cycle; being paid for out of loans for short terms raised as they are required, and being executed with the best available labour, at standard rates, engaged in the ordinary way. That in this ten years' programme there should be included works of afforestation, coast protection and land reclamation; to be carried out by the board of agriculture exclusively in the lean years of the trade cycle; by the most suitable labour obtainable, taken on in the ordinary way at the rates locally current for the work, and paid for out of loans raised as required.

Trade Union Insurance.—In view of its probable adverse effect on trade union membership and organization the minority commissioners cannot recommend the establishment of any plan of government or compulsory insurance against unemployment. They recommend, however, a government subvention not exceeding one half of the sum actually paid in the last preceding year as out-of-work benefit should be offered to trade unions or other societies providing such benefit.

Maintenance and Training.—For the ultimate residuum of men in distress from want of employment the minority recommend that maintenance should be freely provided, without disfranchisement, on condition that they submit themselves to the physical and mental training that they may prove to require. Suitable day training depots or residential farm colonies should be established, where the men's whole working time would be absorbed in such varied beneficial training of body and mind as they proved capable of; their wives and families being, meanwhile, provided with adequate home aliment.

AUTHORITIES.—The Report and Evidence of the Royal Commission of 1905-1909 is a library in itself on the subject of pauperism. The contents of the various volumes are given *supra*. Other important publications are *Report and Evidence of Royal Commission on Aged Poor* (1895); *Report and Evidence of Select Committee of House of Commons on Distress from Want of Employment* (1895); *Report of Departmental Committee on Vagrancy* (1906). See also the references in the bibliography to CHARITY AND CHARITIES; and Sir G. Nicholls and T. Mackay, *A History of the English Poor Law* (3 vols., 1899); the publications of the Charity Organization Society; Reports of Poor Law Conferences. For list of subjects discussed, see index to *Report of Central Conferences*.

POPAYAN, a city of Colombia, capital of the department of Cauca, about 240 m. S.W. of Bogotá, on the old trade route between that city and Quito, in 2° 26' N., 76° 49' W. Pop. (1870), 8485; (1906, estimate), 10,000. Popayan is built on a great plain sloping N.W. from the foot of the volcano Purace, near the source of the Cauca and on one of its small tributaries, 5712 ft. above the sea. Its situation is singularly picturesque, the Purace rising to an elevation of 15,420 ft. about 20 m. south-east of the city, the Sotara volcano to approximately the same height about the same distance south by east, and behind these at a greater distance the Pan de Azucar, 15,978 ft. high. The ridge forming the water-parting between the basins of the Cauca and Patia rivers crosses between the Central and Western Cordilleras at this point and culminates a few miles to the south. Popayan is the seat of a bishopric dating from 1547, whose cathedral was built by the Jesuits; and in the days of its prosperity it possessed a university of considerable reputation. It has several old churches, a college, two seminaries founded about 1870 by the French Lazarists, who have restored and occupy the old Jesuit convent, and a mint established in 1749. The city was at one time an important commercial and mining centre, but much of its importance was lost through the transfer of trade to Cali and Pasto, through the decay of neighbouring mining industries, and through political disturbances. Earthquakes have also caused much damage to Popayan, especially those of 1827 and 1834. The modern city has some small manufacturing industries, including woollen fabrics for clothing, but its trade is much restricted, and its importance is political rather than commercial.

Popayan was founded by Sebastian Benalcazar in 1538 on the site of an Indian settlement, whose chief, Payan, had the unusual honour of having his name given to the usurping town. In 1558 it received a coat of arms and the title of "Muy noble y muy leal" from the king of Spain—a distinction of great

significance in that disturbed period of colonial history. It is noted also as the birthplace of Cãldas, the Colombian naturalist, and of Mosquera, the geographer. There are hot sulphurous springs near by on the flanks of the volcano Purace, especially at Coconuco, which are much frequented by Colombians.

POPE (Gr. *πάππας*, post-classical Lat. *papa*, father), an ecclesiastical title now used exclusively to designate the head of the Roman Catholic Church. In the 4th and 5th centuries it was frequently used in the West of any bishop (Du Cange, *s.v.*); but it gradually came to be reserved to the bishop of Rome, becoming his official title. In the East, on the other hand, only the bishop of Alexandria seems to have used it as a title; but as a popular term it was applied to priests, and at the present day, in the Greek Church and in Russia, all the priests are called *pappas*, which is also translated "pope." Even in the case of the sovereign pontiff the word pope is officially only used as a less solemn style: though the ordinary signature and heading of briefs is, e.g. "Pius P.P.X.," the signature of bulls is "*Pius episcopus ecclesie catholice*," and the heading, "*Pius episcopus, servus servorum Dei*," this latter formula going back to the time of St Gregory the Great. Other styles met with in official documents are *Pontifex*, *Summus pontifex*, *Romanus pontifex*, *Sanctissimus*, *Sanctissimus pater*, *Sanctissimus dominus noster*, *Sanctitas sua*, *Beatissimus pater*, *Beatitudo sua*; while the pope is addressed in speaking as "*Sanctitas vestra*," or "*Beatissime pater*." In the middle ages is also found "*Dominus apostolicus*" (cf. still, in the litanies of the saints), or simply "*Apostolicus*."

The pope is pre-eminently, as successor of St Peter, bishop of Rome. Writers are fond of viewing him as representing

Various Degrees of Jurisdiction. all the degrees of the ecclesiastical hierarchy; they say that he is bishop of Rome, metropolitan of the Roman province, primate of Italy, patriarch of the western Church and head of the universal Church.

This is strictly correct, but, with the exception of the first and last, these titles are seldom to be found in documents. And if these terms were intended to indicate so many degrees in the exercise of jurisdiction they would not be correct. As a matter of fact, from the earliest centuries (cf. can. 6 of Nicaea, in 325), we see that the popes exercised a special metropolitan jurisdiction not only over the bishops nearest to Rome, the future cardinal bishops, but also over all those of central and southern Italy, including Sicily (cf. Duchesne, *Origines du culte*, ch. 1), all of whom received their ordination at his hands. Northern Italy and the rest of the western Church, still more the eastern Church, did not depend upon him so closely for their administration. His influence was exercised, however, not only in dogmatic questions but in matters of discipline, by means of appeals, petitions and consultations, not to mention spontaneous intervention. This state of affairs was defined and developed in the course of centuries, till it produced the present state of centralization, according to a law which can equally be observed in other societies. In practice the different degrees of jurisdiction, as represented in the pope, are of no importance: he is bishop of Rome and governs his diocese by direct episcopal authority; he is also the head of the Church, and in this capacity governs all the dioceses, though the regular authority of each bishop in his own diocese is also ordinary and immediate, *i.e.* he is not a mere vicar of the pope.

But the mode of exercise of a power and its intensity are subject to variation, while the power remains essentially the same. This is the case with the power of the pope

Primacy. and his primacy, the exercise and manifestation of which have been continually developing. This primacy, a primacy of honour and jurisdiction, involving the plenitude of power over the teaching, the worship, the discipline and administration of the Church, is received by the pope as part of the succession of St Peter, together with the episcopate of Rome. The whole episcopal body, with the pope at its head, should be considered as succeeding to the apostolic college,

presided over by St Peter; and the head of it, now as then, as personally invested with all the powers enjoyed by the whole body, including the head. Hence the pope, as supreme in matters of doctrine, possesses the same authority and the same infallibility as the whole Church; as legislator and judge he possesses the same power as the episcopal body gathered around and with him in oecumenical council. Such are the two essential prerogatives of the papal primacy: infallibility in his supreme pronouncements in matters of doctrine (see **INFALLIBILITY**); and immediate and sovereign jurisdiction, under all its aspects, over all the pastors and the faithful. These two privileges, having been claimed and enjoyed by the popes in the course of centuries, were solemnly defined at the Vatican Council by the constitution "*Pastor aeternus*" of the 18th of July 1870. The two principal passages in it are the following. (1) In the matter of jurisdiction: "If any one say that the Roman Pontiff has an office merely of inspection and direction, and not the full and supreme power of jurisdiction over the whole Church, not only in matters of faith and morals, but also as regards discipline and the government of the Church scattered throughout the whole world; or that he has only the principal portion and not the plenitude of that supreme power; or that his power is not ordinary and immediate, as much over each and every church as over each and every pastor and believer: anathema sit." (2) In the matter of infallibility: "We decree that when the Roman Pontiff speaks *ex cathedra*, that is to say, when, in his capacity as Pastor and Doctor of all Christians he defines, in virtue of his supreme apostolic authority, a certain doctrine concerning faith or morals to be held by the whole Church, he enjoys, by the divine assistance promised to him in the Blessed Peter, that infallibility with which the divine Redeemer has thought good to endow His Church in order to define its doctrine in matters of faith and morals; consequently, these definitions of the Roman Pontiff are irreformable in themselves and not in consequence of the consent of the Church."

For the history of the papacy, and associated questions, see **PAPACY**, **CONCLAVE**, **CURIA ROMANA**, **CARDINAL**, &c.

The ordinary costume of the pope is similar to that of the other clergy and bishops, but white in colour; his shoes alone are different, being low open shoes, red in colour, with a cross embroidered on the front; these are what are called the "mules," a substitute for the *compagi* of ancient times, formerly reserved to the pope and his clergy (cf. Duchesne, *op. cit.* ch. 11, 6). Over this costume the pope wears, on less solemn occasions, the lace rochet and the red mozetta, bordered with ermine, or the *camauero*, similar to the mozetta, but with the addition of a hood, and over all the stole embroidered with his arms. The pope's liturgical costume consists, in the first place, of all the elements comprising that of the bishops: stockings and sandals, amice, alb, cincture, tunicle and dalmatic, stole, ring, gloves, chasuble or cope, the latter, however, with a morse ornamented with precious stones, and for head-dress the mitre (see **VESTMENTS**). The tiara (*q.v.*), the pontifical head-dress, is not used strictly speaking in the course of the liturgical functions, but only for processions. To these vestments or insignia the pope adds: the *falda*, a kind of long skirt trailing on the ground all round, which the chaplains hold up while he is walking. Over the chasuble he wears the *fanone* (see **AMICE**); and after that the pallium (*q.v.*). He is preceded by the papal cross, carried with the crucifix turned towards him. When going to solemn ceremonies he is carried on the *sedia*, a portable chair of red velvet with a high back, and escorted by two *flabelli* of peacock feathers. The papal mass, now rarely celebrated, has preserved more faithfully the ancient liturgical usages of the 8th and 9th centuries.

BIBLIOGRAPHY.—Bellarmine, *De romano pontifice*; Wilmers, *De christi ecclesia* (Regensburg, 1897); Turmel, *Histoire de la théologie positive*, vol. ii. (Paris, 1906); Hinschius, *Kirchenrecht*, vol. i. (Berlin, 1869); Rudolph Sohm, *Kirchenrecht* (1892); Duchesne, *Les Origines du culte chrétien* (4th ed., Paris, 1908); Bouix, *De papa* (Paris, 1869); Vacant, *Études théologiques sur les constitutions du concile du Vatican* (Paris, 1895); Barbier de Montault, *Le Costume et les usages ecclésiastiques* (Paris, 1897). (A. Bo.)*

POPE, ALEXANDER (1688-1744), English poet, was born in Lombard Street, London, on the 21st of May 1688. His father, Alexander Pope, a Roman Catholic, was a linen-draper who afterwards retired from business with a small fortune, and fixed his residence about 1700 at Binfield in Windsor Forest. Pope's education was desultory. His father's religion would have excluded him from the public schools, even had there been no other impediment to his being sent there. Before he was twelve he had obtained a smattering of Latin and Greek from various masters, from a priest in Hampshire, from a schoolmaster at Twyford near Winchester, from Thomas Deane, who kept a school in Marylebone and afterwards at Hyde Park Corner, and finally from another priest at home. Between his twelfth and his seventeenth years excessive application to study undermined his health, and he developed the personal deformity which was in so many ways to distort his view of life. He thought himself dying, but through a friend, Thomas (afterwards the abbé) Southcote, he obtained the advice of the famous physician John Radcliffe, who prescribed diet and exercise. Under this treatment the boy recovered his strength and spirits. "He thought himself the better," Spence says, "in some respects for not having had a regular education. He (as he observed in particular) read originally for the sense, whereas we are taught for so many years to read only for words." He afterwards learnt French and Italian, probably in a similar way. He read translations of the Greek, Latin, French and Italian poets, and by the age of twelve, when he was finally settled at home and left to himself, he was not only a confirmed reader, but an eager aspirant to the highest honours in poetry. There is a story, which chronological considerations make extremely improbable, that in London he had crept into Will's coffee-house to look at Dryden, and a further tale that the old poet had given him a shilling for a translation of the story of Pyramus and Thisbe; he had lampooned his schoolmaster; he had made a play out of John Ogilby's *Iliad* for his school-fellows; and before he was fifteen he had written an epic, his hero being Alcander, a prince of Rhodes, or, as he states elsewhere, Deucalion.

There were, among the Roman Catholic families near Binfield, men capable of giving a direction to his eager ambition, men of literary tastes, and connexions with the literary world. These held together as members of persecuted communities always do, and were kept in touch with one another by the family priests. Pope was thus brought under the notice of Sir William Trumbull, a retired diplomatist living at Easthampstead, within a few miles of Binfield. Thomas Dancastle, lord of the manor of Binfield, took an active interest in his writings, and at Whiteknights, near Reading, lived another Roman Catholic, Anthony Englefield, "a great lover of poets and poetry." Through him Pope made the acquaintance of Wycherley and of Henry Cromwell, who was a distant cousin of the Protector, a gay man about town, and something of a pedant. Wycherley introduced him to William Walsh, then of great renown as a critic.¹ Before the poet was seventeen he was admitted in this way to the society of London "wits" and men of fashion, and was cordially encouraged as a prodigy. Wycherley's correspondence with Pope was skilfully manipulated by the younger man to represent Wycherley as submitting, at first humbly and then with an ill-grace, to Pope's criticisms. The publication (Elwin and Courthope, vol. v.) of the originals of Wycherley's letters from MSS. at Longleat showed how seriously the relations between the two friends, which ceased in 1710, had been misrepresented in the version of the correspondence which Pope chose to submit to the public. Walsh's contribution to his development was the advice to study "correctness." "About fifteen," he says, "I got acquainted with Mr. Walsh. He used to encourage me much, and used to tell me that there was one way left of excelling;

for, though we had several great poets, we never had any one great poet that was correct, and he desired me to make that my study and aim" (Spence, p. 280). Trumbull turned Pope's attention to the French critics, out of the study of whom grew the *Essay on Criticism*; he suggested the subject of *Windsor Forest*, and he started the idea of translating Homer.

It says something for Pope's docility at this stage that he recognized so soon that a long course of preparation was needed for such a *magnum opus*, and began steadily and patiently to discipline himself. The epic was put aside and afterwards burnt; versification was industriously practised in short "essays"; and an elaborate study was made of accepted critics and models. He learnt most, as he acknowledged, from Dryden, but the harmony of his verse also owed something to an earlier writer, George Sandys, the translator of Ovid. At the beginning of the 18th century Dryden's success had given great vogue to translations and modernizations. The air was full of theories as to the best way of doing such things. What Dryden had touched Pope did not presume to meddle with—Dryden was his hero and master; but there was much more of the same kind to be done. Dryden had rewritten three of the *Canterbury tales*; Pope tried his hand at the *Merchant's Tale*, and the *Prologue to the Wife of Bath's Tale*, and produced also an imitation of the *House of Fame*. Dryden had translated Virgil; Pope experimented on the *Thebais* of Statius, Ovid's *Heroides* and *Metamorphoses*, and the *Odyssey*. He knew little Latin and less Greek, but there were older versions in English which helped him to the sense; and, when the correspondents to whom he submitted his versions pointed out mistranslations, he could answer that he had always agreed with them, but that he had deferred to the older translators against his own judgment. It was one of Pope's little vanities to try to give the impression that his metrical skill was more precocious even than it was, and we cannot accept his published versions of Statius and Chaucer (published in "miscellanies" at intervals between 1709 and 1714) as incontrovertible evidence of his proficiency at the age of sixteen or seventeen, the date, according to his own assertion, of their composition. But it is indisputable that at the age of seventeen his skill in verse astonished a veteran critic like Walsh, and some of his pastorals were in the hands of Sir George Granville (afterwards Lord Lansdowne) before 1706. His metrical letter to Cromwell, which Elwin dates in 1707, when Pope was nineteen, is a brilliant feat of versification, and has turns of wit in it as easy and spirited as any to be found in his mature satires. Pope was twenty-one when he sent the "Ode on Solitude" to Cromwell, and said it was written before he was twelve years old.

Precocious Pope was, but he was also industrious; and he spent some eight or nine years in arduous and enthusiastic discipline, reading, studying, experimenting, taking the advice of some and laughing in his sleeve at the advice of others, "poetry his only business," he said, "and idleness his only pleasure," before anything of his appeared in print. In these preliminary studies he seems to have guided himself by the maxim formulated in a letter to Walsh (dated July 2, 1706) that "it seems not so much the perfection of sense to say things that had never been said before, as to express those best that have been said oftenest." His first publication was his "Pastorals." Jacob Tonson, the bookseller, had seen these pastorals in the hands of Walsh and Congreve, and sent a polite note (April 20, 1706) to Pope asking that he might have them for one of his miscellanies. They appeared accordingly in May 1709 at the end of the sixth volume of Tonson's *Poetical Miscellanies*, containing contributions from Ambrose Philips, Sheffield, Garth and Rowe, with "January and May," Pope's version of Chaucer's "Merchant's Tale."

Pope's next publication was the *Essay on Criticism* (1711), written two years earlier, and printed without the author's name. "In every work regard the writer's end" (l. 255) is one of its sensible precepts, and one that is often neglected by critics of the essay, who comment upon it as if Pope's end had been to produce an original and profound treatise on first principles.

¹ The dates of Pope's correspondence with Wycherley are 1704-1710; with Walsh, 1705-1707, and with Cromwell, 1708-1727; with John Caryl (1666-1736) and his son, also neighbours, 1710-1735.

His aim was simply to condense, methodize, and give as perfect and novel expression as he could to floating opinions about the poet's aims and methods, and the critic's duties, to "what oft was thought, but ne'er so well expressed" (l. 298). "The town" was interested in *belles lettres*, and given to conversing on the subject; Pope's essay was simply a brilliant contribution to the fashionable conversation. The youthful author said that he did not expect the sale to be quick because "not one gentleman in sixty, even of liberal education, could understand it." The sales were slow until Pope caused copies to be sent to Lord Lansdowne and others, but its success was none the less brilliant for the delay. The town was fairly dazzled by the young poet's learning, judgment, and felicity of expression. Many of the admirers of the poem doubtless would have thought less of it if they had not believed all the maxims to be original. "I admired," said Lady Mary Wortley Montagu, "Mr Pope's *Essay on Criticism* at first very much, because I had not then read any of the ancient critics, and did not know that it was all stolen." Pope gained credit for much that might have been found, where he found it, in the *Institutes of Quintilian*, in the numerous critical writings of René Rapin, and in René le Bossu's treatise on epic poetry. Addison has been made responsible for the exaggerated value once set on the essay, but Addison's paper (*Spectator*, No. 253) was not unmixed praise. He deprecated the attacks made by Pope on contemporary literary reputations, although he did full justice to the poet's metrical skill. Addison and Pope became acquainted with one another, and Pope's sacred eclogue, "Messiah," was printed as No. 378 of the *Spectator*. In the *Essay on Criticism* Pope provoked one bitter personal enemy in John Dennis, the critic, by a description of him as Appius, who "stares, tremendous, with a threatening eye." Dennis retorted in *Reflections . . . upon a late Rhapsody . . .* (1711), abusing Pope among other things for his personal deformity. Pope never forgot this brutal attack, which he described in a note inserted after Dennis's death, as late as 1743, as written "in a manner perfectly lunatic."

The *Rape of the Lock* in its first form appeared in 1712 in *Lintot's Miscellanies*; the "machinery" of sylphs and gnomes was an afterthought, and the poem was republished as we now have it early in 1714. William, 4th Baron Petre, had surreptitiously cut off a lock of Miss Arabella Fermor's hair, and the liberty had been resented; Pope heard the story from his friend John Caryll, who suggested that the breach between the families might be healed by making the incident the subject of a mock-heroic poem like Boileau's *Lutrin*. Pope caught at the hint; the mock-heroic treatment of the pretty frivolities of fashionable life just suited his freakish sprightliness of wit, and his studies of the grand epic at the time put him in excellent vein. The *Rape of the Lock* is admitted to be a masterpiece of airiness, ingenuity, and exquisite finish. But the poem struck Taine as a piece of harsh, scornful, indelicate buffoonery, a mere succession of oddities and contrasts, of expressive figures unexpected and grinning, an example of English insensibility to French sweetness and refinement. Sir Leslie Stephen objected on somewhat different grounds to the poet's tone towards women. His laughter at Pope's raillery was checked by the fact that women are spoken of in the poem as if they were all like Belinda. The poem shows the hand of the satirist who was later to assert that "every woman is at heart a rake," in the epistle addressed to Martha Blount.

Windsor Forest, modelled on Sir John Denham's *Cooper's Hill*, had been begun, according to Pope's account, when he was sixteen or seventeen. It was published in March 1713 with a flattering dedication to the secretary for war, George Granville, Lord Lansdowne, and an opportune allusion to the peace of Utrecht. This was a nearer approach to taking a political side than Pope had yet made. His principle had been to keep clear of politics, and not to attach himself to any of the sets into which literary men were divided by party. Although inclined to the Jacobites by his religion, he never took any part in the plots for the restoration of the Stuarts, and he was on friendly terms with

the Whig coterie, being a frequent guest at the coffee-house kept by Daniel Button, where Addison held his "little senate." He had contributed his poem, "The Messiah" to the *Spectator*; he had written an article or two in the *Guardian*, and he wrote a prologue for Addison's *Cato*. Nevertheless he induced Lintot the bookseller to obtain from John Dennis a criticism of *Cato*. On the publication of Dennis's remarks, the violence of which had, as Pope hoped, made their author ridiculous, Pope produced an anonymous pamphlet, *The Narrative of Dr Robert Norris concerning the . . . Frenzy of Mr John Dennis* (1713), which, though nominally in defence of Addison, had for its main purpose the gratification of Pope's own hostility to Dennis. Addison disavowed any connivance in this coarse attack in a letter written on his behalf by Steele to Lintot, saying that if he noticed Dennis's attack at all it would be in such a way as to allow him no just cause of complaint. Coolness between Addison and Pope naturally followed this episode. When the *Rape of the Lock* was published, Addison, who is said to have praised the poem highly to Pope in private, dismissed it in the *Spectator* with two sentences of patronizing faint praise to the young poet, and, coupling it with Tickell's "Ode on the Prospect of Peace," devoted the rest of the article to an elaborate puff of "the pastorals of Mr Philips."

When Pope showed a leaning to the Tories in *Windsor Forest*, the members of Addison's coterie made insidious war on him. Within a few weeks of the publication of the poem, and when it was the talk of the town, there began to appear in the *Guardian* (Nos. 22, 23, 28, 30, 32) a series of articles on "Pastorals." Not a word was said about *Windsor Forest*, but everybody knew to what the general principles referred. Modern pastoral poets were ridiculed for introducing Greek moral deities, Greek flowers and fruits, Greek names of shepherds, Greek sports and customs and religious rites. They ought to make use of English rural mythology—hobthrushes, fairies, goblins and witches; they should give English names to their shepherds; they should mention flowers indigenous to English climate and soil; and they should introduce English proverbial sayings, dress, and customs. All excellent principles, and all neglected by Pope in *Windsor Forest*. The poem was fairly open to criticism in these points; there are many beautiful passages in it, showing close though somewhat professional observation of nature, but the mixture of heathen deities and conventional archaic fancies with modern realities is incongruous, and the comparison of Queen Anne to Diana was ludicrous. But the sting of the articles did not lie in the truth of the oblique criticisms. The pastorals of Ambrose Philips, published four years before, were again trotted out. Here was a true pastoral poet, the eldest born of Spenser, the worthy successor of Theocritus and Virgil!

Pope took an amusing revenge, which turned the laugh against his assailants. He sent Steele an anonymous paper in continuation of the articles in the *Guardian* on pastoral poetry, reviewing the poems of Mr Pope by the light of the principles laid down. Ostensibly Pope was censured for breaking the rules, and Philips praised for conforming to them, quotations being given from both. The quotations were sufficient to dispose of the pretensions of poor Philips, and Pope did not choose his own worst passages, accusing himself of actually deviating sometimes into poetry. Although the *Guardian's* principles were also brought into ridicule by burlesque exemplifications of them after the manner of Gay's *Shepherd's Week*, Steele, misled by the opening sentences, was at first unwilling to print what appeared to be a direct attack on Pope, and is said to have asked Pope's consent to the publication, which was graciously granted.

The links that attached Pope to the Tory party were strengthened by a new friendship. His first letter to Swift, who became warmly attached to him, is dated the 8th of December 1713. Swift had been a leading member of the Brothers' Club, from which the famous Scriblerus Club seems to have been an offshoot. The leading members of this informal

literary society were Swift, Arbuthnot, Congreve, Bishop Atterbury, Pope, Gay and Thomas Parnell. Their chief object was a general war against the dunces, waged with great spirit by Arbuthnot, Swift and Pope.

The estrangement from Addison was completed in connexion with Pope's translation of Homer. This enterprise was definitely undertaken in 1713. The work was to be published by subscription, as Dryden's Virgil had been. Men of all parties subscribed, their unanimity being a striking proof of the position Pope had attained at the age of twenty-five. It was as if he had received a national commission as by general consent the first poet of his time. But the unanimity was broken by a discordant note. A member of the Addison clique, Tickell, attempted to run a rival version. Pope suspected Addison's instigation; Tickell had at least Addison's encouragement. Pope's famous character of Addison as "Atticus" in the *Epistle to Dr Arbuthnot* (ii. 193-215) was, however, inspired by resentment at insults that existed chiefly in his own imagination, though Addison was certainly not among his warmest admirers. Pope afterwards claimed to have been magnanimous, but he spoiled his case by the petty inventions of his account of the quarrel.

The translation of Homer was Pope's chief employment for twelve years. The new pieces in the miscellanies published in 1717, his "Elegy on an Unfortunate Lady," and his "Eloisa to Abelard," were probably written some years before their publication. His "Eloisa to Abelard" was based on an English translation by John Hughes of a French version of the *Letters*, which differed very considerably from the original Latin. The *Iliad* was delivered to the subscribers in instalments in 1715, 1717, 1718 and 1720. Pope's own defective scholarship made help necessary. William Broome and John Jortin supplied the bulk of the notes, and Thomas Parnell the preface. For the translation of the *Odyssey* he took Elijah Fenton and Broome as coadjutors, who between them translated twelve out of the twenty-four books.¹ It was completed in 1725. The profitableness of the work was Pope's chief temptation to undertake it. His receipts for his earlier poems had totalled about £150, but he cleared more than £8000 by the two translations, after deducting all payments to coadjutors—a much larger sum than had ever been received by an English author before.

The translation of Homer had established Pope's reputation with his contemporaries, and has endangered it ever since it was challenged. Opinions have varied on the purely literary merits of the poem, but with regard to it as a translation few have differed from Bentley's criticism, "A fine poem, Mr Pope, but you must not call it Homer." His collaboration with Broome (*q.v.*) and Fenton (*q.v.*)² involved him in a series of recriminations. Broome was weak enough to sign a note at the end of the work understating the extent of Fenton's assistance as well as his own, and ascribing the merit of their translation, reduced to less than half its real proportions, to a regular revision and correction—mostly imaginary—at Pope's hands. These falsehoods were deemed necessary by Pope to protect himself against possible protests from the subscribers. In 1722 he edited the poems of Thomas Parnell, and in 1725 made a considerable sum by an unsatisfactory edition of Shakespeare, in which he had the assistance of Fenton and Gay.

Pope, with his economical habits, was rendered independent by the pecuniary success of his *Homer*, and enabled to live near London. The estate at Binfield was sold, and he removed with his parents to Mawson's Buildings, Chiswick, in 1716, and in 1719 to Twickenham, to the house with which his name is associated. Here he practised elaborate landscape gardening on a small scale, and built his famous grotto, which was really a tunnel under the road connecting the garden with the lawn on the Thames. He was constantly visited at Twickenham by his intimates, Dr John Arbuthnot, John Gay, Bolingbroke

(after his return in 1723), and Swift (during his brief visits to England in 1726 and 1727), and by many other friends of the Tory party. With Atterbury, bishop of Rochester, he was on terms of affectionate intimacy, but he blundered in his evidence when he was called as a witness on his behalf in 1723.

In 1717 his father died, and he appears to have turned to the Blounts for sympathy in what was to him a very serious bereavement. He had early made the acquaintance of Martha and Teresa Blount, both of them intimately connected with his domestic history. Their home was at Mapledurham, near Reading, but Pope probably first met them at the house of his neighbour, Mr Englefield of Whiteknights, who was their grandfather. He began to correspond with Martha Blount in 1712, and after 1717 the letters are much more serious in tone. He quarrelled with Teresa, who had apparently injured or prevented his suit to her sister; and although, after her father's death in 1718, he paid her an annuity, he seems to have regarded her as one of his most dangerous enemies. His friendship with Martha lasted all his life. So long as his mother lived he was unwearied in his attendance on her, but after her death in 1733 his association with Martha Blount was more constant. In defiance of the scandal-mongers, they paid visits together at the houses of common friends, and at Twickenham she spent part of each day with him. His earlier attachment to Lady Mary Wortley Montagu was apparently a more or less literary passion, which perished under Lady Mary's ridicule.

The year 1725 may be taken as the beginning of the third period of Pope's career, when he made his fame as a moralist and a satirist. It may be doubted whether Pope had the staying power necessary for the composition of a great imaginative work, whether his crazy constitution would have held together through the strain. He toyed with the idea of writing a grand epic. He told Spence that he had it all in his head, and gave him a vague (and it must be admitted not very promising) sketch of the subject and plan of it. But he never put any of it on paper. He shrank as with instinctive repulsion from the stress and strain of complicated designs. Even his prolonged task of translating weighed heavily on his spirits, and this was a much less formidable effort than creating an epic. He turned rather to designs that could be accomplished in detail, works of which the parts could be separately laboured at and put together with patient care, into which happy thoughts could be fitted that had been struck out at odd moments and in ordinary levels of feeling.

Edward Young's satire, *The Universal Passion*, had just appeared, and been received with more enthusiasm than any thing published since Pope's own early successes. This alone would have been powerful inducement to Pope's emulous temper. Swift was finishing *Gulliver's Travels*, and came over to England in 1726. The survivors of the Scriblerus Club—Swift, Pope, Arbuthnot, and Gay—resumed their old amusement of parodying and otherwise ridiculing bad writers, especially bad writers in the Whig interest. Two volumes of their *Miscellanies in Prose and Verse* were published in 1727. A third volume appeared in 1728, and a fourth was added in 1732. According to Pope's own history of the *Dunciad*, an *Heroic Poem in Three Books*, which first appeared on the 28th of May 1728, the idea of it grew out of this. Among the *Miscellanies* was a "Treatise of the Bathos or the Art of Sinking in Poetry," in which poets were classified, with illustrations, according to their eminence in the various arts of debasing instead of elevating their subject. No names were mentioned, but the specimens of bathos were assigned to various letters of the alphabet, which, the authors boldly asserted, were taken at random. But no sooner was the treatise published than the scribblers proceeded to take the letters to themselves, and in revenge to fill the newspapers with the most abusive falsehoods and scurrilities they could devise. This gave Pope the opportunity he had hoped for, and provided him with an excuse for the personalities of the *Dunciad*, which had been in his mind as early as 1720. Among the most prominent objects of his satire were Lewis

¹ 1, 4, 19 and 20 are by Fenton; 2, 6, 8, 11, 12, 16, 18, 23, with notes to all the books, by Broome.

² The correspondence with them is given in vol. viii. of Elwin and Courthope's edition.

Theobald, Colley Cibber, John Dennis, Richard Bentley, Aaron Hill and Bernard Lintot, who, in spite of his former relations with Pope, was now classed with the piratical Edmund Curll. The book was published with the greatest precautions. It was anonymous, and professed to be a reprint of a Dublin edition. When the success of the poem was assured, it was republished in 1729, and a copy was presented to the king by Sir Robert Walpole. Names took the place of initials, and a defence of the satire, written by Pope himself, but signed by his friend William Cleland, was printed as "A letter to the Publisher." Various indexes, notes and particulars of the attacks on Pope made by the different authors satirized were added. To avoid any danger of prosecution, the copyright was assigned to Lord Oxford, Lord Bathurst and Lord Burlington, whose position rendered them practically unassailable. We may admit that personal spite influenced Pope at least as much as disinterested zeal for the honour of literature, but in the dispute as to the comparative strength of these motives, a third is apt to be overlooked that was probably stronger than either. This was an unscrupulous elfish love of fun, and delight in the creations of a humorous imagination. Certainly to represent the *Dunciad* as the outcome of mere personal spite is to give an exaggerated idea of the malignity of Pope's disposition, and an utterly wrong impression of the character of his satire. He was not, except in rare cases, a morose, savage, indignant satirist, but airy and graceful in his malice, revengeful perhaps and excessively sensitive, but restored to good humour as he thought over his wrongs by the ludicrous conceptions with which he invested his adversaries. The most unprovoked assault was on Richard Bentley, whom he satirized in the reconstruction and enlargement of the *Dunciad* made in the last years of his life at the instigation, it is said, of William Warburton. In the earlier editions the place of hero had been occupied by Lewis Theobald, who had ventured to criticize Pope's *Shakespeare*. In the edition which appeared in Pope's *Works* (1742), he was dethroned in favour of Colley Cibber, who had just written his *Letter from Mr Cibber to Mr Pope inquiring into the motives that might induce him in his satirical writings to be so frequently fond of Mr Cibber's name* (1742). Warburton's name is attached to many new notes, and one of the preliminary dissertations by Ricardus Aristarchus on the hero of the poem seems to be by him.

The four epistles of the *Essay on Man* (1733) were also intimately connected with passing controversies. They belong to the same intellectual movement with Butler's *Analogy*—the effort of the 18th century to put religion on a rational basis. But Pope was not a thinker like Butler. The subject was suggested to him by Henry St John, Lord Bolingbroke, who had returned from exile in 1723, and was a fellow-member of the Scriblerus Club. Bolingbroke is said—and the statement is supported by the contents of his posthumous works—to have furnished most of the arguments. Pope's contribution to the controversy consisted in brilliant epigram and illustration. In this didactic work, as in his *Essay on Criticism*, he put together on a sufficiently simple plan a series of happy sayings, separately elaborated, picking up the thoughts as he found them in miscellaneous reading and conversation, and trying only to fit them with perfect expression. His readers were too dazzled by the verse to be severely critical of the sense. Pope himself had not comprehended the drift of the arguments he had adopted from Bolingbroke, and was alarmed when he found that his poem was generally interpreted as an apology for the free-thinkers. Warburton is said to have qualified its doctrines as "rank atheism," and asserted that it was put together from the "worst passages of the worst authors." The essay was soon translated into the chief European languages, and in 1737 its orthodoxy was assailed by a Swiss professor, Jean Pierre de Crousaz, in an *Examen de l'essay de M. Pope sur l'homme*. Warburton now saw fit to revise his opinion of Pope's abilities and principles—for what reason does not appear. In any case he now became as enthusiastic in his praise of Pope's orthodoxy and his genius as he had before been

scornful, and proceeded to employ his unrivalled powers of sophistry in a defence of the orthodoxy of the conflicting and inconsequent positions adopted in the *Essay on Man*. Pope was wise enough to accept with all gratitude an ally who was so useful a friend and so dangerous an enemy, and from that time onward Warburton was the authorized commentator of his works.

The *Essay on Man* was to have formed part of a series of philosophic poems on a systematic plan. The other pieces were to treat of human reason, of the use of learning, wit, education and riches, of civil and ecclesiastical polity, of the character of women, &c. Of the ten epistles of the *Moral Essays*, the first four, written between 1731 and 1735, are connected with this scheme, which was never executed.

There was much bitter, and sometimes unjust, satire in the *Moral Essays* and the *Imitations of Horace*. In these epistles and satires, which appeared at intervals, he was often the mouth-piece of his political friends, who were all of them in opposition to Walpole, then at the height of his power, and Pope chose the object of his attacks from among the minister's adherents. Epistle III., "Of the Use of Riches," addressed to Allen Bathurst, Lord Bathurst, in 1732, is a direct attack on Walpole's methods of corruption, and on his financial policy in general; and the two dialogues (1738) known as the "Epilogue to the Satires," professedly a defence of satire, form an eloquent attack on the court. Pope was attached to the prince of Wales's party, and he did not forget to insinuate, what was indeed the truth, that the queen had refused the prince her pardon on her deathbed. The "Epistle to Dr Arbuthnot" contains a description of his personal attitude towards the scribblers and is made to serve as a "prologue to the satires." The gross and unpardonable insults bestowed on Lord Hervey and on Lady Mary Wortley Montagu in the first satire "to Mr Fortescue" provoked angry retaliation from both. The description of Timon's ostentatious villa in Epistle IV., addressed to the earl of Burlington, was generally taken as a picture of Canons, the seat of John Brydges, duke of Chandos, one of Pope's patrons, and caused a great outcry, though in this case Pope seems to have been innocent of express allusion. Epistle II., addressed to Martha Blount, contained the picture of Atossa, which was taken to be a portrait of Sarah Jennings, duchess of Marlborough. One of the worst imputations on Pope's character was that he left this passage to be published when he had in effect received a bribe of £1000 from the duchess of Marlborough for its suppression through the agency of Nathanael Hooke (d. 1763). As the passage eventually stood, it might be applied to Katherine, duchess of Buckingham, a natural daughter of James II. Pope may have altered it with the intention of diverting the satire from the original object. He was scrupulously honest in money matters, and always independent in matters of patronage; but there is some evidence for this discreditable story beyond the gossip of Horace Walpole (*Works*, ed. P. Cunningham, i. cxliv.), though not sufficient to justify the acceptance it received by some of Pope's biographers. To appreciate fully the point of his allusions requires an intimate acquaintance with the political and social gossip of the time. But apart from their value as a brilliant strongly-coloured picture of the time Pope's satires have a permanent value as literature. It is justly remarked by Mark Pattison¹ that "these *Imitations* are among the most original of his writings." The vigour and terseness of the diction is still unsurpassed in English verse. Pope had gained complete mastery over his medium, the heroic couplet, before he used it to express his hatred of the political and social evils which he satirized. The elaborate periphrases and superfluous ornaments of his earlier manner, as exemplified in the *Pastorals* and the *Homer*, disappeared; he turned to the uses of verse the ordinary language of conversation, differing from everyday speech only in its exceptional brilliance and point. It is in these satires that his best work must be sought, and by them that his position among English poets must be fixed. It was

¹ In his edition of the *Satires and Epistles* (1866).

the *Homer* chiefly that Wordsworth and Coleridge had in their eye when they began the polemic against the "poetic diction" of the 18th century, and struck at Pope as the arch-corrupter. They were historically unjust to Pope, who did not originate this diction, but only furnished the most finished examples of it. At the beginning of the 19th century Pope still had an ardent admirer in Byron, whose first satires are written in Pope's couplet. The much abused pseudo-poetic diction in substance consisted in an ambition to "rise above the vulgar style," to dress nature to advantage—a natural ambition when the arbiters of literature were people of fashion. If one compares Pope's "Messiah" or "Eloisa to Abelard," or an impassioned passage from the *Iliad*, with the originals that he paraphrased, one gets a more vivid idea of the consistence of pseudo-poetic diction than could be furnished by pages of analysis. But Pope merely made masterly use of the established diction of his time, which he eventually forsook for a far more direct and vigorous style. A passage from the *Guardian*, in which Philips was commended as against him, runs: "It is a nice piece of art to raise a proverb above the vulgar style and still keep it easy and unaffected. Thus the old wish, 'God rest his soul,' is very finely turned:—

"Then gentle Sidney liv'd, the shepherd's friend,
Eternal blessings on his shade attend!"

Pope would have despised so easy a metamorphosis as this at any period in his career, and the work of his coadjutors in the *Odyssey* may be distinguished by this comparative cheapness of material. Broome's description of the clothes-washing by Nausicaa and her maidens in the sixth book may be compared with the original as a luminous specimen.

Pope's wit had won for him the friendship of many distinguished men, and his small fortune enabled him to meet them on a footing of independence. He paid long visits at many great houses, especially at Stanton Harcourt, the home of his friend Lord Chancellor Harcourt; at Oakley, the seat of Lord Bathurst; and at Prior Park, Bath, where his host was Ralph Allen. With the last named he had a temporary disagreement owing to some slight shown to Martha Blount, but he was reconciled to him before his death.

He died on the 30th of May 1744, and he was buried in the parish church of Twickenham. He left the income from his property to Martha Blount till her death, after which it was to go to his half-sister Magdalen Rackett and her children. His unpublished MSS. were left at the discretion of Lord Bolingbroke, and his copyrights to Warburton.

If we are to judge Pope, whether as a man or as a poet, with human fairness, and not merely by comparison with standards of abstract perfection, there are two features of his times that must be kept steadily in view—the character of political strife in those days and the political relations of men of letters. As long as the succession to the Crown was doubtful, and political failure might mean loss of property, banishment or death, politicians, playing for higher stakes, played more fiercely and unscrupulously than in modern days, and there was no controlling force of public opinion to keep them within the bounds of common honesty. Hence the age of Queen Anne is pre-eminently an age of intrigue. The government was almost as unsettled as in the early days of personal monarchy, and there was this difference—that it was policy rather than force upon which men depended for keeping their position. Secondly, men of letters were admitted to the inner circles of intrigue as they had never been before and as they have never been since. A generation later Walpole defied them, and paid the rougher instruments that he considered sufficient for his purpose in solid coin of the realm; but Queen Anne's statesmen, whether from difference of tastes or difference of policy, paid their principal literary champions with social privileges and honourable public appointments. Hence men of letters were directly infected by the low political morality of the unsettled time. And the character of their poetry also suffered. The most prominent defects of the age—the lack of high and sustained imagination, the genteel liking for "nature to advantage

dressed," the incessant striving after wit—were fostered, if not generated, by the social atmosphere.

Pope's own ruling passion was the love of fame, and he had no scruples where this was concerned. His vanity and his childish love of intrigue are seen at their worst in his petty manoeuvres to secure the publication of his letters during his lifetime. These intricate proceedings were unravelled with great patience and ingenuity by Charles Wentworth Dilke, when the false picture of his relations with his contemporaries which Pope had imposed on the public had been practically accepted for a century. Elizabeth Thomas, the mistress of Henry Cromwell, had sold Pope's early letters to Henry Cromwell to the bookseller Curll for ten guineas. These were published in Curll's *Miscellanea* in 1726 (dated 1727), and had considerable success. This surreptitious publication seems to have suggested to Pope the desirability of publishing his own correspondence, which he immediately began to collect from various friends on the plea of preventing a similar clandestine transaction. The publication by Wycherley's executors of a posthumous volume of the dramatist's prose and verse furnished Pope with an excuse for the appearance of his own correspondence with Wycherley, which was accompanied by a series of unnecessary deceptions. After manipulating his correspondence so as to place his own character in the best light, he deposited a copy in the library of Edward, second earl of Oxford, and then he had it printed. The sheets were offered to Curll by a person calling himself P. T., who professed a desire to injure Pope, but was no other than Pope himself. The copy was delivered to Curll in 1735 after long negotiations by an agent who called himself R. Smythe, with a few originals to vouch for their authenticity. P. T. had drawn up an advertisement stating that the book was to contain answers from various peers. Curll was summoned before the House of Lords for breach of privilege, but was acquitted, as the letters from peers were not in fact forthcoming. Difficulties then arose between Curll and P. T., and Pope induced a bookseller named Cooper to publish a *Narrative of the Method by which Mr Pope's Private Letters were procured by Edmund Curll, Bookseller* (1735). These preliminaries cleared the way for a show of indignation against piratical publishers and a "genuine" edition of the *Letters of Mr Alexander Pope* (1737, fol. and 4to). Unhappily for Pope's reputation, his friend Caryll, who died before the publication, had taken a copy of Pope's letters before returning them. This letter-book came to light in the middle of the 19th century, and showed the freedom which Pope permitted himself in editing. The correspondence with Lord Oxford, preserved at Longleat, afforded further evidence of his tortuous dealings. The methods he employed to secure his correspondence with Swift were even more discreditable. The proceedings can only be explained as the measures of a desperate man whose maladies seem to have engendered a passion for trickery. They are related in detail by Elwin in the introduction to vol. i. of Pope's *Works*. A man who is said to have "played the politician about cabbages and turnips," and who "hardly drank tea without a stratagem," was not likely to be straightforward in a matter in which his ruling passion was concerned. Against Pope's petulance and "general love of secrecy and cunning" have to be set, in any fair judgment of his character, his exemplary conduct as a son, the affection with which he was regarded in his own circle of intimates, and many well-authenticated instances of genuine and continued kindness to persons in distress.

BIBLIOGRAPHY.—Various collected editions of Pope's *Works* appeared during his lifetime, and in 1751 an edition in nine volumes was published by a syndicate of booksellers "with the commentaries of Mr Warburton." Warburton interpreted his editorial rights very liberally. By his notes he wilfully misrepresented the meaning of the allusions in the satires, and made them more agreeable to his friends and to the court, while he made opportunities for the gratification of his own spite against various individuals. Joseph Warton's edition in 1797 added to the mass of commentary without giving much new elucidation to the allusions of the text, which even Swift, with his exceptional facilities, had found obscure. In 1769–1807 an edition was issued which included Owen Ruffhead's *Life of Alexander*

Pope (1769), inspired by Warburton. The notes of many commentators, with some letters and a memoir, were included in the *Works of Alexander Pope*, edited by W. L. Bowles (10 vols., 1806). His *Poetical Works* were edited by Alexander Dyce (1856); by R. Carruthers (1858) for Bohn's Library; by A. W. Ward (*Globe Edition*, 1869), &c. Materials for a definitive edition were collected by John Wilson Croker, and formed the basis of what has become the standard version, *The Works of Alexander Pope* (10 vols., 1871-1898), including unpublished letters and other new material, with introduction and notes by W. Elwin and W. J. Courthope. The life of Pope in vol. v. was contributed by Professor Courthope. The chief original authority besides Pope's correspondence and Ruffhead's *Life* is Joseph Spence's *Anecdotes*, published by S. W. Singer in 1820. Samuel Johnson gives a good estimate of Pope in his *Lives of the Poets*. The best modern lives are that by Professor Courthope, already mentioned; and *Alexander Pope*, by Sir L. Stephen, in the *English Men of Letters* series (1880). See also George Paston, *Mr Pope: His Life and Times* (1909). The first check to the admiration that prevailed during Pope's lifetime was given by the publication of Joseph Warton's *Essay on the Writings and Genius of Pope* (vol. i., 1757; vol. ii., 1782). Warton had a sincere appreciation of Pope's work, but he began the reaction which culminated with the romantic writers of the beginning of the 19th century, and set the fashion of an undue disparagement of Pope's genius as a poet with enduring effects on popular opinion. Thomas Campbell's criticism in his *Specimens of the British Poets* provoked a controversy to which William Hazlitt, Byron and W. L. Bowles contributed. For a discussion of Pope's position as one of the great men of letters in the 18th century who emancipated themselves from patronage, see A. Beljame, *Le Public et les hommes de lettres en Angleterre au dix-huitième siècle* (1881); a section of Isaac D'Israeli's *Quarrels of Authors* is devoted to Pope's literary animosities; and most important contributions to many vexed questions in the biography of Pope, especially the publication of his letters, were made by C. W. Dilke in *Notes and Queries* and the *Athenaeum*. These articles were reprinted by his grandson, Sir Charles Dilke, in 1875, as *The Papers of a Critic*. (W. M.; M. Br.)

POPE, ALEXANDER (1763-1835), Irish actor and painter, was born in Cork, and was educated to follow his father's profession of miniature painting. He continued to paint miniatures and exhibit them at the Royal Academy as late as 1821; but at an early date he took the stage, first appearing in London as Oroonoko in 1785 at Covent Garden. He remained at this theatre almost continuously for nearly twenty years, then at the Haymarket until his retirement, playing leading parts, chiefly tragic. He was particularly esteemed as Othello and Henry VIII. He died on the 22nd of March 1835. Pope was thrice married. His first wife, Elizabeth Pope (c. 1744-1797), a favourite English actress of great versatility, was billed before her marriage as Miss Younge. His second wife, Maria Ann Pope (1775-1803), also a popular actress, was a member of an Irish family named Campion. His third wife, Clara Maria Pope (d. 1838), was the widow of the artist Francis Wheatley, and herself a skilful painter of figures and of flowers.

POPE, JANE (1742-1818), English actress, daughter of a London theatrical wig-maker, who began playing in a Lilliputian company for Garrick in 1756. From this she speedily developed into soubrette rôles. She was Mrs Candour in *The School for Scandal* at its first presentation (1777), and thereafter she had many important parts confided to her. She was the life-long friend of Mrs Clive, and erected the monument at Twickenham to the latter's memory. She was not only an admirable actress, but a woman of blameless life, and was praised by all the literary critics of her day—unused to such a combination. She died on the 30th of July 1818.

POPE, JOHN (1822-1892), American soldier, was the son of Nathaniel Pope (1784-1850), U.S. judge for the district of Illinois, and was born at Louisville, Kentucky, on the 16th of March 1822. He graduated at the United States Military Academy in 1842 and was assigned to the engineers. He served in the Mexican War, receiving the brevets of 1st lieutenant and captain for his conduct at Monterey and Buena Vista. Subsequently he was engaged in engineering and exploring work, mainly in New Mexico, and in surveying the route for a Pacific railroad. He was commissioned captain in 1856. He was actively opposed to the Buchanan administration, and a speech which he made in connexion with the presidential campaign of 1860 caused him to be summoned before a court-martial. Early in the Civil War he was placed, as a brigadier-general

U.S.V., in charge of the district of Missouri, which by vigorous campaigning against guerrilla bands and severe administration of the civil population he quickly reduced to order. In 1862, along with the gunboat flotilla (commanded by Commodore A. H. Foote) on the Mississippi, Pope obtained a great success by the capture of the defences of New Madrid and Island No. 10, with nearly 7000 prisoners. Pope subsequently joined Halleck, and in command of the Army of the Mississippi took part in the siege of Corinth. He was now a major-general U.S.V. The reputation he had thus gained as an energetic leader quickly placed him in a high command, to which he proved to be quite unequal. The "Army of Virginia," as his new forces were styled, had but a brief career. At the very outset of his Virginian campaign Pope, by a most ill-advised order, in which he contrasted the performances of the Western troops with the failures of the troops in Virginia, forfeited the confidence of his officers and men. The feeling of the Army of the Potomac (which was ordered to his support) was equally hostile, and the short operations culminated in the disastrous defeat of the second battle of Bull Run. Pope was still sanguine and ready for another trial of strength, but he was soon compelled to realize the impossibility of retrieving his position, and resigned the command. Bitter controversy arose over these events. Halleck, the general-in-chief, was by no means free from blame, but the public odium chiefly fell upon generals McClellan and Fitz-John Porter, against whom Pope, while admitting his own mistakes, made grave charges. Pope was not again employed in the Civil War, but in command of the Department of the North-West he showed his former skill and vigour in dealing with Indian risings. In 1865 he was made brevet major-general U.S.A. (having become brigadier-general on his appointment to the Army of Virginia), and he subsequently was in charge of various military districts and departments until his retirement in 1886. In 1882 he was promoted to the full rank of major-general U.S.A. General Pope died at Sandusky, Ohio, on the 23rd of September 1892.

He was the author of various works and papers, including railway reports (*Pacific Railroad Reports* vol. iii.) and *The Campaign of Virginia* (Washington, 1865).

POPE, SIR THOMAS (c. 1507-1559), founder of Trinity College, Oxford, was born at Deddington, near Banbury, Oxfordshire, probably in 1507, for he was about sixteen years old when his father, a yeoman farmer, died in 1523. He was educated at Banbury school and Eton College, and entered the court of chancery. He there found a friend and patron in the lord-chancellor Thomas Audley. As clerk of briefs in the star chamber, warden of the mint (1534-1536), clerk of the Crown in chancery (1537), and second officer and treasurer of the court for the settlement of the confiscated property of the smaller religious foundations, he obtained wealth and influence. In this last office he was superseded in 1541, but from 1547 to 1553 he was again employed as fourth officer. He himself won by grant or purchase a considerable share in the spoils, for nearly thirty manors, which came sooner or later into his possession, were originally church property. "He could have rode," said Aubrey, "in his owne lands from Cogges (by Witney) to Banbury, about 18 miles." In 1537 he was knighted. The religious changes made by Edward VI. were repugnant to him, but at the beginning of Mary's reign he became a member of the privy council. In 1556 he was sent to reside as guardian in Elizabeth's house. As early as 1555 he had begun to arrange for the endowment of a college at Oxford, for which he bought the site and buildings of Durham College, the Oxford house of the abbey of Durham, from Dr George Owen and William Martyn. He received a royal charter for the establishment and endowment of a college of the "Holy and Undivided Trinity" on the 8th of March 1556. The foundation provided for a president, twelve fellows and eight scholars, with a schoolhouse at Hooknorton. The number of scholars was subsequently increased to twelve, the schoolhouse being given up. On the 28th of March the members of the college were put in possession of the site, and they were formally admitted on the 29th of May 1556. Pope died at Clerkenwell on the 29th of January 1559, and was buried at St Stephen's.

Walbrook; but his remains were subsequently removed to Trinity College, where his widow erected a semi-Gothic alabaster monument to his memory. He was three times married, but left no children. Much of his property was left to charitable and religious foundations, and the bulk of his Oxfordshire estates passed to the family of his brother, John Pope of Wroxton, and his descendants, the viscounts Dillon and the earls of Guilford and barons North.

The life, by H. E. D. Blakiston, in the *Dict. Nat. Biog.*, corrects many errors in Thomas Warton's *Life of Sir Thomas Pope* (1772). Further notices by the same authority are in his *Trinity College* (1898), in the "College Histories" Series, and in the *English Historical Review* (April, 1896).

POPE-JOAN, a round game of cards, named after a legendary female Pope of the 9th century. An ordinary pack is used, from which the eight of diamonds has been removed, and a special round board in the form of eight compartments, named respectively Pope-Joan, Matrimony, Intrigue, Ace, King, Queen, Knave and Game (King, Queen and Knave are sometimes omitted). Each player—any number can play—contributes a stake, of which one counter is put into the divisions Ace, King, Queen, Knave and Game, two into Matrimony and Intrigue, and the rest into Pope-Joan. This is called "dressing the board." The cards are dealt round, with an extra hand for "stops," *i.e.* cards which stop, by their absence, the completion of a suit; thus the absence of the nine of spades stops the playing of the ten. The last card is turned up for trumps. Cards in excess may be dealt to "stops," or an agreed number may be left for the purpose, so that all players may have an equal number of cards. If an honour or "Pope" (nine of diamonds) is turned up, the dealer takes the counters in the compartment so marked. Sometimes the turning-up of Pope settles the hand, the dealer taking the whole pool. The Ace is the lowest card, the King the highest. The player on the dealer's left plays a card and names it; the player who has the next highest then plays it, till a stop is played, *i.e.* a card of which no one holds the next highest. All Kings are of course stops, also the seven of diamonds; also the cards next below the dealt stops, and the cards next below the played cards. After a stop the played cards are turned over, and the player of the stop (the card last played) leads again. The player who gets rid of all his cards first takes the counters in "Game," and receives a counter from each player for every card left in his hand, except from the player who may hold Pope but has not played it. The player of Ace, King, Queen or Knave of trumps takes the counters from that compartment. If King and Queen of trumps are in one hand, the holder takes the counters in "Matrimony"; if a Queen and Knave, those in "Intrigue"; if all three, those in the two compartments; if they are in different hands these counters are sometimes divided. Unclaimed stakes are left for the next pool. Pope is sometimes considered a universal "stop."

POPERINGHE, an ancient town of West Flanders, 12 m. W. of Ypres. Pop. (1904), 11,680. It contains a fine church of the 11th century, dedicated to St Betin. In the 14th century it promised to become one of the principal communes in Flanders; but having incurred the resentment of Ypres on a matter of trade rivalry it was attacked and captured by the citizens of that place, who reduced it to a very subordinate position. There are extensive hop gardens, bleaching grounds and tanneries in the neighbourhood of the town.

POPHAM, SIR HOME RIGGS (1762-1820), British admiral, was the son of Stephen Popham, consul at Tetuan, and was his mother's twenty-first child. He entered the navy in 1778, and served with the flag of Rodney till the end of the war. In 1783 he was promoted lieutenant, and was for a time engaged on survey service on the coast of Africa. Between 1787 and 1793 he was engaged in a curious series of adventures of a commercial nature in the Eastern Sea—sailing first for the Imperial Ostend Company, and then in a vessel which he purchased and in part loaded himself. During this time he took several surveys and rendered some services to the East India Company, which were officially acknowledged; but in 1793 his ship was seized, partly

on the ground that he was carrying contraband and partly because he was infringing the East India Company's monopoly. His loss was put at £70,000, and he was entangled in litigation. In 1805 he obtained compensation to the amount of £25,000. The case was a hard one, for he was undoubtedly sailing with the knowledge of officials in India. While this dispute was going on Popham had resumed his career as a naval officer. He served with the army under the duke of York in Flanders as "superintendent of Inland Navigation" and won his confidence. The protection of the duke was exercised with so much effect that Popham was promoted commander in 1794 and post captain in 1795. He was now engaged for years in co-operating in a naval capacity with the troops of Great Britain and her allies. In the Red Sea he was engaged in transporting the Indian troops employed in the expulsion of the French from Egypt. His bills for the repair of his ship at Calcutta were made the excuse for an attack on him and for charging him with the amount. It was just the time of the general reform of the dockyards, and there was much suspicion in the air. It was also the case that St Vincent did not like Popham, and that Benjamin Tucker (1762-1820), secretary to the admiralty, who had been the admiral's secretary, was his creature and sycophant. Popham was not the man to be snuffed out without an effort. He brought his case before Parliament, and was able to prove that there had been, if not deliberate dishonesty, at least the very grossest carelessness on the part of his assailants. In 1806 he co-operated with Sir David Baird in the occupation of the Cape. He then persuaded the authorities that, as the Spanish Colonies were discontented, it would be easy to promote a rising in Buenos Ayres. The attempt was made with Popham's squadron and 1,400 soldiers; but the Spanish colonists, though discontented, were not disposed to accept British help, which would in all probability have been made an excuse for establishing dominion. They rose on the soldiers who landed, and took them prisoners. Popham was recalled, and censured by a court martial for leaving his station; but the City of London presented him with a sword of honour for his endeavours to "open new markets," and the sentence did him no harm. He held other commands in connexion with the movements of troops, was promoted rear admiral in 1814, and made K.C.B. in 1815. He died at Cheltenham on the 10th of September 1820, leaving a large family. Popham was one of the most scientific seamen of his time. He did much useful survey work, and was the author of the code of signals adopted by the admiralty in 1803 and used for many years.

POPHAM, SIR JOHN (c. 1531-1607), English judge, was born at Huntworth, in Somerset, about 1531. He was educated at Balliol College, Oxford, and called to the bar at the Middle Temple. Concerning his early life little is known, but he was probably a member of the parliament of 1558. He was recorder of Bristol, and represented that city in parliament in 1571 and from 1572 to 1583. He was elected Speaker in 1580, and in 1581 became attorney-general, a post which he occupied until his appointment as lord chief justice in 1592. He presided at the trials of Sir Walter Raleigh and Guy Fawkes. Towards the end of his life Popham took a great interest in colonization, and was instrumental in procuring patents for the London and Plymouth companies for the colonization of Virginia. Popham was an advocate, too, of transportation abroad as a means of punishing rogues and vagabonds. His experiment in that direction, the Popham colony, an expedition under the leadership of his brother George (c. 1550-1608), had, however, but a brief career in its settlement (1607) on the Kennebec river. Popham died on the 10th of June 1607, and was buried at Wellington, Somerset.

See Foss, *Lives of the Judges*; J. Winsor, *History of America*, vol. iii.

POPILIA (or **POPILLIA**), **VIA**, the name of two ancient roads in Italy. (1) A highroad running from the Via Appia at Capua to Regium, a distance of 321 m. right along the length of the peninsula, and the main road through the interior of the country, not along the coast. It was built in 159 B.C. by the censor M. Popilius Laenias or in 132 B.C. by the consul P. Popilius. (2) A

highroad from Ariminum to Aquileia along the Adriatic coast. It no doubt originally came into use when Aquileia was founded as a frontier fortress of Italy in 181 B.C., and Polybius gives the distance correctly as 178 m. In 132 it was reconstructed (*munita*) by the consul P. Popilius, one of whose milestones has been found near Atria. It ran along the shore strip (Lido) from Ariminum to Ravenna (33 m.), where it was usual in imperial times for travellers to take ship and go by canal to Altinum (*q.v.*), and there resume their journey by road, though we find the stations right through on the Tabula Peutingeriana, and Narses marched in 552 from Aquileia to Ravenna. (T. As.)

POPINJAY (O. Fr. *papegai*, or *popingay*, onomatopoeic, original), an old name for a parrot. Except in its transferred sense of a dressed-up, vain or conceited, empty-headed person, the word is now only used historically of a representation or image of a parrot swinging from a high pole and used as a mark for archery or shooting matches. This shooting at the popinjay (see **ARCHERY**) was formerly a favourite sport. "Popinjay" is still the proper heraldic term for a parrot as a bearing or charge.

POPLAR, an eastern metropolitan borough of London, England, bounded N. by Hackney, S. by the river Thames, and W. by Stepney and Bethnal Green, and extending E. to the boundary of the county of London. Pop. (1901), 168,822. The river Lea, which the eastern boundary generally follows, is believed to have been crossed towards the north of the modern borough by a Roman road, the existence of which is recalled by the district-name of Old Ford; while Bow (formerly Stratford-le-Bow or Stratford-atte-Bowe) was so named from the "bow" or arched bridge which took the place of the ford in the time of Henry II. South of these districts lies Bromley; in the south-east the borough includes Blackwall; and a deep southward bend of the Thames here embraces the Isle of Dogs. Poplar falls within the great area commonly associated with a poor and densely crowded population under the name of the "East End." It is a district of narrow, squalid streets and mean houses, among which, however, the march of modern improvement may be seen in the erection of model dwellings, mission houses and churches, and various public buildings. In the north a part of Victoria Park is included. In Blackwall and the Isle of Dogs streets give place to the extensive East and West India Docks (opened in 1806) and Millwall Dock, with shipbuilding, engineering, chemical and other works along the river. Blackwall has been a shipping centre from early times. From the south of the Isle of Dogs (the portion called Cubitt Town) a tunnel for foot-passengers (1902) connects with Greenwich on the opposite shore of the Thames, and lower down the river is the fine Blackwall tunnel, carrying a wide roadway, completed by the London County Council in 1897 at a cost, inclusive of incidental expenses, of £1,383,502. Among institutions the Poplar Accidents Hospital may be mentioned. Near the East India Docks is the settlement of St Frideswide, supported by Christ Church, Oxford. In Canning Town, which continues this district of poverty across the Lea, and so outside the county of London, are Mansfield House, founded from Mansfield College, Oxford; and a Women's Settlement, especially notable for its medical work. The metropolitan borough of Poplar includes the Bow and Bromley and the Poplar divisions of the Tower Hamlets parliamentary borough, each returning one member. The borough council consists of a mayor, 7 aldermen and 42 councillors. Area, 2327.7 acres.

POPLAR (Lat. *Populus*), the name of a small group of catkin-bearing trees belonging to the order *Salicaceae*. The catkins of the poplars differ from those of the nearly allied willows in the presence of a rudimentary perianth, of obliquely cup-shaped form, within the toothed bracteal scales; the male flowers contain from eight to thirty stamens; the fertile bear a one-celled (nearly divided) ovary, surmounted by the deeply cleft stigmas; the two-valved capsule contains several seeds, each furnished with a long tuft of silky or cotton-like hairs. The leaves are broader than in most willows, and are generally either deltoid or ovate in shape, often cordate at the base, and

frequently with slender petioles vertically flattened. Many of the species attain a large size, and all are of very rapid growth. The poplars are almost entirely confined to the north temperate zone, but a few approach or even pass its northern limit, and they are widely distributed within that area; they show, like the willows, a partiality for moist ground and often line the river-sides in otherwise treeless districts. There are about twenty species, but the number cannot be very accurately defined—several, usually regarded as distinct, being probably merely variable forms of the same type, and the ease with which the trees intercross has led to the appearance of many hybrids. All yield a soft, easily-worked timber, which, though very perishable when exposed to weather, possesses sufficient durability when kept dry to give the trees a certain economic value. Many of the species are used for paper-making.

Of the European kinds one of the most important and best marked forms is the white poplar or abele, *P. alba*, a tree of large size, with rounded spreading head and curved branches, which, like the trunk, are covered with a greyish white bark, becoming much furrowed on old stems. The leaves are ovate or nearly round in general outline, but with deeply waved, more or less lobed and indented margins and cordate base; the upper side is of a dark green tint, but the lower surface is clothed with a dense white down, which likewise covers the young shoots—giving, with the bark, a hoary aspect to the whole tree. As in all poplars, the catkins expand in early spring, long before the leaves unfold; the ovaries bear four linear stigma lobes; the capsules ripen in May. A nearly related form, which may be regarded as a sub-species, *canescens*, the grey poplar of the nurseryman, is distinguished from the true abele by its smaller, less deeply cut leaves, which are grey on the upper side, but not so hoary beneath as those of *P. alba*; the pistil has eight stigma lobes. Both trees occasionally attain a height of 90 ft. or more, but rarely continue to form sound timber beyond the first half-century of growth, though the trunk will sometimes endure for a hundred and fifty years. The wood is very white, and, from its soft and even grain, is employed by turners and toy-makers, while, being tough and little liable to split, it is also serviceable for the construction of packing cases, the lining of carts and waggons, and many similar purposes; when thoroughly seasoned it makes good flooring planks, but shrinks much in drying, weighing about 58 lb per cubic foot when green, but only 33½ lb when dry. The white poplar is an ornamental tree, from its graceful though somewhat irregular growth and its dense hoary foliage; it has, however, the disadvantage of throwing up numerous suckers for some yards around the trunk.

The grey and white poplars are usually multiplied by long cuttings; the growth is so rapid in a moist loamy soil that, according to Loudon, cuttings 9 ft. in length, planted beside a stream, formed in twelve years trunks 10 in. in diameter. Both these allied forms occur throughout central and southern Europe, but, though now abundant in England, it is doubtful whether they are there indigenous. *P. alba* suffers much from the ravages of wood-eating larvae, and also from fungoid growths, especially where the branches have been removed by pruning or accident.

P. nigra, the black poplar, is a tree of large growth, with dark, deeply-furrowed bark on the trunk, and ash-coloured branches; the smooth deltoid leaves, serrated regularly on the margin, are of the deep green tint which has given name to the tree; the petioles, slightly compressed, are only about half the length of the leaves. The black poplar is common in central and southern Europe and in some of the adjacent parts of Asia, but, though abundantly planted in Britain, is not there indigenous. The wood is of a yellowish tint. In former days this was the prevalent poplar in Britain, and the timber was employed for the purposes to which that of other species is applied, but has been superseded by *P. monilifera* and its varieties; it probably furnished the poplar wood of the Romans, which, from its lightness and soft tough grain, was in esteem for shield-making; in continental Europe it is still in some request; the bark, in Russia, is used for tanning leather, while in Kamchatka it is sometimes

ground up and mixed with meal; the gum secreted by the buds was employed by the old herbalists for various medicinal purposes, but is probably nearly inert; the cotton-like down of the seed has been converted into a kind of vegetable felt, and has also been used in paper-making. A closely related form is the well-known Lombardy poplar, *P. fastigiata*, remarkable for its tall, cypress-like shape, caused by the nearly vertical growth of the branches. Probably a mere variety of the black poplar, its native land appears to have been Persia or some neighbouring country; it was unknown in Italy in the days of Pliny, while from remote times it has been an inhabitant of Kashmir, the Punjab, and Persia, where it is often planted along roadsides for the purpose of shade; it was probably brought from these countries to southern Europe, and derives its popular name from its abundance along the banks of the Po and other rivers of Lombardy, where it is said now to spring up naturally from seed, like the indigenous black poplar. It was introduced into France in 1749, and appears to have been grown in Germany and Britain soon after the middle of the last century, if not earlier. The Lombardy poplar is valuable chiefly as an ornamental tree, its timber being of very inferior quality; its tall, erect growth renders it useful to the landscape-gardener as a relief to the rounded forms of other trees, or in contrast to the horizontal lines of the lake or river-bank where it delights to grow. In Lombardy and France tall hedges are sometimes formed of this poplar for shelter or shade, while in the suburban parks of Britain it is serviceable as a screen for hiding buildings or other unsightly objects from view; its growth is extremely rapid, and it often attains a height of 100 ft. and upwards, while from 70 to 80 ft. is an ordinary size in favourable situations.

P. canadensis, the "cotton-wood" of the western prairies, and its varieties are perhaps the most useful trees of the genus, often forming almost the only arborescent vegetation on the great American plains. It is a tree of rather large growth, sometimes 100 ft. high, with rugged grey trunk 7 or 8 ft. in diameter, and with the shoots or young branches more or less angular; the glossy deltoid leaves are sharply pointed, somewhat cordate at the base, and with flattened petioles; the fertile catkins ripen about the middle of June, when their opening capsules discharge the cottony seeds which have given the tree its common western name; in New England it is sometimes called the "river poplar." The cotton-wood timber, though soft and perishable, is of value in its prairie habitats, where it is frequently the only available wood either for carpentry or fuel; it has been planted to a considerable extent in some parts of Europe, but in England a form of this species known as *P. monilifera* is generally preferred from its larger and more rapid growth. In this well-known variety the young shoots are but slightly angled, and the branches in the second year become round; the deltoid short-pointed leaves are usually straight or even rounded at the base, but sometimes are slightly cordate; the capsules ripen in Britain about the middle of May. This tree is of extremely rapid growth, and has been known to attain a height of 70 ft. in sixteen years; it succeeds best in deep loamy soil, but will flourish in nearly any moist but well-drained situation. The timber is much used in some rural districts for flooring, and is durable for indoor purposes when protected from dry-rot; it has, like most poplar woods, the property of resisting fire better than other timber. The native country of this form has been much disputed; but, though still known in many British nurseries as the "black Italian poplar," it is now well ascertained to be an indigenous tree in many parts of Canada and the States, and is a mere variety of *P. canadensis*; it seems to have been first brought to England from Canada in 1772. In America it seldom attains the large size it often acquires in England, and it is there of less rapid growth than the prevailing form of the western plains; the name of "cotton-wood" is locally given to other species. *P. macrophylla* or *candicans*, commonly known as the Ontario poplar, is remarkable for its very large heart-shaped leaves, sometimes 10 in. long; it is found in New England and the milder parts of Canada, and is frequently planted in Britain; its growth is extremely rapid in moist land; the buds are covered with a balsamic secretion. The true balsam poplar, or tacamahac, *P. balsamifera*, abundant in most parts of Canada and the northern States, is a tree of rather large growth, often of somewhat fastigiate habit, with round shoots and oblong-ovate sharp-pointed leaves, the base never cordate, the petioles round, and the disk deep glossy green above but somewhat downy below. This tree, the "liard" of the Canadian voyageur, abounds on many of the river sides of the north-western plains; it occurs in the neighbourhood of the Great Slave Lake and along the Mackenzie River, and forms much of the drift-wood of the Arctic coast. In these northern habitats it attains a large size; the wood is very soft; the buds yield a gum-like balsam,

from which the common name is derived; considered valuable as an antiscorbutic, this is said also to have diuretic properties; it was formerly imported into Europe in small quantities under the name of "baume focot," being scraped off in the spring and put into shells. This balsam gives the tree a fragrant odour when the leaves are unfolding. The tree grows well in Britain, and acquires occasionally a considerable size. Its fragrant shoots and the fine yellow green of the young leaves recommend it to the ornamental planter. It is said by Aiton to have been introduced into Britain about the end of the 17th century.

P. euphratica, believed to be the weeping willow of the Scriptures, is a large tree remarkable for the variability in the shape of its leaves, which are linear in young trees and vigorous shoots, and broad and ovate on older branches. It is a native of North Africa and Western and Central Asia, including North-West India. With the date palm it is believed to have furnished the rafters for the buildings of Nineveh.

POPLIN, or **TABINET**, a mixed textile fabric consisting of a silk warp with a weft of worsted yarn. As the weft is in the form of a stout cord the fabric has a ridged structure, like rep, which gives depth and softness to the lustre of the silky surface. Poplins are used for dress purposes, and for rich upholstery work. The manufacture is of French origin; but it was brought to England by the Huguenots, and has long been specially associated with Ireland. The French manufacturers distinguish between *popelines unies* or plain poplins and *popelines à dispositions* or *Écossaises*, equivalent to Scotch tartans, in both of which a large trade is done with the United States from Lyons.

POPOCATEPETL (Aztec *popoca* "to smoke," *tepetl* "mountain"), a dormant volcano in Mexico in lat. 18° 59' 47" N., long. 98° 33' 1" W., which with the neighbouring Ixtaccihuatl (Aztec "white woman") forms the south-eastern limit of the great basin known as the "Valley of Mexico." As it lies in the state of Puebla and is the dominating feature in the views from the city of that name, it is sometimes called the Puebla volcano. It is the second highest summit in Mexico, its shapely, snow-covered cone rising to a height of 17,876 ft., or 438 ft. short of that of Orizaba. This elevation was reported by the Mexican geological survey in 1895, and as the Mexican Geographical Society calculated the elevation at 17,888 ft., it may be accepted as nearly correct. The bulk of the mountain consists of andesite, but porphyry, obsidian, trachyte, basalt, and other similar rocks are also represented. It has a stratified cone showing a long period of activity. At the foot of the eastern slope stretches a vast lava field—the "malpays" (*malapais*) of Atlachayacatl—which, according to Humboldt, lies 60 to 80 ft. above the plain and extends 18,000 ft. east to west with a breadth of 6000 ft. Its formation must be of great antiquity. The ascent of Popocatepetl is made on the north-eastern slope, where rough roads are kept open by sulphur carriers and timber cutters. Describing his ascent in 1904, Hans Gadov states that the forested region begins in the foothills a little above 8000 ft., and continues up the slope to an elevation of over 13,000 ft. On the lower slopes the forest is composed in great part of the long-leaved *Pinus loophylla*, accompanied by deciduous oaks and a variety of other trees and shrubs. From about 9500 ft. to 11,500 ft. the Mexican "oyamel," or fir (*Abies religiosa*) becomes the principal species, interspersed with evergreen oak, arbutus and elder. Above this belt the firs gradually disappear and are succeeded by the short-leaved *Pinus montezumae*, or Mexican "ocote"—one of the largest species of pine in the republic. These continue to the upper tree-line, accompanied by red and purple *Pentstemon* and light blue lupins in the open spaces, some ferns, and occasional masses of alpine flowers. Above the tree line the vegetation continues only a comparatively short distance, consisting chiefly of tussocks of coarse grass, and occasional flowering plants, the highest noted being a little *Draba*. At about 14,500 ft. horses are left behind, though they could be forced farther up through the loose lava and ashes. On the snow-covered cone the heat of the sun is intense, though the thermometer recorded a temperature of 34° in September. The reflection of light from the snow is blinding. The rim of the crater is reached at an elevation of about 17,500 ft. Another description places the snow-line at 14,268 ft., and the upper tree-line

a thousand feet lower. A detailed description of the volcano was published by the Mexican geological survey in 1895 according to which the crater is elliptical in form, 2008 by 1312 ft., and has a depth of 1657 ft. below the summit of the highest pinnacle and 673 ft. below the lowest part of the rim, which is very irregular in height. The steep, ragged walls of the crater show a great variety of colours, intensified by the light from the deep blue sky above. Huge patches of sulphur, some still smouldering, are everywhere visible, intermingled with the white streaks of snow and ice that fill the crevices and cover the ledges of the black rocks. The water from the melted snow forms a small lake at the bottom of the crater, from which it filters through fissures to the heated rocks below and thence escapes as steam or through other fissures to the mineral springs at the mountain's base. The Indian sulphur miners go down by means of ladders, or are lowered by rope and windlass, and the mineral is sent down the mountain side in a chute 2000 to 3000 ft. Some observers report that steam is to be seen rising from fissures in the bottom of the crater, and all are united in speaking of the fumes of burning sulphur that rise from its depths. That volcanic influences are still present may be inferred from the circumstance that the snow cap on Popocatepetl disappeared just before the remarkable series of earthquakes that shook the whole of central Mexico on the 30th and 31st of July 1909.

It is believed that Diego de Ordaz was the first European to reach the summit of Popocatepetl, though no proof of this remains further than that Cortés sent a party of ten men in 1519 to ascend a burning mountain. In 1522 Francisco Montañó made the ascent and had himself let down into the crater a depth of 400 or 500 ft. No second ascent is recorded until April and November 1827 (see Brantz Mayer, *Mexico*, vol. ii.). Other ascents were made in 1834, 1848 and subsequent years, members of the Mexican geological survey spending two days on the summit in 1895.

POPPER, DAVID (1846–), Bohemian violoncellist, was born at Prague, and educated musically at the conservatorium there, adopting the 'cello as his professional instrument. He was soon recognized, largely through von Bülow, as one of the finest soloists of the time, and played on tours throughout the European capitals. In 1872 he married the pianist Sophi Menter, from whom he was separated in 1886. In 1896 he became professor at the Royal Conservatoire at Budapest. He published various works, mainly compositions for the 'cello, together with four volumes of studies arranged as a violoncello school.

POPPO, ERNST FRIEDRICH (1794–1866), German classical scholar and schoolmaster, was born at Guben in Brandenburg on the 13th of August, 1794. In 1818 he was appointed director of the gymnasium at Frankfort-on-the-Oder, where he died on the 6th of November 1866, having resigned his post three years before. Poppo was an extremely successful teacher and organizer, and in a few years doubled the number of pupils at the gymnasium. He is chiefly known, however, for his exhaustive and complete edition of Thucydides in four parts (11 vols., 1821–1840), containing (i.) *prolegomena* on Thucydides as an historian and on his language and style (Eng. trans. by G. Burges, 1837), accompanied by historical and geographical essays; (ii.) text with *scholia* and critical notes; (iii.) commentary on the text and *scholia*; (iv.) indices and appendices. For the ordinary student a smaller edition (1843–1851) was prepared, revised after the author's death by J. M. Stahl (1875–1889).

See R. Schwarze in *Allgemeine deutsche Biographie* and authorities there referred to.

POPPY, in botany, a genus of plants known botanically as *papaver*, the type of the family or natural order Papaveraceae. They are annual and perennial erect herbs containing a milky juice, with lobed or cut leaves and generally long-stalked regular showy flowers, which are nodding in the bud stage. The sepals, very rarely three, which are two in number, fall off as the flower opens, the four (very rarely five or six) petals, which are crumpled in the bud stage, also fall readily. The numerous stamens surround the ovary, which is composed of 4 to 16 carpels

and is surmounted by a flat or convex rayed disk bearing the stigmas. The ovary is incompletely divided into many chambers by the ingrowth of the placentas which bear numerous ovules and form in the fruit a many-seeded short capsule opening by small valves below the upper edge. The valves are hydropscopic, responding to increase in the amount of moisture in the atmosphere by closing the apertures. In dry weather the valves open, and the small seeds are ejected through the pores when the capsule is shaken by the wind on its long stiff slender stalk. The flowers contain no honey and are visited by pollen-seeking insects, which alight on the broad stigmatic surface. The genus contains about 40 species, mostly natives of central and south Europe and temperate Asia. Five species are British; *P. Rhoeas* is the common scarlet poppy found in cornfields and waste places. Cultivated forms of this, with exquisite shades of colour and without any blotch at the base of the petals, are known as Shirley poppies. *P. somniferum*, the opium poppy, with large white or blue-purple flowers, is widely cultivated (see OPIUM). The Oriental poppy (*P. orientale*) and its several varieties are fine garden plants, having huge bright crimson flowers with black blotches at the base. Many hybrid forms of varying shades of colour have been raised of late years. The Iceland poppy (*P. undicaule*), is one of the showiest species, having grey-green pinnate leaves and flowers varying in colour from pure white to deep orange-yellow, orange-scarlet, &c. Specially fine varieties with stalks 18–24 in. high are cultivated on a large scale by some growers for market. The Welsh poppy belongs to an allied genus, *Meconopsis*; it is a perennial herb with a yellow juice and pale yellow poppy-like flowers. It is native in the south-west and north of England, and in Wales; also in Ireland. The prickly poppy (*Argemone grandiflora*) is a fine Mexican perennial with large white flowers.

To the same family belongs the horned poppy, *Glaucium luteum*, found in sandy sea-shores and characterized by the waxy bloom of its leaves and large golden-yellow short-stalked flowers. Another member of the family is *Eschscholtzia californica*, a native of western North America, and well-known in gardens, with orange-coloured flowers and a long two-valved fruit pod.

The plume poppy (*Bocconia cordata* and *B. microcarpa*) are ornamental foliage plants of great beauty. The cyclamen poppy (*Eomecon chionantha*) is a pretty Chinese perennial, having roundish slightly lobed leaves and pure white flowers about 2 in. across. The tree poppy (*Dendromecon rigidum*) is a Californian shrub about 3 ft. high, having golden-yellow flowers about 2 in. across. The Californian poppy (*Platystemon californicus*) is a pretty annual about a foot high, having yellow flowers with 3 sepals and 6 petals; and the white bush poppy (*Romneya Coulteri*) is a very attractive perennial and semi-shrubby plant 2–3 ft. high, with pinnatifid leaves and large sweet scented white flowers often 6 in. across.

POPPY HEADS, a term, in architecture, given to the finials or other ornaments which terminate the tops of bench ends, either to pews or stalls. They are sometimes small human heads, sometimes richly carved images, knots of foliage or finials, and sometimes *fleurs-de-lis* simply cut out of the thickness of the bench end and chamfered. The term is probably derived from the French *poupée*, doll, puppet, used also in this sense, or from the flower, from a resemblance in shape.

POPPY OIL (*Oleum papaveris*), a vegetable oil obtained by pressure from the minute seeds of the garden or opium poppy, *Papaver somniferum*. The white-seeded and black-seeded varieties are both used for oil-pressing; but, when the production of oil is the principal object of the culture, the black seed is usually preferred. The qualities of the oil yielded by both varieties and the proportion they contain (from 50 to 60%) are the same. By cold pressing seeds of fine quality yield from 30 to 40% of virgin or white oil (*huile blanche*), a transparent limpid fluid with a slight yellowish tinge, bland and pleasant to taste, and with almost no perceptible smell. On second pressure with the aid of heat an additional 20 to 25% of inferior oil (*huile de fabrique* or *huile russe*) is obtained, reddish in colour, possessed

of a biting taste, and a linseed-like smell. The oil belongs to the linoleic or drying series, having as its principal constituent linolein; and it possesses greater drying power than raw linseed oil. Its specific gravity at 15° C. is 0.925. Poppy oil is a valuable and much used medium for artistic oil painting. The fine qualities are largely used in the north of France (*huile d'aillette*) and in Germany as a salad oil, and are less liable than olive oil to rancidity. The absence of taste and characteristic smell in poppy oil also leads to its being much used for adulterating olive oil. The inferior qualities are principally consumed in soap-making and varnish-making, and for burning in lamps. The oil is very extensively used in the valley of the Ganges and other opium regions for food and domestic purposes. By native methods in India about 30% of oil is extracted, and the remaining oleaginous cake is used as food by the poor. Ordinary poppy-oil cake is a valuable feeding material, rich in nitrogenous constituents, with an ash showing an unusually large proportion of phosphoric acid. The seed of the yellow horned poppy, *Glaucium luteum*, yields from 30 to 35% of an oil having the same drying and other properties as poppy oil; and from the Mexican poppy, *Argemone mexicana*, is obtained a non-drying oil used as a lubricant and for burning.

POPULATION (Lat. *populus*, people; *populare*, to populate), a term used in two different significations, (1) for the total number of human beings existing within certain area at a given time, and (2) for the "peopling" of the area, or the influence of the various forces of which that number is the result. The population of a country, in the former sense of the word, is ascertained by means of a census (*q.v.*), which periodically records the number of people found in it on a certain date. Where, as is generally the case, detail of sex, age, conjugal condition and birthplace is included in the return, the census results can be co-ordinated with those of the parallel registration of marriages, births, deaths and migration, thus forming the basis of what are summarily termed *vital statistics*, the source of our information regarding the nature and causes of the process of "peopling," *i.e.* the movement of the population between one census and another. Neither of these two operations has yet reached perfection, either in scope or accuracy, though the census, being the subject of special and concentrated effort, is generally found the superior in the latter respect, and is in many cases taken in countries where registration has not yet been introduced. The countries where neither is in force are still, unfortunately, very numerous.

The Population of the World, and its Geographical Distribution.—Man is the only animal which has proved able to pass from dependence upon its environment to a greater or less control over it. He alone, accordingly, has spread over every quarter of the globe. The area and population of the world, as a whole, have been the subject of many estimates in scientific works for the last three centuries and are still to a considerable extent matters of rough approximation. Every decade, however, brings a diminution of the field of conjecture, as some form of civilized administration is extended over the more backward tracts, and is followed, in due course, by a survey and a census. It is not necessary, therefore, to cite the estimates framed before 1882, when a carefully revised summary was published by Boehm and H. Wagner. Since then the laborious investigations of P. F. Levasseur and L. Bodio have been completed in the case of Europe and America, and, for the rest of the world, the figures annually brought up to date in the *Statesman's Year Book* may be taken to be the best available. From these sources the abstract at foot of page has been derived.

The principal tracts still unmeasured and unenumerated (in any strict sense) in the Old World are the Turkish Empire, Persia, Afghanistan, China and the Indo-Chinese peninsula

and nearly nine-tenths of Africa. In the same category must be placed a considerable proportion of central, southern and Polar America (see CENSUS). There is little of the world which is entirely uninhabited; still less permanently uninhabitable and unlikely to be required to support a population in the course of the expansion of the race beyond its present abodes. Probably the polar regions alone do not fall within the category of the potentially productive, as even sandy and alkaline desert is rendered habitable where irrigation can be introduced; and vast tracts of fertile soil adapted for immediate exploitation, especially in the temperate zones, both north and south, only remain unpeopled because they are not yet wanted for colonization. The geographical distribution of the population of the world is therefore extremely irregular, and, omitting from consideration areas but recently colonized, the density is regulated by the means of subsistence within reach. "La population," says G. de Molinari, "a tendance de se proportionner à son débouché." These, in their turn, depend mainly upon the character of the people who inhabit the country. Even amongst savages there are few communities, and those but sparse, which subsist entirely upon what is directly provided by nature. As human intelligence and industry come into play the means of livelihood are proportionately extended; population multiplies, and with this multiplication production increases. Thus, the higher densities are found in the eastern hemisphere, within the zone in which arose the great civilizations of the world, or, roughly speaking, between north parallels 25 and 40 towards the east, and 25 and 55 in the west. Here large areas with a mean density of over 500 to the sq. m. may be found either supported by the food directly produced by themselves, as in the great agricultural plains of the middle kingdom of China and the Ganges valley and delta; or else, as in western Europe, relying largely upon food from abroad, purchased by the products of manufacturing industry. In the one class the density is mainly rural, in the other it is chiefly due to the concentration of the population into large urban aggregates. It is chiefly from the populations of the south-west of Europe that the New World is being colonized; but the territories over which the settlers and their recruits from abroad are able to scatter are so extensive that even the lower densities of the Old World have not yet been attained, except in a few tracts along the eastern coasts of Australia and North America. Details of area and population are given under the headings of the respective countries, and the only general point in connexion with the relation between these two facts which may be mentioned here is the need to bear in mind that the larger the territory the less likely is its mean density-figure to be typical or really representative. Even in the case of small and comparatively homogeneous countries such as Holland, Belgium or Saxony there is considerable deviation from the mean in the density of the respective component subdivisions, a difference which when extended over more numerous aggregates often renders the general mean misleading or of little value.

Distribution of Population by Sex.—After geographical dispersion, the most general feature amongst the human race is its division by sex. The number of speculations as to the nature of this distinction has been, it is said, well-nigh doubled since Drelincourt, in the 18th century, brought together 262 "groundless hypotheses," and propounded on his own part a theory

TABLE I.

Continent.	Sq. m. in thousands (1907).	Population, in thousands.		Population per sq. m. (1907).	Unascertained Percentage of:	
		1882.	1907.		Area un-surveyed.	Population Unenumerated.
Europe . . .	3,828*	327,743	405,759	106†	2.5*	1.3
Asia . . .	15,773	795,591	918,324	58	43.2	59.4
Africa . . .	11,507	205,823	126,734	11	90.1	77.4
America . . .	17,208*	100,415	149,944	9†	50.0*	9.1
Oceania . . .	3,448	4,232	5,881	1.7	5.4	19.6
Total . . .	51,764	1,433,804	1,606,542	31.7†	50.4*	41.4

* Including Polar regions.

† Excluding Polar regions.

which has since been held to be the 263rd in the series. It is not proposed to deal here with incidents appertaining to the "ante-natal gloom," and we are concerned only with human beings when once they have been born. In regard to the division of these into male and female, the first point to be noted is that, in all communities of western civilization, more boys are born than girls. The excess ranges from 20 to 60 per thousand. In Greece and Rumania it is exceptionally high, and in some Oriental or semi-Oriental countries it is said to give place to a deficit, though in the latter case the returns are probably not trustworthy. From the more accurate statistics available it appears that the excess of male births varies amongst different races and also at different times in the same community. It is high in new colonies and amongst the Latin races, with the exception of the French. These, with the English, show a much smaller excess of boy-births than the average of western Europe, and the proportion, moreover, seems to be somewhat declining in both these countries and in Belgium, from causes which have not yet been ascertained. As the mortality amongst boys, especially during the first year, is considerably above that of the other sex, numerical equilibrium between the two is established in early youth, and in most cases girls outnumber boys, except for a few years between twelve and sixteen. Then follows the chequered period of the prime of life and middle age, during which the liability of men to industrial accidents, war and other causes of special mortality, irrespective of their greater inclination to emigrate, is generally sufficient to outweigh the dangers of childbirth or premature decay among the women, who tend, accordingly, to predominate in number at this stage. In old age, again, their vitality rises superior to that of the men, and they continue to form the majority of the community. The general results are an excess of females over males throughout western Europe: but though the relative proportions vary from time to time, remaining always in favour of what is conventionally called the weaker sex, it is impossible, owing to disturbing factors like war and migration, to ascertain whether there is any general tendency for the proportion of females to increase or not. In comparatively new settlements, largely fed by immigration, the number of males is obviously likely to be greater than that of females, but in the case of countries in Asia and eastern Europe in which also a considerable deficiency of the latter sex is indicated by the returns, it is probable that the strict seclusion imposed by convention on women and the consequent reticence regarding them on the part of the householders answering the official inquiry tend towards a short count. On the other hand, the lower position there assigned to women and the very considerable amount of hard work exacted from them, may cause them to wear out earlier than under higher conditions, though not to the extent implied in the statistics. In the

TABLE II.

Country.	No. of females to 1000 males.	No. of girls born to 1000 boys.	Country.	No. of females to 1000 males.	No. of girls born to 1000 boys.
Sweden	1049	946	Galicia	1019	941
Norway	1064	944	Hungary	1009	949
Finland	1022	948	Rumania	964	902
Denmark	1053	950	Greece	921	879
England	1069	966	Servia	946	945
Scotland	1057	956	Bulgaria	959	927
Ireland	1028	946	Russia		
Holland	1025	950	(Europe)	1011	948
Belgium	1013	956	Russia (Asia)	893	—
Germany	1029	950	Japan	983	—
Austria	1042	947	India	963	—
France	1033	960	Egypt	967	—
Italy	1011	947	United States	958	—
Spain	1049	938	Canada	952	—
Portugal	1093	899	Argentina	893	—
			Cape Colony	977	—
			Australia	906	950
			New Zealand	900	—

following table the latest available information on this head is given for representative countries of western and eastern Europe, the East and the New World.

Distribution by Age.—Few facts are more uncertain about an individual than the number of years he will live. Few, on the contrary, as was pointed out by C. Babbage, are less subject to fluctuation than the duration of life amongst people taken in large aggregates. The age-constitution of a community does indeed vary, and to a considerable extent, in course of time, but the changes are usually gradual, and often spread over a generation or more. At the same time, it must be admitted that those which have recently taken place amongst most of the communities of western Europe are remarkable for both their rapidity and their extent; and are probably attributable, in part at least, to influences which were almost inoperative at the time when Babbage wrote. The distribution of a population amongst the different periods of life is regulated, in normal circumstances, by the birth-rate, and, as the mortality at some of the periods is far greater than at others, the death-rate falls indirectly under the same influence. The statistics of age, therefore, may be said to form a link between those of the population, considered as a fixed quantity, as at a census, and those which record its movement from year to year. To the correct interpretation of the latter, indeed, they are essential, as will appear below. Unfortunately, the return of age is amongst the less satisfactory results of a general enumeration, though its inaccuracy, when spread over millions of persons, is susceptible of correction mathematically, to an extent to make it serve its purpose in the directions above indicated. The error in the original return generally arises from ignorance. An illiterate population is very prone to state its age in even multiples of five, and even where education is widely spread this tendency is not altogether absent, as may be seen from the examples given in

TABLE III.

Age.	Number returned at each age per 10,000 of Population.					
	Germany, 1900.	United States, 1900.		Russia, 1897.		India, 1891 Females.
		Native Whites.	Negroes.	Europe.	Asia, Females.	
19	180	196	204	166	112	64
20	182	200	252	223	385	505
21	181	191	204	143	113	54
29	130	146	119	92	60	42
30	149	170	218	269	456	624
31	145	125	76	74	74	30
49	88	72	62	45	38	12
50	94	84	156	196	257	386
51	89	61	38	35	34	12
59	62	43	30	25	18	10
60	70	49	105	163	179	281
61	60	33	15	22	25	11

Table III. Deliberate mis-statements, too, are not unknown, especially amongst women. This has been repeatedly illustrated in the English census reports. Irrespective of the wish of women between 25 and 40 to return themselves as under 25, there appears to be the more practical motive of obtaining better terms in industrial insurance, whilst an overstatement of age often has, it is said, the object of getting better wages in domestic service, or better dietary in the workhouse! In all countries, moreover, there seems to be an inclination to exaggerate longevity after the three score years and ten have been passed. In order to minimize the results of such inaccuracy, the return of ages is compiled in aggregates of five or ten years and then redistributed over single years by the method of differences. The present purpose being merely to illustrate the variation of distribution amongst a few representative countries, it is unnecessary to enter into more detail than such as will serve to distinguish the proportions of the population in main divisions of life. Thus it may be said that in the west of Europe about one-third of the people, roughly speaking, are under fifteen; about one-half, between that age and fifty, and the remaining sixth older than fifty. The middle period

may conveniently be extended to sixty and subdivided at forty, as is done in Table IV. The differences between the several countries in their age-constitution can best be appreciated by reference to some recognized general standard. The one here adopted is the result of the co-ordination of a long series of enumerations taken in Sweden during the last century and a half, prepared by Dr G. Sundbärg of Stockholm. It is true that for practical use in connexion with vital statistics for a given period, the aggregate age-distribution of the countries concerned would be a more accurate basis of comparison, but the wide period covered by the Swedish observations has the advantage of eliminating temporary disturbances of the balance of ages, and may thus be held to compensate for the comparatively narrow geographical extent of the field to which it relates.

TABLE IV.

Country.	Census Year.	Per 1000 of Population.			
		Under 15.	15-40.	40-60.	Over 60.
<i>Standard</i>	—	336	389	192	83
Sweden	1900	324	366	191	119
Norway	"	354	361	176	109
Finland	"	345	386	187	82
Denmark	"	339	376	186	99
England	1901	324	423	179	74
Scotland	"	334	416	173	77
Ireland	"	304	407	180	109
Holland	1899	348	384	175	93
Belgium	1900	317	404	184	95
Germany	"	348	395	179	78
Austria	"	344	402	182	72
France	1901	261	389	226	124
Italy	"	341	366	196	97
Portugal	1900	338	375	191	96
Galicia	"	377	399	178	46
Hungary	"	356	379	189	76
Servia	"	419	395	142	44
Bulgaria	"	414	322	172	92
Greece	1889	393	400	155	52
Russia (Europe)	1897	350	385	180	85
India (males)	1891	391	399	163	47
Japan	1898	335	384	193	88
United States	1900	334	422	169	75
Canada	1901	346	409	168	77
Australasia	"	349	431	157	63
Cape Colony	1904	415	409	129	47

As regards correspondence with the standard distribution, it will be noted that Finland, the next country to Sweden geographically, comes after Japan, far detached from northern Europe by both race and distance, and is followed by Portugal, where the conditions are also very dissimilar. The other Scandinavian countries, Norway and Denmark, appear, like Sweden itself in the present day, to bear in their age-distribution distinct marks of the emigration of adults, or, at least, the temporary absence from home of this class at the time of enumeration. The same can be said of Italy in its later returns and of Germany in those before 1895. On the contrary, the effect of the inflow of adult migrants is very marked, as is to be expected, in the returns for the new countries, such as the United States, Canada and Australasia. In the case of the Old World, the divergence from the standard which most deserves notice is the remarkable preponderance of the young in all the countries of eastern Europe, as well as in India, accompanied by an equally notable deficiency of the older elements in the population. Again, there are in the west two well-known instances of deficient reinforcement of the young, France and Ireland, in which countries the proportion of those under 15 falls respectively 75 and 32 per mille below the standard; throwing those over 60 up to 41 and 26 per mille above it. The table does not include figures for earlier enumerations, but one general character-

istic in them should be mentioned, viz. the far higher proportion borne in them of the young, as compared with the more recent returns. In England, for instance, those under 15 amounted to 360 per mille in 1841, against 324 sixty years later. In Ireland the corresponding fall has been still more marked, from 382 to 304. The ratio in France was low throughout the 19th century, and during the last half fell only from 273 to 261, raising the proportion of the old above that resulting in northern Europe and Italy from emigration. It is remarkable that the same tendency for the proportion of the young to fall off is perceptible in new countries as well as in the older civilizations, setting aside the influence of immigration at the prime of life in depressing the proportion of children. The possible causes of this widespread tendency of the mean age of a western community to increase appertain to the subject of the movement of the population, which is dealt with below.

The Movement of Population.—"The true greatness of a State" says Bacon, "consisteth essentially in population and breed of men"; and an increasing population is one of the most certain signs of the well-being of a community. Successive accretions, however, being spread over so long a term as that of human life, it does not follow that the population at any given time is necessarily the result of *contemporary* prosperity. Conversely, the traces left by a casual set-back, such as famine, war, or an epidemic disease, remain long after it has been succeeded by a period of recuperation, and are to be found in the age-constitution and the current vital statistics. Population is continually in a state of motion, and in large aggregates the direction is invariably towards increase. The forces underlying the movement may differ from time to time in their respective intensity, and, in highly exceptional cases, may approach equilibrium, their natural tendencies being interrupted by special causes, but the instances of general decline are confined to wild and comparatively small communities brought into contact with alien and more civilized races. The factors upon which the growth of a population depend are internal, operating within the community, or external, arising out of the relations of the community with other countries. In the latter case, population already in existence is transferred from one territory to another by migration, a subject which will be referred to later. Far more important is the vegetative, or "natural" increase, through the excess of births over deaths. The principal influences upon this, in civilized life, are the number of the married, the age at which they marry or bear children, the fertility of marriages and the duration of life, each of which is in some way or other connected with the others.

Marriage.—In every country a small and generally diminishing proportion of the children is born out of wedlock, but the primary regulator of the native growth of a community is the institution of marriage. Wherever, it has been said, there is room for two to live up to the conventional standard of comfort, a marriage takes place. So close, indeed, up to recent times, was the connexion held to be between the prosperity of the country and the number of marriages, that Dr W. Farr used to call the latter the barometer of the former. The experience of the present generation, however, both in England and other countries, seems to justify some relaxation of that view, as will appear below. The tendency of a community towards matrimony, or its "nuptiality," as it is sometimes termed, is usually indicated by the ratio to the total population of the persons married each year. For the purpose of comparing the circumstances of the same community at successive periods this method is fairly trustworthy, assuming that there has been no material shifting of the age-proportions during the intervals. It is not a safe guide, however, when applied to the comparison of different communities, the age-composition of which is probably by no means identical, but in consideration of its familiarity it has been adopted in the first section of Table V. below, at three periods for each of the countries selected as representative.

One of the features which is prominent throughout the return is that in every country except Belgium the rate per mille attained a maximum in the early seventies, and has since shown

a descending tendency, notwithstanding the fact, noted in the preceding paragraph, that the youthful population, which, of course, weighs down the rate, has also been relatively decreasing. Countries of Oriental and semi-Oriental habits have not been shown, owing to the difference in their marriage system from that of western Europe. It may be mentioned, however, in passing, that their marriage rate is generally considerably higher than that here indicated, as may be seen from the example of Galicia, which is here shown separately from cis-Leithian Austria.

years of age and decreases rapidly as that period is left behind. A Swedish return of 1896-1900 shows that the annual births per thousand wives of 20-25 are fewer by nearly 17% than those of wives under 20. Between 25 and 30 the number falls off by one-fifth, and after 40 by about 44%. In the countries mentioned in Table V. the average proportion borne by wives under 30 to the total under 45 is just over one-third. That proportion is exceeded in southern Europe, where women develop earlier, and in Galicia. In England and France it stands at

TABLE V.

Country.	Per 1000 of Population.						
	Persons Married Yearly.			Women, 15 to 45 (1900).			Men, 20-50.
	1861-1870.	1871-1875.	1895-1904.	Total.	Married.	Unmarried.	Unmarried.
Sweden	13.1	14.0	12.0	215	88	123	83
Norway	13.3	14.6	13.2	218	91	102	71
Finland	15.5	17.9	14.1	219	103	115	70
Denmark	14.9	15.9	14.6	221	104	111	81
England	16.7	17.1	15.8	250	117	127	77
Scotland	14.0	14.9	14.3	242	102	135	90
Ireland	10.5	10.7	10.1	235	76	153	125
Holland	16.4	16.6	14.9	218	96	118	82
Germany	17.0	18.9	16.4	226	114	107	76
Belgium	15.0	15.1	16.4	230	108	117	85
Austria (W.)	16.1	17.7	15.7	227	106	115	85
France	15.6	16.9	15.2	228	120	100	82
Italy	15.2	15.6	14.4	214	116	92	71
Galicia	19.7	19.7	17.6	225	125	94	67

In the opposite direction will be noted the case of Ireland, where the rate is abnormally low; and returns more recent than those included in the table show that of late the rates in Sweden and Norway have also fallen to but little above 11 per mille. In regard to the necessity of taking into consideration the factor of age in the return of marriage-rates, an example may be here given from the data for England. The rate taken upon the total population was 16.7 per mille in 1870-1871 and 15.3 in 1905; by excluding the population under fifteen the corresponding figures are 57.2 and 46.6 per mille. Thus the decline, which by the first method is only 8%, becomes, by the second, 19%; and if the age-distribution of 1905 were reduced to that of the earlier period, the difference would increase to 22%, the most accurate figure of the three. For the present purpose it is sufficient to connect the rate of marriage with that of births by using as a basis for the former the number of women of conceptive age, or between 15 and 45 years old. The proportion of these is given in the latter portion of the table. Again taking England as an example, the women of the above ages bore the proportion to the total population of 23% in 1871 and had risen to 25% in 1901; but at the former time, 49.6% were married, whilst thirty years later, only 46.8 were thus situated. The table also shows that the proportion of the women of the ages in question who were married exceeds half only in Italy, France and Germany, not to mention Galicia. In other countries the average proportion is about 45%. In Sweden and Norway it is only 41 and in Ireland less than a third. In Scandinavia, and perhaps in Italy, the rate may be affected by the emigration of adult males, but the later columns of the table indicate that this is not the cause of the low rate in Ireland, which appears to be mainly due to abstinence from marriage at the ages specified.

Next to the proportion of the married to the total marriageable the most important factor connected with the natural increase of the population is the age at which marriage takes place. Where the proportion of the married is high, the average age of the wives is low, and early marriage is conducive to relatively rapid increase. In the first place, the interval between generations is shortened, and the elder is contemporaneous with the younger for a longer period. Then, again, the fecundity of women amongst western peoples is at its maximum between 18 and 25

36. In Ireland and Sweden it is only 28, and in Denmark, Holland and Norway, too, it is below the average. The registrar-general of England has pointed out a marked tendency towards the postponement of marriage in that country. Between 1876 and 1905, for instance, the proportion of minors married receded by 43% in the case of men and 32% amongst women. The mean age of husbands married in 1873 was 25.6 years and of wives 24.2, whereas thirty years later the corresponding ages were 28.6 and 26.4. The general results of the decline of the marriage-rate and the postponement of marriage upon the natural growth of population will be discussed in connection with the birth-rate, though the statistics available do not permit of the accurate measurement of the respective influence of these factors, and there are others, too, which have to be taken into consideration, as will appear below.

Births.—Apart from the information which the statistics of birth furnish as to the growth of population, they have, like those of marriage, and perhaps to even a greater extent, a special social interest from their bearings upon the moral conditions of the community to which they relate. It is in their former capacity, however, that they enter into the present subject. A birth-rate, taken as it usually is upon the total population, old and young, is open to the objections made above respecting the marriage-rate, and with even more force, as the basis is itself largely the product of the fact which is being measured by it. The internal variations of the rate in a single community, however, can be fairly indicated in this way, as is done in Table VI., which, it is to be noted, refers to those born alive only and excludes the still-born, statistics regarding whom are incomplete.

The crude birth-rate, it will be noted, is in general harmony with that of marriage. In the countries where the former is high the rate of marriage is also above the average. In eastern Europe, so far as the figures can be trusted, this is markedly the case, and the birth-rates range between 39 per mille in Hungary and 49 in Russia, where the tradition of encouraging prolificity amongst the peasantry has not been effaced. Among the lower rates which prevail in western Europe, however, the connexion is not so direct, and a low birth-rate is sometimes found with a relatively higher marriage rate and vice versa, a deviation from the natural course of events which will

be discussed presently. The birth-rate, like the marriage-rate, seems to have reached its acme in the seventies, except in the three southern countries, France, Italy and Spain. The decline since the above period is very marked and exceeds that noted in the case of the rate of marriage. It is worth noting, too, that the fall in the crude birth-rate is not confined to the Old World, but has attracted special attention in Australia and New Zealand, where a rate of 40 per mille in the period 1861-1870 has now given place to one of 26. In Massachusetts and other of the older settlements of the United States, moreover, the same feature has been the subject of investigation.

other than abstinence from marriage, at all events at the principal reproductive period; and perhaps to a decrease in marriage or remarriage after middle life, a period of which the weight in the age-distribution has been increasing of late. On the other hand, the postponement of marriage in the case of women of conceptive ages is a tendency which seems to be growing in other countries as well as in England and undoubtedly has a depressing effect upon the rate of births. It would conduce, therefore, to further accuracy in the comparison of the rates of different countries if the latter were to be correlated with greater subdivision of the ages amongst wives between 15 and 45. The proportion of wives below 30 to the total of that group was

TABLE VI.

Country.	(A) Born alive, per 1000 of Total Population.				(B) Legitimate Births, per 1000 Wives, 15 to 45 years old.			(C) Illegitimate Births, per 1000 Unmarried and Widowed Women, 15 to 45.
	1841-1850.	1861-1870.	1871-1875.	1900-1905.	1880-1882.	1890-1892.	1900-1902.	1896-1900.
Sweden	31.1	31.4	30.7	26.7	293	280	269	23.4
Norway	30.7	30.9	30.3	29.7	314	307	303	16.9
Finland	35.5	34.7	37.0	32.2	309	301	—	18.0
Denmark	30.5	31.0	30.8	29.7	287	278	259	23.6
England	34.6	36.0	36.0	29.0	286	264	235	8.8
Scotland	—	34.8	35.0	29.7	311	296	272	14.1
Ireland	—	26.1	26.4	23.2	283	288	289	3.9
Holland	33.0	35.3	36.1	32.1	347	339	315	9.0
Belgium	30.5	31.6	32.4	28.5	313	285	251	18.9
Germany	36.1	37.2	38.9	35.5	310	301	284	27.7
Austria (W.)	35.9	35.7	37.2	34.2	281	292	284	41.7
France	27.3	26.3	25.5	21.7	196	173	157	18.1
Italy	—	37.5	36.9	33.5	276	283	269	21.1
Spain	—	37.8	36.5	34.8	258	264	259	—

The crude rates which have been discussed above afford no explanation of this change, nor do they always illustrate its full extent. It is necessary, therefore, to eliminate the difference in the age-constitution of the countries in question by excluding from the field of observation, as before, all except possible mothers, basing the rate upon the respective numbers of women of the conceptive age, that is between 15 and 45. The proportion borne by this group to the total population is in most cases fairly up to that set forth by Dr Sundbärg in his standard. It is well above it in all three parts of the United Kingdom and falls materially below it only in Scandinavia and Italy. Indeed, during the last generation, this proportion has been in most cases slightly increased, in consequence of the fall of the birth-rate which set in anterior to this period. The stock, then, from which wives are drawn is ample. The question remains, how far advantage is taken of it. According to the Sundbärg standard the percentage married is 48. As has been shown in the preceding paragraph, this is surpassed in Italy, France and Germany, and approached in most of the rest, with the exception of Sweden, Norway and Scotland, which are six or seven points below it, and Ireland, where less than a third are married. The proportion married, moreover, has slightly increased since 1880, except in the United Kingdom. In England the marriage-rate (on the age basis) fell off by 4.6% and in Scotland by 2%, whilst the crude birth-rate declined by 15 and 11% respectively. In Ireland the case was different, as the marriage-rate declined by 12% and the birth-rate by no more than 5.7%. In New South Wales and New Zealand, too, the marriage-rates fell off in the same period by 11 and 28% respectively, whilst the decline in the birth-rates amounted to 35 and 31%. In the above countries, therefore, abstinence from matrimony may be said to have been a factor of some importance in the decline. On the continent of Europe, however, looking at the divergence in direction between the crude marriage-rate and that corrected to an age-basis, it is not improbable that the decline in the former may be attributable to some cause

mentioned in connexion with the marriage-rate, and in the figures relating to some 30 years back some traces can be found of a connexion between a high birth-rate and a high proportion of young wives. In the present day, however, these indications do not appear, so it would seem that the tendency in question had been interrupted by some other influence, a point to which reference will be made below.

If abstinence from marriage and the curtailment of the reproductive period by postponement of marriage be insufficient to account for the material change which has taken place in the birth-rate within the last few decades, it is clear that the latter must be attributable to the diminished fertility of those who are married. On this question the figures in the second portion of Table VI. throws some light. Here the annual number of legitimate births is shown in its proportion to the mean number of married women of conceptive age at each of the three latest enumerations. The rate, it will be seen, has fallen in all the countries specified, except for a slight increase of 2% in Ireland and an almost stationary condition in Austria and Spain. The decline in Italy and Norway is small, but in France, where for a long time the fertility of the population has been very much below that of any other European country, the birth-rate thus calculated fell by nearly 20%, the same figure being approached in Belgium, where however, the fertility of married women is considerably greater. The case of England is remarkable. In the earlier period its crude birth and marriage-rates were above the average and its proportion of young wives well up to it. Its fertility-rate, however, which was by no means high in 1880, fell by nearly 18% by 1901, and since that date a further fall is reported by the registrar-general, to 24%, leaving the rate below that of all the other European countries except France. The States of Australasia, again, have experienced a decline even more marked. In 1880-1882 their fertility-rate ranged from 300 to 338, a low proportion for a new country, but nearly up to the European standard. By 1900-1902, however, the rate had fallen in all the larger States by from 23 to 31% and the

highest rate recorded, 253 per thousand conceptive wives, was lower than that of any European country except France and Belgium. The cessation of assisted immigration early in the life of the present generation is alleged to have had considerable influence upon the rate, in Victoria, at least, owing to the curtailment of the supply of adult women of the more conceptive ages and the ageing of those who had reached the country at an earlier date. But neither this nor the diminution of the marriage-rate amongst women of those ages suffices to account for more than a fraction of the decline. The same tendency, moreover, is traceable in the New England States of America, so far as statistics are available.

It has been held by some that a phenomenon so widely diffused over the western world must be attributable to physiological causes, such as alcoholism, syphilis, the abuse of narcotics and so on. Herbert Spencer, again, before the decline in question set in, put forward the hypothesis that "the ability to maintain individual life and the ability to multiply vary inversely"; in other words, the strain upon the nervous system involved in the struggle for life under the conditions of modern civilization, by reacting on the reproductive powers, tends towards comparative sterility. These theories, however, being supported, according to the authorities of to-day, by no evidence, statistical or other, need not be here considered.

Nor, again, can the decline in fertility be connected with any diminution of material prosperity. On the contrary, the fertility-rate appears to be best maintained in countries by no means distinguished for their high standard of living, such as Spain, Italy, Ireland, and, perhaps, Austria. In this respect Holland stands by itself; but in the others mentioned, with the exception of Ireland, both marriage and birth-rates are high and there has been a comparatively insignificant fall in prolificity. The decline has been greatest where the standard of comfort is notoriously high, as in the United States, England and Australasia; also in France, where the general wellbeing reaches probably a lower depth in the community than in any other part of Europe. The comparison of the rates in France with those of Ireland is an instructive illustration of the point under consideration. In France more than half the women of conceptive age are married: in Ireland less than a third, and the proportion of youthful wives in the latter is 28% below that in France. In both the crude birth-rate is far below that of any other European country. But the fertility of the Irish wife exceeded that of her French compeer by 44% in 1880 and by no less than 84% twenty years later. So steady, indeed, has been the prolificity of Ireland, that from being ninth on the list at the earlier period mentioned, it is now inferior only to Holland and perhaps Finland in this respect.

It need not be assumed, however, that because these rates cannot be associated with the comparative degree of prosperity attained by the individual community they are altogether independent of the economic factors mainly contributing to that condition, such as trade, employment and prices. It is difficult, indeed, if not impracticable, to disentangle the effects which should be respectively attributed to influences so closely related to each other; but, of the three, prices alone tend to sufficient uniformity in their course in different countries to justify a supposition that they are in some way connected with a phenomenon so widely diffused as that of the decline in marriage and fertility. It is not improbable, therefore, that the fall in wholesale prices which, with temporary interruptions, persisted between 1870 and 1900, in general harmony with the other movement, may have conduced to reluctance on the part of those who have enlarged their notions of the standard of comfort to endanger their prospects of enjoying it by incurring the additional expenses of family life. Matrimony may be postponed, or, when entered upon, may be rendered a lighter burden upon the breadwinner. The economic element in the situation, which is imposed upon the individual by circumstances, is thus modified voluntarily into a moral or prudential consideration. In this case diminished prolificity where unaccompanied by a decrease in the number of marriages at reproductive ages, is attributable

to the voluntary restriction of child-bearing on the part of the married. This explanation of the decline is supported by the almost unanimous opinion of the medical profession in the countries in question, and substantial evidence can be found everywhere of the extensive prevalence of the doctrine and practice of what has been termed, in further derogation of the repute of the "much misrepresented Malthus," *Neomalthusianism*. Preventive measures of this kind have long been in use in France, with the result shown in Tables V. and VI., and from that country they have spread, mostly since 1870, nearly all over western Europe, as well as to the Anglo-Saxon world beyond the seas; but are scarcely apparent in countries where the Roman church has a strong hold on the people. It is generally held that the practice of thus limiting families usually prevails, in the first instance, among the better-off classes, and in time filters down, as "the gospel of comfort" is accepted by those of less resources, until the prolificity of the whole community is more or less affected by it. The registrar general for England, indeed, has stated that whilst no more than about 17% of the decline in the birth-rate can be attributed to abstinence or postponement of marriage, nearly 70% should be ascribed to voluntary restriction.

The question of illegitimate births is the last to be here mentioned. It appears to be connected to a considerable extent with the subject dealt with above. In nearly every country the rate of these births has of late years shown a marked fall, which is by some ascribed to the adoption of the same expedients in illicit intercourse as are becoming conventional amongst the married. The rates given at the end of Table VI. are calculated upon the number of women most likely to produce them, that is, the spinsters, widows and divorced of conceptive age. In comparing the different countries, it may be noted that in some parts of Europe the rate is raised by the inclusion of the offspring of marriages not registered as demanded by law, though duly performed in church. Then, again, the possibility of legitimization by subsequent marriage tends to raise the rate. Italy and Scotland may be taken as examples of these two influences, and in Germany, too, the rates in Saxony and Bavaria, which are among the highest in Europe, are in part due to the non-registration of marriages sanctioned by religious ceremony only. The low rates in Ireland, Holland and England are especially noticeable, and in the last named, the decrease between 1870 and 1905 amounted to more than 50%, not, however, entirely due, it is said, to improved morality.

Deaths.—The forces tending towards the natural growth of population, which have been described above, differ from that which acts in the opposite direction in two material features. Marriage and child-bearing, in the first place, are operative amongst a fraction of the population only—those of conceptive age; whereas to the Urn of Death, as Dr Farr expressed it, all ages are called upon to contribute in their differing degrees. Then, again, the former are voluntary acts, entirely under the control of the individual; but mortality, though not beyond human regulation, is far less subject to it, and in order to have substantial results the control must be the outcome of collective rather than individual co-operation. The course of the marriage and birth-rates, set forth above, affords evidence that the control over both has been exercised of recent years to an unprecedented extent, and it will appear from what is stated below, that partly owing to this cause, partly, also, to improved hygienic conditions in western life, there has been an even more pronounced decline in the rate of mortality. The general results of both upon the natural increase of population in the countries selected for illustration of this subject will be found at the end of this paragraph. For the purpose of showing this, the crude death-rate, taken, like that of births, upon the whole population, without distinction of age or sex, will suffice. Where, however, the tendency to mortality, not its results, is in question, both the above factors must be taken into account, as they have been above in distinguishing the rate of fertility from that of births. The process of correcting the mere numbers of annual deaths per thousand of population into a form which renders

the return comparable with those for communities differently constituted is somewhat complicated, but it is amply justified by its necessity in adapting the figures to the important services they perform in actuarial and sanitary science. This subject can only be dealt with here in outline. In the first place, sex must be distinguished, because, from infancy upwards, except between the ages of 10 and 20, the mortality amongst females is considerably less than amongst the other sex, and appears, too, to be declining more rapidly. So far as adult life is concerned this superior vitality is no doubt attributable to comparative immunity from the risks and hardships to which men are exposed, as, also, to the weaker inclination of women towards intemperance of different kinds. Thus, though the generally higher proportion of females in the community may seldom be enough to depress more than slightly the death-rate as a whole, it has a substantial effect upon it at the ages where women are in more marked numerical predominance, as in later life, and in places where the number of domestic servants is unusually great. Age is a factor still more important than sex in a return intended to serve as an index of mortality. The liability to death is extremely high amongst infants, decreasing with every month of life during the first year, but continuing above the mean rate until about the age of five. From the latter period until the fifteenth or sixteenth year vitality is at its best. The death-rate then gradually rises, slowly till 25, more rapidly later, when, from about 45 onward deterioration asserts itself more pronouncedly, and by three score years and ten the rate begins to exceed that of childhood. Thus, all other considerations being set aside, mortality tends to vary inversely with the proportion of the population at the healthy period 5 to 25. As the replenishment of this group depends upon the conditions prevailing at the earlier ages, it is to the mortality in childhood that most weight, from the standpoint of hygiene, must be attached. In most European countries not much less than half the annual deaths take place amongst children below five years of age, upon the total number of whom the incidence falls to the extent of from 40 to 120 per mille. The greater part of this is debitable, as just pointed out, to the first year, in which the mortality, calculated upon the number of births, ranged, in the

decennium 1895-1904, between 70 per mille, in the exceptionally favourable circumstances of the Australasian States, to nearly 270 in European Russia. It should be remarked, in passing, that these rates are enormously higher amongst illegitimate children than amongst those born in wedlock, and that the proportion of still-born amongst the former is also in excess of that amongst the latter by some 50%. Infantile mortality is higher, too, in urban tracts, especially those associated with manufacturing industries. In Table VII. below, in which the crude rate alone is dealt with, evidence will be found of the general decline which has taken place in the mortality, thus expressed in different countries.

The difference in the rates for the various countries must not be taken as a measure of difference in mortality, since, as according to the table, much of it is ascribable to difference in age-constitution. At the same time, where the range is very wide, as between the rates in Scandinavia and Australia, and those in southern and eastern Europe, the variation, to a great extent, cannot be accounted for otherwise than by difference in hygienic conditions, more especially in the light thrown by the figures of infantile mortality in the second part of the table. The variations from period to period in the same country are more instructive. They show that in the 35 years covered the death-rate has generally declined by over 20%. The exceptional cases are, first, Ireland and Norway, with their emigrating tendencies; then Spain, where the returns have probably to be discounted for improved registration, and France, where the population is all but stationary. In Finland the death-rate at the earlier period taken for the comparison was abnormally swollen by epidemic disease, and if it be set on one side the decline appears to have been in harmony with that in its Scandinavian neighbours. The decline in mortality has been much greater than that in the crude birth-rate everywhere except in France, Australia, and, of course, Ireland; and it is only in the two former that it has been exceeded by that in the fertility-rate. The standard mortality of each community is deduced from a life-table, representing a "generation" of people assumed to be born at the same moment and followed throughout their hypothetical life, in the light of the distribution by age ascertained

TABLE VII.

Country.	(A) Death per 1000 of Total Population.			(B) Deaths under one year per 1000 Births.		(C) Decline per cent.			Probable Lifetime.
	1841-1850.	1861-1870.	1895-1904.	1874-1883.	1895-1904.	1861-1870 to 1895-1904.		Fertility-rate. 1880-1882 to 1900-1902.	
						Death-rate.	Birth-rate.		Years.
Sweden	20.6	20.2	15.8	128	98	21.7	15.0	8.2	52.3
Norway	18.2	18.0	15.1	104	90	10.5	3.9	3.5	52.2
Finland	23.5	32.6	18.7	164	134	42.6 ²	7.2	—	42.8
Denmark	20.5	19.8	15.8	141	127	20.6	4.2	9.3	47.8
England	23.7	24.0	17.2	149	150	28.3	19.4	17.8	45.9
Scotland	—	21.8	17.3	122	126	20.6	14.7	12.5	46.2
Ireland	—	16.6	18.0	96	103	+8.4	11.1	+2.1	—
Holland	26.2	25.4	17.0	204	147	33.0	9.0	9.2	27.8
Belgium	24.4	23.8	17.8	148	156	25.2	9.8	19.8	45.1
Germany	26.8	26.9	20.8	208 ³	198 ³	22.6	4.6	8.4	40.7
Austria (W)	29.8	29.1	24.0	255	224	17.5	4.2	—	—
France	23.2	23.6	20.4	165	153	13.5	17.5	19.8	47.4
Italy	—	30.9	22.7	208	170	26.5	10.7	2.5	43.0
Spain	—	30.6	27.8	—	182	9.1	8.0	—	—
Hungary	—	33.0	27.4	—	216	17.0	6.2	—	40.1
Galicia	—	33.5	27.8	—	—	17.0	2.3	—	—
Servia	—	30.9	23.6	—	154	23.6	9.9	—	—
Russia (Eur.)	—	37.1	31.2	267	268	15.9	2.2	—	—
N. S. Wales	—	16.2	11.7	—	108	27.7	32.2	30.7	51.2
Victoria	—	16.7	13.3	—	105	20.4	37.2	24.1	—
New Zealand	—	13.2	9.8	117	79	25.7	35.1	24.5	55.4

¹ Mean after lifetime at birth.² Finland from 1850-1891, decrease 20.4.³ Prussia only; Saxony, 284 and 272; Bavaria, 308 257.

through the census and the number of deaths at each age observed for as many years, generally from 10 to 20, as suffice to furnish a trustworthy average. The population thus dealt with is supposed to be stationary, that is, the loss by death at each age is at once made good by the addition of an equal number of the same age, whilst the survivors pass on to the age above. Of the many calculations set forth in these valuable tables there is only room here to refer to the "afterlifetime" for such countries as it is available, which is quoted in the last column of Table VII. It shows the average number of years which persons of a given age, or, as here, of all ages, will live, on the assumption that they are subject to the calculated probabilities of survival. It is sometimes known as the "expectation of life," a term, however, which involves a mathematical hypothesis now discarded.

The relation between the birth and the death rates has been the subject of much analysis and controversy. Observation has demonstrated that the two rates are generally found to move along parallel lines. A high birth-rate is accompanied by high mortality; conversely, when one is low, so is the other. A birth-rate continuously in excess of the death-rate tends to lower the latter through the supply it affords of people annually reaching the more healthy ages. If the supply be diminished, the narrower field open to the risks of infancy has the immediate effect of further decreasing the mortality. In course of time, however,

19th century. In England, the decrease in "natality" is in itself enough to account for the decline in the death-rate, apart from any considerations of improved hygiene. In France, on the contrary, the low natality having been so long continued, has raised the death-rate, by reason of the balance of proportion having been shifted by it from youth and the prime of life to old age. It may be inferred from the above that a high birth-rate does not imply a high rate of increase of population, any more than does a decreasing mortality, but the two rates must be considered in their relations to each other. The death-rate, however, is often taken by itself as the measure of the relatively favourable conditions or otherwise of the different countries; but it indicates at best the maintaining power of the community, whereas the increasing power, as manifested in the birth-rate, has also to be taken into account. Here, again, it is not sufficient to rely upon the mere rate of natural growth, or the difference between the two rates, since this may be the same in a community where both the rates are very high as in one where they are relatively low, a distinction of considerable importance. It has been suggested by Dr Rubin of Copenhagen, that if the death rate (*d*) be squared and divided by the birth-rate (*b*), due influence is allowed to each rate respectively, as well as to the difference in the height of the rates in different countries (*Journ. R. Statist. Soc.*, London, 1897, p. 154). The quotient thus obtained decreases as the conditions are more favourable, and, on the

whole, it seems to form a good index to the merit of the respective countries from the standpoint of vital forces. The first column of Table VIII. shows the order in which the countries mentioned are found to stand according to the above test.

The three Australasian states head the list in virtue of their remarkably low death-rate, which outweighs the relative paucity of their births. The next countries in order all belong to north-western Europe, and their index-quotients are all very close to each other. Sweden falls below its geographical neighbours owing to its low birth-rate, and Finland because of its higher mortality. England and Scotland, in spite of their higher birth-rates, are kept below Scandinavia by the higher death-rate, but their birth-rate places them above Belgium. Ireland and France are pulled down by their low natality. The latter, with the same mortality as Germany, stands far below it for the above reason, as Ireland is raised by its lower death-rate above the prolific countries of eastern Europe. The rate of natural growth is given in the second part of the table. In the case of two of the Australasian states, of Holland, Finland, Spain and Italy, the order is in accord with that given by the test applied above, and the difference between the two in Austria, Ireland and France is not large. The great difference between the serial rank occupied in the respective lists by Russia, Servia and Galicia, with remarkably high rates of natural growth, as well as that found in the case of most of the other countries in question, shows that this factor is by no means a trustworthy guide in the estimate of hygienic balance.

TABLE VIII.

Country.	Serial order according to formula $\frac{d^2}{b}$	Per 1000 of Population.					
		Annual excess of Births over Deaths.		Total annual increase.		Approximate loss by emigration.	
		1895-1904.	1861-1871.	1895-1904.	1861-1871.	1891-1901.	1861-1871.
Sweden . . .	7	11.2	10.9	7.7	7.1	3.7	3.7
Norway . . .	4	12.9	14.6	7.9	11.3	5.1	2.7
Finland . . .	10	2.1	13.5	1.3	11.1	1.0	2.3
Denmark . . .	5	11.1	13.9	10.4	11.5	0.3	1.3
England . . .	8	13.6	11.8	12.5	11.5	1.1	0.2
Scotland . . .	9	13.0	11.9	9.3	10.6	3.6	1.2
Ireland . . .	13	9.6	5.2	-6.9	-5.4	15.0	10.7
Holland . . .	6	9.9	15.1	8.4	12.7	2.0	1.5
Belgium . . .	11	7.8	10.7	7.4	9.8	1.1	0.1
Germany . . .	12	10.3	14.7	7.8	13.2	2.5	0.7
Austria (W.) . .	16	7.9	10.2	5.6	0.5	0.8	0.5
France . . .	18	2.7	1.3	2.8	1.6	+ 0.2	+ 1.0
Italy . . .	15	6.5	10.8	6.0	6.2	0.9	4.6
Spain . . .	19	7.7	7.0	5.1	4.9	2.1	0.4
Russia . . .	20	12.7	17.5	11.7	13.5	0.7	1.6
Hungary . . .	18	8.5	11.5	8.2	9.8	0.4	0.9
Servia . . .	14	13.6	16.5	-	14.4	-	0.6
Galicia . . .	17	10.9	15.6	10.9	10.4	0.1	4.1
New South Wales	2	24.8	16.1	36.9	18.4	+ 12.1	+ 2.3
Victoria . . .	3	24.7	12.7	30.8	5.2	+ 6.1	7.5
New Zealand . .	1	27.0	16.3	63.0	19.0	+ 36.0	+ 2.7

under the same influence, those passing from their prime into the second period of danger acquire a numerical preponderance which throws its weight upon the general death-rate and tends to raise it. It is assumed that throughout the above course the hygienic conditions of life remain unchanged. If, however, they undergo marked improvement, the duration of life is extended and both birth and death-rates, being spread over a wider field of the living, tend to decrease. On the other hand, an accidental set-back to population, such as that caused by famine or a disastrous war, leaves room which an increasing birth-rate hastens to occupy. A similar result follows in a lesser degree a wave of emigration. Examples of all the above tendencies may be gleaned from the returns of the countries named in the table, though space does not admit of their exhibition. In both France and Germany, for instance, the process of replenishment after a great war can be traced both early and late in the

Migration.—Passing from the internal factors in the movement of population, the influence has to be taken into account of the interchange of population between different countries. The net results of such exchange can be roughly estimated by comparing the rate of natural growth with that of the total increase of the community between one census and another, as set forth in Table VIII., in the last section of which the approximate loss by emigration, as calculated by Dr Sundbärg, is given. It will be seen that the only European country which gains by the exchange is France, and there the accretion is almost insignificant. Between many of the countries there is a good deal of migration which is only seasonal or temporary, according to the demand for labour. From Russia, too, there is a stream of colonization across the Urals into western Siberia, and amongst the western Mediterranean populations there is constant

migration to North Africa. The greatest drain from Europe, however, has been across the sea to the United States, Canada and Australasia, especially to the first-named. Dr Sundbärg's returns give about 28 millions as the number which left Europe by sea during the 19th century, of whom all but 4 millions emigrated during the last half of that period. Between 1821 and 1904, about 22 millions landed from Europe in the United States; about 2½ millions in Canada; 2 millions in Australia, besides a good number in Brazil, the Argentine and South Africa. The return of birthplace which usually forms part of the census inquiry, affords supplementary information on the subject of immigration. In Canada, for instance, those born abroad numbered 17 % of the population in 1871, and about 13 % thirty years later. In New South Wales, the corresponding figures were 41 and 28 %, and in Victoria 55 and 27. In New Zealand the consequences of the cessation of special encouragement to emigration were still more marked, the foreign-born declining in proportion from 63 to 33 %. On the other hand, in the United States, from 9·7 % in 1850 the proportion rose to 13·7 in 1900, and has since reached still higher figures, as has been the case recently in Canada also. Up to the early 'nineties the greater part of the immigrants into America were furnished by Germany, Ireland and Great Britain, but for the next fifteen years the place of those countries was taken by Italy and eastern Europe. The general results of the two movements in Europe have been thus summarised by Dr Sundbärg:—

TABLE IX.

	Annual rate per 1000 of population.							
	1801-1850.				1850-1900.			
	Births.	Deaths.	Births above Deaths.	Census Increase.	Births.	Deaths.	Births above Deaths.	Census Increase.
Europe, N.W.	35·4	26·5	8·9	8·1	34·4	23·4	11·0	8·6
„ S.W.	33·6	28·3	5·3	5·2	31·4	26·3	5·1	4·3
„ E.	45·9	38·1	7·8	7·7	46·2	34·7	11·5	10·6
Total Europe	38·6	31·2	7·4	7·1	38·0	28·4	9·6	8·2
United States	—	—	—	29·9	—	—	—	24·0
Canada	—	—	—	38·7	—	—	—	16·2
Australasia	—	—	—	85·9	—	—	—	48·2

Differences tend to be smoothed out, of course, in dealing with a population so large and varied as that of a continent, but the figures suffice to show the contrast between the early part of the century and the period following the great migratory movements to the new goldfields. In the countries receiving the stream of newcomers, the intercensal rate of increase was obviously very different from those of the older countries, though it seems to have largely spent itself or been counteracted by other influences. The latest rates, for instance, were only 18 per mille per annum in Australia; 11 in Canada and 19 in the United States.

BIBLIOGRAPHY.—A very full bibliography up to 1899 is appended to von Fircke's *Bevölkerungslehre und Bevölkerungspolitik*. Reference may also be made to Matthews Duncan, *Fecundity, Fertility and Sterility* (ed. 1871); Newsholme, *Elements of Vital Statistics* (ed. 1899), and his paper on birth-rates, *Journ. R. Statist. Soc.* (1906); W. Farr, *Vital Statistics* (1885); Coghlan, *Report on Decline in Birth-rate, New South Wales* (1903), and report of Royal Commission on that decline (1904); Bonar, *Malthus and his Work* (1885); Bertillon, *Éléments de démographie*; Garnier, *Du Principe de population*; de Molinari, *Ralentissement du mouvement de la population*; Bertheau, *Essai sur les lois de la population*; Starkenburg, *Die Bevölkerungs-Wissenschaft*; Stieda, *Das sexual Verhältniss der Geborenen*; Rubin and Westergård, *Statistik der Ehen*; Westergård, *Die Lehre von der Mortalität und Morbilität*, and *Die Grundzüge der Theorie der Statistik*; Gonnard, *L'Émigration européenne*. (J. A. B.)

POPULONIUM (Etruscan *Pupluna*), an ancient seaport town of Etruria, Italy, at the north end of the peninsular of Monte Massoncello, at the south end of which is situated the town of Piombino (q.v.). The place, almost the only Etruscan town

built directly on the sea, was situated on a lofty hill¹ now crowned by a conspicuous medieval castle and a poor modern village (Populonia). Considerable remains of its town walls, of large irregular, roughly rectangular blocks (the form is that of the natural splitting of the schistose sandstone), still exist, enclosing a circuit of about 1½ m. The remains existing within them are entirely Roman—a row of vaulted substructions, a water reservoir and a mosaic with representations of fishes. Strabo mentions the existence here of a look-out tower for the shoals of tunny-fish. There are some tombs outside the town, some of which, ranging from the Villanova period (9th century B.C.) to the middle of the 3rd century B.C., were explored in 1908. In one, a large circular tomb, were found three sepulchral couches in stone, carved in imitation of wood, and a fine statuette in bronze of Ajax committing suicide. Close by was found a horse collar with 14 bronze bells. The remains of a temple, devastated in ancient times (possibly by Dionysius of Syracuse in 384 B.C.), were also discovered, with fragments of Attic vases of the 5th century B.C., which had served as *ex votos* in it. Coins of the town have also been found in silver and copper. The iron mines of Elba, and the tin and copper of the mainland, were owned and smelted by the people of Populonia; hot springs too lay some 6 m. to the E. (Aquae Populaniae) on the high road—Via Aurelia—along the coast. At this point a road branched off to Saena (Siena). According to Virgil the town sent a contingent to the help of Aeneas, and

it furnished Scipio with iron in 205 B.C. It offered considerable resistance to Sulla, who took it by siege; and from this dates its decline, which Strabo, who describes it well (v. 2, 6, p. 223), already notes as beginning, while four centuries later Rutilius describes it as in ruins. The harbour, however, continued to be of some importance, and the place was still an episcopal see in the time of Gregory the Great.

See G. Dennis, *Cities and Cemeteries of Etruria* (London, 1883, ii. 212 sqq.); I. Falchi in *Notizie degli Scavi* (1903-1904); L. A. Milani, *ibid.* (1908), 199 sqq.

PORBANDAR, a native state of India, in the Kathiawar political agency, Bombay, extending along the S.W. coast of the peninsula of Kathiawar. Area, 636 sq. m.; pop. (1901), 82,640, showing a decrease of 4 % in the decade. Estimated gross revenue, £65,000; tribute, £3,233. The chief, whose title is rana, is a Jethwa Rajput. Limestone is largely exported to Bombay. This limestone is used for buildings in Porbandar without mortar, and is said to coalesce into a solid block under the influence of moisture. The town of PORBANDAR is the maritime terminus of the Kathiawar railway system. Pop. (1901), 24,620. A large trade is conducted in native boats as far as the east coast of Africa.

PORCELAIN, the name of that kind of ceramic ware which is characterized by a translucent body, also loosely used for the finer kinds of ware generally, popularly known as "china" (see CERAMICS). The French *porcelaine*, from which the word comes into English, is an adaptation of the Italian *porcellana*, a cowrie-shell, the beautifully polished surface of which caused the name to be applied to the ware. The Italian word is generally taken to be from *porcella*, diminutive of *porco*, pig, from a supposed resemblance of the shell to a pig's back.

PORCH (through the Fr. *porche*, from Lat. *porticus*; the Ital. equivalent is *portico*, corresponding to the Gr. *πόρθηξ*; Ger. *Vorhalle*), a covered erection forming a shelter to the entrance door of a large building. The earliest known are the two porches of the Tower of the Winds at Athens; there would seem to have been one in front of the entrance door of the villa of Diomedes outside the gate at Pompeii; in Rome they were

¹ It commands a fine view, and Corsica is sometimes visible, though not Sardinia, as Strabo (and following him, Lord Macaulay) erroneously state.

probably not allowed, but on either side of the entrance door of a mansion, porticoes set back behind the line of frontage were provided, according to F. Mazois, as shelters from sun and rain for those who paid early visits before the doors were opened. In front of the early Christian basilicas was a long arcaded porch called "narthex" (*q.v.*) In later times porches assume two forms—one the projecting erection covering the entrance at the west front of cathedrals, and divided into three or more doorways, &c., and the other a kind of covered chamber open at the ends, and having small windows at the sides as a protection from rain. These generally stand on the north or south sides of churches, though in Kent there are a few instances (as Snodland and Boxley) where they are at the west ends. Those of the Norman period generally have little projection, and are sometimes so flat as to be little more than outer dressings and hood-moulds to the inner door. They are often richly ornamented, and, as at Southwell in England and Kelso in Scotland, have rooms over, which have been erroneously called *parvises*. Early English porches are much longer, and in larger buildings frequently have rooms above; the gables are generally bold and high pitched. In larger buildings also, as at Wells, St Albans, &c., the interiors are as rich in design as the exteriors. Decorated and Perpendicular porches partake of much the same characteristics, the pitch of roof, mouldings, copings, battlements, &c., being, of course, influenced by the taste of the time. The later porches have rooms over them more frequently than in earlier times; these are often approached from the lower storey by small winding stairs, and sometimes have fire-places, and are supposed to have served as vestries; and sometimes there are the remains of a piscina, and relics of altars, as if they had been used as chantry chapels. It is probable there were wooden porches at all periods, particularly in those places where stone was scarce; but, as may be expected from their exposed position, the earliest have decayed. At Cobham, Surrey, there was one that had ranges of semicircular arches in oak at the sides, of strong Norman character. It is said there are several in which portions of Early English work are traceable, as at Chevington in Suffolk. In the Decorated and later periods, however, wooden porches are common, some plain, others with rich tracery and large boards; these frequently stand on a sort of half storey of stone work or *bahul*. The entrance porches at the west end of cathedrals are generally called *portals*, and where they assume the character of separate buildings, are designated *galilees*; e.g. the porticoes on the west side of the south transept of Lincoln Cathedral, and at the west end of the nave of Ely Cathedral, and the chapel at the west end of Durham Cathedral. The finest example in England of an open projected porch is that of Peterborough Cathedral, attached to the Early Norman nave.

The term "porch" is also given to the magnificent portals of the French cathedrals, where the doors are so deeply recessed as to become porches, such as those of Reims, Amiens, Chartres, Troyes, Rouen, Bourges, Paris, and Beauvais cathedrals, St Ouen, Rouen, and earlier Romanesque churches, as in St Trophime, Arles and St Gilles. Many, however, have detached porches in front of the portals, as in Notre Dame at Avignon, Chartres (north and south), Noyon, Bourges (north and south), St Vincent at Rouen, Notre Dame de Louviers, the cathedrals of Albi and Le Puy, and in Germany those of Spire and Regensburg, and the churches of St Laurence and St Sebald at Nuremberg. (R. P. S.)

PORCUPINE (Fr., *porc-épic*, "spiny pig"), the name of the largest European representative of the terrestrial rodent mammals, distinguished by the spiny covering from which it takes its name. The European porcupine (*Hystrix cristata*) is the typical representative of a family of Old World rodents, the *Hystricidae*, all the members of which have the same protective covering. These rodents are characterized by the imperfectly rooted cheek-teeth, imperfect clavicles or collar-bones, cleft upper lip, rudimentary first front-toes, smooth soles, six teats and many cranial characters. They range over the south of Europe, the whole of Africa, India and the Malay Archipelago as far east as Borneo. They are all stout, heavily-built animals,

with blunt rounded heads, fleshy mobile snouts, and coats of thick cylindrical or flattened spines, which form the whole covering of their body, and are not intermingled with ordinary hairs. Their habits are strictly terrestrial. Of the three genera *Hystrix* is characterized by the inflated skull, in which the nasal chamber is often considerably larger than the brain-case, and

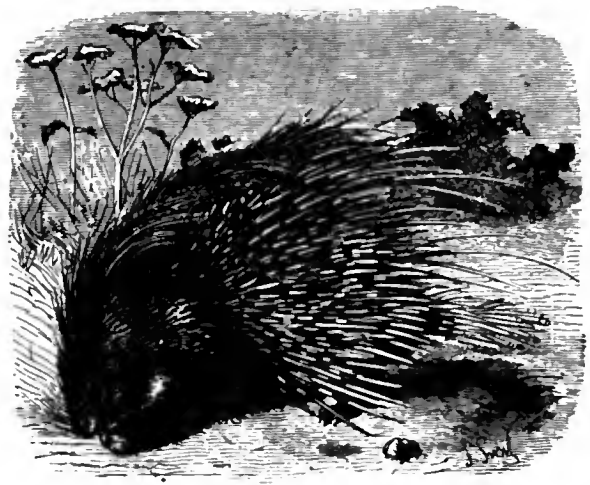

The Porcupine (*Hystrix cristata*).

the short tail, tipped with numerous slender-stalked open quills, which make a loud rattling noise whenever the animal moves. The common porcupine (*H. cristata*), which occurs throughout the south of Europe and North and West Africa, is replaced in South Africa by *H. africae australis* and in India by the hairy-nosed porcupine (*H. leucura*).

Besides these large crested species, there are several smaller species without crests in north-east India, and the Malay region from Nepal to Borneo. The genus *Atherura* includes the brush-tailed porcupines which are much smaller animals, with long tails tipped with bundles of flattened spines. Two species are found in the Malay region and one in West Africa. *Trichys*, the last genus, contains two species, *T. fasciculata* of Borneo and *T. macrotis* of Sumatra, both externally very like *Atherura*, but differing from the members of that genus in many cranial characteristics. In the New World the porcupines are represented by the members of the family *Erethizontidae*, or *Coendidae*, which have rooted molars, complete collar-bones, entire upper lips, tuberculated soles, no trace of a first front-toe, and four teats. The spines are mixed with long soft hairs. They are less strictly nocturnal in their habits; and with one exception live entirely in trees, having in correspondence with this long and powerful prehensile tails. They include three genera, of which the first is represented by the Canadian porcupine (*Erethizon dorsatus*), a stout, heavily-built animal, with long hairs almost or quite hiding its spines, four front- and five hind-toes, and a short, stumpy tail. It is a native of the greater part of Canada and the United States, wherever there is any remnant of the original forest left. *Syntheres*, or *Coendu*, contains some eight or ten species, known as tree-porcupines, found throughout tropical South America, with one extending into Mexico. They are of a lighter build than the ground-porcupines, with short, close, many-coloured spines, often mixed with hairs, and prehensile tails. The hind-feet have only four toes, owing to the suppression of the first, in place of which they have a fleshy pad on the inner side of the foot, between which and the toes boughs and other objects can be firmly grasped as with a hand. *Chaetomys*, distinguished by the shape of its skull and the greater complexity of its teeth, contains *C. subspinosus*, a native of the hottest parts of Brazil. (W. H. F.; R. L. *)

PORDENONE, IL (1483-1530), an eminent painter of the Venetian school, whose correct name was Giovanni Antonio Licinio, or Licino. He was commonly named Il Pordenone from having been born in 1483 at Corticelli, a village near Pordenone (*q.v.*) in Italy. He ultimately dropped the name of Licinio, having quarrelled with his brothers, one of whom had wounded him in the hand; he then called himself Regillo, or De Regillo. His signature runs "Antonius Portunaensis." or "De Portunaonis." He was created a cavaliere by Charles V.

As a painter Licinio was a scholar of Pellegrino da S. Daniele, but the leading influence which governed his style was that of Giorgione; the popular story that he was a fellow-pupil with Titian under Giovanni Bellini is incorrect. The district

about Pordenone had been somewhat fertile in capable painters; but Licinio excelled them all in invention and design, and more especially in the powers of a vigorous chiaroscuro and flesh painter. Indeed, so far as mere flesh-painting is concerned he was barely inferior to Titian in breadth, pulpiness and tone; and he was for a while the rival of that great painter in public regard. The two were open enemies, and Licinio would sometimes affect to wear arms while he was painting. He excelled Giorgione in light and shade and in the effect of relief, and was distinguished in perspective and in portraits; he was equally at home in fresco and in oil-colour. He executed many works in Pordenone and elsewhere in Friuli, and in Cremona and Venice; at one time he settled in Piacenza, where is one of his most celebrated church pictures, "St Catherine disputing with the Doctors in Alexandria"; the figure of St Paul in connexion with this picture is his own portrait. He was formally invited by Duke Hercules II. of Ferrara to that court; here soon afterwards, in 1539, he died, not without suspicion of poison. His latest works are comparatively careless and superficial; and generally he is better in male figures than in female—the latter being somewhat too sturdy—and the composition of his subject-pictures is scarcely on a level with their other merits. Pordenone appears to have been a vehement self-asserting man, to which his style as a painter corresponds, and his morals were not unexceptionable. Three of his principal scholars were Bernardino Licinio, named Il Sacchiense, his son-in-law Pomponio Amalteo, and Giovanni Maria Calderari.

The following may be named among Pordenone's works: the picture of "S Luigi Giustiniani and other Saints," originally in S Maria dell' Orto, Venice; a "Madonna and Saints" (both of these in the Venice academy); the "Woman taken in Adultery," in the Berlin museum; the "Annunciation," at Udine, regarded by Vasari as the artist's masterpiece, now damaged by restoration. In Hampton Court is a duplicate work, the "Painter and his Family"; and in Burghley House are two fine pictures now assigned to Pordenone—the "Finding of Moses" and the "Adoration of the Kings." These used to be attributed to Titian and to Bassano respectively.

PORDENONE, a town of the province of Udine, Venetia, Italy, 30 m. W. by S. of Udine on the railway to Treviso. Pop. (1901), 8,425 (town); 12,409 (commune). It was the birthplace of the painter generally known as Il Pordenone (*q.v.*). Paintings from his brush adorn the cathedral (which has a fine brick campanile), and others are preserved in the gallery of the town hall. Cotton industries are active, and silk and pottery are manufactured.

PORE, a small opening or orifice, particularly used of the openings of the ducts of the sweat-glands in the skin or of the *stomata* in the epidermis of plants or those through which the pollen or seed are discharged from anthers or seed capsules. The word is an adaptation through the French from Lat. *porus*, Gr. *πόρος*, passage. In the sense of to look closely at, to read with persistent or close attention, "pore" is of obscure origin. It would seem to be connected with "peer," to look closely into, and would point to an O. Eng. *purian* or *pyrian*. There is no similar word in Old French.

PORFIRIUS, PUBLILIUS OPTATIANUS, Latin poet, possibly a native of Africa, flourished during the 4th century A.D. He has been identified with Publilius Optatianus, who was *præfectus urbi* (329 and 333), and is by some authorities included amongst the Christian poets. For some reason he had been banished, but having addressed a panegyric to the Emperor Constantine the Great, he was allowed to return. Twenty-eight poems are extant under his name, of which twenty were included in the panegyric. They have no value except as curiosities and specimens of perverted ingenuity. Some of them are squares (the number of letters in each line being equal), certain letters being rubricated so as to form a pattern or figure, and at the same time special verses or maxims; others represent various objects (a syrinx, an organ, an altar); others have special peculiarities in each line (number of words or letters); while the 28th poem (the *versus anocyclici*) may be read back-

wards without any effect upon sense or metre. A complimentary letter from the emperor and letter of thanks from the author are also extant. The best edition of the poem is by L. Müller (1877).

See also O. Seeck, "Das Leben des Dichters Porphyrius" in *Rheinisches Museum* (1908), lxiii. 267.

PORISM. The subject of porisms is perplexed by the multitude of different views which have been held by geometers as to what a porism really was and is. The treatise which has given rise to the controversies on this subject is the *Porisms* of Euclid, the author of the *Elements*. For as much as we know of this lost treatise we are indebted to the *Collection* of Pappus of Alexandria, who mentions it along with other geometrical treatises, and gives a number of lemmas necessary for understanding it. Pappus states that the porisms of Euclid are neither theorems nor problems, but are in some sort intermediate, so that they may be presented either as theorems or as problems; and they were regarded accordingly by many geometers, who looked merely at the form of the enunciation, as being actually theorems or problems, though the definitions given by the older writers showed that they better understood the distinction between the three classes of propositions. The older geometers regarded a theorem as directed to *proving* what is proposed, a problem as directed to *constructing* what is proposed, and finally a porism as directed to *finding* what is proposed (*εἰς πορισμὸν αὐτοῦ τοῦ προτεινομένου*). Pappus goes on to say that this last definition was changed by certain later geometers, who defined a porism on the ground of an accidental characteristic as *τὸ λείπον ὑποθέσει τοπικοῦ θεωρήματος*, that which falls short of a locus-theorem by a (or in its) hypothesis.

Proclus points out that the word was used in two senses. One sense is that of "corollary," as a result unsought, as it were, but seen to follow from a theorem. On the "porism" in the other sense he adds nothing to the definition of "the older geometers" except to say (what does not really help) that the finding of the center of a circle and the finding of the greatest common measure are porisms (Proclus, ed. Friedlein, p. 301).

Pappus gives a complete enunciation of a porism derived from Euclid, and an extension of it to a more general case. This porism, expressed in modern language, asserts that—given four straight lines of which three turn about the points in which they meet the fourth, if two of the points of intersection of these lines lie each on a fixed straight line, the remaining point of intersection will also lie on another straight line. The general enunciation applies to any number of straight lines, say $(n+1)$, of which n can turn about as many points fixed on the $(n+1)$ th. These n straight lines cut, two and two, in $\frac{1}{2}n(n-1)$ points, $\frac{1}{2}n(n-1)$ being a triangular number whose side is $(n-1)$. If, then, they are made to turn about the n fixed points so that any $(n-1)$ of their $\frac{1}{2}n(n-1)$ points of intersection, chosen subject to a certain limitation, lie on $(n-1)$ given fixed straight lines, then each of the remaining points of intersection, $\frac{1}{2}(n-1)(n-2)$ in number, describes a straight line. Pappus gives also a complete enunciation of one porism of the first book of Euclid's treatise. This may be expressed thus: If about two fixed points P, Q we make turn two straight lines meeting on a given straight line L, and if one of them cut off a segment AM from a fixed straight line AX, given in position, we can determine another fixed straight line BY, and a point B fixed on it, such that the segment BM' made by the second moving line on this second fixed line measured from B has a given ratio λ to the first segment AM. The rest of the enunciations given by Pappus are incomplete, and he merely says that he gives thirty-eight lemmas for the three books of porisms; and these include 171 theorems.

The lemmas which Pappus gives in connexion with the porisms are interesting historically, because he gives (1) the fundamental theorem that the cross or an harmonic ratio of a pencil of four straight lines meeting in a point is constant for all transversals; (2) the proof of the harmonic properties of a complete quadrilateral; (3) the theorem that, if the six vertices of a hexagon lie three and three on two straight lines, the three points of concurrence of opposite sides lie on a straight line.

During the last three centuries this subject seems to have had great fascination for mathematicians, and many geometers have attempted to restore the lost porisms. Thus Albert Girard says in his *Traité de trigonométrie* (1626) that he hopes to publish a restoration. About the same time P. de Fermat wrote a short work under the title *Porismatum euclidæorum renovata doctrina et sub forma isagoges recentioribus geometris exhibitæ* (see *Oeuvres de Fermat*, i., Paris, 1891); but two at least of the five examples of porisms which he gives do not fall within the classes indicated by Pappus. Robert Simson was the first to throw real light upon the subject. He first succeeded in explaining the only three propositions which Pappus indicates with any completeness. This explanation was published in the *Philosophical Transactions* in 1723. Later he investigated the subject of porisms generally in a work entitled *De porismatibus tractatus; quo doctrinam porismatum satis explicatam, et in posterum ab oblivione tutam fore sperat auctor*, and published after his death in a volume, *Roberti Simson opera quaedam reliqua* (Glasgow, 1776). Simson's treatise, *De porismatibus*, begins with definitions of theorem, problem, datum, porism and locus. Respecting the porism Simson says that Pappus's definition is too general, and therefore he will substitute for it the following: "Porisma est propositio in qua proponitur demonstrare rem aliquam vel plures datas esse, cui vel quibus, ut et cuilibet ex rebus innumeris non quidem datis, sed quæ ad ea quæ data sunt eandem habent relationem, convenire ostendendum est affectionem quandam communem in propositione descriptam. Porisma etiam in forma problematis enuntiari potest, si nimirum ex quibus data demonstranda sunt, invenienda proponantur." A locus (says Simson) is a species of porism. Then follows a Latin translation of Pappus's note on the porisms, and the propositions which form the bulk of the treatise. These are Pappus's thirty-eight lemmas relating to the porisms, ten cases of the proposition concerning four straight lines, twenty-nine porisms, two problems in illustration and some preliminary lemmas. John Playfair's memoir (*Trans. Roy. Soc. Edin.*, 1794, vol. iii.), a sort of sequel to Simson's treatise, had for its special object the inquiry into the probable origin of porisms—that is, into the steps which led the ancient geometers to the discovery of them. Playfair remarked that the careful investigation of all possible particular cases of a proposition would show that (1) under certain conditions a problem becomes impossible; (2) under certain other conditions, indeterminate or capable of an infinite number of solutions. These cases could be enunciated separately, were in a manner intermediate between theorems and problems, and were called "porisms." Playfair accordingly defined a porism thus: "A proposition affirming the possibility of finding such conditions as will render a certain problem indeterminate or capable of innumerable solutions." Though this definition of a porism appears to be most favoured in England, Simson's view has been most generally accepted abroad, and has the support of the great authority of Michael Chasles. However, in *Lionville's Journal de mathématiques pures et appliquées* (vol. xx., July, 1855), P. Breton published *Recherches nouvelles sur les porismes d'Euclide*, in which he gave a new translation of the text of Pappus, and sought to base thereon a view of the nature of a porism more closely conforming to the definitions in Pappus. This was followed in the same journal and in *La Science* by a controversy between Breton and A. J. H. Vincent, who disputed the interpretation given by the former of the text of Pappus, and declared himself in favour of the idea of Schooten, put forward in his *Mathematicæ exercitationes* (1657), in which he gives the name of "porism" to one section. According to F. van Schooten, if the various relations between straight lines in a figure are written down in the form of equations or proportions, then the combination of these equations in all possible ways, and of new equations thus derived from them leads to the discovery of innumerable new properties of the figure, and here we have "porisms." The discussions, however, between Breton and Vincent, in which C. Housel also joined, did not carry forward the work of restoring Euclid's Porisms, which was left for Chasles. His work (*Les Trois livres de porismes d'Euclide*, Paris, 1860) makes full use of all the material found in Pappus. But we may doubt its being a successful reproduction of Euclid's actual work. Thus, in view of the ancillary relation in which Pappus's lemmas generally stand to the works to which they refer, it seems incredible that the first seven out of thirty-eight lemmas should be really equivalent (as Chasles makes them) to Euclid's first seven Porisms. Again, Chasles seems to have been wrong in making the ten cases of the four-line Porism begin the book, instead of the intercept-Porism fully enunciated by Pappus, to which the "lemma to the first Porism" relates intelligibly, being a particular case of it. An interesting hypothesis as to the Porisms was put forward by H. G. Zeuthen (*Die Lehre von den Kegelschnitten im Altertum*, 1886, ch. viii.). Observing, e.g., that the intercept-Porism is still true if the two fixed points are points on a conic, and the straight lines drawn through them intersect on the conic instead of on a fixed straight line, Zeuthen conjectures that the Porisms were a by-product of a fully developed projective geometry of conics. It is a fact that Lemma 31 (though it makes no mention of a conic) corresponds exactly to Apollonius's method of determining the foci of a central conic (*Conics*, iii. 45-47 with 42).

The three porisms stated by Diophantus in his *Arithmetica* are

propositions in the theory of numbers which can all be enunciated in the form "we can find numbers satisfying such and such conditions"; they are sufficiently analogous therefore to the geometrical porism as defined in Pappus and Proclus.

A valuable chapter on porisms (from a philological standpoint) is included in J. L. Heiberg's *Litterargeschichtliche Studien über Euklid* (Leipzig, 1882); and the following books or tracts may also be mentioned: Aug. Richter, *Porismen nach Simson bearbeitet* (Elbing, 1837); M. Cantor, "Ueber die Porismen des Euklid und deren Divinatoren," in *Schlömilch's Zeitsch. f. Math. u. Phys.* (1857), and *Literaturzeitung* (1861), p. 3 seq.; Th. Leidenfrost, *Die Porismen des Euklid* (Programm der Realschule zu Weimar, 1863); Fr. Buchbinder, *Euclids Porismen und Data* (Programm der kgl. Landesschule Pforta, 1866). (T. L. H.)

POROS, or PORO ("the Ford"), an island off the east coast of the Morea, separated at its western extremity by only a narrow channel from the mainland at Troezen, and consisting of a mass of limestone rock and of a mass of trachyte connected by a slight sandy isthmus. The town looks down on the beautiful harbour between the island and the mainland on the south.

The ancient Calauria, with which Poros is identified, was given, according to the myth, by Apollo to Poseidon in exchange for Delos; and it became in historic times famous for a temple of the sea-god, which formed the centre of an amphictyony of seven maritime states—Hermione, Epidaurus, Aegina, Athens, Prasiae, Nauplia, and Orchomenus. Here Demosthenes took sanctuary with "gracious Poseidon," and, when this threatened to fail him, sought death. The building was of Doric architecture and lay on a ridge of the hill commanding a fine view of Athens and the Saronic Gulf, near the middle of the limestone part of the island. The site was excavated in 1894, and traces of a sacred agora with porticoes and other buildings, as well as the temple, have been found. In the neighbourhood of Poros-Calauria are two small islands, the more westerly of which contains the ruins of a small temple, and is probably the ancient Sphaeria or Hiera mentioned by Pausanias as the seat of a temple of Athena Apaturia. The English, French, and Russian plenipotentiaries met at Poros in 1828 to discuss the basis of the Greek government.

See Chandler, *Travels*; Leake, *Morea*; Le Bas, *Voyage archéologique*; Curtius, *Peloponnesos*; Pouillon-Boblaye, *Recherches*; Bursian, *Geographie von Griechenland*; Rangabé "Ein Ausflug nach Poros," in *Deutsche Revue* (1883); and S. Wide, in *Mitteilungen d. deutsch. Inst. Athen.* (1895), vol. xx.

PORPHYRIO, **POMPONIU**s, Latin grammarian and commentator on Horace, possibly a native of Africa, flourished during the 2nd century A.D. (according to others, much later). His scholia on Horace, which are still extant, mainly consist of rhetorical and grammatical explanations. It is not probable that we possess the original work, which must have suffered from alterations and interpolations at the hands of the copyists of the middle ages, but on the whole the scholia form a valuable aid to the student of Horace.

Ed. W. Meyer (1874); A. Holder (1894); see also C. F. Urba, *Meletemata porphyrianea* (1885); E. Schweikert, *De Porphyriionis . . . scholiis Horatianis* (1865); F. Pauly, *Quaestiones criticae de . . . Porphyriionis commentariis Horatianis* (1858).

PORPHYRY (Πορφύριος) (A.D. 233-c. 304), Greek scholar, historian, and Neoplatonist, was born at Tyre, or Batanæa in Syria. He studied grammar and rhetoric under Cassius Longinus (q.v.). His original name was Malchus (king), which was changed by his tutor into Porphyrius (clad in purple), a jesting allusion to the colour of the imperial robes (cf. porphyrogenitus, born in the purple). In 262 he went to Rome, attracted by the reputation of Plotinus, and for six years devoted himself to the study of Neoplatonism. Having injured his health by overwork, he went to live in Sicily for five years. On his return to Rome, he lectured on philosophy and endeavoured to render the obscure doctrines of Plotinus (who had died in the meantime) intelligible to the ordinary understanding. His most distinguished pupil was Iamblichus. When advanced in years he married Marcella, a widow with seven children and an enthusiastic student of philosophy. Nothing more is known of his life, and the date of his death is uncertain.

Of his numerous works on a great variety of subjects the following are extant: *Life of Plotinus* and an exposition of his teaching in the

'Αφορμὰ πρὸς τὰ νοητὰ (*Sententiae ad intelligibilia ducentes*, Aids to the study of the Intelligibles). The *Life of Pythagoras*, which is incomplete, probably formed part of a larger history of philosophy (φιλόσοφος ἱστορία, in four books) down to Plato. His work on Aristotle is represented by the *Introduction* (εἰσαγωγή) to and *Commentary* (ἐξηγήσεις, in the form of questions and answers) on the *Categories*. The first, translated into Latin by Boëtius, was extensively used in the middle ages as a compendium of Aristotelian logic; of the second only fragments have been preserved. His *Χρονικά*, a chronological work, extended from the taking of Troy down to A.D. 270; to it Eusebius is indebted for his list of the Macedonian kings. The treatise φιλόλογος ἱστορία is called an ἀκρόασις (lecture) by Eusebius, who in his *Præparatio evangelica* (x. 3) has preserved a considerable extract from it, treating of plagiarism amongst the ancients. Other grammatical and literary works are 'Ομηρικὰ ζήτηματα (*Quæstiones homericae*); and *De antro nympharum*, in which the description in the *Odyssey* (xiii. 102-112) is explained as an allegory of the universe. The *Περὶ ἀποκρίσεως ἐπιθυμιῶν* (*De abstinentia*), on abstinence from animal food, is especially valuable as having preserved numerous original statements of the old philosophers and the substance of Theophrastus's *Περὶ ἐσθραβίας* (*On Piety*). It also contains a long fragment from the *Cretans* of Euripides. The *Πρὸς Μαρκέλλαν* is an exhortation to his wife Marcella to practise virtue and self-restraint and to study philosophy. The letter to the Egyptian priest Anebo, dealing with religious questions, was answered by a member of the school of Iamblichus, who called himself Abammon, in the *De mysteriis*. It is frequently referred to by Eusebius, Cyril and Augustine. Eusebius preserved fragments of the *Περὶ τῆς ἐκ λογίων φιλοσοφίας* (*De philosophia ex oraculis haurienda*), in which he expressed his belief in the responses of the oracles of various gods as confirming his theosophical views. Porphyry is well known as a violent opponent of Christianity and defender of Paganism; of his *Κατὰ Χριστιανῶν* (*Adversus Christianos*) in 15 books, perhaps the most important of all his works, only fragments remain. Counter-treatises were written by Eusebius of Caesarea, Apollinarius (or Apollinaris) of Laodicea, Methodius of Olympus, and Macarius of Magnesia, but all these are lost. Porphyry's view of the book of Daniel, that it was the work of a writer in the time of Antiochus Epiphanes, is given by Jerome. There is no proof of the assertion of Socrates, the ecclesiastical historian, and Augustine, that Porphyry was once a Christian.

There is no complete edition of the works of Porphyry. Separate editions: *Vita Plotini* in R. Volkman's edition of the *Enneades* of Plotinus (1883); *Sententiae*, by B. Mommiert (1907); *Vita Pythagoræ*, *De antro nympharum*, *De abstinentia*, *Ad Marcellam*, by A. Nauck (1885); "Isagoge et in Aristotelis categoriis commentarium," by A. Busse in *Commentaria in Aristotelem graeca* (1887), iv. 1, with the translation of Boëtius (ed. with introd., S. Brandt, 1906); fragments of the *Chronica* in C. W. Müller, *Frag. hist. graec.* (1849), iii. 688; *Quæstiones homericae*, by H. Schrader (1880, 1890); *Leter to Anebo* in W. Pharthey's edition of Iamblichus *De mysteriis* (1857); *De philosophia ex oraculis haurienda*, by G. Wolff (1856); fragments of the *Adversus Christianos* by A. Georgiades (Leipzig, 1891); English trans. of the *De abstinentia*, *De antro nympharum* and *Sententiae*, by Thomas Taylor (1823); of the *Sententiae* by T. Davidson in the *Journal of Speculative Philosophy*, iii. (1869); of the *De abstinentia* by S. Hibberd (1857), and of the *Ad Marcellam* by A. Zimmern (1896).

On Porphyry and his works generally see Fabricius, *Bibliotheca graeca* (ed. Harles), v. 725; Eunapius, *Vita philosophorum*; article in Suidas; Lucas Holstenius, *De vita et scriptis Porphyrii* (Cambridge, 1655); J. E. Sandys, *Hist. of Classical Scholarship* (1906), i. 343; W. Christ, *Gesch. der griechischen Litteratur* (1898), § 621; M. N. Bouillet, *Porphyre, son rôle dans l'école néoplatonicienne* (1864); A. I. Kleffner, *Porphyrius der Neuplatoniker und Christenfeind* (Paderborn, 1896); on his philosophy, T. Whittaker, *The Neoplatonists* (Cambridge, 1901), and NEOPLATONISM.

PORPHYRY (Gr. πορφύρεος, Lat. *purpureus*, purple), in petrology, a beautiful red volcanic rock which was much used by the Romans for ornamental purposes when cut and polished. The famous red porphyry (*porfido rosso antico*) came from Egypt, but its beauty and decorative value were first recognized by the Romans in the time of the emperor Claudius. It was obtained on the west coast of the Red Sea, where it forms a dike 80 or 90 ft. thick. For a long time the knowledge of its source was lost, but the original locality, marked by many ancient quarries, has been re-discovered at Jebel Dhokan, and the stone is again an article of commerce. In a dark red ground-mass it contains many small white or rose-red plagioclase feldspars, black shining prisms of hornblende, and small plates of iron oxide. The red colour of the feldspars and of the ground-mass is unusual in rocks of this group, and arises from the partial conversion of the plagioclase feldspar into thulite and manganese-epidote. These minerals also occur in thin veins crossing the rock. Many

specimens show effects of crushing and in extreme cases this has produced brecciation. Another famous porphyry, hardly less beautiful, is the *verde antique*, *porfido verde antico*, or *marmor lacedaemonium viride* of Pliny, which was obtained between Lebetsova and Marathonisi in Peloponnesus. It has the same structure as the red porphyry as it contains large white or green feldspars in a fine ground-mass. The green colour arises from the abundant formation of chlorite and epidote in the large feldspars and throughout the rock. In ancient times it was much used as an ornamental stone, these two varieties of porphyry making a fine contrast with one another. Green porphyries are not so rare as red. A similar rock is obtained at Lambay Island near Dublin. They are still used extensively, especially for small ornaments. Large pieces are difficult to obtain free from flaws, and marble is preferred for mural work, not only because of the greater variety of patterns but also because it is much softer and more easily cut and polished.

Many igneous rocks possess the structure which characterizes these porphyries (see PETROLOGY, Plate III.); the presence of scattered crystals of larger size in a fine-grained ground-mass. Most lavas, and many of the rocks which occur as dikes and sills, have porphyritic structure. These may be called porphyries and this term has consequently been applied to a great variety of rocks, e.g. diorite-porphry, granite-porphry, greenstone-porphry, augite-porphry, liabenerite-porphry, &c. More recently the use of the term has been restricted to a series of rocks which are of intrusive origin and contain much porphyritic feldspar (with or without quartz or nepheline). The porphyritic intrusive rocks with large crystals of augite, olivine, biotite, and hornblende are for the most part grouped under the lamprophyres; while the term porphyry is rarely now applied to any of the effusive rocks or lavas. Furthermore, it has become usual to subdivide the intrusive porphyries into two classes; in one of these the phenocrysts are mainly orthoclase, in the other mainly plagioclase feldspar. The first series is known as the "porphyries," while the second group is called "porphyrites." There are porphyries which correspond chemically and mineralogically to granites, syenites, and nepheline-syenites; while the porphyrites form a parallel series to the diorites, norites and gabbros. In each case the porphyritic type occurs generally as dikes and thin sheets which consolidated beneath the surface but probably at no great depth (hypabyssal rocks); while granite, gabbro and the other holocrystalline non-porphryitic rocks belong to the plutonic or abyssal group which cooled very slowly at great depths and under enormous pressure.

The principal subdivisions of the group are the granite-porphryes, the syenite-porphryes and the elaeolite-porphryes. In all of them porphyritic orthoclase or alkali feldspar is the characteristic mineral. The granite-porphryes and quartz-porphryes (*q.v.*) consist mainly of orthoclase, quartz and ferro-magnesian mineral, usually biotite but sometimes hornblende, augite or enstatite.

Granite-porphryes are exceedingly common in all regions where acid intrusive rocks occur. Many granite masses are surrounded by dikes of this kind, and in some cases the chilled margin of a granite consists of typical porphyry.

The syenite-porphryes, like the syenites, are less common than the granite-porphryes and granites. They are characterized by an abundance of orthoclase and a scarcity or absence of quartz. The phenocrysts are orthoclase (and oligoclase), biotite, hornblende or augite; the ground-mass is principally alkali feldspar with sometimes a little quartz. In many specimens the feldspars of the second generation form a mosaic of ill-shaped grains, in others they are little rectangular crystals which may have a fluxion arrangement (orthophytic type of ground-mass). Some of the rocks formerly known as orthoclase-porphryes belong to this group; others are ancient trachytic lavas (orthophyres). Closely related to the syenite-porphryes is the rhomben-porphry of south Norway and West Africa. In these the large feldspars have rhomb-shaped sections owing to their peculiar crystalline development. Olivine, augite and biotite occur in these rocks, but there is no quartz or soda-lime feldspar. The porphyritic feldspars contain both soda and potash and belong to anorthoclase. Rhomben-porphryes occur as dikes connected with the syenites (laurvikites of southern Norway), and many ice-borne boulders of these rocks have been found among the drift deposits of the east of England.

Elaeolite- and leucite- (syenite) porphyries form apophyses and dikes around nepheline- and leucite-syenite intrusions. The former contain porphyritic nepheline which is often weathered to soft,

finely crystalline aggregates of white mica and other secondary products as in the well-known liebenerrite-porphry of Tirol and giesckite-porphry of Greenland. The felspars of these rocks are albite, orthoclase and anorthoclase, and they often contain soda-augite and amphiboles. Elaeolite-porphyrines occur along with nepheline-syenites in such districts as the Serra de Monchique, south Norway, Kola, Montreal. Allied to them are the tinguaites (so called from the Serra de Tingua, Rio de Janeiro, Brazil), which are pale green rocks with abundant alkali felspar nepheline, needles of green aegirine, and sometimes biotite and cancrinite. As a rule, however, these are not porphyritic. Some authors group the tinguaites with the aplites rather than the porphyries. Grorudites are quartz-tinguaites free from nepheline, and sölvbergites are tinguaitic rocks in which neither quartz nor nepheline occur. The two last varieties have been described from the Christiania district in Norway, but tinguaites are known with nepheline-syenites in many parts of the world, e.g. Norway, Brazil, Portugal, Canada, Sweden, Greenland.

The following analyses of porphyries of different types will show the chemical composition of a few selected examples:—

	SiO ₂	Al ₂ O ₃	Fe ₂ O ₃	FeO	MgO	CaO	K ₂ O	Na ₂ O	H ₂ O
I.	72.51	13.31	tr.	3.87	1.50	0.60	6.65	0.43	0.60
II.	67.18	16.65	0.55	2.15	1.54	2.35	2.91	4.03	0.75
III.	71.60	13.60	2.40	—	0.21	2.30	3.53	5.55	0.70
IV.	58.82	21.06	3.26	0.70	1.38	3.03	3.70	6.83	1.26
V.	45.18	23.31	6.11		1.45	4.62	11.16	5.94	1.14
VI.	54.46	19.96	2.34	3.33	0.61	2.12	8.68	2.76	5.20
VII.	75.20	12.65	1.53	0.28	0.26	0.60	4.14	5.67	0.12

I., Elvan or granite porphyry (with pinite after cordierite)—Prah sands, Cornwall. II., Granophyre—Armbboth, Cumberland. III., Granophyre—Carrack Fell, Cumberland. IV., Rhomben-porphry—Tönsterg, Norway. V., Elaeolite porphyry—Beemerville, New Jersey. VI., Tinguaitite—Kola. VII., Grorudite—Assynt, Scotland.

Porphyrites.—The porphyrites as above mentioned are intrusive or hypabyssal rocks of porphyritic texture, with phenocrysts of plagioclase felspar and hornblende, biotite or augite (sometimes also quartz) in a fine ground-mass. The name has not always been used in this sense, but formerly signified rather decomposed andesitic and basaltic lavas of Carboniferous age and older. Both the red porphyry and the green porphyry of the ancients are more properly classified in this group than with the granite-porphyrines, as their dominant felspar is plagioclase and they contain little or no primary quartz. Porphyrites occur as dikes which accompany masses of diorite, and are often called diorite-porphyrines; they differ from diorites in few respects except their porphyritic structure. The phenocrysts are plagioclase, often much zoned with central kernels of bytownite or labradorite and margins of oligoclase or even orthoclase. In a special group there are corroded blebs or porphyritic quartz: these rocks are called quartz-porphyrines, and are distinguished from the granite-porphyrines by the scarcity or absence of orthoclase. The hornblende of the porphyrites is often green but sometimes brown, resembling that of the lamprophyres, a group from which the porphyrites are separated by their containing phenocrysts of felspar, which do not occur in normal lamprophyres. Augite, when present, is nearly always pale green; it is not so abundant as hornblende. Dark brown biotite is very common in large hexagonal plates. Muscovite and olivine are not represented in these rocks. The ground-mass is usually a crystalline aggregate of granular felspar in which plagioclase dominates, though orthoclase is rarely absent. The Alpine dike rocks known as ortlerites and sudenites are porphyrites containing much green or brown hornblende and augite; these, however, hardly require a distinctive designation. Diorite-porphyrines have almost as wide a distribution as granite-porphyrines, and occur in all parts of the world where intrusions of granite and diorite have been injected; they are in fact among the commonest hypabyssal rocks.

To gabbros and norites certain types of porphyrite correspond which have the same mineral and chemical composition as the parent rocks but with a porphyritic instead of granitic structure. Gabbro-porphyrines are not numerous; or rather most of these rocks are described as porphyritic basalts and dolerites. The beerbachites are finely granular dike rocks resembling gabbros

in all respects except in their being less coarsely crystalline. Norite-porphyrines have porphyritic plagioclase (labradorite usually) with hypersthene or bronzite, often altered to bastite. They accompany norite masses in Nahe (Prussia) and Tirol. They have vitreous forms which are described as andesitic-pitchstones or hypersthene-andesites.

	SiO ₂	Al ₂ O ₃	Fe ₂ O ₃	FeO	CaO	MgO	K ₂ O	Na ₂ O	H ₂ O
I.	64.94	17.50	0.69	3.94	2.59	2.83	3.11	3.44	1.36
II.	61.58	18.84	4.68	—	6.59	2.04	1.49	4.27	1.61
III.	56.85	16.70	5.92	7.13	5.97	3.25	1.91	2.78	0.54

I., Quartz-porphryite—Lippenhof, Schwarzwald. II., Porphyrite—Esterel, France. III., Norite-porphryite—Klausen, Tirol. (J. S. F.)

PORPOISE (sometimes spelled Porpus and Porpesse), a name derived from the O. Fr. *porpeis*, for *porc-peis*, i.e. pig-fish, Lat. *porcus*, pig, and *piscis*, fish; the mod. Fr. *marouin* is borrowed from the Ger. *meerschwein*, although the word is commonly used by sailors to designate all the smaller cetaceans, especially those numerous species which naturalists call "dolphins," it is properly restricted to the common porpoise of the British seas (*Phocaena communis*, or *P. phocaena*).

The porpoise, when full grown, attains a length of 5 ft. or more; the dimensions of an adult female specimen from the

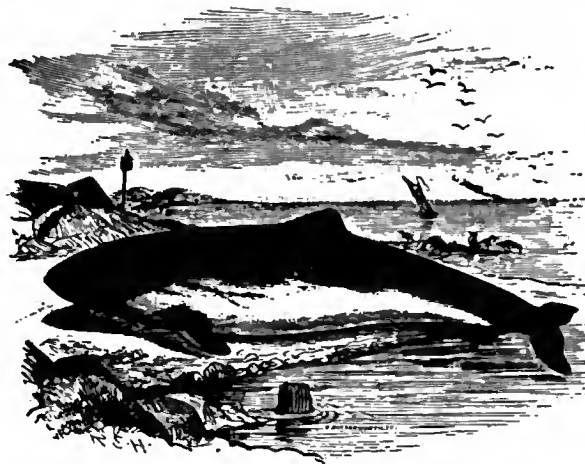

FIG. 1.—The Common Porpoise (*Phocaena communis*).

English Channel being: length from nose to notch between the flukes of the tail, 62½ in.; from the nose to the front edge of the dorsal fin, 29 in.; height of dorsal fin, 4½ in.; length of base of dorsal fin, 8 in.; length of pectoral fin, 9½ in.; breadth of pectoral fin, 3½ in.; breadth of tail flukes, 13 in. The head is rounded in front, and differs from that of dolphins in not having the snout produced into a distinct "beak" separated from the forehead by a groove. The under jaw projects about half an inch beyond the upper. The mouth is wide, bounded by stiff immobile lips, and curves slightly upwards at the hinder end. The eye is small, and the external ear represented by a minute aperture, scarcely larger than would be made by a pin, about 2 in. behind the eye. The dorsal fin, near the middle of the back, is low and triangular. The flippers are of moderate size, and slightly sickle-shaped. The upper-parts are dark grey or nearly black according to the light in which they are viewed and the state of moisture or otherwise of the skin; the under-parts pure white. The line of demarcation between these colours is not distinct, washes or splashes of grey encroaching upon the white on the sides, and varies somewhat in different individuals. Usually it passes from the throat (the anterior part of which, with the whole of the under jaw, is dark) above the origin of the flipper, along the middle of the flank, and descends again to the middle line before reaching the tail. Both sides of the flippers and flukes are black. The anterior edge of the dorsal fin is furnished with a row of small rounded horny spines or, rather, tubercles, of variable number. One of

the most characteristic anatomical distinctions between the porpoise and other members of the *Delphinidae* is the form of the teeth (numbering twenty-three to twenty-six on each side of each jaw), which have expanded, flattened, spade-like crowns, with more or less marked vertical grooves, giving a tendency to a bilobed or often trilobed form (fig. 2).

The porpoise, which is sociable and gregarious, is usually seen in small herds, and frequents coasts, bays and estuaries rather

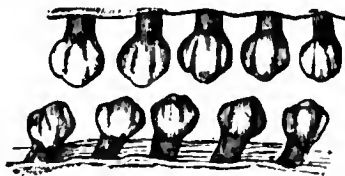

FIG. 2.—Teeth of Porpoise. (Twice natural size.)

than the open ocean. It is the commonest cetacean in the seas round the British Isles, and not infrequently ascends the Thames, having been seen as high as Richmond; it has also been observed in the Seine at Neuilly, near Paris. It frequents the Scandinavian coasts, entering the Baltic in the summer; and is found as far north as Baffin's Bay and as far west as the coasts of the United States. Southward its range is more limited than that of the dolphin, as, though common on the Atlantic coasts of France, it is not known to enter the Mediterranean.

It feeds on mackerel, pilchards and herrings and, following the shoals, is often caught by fishermen in the nets along with its prey. In former times it was a common article of food in England and France, but is now rarely if ever eaten, being valuable only for the oil obtained from its blubber. Its skin is sometimes used for leather and boot-thongs, but the so-called "porpoise-hides" are generally obtained from the beluga. The Black Sea porpoise (*P. relicta*) is a distinct species. A third species, from the American coast of the North Pacific, has been described under the name of *Phocaena vomerina*, and another from the mouth of the Río de la Plata as *P. spinipennis*. Nearly allied is *Neophocaena phocaenoides*, a small species from the Indian Ocean and Japan, with teeth of the same form as those of the porpoise, but fewer in number (eighteen to twenty on each side), of larger size, and more distinctly notched or lobed on the free edge. It is distinguished from the common porpoise externally by its black hue and the absence of a dorsal fin. (See CETACEA.)

(R. L.*)

PORPORA, NICCOLA [or **NICCOLÒ**] **ANTONIO** (1686–1767), Italian operatic composer and teacher of singing, was born in Naples on the 10th of August 1686. He was educated at the Conservatorio di Santa Maria di Loreto. His first opera, *Basilio*, was produced at Naples; his second, *Berenice*, at Rome. Both were successful, and he followed them up by innumerable compositions of like character; but his fame rests chiefly upon his unequalled power of teaching singing. At the Conservatorio di Sant' Onofrio and the Poveri di Gesù Cristo he trained Farinelli, Caffarelli, Mingotti, Salimbeni, and other celebrated vocalists. Still his numerous engagements did not tempt him to forsake composition. In 1725 he visited Vienna, but the Emperor Charles VI. disliked his florid style, especially his constant use of the *trillo*, and refused to patronize him. After this rebuff he settled in Venice, teaching regularly in the schools of La Pietà and the Incurabili. In 1729 he was invited to London as a rival to Handel; but his visit was unfortunate. Little less disastrous was his second visit to England in 1734, when even the presence of his pupil, the great Farinelli, failed to save the dramatic company of Lincoln's Inn Fields theatre, known as the "Opera of the Nobility," from ruin. The sequence of dates and visits in Porpora's life are variously stated by different biographers. The electoral prince of Saxony and king of Poland had invited him to Dresden to become the singing master of the electoral princess, Maria Antonia, and in 1748 he is supposed to have been made Kapellmeister to the prince. Difficult relations, however, with Hasse and his wife resulted in his departure, of which the date is not known. From Dresden he

is said to have gone to Vienna, where he gave lessons to Joseph Haydn (*q.v.*), and then to have returned in 1759 to Naples. From this time Porpora's career was a series of misfortunes. His last opera, *Camilla*, failed; and he became so poor that the expenses of his funeral were paid by subscription. Yet at the moment of his death in 1767 Farinelli and Caffarelli were living in splendour on fortunes for which they were largely indebted to the excellence of the old maestro's teaching. In George Sand's *Consuelo* much use is made of a romantic version of the life of young Haydn and his relations with the heroine, Porpora's pupil, and with Porpora himself. A good linguist and a man of considerable literary culture, Porpora was also celebrated for his power of repartee. His operas are, on the whole, tedious and conventional; but he produced some good work in the form of instrumental music and chamber-cantatas. A series of six Latin duets on the Passion (accessible in a modern edition published by Breitkopf and Haertel) is remarkable for dignity and beauty.

PORRIDGE (an altered form of "pottage," Fr. *potage*, soup, that which is cooked in a pot), a food made by stirring meal, especially oatmeal, in boiling water and cooking it slowly until the whole becomes soft. The dish and its name are particularly identified with Scotland; in Ireland it is commonly known as "stir-about." The former application to a broth made of vegetables or of meat and vegetables thickened with barley or other meal is obsolete, and the earlier "pottage" is the usual word employed. The form "porridge" apparently dates from the 16th century. In "porringer," a porridge-bowl, the *n* is inserted as in "passenger," "messenger."

PORSENA (or **PORSENNNA**), **LARS**, king of Clusium in Etruria. He is said to have undertaken an expedition against Rome in order to restore the banished Tarquinius Superbus to the throne. He gained possession of the Janiculum, and was prevented from entering Rome only by the bravery of Horatius Cocles (*q.v.*). Porsena then laid siege to the city, but was so struck by the courage of Mucius Scaevola that he made peace on condition that the Romans restored the land they had taken from Veii and gave him twenty hostages. He subsequently returned both the land and the hostages (Livy, ii. 9–15; Dion. Halic., v. 21–34; Plutarch, *Poplicola*, p. 16–19). This story is probably an attempt to conceal a great disaster and to soothe the vanity of the Romans by accounts of legendary exploits. According to other authorities, the Romans were obliged to surrender the city, to acknowledge Porsena's supremacy by sending him a sceptre, a royal robe, and an ivory chair, to abandon their territory north of the Tiber, to give up their arms, and in future to use iron for agricultural purposes only. It is curious that, in spite of his military success, Porsena made no attempt to restore the Tarquinian dynasty. Hence it is suggested that the attack on Rome was merely an incident of the march of the Etruscans, driven southward by the invasion of upper Italy by the Celts, through Latium on their way to Campania. This would account for its transitory effects, and the speedy recovery of the Romans from the blow. With the departure of Porsena all traces of Etruscan sovereignty disappear and Rome is soon vigorously engaged in the prosecution of various wars (see Tacitus, *Hist.* iii. 72; Pliny, *Nat. Hist.* xxxiv. 39 [14]; Dion. Halic. v. 35, 36, vii. 5). The tomb at Chiusi described by Pliny (*Nat. Hist.* xxxvi. 19) as that of Porsena cannot have been his burial-place (see **CLUSIUM**).

For a critical examination of the story, see Schwegler, *Römische Geschichte*, bk. xxi. 18; Sir G. Cornwall Lewis, *Credibility of Early Roman History*, ch. xii. 5; W. Ihne, *Hist. of Rome*, vol. i.; E. Pais, *Storia di Roma*, i. ch. iv. (1898). Macaulay's *Lays of Ancient Rome* gives a dramatic version of the story.

PORSON, RICHARD (1759–1808), English classical scholar, was born on Christmas Day 1759 at East Ruston, near North Walsham, in Norfolk, the eldest son of Huggin Porson, parish clerk. His mother was the daughter of a shoemaker named Palmer, of the neighbouring village of Bacton. He was sent first to the village school at Bacton, kept by John Woodrow, and afterwards to that of Happsburgh kept by Mr Summers.

Here his extraordinary powers of memory and aptitude for arithmetic were soon discovered; his skill in penmanship, which attended him through life, was due to the care of Summers, who became early impressed with his abilities, and long afterwards stated that during fifty years of scholastic life he had never come across boys so clever as Porson and his two brothers. He was well grounded in Latin by Summers, remaining with him for three years. His father also took pains with his education, making him repeat at night the lessons he had learned in the day. He would frequently repeat without making a mistake a lesson which he had learned one or two years before and had never seen in the interval. For books he had only what his father's cottage supplied—a book or two of arithmetic, Greenwood's *England*, Jewell's *Apology*, and an odd volume of Chamber's *Cyclopaedia* picked up from a wrecked coaster, and eight or ten volumes of the *Universal Magazine*.

When Porson was eleven years old the Rev. T. Hewitt, the curate of East Ruston and two neighbouring villages, took charge of his education. Mr Hewitt taught him with his own boys, taking him through the ordinary Latin authors, Caesar, Terence, Ovid and Virgil; before this he had made such progress in mathematics as to be able to solve questions out of the *Ladies' Diary*. In addition to this Hewitt brought him under the notice of Mr Norris of Wotton Park, who sent him to Cambridge and had him examined by Professor Lambert, the two tutors of Trinity, Postlethwaite and Collier, and the well-known mathematician Atwood, then assistant tutor; the result was so favourable a report of his knowledge and abilities that Mr Norris determined to provide for his education so as to fit him for the university. This was in 1773. It was found impossible to get him into Charterhouse, and he was entered on the foundation of Eton in August 1774.

Of his Eton life Porson had no very pleasant recollections, but he was popular among his schoolfellows; and two dramas he wrote for performance in the Long Chamber were remembered many years later. His marvellous memory was of course noticed; but at first he seems to have somewhat disappointed the expectations of his friends, as his composition was weak, and his ignorance of quantity kept him behind several of his inferiors. He went to Eton too late to have any chance of succeeding to a scholarship at King's College. In 1777 he suffered a great loss from the death of his patron Mr Norris; but contributions from Etonians to aid in the funds for his maintenance at the university were rapidly supplied, and he found a successor to Norris in Sir George Baker, the physician, at that time president of the college of physicians. Chiefly through his means Porson was entered at Trinity College, Cambridge, as a pensioner on the 28th of March 1778, matriculating in April. It is said that what first biased his mind towards critical researches was the gift of a copy of Toup's *Longinus* by Dr Davies, the head master of Eton, for a good exercise; but it was Bentley and Richard Dawes to whom he looked as his immediate masters. His critical career was begun systematically while an undergraduate. He became a scholar of Trinity in 1780, won the Craven university scholarship in 1781, and took his degree of B.A. in 1782, as third senior optime, obtaining soon afterwards the first chancellor's medal for classical studies. The same year he was elected Fellow of Trinity, a very unusual thing for a junior bachelor of arts, as the junior bachelors were rarely allowed to be candidates for fellowships, a regulation which lasted from 1667 when Isaac Newton was elected till 1818 when Connop Thirlwall became a fellow. Porson graduated M.A. in 1785.

Having thus early secured his independence, he turned his thoughts to publication. The first occasion of his appearing in print was in a short notice of Schütz's *Aeschylus* in *Maty's Review*, written in 1783. This review contains several other essays by his hand; especially may be mentioned the reviews of R. F. Brunck's *Aristophanes* (containing an able summary of the poet's chief excellencies and defects), Weston's *Hermesianax*, and Huntingford's *Apology for the Monstrophics*. But it was to the tragedians, and especially to Aeschylus, that his mind was then chiefly directed. He began a correspondence

with David Ruhnken, the veteran scholar of Leiden, requesting to be favoured with any fragments of Aeschylus that Ruhnken had come across in his collection of inedited lexicons and grammarians, and sending him, as a proof that he was not undertaking a task for which he was unequal, some specimens of his critical powers, and especially of his restoration of a very corrupt passage in the *Supplices* (673-677) by the help of a nearly equally corrupt passage of Plutarch's *Eroticus*. As the syndics of the Cambridge press were proposing to re-edit Thomas Stanley's *Aeschylus*, the editorship was offered to Porson; but he declined to undertake it on the conditions laid down, namely, of reprinting Stanley's corrupt text and incorporating all the variorum notes, however worthless. He was especially anxious that the Medicean MS. at Florence should be collated for the new edition, and offered to undertake the collation at an expense not greater than it would have cost if done by a person on the spot; but the syndics refused the offer, the vice-chancellor (Mr Torkington, master of Clare Hall) observing that Porson might collect his MSS. at home.

In 1786, a new edition of Hutchinson's *Anabasis* of Xenophon being called for, Porson was requested by the publisher to supply a few notes, which he did in conjunction with the Rev. W. Whiter, editor of the *Etymologicon universale*. These give the first specimen of that neat and terse style of Latin notes in which he was afterwards without a rival. They also show his intimate acquaintance with his two favourite authors, Plato and Athenaeus, and a familiarity with Eustathius's commentary on Homer.

In 1787 the *Notae breves ad Toup's emendationes in Suidam* were written, though they did not appear till 1790 in the new edition of Toup's book published at Oxford. These first made Porson's name known as a scholar of the first rank, and carried his fame beyond England. The letters he received from Christian G. Heyne and G. Hermann preserved in the library of Trinity College, and written before his *Euripides* was published, afford proof of this. In his notes he points out the errors of Toup and others; at the same time he speaks of Toup's book as "opus illud aureum," and states that his writing the notes at all is due to the admiration he had for it. They contain some brilliant emendations of various authors; but the necessity of having Toup's own notes with them has prevented their ever being reprinted in a separate form.

During this year, in the *Gentleman's Magazine*, he wrote the three letters on Hawkins's *Life of Johnson* which have been reprinted by Mr Kidd in his *Tracts and Criticisms of Porson*, and in a volume of Porson's *Correspondence*. They are admirable specimens of the dry humour so characteristic of the writer, and prove his intimate acquaintance with Shakespeare and the other English dramatists and poets. In the same periodical, in the course of 1788 and 1789, appeared the *Letters to Archdeacon Travis, on the spurious verse 1 John v. 7* (collected in 1790 into a volume), which must be considered to have settled the question. Gibbon's verdict on the book, that it was "the most acute and accurate piece of criticism since the days of Bentley," may be considered as somewhat partial, as it was in defence of him that Porson had entered the field against Travis. But in the masterly sketch of Gibbon's work and style in the preface Porson does not write in a merely flattering tone. It is to be wished that on such a subject the tone of levity had been modified. But Porson says in his preface that he could treat the subject in no other manner, if he treated it at all: "To peruse such a mass of falsehood and sophistry and to write remarks upon it, without sometimes giving way to laughter and sometimes to indignation, was, to me at least, impossible." Travis has no mercy shown him, but he certainly deserved none. One is equally struck with the thorough grasp Porson displays of his subject, the amount of his miscellaneous learning, and the humour that pervades the whole. But it was then the unpopular side: the publisher is said to have lost money by the book; and one of his early friends, Mrs Turner of Norwich, cut down a legacy she had left Porson to £30 on being told that he had written what was described to her as a book against Christianity.

During the years that followed he continued to contribute to the leading reviews, writing in the *Monthly Review* the articles on Robertson's *Parian Chronicle*, Edwards's *Plutarch*, and R. Payne Knight's *Essay on the Greek Alphabet*. He gave assistance to William Beloe in one or two articles in the *British Critick*, and probably wrote also in the *Analytical Review* and the *Critical Review*.

In 1792 his fellowship was no longer tenable by a layman; and, rather than undertake duties for which he felt himself unfit, and which involved subscription to the Articles (though he had no difficulty as to signing a statement as to his conformity with the liturgy of the Church of England when elected Greek professor), he determined not to take holy orders, which would have enabled him to remain a fellow, and thus deprived himself of his only means of subsistence. He might have been retained in the society by being appointed to a lay fellowship, one of the two permanent lay fellowships which the statutes then permitted falling vacant just in time. It is said that this had been promised him, and it was certainly the custom in the college always to appoint the senior among the existing laymen, who otherwise would vacate his fellowship. But the master (Dr Postlethwaite), who had the nomination, used his privilege to nominate a younger man (John Heys), a nephew of his own, and thus Porson was turned adrift without any means of support. A subscription was, however, got up among his friends to provide an annuity to keep him from actual want; Cracherode, Cleaver Banks, Burney and Parr took the lead, and enough was collected to produce about £100 a year. He accepted it only on the condition that he should receive the interest during his lifetime, and that the principal, placed in the hands of trustees, should be returned to the donors at his death. When this occurred they or their survivors refused to receive the money, and it was with part of this sum that, in 1816, the Porson prize was founded to perpetuate his name at Cambridge. The remainder was devoted to the foundation of the Porson scholarship in the same university. This scholarship was first awarded in 1855.

After the loss of his fellowship he continued chiefly to reside in London, having chambers in Essex Court, Temple—occasionally visiting his friends, such as Dr Goodall at Eton and Dr Samuel Parr at Hatton. It was at Dr Goodall's house that the *Letters to Travis* were written, and at one period of his life he spent a great deal of time at Hatton. While there he would generally spend his mornings in the library, and for the most part in silence; but in the evenings, especially if Parr were away, he would collect the young men of the house about him, and pour forth from memory torrents of every kind of literature. The charms of his society are described as being then irresistible.

In 1792 the Greek professorship at Cambridge became vacant by the resignation of Mr Cooke. To this Porson was elected without opposition, and he continued to hold it till his death. The duties then consisted in taking a part in the examinations for the university scholarships and classical medals. It was said he wished to give lectures; but lecturing was not in fashion in those days, and he did far more to advance the knowledge and study of the Greek language by his publications than he could have done by any amount of lecturing. It must be remembered that the emoluments of the professorship were only £40 a year. The authors on which his time was chiefly spent were the tragedians, Aristophanes, Athenaeus, and the lexicons of Suidas, Hesychius and Photius. This last he twice transcribed (the first transcript having been destroyed by a fire at Perry's house, which deprived the world of much valuable matter that he had written on the margins of his books) from the original among the Gale MSS. in the library of Trinity College. Of the brilliancy and accuracy of his emendations on Aristophanes, the fragments of the other comic poets, and the lexicographers he had a pleasing proof on one occasion when he found how often in Aristophanes he had been anticipated by Bentley, and on another when Schow's collation of the unique MS. of Hesychius appeared and proved him right in "an incredible number" of instances.

In 1795 there appeared from Foulis's press at Glasgow an

edition of *Aeschylus* in folio, printed with the same types as the Glasgow *Homer*, without a word of preface or anything to give a clue to the editor. Many new readings were inserted in the text with an asterisk affixed, while an obelus was used to mark many others as corrupt. It was at once recognized as Porson's work; he had superintended the printing of a small edition in two vols. 8vo, but this was kept back by the printer and not issued till 1806, still without the editor's name. There are corrections of many more passages in this edition than in the folio; and, though the text cannot be considered as what would have gone forth if with his name and sanction, yet more is done for the text of *Aeschylus* than had been accomplished by any preceding editor. It has formed the substratum for all subsequent editions. It was printed from a copy of Pauw's edition corrected, which is preserved in the library of Trinity College.

Soon after this, in 1797, appeared the first instalment of what was intended to be a complete edition of Euripides—an edition of the *Hecuba*.

In the preface he pointed out the correct method of writing several words previously incorrectly written, and gave some specimens of his powers on the subject of Greek metres. The notes are very short, almost entirely critical; but so great a range of learning, combined with such felicity of emendation whenever a corrupt passage was encountered, is displayed that there was never any doubt as to the quarter whence the new edition had proceeded. He avoided the office of interpreter in his notes, which may well be wondered at on recollecting how admirably he did translate when he condescended to that branch of an editor's duties.

His work, however, did not escape attack; Gilbert Wakefield had already published a *Tragoediarum delectus*; and, conceiving himself to be slighted, as there was no mention of his labours in the new *Hecuba*, he wrote a "diatribe extemporalis" against it, a tract which for bad taste, bad Latin and bad criticism it would not be easy to match. Gottfried Hermann of Leipzig, then a very young man, who had also written a work on Greek metres, which Dr Elmsley has styled "a book of which too much ill cannot easily be said," issued an edition of the *Hecuba*, in which Porson's theories were openly attacked. Porson at first took no notice of either, but went on quietly with his Euripides, publishing the *Orestes* in 1798, the *Phoenissae* in 1799 and the *Medea* in 1801, the last printed at the Cambridge press, and with the editor's name on the title-page. But there are many allusions to his antagonists in the notes on such points as the final *v*, the use of accents, &c.; and on v. 675 of the *Medea* he holds up Hermann by name to scorn in caustic and taunting language. And it is more than probable that to Hermann's attack we owe the most perfect of his works, the supplement to the preface to the *Hecuba*, prefixed to the second edition published at Cambridge in 1802. The metrical laws promulgated are laid down clearly, illustrated with an ample number of examples, and those that militate against them brought together and corrected, so that what had been beyond the reach of the ablest scholars of preceding times is made clear to the tyro. The laws of the iambic metre are fully explained, and the theory of the pause stated and proved, which had been only alluded to in the first edition. A third edition of the *Hecuba* appeared in 1808, and he left corrected copies of the other plays, of which new editions appeared soon after his death; but these four plays were all that was accomplished of the projected edition of the poet. Porson lived six years after the second edition of the *Hecuba* was published, but his natural indolence and procrastination led him to put off the work. He found time, however, to execute his collation of the Harleian MS. of the *Odyssey*, published in the Grenville *Homer* in 1801, and to present to the Society of Antiquaries his wonderful conjectural restoration of the Rosetta stone.

In 1806, when the London Institution was founded (then in the Old Jewry, since removed to Finsbury Circus), he was appointed principal librarian with a salary of £200 a year and a suite of rooms; and thus his latter years were made easy as far as money was concerned.

Among his most intimate friends was Perry, the editor of the *Morning Chronicle*; and this friendship was cemented by his marriage with Perry's sister, Mrs Lunan, in November 1796. The marriage was a happy one for the short time it lasted, as Porson became more attentive to times and seasons, and would have been weaned from his habits of drinking; but she sank in a decline a few months after her marriage (April 12, 1797), and he returned to his chambers in the Temple and his old habits. Perry's friendship was of great value to him in many ways; but it induced him to spend too much of his time in writing for the *Morning Chronicle*; indeed he was even accused of "giving up to Perry what was meant for mankind," and the existence of some of the papers he wrote there can be only deplored.

For some months before his death he had appeared to be failing: his memory was not what it had been, and he had some symptoms of intermittent fever; but on the 19th of September 1808 he was seized in the street with a fit of apoplexy, and after partially recovering sank in the 25th of that month at the age of forty-nine. He was buried in Trinity College, close to the statue of Newton, at the opposite end of the chapel to where rest the remains of Bentley.

In learning Porson was superior to Valckenaer, in accuracy to Bentley. It must be remembered that in his day the science of comparative philology had scarcely any existence; even the comparative value of MSS. was scarcely considered in editing an ancient author. With many editors MSS. were treated as of much the same value, whether they were really from the hand of a trustworthy scribe, or what Bentley calls "scrub manuscripts," or "scoundrel copies." Thus, if we are to find fault with Porson's way of editing, it is that he does not make sufficient difference between the MSS. he uses, or point out the relative value of the early copies whether in MS. or print. Thus he collates minutely Lascaris's edition of the *Medea*, mentioning even misprints in the text, rather from its rarity and costliness than from its intrinsic value. And his wonderful quickness at emendation has sometimes led him into error, which greater investigation into MSS. would have avoided; thus, in his note on Eur., *Phoen.* 1373 an error, perhaps a misprint ($\kappa\epsilon$ for $\mu\epsilon$), in the first edition of the scholiast on Sophocles has led him into an emendation of v. 339 of the *Trachiniae* which clearly will not stand. But his most brilliant emendations, such as some of those on Athenaeus, on the *Supplices* of Aeschylus, or, to take one single instance, that on Eur. *Helen.* 751 (*ὄδδ' Ἐνεὸς for ὄδδὲν γε*; see Maltby's *Thesaurus*, p. 299), are such as convince the reader of their absolute certainty; and this power was possessed by Porson to a degree no one else has ever attained. No doubt his mathematical training had something to do with this; frequently the process may be seen by which the truth has been reached.

A few words are called for on his general character. No one ever more loved truth for its own sake; few have sacrificed more rather than violate their consciences, and this at a time when a high standard in this respect was not common. In spite of his failings, few have had warmer friends; no one more willingly communicated his knowledge and gave help to others; scarcely a book appeared in his time or for some years after his death on the subjects to which he devoted his life without acknowledging assistance from him. And, if it be remembered that his life was a continued struggle against poverty and slight and ill-health, rather than complain that he did little, we should wonder how he accomplished so much.

His library was divided into two parts, one of which was sold by auction; the other, containing the transcript of the Gale Photius, his books with MS. notes, and some letters from foreign scholars, was bought by Trinity College for 1000 guineas. His notebooks were found to contain, in the words of Bishop Blomfield, "a rich treasure of criticism in every branch of classical literature—everything carefully and correctly written and sometimes rewritten—quite fit to meet the public eye, without any diminution or addition." They have been carefully rearranged, and illustrate among other things his extraordinary penmanship and power of minute and accurate writing. Much remains unpublished. J. H. Monk, his successor as Greek professor, and C. J. Blomfield (both afterwards bishops) edited the *Adversaria*, consisting of the notes on Athenaeus and the Greek poets, and his prelection on Euripides; P. P. Dobree, afterwards Greek professor, the notes on Aristophanes and the lexicon of Photius. Besides these, from other sources, Professor T. Gaisford edited his notes on Pausanias and Suidas, and Mr Kidd collected his scattered reviews. And, when Bishop Burgess attacked his literary character on the score of his *Letters to Travis*, Professor Turton (afterwards Bishop of Ely) came forward with a vindication.

The chief sources for Porson's life will be found in the memoirs in the *Gentleman's Magazine* for September and October 1808, and other periodicals of the time (mostly reprinted in Barker's *Porsonian*; London, 1852); Dr Young's memoir in former editions of the *Ency. Brit.* (reprinted *ibid.* and in his works); Weston's (utterly worthless) *Short Account of the late Mr Richard Porson*

(London, 1808; reissued with a new preface and title-page in 1814); Dr Clarke's narrative of his last illness and death (London, 1808; reprinted in the *Classical Journal*); Kidd's "Imperfect Outline of the Life of R.P.," prefixed to his collection of the *Tracts and Criticisms*; Beloe's *Sexagenarian* (not trustworthy), vol. i. (London, 1817); Barker's *Parricana*, vol. ii. (London, 1829); Maltby's "Porsonian," published by Dyce in the volume of *Recollections of the Table-Talk of Samuel Rogers* (London, 1856); a life in the *Cambridge Essays* for 1857 by H. R. Luard; and a lengthy life by J. S. Watson (London, 1861). See also R. C. Jebb in *Dict. Nat. Biog.*, and J. E. Sandys, *History of Classical Scholarship*, ii. 424-430 (with copy of portrait by Hoppner; 1908).

The dates of Porson's published works are as follows: *Notae in Xenophontis anabasin* (1786); Appendix to Toup (1790); *Letters to Travis* (1790); *Aeschylus* (1795, 1806); *Euripides* (1797-1802); collation of the Harleian MS. of the *Odyssey* (1801); *Adversaria* (Monk and Blomfield, 1812); *Tracts and Criticisms* (Kidd, 1815); *Aristophania* (Dobree, 1820); *Notae in Pausaniam* (Gaisford, 1820); *Photii lexicon* (Dobree, 1822); *Notae in Suidam* (Gaisford, 1834); *Correspondence* (Luard, edited for the Cambridge Antiquarian Society, 1867). Dr. Turton's vindication appeared in 1827.

(H. R. L.; J. E. S. *)

PORT. (1) (From the Lat. *portus*, harbour), a place to which ships may resort for the unloading or taking in of cargo, or for shelter, a harbour, also a town possessing such a harbour, a "seaport," or "seaport town," especially one where custom-house officers are stationed. As the name of a dark red Portuguese wine, the word is a shortened form of Oporto, *i.e.* the port, the chief centre of the wine-shipping trade of Portugal (see WINE). (2) (Through the Fr. *porte*, from Lat. *porta*, gate), an entrance or opening, not often used in the sense of gate, except in such compounds as "sallyport," cf. "portcullis," and in the derivative "porter," a keeper of a door or gate, especially of a public building, hotel, college, &c. The most general use of the word is for an opening for the admission of light and air in a ship's side, and formerly in ships of war for an embrasure for cannon, a "port-hole." For the application of the word to the left side of a ship, taking the place of the earlier "larboard," and its disputed origin, see STARBOARD AND LARBOARD. (3) (Through the Fr. *porter*, from Lat. *portare*, to carry, bear), properly outward bearing or deportment, whence "portly," originally of dignified or majestic bearing, now chiefly used in the sense of stout or corpulent. The verb "to port" is only used as a military term "to port arms," *i.e.* to hold the rifle across and close to the body, the barrel being placed opposite to the left shoulder. Derivatives are "port-fire" (Fr. *porte-feu*), a fuse for firing rockets, &c., and formerly for the discharge of artillery, and "porter," *i.e.* one who carries a burden, particularly a servant of a railway company, hotel, &c., who carries passengers' luggage to and from a station, &c. The term "porter" has been applied, since the 18th century, to a particular form of beer, dark brown or almost black in colour (see BEER and BREWING). The finer kinds of this beer are generally now known as "stout." The name is almost certainly due to the fact that it was from the first a favourite drink among the London "porters," the street carriers of goods, luggage, &c., and in early uses the drink is called porter's ale, porter's beer, or porter-beer.

PORT ADELAIDE, a port of Adelaide county, South Australia, 7½ m. by rail N.W. of Adelaide. Pop. of the town and suburbs (1901), 20,080. It is situated on an estuary 9 m. from St Vincent Gulf and is the principal shipping port of South Australia. Its wharves, equipped with steam and travelling cranes, and tramways, are 2½ m. in extent; it has docks and a number of patent slips capable of taking up vessels of 300 to 1500 tons. There are also piers at Semaphore and Larg's Bay, on the other side of Lefevre's Peninsula some 2 m. distant, which are connected with Port Adelaide by rail. The industries comprise silver and copper smelting, brewing, sawmilling, ropemaking, flourmilling, sugar-refining and yacht-building. The harbour is protected by two forts known as the Fort Glanville batteries. The suburbs, which are connected with the town by tramways, are Alberton, Queenstown, Yatala, Rosewater and Kingston-on-the-Hill.

PORTADOWN, a market town of county Armagh, Ireland, on the river Bann and the Great Northern railway, 25 m. W.S.W. of Belfast. Pop. (1901), 10,092. It is a junction of

lines from Dublin, Clones and Omagh. The Bann, which is connected with the Newry Canal and falls into Lough Neagh 5 m. north of the town, is navigable for vessels of 90 tons burden. It is crossed at Portadown by a stone bridge of seven arches, originally built in 1764, but since then re-erected. The manufacture of linen and cotton is carried on, and there is a considerable trade in pork, grain and farm produce. In the reign of Charles I. the manor was bestowed on John Obyns, who erected a mansion and a few houses, which were the beginning of the town. A grain-market was established in 1780. The town is governed by an urban district council.

PORTAELS, JEAN FRANÇOIS (1818-1895), Belgian painter, was born at Vilvorde (Brabant), in Belgium, on the 30th of April 1818. His father, a rich brewer, sent him to study in the Brussels Academy, and the director, François Navez, ere long received him as a pupil in his own studio. About 1841 Portaels went to Paris, where he was kindly received by Paul Delaroche. Having returned to Belgium, he carried off the Grand Prix de Rome in 1842. He then travelled through Italy, Greece, Morocco, Algeria, Egypt, the Lebanon, Judaea, Spain, Hungary and Norway. On his return to Belgium in 1847 Portaels succeeded H. Vanderhaert as director of the academy at Ghent. In 1849 he married the daughter of his first master, Navez, and in 1850 settled at Brussels; but as he failed in obtaining the post of director of the academy there, and wished, nevertheless, to carry on the educational work begun by his father-in-law, he opened a private studio-school, which became of great importance in the development of Belgian art. He again made several journeys, spending some time in Morocco; he came back to Brussels in 1874, and in 1878 obtained the directorship of the academy which had so long been the object of his ambition. Portaels executed a vast number of works. Decorative paintings in the church of St Jacques-sur-Caudenberg; biblical scenes, such as "The Daughter of Sion Reviled" (in the Brussels Gallery), "The Death of Judas," "The Magi travelling to Bethlehem," "Judith's Prayer," and "The Drought in Judaea"; genre pictures, among which are "A Box in the Theatre at Budapest" (Brussels Gallery), portraits of officials and of the fashionable world, Oriental scenes and, above all, pictures of fancy female figures and of exotic life. "His works are in general full of a facile grace, of which he is perhaps too lavish," wrote Théophile Gautier. Yet his pleasing and abundant productions as a painter do not constitute Portaels's crowning merit. The high place his name will fill in the history of contemporary Belgian art is due to his influence as a learned and clear-sighted instructor, who formed, among many others, the painters E. Wauters and E. Agneesens, the sculptor Ch. van der Stappen, and the architect Licot. He died at Brussels on the 8th of February 1895.

See E. L. de Taeye, *Peintres belges contemporains*; J. du Jardin, *L'Art flamand*. (F. K. *)

PORTAGE, a city and the county-seat of Columbia county, Wisconsin, U.S.A., on the Wisconsin river, about 85 m. N.W. of Milwaukee. Pop. (1890) 5143; (1900) 5459, of whom 1184 were foreign-born; (1910 U.S. census) 5440. It is served by the Chicago, Milwaukee & St Paul, and the Minneapolis, St Paul & Sault Ste Marie railways. The city is situated at the west end of the government ship canal connecting the Fox and Wisconsin rivers, and river steamboats ply during the open season between Portage and Green Bay and intermediate points in the Fox River Valley, Portage being the head of navigation on the Fox. Portage is in the midst of a fertile farming region, and has a trade in farm and dairy products and tobacco. Its manufactures include brick, tile, lumber, flour, pickles, knit goods, steel tanks and marine engines and launches, and there are several tobacco warehouses and grain elevators. As the Fox and Wisconsin rivers are here only 2 m. apart, these rivers were the early means of communication between Lake Michigan and the Mississippi river. The first Europeans known to have visited the site of the city were Radisson and Groseilliers, who crossed the portage in 1655. The portage was used by Marquette and Joliet on their way to the Mississippi in 1673, and a

red granite monument commemorates their passage. About 1712 the Fox Indians disputed the passage of the portage, precipitating hostilities which continued intermittently until 1743. The first settler was Lawrence Barth, who engaged in the carrying trade here in 1793. Jacques Vieau established a trading post here in 1797, and by 1820 it was a thriving dépôt of the fur trade. During the Red Bird uprising (1827) a temporary military post was established by Major William Whistler of the U.S. army. Fort Winnebago was begun in the following year, was remodelled and completed by Lieut. Jefferson Davis in 1832, and was subsequently abandoned. It was from there in the same year that the final and successful campaign against Black Hawk was begun. After several failures the Fox-Wisconsin canal was completed in 1856, and in June of that year the "Aquila," a stern-wheeler, passed through the canal on its way from Pittsburg to Green Bay. The shifting channel of the Wisconsin has retarded navigation, and the canal has never been as important commercially as was expected.

PORTAGE LA PRAIRIE, a port of entry and the chief town of Portage la Prairie county, Manitoba, Canada, situated 50 m. W. of Winnipeg, on the Canadian Pacific and Canadian Northern railways, at an altitude of 854 ft. above the sea. Pop. (1901), 3901. It is in the midst of a fine agricultural district, into which several branch railways extend, and carries on a large export trade in grain and other farm produce.

PORTALEGRE, an episcopal city, capital of the district of Portalegre, Portugal; 8 m. N. of Portalegre station, on the Lisbon-Badajoz-Madrid railway. Pop. (1900), 11,820. Portalegre is the Roman *Amaea* or *Ammaia*, and numerous Roman and prehistoric remains have been discovered in the neighbourhood. The principal buildings are the cathedral, the ruined Moorish citadel and two more modern forts. The administrative district of Portalegre, in which the rearing of swine, the production of grain, wine and oil, and the manufacture of woollen and cotton goods and corks are the principal industries, coincides with the northern part of the ancient province of Alemtejo (*q.v.*). Pop. (1900), 124,443; area, 2405 sq. m.

PORTALIS, JEAN ÉTIENNE MARIE (1746-1807), French jurist, came of a bourgeois family, and was born at Bausset in Provence on the 1st of April 1746. He was educated by the Oratorians at their schools in Toulon and Marseilles, and then went to the university of Aix; while a student there he published his first two works, *Observations sur Émile* in 1763 and *Des Préjugés* in 1764. In 1765 he became an *avocat* at the parlement of Aix, and soon obtained so great a reputation that he was instructed by the duc de Choiseul in 1770 to draw up the decree authorizing the marriage of Protestants. From 1778 to 1781 he was one of the four assessors or administrators of Provence. In November 1793, after the republic had been proclaimed, he came to Paris and was thrown into prison, being the brother-in-law of Joseph Jérôme Siméon, the leader of the Federalists in Provence. He was soon removed through the influence of B. de V. Barère to a *maison de santé*, where he remained till the fall of Robespierre. On being released he practised as a lawyer in Paris; and in 1795 he was elected by the capital to the Conseil des Anciens, becoming a leader of the moderate party opposed to the directory. As a leader of the moderates he was proscribed at the *coup d'état* of Fructidor, but, unlike General Charles Pichegru and the marquis de Barbé-Marbois, he managed to escape to Switzerland, and did not return till Bonaparte became First Consul. Bonaparte made him a *conseiller d'état* in 1800, and then charged him, with F. D. Tronchet, Bigot de Préameneu, and Jacques de Maleville, to draw up the *Code Civil*. Of this commission he was the most industrious member, and many of the most important titles, notably those on marriage and heirship, are his work. In 1801 he was placed in charge of the department of *cultes* or public worship, and in that capacity had the chief share in drawing up the provisions of the Concordat. In 1803 he became a member of the Institute, in 1804 minister of public worship, and in 1805 a knight grand cross of the Legion of Honour. He soon after became totally

blind; and after an operation he died at Paris on the 25th of August 1807.

The work of Portalis appears in the *Code Napoléon*, but see also Frederick Portalis's *Documents, rapports, et travaux inédits sur le Code Civil* (1844) and *Sur le Concordat* (1845); for his life, see the biography in the edition of his *Oeuvres* by F. Portalis (1823) and René Lavolée, *Portalis, sa vie et ses œuvres*, (Paris, 1869).

His son, JOSEPH MARIE PORTALIS (1778-1858), entered the diplomatic service, and obtaining the favour of Louis XVIII. filled many important offices. He was under-secretary of state for the ministry of justice, first president of the court of cassation, minister for foreign affairs, and in 1851 a member of the senate.

PORTARLINGTON, a market town situated partly in King's county but chiefly in Queen's county, Ireland, on both banks of the river Barrow, here the county boundary. Pop. (1901), 1943. The railway station, a mile south of the town, is an important junction, 42 m. west by south from Dublin, of the Great Southern & Western system, where the branch line to Athlone leaves the main line. Monthly fairs are held, and there is considerable local trade. After the revocation of the edict of Nantes a colony of French refugees was established here in the reign of William III., and the beautiful church of St Paul (rebuilt in 1857) was devoted to their use, services being conducted in the French language, for which reason the church is still spoken of as the "French Church." The former name of the town was Cooltetoadera, but on the property passing into the hands of Lord Arlington in the reign of Charles II. the name was changed. Emo Park, 5 m. south of the town, is the fine demesne of the earls of Portarlington, a title granted to the family of Dawson in 1785. An obelisk on Spire Hill near the town is one of the many famine relief works in Ireland. On the river, close to the town, there are picturesque remains of Lea Castle, originally built c. 1260. Portarlington was incorporated in 1667, and was a parliamentary borough both before the Union and after, its representation in the imperial parliament (by one member) being merged in that of the county by the Redistribution Act of 1885.

PORT ARTHUR (formerly Prince Arthur's Landing), a town and harbour in Thunder Bay District, Ontario, Canada, on Lake Superior, and the Canadian Pacific, Grand Trunk Pacific, and Canadian Northern railways, and the lake terminus of the two latter. Pop. (1901), 3214. The lake terminus of the Canadian Pacific, originally here, has been moved to Fort William, 4 m. distant. Lumber and minerals are shipped from the surrounding district, and vast quantities of grain from the farther west.

PORT ARTHUR (Chinese, *Lu-shun-k'ou*), a fortress situated at the extreme south of the peninsula of Liao-tung in the Chinese principality of Manchuria. It was formerly a Chinese naval arsenal and fortress, but was captured by the Japanese in 1894, who destroyed most of the defensive works. In 1898 it was leased to Russia with the neighbouring port of Talienwan, and was gradually converted into a Russian stronghold. In 1905 the lease was transferred to Japan. The port or harbour is a natural one, entirely landlocked except to the south. The basin inside is of limited extent. Barren and rocky hills rise from the water's edge all round. A railway 270 m. long connects the port with Mukden and the trans-Siberian line; there is also railway connexion with Peking. The harbour is ice-free all the year round, a feature in which it contrasts favourably with Vladivostok.

The Liao-tung peninsula, separated from Korea by the Bay of Korea, and from the Chinese mainland by the Gulf of Liao-tung, runs in a south-westerly direction from the mainland of Manchuria, and is continued by a group of small islands which reach another peninsula projecting from the mainland of China in a north-easterly direction, and having at its north-eastern extremity the port of Wei-hai-wei. The Liao-tung peninsula is indented by several bays, two of which nearly meet, making an isthmus less than 2 m. wide, beyond which the peninsula slightly widens again, this part of it having the name of Kan-tun (regent's sword). Two wide bays open on the eastern shore of the latter: Lu-shun-k'ou (Port Arthur) and Talienwan. Both were leased to Russia. Lu-shun-k'ou Bay

is nearly 4 m. long and 1½ m. wide, the entrance being only 350 yds. wide. The Chinese deepened the bay artificially and erected quays. The roadstead is exposed to south-easterly winds, and in this respect the wider Bay of Talienwan is safer. Coal is found near to the port. The climate is very mild, and similar to that of south Crimea, only moister.

While in occupation by the Russians Port Arthur became Europeanized. The military port, Tairen, is a few miles to the north. During the Russo-Japanese war the Japanese assailed Port Arthur both by land and sea and, after repeated assaults, on the 1st of January 1905, General Stoessel surrendered the citadel into the hands of the Japanese.

PORTAS, or **PORTUARY**, a breviary (*q.v.*) of such convenient size that it could be carried on the person, whence its Latin name *portiforium* (*portare*, to carry, *foris*, out of doors, abroad). The English word was adapted from the Old French *portehors*, and took a large number of forms, e.g. *porthors*, *porteous*, *portes*, &c. In Scots law, the "porteous-roll" was the name given formerly to a list of criminals drawn up by the justice-clerk on information given by the local authorities, together with the names of witnesses, and charges made.

PORTATIVE ORGAN, a small medieval organ carried by the performer, who manipulated the bellows with one hand and fingered the keys with the other. This small instrument was necessarily made as simple as possible. On a small rectangular wind chest or reservoir, fed by means of a single bellows placed at the back, in front, or at the right side, were arranged the pipes—one, two or three to a note—supported by more or less ornamental uprights and an oblique bar. The most primitive style of keyboard consisted merely of sliders pushed in to make the note sound and restored to their normal position by a horn spring; the reverse action was also in use, the keys being furnished with knobs or handles.

Towards the middle of the 13th century the portatives represented in the miniatures of illuminated MSS. first show signs of a real keyboard with balanced keys, as in the 13th century Spanish MS., known as the *Cantigas de Santa Maria*,¹ containing four full pages of miniatures of instrumentalists, fifty-one in number. From the position of the performer's thumb it is evident that the keys are pressed down to make the notes sound. There are nine pipes and the same number of keys, sufficient for the diatonic octave of C major with the B flat added. The pipes put into these small organs were flue pipes, their intonation must have been very unstable owing to the irregularity of the wind supply fed by a single bellows, the pressure being at the mercy of the performer's hand. Increased pressure in pipes with fixed mouthpieces, such as organ pipes, produces a rise in pitch. These medieval portative organs, so extensively used during the 14th and 15th centuries, were revivals of those used by the Romans, of which a specimen excavated at Pompeii in 1876 is preserved in the Museum at Naples. The case measures 14½ in. by 9½ in. and contains nine pipes, of which the longest measures but 9½ in.; six of the pipes have oblong holes at a short distance from the top similar to those made in *gamba* pipes of modern organs to give them their reedy quality, and also to those cut in the bamboo pipes of the Chinese *Cheng*, which is a primitive organ furnished with free reeds. From the description of these remains by C. F. Abdy Williams,² it would seem that a bronze plate 11½ in. by 2½ in. having 18 rectangular slits arranged in three rows to form vandykes was found inside the case, with three little plates of bronze just wide enough to pass through the slits lying by it; this plate possibly formed part of the mechanism for the sliders of the keys. The small instrument often taken for a syrinx on a contorniate of Sallust in the Cabinet Impérial de France in Paris may be meant for a miniature portative. (K. S.)

PORT AUGUSTA, a seaport of Frome county, South Australia, on the east shore of Spencer Gulf, 259 m. by rail N.N.W. of Adelaide. Pop. about 2400. It has a fine natural deep and landlocked harbour, and the government wharves have berthing for large vessels. The chief exports are wool, wheat, flour, copper, hides and tallow. Port Augusta is the seat of a Roman Catholic bishop and has a cathedral, while its town-hall is the finest in the state, that of Adelaide excepted. It is also the starting point of the Great Northern railway. The largest ostrich farm in Australia lies 8 m. from the town. The neighbourhood is rich in minerals, copper, silver, iron and coal have been found,

¹ For a reproduction see J. F. Riaño, *Studies of Early Spanish Music*, pp. 119-127 (London, 1887).

² *Quarterly Musical Review* (August, 1893).

and in 1900 valuable gold quartz reefs were discovered at Tarcoola.

PORT AU PRINCE (originally *L'Hôpital*, and for brief periods *Port Henri* and *Port Républicain*), the capital of the republic of Haiti, West Indies, situated at the apex of the triangular bay which strikes inland for about 100 m. between the two great peninsulas of the west coast, with its upper recesses protected by the beautiful island of Gonaives (30 m. long by 2 broad). The city is admirably situated on ground that soon begins to rise rapidly towards the hills. It was originally laid out by the French on a regular plan with streets of good width running north and south and intersected by others at right angles. Everything has been allowed to fall into disorder and disrepair, and to this its public buildings form no exception. Every few years whole quarters of the town are burned down, but the people go on building the same slight wooden houses, with only here and there a more substantial warehouse in brick. In spite of the old French aqueduct the water-supply is defective. From June to September the heat is excessive, reaching 95° to 99° F. in the shade. The population, mostly negroes and mulattoes, is estimated at 61,000. Port au Prince was first laid out by M. de la Cuza in 1749. In 1751, and again in 1770, it was destroyed by earthquakes.

PORT BLAIR, the chief place in the convict settlement of the Andaman Islands in the Indian Ocean, situated on the south-east shore of the South Andaman Island, in 11° 42' N., 93° E. It derives its name from Lieut. Blair, R.N., who first occupied it in 1789, as a station for the suppression of piracy and the protection of shipwrecked crews. Abandoned on account of sickness in 1796, it was not again occupied until 1856. It possesses one of the best harbours in Asia, while its central position in the Bay of Bengal gives it immense advantage as a place of naval rendezvous. (See ANDAMAN ISLANDS.)

PORT CHESTER, a village of Westchester county, New York, U.S.A., in the south-east part of the state, on Long Island Sound, and about 10 m. N.E. of New York City (26 m. from the Grand Central Station). Pop. (1900), 7440, of whom 2110 were foreign-born; (1910 census), 12,809. It is served by the New York, New Haven & Hartford railroad, and by daily steamers to and from New York City. The village is a summer resort as well as a suburban residential district for New York City. Among its public institutions are a library, a park and a hospital. The village has various manufactures, including bolts and nuts, motors for racing boats and automobiles; there are also large planing and wood-moulding mills. The earliest mention of Port Chester in any extant record is in the year 1732. Until 1837 it was known as Saw Pit, on account of a portion of the village, it is said, being used as a place for building boats. During the War of Independence the village was frequently occupied by detachments of American troops. Port Chester was incorporated as a village in 1868.

PORTCULLIS (from the Fr. *porte-coulisse*, *porte*, a gate, Lat. *porta*, and *coulisse*, a groove, used adjectivally for "sliding," from *couler*, to slide or glide, Lat. *colare*; the Fr. equivalents are *herse*, a harrow, and *coulisse*; Ger. *Fallgatter*; Ital. *saracinesca*), a strong-framed grating of oak, the lower points shod with iron, and sometimes entirely made of metal, hung so as to slide up and down in grooves with counterbalances, and intended to protect the gateways of castles, &c. The defenders having opened the gates and lowered the portcullis, could send arrows and darts through the gratings. A portcullis was in existence until modern times in a gateway at York. The Romans used the portcullis in the defence of gateways. It was called *cataracta* from the Gr. *καταράκτης*, a waterfall (*καταρῆγνυσθαι*, to fall down). Vegetius (*De re milit.* iv. 4) speaks of it as an old means of defence, and it has been suggested that in Psalm xxiv. 7, 9, "Lift up your heads, oh ye gates," &c., there is an allusion to a similar contrivance. Remains of a *cataracta* are clearly seen in the gateway of Pompeii. The Italian name *saracinesca* originates from the crusades. (See GATE.)

PORTE, THE SUBLIME (Arab. *babi-ali*, the high gate, through the French translation *la sublime porte*), in Turkey, the

official name for the government, derived from the high gate giving access to the building where the offices of the principal state departments are situated.

PORT ELIZABETH, a seaport of the Cape province, South Africa, in Algoa Bay, by which name the port is often designated. It lies in 35° 57' S., 25° 37' E. on the east side of Cape Recife, being by sea 436 m. from Cape Town and 384 m. from Durban. In size and importance it is second only to Cape Town among the towns of the province. It is built partly along the seashore and partly on the slopes and top of the hills that rise some 200 ft. above the bay. The Baaken's River, usually a small stream, but subject (as in 1908) to disastrous floods, runs through the town, which consists of four divisions; the harbour and business quarter at the foot of the cliffs, the upper part, a flat table-land known as "The Hill"; "The Valley" formed by the Baaken's River; and "South Hill," east of the river.

The Town.—Jetty Street leads from the north jetty to the market square, in or around which are grouped the chief public buildings—the town-hall, court-house, post office, market buildings, public library, St Mary's church (Anglican) and St Augustine's (Roman Catholic). Several of these buildings are of considerable architectural merit and fine elevation. The library, of Elizabethan design, contains some 45,000 volumes. The market buildings, at the south-east corner of the square, and partly excavated from the sides of the cliff, contain large halls for the fruit, wool and feather markets and the museum. Feather-Market Hall, where are held the sales of ostrich feathers, seats 5000 persons. The museum has valuable ethnographical and zoological collections. Other public buildings include a synagogue and a Hindu temple. Leading west from Market Square is Main Street, in which are the principal business houses. Between Main Street and the sea is Strand Street, also a busy commercial thoroughfare. Behind the lower town streets rise in terraces to "The Hill," a residential district. Here is an open plot of ground, Donkin Reserve, containing the lighthouse and a stone pyramid with an inscription in memory of Elizabeth, wife of Sir Rufane Donkin, described as "one of the most perfect of human beings, who has given her name to the town below." A fountain, surmounted by the statue of a war-horse, erected by public subscription in 1905 commemorates "the services of the gallant animals which perished in the Anglo-Boer war, 1899–1902." Farther west is a large hospital, one of the finest institutions of its kind in South Africa. At the southern end of The Hill is St George's Park, which has some fine trees, in marked contrast to the general treeless, barren aspect of the town. Port Elizabeth indeed possesses few natural amenities, but its golf links are reputed the finest in South Africa. The town, apart from its transit trade and the industries connected therewith, has some manufactures—jam and confectionery works; oil, candle and explosive works; saw and flour mills; tanneries, &c. It has an excellent water supply.

The Harbour.—There is no enclosed basin, but the roadstead has excellent holding ground, protected from all winds except the south-east, the prevailing wind being westerly. No harbour or light dues are charged to vessels of any flag. The port has three jetties of wrought iron, respectively 1162, 1152 and 1462 ft. in length, extending to the four fathoms line. These jetties are provided with hydraulic cranes, &c., and railways connect them with the main line, so that goods can be sent direct from the jetties to every part of South Africa. In favourable weather vessels drawing up to 21 ft. can discharge cargo alongside the jetties. In unfavourable conditions and for larger steamers tugs and lighters are employed. Rough weather prevents discharge of cargo by lighters, on an average, seven days in the year. The customs-house and principal railway station are close to the north jetty. The port is state owned, and is under the administration of the harbour and railway board of the Union.

Trade.—Port Elizabeth has a large import trade, chiefly in textiles, machinery, hardware, apparel and provisions, supplying to a considerable extent the markets of Kimberley, Rhodesia, the Orange Free State and the Transvaal. The exports are mainly the products of the eastern part of the Cape province, the most important being ostrich feathers, wool and mohair. Skins, hides and maize are also exported. In 1855 the value of the imports was £376,000; in 1883 £2,364,000; in 1898 £6,248,000; in 1903 £10,137,000. Depression in trade brought down the imports in 1904 to £6,855,000. In 1906 they were £6,564,000 and in 1907 £6,004,000. The export trade has been of slower but more steady growth. It was valued at £584,000 in 1855, at £2,341,000 in 1883, £2,103,000 in 1898, £2,910,000 in 1903. Indicative of the fact that the agricultural community was little affected by the trade depression are the export figures for 1904 and 1906, which were £2,044,000 and £2,627,000 respectively. In 1907 goods valued at £3,150,000 were exported.

Population.—The population within the municipal area was at the 1904 census 32,959; that within the district of Port Elizabeth 46,626, of whom 23,782 were whites. Many of the inhabitants are of German origin and the Deutsche Liedertafel is one of the most popular clubs in the town.

History.—Algoa Bay was discovered by Bartholomew Diaz in 1488, and was by him named Bahia da Roca, probably with reference to the rocky islet in the bay, on which he is stated to have erected a cross (St Croix Island). After the middle of the 16th century the bay was called by the Portuguese Bahia da Lagoa, whence its modern designation. In 1754 the Dutch settlements at the Cape were extended eastwards as far as Algoa Bay. The convenience of reaching the eastern district by boat was then recognized and advantage taken of the roadstead sheltered by Cape Recife. In 1799, during the first occupation of Cape Colony by the British, Colonel (afterwards General Sir John) Vandeleur, to guard the roadstead, built a small fort on the hill west of the Baakens River. It was named Fort Frederick in honour of the then duke of York, and is still preserved. A few houses grew up round the fort, and in 1820 besides the military there was a civilian population at Fort Frederick of about 35 persons. In April of that year arrived in the bay the first of some 4000 British immigrants, who settled in the eastern district of the colony (See CAPE COLONY: *History*). Under the supervision of Sir Rufane Donkin, acting governor of the Cape, a town was laid out at the base of the hills. In 1836 it was made a free warehousing port, and in 1837 the capital of a small adjacent district. To overcome the difficulty of landing from the roadstead a breakwater was built at the mouth of the Baakens River in 1856, but it had to be removed in 1869, as it caused a serious accumulation of sand. The prosperity which followed the construction of railways to the interior earned for the port the designation of "the Liverpool of South Africa." Railway work was begun in 1873 and Port Elizabeth is now in direct communication with all other parts of South Africa. At the same period (1873) the building of the existing jetties was undertaken. Port Elizabeth has possessed municipal government since 1836. Its predominant British character is shown by the fact that not until 1909 was the foundation stone laid of the first Dutch Reformed Church in the town.

PORTEOUS, JOHN (d. 1736), captain of the city guard of Edinburgh, whose name is associated with the celebrated riots of 1736, was the son of Stephen Porteous, an Edinburgh tailor. Having served in the army, he was employed in 1715 to drill the city guard for the defence of Edinburgh in anticipation of a Jacobite rising, and was promoted later to the command of a force. In 1736 a smuggler named Wilson, who had won popularity by helping a companion to escape from the Tolbooth prison, was hanged; and, some slight disturbance occurring at the execution, the city guard fired on the mob, killing a few and wounding a considerable number of persons. Porteous, who was said to have fired at the people with his own hand, was brought to trial and sentenced to death. The granting of a reprieve was hotly resented by the people of Edinburgh, and on the night of the 7th of September 1736 an armed body of men in disguise broke into the prison, seized Porteous, and hanged him on a signpost in the street. It was said that persons of high position were concerned in the crime; but although the government offered rewards for the apprehension of the perpetrators, and although General Moyle wrote to the duke of Newcastle that the criminals were "well-known by many of the inhabitants of the town," no one was ever convicted of participation in the murder. The sympathies of the people, and even, it is said, of the clergy, throughout Scotland, were so unmistakably on the side of the rioters that the original stringency of the bill introduced into parliament for the punishment of the city of Edinburgh had to be reduced to the levying of a fine of £2000 for Porteous's widow, and the disqualification of the provost for holding any public office. The incident of the Porteous riots was used by Sir Walter Scott in *The Heart of Midlothian*.

See Sir Daniel Wilson, *Memorials of Edinburgh in the Olden Time* (2 vols. Edinburgh, 1848); *State Trials*, vol. xvii.; William Coxe, *Memoirs of the Life of Sir R. Walpole* (4 vols. London, 1816); Alexander Carlyle, *Autobiography* (Edinburgh, 1860), which gives the account of an eye-witness of the execution of Wilson; pamphlets (2 vols. in British Museum) containing *The Life and Death of Captain John Porteous*, and other papers relating to the subject; W. E. H. Lecky, *History of England in the Eighteenth Century*, ii. 324, note

(7 vols., London, 1892). See also Scott's notes to *The Heart of Midlothian*.

PORTER, BENJAMIN CURTIS (1843–), American artist, was born at Melrose, Massachusetts, on the 27th of August 1843. He was a pupil of A. H. Bicknell and of the Paris schools, and was elected an associate of the National Academy of Design, New York, in 1878, and a full academician in 1880. He is best known as a painter of portraits.

PORTER, DAVID (1780–1843), American naval officer, was born in Boston, Massachusetts, on the 1st of February 1780. His father, David, and his uncle, Samuel, commanded American ships in the War of Independence. In 1796 he accompanied his father to the West Indies; on a second and on a third voyage he was impressed on British vessels, from which, however, he escaped. He became a midshipman in the United States Navy in April 1798; served on the "Constellation" (Captain Thomas Truxton) and was midshipman of the foretop when the "Constellation" defeated the "Insurgente"; was promoted lieutenant in October 1799, and was in four successful actions with French ships in this year. In 1803, during the war with Tripoli, he was first lieutenant of the "Philadelphia" when that vessel grounded, was taken prisoner, and was not released until June 1805. He was commissioned master commandant in April 1806; in 1807–1810 served about New Orleans¹, where he captured several French privateers, and in 1812 was promoted captain. He commanded the frigate "Essex" in her famous voyage in 1812–1814. In the Atlantic he captured seven brigs, one ship, on the 13th of August 1812, the sloop "Alert," the first British war vessel taken in the War of 1812. Without orders from his superiors he then (February 1813) rounded Cape Horn, the harbours of the east coast of South America being closed to him. In the South Pacific he captured many British whalers (the British losses were estimated at £500,000), and on his own authority took formal possession (November 1813) of Nukahivah, the largest of the Marquesas Islands; the United States, however, never asserted any claim to the island, which in 1842, with the other Marquesas, was annexed by France. During most of February and March 1814 he was blockaded by the British frigates "Cherub" and "Phoebe" in the harbour of Valparaiso, and on the 28th of March was defeated by these vessels, which seem to have violated the neutrality of the port. He was released on parole, and sailed for New York on the "Essex, Jr.," a small vessel which he had captured from the British, and which accompanied the "Essex." At Sandy Hook he was detained by the captain of the British ship-of-war "Saturn" (who declared that Porter's parole was no longer effective), but escaped in a small boat. He was a member of the new board of naval commissioners from 1815 until 1823, when he commanded a squadron sent to the West Indies to suppress piracy. One of his officers, who landed at Fajardo (or Foxardo), Porto Rico, in pursuit of a pirate, was imprisoned by the Spanish authorities on the charge of piracy. Porter, without reporting the incident or awaiting instructions, forced the authorities to apologize. He was recalled (December 1824), was court-martialled, and was suspended for six months. In August 1826 he resigned his commission, and until 1829 was commander-in-chief of the Mexican navy, then fighting Spain; in payment for his services he received government land in Tehuantepec, where he hoped to promote an inter-oceanic canal. President Andrew Jackson appointed him consul-general to Algiers in 1830, and in 1831 created for him the post of chargé d'affaires at Constantinople, where in 1841 he became minister. He died in Pera on the 3rd of March 1843.

He wrote a *Journal of a Cruise made to the Pacific Ocean in the U.S. Frigate "Essex" in 1812–13–14* (2 vols., 1815; 2nd ed., 1822), and *Constantinople and its Environs* (2 vols., 1835), a valuable guide-book. See the *Memoir of Commodore David Porter* (Albany, New York, 1875), by his son, Admiral David D. Porter.

PORTER, DAVID DIXON (1813–1891), American naval officer, son of Captain David Porter, was born in Chester, Pennsylvania, on the 8th of June 1813. His first voyage, with his father

¹ While he was in New Orleans he adopted David Farragut, who later served with him on the "Essex."

in West Indian waters in 1823-1824, was terminated by the Fajardo affair (see PORTER, DAVID). In April 1826 he entered the Mexican navy, of which his father was commander-in-chief, and which he left in 1828, after the capture by the Spanish of the "Guerrero," on which he was serving under his cousin, David H. Porter (1804-1828), who was killed before the ship's surrender. He became a midshipman in the United States navy in 1829, and was in the coast survey in 1836-1842. In 1839 he married the daughter of Captain Daniel Tod Patterson (1786-1839), then commandant of the Washington navy-yard. Porter became a lieutenant in February 1841; served at the naval observatory in 1845-1846; in 1846 he was sent to the Dominican Republic to report on conditions there. During the Mexican War he served, from February to June 1847, as lieutenant and then as commanding officer of the "Spitfire," a paddle vessel built for use on the rivers, and took part in the bombardment of Vera Cruz and in the other naval operations under Commander M. C. Perry. From the close of the Mexican War to the beginning of the Civil War he had little but detail duty; in 1855 and again in 1856 he made trips to the Mediterranean to bring to the United States camels for army use in the south-west. In April 1861 he was assigned to the "Powhatan," and was sent under secret orders from the president for the relief of Fort Pickens, Pensacola, an expedition which he had urged. Porter was promoted commander on the 22nd of April, and on the 30th of May was sent to blockade the South-West Pass of the Mississippi. In August he left the gulf in a fruitless search for the Confederate cruiser "Sumter." Upon his return to New York in November he urged an expedition against New Orleans (*q.v.*), and recommended the appointment of Commander D. G. Farragut (*q.v.*), his foster-brother, to the chief command. In the expedition Porter himself commanded the mortar flotilla, which, when Farragut's fleet passed the forts on the early morning of the 24th of April 1862, covered its passage by a terrific bombardment that neutralized the fire of Fort Jackson. At Vicksburg Porter's bombardment assisted Farragut to run past the forts (June 28). On the 9th of July Porter was ordered, with ten mortar boats, to the James river, where McClellan's army was concentrated. On the 15th of October he took command of the gun-vessels which had been built on the upper waters of the Mississippi, and to which he made important additions at an improvised navy-yard at Mound City, Illinois. With this he took part in the capture of Arkansas Post on the 11th of January 1863. In the operations for the capture of Vicksburg in 1863 unsuccessful attempts were made in February and March by Porter's vessels to penetrate through connecting streams and bayous to the Yazoo river and reach the right rear of the Confederate defences on the bluffs. But in May the fleet ran past the Vicksburg batteries, mastered the Confederate forts at Grand Gulf, and made it possible for Grant's army to undertake the brilliant campaign which led to the fall of the place (see AMERICAN CIVIL WAR and VICKSBURG). Porter received the thanks of Congress for "opening the Mississippi River" and was promoted rear-admiral. He co-operated with Major-General N. P. Banks in the Red River expeditions in March-May 1864, in which his gun-boats, held above Alexandria by shallow water and rapids, narrowly escaped isolation, being enabled to return only by the help of a dam built by Lieut.-Colonel (Brigadier-General) Joseph Bailey (1827-1867). On the 12th of October 1864 he assumed command of the North Atlantic blockading squadron, then about to engage in a combined military and naval expedition against Fort Fisher, North Carolina. Porter claimed that his guns silenced Fort Fisher, but Major-General B. F. Butler, in command of the land forces, refused to assault, asserting that the fort was practically intact. After Butler's removal, Porter, co-operating with Major-General Alfred H. Terry, and commanding the largest fleet assembled at any one point during the war, took the fort on the 15th of January 1865; for this he again received the thanks of Congress. From 1865 to 1869 he was superintendent of the U.S. Naval Academy at Annapolis, which he greatly improved; his most notable change being the introduction of athletics. On the 25th of July he became

vice-admiral. From the 9th of March to the 25th of June 1869, while Adolph E. Borie (1809-1880), of Pennsylvania, was secretary of the navy in President Grant's cabinet, Porter was virtually in charge of the navy department. In 1870 he succeeded Farragut in the grade of admiral, which lapsed after Porter's death until 1899, when it was re-established to reward Rear-Admiral George Dewey for his victory at Manila. Porter urged the reconstruction of the navy, which he saw begun in 1882. He died in Washington, D.C., on the 13th of February 1891.

Porter wrote a *Life of Commodore David Porter* (1875), gossipy *Incidents and Anecdotes of the Civil War* (1885), a none too accurate *History of the Navy during the War of the Rebellion* (1887), two novels, *Allan Dare* and *Robert le Diable* (1885; dramatized, 1887) and *Harry Marline* (1886), and a short "Romance of Gettysburg," published in *The Criterion* in 1903. See J. R. Soley, *Admiral Porter* (New York, 1903) in the "Great Commanders" Series.

Admiral Porter's three brothers were in the service of the United States: WILLIAM DAVID PORTER (1809-1864) entered the navy in 1823, commanded the "Essex" on the Tennessee and the Mississippi in the Civil War, and became commodore in July 1862; THEODORIC HENRY PORTER (1817-1846) was the first officer of the American army killed in the Mexican War; and HENRY OGDEN PORTER (1823-1872) resigned from the United States navy in 1847, after seven years' service, fought under William Walker in Central America, returned to the American navy, was executive officer of the "Hatteras" when she was sunk by the "Alabama," and received wounds in the action from the effects of which he died several years later.

PORTER, ENDYMION (1587-1649), English royalist, descended from Sir William Porter, sergeant-at-arms to Henry VII., and son of Edmund Porter, of Aston-sub-Edge in Gloucestershire, by his cousin Angela, daughter of Giles Porter of Mickleton, in the same county, was brought up in Spain—where he had relatives—as page in the household of Olivares. He afterwards entered successively the service of Edward Villiers and of Buckingham, and through the latter's recommendation became groom of the bedchamber to Charles I. In October 1622 he was sent to negotiate concerning the affairs of the Palatinate and the marriage with the Infanta. He accompanied Charles and Buckingham on their foolhardy expedition in 1623, acted as their interpreter, and was included in the consequent attack made by Lord Bristol on Buckingham in 1626. In 1628 he was employed as envoy to Spain to negotiate for peace, and in 1634 on a mission to the Netherlands to the Infante Ferdinand. During the Civil War Porter remained a constant and faithful servant of the king. He was with him during the two Scottish campaigns, attended him again on the visit to Scotland in August 1641, and followed Charles on his last departure from London in 1642, receiving the nominal command of a regiment, and sitting in the Royalist parliament at Oxford in 1643. He had, however, little faith in the king's measures. "His Majesty's businesses," he writes in 1641, "run in their wonted channel—subtle designs of gaining the popular opinion and weak executions for the upholding of monarchy." His fidelity to Charles was of a personal, not of a political nature. "My duty and loyalty have taught me to follow my king," he declares, "and by the grace of God nothing shall divert me from it." This devotion to the king, the fact that he was the agent and protégé of Buckingham, and that his wife Olivia, daughter of John, Lord Boteler of Bramfield, and niece of Buckingham, was a zealous Roman Catholic, drew upon him the hostility of the opposite faction. As member of the Long Parliament, in which he sat as member for Droitwich, he was one of the minority of 59 who voted against Strafford's attainder, and was in consequence proclaimed a "betrayed of his country." On the 15th of February 1642 he was voted one of the dangerous counsellors, and specially excepted from pardon on the 4th of October and in the treaties of peace negotiated subsequently, while on the 10th of March 1643 he was excluded from parliament. Porter was also implicated in the army plot; he assisted Glamorgan in illegally putting the great seal to the commission to negotiate with the Irish in 1644; and was charged with having in the same manner affixed the

great seal of Scotland, then temporarily in his keeping, to that of O'Neill in 1641, and of having incurred some responsibility for the Irish rebellion. Towards the end of 1645, when the king's cause was finally lost, Porter abandoned England, and resided successively in France, Brussels, where he was reduced to great poverty, and the Netherlands. The property which he had accumulated during the tenure of his various appointments, by successful commercial undertakings and by favours of the court, was now for the most part either confiscated or encumbered. He returned to England in 1649, after the king's death, and was allowed to compound for what remained of it. He died shortly afterwards, and was buried on the 20th of August 1649 at St Martin's-in-the-Fields, leaving as a special charge in his will to his sons and descendants to "observe and respect the family of my Lord Duke of Buckingham, deceased, to whom I owe all the happiness I had in the world." He left five sons, who all played conspicuous, if not all creditable, parts in the history of the time. According to Wood, Porter was "beloved by two kings: James I. for his admirable wit and Charles I. for his general bearing, brave style, sweet temper, great experience, travels and modern languages." During the period of his prosperity Porter had gained a great reputation in the world of art and letters. He wrote verses, was a generous patron of Davenant, who especially sings his praises, of Dekker, Warmstrey, May, Herrick and Robert Dover, and was included among the 84 "essentials" in Bolton's "Academy Royal." He was a judicious collector of pictures, and as the friend of Rubens, Van Dyck, Mytens and other painters, and as agent for Charles in his purchases abroad he had a considerable share in forming the king's magnificent collection. He was also instrumental in procuring the Arundel pictures from Spain. The authorship of *Εὐκὼν πιστῆ*, 1649, a vindication of the *Εὐκὼν βασιλική*, has been attributed with some reason to Porter.

AUTHORITIES.—*Life and Letters of Endymion Porter*, by D. Townshend (1897); article in the *Dict. of Nat. Biog.*, by C. H. Firth and authorities there cited; *Memoires*, by D. Lloyd (1668), p. 657; Burton's *Hist. of Scotland* (1873), vi. 346-347; *Eng. Hist. Rev.* ii. 531, 692; Gardiner's *Hist. of England*; *Lives of the Lords Strangford* (1877), by E. B. de Fonblanque (Life and Letters); Wood, *Athenae Oxonienses*; Clarendon's *History of the Rebellion*; *State Papers and Calendar of State Papers*; *Calendar of State Papers: Dom. and of Committee for Compounding*; *The Chesters of Chichele*, by Waters, i. 144-149; *Εἰκὼν Βασιλική*, by Ed. Almack, p. 94. There are also various references, &c., to Endymion Porter in *Additional Charters*, British Museum, 6223, 1633, 6225; *Add. MSS.* 15,858; 33, 374; and *Egerton* 2550, 2533; in the *Hist. MSS. Comm. Series*; *MSS. of Duke of Portland*, &c., and in *Notes and Queries*; also *Thomason Tracts*, Brit. Mus., E 118 (13).

PORTER, FITZ-JOHN (1822-1901), American soldier, was born at Portsmouth, New Hampshire, on the 31st of August 1822. He was the son of a naval officer, and nephew of David Porter of the frigate "Essex." He graduated at the United States Military Academy in 1845 and was assigned to the artillery. In the Mexican War he won two brevets for gallantry—that of captain for Molino del Rey and that of major for Chapultepec. He served at West Point as instructor and adjutant (1849-1855), and he took part in the Utah expedition. At the outbreak of the Civil War in 1861 he was employed on staff duties in the eastern states, and rendered great assistance in the organization of Pennsylvania volunteers. In the absence of higher authority Porter sanctioned on his own responsibility the request of Missouri Unionists for permission to raise troops, a step which had an important influence upon the struggle for the possession of the state. He became colonel of a new regiment of regulars on the 14th of May, and soon afterwards brigadier-general of volunteers. Under McClellan he commanded a division of infantry in the Peninsular campaign, and directed the Union siege operations against Yorktown, and he was soon afterwards placed in command of the V. army corps. When the Seven Days' battle (*q.v.*) began Porter's corps had to sustain alone the full weight of the Confederate attack, and though defeated in the desperately fought battle of Gaines's Mill (June 27, 1862) the steadiness of his defence was so conspicuous that he was immediately

promoted major-general of volunteers and brevet brigadier-general U.S.A. His corps, moreover, had the greatest share in the successful battles of Glendale and Malvern Hill. Soon afterwards, with other units of the Army of the Potomac, the V. corps was sent to reinforce Pope in central Virginia. Its inaction on the first day of the disastrous second battle of Bull Run (*q.v.*) led to the general's subsequent disgrace; but it made a splendid fight on the second day to save the army from complete rout, and subsequently shared in the Antietam campaign. On the same day on which McClellan was relieved from his command, Porter, his warm friend and supporter, was suspended. A few days later he was tried by court-martial on charges brought against him by Pope, and on the 21st of January 1863 was sentenced to be cashiered "and for ever disqualified from holding any office of trust under the government of the United States." After many years Porter's friends succeeded (1878) in procuring a revision of the case by a board of distinguished general officers. This board reported strongly in Porter's favour, but at the time the remission of the disqualifying penalty was all that was obtained in the way of redress. General Grant had now taken Porter's part, and wrote an article in vol. 135 of the *North American Review* entitled "An Undeserved Stigma." Against much opposition, partly political (1879-1886) and a veto on a legal point from President Arthur, a relief bill finally passed Congress, and Porter was on the 5th of August 1886 restored to the United States army as colonel and placed on the retired list, no provision, however, being made for compensation. After the Civil War General Porter was engaged in business in New York, and later held successively many important municipal offices. In 1869 he declined the offer made by the khedive of the chief command of the Egyptian army. He died on the 21st of May 1901, at Morristown, New Jersey.

See, besides General Grant's article, Cox, *The Second Battle of Bull Run as connected with the Porter Case* (Cincinnati, 1882); Lord, *A Summary of the Case of F. J. Porter* (1883), and papers in vol. ii. of the publications of the Military Historical Society of Massachusetts.

PORTER, HENRY (*fl.* 1596-1599), English dramatist, author of *The Two Angry Women of Abingdon*, may probably be identified with the Henry Porter who matriculated at Brasenose College, Oxford, on the 19th of June 1589, and is described as aged sixteen and the son of a gentleman of London. From 1596 to 1599 he was engaged in writing plays for Henslowe for the admiral's men, and his closest associate seems to have been Henry Chettle. The earlier entries in Henslowe's *Diary* are respectful in tone, and the considerable sums paid to "Mr Porter" prove that his plays were popular. Henslowe secured in February 1599 the sole rights of any play in which Porter had a hand, the consideration being an advance of forty shillings. As time goes on he is familiarly referred to as "Harry Porter"; his borrowings become more frequent, and the sums less, until on the 16th of April 1599 he obtained a loan of twelve pence in exchange for a bond to pay all he owed to Henslowe—twenty-five shillings—on pain of forfeiting ten pounds. Whether he paid or not does not appear, but his last loan is recorded on the 26th of May 1599, after which nothing further is known of him. It seems in the highest degree unlikely that he is the Henry Porter who took his degree as Mus. Bac. at Christ Church in 1600 after twelve years' study, and whose skill in sacred music is celebrated in an epigram by John Weever. The entries in Henslowe's *Diary* indicate that he wrote a play called *Love Prevented* (1598), *Hot Anger soon Cold*, with Chettle and Ben Jonson (1598), the second part of *The Two Angry Women of Abingdon* (1598), *The Four Merry Women of Abingdon* (1599), and *The Spencers* (1599), with Chettle. None of these are extant, unless, as has been suggested, *Love Prevented* is another name for *The Pleasant History of the two angry women of Abingdon. With the humorous mirth of Dick Coomes and Nicholas Procerbes, two serving men* (1599), the importance of which is well described by Professor Gayley: "As a comedy of unadulterated native flavour, breathing rural life and manners and the modern spirit, constructed with knowledge of the stage, and without affectation or

constraint, it has no foregoing analogue except perhaps *The Pinner of Wakefeld*. No play preceding or contemporary yields an easier conversational prose, not even the *Merry Wives*."

Alexander Dyce edited the *Angry Women* for the Percy Society in 1841; and it is included in W. C. Hazlitt's edition of Dodsley's *Old Plays* (1874). It was edited by Havelock Ellis in *Nero and other plays* (1888, "Mermaid Series,") and in *Representative English Comedies* (1903), with an introduction by the general editor, Professor C. M. Gayley.

PORTER, HORACE (1837–), American diplomatist and soldier, was born in Huntingdon, Pennsylvania, on the 15th of April 1837; son of David Rittenhouse Porter (1788–1867), governor of Pennsylvania in 1839–1845, and grandson of Andrew Porter (1743–1813), an officer in the Continental Army during the War of Independence, and surveyor-general of Pennsylvania from 1809 until his death. Horace Porter studied for a year (1854) at the Lawrence scientific school of Harvard University, and then entered the United States Military Academy, where he graduated in 1860, third in his class. During the Civil War he was chief of ordnance at the capture of Fort Pulaski; then served in the Army of the Potomac until after Antietam; was transferred to the west, where he took part in the battles of Chickamauga (for gallantry in which he received a congressional medal of honour in June 1902) and Chattanooga; and in April 1864 became aide-de-camp to General Grant, in which position he served until March 1869. He earned the brevet of captain at Fort Pulaski, that of major at the battle of the Wilderness, and that of lieutenant-colonel at New Market Heights, and in March 1865 was breveted colonel and brigadier-general. From August 1867 to January 1868, while General Grant was secretary of war *ad interim*, Porter was an assistant secretary, and from March 1869 to January 1873, when Grant was president, Porter was his executive secretary. He resigned from the army in December 1873, when he became vice-president of the Pullman Palace Car Company and held other business positions. From March 1897 to May 1905 he was United States ambassador to France. At his personal expense he conducted (1899–1905) a successful search for the body of John Paul Jones,¹ who had died in Paris in 1792. For this he received (May 9, 1906) a unanimous vote of thanks of both Houses of Congress, and the privileges of the floor for life. In 1907 he was a member of the American delegation to the Hague Peace Conference. General Porter became well-known as a public speaker, and delivered orations at the dedication of General Grant's tomb in New York, at the centennial of the founding of West Point, and at the re-interment of the body of John Paul Jones at Annapolis. His publications include *West Point Life* (1866) and *Campaigning with Grant* (1897).

PORTER, JANE (1776–1850), British novelist, daughter of an army surgeon, was born at Durham in 1776. Her life and reputation are closely linked with those of her sister, ANNA MARIA PORTER (1780–1832), novelist, and her brother, SIR ROBERT KER PORTER (1775–1842), painter and traveller. After their father's death, in 1779, the mother removed from Durham, their birth-place, to Edinburgh, where the children's love of romance was stimulated by their association with Flora Macdonald and the young Walter Scott. Mrs Porter moved to London, so that her son might study art, and the sisters subsequently resided at Thames Ditton and at Esher with their mother until her death in 1831. Anna Maria Porter published *Artless Tales* in 1793–1795, the first of a long series of works of which the more noteworthy are *Walsh Colville* (1797), *Octavia* (1798), *The Lake of Killarney* (1804), *A Sailor's Friendship and a Soldier's Love* (1805), *The Hungarian Brothers* (1807), *Don Sebastian* (1800), *Ballads, Romances and other Poems* (1811), *The Recluse of Norway* (1814), *The Knight of St John* (1817), *The Fast of St Magdalen* (1818), *The Village of Mariendorpt* (1821), *Roche Blanche* (1822), *Honor O'Hara* (1826) and *Barony* (1830). Jane Porter—whose intellectual power, though slower in development and in expression, was greater than her sister's—had in the meantime gained immediate popularity by her first work, *Thaddeus of Warsaw* (1803),

¹ See JONES, JOHN PAUL, and an article by General Porter, "The Recovery of the Body of John Paul Jones," in the *Century Magazine*, (1905), lxx. 927 sqq.

which was translated into several languages and procured her election as canoness of the Teutonic order of St Joachim. In 1810, four years before the appearance of *Waverley*, she attempted national romance in her *Scottish Chiefs*. The story of Wallace had been a favourite one in her childhood, and she was probably well acquainted with the poem of Blind Harry (Henry the Minstrel). Although the book lacked historical accuracy, and the figure of Wallace is a sentimental conception of the least convincing kind, the picturesque power of narration displayed by Miss Porter has saved the story from the oblivion which has overtaken the works of most of Scott's predecessors in historical fiction. Her later works included *The Pastor's Fireside* (1815), *Duke Christian of Lüneburg* (1824), *Coming Out* (1828) and *The Field of Forty Footsteps* (1828). In conjunction with her sister she published in 1826 the *Tales round a Winter Hearth*. She also wrote some plays, and frequent contributions to current periodical literature. *Sir Edward Seaward's Diary* (1831) was asserted by Miss Porter to be founded on documents placed in her hands by the author's family, but is generally regarded as pure fiction. The claim of her eldest brother, Dr William Ogilvie Porter, to its authorship rests on a memorial inscription in Bristol Cathedral, written by Jane. On the 21st of September 1832 Anna Maria died, and for the next ten years Jane became "a wanderer" amongst her relations and friends.

Robert Ker Porter had in his own way been scarcely less successful than his sisters. After two years of study at the Royal Academy he had gained reputation as a painter of altarpieces and battle-scenes of imposing magnitude. He went to Russia as historical painter to the emperor in 1804, travelled in Finland and Sweden, where he received knighthood from Gustavus IV. in 1806, and accompanied Sir John Moore to Spain in 1808. In 1811 he returned to Russia and married a Russian princess. He was knighted by the Prince Regent in 1813. In 1817 he travelled to Persia by way of St Petersburg and the Caucasus, returning through Bagdad and western Asia Minor. He examined the ruins of Persepolis, making many valuable drawings and copying cuneiform inscriptions. In 1826 he became British consul in Venezuela. His services there were recognized by a knight commandership of the Order of Hanover. Accounts of his wanderings are to be found in his *Travelling Sketches in Russia and Sweden* (1808), *Letters from Portugal and Spain* (1809), *Narrative of the late Campaign in Russia* (1813), and *Travels in Georgia, Persia, Armenia, Ancient Babylonia &c., during the years 1817–1820* (1821–1822). After leaving Venezuela (1841) he again visited St Petersburg, and died there suddenly on the 4th of May 1842. Jane Porter, who had joined him in Russia, then returned to England and took up her residence with her eldest brother at Bristol, where she died on the 24th of May 1850.

PORTER, MARY (d. 1765), English actress, was brought to the attention of Betterton by Mrs Barry, who had seen her play the Fairy Queen at Bartholomew Fair. In his company she made her first appearance in 1699, in tragedy, in which she was at her best, although she also played a long list of comedy parts. When her friends, Mrs Barry, Mrs Bracegirdle and Mrs Oldfield, had retired from the stage, she was left its undisputed queen. She died on the 24th of February 1765.

PORTER, NOAH (1811–1892), American educationalist and philosophical writer, was born in Farmington, Connecticut, on the 14th of December 1811. He graduated at Yale College, 1831, and laboured as a Congregational minister in Connecticut and Massachusetts, 1836–1846. He was elected professor of moral philosophy and metaphysics at Yale in 1846, and from 1871 to 1886 he was president of the college. He edited several editions of Noah Webster's English dictionary, and wrote on education, &c. His best-known work is *The Human Intellect, with an Introduction upon Psychology and the Human Soul* (1868), comprehending a general history of philosophy, and following in part the "common-sense" philosophy of the Scottish school, while accepting the Kantian doctrine of intuition, and declaring the notion of design to be a priori. He died in New Haven on the 4th of March 1892.

PORTEUS, BEILBY (1731-1808), bishop of London, was born at York and educated at Christ's College, Cambridge, where he became fellow in 1752. He was ordained in 1757, and in 1762 was appointed domestic chaplain to the archbishop of Canterbury. In 1767 he became rector of Lambeth, and took his D.D. degree at Cambridge, preaching on that occasion a sermon which induced John Norris (1734-1777) to found the Norrisian professorship of divinity. About two years later he was appointed chaplain to the king and master of the hospital of St Cross, Winchester. In 1776 he became bishop of Chester, and in 1787 he was translated to London. He was a supporter of the Church Missionary and the British and Foreign Bible societies, and laboured for the abolition of slavery.

Of his published works the *Review of the Life and Character of Archbishop Secker* (London, 1770), and the *Summary of the principal Evidences for the Truth and Divine Origin of the Christian Revelation* (London, 1800), have passed through numerous editions.

PORTFOLIO (shortened form of *porto folio*, adapted from the Ital. *portafogli*, *portare*, to carry, and *fogli*, sheets or leaves of paper, Lat. *folium*, leaf), a case for keeping papers, documents, prints, maps, &c., usually a leather book-cover with a flexible back. As the official documents of a state department are in the hands of the minister of that department, the word "portfolio" is frequently used figuratively of the office itself, particularly on the continent of Europe, where the "portfolio" is the symbol of office, as, in English usage, the "seals" are for the secretaryships of state. The phrase "minister without portfolio" is applied to a member of a ministry to whom no special department is assigned.

PORT GLASGOW, a municipal and police burgh and seaport of Renfrewshire, Scotland, on the southern shore of the Firth of Clyde, 20½ m. W.N.W. of Glasgow by the Caledonian railway. Pop. (1901), 16,857. The ground behind the town rises to a height of 700 ft. and is partly occupied by villas. Amongst the principal buildings are the town house (1815), with a tower and spire; the town hall (1873); the library (1887) founded by James Moffat, a merchant of the burgh, and the Carnegie Park Orphanage, also provided from the same bequest. Birkmyre Park was opened in 1894. The industries include shipbuilding and allied trades, engineering works, and iron and brass foundries. The area of the port (which has wet and graving docks) amounts to 16 acres, and there are 2000 yds. of quayage. The harbours are accessible at all stages of the tide. The district originally formed part of the parish of Kilmalcolm, the nucleus of the town being the village of Newark attached to the barony of that name. In 1668 it was purchased from Sir Patrick Maxwell of Newark by the Glasgow magistrates, who here constructed a harbour. In 1695 it was erected into a separate parish under the name of New Port Glasgow. In 1710 it became the chief custom-house port for the Clyde, until superseded by Greenock. The graving dock made in 1762 was the first dock of the kind in Scotland. In 1775 Port Glasgow was created a burgh of barony and since 1832 has formed one of the Kilmarnock parliamentary burghs (with Kilmarnock, Dumbarton, Renfrew and Rutherglen). It is governed by a council with provost and bailies. Adjoining the town on the east are the picturesque ruins of Newark Castle, a quadrangular building dating from the end of the 16th century. Formerly the property of the Dennistouns, it now belongs to the Shaw-Stewarts.

PORHCRAWL, a seaport and urban district in the mid-parliamentary division of Glamorganshire, South Wales 30 m. by rail W. of Cardiff and 22 m. S.E. of Swansea. Pop. (1901) 1872. The urban district (formed in 1893) is continuous with the civil parish of Newton Nottage, which, in addition to Porthcawl proper, built on the sea-front, comprises the ancient village of Nottage, 1 m. N., and the more modern village of Newton, 1 m. N.E. of Porthcawl. The natural harbour of Newton (as it used to be called) was improved by a breakwater, and was connected by a tramway with Maesteg, whence coal and iron were brought for shipment. The tramway was converted into a railway, and in 1865 opened for passenger traffic. In 1866 a dock (7½ acres) and tidal basin (2½ acres) were constructed, but

since about 1902 they have fallen into disuse and the coal is diverged to other ports, chiefly Port Talbot. Porthcawl, however, has grown in popularity as a watering-place. Situated on a slightly elevated headland facing Swansea Bay and the Bristol Channel, it has fine sands, rocks and breezy commons, on one of which, near golf links resorted to from all parts of Glamorgan, is "The Rest," a convalescent home for the working classes, completed in 1891, with accommodation for eighty persons. The climate of Porthcawl is bracing, and the rainfall (averaging 25 in.) is about the lowest on the South Wales coast. The district is described by R. D. Blackmore in his tale *The Maid of Sker* (1872), based on a legend associated with Sker House, a fine Elizabethan building in the adjoining parish of Sker, which was formerly extra-parochial. The parish church (dedicated to St John the Baptist) has a pre-Reformation stone altar and an ancient carved stone pulpit, said to be the only relic of an earlier church now covered by the sea.

PORT HOPE, a town and port of entry of Durham county, Ontario, Canada, on the north shore of Lake Ontario, 63 m. N.E. of Toronto by the Grand Trunk railway, and connected with Charlotte, the port for Rochester, New York, by a daily steamboat service. The population, 5585 in 1881, shrank in 1901 to 4188, but is increasing owing to the popularity of the town as a summer resort. It is picturesquely situated on the side and at the foot of hills overlooking the lake; and Smith's Creek, by which it is traversed, supplies abundant water-power. Trade is carried on in lumber, grain and flour. Trinity College School, a residential school under Anglican control, has a long and creditable history.

PORT HUDSON, a village in East Baton Rouge Parish, Louisiana, U.S.A., on the left bank of the Mississippi, about 135 m. above New Orleans. At the sharp turn of the Mississippi here the Confederates in 1862 built on the commanding bluffs powerful batteries covering a stretch of about 3 m., their strongest fortifications along the Mississippi between New Orleans and Vicksburg. On the night of the 14th of March 1863 Admiral Farragut, with seven vessels, attempted to run past the batteries, commanded by Brigadier-General William M. Gardner, but four of his vessels were disabled and forced to turn back, one, the "Mississippi" was destroyed, and only two, the "Hartford" and the "Albatross" got past. General N. P. Banks's land attack, on the 27th of May, was unsuccessful, the Union loss, nearly 2000, being six times that of the Confederates. A second attack on the 14th of June, entailed a further Union loss of about 1800 men. But on the 9th of July, two days after the news of the surrender of Vicksburg, after a siege of 45 days, General Gardner surrendered the position to General Banks with about 6400 men, 50 guns, 5000 small arms and ammunition, and two river steamers. The Union losses during the siege were probably more than 4000; the Confederate losses about 800. The capture of Vicksburg and Port Hudson secured to the Union the control of the Mississippi.

PORT HURON, a city and the county-seat of Saint Clair county, Michigan, U.S.A., at the confluence of the Saint Clair and Black rivers, and at the lower end of Lake Huron, about 60 m. N.N.E. of Detroit. Pop. (1900), 19,158 of whom 7142 were foreign-born; (1910 U.S. census) 18,863. It is served by the Grand Trunk and other railways, and by steamboat lines to Chicago and other ports. A railway tunnel, 6025 ft. long, under the Saint Clair, connects the city with Sarnia, Canada. The tunnel, which has an inside diameter of 20 ft., was constructed by the Grand Trunk railway in 1889-1891 at a cost of about \$2,700,000, and was designed by Joseph Hobson (b. 1834). Port Huron is laid out with wide streets, on both sides of the Black river and along the shore of Lake Huron; it has attractive parks and mineral water springs, and is a summer resort. Among its buildings are the court house, the city hall, and a Modern Maccabee Temple—Port Huron being the headquarters of the Knights of the Modern Maccabees (1881), a fraternal society which, in 1910, had a membership of 107,737. Until 1908 Port Huron was the headquarters of the Knights of the Maccabees of the World (founded in 1883; 283,908 members in 1910). Port Huron has large shipping interests, and since 1866 has been the port of entry of the Huron

customs district. In 1908 its exports were valued at \$16,958,080 and its imports at \$4,859,120. The city has shipyards, dry docks, large shops of the Grand Trunk railway, publishing houses, and manufactories of agricultural implements, steel ships, automobiles, foundry products, paper and pulp, and toys. In 1904 the city's factory products were valued at \$4,789,589.

In 1686 the French established Fort St Joseph, a fortified trading post, which came into the possession of the British in 1761 and was occupied by American troops in 1814. The fort was renamed Fort Gratiot in honour of General Charles Gratiot (1788-1855), who was chief-engineer in General W. H. Harrison's army in 1813-1814, and was chief-engineer of the U.S. Army in 1828-1838. The settlement which grew up round the fort, and was organized as a village in 1840, was also known as Fort Gratiot, and was annexed to Port Huron in 1893. The fort was abandoned during 1837-1848, during 1852-1866, and, permanently, in 1879. The earliest permanent settlement, in what later became Port Huron, was made in 1790 by several French families. This settlement, distinct from that at the fort, was first called La Rivière De Lude, and, after 1828, Desmond. It was platted in 1835, incorporated as a village in 1840 (under its present name), and chartered as a city in 1857.

PORTICI, a town of Campania, Italy, in the province of Naples, 5 m. S.E. of Naples by rail, on the shores of the bay, and at the foot of Vesuvius. Pop. (1901), 14,239. The palace, erected in 1738, is traversed by the high road. It once contained the antiquities from Herculaneum, now removed to Naples, and since 1882 it has been a government school of agriculture. There is a small harbour. Just beyond Portici, on the south east, is Resina (pop. in 1901, 20,182), on the site of the ancient Herculaneum, with several fine modern villas. The inhabitants are engaged in fishing, silk-growing and silk-weaving. The town was completely destroyed by the eruption of Vesuvius in 1631.

PORTICO (Ital. for "porch," Lat. *porticus*), a term in architecture for the covered entrance porch to a building, which is carried by columns, and either constitutes the whole front of the building, as in the Greek and Roman temples, or forms an important feature, as the portico of the Pantheon at Rome attached to the rotunda. A circular projecting portico, such as those to the north and south transepts of St Paul's Cathedral, and that which forms the west entrance of St Mary le Strand, is known as cyclostyle. The term *porticus* is used to distinguish the entrance portico in an amphiprostyle or peripteral temple from that behind which is called the *posticum*.

PORTIÈRE, a hanging placed over a door, as its French name implies, or over the doorless entrance to a room. From the East, where doors are still rare, it came to Europe at a remote date—it is known to have been in use in the West in the 14th century, and was probably introduced much earlier. Like so many other domestic furnishings, it reached England by way of France, where it appears to have been originally called *rideau de porte*. It is still extensively used either as an ornament or as a means of mitigating draughts. It is usually of some heavy material, such as velvet, brocade, or plush, and is often fixed upon a brass arm, moving in a socket with the opening and closing of the door.

PORT JACKSON, or SYDNEY HARBOUR, a harbour of New South Wales, Australia. It is one of the safest and most beautiful harbours in the world; its area, including all its bays, is about 15 sq. m., with a shore line of 165 m.; it has deep water in every part, and is landlocked and secure in all weathers. The entrance, between two rocky promontories known as North and South Heads, is $2\frac{1}{2}$ m. wide between the outer heads, and narrows down to 1 m. 256 yds. The port is flanked on both sides by promontories, so that, in addition to a broad and deep central channel, there is a series of sheltered bays with good anchorage. Sydney lies on the southern shore about 4 m. from the Heads. Port Jackson is the chief naval dépôt of Australasia, the headquarters of the admiral's station, and is strongly fortified. The harbour has a number of islands, most of which are used for naval or government purposes—Shark Island is the quarantine station, Garden Island has naval foundries, hospital and stores, Goat Island is occupied by a powder magazine, Spectacle Island is used to store explosives, and on Cockatoo Island are important government docks. Port Jackson was discovered by Captain

Phillip in 1788, though in 1770 Captain Cook, when coasting north, noticed what looked like an inlet, and named it after Sir George Jackson, one of the secretaries to the Admiralty. Captain Cook passed the harbour without recognizing its capacity; but the cliffs which guard the entrance are 300 ft. high, and no view of the basin can be seen from the masthead. Middle Head, which is opposite the entrance, closes it in, and it is necessary to enter, turn to the south, and then to the west before the best part of the harbour discloses itself.

PORT JERVIS, a city of Orange county, New York, U.S.A., on the Delaware river, at its junction with the Neversink, 88 m. N.W. of New York city by rail, and at the intersection of the boundary lines of the states of New York, New Jersey and Pennsylvania. Pop. (1900), 9385, of whom 895 were foreign-born; (1910 census), 9564. It is served by the Erie and the New York, Ontario & Western railways. The beauty of the scenery in its vicinity has made the city a summer resort. At Port Jervis are situated the extensive shops of the Erie railway. Among the manufactures are wearing apparel, silk, glass, and silver ware. The value of the factory products increased from \$1,009,081 in 1900 to \$1,635,215 in 1905, or 62%. Port Jervis was laid out in 1826, soon after work began on the Delaware & Hudson Canal; it owes its origin to that waterway (now abandoned), and was named in honour of John Bloomfield Jervis (1795-1885), the engineer who constructed the canal, who, in 1836, was in charge of the construction of the Croton Aqueduct, and wrote *Railway Property* (1859) and *The Construction and Management of Railways* (1861). Port Jervis was incorporated as a village in 1853, and was chartered as a city in 1907.

PORTLAND, EARL OF, an English title held by the family of Weston from 1633 to 1688, and by the family of Bentinck from 1689 to 1716, when it was merged in that of duke of Portland. Sir Richard Weston (1577-1635), according to Clarendon "a gentleman of very ancient extraction by father and mother," was the son and heir of Sir Jerome Weston (c. 1550-1603) of Skreens, in Roxwell, Essex, his grandfather being Richard Weston (d. 1572) justice of the common pleas. A member of parliament during the reigns of James I. and Charles I., Sir Richard was sent abroad by James on two occasions to negotiate on behalf of the elector palatine Frederick V.; after the murder of the duke of Buckingham, he became the principal counsellor of Charles I. In 1628 he was created Baron Weston of Neyland and in 1633 earl of Portland. Having in 1625 and 1626 had experience in the difficult task of obtaining money for the royal needs from the House of Commons, Weston was made lord high treasurer in 1628. His own inclinations and the obstacles in the way of raising money made him an advocate of a policy of peace and neutrality. His conduct was frequently attacked in parliament, but he retained both his office and the confidence of the king until his death on the 13th of March 1635. His son Jerome, the 2nd earl (1605-1663), was imprisoned for plotting in the interests of Charles I. in 1643, and was nominally president of Munster from 1644 to 1660. He sat in the convention parliament of 1660. He was succeeded by his son Charles (1639-1665), who was killed in a sea-fight with the Dutch off the Texel, and then by his brother Thomas (1609-1688), who died in poverty at Louvain, when the title became extinct. In 1689 it was revived by William III., who bestowed it upon his favourite William Bentinck (see below.)

Sir Richard Weston must be distinguished from a contemporary and namesake, Sir Richard Weston (c. 1579-1652), baron of the exchequer. Another Sir Richard Weston (c. 1466-1542) was a courtier and a diplomatist under Henry VIII.; his son was Sir Francis Weston (c. 1511-1536), who was beheaded for his alleged adultery with Anne Boleyn. This Sir Richard had a brother, Sir William Weston (d. 1540), who distinguished himself at the defence of Rhodes in 1522, and was afterwards prior of the Knights of St John in England. A third Sir Richard Weston (1591-1652), was mainly responsible for introducing locks on the Wey and thus making this river navigable.

Another family of Weston produced Robert Weston (c. 1515-1573), lord chancellor of Ireland from 1566 until his death on the

20th of May 1573. Other famous Westons were Stephen Weston (1665-1742) bishop of Exeter from 1724 until his death, and his son Edward Weston (1703-1770) the writer.

Much of the earl of Portland's correspondence is in the Public Record Office, London. For his political career see S. R. Gardiner, *History of England* (1883-1884), and L. von Ranke, *Englische Geschichte* (Eng. trans., Oxford, 1875).

PORTLAND, WILLIAM BENTINCK, EARL OF (c. 1645-1709), English statesman, was born, according to the Dutch historian, Groen van Prinsterer, in 1645, although most of the other authorities give the date as 1649. The son of Henry Bentinck of Diepenheim, he was descended from an ancient and noble family of Gelderland. He became page of honour and then gentleman of the bedchamber to William, prince of Orange. When, in 1675, the prince was attacked by small-pox, Bentinck nursed him assiduously, and this devotion secured for him the special and enduring friendship of William; henceforward, by his prudence and ability, he fully justified the confidence placed in him. In 1677 he was sent to England to solicit for the prince of Orange, the hand of Mary, daughter of James duke of York, afterwards James II., and he was again in England in 1683 and in 1685. When, in 1688, William was preparing for his invasion Bentinck went to some of the German princes to secure their support, or at least their neutrality, and he was also a medium of communication between his master and his English friends. He superintended the arrangements for the expedition and sailed to England with the prince.

The revolution accomplished, Bentinck was made groom of the stole, first gentleman of the bedchamber, and a privy councillor; and in April 1689 he was created Baron Cirencester, Viscount Woodstock and earl of Portland. He commanded some cavalry at the battle of the Boyne in 1690, and was present at the battle of Landen, where he was wounded, and at the siege of Namur. But his main work was of a diplomatic nature. Having thwarted the plot to murder the king in 1696, he helped to arrange the peace of Ryswick in 1697; in 1698 he was ambassador to Paris, where he opened negotiations with Louis XIV. for a partition of the Spanish monarchy, and as William's representative, he signed the two partition treaties. Portland had, however, become very jealous of the rising influence of Arnold van Keppel, earl of Albemarle, and, in 1699, he resigned all his offices in the royal household. But he did not forfeit the esteem of the king, who continued to trust and employ him. Portland had been loaded with gifts, and this, together with the jealousy felt for him as a foreigner, made him very unpopular in England. He received 135,000 acres of land in Ireland, and only the strong opposition of a united House of Commons prevented him obtaining a large gift of crown lands in North Wales. For his share in drawing up the partition treaties he was impeached in 1701, but the case against him was not proceeded with. He was occasionally employed on public business under Anne until his death at his residence, Bulstrode in Buckinghamshire, on the 23rd of November 1709. Portland's eldest son Henry (1680-1724) succeeded as 2nd earl. He was created marquess of Titchfield and duke of Portland in 1716.

See G. Burnet, *History of My Own Time* (Oxford, 1833); Lord Macaulay, *History of England* (1854); L. von Ranke, *Englische Geschichte* (Eng. trans., Oxford, 1875); and especially Onno Klopp, *Der Fall des Hauses Stuart* (Vienna, 1875-1888). See also Dr A. W. Ward's article in vol. iv. of the *Dict. Nat. Biog.*

PORTLAND, WILLIAM HENRY CAVENDISH BENTINCK, 3rd DUKE OF (1738-1809), prime minister of England, son of William, 2nd duke (1709-1762), and grandson of the 1st duke. His mother, Margaret, granddaughter and heiress of John Holles, duke of Newcastle, brought to her husband Welbeck Abbey and other estates in Nottinghamshire. He was born on the 14th of April 1738, and was educated at Oxford, where he graduated M.A. in 1757. In 1761, as marquess of Titchfield, he became M.P. for the borough of Weobly (Hereford), but in May 1762 he was called to the upper house on the death of his father. Under the marquess of Rockingham he was, from July 1765 to December 1766, lord chamberlain, and on the return of Rockingham to power in April 1782 he was made lord-licutenant

of Ireland. After the short ministry of Shelburne, succeeding the death of Rockingham, the duke of Portland was selected by Fox and North as a "convenient cipher" to become the head of the coalition ministry, to the formation of which the king was with great reluctance compelled to give his assent. The duke held the premiership from the 5th of April 1783 until the defeat of the bill for "the just and efficient government of British India" caused his dismissal from office on the 17th of December following. Under Pitt he was, from 1794 to 1801, secretary of state for the home department, after which he was, from 1801 to 1805, president of the council. In 1807 he was appointed a second time prime minister and first lord of the treasury. Ill health caused him to resign in October 1809, and he died on the 30th of that month. He owed his political influence chiefly to his rank, his mild disposition, and his personal integrity, for his talents were in no sense brilliant, and he was deficient in practical energy as well as in intellectual grasp.

He married in 1766 Lady Dorothy Cavendish (1750-1794), daughter of the 4th duke of Devonshire, and was succeeded as 4th duke by his son WILLIAM HENRY (1768-1854), who married a daughter of the famous gambler, General John Scott, and was brother-in-law to Canning. His son, the 5th duke, WILLIAM JOHN CAVENDISH BENTINCK-SCOTT (1800-1879) died unmarried. He is notable for having constructed the underground halls at Welbeck Abbey, and for his retiring habits of life, which gave occasion for some singular stories.¹ He was succeeded by his cousin WILLIAM JOHN ARTHUR CHARLES JAMES CAVENDISH-BENTINCK (b. 1857) as 6th duke.

PORTLAND, a seaport of Normanby county, Victoria, Australia, 250 m. by rail S.W. of Melbourne. Pop. (1901), 2185. It stands on the western shore of a magnificent bay, 24 m. long and 12 m. broad, and is the outlet for a rich agricultural and pastoral tract.

PORTLAND, the largest city of Maine, U.S.A., the county-seat of Cumberland county, and a port of entry, on Casco Bay, about 115 m. by rail N.N.E. of Boston. Pop. (1890), 36,425; (1900), 50,145, of whom 34,918 were born in Maine, 3125 in the other New England states, 4476 in Canada, and 3273 in Ireland, and 291 were negroes; (1910 census) 58,571. Portland is served by the Maine Central, the Boston & Maine, and the Grand Trunk railways; by steamboat lines to New York, Boston, Bar Harbor, Saint John, N.B., and other coast ports, and, during the winter season, by the Allan and Dominion transatlantic lines. It is connected by ferry with South Portland.

¹ Public interest centred for some years round the allegation that he lived a double life and was identical with Mr T. C. Druce, an upholsterer of Baker Street, London, who, in 1851, married Annie May. The "Druce case," involving a claim to the title and estates, by Mrs Druce (widow of W. T. Druce, son of T. C. Druce by Annie May) on behalf of her son, aroused much attention from 1897 to 1908. The duke of Portland was undoubtedly buried in Kensal Green cemetery in 1879. "Druce," on the other hand, was supposed to have died in 1864 and been interred in Highgate cemetery, his will bequeathing over £70,000 in personal estate. Mrs Druce's claims had two aspects, both as involving the revocation of probate of T. C. Druce's will, and also as identifying Druce with the duke of Portland. But her application to have the grave in Highgate opened (with the object of showing that the coffin there was empty), though granted by Dr Tristram, chancellor of the diocese of London, was thwarted by a *caveat* being entered on the part of the executor of T. C. Druce's will; and the case became the subject of constant proceedings in the law-courts without result. Meanwhile it was discovered that children of T. C. Druce by a former wife were living in Australia, and Mrs Druce's claims fell into the background, the case being taken up independently by Mr G. H. Druce as the representative of this family, from 1903 onwards. A company to finance his case was formed in 1905, and in the autumn of 1907 he instituted a charge of perjury against Mr Herbert Druce, T. C. Druce's younger son and executor, for having sworn that he had seen his father die in 1864. Sensational evidence of a mock burial was given by an American witness named Caldwell, and others; but eventually it was agreed that the grave at Highgate should be opened. This was done on December the 30th, and the body of Mr T. C. Druce was then found in the coffin. The charge of perjury at once collapsed and was withdrawn on January 6th, the opening of the grave definitely putting an end to the story of an identity between the two men.

The hilly peninsula, to which Portland was confined until the annexation of the town of Deering in 1899, is nearly 3 m. in length by about $\frac{1}{2}$ m. in average width; at its east end is Munjoy Hill, 160 ft. above the sea, and its west end Bramhall Hill, 15 ft. higher. Portland's total land area is about 21 $\frac{1}{2}$ sq. m. The scenery in and about the city is noted for its picturesqueness, and this, with its delightful summer climate and historic interest, attracts a large number of visitors during the summer season. Munjoy Hill commands a fine view of Casco Bay, which is overlooked by other wooded heights. There is excellent yachting in the bay, which contains many beautiful islands, such as Peaks and Cushing's islands. Bramhall Hill commands an extensive view west and north-west of the bay, the mainland, and the White Mountains some 80 m. distant.

The city's park system includes the Western Promenade, on Bramhall Hill; the Eastern Promenade, on Munjoy Hill; Fort Allen Park, at the south extremity of the latter promenade; Fort Sumner, another small park farther west, on the same hill; Lincoln Park, containing 2 $\frac{1}{2}$ acres of beautiful grounds near the centre of the city; Deering's Oaks (made famous by Longfellow), the principal park (50 acres) on the peninsula, with many fine old trees, pleasant drives, and an artificial pond used for boating; and Monument Square and Boothby Square. There are many pleasant drives along the shore of the bay or the banks of rivers, and some of these lead to popular resorts, such as Riverton Park, on the Presumpscot; Cape Cottage Park, at the mouth of the harbour; and Falmouth Foreside, bordering the inner bay.

The streets of Portland are generally well paved, are unusually clean, and, in the residence districts, where the fire of 1866 did not extend, they are profusely shaded by elms and other large trees—Portland has been called the "Forest City." Congress Street, the principal thoroughfare, extends along the middle of the peninsula north-east and south-west and from one end of it to the other, passing in the middle of its course through the shopping district.

In Portland's architecture, both public and private, there is much that is excellent; and there are a number of buildings of historic interest. The Post Office, at the corner of Exchange and Middle streets, is of white Vermont marble and has a Corinthian portico. The granite Customs House, extending from Fore Street to Commercial Street, is large and massive. The Public Library building is Romanesque and elaborately ornamented; the building was presented to the city by James P. Baxter; in the library is the statue, by Benjamin Paul Akers (1825-1861), of the dead pearl-diver, well known from Hawthorne's description in *The Marble Faun*. The Cumberland County Court House, of white Maine granite, occupies the block bounded by Federal, Pearl, Church and Newbury streets; immediately opposite (to the south-west) is the Federal Court building, also of Maine granite. The Portland Observatory, on Munjoy Hill, erected in 1807 to detect approaching vessels, rises 222 ft. above tide-water. In Monument Square, the site of a battery in 1775 is a soldiers' and sailors' monument (1889), a tall granite pedestal surmounted by a bronze female figure, by Franklin Simmons; at the corner of State Street is a statue of Henry W. Longfellow by the same sculptor; and where Congress Street crosses the Eastern Promenade, a monument to the first settlers, George Cleeve and Richard Tucker. On the Western Promenade there is a monument to Thomas Brackett Reed, who was a native and a resident of Portland. On Congress Street, below the Observatory, is the Eastern Cemetery, the oldest burying ground of the city; in it are the graves of Commodore Edward Preble, and of Captain Samuel Blythe (1784-1813) and Captain William Burroughs (1785-1813), who were killed in the engagement between the British brig "Boxer" and the American brig "Enterprise," their respective ships, off this coast on the 5th of September 1813. The cemetery also contains monuments to Alonzo P. Stinson, the first soldier from Portland killed in the Civil War, to the Portland soldiers in the War of Independence, and to Rear-Admiral James Alden (1810-1877), of the U.S. Navy, a native of Portland. Among the churches are the Cathedral of the Immaculate Conception (Roman Catholic), with a spire 236 ft. high, and St Luke's (Protestant Episcopal) Cathedral. In the Williston Church (Congregational), in Thomas Street, the Young People's Society of Christian Endeavor was founded in 1881 by the Rev. Francis E. Clark, then pastor of the church. The finest residence district is on Bramhall Hill. Many houses, especially in State, Danforth and Congress streets, are simple in style and old-fashioned in architecture. Of special interest to visitors is the Wadsworth-Longfellow House—the early home of Henry W. Longfellow—which was built in 1785-1786 by General Peleg Wadsworth (1748-1829), a soldier of the War of Independence, a representative in Congress from 1793 to 1807, and the grandfather of the poet; was given by Longfellow's sister, Mrs Anne Longfellow Piercee (1810-1901) to the Maine Historical Society; and contains interesting relics of the Wadsworth and Longfellow families, and especially of the poet himself. Behind the "Home" is the Library of the Maine Historical Society. The birthplace of Longfellow is now a tenement

house at the corner of Fore and Hancock streets, near the Grand Trunk railway station.

In Portland, as in Bangor, the Maine Music Festival (begun in 1897) is held every year in October, three concerts being given by a chorus composed of local choruses trained in different cities of the state for the festival.

Among the institutions are: The Medical School of Maine, the medical department of Bowdoin College—instruction being given here during the last two years of the course; Westbrook Seminary (chartered in 1831, and empowered to grant degrees in 1863); the Public Library, containing (1910) 65,000 vols.; the Library of the Maine Historical Society (30,000 vols.); the Mechanics' Library, the Greenleaf Law Library, the Maine General Hospital, and the United States Marine Hospital. The Portland Society of Natural History, founded in 1843 and incorporated in 1850, has a building (1880) containing a library and natural history collections. The city is supplied with good water from Lake Sebago, 17 m. distant.

The harbour has an artificial breakwater and extensive modern fortifications (Fort Preble, on the Cape Shore; Fort Levett, on Cushing's Island; Fort Williams, at Portland Head; and Fort McKinley, on Great Diamond Island) among the best equipped in the United States. For a long period the city was noted for its commerce with the West Indies, which began to decline about 1876, but the coast trade and commerce with Great Britain are still considerable, especially in the winter, when Portland is the outlet of much of the trade from the Great Lakes that in the other seasons passes through Montreal. The principal exports are grain, live-stock and fruit. In 1908 the exports were valued at \$11,353,339 and the imports at \$1,189,964. The Grand Trunk Railroad Company has here two of the largest grain warehouses on the Atlantic Coast. In 1905 Portland was the first manufacturing city of the state, with a factory product valued at \$9,132,801 (as against \$8,527,649 for Lewiston, which outranked Portland in 1900); here are foundries and machine-shops, planing-mills, car and railway repair shops, packing and canning establishments—probably the first Indian corn canned in the United States was canned near Portland in 1840—potteries, and factories for making boots, shoes, clothing, matches, screens, sleighs, carriages, cosmetics, &c. Ship-building and fishing are important industries.

The first permanent settlement on the peninsula was established by George Cleeve and Richard Tucker at the foot of Munjoy Hill in 1633 immediately after they had been ejected from land which they had claimed at the mouth of the Spurwink. Soon the hill at the east end became the property of George Munjoy and that at the west end the property of George Bramhall. The Indian name of the peninsula was Machegonne, and the new settlement was during the next few years known by various names, such as Casco, Casco Neck, Cleeve's Neck, and Munjoy's Neck. In 1658 Massachusetts extended its jurisdiction over this part of Maine. The peninsula, with considerable neighbouring territory and Cape Elizabeth, was organized as a town in 1718 and was named Falmouth. The town suffered so severely from the Indians in 1676 that it was deserted until 1678. It was attacked in 1689, and in 1690 it was utterly destroyed by the French and Indians, and remained desolate until after the Treaty of Utrecht in 1713. When the port of Boston was closed by Great Britain in 1774 the bell of the old First Parish Church (Unitarian) of Portland (built 1740; the present building dates from 1825) was muffled and rung from morning till night, and in other ways the town showed its sympathy for the patriot cause. As a punishment, on the 18th of October 1775, the town was bombarded and burned by a British fleet. The peninsula portion of Falmouth was incorporated as a distinct town in 1786 and was named Portland. Portland was the capital of the state from 1820 to 1832 and in the latter year was chartered as a city. In 1886 a large central portion of the city, about 200 acres, was destroyed by a fire resulting from a Fourth of July celebration. Portland was the birthplace of Henry Wadsworth Longfellow, Thomas Brackett Reed, Edward Preble and his nephew George Henry Preble, Mrs Parton ("Fanny Fern"), Nathaniel Parker Willis, Seargent Smith Prentiss and Neal Dow, and it was the home of William Pitt Fessenden, Theophilus Parsons and Simon Greenleaf.

See W. Willis, *The History of Portland* (Portland, 1865), and William Goold, *Portland in the Past* (Portland, 1886).

PORTLAND, a city, port of entry and the county-seat of Multnomah county, Oregon, U.S.A., on the Willamette river, near its confluence with the Columbia, about 120 m. by water from the Pacific, 186 m. by rail S.S.W. of Seattle and about

772 m. N. of San Francisco. Pop. (1890), 46,385; (1900), 90,426, of whom 25,876 were foreign-born (6943 Chinese); (1910 census) 207,214. Portland is served by the Northern Pacific, the Southern Pacific, the Canadian Pacific, the Great Northern and other railways, by transpacific vessels to Hong-Kong and Yokohama, by coast-wise vessels to San Francisco, to ports on Puget Sound, in British Columbia, and in Alaska, and by river boats sailing 100 m. farther up the Willamette and up the Columbia and the Clearwater to Lewiston, Idaho. The city is built on both sides of the river (which is crossed by five bridges), and covers about 44 sq. m. On the western side the ground rises gradually for a distance of $\frac{3}{4}$ to $1\frac{1}{2}$ m., and then rises abruptly 500–1000 ft. to "Portland Heights" and "Council Crest," beyond the much-broken surface of which rises the Coast range; on the eastern side a slightly rolling surface extends to the foothills of the Cascade Mountains. From "Portland Heights" there are fine views of the Columbia and Willamette valleys, and, particularly, of the snow-clad summits of Mt Hood, Mt Jefferson, Mt St Helen's, Mt Adams and Mt Rainier (or Tacoma). In the residence districts (King's Hill, Nob Hill, Portland Heights, Willamette Heights, Hawthorne Avenue, &c.) are pleasantly shaded streets, and grounds decorated with shrubs, especially roses, which sometimes bloom as late as January—an annual "Rose Festival" is held here in June. The city has 205 acres in parks and numerous beautiful drives. It has a fine climate, the mean temperature during the winter months from 1874 to 1903 was 41° F.; the mean summer temperature for the same period 65° F. For the year ending the 31st of May 1900 the death-rate was reported to be only 9 per 1000, and in 1907 to be only 8.28 per 1000. The city's water is brought through a pipe 30 m. in length from Bull Run river, which is fed by Bull Run Lake at an elevation of more than 3000 ft. in the Cascade Mountains.

Among the prominent buildings are the Court House; the City Hall, containing the rooms of the Oregon Historical Society; the Customs House; the Protestant Episcopal Cathedral; the Public Library (with 75,000 volumes in 1908); several tall office buildings with frames of steel; and the Art Museum (1905). There are large grain elevators and miles of wharfs and docks. Among educational institutions are the law and medical departments of the University of Oregon, Hill Military Academy (1901) and Columbia University (Roman Catholic, 1901). The *Oregonian*, which was established here in 1850, is one of the most influential newspapers on the Pacific Slope.

The harbour is accessible for vessels of 26 ft. draught and the city's leading industry is the shipment by water and by rail of fish (especially salmon) and of the products (largely lumber, wheat and fruits) of the rich Willamette and Columbia valleys. It is also an important jobbing centre. The value of the exports in 1908 amounted to \$16,652,850 and the value of the imports to \$2,937,513; the foreign trade is chiefly with Great Britain and its possessions, and with the Orient, where wheat and flour are exchanged for raw silk, tea and manila and other fibres. Portland is the principal manufacturing city of the state. The total value of its factory product in 1905 was \$28,651,321. The principal manufactures were lumber and timber products (\$3,577,465) and flour and grist mill products (\$2,712,735); other important manufactures were packed meat, planing-mill products, foundry and machine-shop products, railway cars (repaired), cordage and twine, and canned and preserved fish (salmon), oysters and fruits and vegetables.

Portland, named after Portland, Maine, was founded in 1845 by two real-estate men from New England, and was chartered as a city in 1851. Its early growth was promoted by the demand for provisions from California soon after the discovery of gold there, and although a considerable portion was swept by fire in 1873 the city had a population of nearly 20,000 before railway communication with the East was established by the Northern Pacific in 1883. East Portland and Albina were annexed to the city in July 1891. The Lewis and Clark Centennial and American Pacific Exposition and Oriental Fair was held in Portland in 1905 in commemoration of the expedition of Meriwether Lewis and William Clark to this region in 1805. The forestry building, 205 ft. long by 108 ft. wide and built of logs of Oregon fir 6 ft. or more in diameter and 54 ft. long, and a building devoted entirely to the subject of irrigation, were of unusual interest. The forestry building is now maintained as a museum chiefly for timber and timber products.

PORTLAND, ISLE OF, properly a peninsula of the coast of Dorsetshire, England, as a prolongation of a narrow ridge of shingle, Chesil Bank (*q.v.*), connects it with the mainland. Pop. (1901), 15,262. It is 4 m. long and nearly $1\frac{1}{2}$ in extreme breadth, with an area of about $4\frac{1}{2}$ sq. m. The shores are wild and precipitous, and Portland is inaccessible from the sea except towards the south. The highest point, close upon 500 ft., is the Verne hill in the north. Wave action is seen in the numerous caverns, and south-east of Portland Bill, the southern extremity of the isle, is a bank called the Shambles, between which and the land there flows a dangerous current called the Race of Portland. A raised beach is seen at Portland Bill. The substratum of the island is Kimeridge Clay, above which rests beds of sand and strata of Oolitic limestone, widely famed as a building stone. Extensive quarries, which are Crown property, have supplied the materials for St Paul's Cathedral and many other important public buildings. In the "dirt-bed" resting upon the Oolitic strata numerous specimens of petrified wood are found, some of great size. The soil, though shallow, is fertile, and mutton fed on the grass has a peculiar rich flavour. Quarrying, fishing and agriculture are the chief industries. Several curious local customs are retained by the inhabitants.

A joint railway of the Great Western and London & South Western companies runs south from Weymouth to Portland ($4\frac{3}{4}$ m.) and Easton ($8\frac{1}{2}$ m.) on the isle. The isle contains a convict prison with accommodation for about 1500 prisoners. Portland Castle, built by Henry VIII. in 1520, is generally occupied by the commander of the engineers or of the regiment stationed on the island. On a rock on the eastern side are remains of a more ancient fortress, Bow and Arrow Castle, ascribed to William Rufus.

A harbour of refuge, begun in 1847 under the direction of the Admiralty, was completed some fifteen years later. A breakwater stretching in a northerly direction from the north-east corner of the island partially enclosed a large area of water naturally sheltered on the south and west. An inner arm ran nearly east from the island and terminated in a masonry head and fort, and an outer detached arm bent to the north and terminated in a circular fort, a narrow entrance for shipping being left between the two. It was formed of a rubble mound quarried by convict labour at the summit of the island, and was lowered by a wire-rope incline to the sea. The harbour thus made was open on the north to Weymouth and the Channel, but the necessity for greater protection from torpedo attack made it advisable to complete the enclosure. Accordingly the Naval Works Acts of 1895 and subsequent years sanctioned works for closing the gap—about 2 m. long—between the end of the outer breakwater and the Bingleaves rocks near Weymouth, by two new breakwaters. One of these runs nearly east from the Bingleaves shore and is about 4642 ft. long, while from its extremity the other, about 4465 ft. long, stretches in a south-east direction towards the old outer breakwater, passages for navigation about 700 ft. wide separating it from its neighbours at each end. These new structures also consist of rubble mounds. The defensive harbour thus completely enclosed has an area of 2200 acres to the one-fathom line, of which 1500 acres have a depth of not less than 30 ft. at low water. There is no dockyard at Portland, but the watering and coaling arrangements for the supply of the fleet are of considerable importance. There is a coaling jetty and camber for the storage of both sea-borne and land-borne coal, with hydraulic appliances for handling it. The harbour and island are strongly fortified.

The isle of Portland is not mentioned in the time of the Romans. In 837 it was the scene of an action against the Danes, and in 1052 it was plundered by Earl Godwine. In 1643 the parliamentary party made themselves masters of the island and castle, but shortly afterwards these were regained by the Royalists through a clever stratagem, and not recovered again by the forces of the parliament till 1646.

PORTLANDIAN, in geology, a subdivision of the Upper Jurassic system that includes the strata lying between the Kimeridge Clay and the Purbeck beds. These rocks are well exposed on the isle of Portland, Dorsetshire, where they have been quarried for more than 200 years. J. Mitchell appears to have been the first to use the term "Portland lime" in geological literature (1788); T. Webster spoke of the "Portland Oolite" in 1812. In England the strata are very variable: the upper part consists principally of limestones, shelly, oolitic or

compact, or in places very closely resembling chalk (Upway, Portisham, Brill, Chilmark). Nodules and layers of chert are well developed in some of the limestones of Dorsetshire and elsewhere; and a silicified oolite occurs near St Alban's Head. About Swindon, beds of sand are common in the Upper Portland beds with layers of calcareous sandstone (Swindon stone). Marly and sandy beds occur also at Shotover Hill. The lower portion is usually sandy and shows a gradual passage into the underlying Kimeridge Clay. W. H. Fitton in 1827 gave the name "Portland Sand" to this division. The Upper Portlandian in Dorsetshire is 130–170 ft. thick; the Lower Portlandian in the same district is 100–120 ft. These rocks crop out from South Dorsetshire into Wiltshire, Oxfordshire and Buckinghamshire, and possibly extend beneath younger rocks into Bedfordshire and Cambridgeshire. They have been proved by borings in Sussex and Kent, and in Yorkshire they are represented by part of the Speeton Clays, and in Lincolnshire by part of the Spilsby Sand. At Swindon and Aylesbury a conglomeratic layer with small pebbles of lydite and phosphatized fossils lies at the base of the Portland Stone.

The Upper Portlandian of England is characterized by the ammonite *Perisphinctes giganteus*, along with *Cytheria* (*Cyrena*) *rugosa*, *Trigonia gibbosa*, *Perisphinctes boloniensis* and *Trigonia incurva* as subzonal forms. *Olcostephanus gigas* is the zonal ammonite in the Lower Portlandian, associated with *Trigonia Pellati*, *Cyprina Brongniarti*, *Exogyra brantrutana* and *Astarte Saemanni* as subzonal indices. Other characteristic fossils are *Cerithium portlandicum*, the casts of which form the familiar "Portland screw," *Isastraea oblonga*, the Chelonian *Stegochelys*; the remains of saurians *Pliosaurus* and *Cimoliosaurus* and others are found; *Mesodon*, *Ischyodus* and other fishes occur in this formation. The Portland limestones have been much in demand for building purposes; at Portland the "Top Roach," the "Whit Bed" or top freestone, and the "Best Bed" (or Base Bed) are the best known. In the Vale of Wardour the lower Portlandian has been largely quarried; the stone from this neighbourhood is often described as Wardour, Tisbury or Chilmark stone. Swindon stone is a calcareous sandstone that occurs in the sands of the Upper Portland beds near Swindon.

Rocks of Portlandian age are well developed on the continent of Europe, but the grouping of the strata is different in some respects from that adopted by English geologists. In France the "Portlandian" is usually taken to include the Purbeckian as well as the equivalents of the English Portland beds, and some authors, e.g. E. Renevier, have included more or less of the Kimeridgian in this division. The Portlandian of north-west Germany includes the Eimbeckhäuser Plattenkalk and the Lower Portland Kalk. Oppel's "Tithonian" (tithonic) division, embracing Upper Kimeridge beds, Portlandian and Purbeckian beds in the Alpine district, is now recognized as a deeper water deposit of this time with many points of resemblance to the Russian development to which the name "Volgian" has been applied by S. Nikitin. The Portlandian beds of Yorkshire are more nearly related to the Volgian phase than to the beds of the same age in the south of England. The term Bononian (= Bolonian) was suggested by J. F. Blake in 1881 for a part of the Portlandian series, from their occurrence at Boulogne (Bononia) where they are similar to the beds of Dorset. He limited the name Portlandian to the Purbeckian and Upper Portlandian (Portland stone), while he placed the Portland Sands and upper part of the Kimeridge Clay in his Bolonian division: this scheme has not been accepted in England. See JURASSIC.

PORTLOCK, JOSEPH ELLISON (1794–1864), British geologist and soldier, the only son of Nathaniel Portlock, captain in the Royal Navy, was born at Gosport on the 30th of September 1794. Educated at the Royal Military Academy he entered the Royal Engineers in 1813. In 1814 he took part in the frontier operations in Canada. In 1824 he was selected by Colonel (afterwards Major-General) T. F. Colby (1784–1852) to take part in Ordnance Survey of Ireland. He was engaged for several years in the trigonometrical branch, and subsequently compiled information on the physical aspects, geology and economic products of Ireland. In 1837 he formed at Belfast a geological and statistical office, a museum for geological and zoological specimens, and a laboratory for the examination of soils. The work was then carried on by Portlock as

the geological branch of the Ordnance Survey of Ireland, and the chief results were embodied in his *Report on the Geology of the County of Londonderry and of parts of Tyrone and Fermanagh* (1843), an elaborate and well-illustrated volume in which he was assisted by Thomas Oldham. After serving in Corfu and at Portsmouth he was, in 1849, appointed Commanding Royal Engineer at Cork, and from 1851–1856 he was Inspector of Studies at the Royal Military Academy, Woolwich. For a short time commanding officer at Dover, when the Council of Military Education was formed in 1857 he was selected as a member.

During these years of active service he contributed numerous geological papers to the scientific societies of Dublin and to the British Association. He published in 1848 a useful treatise on geology in Weale's "Rudimentary Series" (3rd. ed., 1853). He was president of the geological section of the British Association at Belfast (1852), and of the Geological Society of London (1856–1858). He wrote a *Memoir of the late Major-General Colby, with a Sketch of the Origin and Progress of the Trigonometrical Survey* (reprinted in 1869 from *Papers on Subjects connected with the Royal Engineers*, vols. iii.–v.). He also contributed several articles on military subjects to the 8th edition of the *Encyclopaedia Britannica*. He was elected a Fellow of the Royal Society in 1837. He died in Dublin on the 14th of February 1864.

PORT MAHON, or MAHON (Spanish *Puerto Mahón*), the capital and principal seaport of Minorca, in the Spanish province of the Balearic Islands. Pop. (1900), 17,144. Port Mahon is situated on the east coast, at the head of a deep inlet which extends inland for 3½ m. It is an important harbour (see MINORCA). The city occupies a conspicuous hill, and presents a fine appearance from the sea; it is solidly built of excellent stone. Many of the houses date from the British occupation, which has also left curious traces in the customs and speech of the people. The King's Island (Isla del Rey, so called as the landing-place of Alphonso III. of Aragon in 1287) contains a hospital built by the admiral of the British squadron in 1722; farther south-east on the shore is the village of Villa Carlos or George Town, with ruins of extensive British barracks; and at the mouth of the port, on the same side, are the remains of Forte San Felipe, originally erected by Charles V. and twice the scene of the capitulation of British troops. Opposite San Felipe is the easily defended peninsula of La Mola (256 ft. high), which is occupied by extensive Spanish fortifications. Mahon is one of the principal quarantine stations of Spain; the lazaretto, erected between 1798 and 1803, stands on a long tongue of land, separated from La Mola by the inlet of Cala Taulera. The principal modern buildings are the military and naval hospitals, the theatre, museum, library and schools. There are an arsenal and extensive quays. From its position on the route of vessels plying between Algeria and the south of France, the harbour is much frequented by French cargo-steamers; it is also a Spanish naval station. The principal exports are grain, live stock and fruit; cement, coal, iron, machinery, flour, raw cotton and hides are imported. Shoes and cotton and woollen goods are manufactured. About 250 vessels enter the port every year, and the annual value of the foreign trade is, approximately, £200,000 to £250,000.

Mahon is the ancient *Portus Magonis*, which under the Romans was a municipium (*Mun. flavium magonitanum*), probably including the whole island under its authority. As the name suggests, it had previously been a Carthaginian settlement. The Moors, who occupied Minorca in the 8th century, were expelled by James I. of Aragon in 1232. Khair-ed-Din Barbarossa besieged and captured the city in 1535; and in 1558 it was sacked by a corsair called Piali. The British, who under James Stanhope, afterwards Earl Stanhope, seized the island in 1708, made Mahon a flourishing city, and in 1718 declared it a free port. In 1756 it fell into the hands of the French through the failure of Admiral Byng to relieve the garrison of St Philip's (San Felipe). Restored to the British in 1762, it was in 1782 heroically but unsuccessfully defended by General Murray. In 1802 it was finally ceded to Spain by the treaty of Amiens.

PORTMANTEAU, a leather case or trunk for carrying articles of personal use when travelling. The typical portmanteau of

the present day has two compartments which, fastened at the back by hinges, close together like a book. The original port-manteau (adopted from Fr. *portemanteau*, *porter*, to carry, *manteau*, cloak, mantle) was a flexible round leather case to hold a cloak or other garment and of such a shape as could conveniently be carried on a rider's saddle. In French the word was also applied to a bracket or set of pegs on which to hang clothes. C. L. Dodgson ("Lewis Carroll") in *Through the Looking Glass* ("The Song of the Jabberwock") used the expression "port-manteau word" of an invented word composed of two words run together and supposed to convey humorously the combined meaning: thus "slithy" conveys slimy and lithe; "mimsy," flimsy and miserable.

PORTO ALEGRE, a city and port of Brazil, capital of the state of Rio Grande do Sul, at the northern extremity of Lagôa dos Patos on the eastern shore of an estuary called Rio Guahyba, about 160 m. from the port of Rio Grande do Sul at the entrance to the lake. The population which contains a large foreign element, chiefly German and Italian, was returned as 73,574 by the census of 1900, including some outlying districts not within urban limits. The *município* (commune), which has an area of 931 sq. m., had a population of nearly 100,000, including a large number of prosperous colonists. The railway from Porto Alegre to Novo Hamburgo and Taquara (55 m.) affords an outlet for some of the older German colonies. The railway from Porto Alegre to Urugayana is completed from Margem da Taquary to Cacequy, 232 m. Its starting point, Margem da Taquary, is about 80 m. from the city, with which it is connected by river steamers. An extension of the railway is projected from Margem da Taquary to Neustadt on the Novo Hamburgo line, and will give the city direct railway connexion with the principal cities of western and southern Rio Grande do Sul. The Rio Guahyba, which is not a river, was once called "Viamão" because its outline is roughly that of the human hand, the rivers entering the estuary at its head corresponding to the fingers. The lower channels of these rivers (the Gravaty, Sinos, Cahy, Jacuhy and Taquary) are all navigable and bring considerable trade to the port. Its foreign trade is limited to light-draught steamers able to cross the bar at the entrance to the lake.

The city occupies a tongue of land projecting into the estuary, and extends along its shores and back to a low wooded hill. Its site, as seen from the water, is attractive, though its larger part is an almost level plain. There are pleasant suburbs along the shore and farther inland (Floresta, Gloria, Moinhos de Vento, i.e. "Windmills," Navigantes and Partenon). The climate is sub-tropical, cool and bracing in winter but insufferably hot in summer. The mean annual temperature is slightly under 69° F., the average maximum being a little over 82° and the average minimum 59°. The annual rainfall is about 30½ in. The city is regularly laid out with broad, straight, well-paved streets, in great part lined with shady trees. The waterside streets, however, follow the curve of the beach. There are several public squares and gardens, the more important being the Praça Harmonia, the Praça d'Alfandega, Praça da Independencia and the Parque, where an exposition was held in 1901. The public water supply is drawn from a range of hills 6 m. distant and is considered good. Porto Alegre, like many Brazilian cities, is in a transition stage, and handsome new structures of French and Italian styles rise from among the low, heavy and plain old buildings of Portuguese origin. Brick and broken stone are chiefly used in the walls, which are plastered outside and tinted. Tiles are used for roofing, and on modern edifices stucco ornamentation is lavishly employed. The most noteworthy public buildings are the Cathedral (Porto Alegre being the see of a Roman Catholic bishop), the handsome church of Nossa Senhora das Dores, the municipal palace, school of engineering, government palace, legislative halls, school of medicine, athenaeum, normal school and public library and military barracks. One of the hospitals—that of Caridade—is the largest in the state. The city is the chief commercial centre of the state and has shipyards for the construction of river and lake vessels. It manufactures cotton fabrics, boots and shoes, iron safes and stoves, carriages, furniture, butter and cheese, macaroni, preserves, candles, soap and paper.

Porto Alegre was founded in 1743 by immigrants from the Azores and was at first known as Porto dos Captaes. Owing to the occupation of the southern part of the captaincy by the Spaniards, Governor Jose Marcellino de Figueredo selected this village in 1770 as his official residence and gave to it the name it

now bears. It was made a *villa* in 1803, and in 1807, when Rio Grande do Sul was made a captaincy-general, the transfer of the capital from Rio Grande to Porto Alegre was officially recognized. In 1822 it was raised to the rank of a city, and in 1841, as a reward for its loyalty in revolutionary wars of that province, it was distinguished by the title of *leal e valorosa* (loyal and valorous). The first German immigrants to settle near Porto Alegre arrived in 1825, and much of its prosperity and commercial standing is due to the German element.

PORTOCARRERO, LUIS MANUEL FERNANDEZ DE (1635–1709), cardinal archbishop of Toledo, was a younger son of the marquis of Almenara and was born on the 8th of January 1635. He became dean of Toledo early, and was made cardinal on the 5th of August 1669. Till 1677 he lived at Rome as cardinal protector of the Spanish nation. In 1677 he was appointed interim viceroy of Sicily, counsellor of state and archbishop of Toledo. He ceased to be viceroy of Sicily in 1678. As archbishop of Toledo he exerted himself to protect the clergy from the obligation to pay the excises or *octroi* duties known as "the millions" and thereby helped to perpetuate the financial embarrassments of the government. His position rather than any personal qualities enabled him to play an important part in a great crisis of European politics. The decrepit King Charles II. was childless, and the disposal of his inheritance became a question of great interest to the European powers. Portocarrero was induced to become a supporter of the French party, which desired that the crown should be left to one of the family of Louis XIV., and not to a member of the king's own family, the Habsburgs. The great authority of Portocarrero as cardinal and primate of Spain was used to persuade, or rather to terrify the unhappy king into making a will in favour of the duke of Anjou, Philip V. He acted as regent till the new king reached Spain and hoped to be powerful under his rule. But the king's French advisers were aware that Spain required a thorough financial and administrative reform. Portocarrero could not see, and indeed had not either the intelligence or the honesty to see, the necessity. He was incapable, obstinate and perfectly selfish. The new rulers soon found that he must be removed and he was ordered to return to his diocese. When in 1706 the Austrian party appeared likely to gain the upper hand, Portocarrero was led by spite and vexation to go over to them. When fortune changed he returned to his allegiance to Philip V., and as the government was unwilling to offend the Church he escaped banishment. In 1709 when Louis XIV. made a pretence of withdrawing from the support of his grandson, the cardinal made a great display of loyalty. He died on the 14th of September and by his orders the words *Hic jacet pulvis, cinis, et nihil* were put on his tomb.

See Lord Stanhope, *History of the War of Succession in Spain* (London, 1832).

PORTO FARINA, a town of Tunisia about 20 m. E. of Bizerta, on the Ghar-el-Mela, a lagoon, also known as the Lake of Porto Farina, at the mouth of the Mejerda (the ancient Bagradas). Porto Farina was the naval arsenal of the piratical beys of Tunis and was bombarded by the English under Admiral Blake in 1655. The lagoon has become very shallow in consequence of the silt brought down by the Mejerda. The town has ceased to be important, and its inhabitants have dwindled to about 1500. The ruins 10 m. to the south-west, near the village of Bu Shater, are identified with the ancient Utica (q.v.).

PORTO MAURIZIO, a city of Liguria, Italy, the capital of the province of Porto Maurizio, on the coast of the Ligurian Sea, 46 m. by rail E. of Nice and 70 m. S.W. of Genoa, 115 ft. above sea-level. Pop. (1901), 7207. It consists of a picturesque old town on the heights and a modern town of villas on the lower slopes. The principal church, designed by Gaetano Cantone, is a large structure of 1780 with a dome rebuilt in 1821. A few remains of the old city walls may be seen. About 2 m. north-east of Porto Maurizio is the town of Oneglia, with a fine church, S. Giovanni Battista, designed by Gaetano Amoretti, a hospital (1785) and a large prison. It suffered considerably from the earthquake of 1887. Maurizio and Oneglia lie on the same bay

and both have small but safe harbours, both are frequented for sea-bathing, and both are embowered amid olive groves; and the district is famous for the quality of its oil. The two towns together form one commune, called imperia, which had a population of 15,459 in 1907.

Porto Maurizio appears as *Portus Maurici* in the Maritime Itinerary. After being subject to the marquises of Turin (11th century) and of Clavesana, it was sold by Boniface of Clavesana in 1288 to Genoa in return for a yearly payment; in 1354 it became the seat of the Genoese vicar of the western Riviera, and remained in the possession of the republic till it was merged in the kingdom of Sardinia. Oneglia, formerly situated inland at the place called Castelvecchio (old castle), has occupied its present site from about 935. The bishops of Albenga sold it in 1298 to the Dorias of Genoa, who in their turn disposed of it in 1576 to Emanuel Philibert of Savoy. In the wars of the house of Savoy Oneglia often changed hands. In 1614 and 1649 the Spaniards and in 1623 and 1672 the Genoese obtained possession; in 1692 it had to repulse an attack by a French squadron; in 1744-1745 it was again occupied by the Spaniards, and in 1792 bombarded and burned by the French. Pellegrino Amoretti, assistant secretary to Charles V., and Andrea Doria, the famous admiral, were natives of Oneglia.

See G. Donaudi, *Storia di Porto Maurizio* (1889).

PORTO NOVO, a town of British India, on the Coromandel coast in the South Arcot district of Madras. Pop. (1901), 13,712. The English began trading here in 1683, when they found both the Danes and the Portuguese already established. The place is chiefly famous for the battle in July 1781, in which Sir Eyre Coote with 8000 men defeated Hyder Ali with 60,000 and saved the Madras presidency. In 1830 an attempt, finally unsuccessful mainly owing to the lack of fuel, was made to smelt iron from the ores found in the vicinity.

PORTO-RICHE, GEORGES DE (1849-), French dramatist, was born at Bordeaux. When he was twenty his pieces in verse began to be produced at the Parisian theatres; he also wrote some books of verse which met with a favourable reception, but these early works were not reprinted. In 1898 he published *Théâtre d'amour*, which contained four of his best pieces, *La Chance de Françoise*, *L'Infidèle*, *Amoureuse*, *Le Passé*. The title given to this collection indicates the difference between the plays of Porto-Riche and the political or sociological pieces of many of his contemporaries. In Germaine, the passionate and exacting heroine of *Amoureuse*, Mme Réjane found one of her best parts. In *Les Mafefilâtres* (Odéon, 1904), also a drama of passion, the characters are drawn from the working classes.

PORTO RICO, or PUERTO RICO ("Rich Harbour"), an island of the United States of America, the most easterly and the fourth in size of the Greater Antilles, situated between 17° 50' and 18° 30' N., and between 65° 30' and 67° 15' W., about 70 m. E. of Haiti, and 500 m. E. by S. of Cuba. It is about 100 m. long from east to west, 40 m. wide near the west end, and somewhat narrower towards the east end, and has an area of 3435 sq. m.

Physical Features.—A range of mountains, varying in height from 2000 ft. to about 3750 ft. on El Yunque Peak in the north-east corner, traverses the island from west to east and descends abruptly to the sea at each end. The south slope rises precipitously from the foothills; the north slope is more gradual, but it is much broken by rugged spurs and deep gorges. On the north there is little coastal plain except at the mouths of rivers, but on the south coast there is a plain of considerable extent broken only by the remains of eroded foothills. The water parting is about twice as far from the north coast as it is from the south coast, the rainfall is greater on the north slope, and the principal rivers—Rio Loiza, Rio de la Plata, Rio Manatí and Rio Arcibo are on the north side. There are eight other rivers on the same side, seventeen on the south side, six at the east end and four at the west end, besides more than 1200 smaller streams, and the deep valleys cut by the streams add to the broken surface of the country. None of the rivers is navigable for more than a mile or two from the coast. The coast-line has few indentations sufficient to afford safe harbourage. Under the same jurisdiction as Porto Rico are the fertile island of Vieques (21 m. long and 6 m. wide) and the smaller and nearly barren island of Culebra off the east coast, the island of Mona, covered with deposits of guano, off the west coast, and numerous islets.

Fauna.—The native fauna is scanty. The agouti and the armadillo are practically extinct and the only other mammals are ground squirrels, rats, a few other small rodents, and some bats. A huge land-turtle is peculiar to the island. Reptiles are scarce,

and venomous reptiles unknown. Noxious insects are less numerous than is usual in tropical countries. There are no large game birds, but song birds and doves are numerous on the mountains, and flamingoes and other water-birds frequent the coast. There are a few species of fresh-water fish, but food-fishes are scarce both in the rivers and along the coast.

Flora.—The flora is beautiful and varied. The more rugged districts and higher elevations are clad with such tropical forest trees as ebony, Spanish cedar, sandalwood, rosewood and mahogany. There are several species of palms, flowering trees, trees with beautifully coloured foliage, tree ferns, resinous trees and trees bearing tropical fruits. There are about thirty species of medicinal plants, twelve used for condiments, and twelve for dyes and tanning. In the semi-arid districts on the south slope of the mountains the flora consists chiefly of dry grasses, acacias, yuccas and cactuses.

Climate.—The climate is somewhat more healthy than that of the other West Indies. The temperature is moderated by the north-east trade winds, which, somewhat modified by local conditions, blow throughout the year, briskly during the day and more mildly during the night. It rarely reaches 100° F. or falls below 50°, and the mean annual temperature is about 80° (75.2° in January, 80.4° in August). The mean daily variation at San Juan is 11.5°; on the mountains the mean daily variation is 23°. The average annual rainfall on the north-east coast, at the foot of

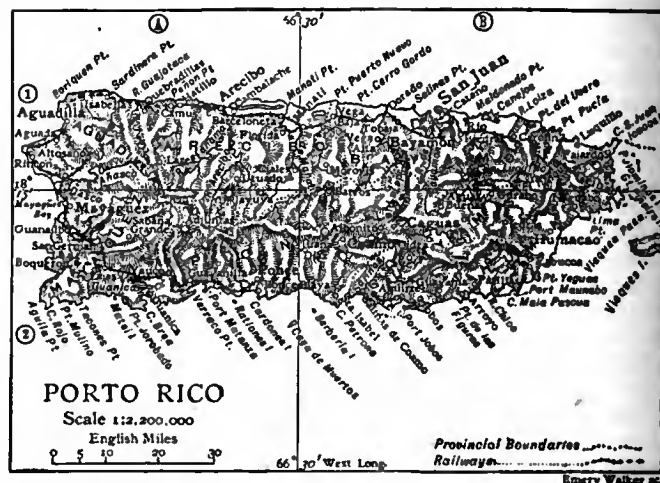

El Yunque Mountain, is 120 in. or more, while other districts are semi-arid or subject to severe droughts. At San Juan the average annual rainfall is about 55 in.; nearly two-thirds of this falls from June to November inclusive. Most of the rain is in showers, frequently heavy; and on the windward slope showers are an almost daily occurrence. The island is visited occasionally by hurricanes.

Soil.—Close to the coast the soil is for the most part a coral sand. Farther inland in the level districts and river bottoms it varies from a sandy to a clay loam containing much alluvium. On the foothills and in the less rugged mountain districts there is a thin but rich clay soil derived from coral limestone.

Industries.—A little more than one-fourth of the land is under cultivation and in 1899 more than three-fifths of the working population were engaged in agriculture. There were over 39,000 farms, nearly all of them small, and the average number of acres cultivated on each was not more than fifteen. Sugar on the lowlands, coffee on the upper, and tobacco on the lower mountain slopes are the principal crops. In 1909 there were 185,927 acres of sugar, yielding 244,257 tons for exportation, and valued at \$18,432,446. The coffee plantations were greatly injured by a severe hurricane which visited the island on the 8th of August 1899, but the yield for export increased from 12,157,240 lb in 1901 to 38,756,750 lb, valued at \$4,693,004, in 1907. The acreage, however, decreased from 178,155 acres in 1906 to 155,778 acres in 1909, and in the latter year the crop fell to 28,489,263 lb. Java coffee has been grown with success in Porto Rico. Tobacco of a superior quality is grown extensively on the lower northern slopes and much tobacco is now grown under cloth. The total acreage of tobacco increased from 12,871 acres in 1906 to 27,596 acres in 1909; the total value of the exported tobacco products increased from \$681,642 in 1901 to \$5,634,130 in 1909. Cotton, Indian corn, sweet potatoes, yams and rice are small crops. The culture of citrus fruits, principally oranges and grape-fruit, and of pineapples and coco-nuts has been rapidly extended. About 13,000 head of cattle were exported annually from 1901 to 1905, but much of the best grazing land has since been devoted to the cultivation of sugar-cane. A project for irrigating the district south of the mountains between Ponce and Patillas was adopted by the Porto Rican government in 1909. The Federal government has an agricultural experiment station at Mayaguez.

The mineral resources are very limited. Brick clay and limestone are abundant, and there are on the south coast a sand marl rich in phosphates and productive salt deposits. Iron ore, lignite, copper, mercury, molybdenite, nickel, platinum and other minerals have been found, but the quantity of each is too small, or the quality too poor, for them to be of commercial value. There are important mineral and thermal springs in various parts of the island.

The only manufacturing industries of much importance are the preparation of sugar, coffee and tobacco for market, and the manufacture of cigars, cigarettes, straw hats, soap, matches, vermicelli, sash, doors, ice, distilled liquors and some machinery.

Transport facilities are inadequate. The American Railroad of Porto Rico, about 190 m. long, connects the principal cities along the north and west coasts and those as far east as Ponce on the south coast; a railway between Ponce and Guayama, farther east, was virtually completed in 1910, and the Vega Alta railroad connects Vega Alta with Dorado on the north coast; but there are no inland railways and most of the products of the interior are carried to the coast in carts drawn by bullocks or on the backs of mules. The mileage of wagon roads was increased from about 170 m. in 1898 to 612 m. in 1909. The principal harbours are San Juan on the north and Ponce on the south coast; the former is accessible to vessels of about 30 ft. draught, and the latter has a natural channel which admits vessels of 25 ft. draught. Two lines of steamboats afford regular communication between San Juan and New York; one of them runs to Venezuelan ports and one to New Orleans; and there are lines to Cuba and direct to Spain.

The commerce of Porto Rico is principally with the United States. The value of its exports to the United States increased from \$5,581,288 in the fiscal year ending on the 30th of June 1901 to \$26,998,542 in 1909, and the value of its imports from the United States increased during this period from \$7,413,502 to \$25,163,678. In the meantime the value of its exports to foreign countries increased only from \$3,002,679 to \$4,565,598, and the value of its imports from foreign countries only from \$1,952,728 to \$3,054,318.

Population.—The population increased from 583,308 in 1860 to 798,565 in 1887, and to 953,243, or 277.5 per sq. m., in 1899. Of the total population in 1899, 589,426, or 61.8% were whites, 304,352 were of mixed blood, 59,390 were negroes and 75 were Chinese. In 1910 the census returned the population as 1,118,012. The proportion of whites is greater at the west end than at the east end, greater on the north side than on the south side, and greater in the interior than along the coast. Only 13,872, or about 1.5% of the total population of 1899, were foreign-born, and of these more than one-half were born in Spain. The married portion of the population was only 16.6% in 1899. The principal towns, with the population of each in 1910, are: San Juan, 48,716; Ponce, 35,027; Mayaguez, 16,591; Arecibo, 9612. The Roman Catholic is the predominant church and the bishopric of Porto Rico (1512) is one of the oldest in the New World.

Government.—The constitution of Porto Rico is contained in an act of the Congress of the United States (the Foraker Act) which came into operation in May 1900. The governor is appointed by the president of the United States with the advice and consent of the Senate for a term of four years, and associated with the governor is an executive council consisting of the secretary, treasurer, auditor, attorney-general, commissioner of the interior, commissioner of education, and five other members, all appointed in the same manner and for the same term as the governor. The constitution requires that at least five of the eleven members of the Executive Council shall be native inhabitants of Porto Rico; in practice the six members who are also heads of the administrative departments have been Americans while the other five have been Porto Ricans. The insular government, however, has created a seventh administrative department—that of health, charities and corrections—and requires that the head of this shall be chosen by the governor from among the five members of the Executive Council who are not heads of the other departments.

The Executive Council constitutes one branch of the legislative assembly; the House of Delegates the other. The House of Delegates consists of 35 members elected biennially, five from each of seven districts. The right to determine the electoral franchise is vested in the legislature itself and that body has conferred it upon practically all adult males. The governor has the right to veto any bill, and for passing a bill over his veto an affirmative vote

of two-thirds of the members of each house is required. All laws enacted by the insular legislature must also be submitted to the Congress of the United States, which reserves the right to annul them. Railway, street railway, telegraph and telephone franchises can be granted only by the Executive Council with the approval of the governor, and none can be operative until it has been approved by the President of the United States. The governor and Executive Council have the exclusive right to grant all other franchises of a public or quasi-public nature and Congress reserves the right to annul or modify any such grant.

The administration of justice is vested in a United States district court and a supreme court, district courts, municipal courts and justice of the peace courts of Porto Rico. The judge of the United States district court and the chief justice and associate justices of the supreme court are appointed by the President with the consent of the Senate, and the judges of the district courts by the governor with the consent of the Executive Council.

The principal local government is that of the municipalities or municipal districts, but for the Spanish municipal government the insular legislature has substituted one resembling that of small towns in the United States, and it has reduced the number of districts from 66 to 47. Each municipal district elects biennially a mayor and a municipal council, the membership of which varies from five to nine according to the population of the district. The mayor appoints practically all municipal employes and may veto any ordinance of the council; his veto, however, may be overridden by two-thirds of the council. The police force of each municipality, or rather of each of 66 police districts, is maintained and controlled by the insular government; justice in each municipality is also administered by the insular government; the building, maintenance and repair of public roads are under the management of a board of three road supervisors in each of the seven insular election districts; and matters pertaining to education are for the most part under the insular commissioner of education and a school board of three members elected biennially in each municipality; nearly all other local affairs are within the jurisdiction of the mayor and municipal council.

Education.—In 1899 more than three-fourths of the inhabitants ten years of age or over were unable to read or write, and when in the following year the present system of government was established large powers were given to the commissioner of education. He controls the expenditure of public money for school purposes, the examination and the appointment of teachers, whose nominations by the municipal school boards are referred to the commissioner. The school system comprises preparatory schools, rural schools, graded schools, three high schools and the university of Porto Rico. The university at Rio Piedras was established by act of the insular legislature in 1903, but in 1910 only two departments had been organized—the insular normal school and the department of agriculture. Numerous scholarships have been established at government expense in Porto Rican schools and in colleges or universities of the United States. The average daily attendance in the public schools increased from 47,277 in 1906–1907 to 74,522 in 1908–1909. Each municipality is required to pay to its school board 25% of its receipts from the general property tax.

Finance.—Trade between Porto Rico and the United States is free, but upon imports to Porto Rico from foreign countries the Federal government collects custom duties and pays the net proceeds to the insular government. Other principal sources of income are excise taxes, a general property tax, an inheritance tax and a tax on insurance premiums. For the fiscal year ending June 1909 the net income of the insular government was \$3,180,111.75 and the net bonded indebtedness was \$3,759,231.22.

History.—On his second voyage Columbus sighted the island, to which he gave the name San Juan Bautista, and remained in its vicinity from the 17th to the 22nd of November 1493. In 1508 Nicolás de Ovando, governor of Hispaniola (Haiti) rewarded the services of Juan Ponce de Leon, one of Columbus's companions in 1493, by permitting him to explore the island, then called by the natives "Borinquen," and search for its reputed deposits of gold. Ponce's hospitable reception by the native chief, Aquebana or Guaybaná, and his fairly profitable search for the precious metal led King Ferdinand in 1509 to give him an appointment as temporary governor of the island, where his companions had already established the settlement of Caparra (Pueblo Viejo, near the present San Juan). In 1510 the king through Ovando's influence made this commission permanent. Meanwhile Ferdinand had also restored to Diego Columbus, son of the discoverer, the privileges of his father, including the control of the islands of Haiti and Porto Rico. The new admiral removed Ponce and appointed Juan Cerón to administer the affairs of Porto Rico. The quarrels between these two leaders disturbed the affairs of the island for the next

two years, but in the end Ponce was forced to yield the political control to the representatives of Columbus. While Ponce was exploring Florida in 1513 the conquerors of Porto Rico had established their domination in the upper western portion of the island by a series of settlements. The ruthless methods by which the Spaniards forced the natives to labour for them caused a change in the attitude of the erstwhile friendly Borinqueños. Both Ponce and his rivals had introduced the system of repartimientos established by Columbus in Haiti. A preliminary distribution of 1060 natives in 1509-1510 was the direct precursor of the rebellion of the natives in 1511. For a time the Borinqueños, aided by Caribs from the neighbouring islands, threatened to destroy all vestiges of white occupation in Porto Rico, but in the end the Spaniards prevailed. Immediately after this rebellion a second distribution of more than 4000 natives foreshadowed the rapid disappearance of those unfortunates, despite the well-meaning regulations of the Council of the Indies. For some decades the inevitable extermination was postponed by the fact that the Spaniards were not numerous enough to occupy the southern and eastern portions of the island. Here a remnant of the Borinqueños, assisted by the Caribs, maintained a severe struggle with the conquerors, but in the end their Indian allies were subdued by English and French corsairs, and the unfortunate natives of Porto Rico were left alone to experience the full effect of forced labour, disastrous hurricanes, natural plagues and new diseases introduced by the conquerors. By 1520 philanthropic churchmen directed their attention to the miserable conditions of the natives; but remedial legislation was largely nullified by the rapacity of subordinate officials, and before the end of the 16th century the natives disappeared as a distinct race.

To replace the natives as a labour element and also to preserve them from extermination African slavery was early permitted, and by 1530 there were over 1500 negro slaves in Porto Rico. Although the extravagant prices paid at first almost ruined the planters, the traffic continued to flourish in hands of foreign concessionaires until 1820, when through English influence it was abandoned. At this period negroes were an important element of the population, but by no means the most numerous one.

At no period of its history has Porto Rico enjoyed great prosperity. Besides the causes already indicated the evil character of many of the white settlers conspired to retard its development. In 1515 its European population may have been 400. Until 1782 the island was divided into the eastern district of Puerto Rico and the western one of San Germán. In 1513 the arrival of its first bishop, who later also exercised the function of general inquisitor, added one more to the discordant elements ruling the island. About 1520 Caparra was abandoned for a more healthy site, and the city of San Juan de Puerto Rico was founded as the capital of the eastern district. In time Puerto Rico became the name of the whole island. In 1536 legislation for changing the method of general government and regulating common pasturages and public property caused extreme dissatisfaction, but for many years thereafter the form of control alternated between alcaldes selected by the inhabitants and annual governors appointed by the Council of the Indies.

To the difficulties caused by disaster, depopulation and maladministration there was added the danger of foreign invasion when war broke out in Europe between Francis I. of France and the emperor Charles V. In 1528 San Germán was plundered by a French corsair and twenty-six years later utterly destroyed. In 1533 the *fortaleza*, now the governor's palace, was begun at San Juan, and in 1539-1584 Morro Castle was erected at the entrance of the harbour. Possibly these slight fortifications preserved the capital from the destruction which overwhelmed all the other settlements; but these measures for defence were due more to the loyalty of the inhabitants than to the efforts of the home government, which at this time remained indifferent to appeals for help from the island.

In 1595 San Juan was unsuccessfully attacked by an English fleet under Sir Francis Drake; two years later another English force, led by Sir George Cumberland, occupied the city for some weeks. The city was attacked in 1625 by a Dutch fleet, which was easily repulsed. The buccaneers or filibusters, who during the 17th century were drawn to the West Indies by the prospect of plundering the possessions of decadent Spain, often invaded Porto Rico, but that island escaped the conquest which Haiti experienced. The English attacked the island in 1678, 1702, 1703 and 1743; and in 1797 an English force attempted to reduce San Juan, but was repulsed by the strong fortifications vigorously manned by resident volunteers. After this event the city was permitted to add the words "very noble and very loyal" to its coat of arms.

Porto Rico was comparatively unaffected by the great Spanish-American uprising of the early 19th century. During the struggle of Spain against Napoleon, the island, in common with the other American dominions, was represented in the Spanish Cortes and had its first legislative assembly. Trade with the United States was permitted in 1815, although only in Spanish ships. The island suffered from the reactionary policy of Ferdinand VII., but the few sporadic attempts at revolution between 1815 and 1820 were readily suppressed. Columbian insurgents made ineffectual attempts to invade the island during 1819-29. Governor Miguel de la Torre, who ruled the island with vice-regal powers during the second period of Ferdinand's absolutism, sternly repressed all attempts at liberalism, and made the island the resort for loyal refugees from the Spanish mainland. This policy, coupled with certain administrative and revenue reforms, and some private attempts in behalf of public education, made the last seven years of his rule, from 1827 to 1834, the most prosperous in the Spanish régime. The unsettled political condition of Spain during the next forty years was reflected in the disturbed political conditions of Porto Rico and Cuba. The suffrage was restricted, the Press was placed under a strict censorship, and the right of public assemblage was unknown. Economically the island in 1868 was in a much worse condition than thirty years before. The Revolution of 1868 in Spain promised such salutary changes for the Antilles as the introduction of political parties, the restoration of representation in the Spanish Cortes, and the enfranchisement of the slaves; but the imprudent "Insurrection of Lares," and other outbreaks of 1867-68, delayed these anticipated reforms. The reactionaries feared separation from the mother country. Under the short-lived republican government in Spain Porto Rico was in 1870-1874 a province with a provincial deputation, and in 1873 slavery was abolished. After the restoration of the monarchy under Alphonso XII. there was some improvement in the commerce of the island, but politically it displayed all the evils of an obsolete system of administration disturbed by a premature liberalism. In 1877 the provincial deputation was re-established, but it was not until 1895 that the home government attempted, far too late, to enact a series of adequate reform measures, and in November 1897 followed this by a grant of autonomy.

When in April 1898 war broke out between Spain and the United States the former strongly garrisoned the island, but the fortifications of the capital were largely of the massive stone construction that had repelled Abercrombie a century before, most of the artillery was of an obsolete pattern and the few cruisers in the harbour were antiquated in type. The American invasion of the island occurred in July. On the 25th of that month, while a few vessels made a demonstration before San Juan, the main American fleet was landing some 3400 troops under General Nelson A. Miles at Guánica, a small town on the southern shore, some 15 m. west of Ponce. Three days later the latter town surrendered, amid demonstrations of joy on the part of the inhabitants. The people seemed to regard the American flag as the harbinger of a new era. General Miles's policy in affording employment for the natives likewise served to make the new American régime acceptable.

Meanwhile the Spanish governor-general, Manuel Macias y

Casado, had ordered the forces under his command in the southern part of the island to fall back towards the ridge of mountains intersecting it from east to west, just north of the town of Coamo. Reinforcements were also brought up from San Juan and preparations made to resist an attack by the Americans, despite the current rumours of approaching peace. On their part the American forces, now numbering about 10,000 men, prepared to advance by separate routes across the island in four columns. Guayama, Mayagüez and Coamo were occupied; one portion of the army was within 20 m. of the northern coast and another had advanced along the main military road nearly to Aibonito, when the signing of the peace protocol on the 12th of August caused an immediate suspension of hostilities. The advance of the Americans had been rapid and decisive, with a small loss of life—three killed and forty wounded—due to the skill with which the military manœuvres were planned and executed and the cordial welcome given the invaders by the inhabitants. By November the Spaniards had evacuated the greater part of the island; after Captain General Macias embarked for Spain, General Ricardo Ortega was governor from the 16th to the 18th of October, when the island was turned over to the American forces. In the work of policing the island, in the accompanying tasks of sanitation, construction of highways and other public works, accounting for the expenditure of public funds, and in establishing a system of public education, the military control, which under the successive direction of Generals John R. Brooke, Guy V. Henry and George W. Davis, lasted until the 1st of May 1900, proved most effective in bridging over the period of transfer from the repressive control of Spain to the semi-paternal system under the American civil government. But it was hardly adapted to teach a people utterly without political experience the essential elements of self-government. To meet this problem the Congress of the United States passed the "Foraker Act," under which civil government was instituted, and which, with certain modifications is still in force (see ADMINISTRATION). Under this act the American element has exercised the controlling power, and this has proved distasteful to certain Porto Rican politicians.

On the 8th of August 1899 the island was visited by the most destructive cyclone in its history, causing a loss of about 3500 lives and a property damage amounting to 36,000,000 pesos, the coffee industry suffering most. This calamity afforded the American people an opportunity to display their generosity toward their new colony. Charles H. Allen became the first civil governor in May 1900; he was succeeded in August 1901 by William H. Hunt, who served until July 1904; Beekman Winthrop was governor in 1904-1907 and Régis H. Post from April 1907 until November 1909, when he was succeeded by George R. Colton. The island now has free trade with the United States, and receives into its general revenue fund all customs duties and internal taxes collected in the island. Its political leaders in the House of Delegates are restive under the control exercised by the Executive Council, but an attempt to hold up necessary appropriations resulted in the passage in July 1909 of an act continuing the appropriations of the previous year, whenever for any cause the lower house fails to pass the necessary financial legislation. In 1910 the coffee industry had not yet recovered from the effect of the cyclone of 1899 and the unfortunate mortgage system that prevailed under the Spanish régime. The fact that its product is shut out of its natural markets, without gaining that of the United States, is also a great handicap. The civic status of the people is still unsettled, but there has been under American rule a notable advance in the well-being of the island.

BIBLIOGRAPHY.—The main source for the history under the Spanish is Fray Inigo Abbad, *Historia geografica civil y natural de San Juan Bautista de Puerto Rico* (Madrid, 1788; a new edition with notes by Jose J. Acosta was published in Porto Rico in 1866). Abbad makes extensive quotations from early historians of Spanish America. The best modern critical account in Spanish is Salvador Brau, *Puerto Rico y su historia* (Valencia, 1894). Probably the best account in English, although one leaving much to be desired, is R. A. Van Middeldyk, *The History of Puerto Rico* (New York,

1903). R. H. Davis, *The Cuban and Porto Rican Campaigns* (New York, 1898), is a sketch of the invasion of the island in 1898. L. S. Rowe, *The United States and Porto Rico* (ibid., 1900) treats clearly and briefly of the problems arising from American control, and a like characterization may be made of W. F. Willoughby, *Territories and Dependencies of the United States* (New York, 1905). Van Middeldyk gives a brief bibliography of historical works, and a more extensive list is given in General George W. Davis's *Report on the Military Government of Porto Rico*. See also *Annual Reports of the Governor of Porto Rico* (Washington, 1901 sqq.); H. M. Wilson, "Porto Rico: Its Topography and Aspects," in the *Bulletin Amer. Geogr. Soc. New York*, vol. xxxii. (New York, 1900); W. A. Alexander, "Porto Rico: Its Climate and Resources," in the same, vol. xxxiv. (ibid., 1902); *Report on the Census of Porto Rico* (Washington, 1900); W. F. Willoughby, *Insular and Municipal Finances in Porto Rico for the Fiscal Year 1902-1903*, issued by the Bureau of the United States Census (ibid., 1905); R. T. Hill, *Cuba and Porto Rico* (New York, 1898).

PORTO TORRES (anc. *Turris Libisonis*, q.v.), a seaport on the north coast of Sardinia, 12½ m. N.W. of Sassari by rail. Pop. (1901), 3762 (town); 4225 (commune). It is only 10 ft. above sea-level, and is malarious, but is a seaport of some importance, having regular steam communication with Ajaccio, Leghorn and Cagliari, and with the north and west coasts of Sardinia. The church of S. Gavino, formerly the cathedral, probably dates from the 11th century. It is a Romanesque basilica with a nave and two aisles, divided by ancient columns; at each end of the nave is an apse. It has a 14th-century portal and two smaller doors at the sides added later in the Aragonese style. See D. Scano, *Storia dell' arte in Sardegna dal XI. al XIV. secolo* (Cagliari-Sassari, 1907), 91 sqq. To the N.N.W. is the island of Asniara, the principal quarantine station of Italy. Porto Torres was the seat of the *giudici* of the north-west portion of the island (the district was called Torres or Logudoro); it was plundered by the Genoese in 1166, but remained the seat of the *giudici* until 1272, when it was divided between various Genoese families, the Doria, Malaspina, &c., and the *giudici* of Arborea. It was also the seat of a bishopric until 1441, when the see was transferred to Sassari, Porto Torres being practically deserted, owing to its unhealthiness. It did not become an independent commune again until 1842.

PORTOVENERE (anc. *Portus Veneris*), a town and summer resort of Liguria, Italy, in the province of Genoa, at the southern extremity of the peninsula which protects the Gulf of Spezia on the west, 7 m. S. of Spezia by road. Pop. (1901), 1553 (town); 5754 (commune). The fortress and walls with which it was provided by the Genoese in the 9th or 10th century have been destroyed for military reasons. The restored church of St Peter, of black and white marble (1118; destroyed by the Aragonese in 1494), is reputed to occupy the site of a temple of Venus. The parish church dates from 1098. Yellow-veined black marble, known as Portoro, and building-stone are quarried here and in the fortified island of Palmaria to the east of Portovenere. In the Grotta dei Colombi objects of the Palaeolithic age have been found.

PORT PHILLIP, the harbour of Melbourne, Victoria, Australia. An almost circular, landlocked sheet of water, it is 31 m. long, 20 m. at its widest, with an area of 800 sq. m. A narrow channel flanked by bold cliffs forms its entrance, and when the tide recedes through it a strong current is encountered outside. The broken and somewhat dangerous sea thus caused is called "the Rip." Within the port on the eastern side are suburbs of Melbourne, such as Sorrento, Mornington, Frankston, Carrum, Mordialloc, Redcliff, Brighton and St Kilda. The wharves of Port Melbourne and Williamstown stand at the head of the port on an arm known as Hobson's Bay. On the western side the port of Geelong and the port and watering-place of Queenscliff are the only towns of importance. Port Phillip is well fortified with strong batteries at its entrance. The harbour was discovered in 1802 by Lieut. Murray, who named it in honour of Captain Phillip, first governor of New South Wales. The colony of Victoria was originally called the district of Port Phillip.

PORT PIRIE, a town of Victoria county, South Australia, on Germein Bay, an arm of Spencer Gulf, 168½ m. by rail N. by W.

of Adelaide. It is a prosperous and well-equipped port, from which enormous quantities of wheat are annually shipped. Pop. (1901), 7983.

PORTRAITURE. The earliest attempts at individual portraiture (see also PAINTING) are found in the eidolon and mummy-cases of the ancient Egyptians; but their painting never went beyond conventional representation—mere outlines filled in with a flat tint of colour. In Greece portraiture probably had its origin in skiagraphy or shadow-painting. The story of the Greek maiden tracing the shadow of her departing lover on the wall points to this. The art developed rapidly. In 463 B.C., Polygnotus, one of the first Greek painters of distinction, introduced individual portraiture in the decoration of public buildings, and Apelles nearly a century later showed so much genius in rendering character and expression, that Alexander the Great appointed him "portrait painter in ordinary," and issued an edict forbidding any one else to produce pictorial representations of his majesty. Similar edicts were issued in favour of the sculptor Lysippus and Pyrgoteles the gem engraver. No works of the Greek painters survive, but the fate of two portraits by Apelles, which were in the possession of the emperor Claudius (A.D. 41-54), is known, the heads having been painted out to make room for the features of the divine Augustus!

After the time of Alexander (300 B.C.) Greek art rapidly deteriorated. There is, perhaps, nothing in the history of human intelligence to compare with the dazzling swiftness of its development or the rapidity of its decline. War was followed by pillage and devastation, and victorious Roman generals, mere depredators and plunderers, crowded Rome with the stolen treasures of Greece, with the result that Greek art and Greek influence soon made themselves felt in the imperial city, and for generations its artists were almost exclusively Greeks, chiefly portrait painters and decorators. The Romans possessed no innate aptitude for art, and rather despised it as a pursuit little becoming the dignity of a citizen. Although lacking in appreciation of the higher conditions of art, they had from early times decorated their atria with effigies—originally wax moulds—of the countenances of their ancestors. These primitive "wax-works" ultimately developed into portrait busts, often vivid and faithful, the only branch of art in which Rome achieved excellence.

With the invasion of the Northern barbarians and the fall of the empire Graeco-Roman art ended. In the following centuries Christianity gradually became the dominant religion, but its ascetic temper could not find expression in the old artistic forms. Instead of joy in the ideals of bodily perfection, came a loathing of the body and its beauty, and artists were classed among "persons of iniquitous occupations." Before the 5th century these prejudices had relaxed, and images and pictures again came into general favour for religious uses. In the 8th and 9th centuries, the iconoclasts commenced their systematic destruction, and it was not till the Renaissance in the 13th century that art began again to live. The great revival brought with it a closer observation of the facts of nature and a growing sense of beauty, and the works of Cimabue and Giotto prepared the way for those of Benozzo Gozzoli, Ghirlandaio and the long line of masters who raised Italian art to such a height in the 15th and 16th centuries. Although the works of the early painters of the Renaissance were mostly devoted to the expression of the dogmas of the Church, the growing love and study of nature led them, as opportunity afforded, to introduce portraits of living contemporaries into their sacred pictures. Gozzoli (1420-1498) and Ghirlandaio (1449-1494) began the practice, followed by nearly all the old and great painters, of introducing portraiture into their works; Ghirlandaio especially filling some of his great fresco compositions with the forms and features of the living men and women of Florence, members of the Tornabuoni, Medici and other great families. Acuteness of observation was innate in the race. By degrees it manifested itself in a marvellous subtlety in the rendering of individual character, in the portrayal of individual men and women, and a school of

portraiture was developed of which Titian became the crowning glory. This great Venetian painter, by universal consent reckoned one of the masters of portraiture, has handed down to us the features of many of the greatest historical and literary personages of his time—emperor, pope, king, doge—all set by turn to him and loaded him with honours. The names of Bellini, Raffaele, Tintoret, Veronese and Moroni of Bergamo occur among those of the great Italian portrait painters of the 15th and 16th centuries. The last-named, some of whose finest works are now in England, was highly praised by Titian.

A love of ugliness characterizes the artists of the early German and Flemish schools, and most of the portraits produced by them previous to Holbein's time suffer from this cause. Schöngauer, Dürer and Lucas Cranach are never agreeable or pleasant, however interesting in other respects. Dürer, the typical German artist, the dreamer of dreams, the theorist, the thinker, the writer, was less fitted by nature for a portrait painter than Holbein, who, with a keen sense of nature's subtle beauty, was a far greater painter although a less powerful personality. He produced many fine works in other branches, but it is as a portrait painter that Holbein is chiefly known, and his highest claims to fame will rest on his marvellous achievements in that branch of art. He first came to England in 1526, bringing with him letters of introduction from Erasmus. Sir Thomas More received him as his guest, and during his stay he painted More's and Archbishop Warham's portraits. In 1532 he was again in London, where till his death in 1543 he spent much of his time. He was largely employed by the German merchants of the Steelyard and many Englishmen of note, and afterwards by Henry VIII., by whom he was taken into permanent service with a pension. As a portrait painter Holbein is remarkable not only for his keen insight into the character of his sitters, but for the beauty and delicacy of his drawing. As colourist he may be judged by an admirable example of his work, "The Ambassadors," in the National Gallery in London. Many of his drawings appear to have been made as preliminary studies for his portraits.

In Flanders Jan van Eyck (1390-1440), his brother Hubert, Quintin Matsys, Memlinc and other artists of the 15th century occasionally practised portraiture. The picture of Jean Arnolfini and his wife, in the National Gallery, London, is a remarkable sample of the first-named artist, and the small half-length of young Martin van Nieuwenhoven, in the hospital of St John at Bruges, of the last-named. Nearly a century later the names of Antony Mor (or Moro), Rubens and Van Dyck appear. Rubens, although not primarily a painter of portraits, achieved no small distinction in that way, being much employed by royalty (Maria de Medici, Philip IV. and the English Charles I. among the number). His services were also in request as ambassador or diplomatist, and thrice at least he was sent on missions of that nature. His personal energy and industry were enormous, but a large proportion of the work attributed to him was painted by pupils, of whom Van Dyck was one of the most celebrated. Van Dyck (1599-1641) early acquired a high reputation as a portrait painter. In 1632 he was invited to England by Charles I., and settled there for the remainder of his life. He was knighted by Charles, and granted a pension of £200 a year, with the title of painter to his majesty. Many of Van Dyck's portraits, especially those of the early and middle periods, are unsurpassed in their freshness, force and vigour of handling. He is a master among masters. England possesses many of his works, especially of his later period. To Van Dyck we owe much of our knowledge of what Charles I. and those about him were like. A routine practice, luxurious living, failing health, and the employment of assistants told upon his work, which latterly lost much of its early charm.

In Holland in the 17th century portraiture reached a high standard. A reaction had set in against Italian influence, and extreme faithfulness and literal resemblance became the prevailing fashion. The large portrait pictures of the members of guilds and corporations, so frequently met with in Holland, are characteristically Dutch. The earliest works of the kind are

generally rows of portraits ranged in double or single lines, without much attempt at grouping or composition. Later, in the hands of painters like Rembrandt, Frans Hals and Van der Helst, these pictures of civic guards, hospital regents and masters of guilds assumed a very different character, and are among the very finest works produced by the Dutch portrait painters of the 17th century. They may be termed "subscription portraits"—each member of the guild who desired a place on the canvas agreeing, before the commission was given, to pay, according to a graduated scale, his share of the cost. Among the most famous examples of this class of portraits are "The Anatomy Lesson," "The March-out of Captain Banning Kock and his Company" (erroneously called "The Night Watch"), and "The Five Syndics of the Cloth-Workers' Guild," by Rembrandt. The magnificent portrait groups at Haarlem by Hals—the next greatest portrait painter of Holland after Rembrandt—and the "Schuttersmaaltijd" by Van der Helst in the Amsterdam Museum, which Reynolds considered "perhaps the first picture of portraits in the world," must also be mentioned.

Of the pictorial art of Spain previous to the 15th century, little, if any, survives. Flemish example was long paramount and Flemish painters were patronized in high places. In the 16th century the names of native Spanish artists began to appear—Morales, Ribera, Zurbaran, a great though not a professed portrait painter; and in the last year of the century Velasquez was born, the greatest of Spain's artists, and one of the great portrait painters of the world. None, perhaps, has ever equalled him in keen insight into character, or in the swift magic of his brush. Philip IV., Olivarez and Innocent X. live for us on his canvases. His constantly varying, though generally extremely simple, methods, explain to some extent the interest and charm his works possess for artists. Depth of feeling and poetic imagination were, however, lacking, as may be seen in his prosaic treatment of such subjects as the "Coronation of the Virgin," the "Mars" and other kindred works in the Madrid Gallery. Velasquez must be classed with those whose career has been prematurely cut short. His works often show signs of haste and of the scanty leisure which the duties of his office of "Aposentador Mayor" left him—duties which ended in the fatal journey to the Isle of Rhé.

In France the most distinguished portrait painters of the 16th and 17th centuries were the Clouets, Cousin, Vouet, Philippe de Champaigne, Rigaud and Vanloo. French portraiture, long inflated and artificial, reached the height of pomposity in the reigns of Louis XIV. and XV., the epoch of which the towering wig is the symbol. In the 18th and early part of the 19th centuries occur the names of Boucher, Greuze, David, Gérard and Ingres; but somehow the portraits of the French masters seldom attract and captivate in the same way as those of the Dutch and Italian painters.

Foreign artists were engaged for almost every important work in painting in England down to the days of Sir Joshua Reynolds and Gainsborough. Henry VIII. employed Holbein; Queen Mary, Sir Antonio Moro; Elizabeth, Zuccherro and Lucas de Heere; James I. van Somer, Cornelius Janssens and Daniel Mytens; Charles I. Rubens, Van Dyck, Mytens, Petitot, Honthorst and others; and Charles II., Lely and Kneller, although there were native artists of merit, among them Dobson, Walker and Jamesone, a Scottish painter. Puritan England and Presbyterian Scotland did little to encourage the portrait painter. The attitude of the latter towards it may be inferred from an entry in the diary of Sir Thomas Hope, the Scottish Lord Advocate in 1638. "This day, Friday, William Jamesone, painter (at the earnest desyr of my sone Mr Alexander) was sufferit to draw my pictur." He does not even give the painter's name correctly, although Jamesone at the time was a man of some note in Scotland. At the commencement of the reign of George I. art in England had sunk to about the lowest ebb. With the appearance of William Hogarth (1697-1764) the English school of painting may be said to have commenced, and in Reynolds and Gainsborough it produced two portrait painters

whose works hold their own with those of the masters of the 16th and 17th centuries. Both Sir Joshua and Gainsborough are seen at their best in portraits of women and children.

George Romney (1734-1802) shared with Reynolds and Gainsborough the patronage of the wealthy and fashionable of his day. Many of his female portraits are of great beauty. For some unknown reason he never exhibited his works in the Royal Academy.

Sir Henry Raeburn (1756-1823) was a native of Edinburgh, and spent most of his life there. His portraits are broad and effective in treatment, masterly and swift in execution and often fine in colour. He painted nearly all the distinguished Scotsmen of his time—Walter Scott, Adam Smith, Braxfield, Robertson the historian, Dugald Stewart, Boswell, Jeffrey, Professor Wilson and many of the leading noblemen, lairds, clergy and their wives and daughters. For a considerable period his portraits were little known out of Scotland, but they are now much sought after, and fine examples appearing in London sale-rooms bring remarkable prices. Raeburn's immediate successor in Scotland, J. Watson Gordon (1788-1864), also painted many excellent portraits, chiefly of men. A very characteristic example of his art at its best may be seen in his "Provost of Peterhead" in the Scottish National Gallery.

Sir Thomas Lawrence (1769-1830) was the favourite English portrait painter of his time, and had an almost unrivalled career. He had an immense practice, and between the years 1787 and 1830 exhibited upwards of three hundred portraits in the Royal Academy alone. The Waterloo Gallery at Windsor contains some of his best work, chiefly painted in 1818-1819, including his portraits of the emperor Francis, Pope Pius VII. and Cardinal Gonsalvi. He was loaded with honours, and died President of the Royal Academy.

Sir J. E. Millais (1829-1896), although most widely known as a painter of figure subjects, achieved some of his greatest successes in portraiture, and no artist in recent years has approached him as a painter of children. His portraits of Gladstone, Sir James Paget, Sir Gilbert Greenall, Simon Fraser, J. C. Hook and Mrs. Bischoffsheim, to name only a few, are alone sufficient to give him a high place among British portrait painters.

Frank Holl (1845-1888) first came into note as a portrait painter in 1878, and during the subsequent nine years of his life he painted upwards of one hundred and ninety-eight portraits, an average of over twenty-two a year. The strain, however, proved too great for a naturally delicate constitution, and he died at the age of forty-three—another instance of a brilliant career prematurely cut short. To G. F. Watts (1820-1904) we are indebted for admirable portraits of many of the leading men of the Victorian era in politics, science, literature, theology and art. Among more recent artists, Sir W. Q. Orchardson (1835-1910), like Millais more widely known as a painter of figure subjects, but also admirable as a portrait painter; John Sargent (1856-), whose brilliant and vigorous characterization of his sitters leaves him without a rival; as well as Oules, Shannon, Fildes, Herkomer and others, have worthily carried on the best traditions of the art.

In France contemporary portraiture is ably represented in the works of Carolus-Duran, Bonnat and Benjamin Constant, and in Germany by Lenbach, who has handed down to posterity with uncompromising faithfulness the form and features of Prince Bismarck.

Of portraiture in its other developments little need be said. Miniature painting, which grew out of the work of the illuminator, appears to have been always successfully practised in England. The works of Hilliard, Isaac and Peter Oliver, Samuel Cooper, Hoskins, Engleheart, Plimer and Cosway hold their own with the best of the kind; but this beautiful art, like that of the engraver, has been largely superseded by photography and the "processes" now in use.

It is unnecessary to refer to the many uses of portraiture, but one of its chiefest has been to transmit to posterity the form and features of those who have played a part, worthy or otherwise, in the past history of our race. Of its value to the

biographer and historian, Carlyle, in a letter written in 1854, says, "In all my poor historical investigations it is one of the most primary wants to procure a bodily likeness of the personage inquired after; a good *portrait*, if such exists; failing that, even an indifferent, if sincere one; in short, *any* representation, made by a faithful human creature, of that face and figure which *he* saw with his eyes and which I can never see with mine. Often I have found the portrait superior in real instruction to half-a-dozen written biographies, or rather, I have found the portrait was as a small lighted *candle*, by which the biographies could for the first time be *read*, and some human interpretation be made of them." (G. RE.)

PORT RICHMOND, a part of the borough of Richmond in the city of New York, U.S.A., on the N. shore of Staten Island and on the Kill van Kull Channel. Before 1898 it was a separate village of Richmond county, New York, containing 6290 inhabitants in 1890. It is served by the Staten Island Rapid Transit railway, and by a ferry to Bergen Point, New Jersey, and has steam and electric railway connexions with the municipal ferry at St George, which furnishes easy access to the business districts on Manhattan Island. Among its places of historic interest are the Dutch Reformed Church, which is the direct successor of the church established on Staten Island in 1664 or 1665 by Waldenses and Huguenots; and the Danner Hotel, built soon after the War of Independence on the site of a temporary fort that had been erected by British troops, and used as a private dwelling until 1820. In this house Aaron Burr spent the last years of his life, dying there on the 14th of September 1836. Among the industrial establishments are a shipyard, dry dock and manufactories of flour, lumber, lead paint and builders' supplies. On the first of January 1898, when the act creating Greater New York came into effect, the village became a part of the third ward of Richmond borough.

PORT ROYAL, a celebrated Cistercian abbey, occupied a low and marshy site in the thickly wooded valley of the Yvette, at what is now known as Les Hameaux near Marly, a few miles south-west of Paris. It was founded in 1204 by Mahaut de Garlande, wife of Mathieu de Montmorenci-Marli in 1204; the church was built in 1229 from the designs of Robert de Luzarches. During its early years the convent received a number of papal privileges; the most important of these, granted by Honorius III. in 1223, authorized it to offer a retreat to women anxious to withdraw from the world without binding themselves by perpetual vows. Little is known of its history during the three succeeding centuries, except that its discipline became relaxed; reform was only attempted when Angélique Arnauld (*q.v.*) was appointed coadjutor to the elderly and invalid abbess in 1598. Angélique's reforming energy soon brought her into contact with Jean Duvergier (*q.v.*) abbot of Saint Cyran, and chief apostle in France of the Jansenist revival, and the later history of her convent is indissolubly connected with this movement.

In 1626 constant visitations of ague drove the nuns to Paris; they settled at Port Royal de Paris, at the end of the Faubourg Saint Jacques. The deserted buildings of Port Royal des Champs were presently occupied by "hermits," laymen, mostly relatives of the abbess, who wished for a semi-monastic existence, though without taking formal vows. In 1648, however, some of the nuns returned to the country, and the hermits retreated to buildings at a short distance from the abbey. Here they set up a "little school" for the sons of Jansenist parents; and here Jean Racine, the future poet, received his education. But in 1653 Innocent X. condemned the doctrines of Jansen. Three years later "the hermitage" and school were broken up, and the nuns were forbidden to receive new members into their community. These rigours were much increased when Louis XIV. took up the reins of government in 1660; between 1664 and 1669 the archbishop of Paris laid under an interdict those of the nuns who refused to subscribe the papal censure on Jansen. In 1669, however, came the so-called "Peace of Clement IX.," when the Jansenists generally were admitted to grace, and the interdict was removed from Port Royal, though the authorities broke up the convent into two distinct communities. The conformist nuns were gathered together at Port Royal de Paris, under an independent abbess; their Jansenist sisters were united at the original building in the country. Thereupon followed ten years of peace, for the nuns had a powerful protector in the king's cousin, Mme de Longueville. But in

1679 she died, and Louis at once ordered the nuns to send away their novices and boarders and to receive no others. Finally, in 1705, he got from Clement XI. a new condemnation of the Jansenists, which the few remaining nuns, all of whom were over sixty, refused to sign; and on the 29th of October 1709 they were forcibly removed from Port Royal by the police, and distributed among various conformist convents. In the following spring the buildings were pulled down; even the cemetery was not spared. The land on which the convent had stood was made over to Mme de Maintenon's college of St Cyr; in 1825 it was bought by some descendants of Jansenist families, who have done their best to restore the grounds to their original appearance, and have built a museum rich in Jansenist relics. Port Royal de Paris was secularized at the French Revolution, and is now a maternity hospital.

For a classified list of the chief books, ancient and modern, dealing with Port Royal, see the *Abrégé de l'histoire de Port Royal*, by Jean Racine, ed. E. Gazier (Paris, 1908). See also C. A. Sainte-Beuve, *Port Royal* (6 vols. and index, Paris, 1882); Charles Beard, *Port Royal* (2 vols., London, 1861); H. Reuchlin, *Geschichte von Port Royal* (2 vols., Hamburg, 1839-1844), and the books recommended under the articles ARNAULD, JANSENISM and PASCAL.

PORT ROYAL, an island in Beaufort county, South Carolina, U.S.A., at the head of Port Royal Sound, about 16 m. from the Atlantic coast, and about 50 m. S.W. of Charleston. It is about 13 m. long (north and south) by about 7 m. wide. The surface is generally flat, and there is much marshland in its southern part, and along its north-eastern shore. The principal settlement is Beaufort, a port of entry, and the county-seat of Beaufort county, on the Beaufort river (here navigable for vessels drawing 18 ft.), about 11 m. from its mouth, and about 15 m. from the ocean. Pop. (1900) 4110 (3220 negroes); (1910) 2486. It is served by the Charleston & Western Carolina railway, has inland water communication with Savannah, Georgia, and its harbour, Port Royal Sound (between Bay Point on the north-east and Hilton Head on the south-west), is one of the largest and best on the coast of South Carolina. Beaufort's beautiful situation and delightful climate make it a winter resort. In the vicinity Sea Island cotton, rice, potatoes and other vegetables are raised—the truck industry having become very important; and there are groves of yellow pine and cypress. Large quantities of phosphate rock were formerly shipped from here. Among the manufactures are cotton goods, canned oysters, lumber and fertilizer. About 5 m. south of Beaufort is the town of Port Royal (pop. in 1910, 363), a terminus of the Charleston & Western Carolina railway. On the Beaufort River (eastern) shore of Paris Island, about 6 m. north of Bay Point, is a United States naval station, with a dry dock and repair shop.

Jean Ribaut (1520-1565), leading an expedition sent out by Admiral Gaspard de Coligny (1517-1572) to found a Huguenot colony in New France, sailed into the harbour, which he named Port Royal, on the 27th of May 1562, took possession of the region in the name of Charles IX., and established the first settlement (Fort Charles), probably on Paris Island. In June he sailed for France, leaving 26 volunteers under Captain Albert de la Pierria. Soon afterward the garrison killed Pierria (probably because of the severity of his discipline), and put to sea in an insufficiently equipped vessel, from which, after much suffering, they were rescued by an English ship, and taken to England. In 1670, a company under Colonel William Sayle (d. 1671) landed on Port Royal Island, but probably because this site exposed them to Spanish attacks, proceeded along the coast and founded the original Charles Town (see CHARLESTON). In 1683, several families, chiefly Scotch, led by Henry Erskine, third Lord Cardross (1650-1693), established on the island a settlement named Stuart's Town (probably in honour of Cardross's family); but three years later most of the settlers were murdered by Spaniards from Florida and the remainder fled to Charleston. In 1710, after the lords proprietors had issued directions for "the building of a town to be called Beaufort Town," in honour of Henry Somerset, duke of Beaufort (1629-1700), the first permanent settlement was established on the island. The town was incorporated in 1803. In January 1779 about 200 British soldiers occupied the island by order of Colonel Augustine Prevost, but they were dislodged (Feb. 3) by about 300

Americans, mostly militiamen, under General William Moultrie. At the beginning of the Civil War the Confederates erected Fort Walker on Hilton Head, and Fort Beauregard on Bay Point. Captain (afterwards Admiral) Samuel F. Du Pont and General Thomas W. Sherman organized an expedition against these fortifications, which were reduced by a naval bombardment and were evacuated by the Confederates under General Thomas F. Drayton (d. 1891) on the 7th of November 1861. During the remainder of the war Port Royal Harbour was used as a coaling, repair and supply station by the Federal blockading squadron. Early in 1862 Port Royal Island and the neighbouring region became the scene of the so-called "Port Royal Experiment"—the successful effort of a group of northern people, chiefly from Boston, New York and Philadelphia, among whom Edward S. Philbrick (d. 1889) of Massachusetts was conspicuous, to take charge of the cotton plantations, deserted upon the occupation of the island by Union troops, and to employ the negroes under a system of paid labour. The volunteers organized as the Educational Commission for Freedmen (afterward the New England Freedmen's Aid Society), and the government granted them transportation, subsistence and quarters, and paid them small salaries.

See Edward McCrady's *History of South Carolina* (New York, 1897-1901); and, for an account of the Port Royal Experiment, *Letters from Port Royal* (Boston, 1906), edited by Elizabeth W. Pearson.

PORTRUSH, a seaport and the most popular seaside resort of Co. Antrim, Ireland; the terminus of a branch of the Northern Counties (Midland) railway. Pop. (1901), 1941. It is very picturesquely situated on the basaltic peninsula of Ramore Head, with a deep bay on either side, and a harbour protected by the natural breakwater known as the Skerries. A fine hotel, owned by the railway company, and an excellent golf course are the chief features, together with a town-hall with public reading room, and the place is much frequented for golf and sea-bathing. It is also the centre for visitors to the Giants' Causeway, with which it is connected by an electric railway. Dunluce Castle, between Portrush and Bushmills, stands on a rock separated from the mainland by a chasm which is spanned by a bridge. The ruins, which are extensive, are of unknown date. Portrush has a thriving trade in salmon. It is governed by an urban district council.

PORT SAID, a seaport of Egypt, at the northern entrance of the Suez Canal, in 31° 15' 35" N., 32° 19' 20" E., and 145 m. by rail N.E. of Cairo. Pop. (1907), 49,884. It lies on the western side of the canal on the low, narrow, treeless and desolate strip of land which separates the Mediterranean from Lake Menzala, the land at this point being raised and its area increased by the draining of part of the lake and by the excavation of the inner harbour. The outer harbour is formed by two breakwaters which protect the entrance to the canal; altogether the harbour covers about 570 acres and accommodates ships drawing 28 ft. Originally besides the central basin of the inner harbour there were three docks; between 1903 and 1909 the harbour accommodation was doubled by the construction of new docks on the eastern side of the canal and by enlarging the western docks. The port possesses a floating dock 295 ft. long, 85 ft. broad and 18 ft. deep, capable of lifting 3500 tons, and a patent slip taking 300 tons and ships drawing 9 ft. 9 in. of water. On the western breakwater is a colossal statue of Ferdinand de Lesseps by E. Fremiet, unveiled in 1899, and a lighthouse 174 ft. high. Among the few buildings of note in the town are the offices of the Suez Canal Company and the British barracks, the last named having been built by Prince Henry of the Netherlands (d. 1879) as a *dépôt* for Dutch trade.

Port Said dates from 1859 and its situation was determined by the desire of the engineers of the Suez Canal to start the canal at the point on the Mediterranean coast of the isthmus of Suez nearest to deep water, and off the spot where Port Said now stands there was found a depth of 26 ft. at about 2 m. from the shore. For many years after its foundation it depended entirely upon the traffic of the canal, being the chief coaling station of all ships passing through and becoming the largest coaling station in the

world. The population was of a very heterogeneous character, but mainly of an undesirable class of Levantines; this with the damp heat and the dirt and noise of the incessant coaling operations gave the town an unenviable reputation. In 1902, however, a new industry was added in the export of cotton from the eastern provinces of the Delta, the cotton being brought from Mataria by boat across Lake Menzala. In 1904 the opening of a standard gauge railway to Cairo placed Port Said in a position to compete with Alexandria for the external trade of Egypt generally, besides making it a tourist route to the capital from Europe. The result was to attract to the town a considerable commercial community and to raise its social status. A new suburb was created by reclaiming land on the north foreshore, and another suburb was created on the eastern side of the canal. The average annual value of the trade of the port for the five years 1902-1906 was £2,410,000. This figure includes the value of the coal used by vessels passing through the Suez Canal.

PORTSMOUTH, EARLS OF. In 1743 John Wallop (1690-1762) of Farley Wallop in Hampshire was created earl of Portsmouth. He belonged to an old Hampshire family and had been a lord of the treasury from 1717 to 1720, when he was created Baron Wallop. The earldom has since been held by his descendants, one of whom, Newton Wallop (b. 1856), became the 6th earl in 1891. This earl was a member of parliament from 1880 to 1891 and was under secretary of state for war from 1905 to 1908.

PORTSMOUTH, LOUISE DE KÉROUALLE, DUCHESS OF (1649-1734), mistress of the English king Charles II., was the daughter of Guillaume de Penancourt and his wife Marie de Plæuc de Timeur. The name of Kéroualle was derived from an heiress whom her ancestor François de Penhoët had married in 1330. The family were nobles in Brittany, and their name was so spelt by themselves. But the form Querouailles was commonly used in England, where it was corrupted into Carwell or Carewell, perhaps with an ironic reference to the care which the duchess took to fill her pocket. In France it was variously spelt Queroul, Kéroual and Kéroël. The exact date of her birth is apparently unknown. Louise was placed early in life in the household of Henriette, duchess of Orleans, sister of Charles II. Saint-Simon asserts that her family threw her in the way of Louis XIV. in the hope that she would be promoted to the place of royal mistress. In 1670 she accompanied the duchess of Orleans on a visit to Charles II. at Dover. The sudden death of the duchess, attributed on dubious evidence to poison, left her unprovided for, but the king placed her among the ladies in waiting of his own queen. It was said in after times that she had been selected by the French court to fascinate the king of England, but for this there seems to be no evidence. Yet when there appeared a prospect that the king would show her favour, the intrigue was vigorously pushed by the French ambassador, Colbert de Croissy, aided by the secretary of state, Lord Arlington, and his wife. Louise, who concealed great cleverness and a strong will under an appearance of languor and a rather childish beauty (Evelyn the diarist speaks of her "baby face"), yielded only when she had already established a strong hold on the king's affections and character. Her son, ancestor of the dukes of Richmond, was born in 1672.

The support she received from the French envoy was given on the understanding that she should serve the interests of her native sovereign. The bargain was confirmed by gifts and honours from Louis XIV. and was loyally carried out by Louise. The hatred openly avowed for her in England was due as much to her own activity in the interest of France as to her notorious rapacity. The titles of Baroness Petersfield, countess of Fareham and duchess of Portsmouth were granted her for life on the 10th of August 1673. Her pensions and money allowances of various kinds were enormous. In 1677 alone she received £27,300. The French court gave her frequent presents, and in December 1673 conferred upon her the ducal fief of Aubigny at the request of Charles II. Her thorough understanding of the king's character enabled her to retain her hold on him to the end. She contrived to escape uninjured during the crisis of the Popish Plot in 1678. She was strong enough to maintain her position during a long illness in 1677, and a visit to France in 1682. In February 1685 she took measures to see that the king, who was secretly a Roman Catholic, did not die without confession and absolution. Soon after the king's death she retired to France, where, except for one short visit to England during the reign of James II., she remained. Her pensions and an outrageous grant on the Irish revenue given her by

Charles II. were lost either in the reign of James II. or at the Revolution of 1688. During her last years she lived at Aubigny, and was harassed by debt. The French king, Louis XIV., and after his death the regent Orleans, gave her a pension, and protected her against her creditors. She died at Paris on the 14th of November 1734.

See H. Forneron, *Louise de Kéroualle* (Paris, 1886); and Mrs Colquhoun Grant, *From Brittany to Whitehall* (London, 1909).

PORTSMOUTH, a municipal, county and parliamentary borough, and seaport of Hampshire, England, 74 m. S.W. from London, on the London & South-Western and the London, Brighton & South Coast railways. Pop. (1891), 159,278; (1901), 188,133. This great naval station and arsenal is an

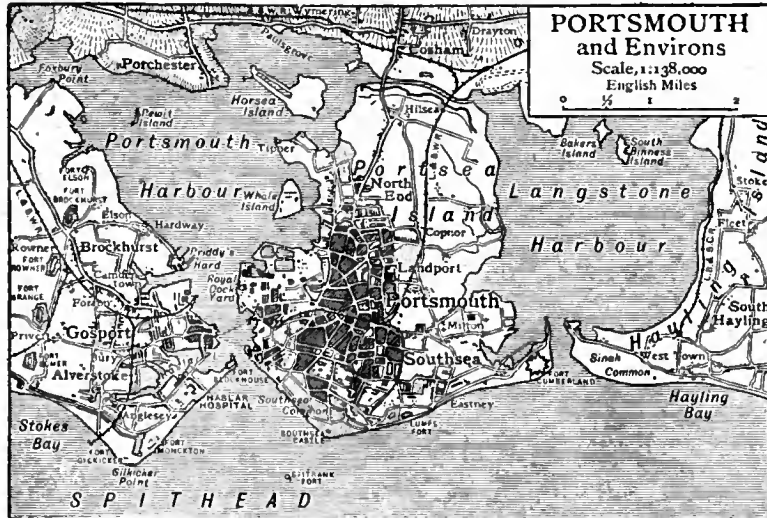

aggregate of four towns, Portsmouth, Portsea, Landport and Southsea, and occupies the south-western part of Portsea Island, which lies between Portsmouth Harbour and Langstone Harbour, two inlets of the English Channel. Portsmouth Harbour opens into Spithead, one of the arms of the Channel separating the Isle of Wight from the mainland. The harbour widens inwards in bottle form, Portsmouth lying on the east shore of the neck, with Gosport opposite to it on the west side. Portsmouth proper may be distinguished as the garrison town; Portsea as the naval station with the dockyards; Landport is occupied chiefly by the houses of artisans; and Southsea is a residential quarter and a favourite watering-place. Besides a number of handsome modern churches, among which is a Roman Catholic cathedral, Portsmouth possesses, in the church of St Thomas à Becket, a fine cruciform building dating from the second half of the 12th century, in which the chancel and transepts are original, but the nave and tower date from 1608, and the whole was extensively restored in 1904. The garrison chapel originally belonged to the hospital of St Nicholas, a foundation of the 13th century. Among other buildings worthy of mention (apart from those having naval or military connexion) the principal is the town-hall (1890), a fine classic building standing alone in a square, and surmounted by a handsome clock tower. Among educational institutions there are a large grammar school (1879), on a foundation of 1732, Roman Catholic schools adjoining the cathedral, schools for engineering students and dockyard apprentices, and seamen and marines' orphan school. Aria College in Portsea was opened in 1874 for the training of Jewish ministers. Victoria Park, in the heart of the town, contains a monument to Admiral Napier. There are recreation grounds for the naval and military forces in the vicinity. There is a railway station (Portsmouth Harbour) on the Hard, from which passenger steamers serve Ryde in the Isle of Wight. A ferry and a floating bridge connect with Gosport. The port has a considerable trade in coal, timber, fruits and agricultural produce. The parliamentary borough returns two members. The county borough was created in 1888. The municipal borough is under a mayor, 14 aldermen and 42 councillors. Area, 5010 acres.

The dockyard seems to have been regularly established about 1540, but long before that date the town was of importance as a naval station and was used for the accommodation of the king's ships. In 1540 it covered 8 acres of ground, abutting on the harbour near the "King's Stairs." Cromwell added 2 acres in 1658, and Charles II. added 8 in 1663 and 10 more in 1667. By 1710 30 acres more had been reclaimed or bought, and by the end of the 18th century the total area was 90 acres. In 1848 a steam basin, covering 7 acres, and four new docks were opened, the dockyard ground being extended to 115 acres in all. In 1865 large extension works were decided upon, increasing the area to 293 acres. These included a tidal basin and, opening out of it, a deep dock and two locks, in themselves serving as large docks, which lead to three basins and four docks. An entrance was also formed between the new tidal basin and the steam basin of 1848, and large additions were made to the wharfrage accommodation as well as to the storehouses and factories. Subsequent improvements included the formation of two new dry docks (1896) with a floor-length of 557 ft. and a depth of 33½ ft. over the sill at high water of spring tides; the construction of new jetties at the entrance to the tidal basin and at the north wall; the establishment of a coal wharf with hydraulic appliances; a torpedo range in the harbour; the erection of various buildings such as torpedo and gun-mounting stores, electrical shops and numerous subsidiary works; and extensive dredging of the harbour to increase the berthing accommodation for the fleet. Altogether the dockyard comprises 15 dry docks, 60 acres of enclosed basins, 18,400 ft. of wharfrage and about 10 m. of railway. There is a gunnery establishment in the harbour on Whale Island, the area of which has been increased to nearly 90 acres by the accretion of material excavated from the dockyard extension works, and various barracks including those of the royal marine artillery at Eastney, beyond Southsea.

Portsmouth (*Portsmue*, *Portesmuþ*) owes its origin to the retreat of the sea from Porchester, and its importance to its favourable position for a naval station. Though probably the site had long been recognized as a convenient landing-place, no town existed there until the 12th century, when the strategical advantage it offered induced Richard I. to build one. He granted a charter in 1194 declaring that he retained the borough in his hand, and granting a yearly fair and weekly market, freedom from certain tolls, from shire and hundred court and sheriffs' aids. In October 1200 King John repeated the grants, and Henry III. in 1229 gave the "men of Portsmouth" the town in fee farm and granted a merchant gild. Confirmations were made by successive kings, and a charter of incorporation was given by Elizabeth in 1599-1600. A new and enlarged charter was granted by Charles I. in 1627, by which the borough is now governed subject to changes by the municipal acts of the 19th century. Portsmouth has returned two members to parliament since 1295. A fair on the 1st of August and fourteen following days was granted by Richard I. The first day was afterwards changed to the 29th of June and later to the 11th of July. It was important as a trading fair for cutlery, earthenware, cloth and Dutch metal, and was abolished in 1846. The market, dating from 1194 and originally held on Thursday only, is now held on Tuesday and Saturday in addition. Portsmouth was important in the middle ages not only as a naval station but a trading centre. There was a considerable trade in wool and wine, and the building of the dockyards by Henry VII. further increased its prosperity.

See *Victoria County History: Hampshire*, iii. 172 seq.; R. East, *Extracts from the Portsmouth Records*.

PORTSMOUTH, a city, port of entry and one of the county-seats of Rockingham county, New Hampshire, U.S.A., on the Piscataqua river, about 3 m. from the Atlantic Ocean, about 45 m. E.S.E. of Concord, and about 54 m. N.N.E. of Boston. Pop. (1910 U.S. census) 11,269. Area, 17 sq. m. Portsmouth is served by the Boston & Maine railway, by electric lines to neighbouring towns, and in summer by a steamboat daily to the Isles of Shoals. The city is pleasantly situated, mainly on a peninsula, and has three public parks. Portsmouth attracts many visitors during the summer season. In Portsmouth are an Athenaeum (1817), with a valuable library; a public library (1881); a city hall; a county court house; a United States customs-house; a soldiers' and sailors' monument; an equestrian

monument by James Edward Kelly to General Fitz John Porter; a cottage hospital (1886); a United States naval hospital (1891); a home for aged and indigent women (1877); and the Chase home for children (1877).

A United States navy yard, officially known as the Portsmouth Navy Yard, is on an island of the Piscataqua but within the township of Kittery, Maine. In 1800 Fernald's Island was purchased by the Federal government for a navy yard; it was the scene of considerable activity during the War of 1812, but was of much greater importance during the Civil War, when the famous "Kearsarge" and several other war vessels were built here.¹ In 1866 the yard was enlarged by connecting Seavey's Island with Fernald's; late in the 19th century it was equipped for building and repairing steel vessels. It now has a large stone dry dock. On Seavey's Island Admiral Cervera and other Spanish officers and sailors captured during the Spanish-American War were held prisoners in July—September 1898. Subsequently a large naval prison was erected. In 1905 the treaty ending the war between Japan and Russia was negotiated in what is known as the Peace Building in this yard.

In 1905 the city's factory products were valued at \$2,602,056. During the summer season there is an important trade with the neighbouring watering-places; there is also a large transit trade in imported coal, but the foreign commerce, consisting wholly of imports, is small.

Portsmouth and Dover are the oldest permanent settlements in the state. David Thomson with a small company from Plymouth, England, in the spring or early summer of 1623 built and fortified a house at Little Harbor (now Odiorne's Point in the township of Rye) as a fishing and trading station. In 1630 there arrived another band of settlers sent over by the Laconia Company. They occupied Thomson's house and Great Island (New Castle) and built the "Great House" on what is now Water Street, Portsmouth. This settlement, with jurisdiction over all the territory now included in Portsmouth, New Castle and Greenland, and most of that in Rye, was known as "Strawberry Banke" until 1653, when it was incorporated (by the government of Massachusetts) under the name of Portsmouth. There was from the first much trouble between its Anglican settlers sent over by Mason and the Puritans from Massachusetts, and in 1641 Massachusetts extended her jurisdiction over this region. In 1679, however, New Hampshire was constituted a separate province, and Portsmouth was the capital until 1775. In 1693 New Castle (pop. 1900, 581), then including the greater part of the present township of Rye, was set apart from Portsmouth, and in 1703 Greenland (pop. 1900, 607) was likewise set apart. One of the first military exploits of the War of Independence occurred at New Castle, where there was then a fort called William and Mary. In December 1774 a copy of the order prohibiting the exportation of military stores to America was brought from Boston to Portsmouth by Paul Revere, whereupon the Portsmouth Committee of Safety organized militia companies, and captured the fort (Dec. 14). In 1849 Portsmouth was chartered as a city.

Portsmouth was the birthplace of Governor Benning Wentworth (1696-1770) and his nephew Governor John Wentworth (1737-1820); of Governor John Langdon (1739-1819); of Tobias Lear (1762-1816), the private secretary of General Washington from 1785 until Washington's death, consul-general at Santo Domingo in 1802-1804, and negotiator of a treaty with Tripoli in 1805; of Benjamin Penhallow Shillaber (1814-1890), humorist, who is best known by his *Life and Sayings of Mrs Partington* (1854); of James T. Fields, of Thomas Bailey Aldrich and of General Fitz John Porter. From 1807 to 1816 Portsmouth was the home of Daniel Webster.

PORTSMOUTH, a city and the county-seat of Scioto county, Ohio, U.S.A., picturesquely situated at the confluence of the Scioto and Ohio rivers, 95 m. S. of Columbus. Pop. (1910 U.S. census) 23,481. Portsmouth is served by the Baltimore &

¹ See Captain G. H. Preble, "Vessels of War built at Portsmouth, N. H. 1690-1868," in *New England Historical and Genealogical Register*, vol. xxii. (Boston, 1868); and W. E. Fentress, *Centennial History of the U.S. Navy Yard at Portsmouth, N. H.* (Portsmouth, 1876).

Ohio South-Western, the Chesapeake & Ohio and the Norfolk & Western railways, also by passenger and freight boats to Pittsburg, Cincinnati and intermediate ports. The city has a Carnegie library, a municipal hospital, an aged women's home and a children's home. Extending along the Ohio for 8 m. and arranged in three groups are works of the "Mound Builders." There are two small city parks, and a privately owned resort, Millbrook Park. The surrounding country is a fine farming region, which also abounds in coal, fire-clay and building stone. Natural gas is used for light, heat and power. In 1905 the city's factory products were valued at \$7,970,674, of which \$4,258,855 was the value of boots and shoes. The Norfolk & Western has division terminals here.

The first permanent settlement in the immediate vicinity was made in 1796. In 1799 Thomas Parker, of Alexandria, Virginia, laid out a village (which was named Alexandria) below the mouth of the Scioto, but as the ground was frequently flooded the village did not thrive, and about 1810 the inhabitants removed to Portsmouth. Portsmouth was laid out in 1803, incorporated as a town in 1815, and chartered as a city in 1851. The Ohio and Erie canal was opened from Cleveland to Portsmouth in 1832.

PORTSMOUTH, a city of Norfolk county, Virginia, U.S.A., on the Elizabeth river opposite Norfolk. Pop. (1910, census), 33,190. Portsmouth is served by the Atlantic Coast Line, the Seaboard Air Line, the Chesapeake & Ohio and the New York, Philadelphia & Norfolk (Pennsylvania system), the Southern, and the Norfolk & Western railways, by steamboat lines to Washington, Baltimore, New York, Providence and Boston, by ferries to Norfolk, and by electric lines to numerous suburbs. There is a 30-ft. channel to the ocean. Portsmouth is situated on level ground only a few feet above the sea; it has about 2½ m. of water-front, and adjoins one of the richest trucking districts in the Southern States. Among the principal buildings are the county court house, city hall, commercial building, United States naval hospital, post office building, high school and the Portsmouth orphan asylum, King's Daughters' hospital and the old Trinity Church (1762). In the southern part of the city is a United States navy yard and station, officially the Norfolk Yard (the second largest in the country), of about 450 acres, with three immense dry docks, machine shops, warehouses, travelling and water cranes, a training station, torpedo-boat headquarters, a powder plant (20 acres), a naval magazine, a naval hospital and the distribution headquarters of the United States Marine Corps. The total value of the city's factory products in 1905 was only \$145,430. The city is a centre of the Virginia oyster "fisheries." Portsmouth and Norfolk form a customs district, Norfolk being the port of entry, whose exports in 1908 were valued at \$11,326,817, and imports at \$1,150,044.

Portsmouth was established by act of the Virginia assembly in 1752, incorporated as a town in 1852 and chartered as a city in 1858. Though situated in Norfolk county, the city has been since its incorporation administratively independent of it. Shortly before the War of Independence the British established a marine yard where the navy yard now is, but during the war it was confiscated by Virginia and in 1801 was sold to the United States. In April 1861 it was burned and abandoned by the Federals, and for a year afterwards was the chief navy yard of the Confederates. Here was constructed the iron-clad "Virginia" (the old "Merrimac"), which on the 9th of March 1862 fought in Hampton Roads (*q.v.*) the famous engagement with the "Monitor." Two months later, on the 9th of May, the Confederates abandoned the navy yard and evacuated Norfolk and Portsmouth, and the "Virginia" was destroyed by her commander, Josiah Tattnall.

PORT SUDAN, a town and harbour on the west coast of the Red Sea, in 19° 37' N. 37° 12' E., 700 m. by boat S. of Suez and 495 m. by rail N.E. of Khartum. Pop. (1906), 4280. It is the principal port of the Anglo-Egyptian Sudan and the headquarters of the customs administration. The coral reefs fringing the coast are here broken by a straight channel with deep water giving access to the harbour, which consists of a series of natural

channels and basins. The largest basin is 900 yds. long by 500 broad and has a minimum depth of 6 fathoms. On the north side of the inlet are quays (completed 1909), fitted with electric cranes, &c. Here are the customs-house, coal sheds and goods station. The town proper lies on the south side of the inlet, connected with the quays by a railway bridge. Besides government offices the public buildings include hospitals, and a branch of the Gordon College of Khartum. Beyond the bridge in the upper waters of the inlet is a dry dock. The climate of Port Sudan is very hot and damp and fever is common. Adjacent to the town is an arid plain without vegetation other than mimosa thorns. Some 10 m. west is a line of hills parallel to the coast.

The port dates from 1905. It owes its existence to the desire of the Sudan administration to find a harbour more suitable than Suakin (*q.v.*) for the commerce of the country. Such a place was found in Mersa Sheikh Barghut (or Barud), 36 m. north of Suakin, a harbour so named from a saint whose tomb is prominent on the northern point of the entrance. When the building of the railway between the Nile and the Red Sea was begun, it was determined to create a port at this harbour—which was renamed Port Sudan (Bander es-Sudan). Up to the end of 1909 the total expenditure by the government alone on the town and harbour-works was £914,320. The railway (which has termini both at Port Sudan and Suakin) was opened in January 1906 and the customs-house in the May following. Port Sudan immediately attracted a large trade, the value of goods passing through it in 1906 exceeding £470,000. In 1908 the imports and exports were valued at about £750,000. It is a regular port of call of British, German and Italian steamers. The imports are largely cotton goods, provisions, timber and cement; the exports gum, raw cotton, ivory, sesame, durra, senna, coffee (from Abyssinia), goat skins, &c. Forty miles north of Port Sudan is Mahommed Gul, the port for the mines of Gebet, worked by an English company.

The Foreign Office Report, *Trade of Port Sudan for the Year 1906*, by T. B. Hohler, gives a valuable account of the beginnings of the port. A chart of the harbour was issued by the British Admiralty in 1908. See also SUDAN: § *Anglo-Egyptian*.

PORT TOWNSEND, a city, port of entry and the county-seat of Jefferson county, Washington, U.S.A., on Quimper Peninsula, at the entrance to Puget Sound, about 40 m. N.N.W. of Seattle. Pop. (1905), 5300; (1910), 4181. The city is served by the Port Townsend Southern railway (controlled by the Northern Pacific, but operated independently) and by steamship lines to Victoria (British Columbia), San Francisco, Alaska and Oriental ports. The harbour is $7\frac{1}{2}$ m. long and $3\frac{1}{2}$ m. wide, and is deep, well sheltered and protected by three forts, of which Fort Worden is an excellently equipped modern fortification ranking with the forts at Portland (Maine), San Francisco, Boston and New York. The United States government has at Port Townsend a customs-house, a revenue cutter service, a marine hospital, a quarantine station and an immigration bureau. Port Townsend is the port of entry for the Puget Sound customs district. In 1908 its exports were valued at \$37,547,553, much more than those of any other American port of entry on the Pacific; its imports were valued in 1908 at \$21,876,361, being exceeded among the Pacific ports by those of San Francisco only. The city has a considerable trade in grain, lumber, fish, livestock, dairy products and oil; its manufactures include boilers, machinery and canned and pickled fish, especially salmon and herring. Port Townsend was settled in 1854, incorporated as a town in 1860 and chartered as a city in 1890.

PORTUGAL, a republic of western Europe, forming part of the Iberian Peninsula, and bounded on the N. and E. by Spain, and on the S. and W. by the Atlantic Ocean. Pop. (1900), 5,016,267; area, 34,254 sq. m. These totals do not include the inhabitants and area of the Azores and Madeira Islands, which are officially regarded as parts of continental Portugal. In shape the country resembles a roughly drawn parallelogram, with its greatest length (362 m.) from N. to S., and its greatest breadth (140 m.) from E. to W. For map, see SPAIN. The

land frontiers are to some extent defined by the course of the four principal rivers, the Minho and Douro in the north, the Tagus and Guadiana in the south; elsewhere, and especially in the north, they are marked by mountain ranges; but in most parts their delimitation is originally based on political considerations. In no sense can the boundary-line be called either natural or scientific, apart from the fact that the adjacent districts on either side are poor, sparsely peopled, and therefore little liable to become a subject of dispute. The Portuguese seaboard is nearly 500 m. long, and of the six ancient provinces all are maritime except Traz-os-Montes. From the extreme north to Cape Mondego and thence onward to Cape Carvoeiro the outline of the coast is a long and gradual curve; farther south is the prominent mass of rock and mountain terminating westward in Capes Roca and Espichel; south of this, again, there is another wide curve, broken by the headland of Sines, and extending to Cape St Vincent, the south-eastern extremity of the country. The only other conspicuous promontory is Cape Santa Maria, on the south coast. The only deep indentations of the Portuguese littoral are the lagoon of Aveiro (*q.v.*) and the estuaries of the Minho, Douro, Mondego, Tagus, Sado and Guadiana, in which are the principal harbours. The only islands off the coast are the dangerous Farilhões and Berlings (Portuguese *Berlengas*) off Cape Carvoeiro.

Physical Features.—Few small countries contain so great a variety of scenery as Portugal. The bleak and desolate heights of the Serra da Estrella and the ranges of the northern frontier are almost alpine in character, although they nowhere reach the limit of perpetual snow. At a lower level there are wide tracts of moorland, covered in many cases with sweet-scented plants and other wild flowers. The lagoon of Aveiro, the estuary of the Sado and the broad inland lake formed by the Tagus above Lisbon (*q.v.*), recall the waterways of Holland. The sand-dunes of the western coast and the Pinal de Leiria (*q.v.*) resemble the French Landes. The Algarve and parts of Alemtejo might belong to North-West Africa rather than to Europe. The Paiz do Vinho, on the Douro, and the Tagus near Abrantes, with their terraced bush-vines grown up the steep banks of the rivers, are often compared with the Rhine and the Elbe. The harbours of Lisbon and Oporto are hardly inferior in beauty to those of Naples and Constantinople. Apart from this variety, and from the historic interest of such places as Braga, Bussaco, Cintra, Coimbra, or Torres Vedras, the attractiveness of the country is due to its colouring, and not to grandeur of form. Its landscapes are on a small scale; it has no vast plains, no inland seas, no mountain as high as 7000 ft. But its flora is the richest in Europe, and combines with the brilliant sunshine, the vivid but harmonious costumes of the peasantry, and the white or pale-tinted houses to compensate for any such deficiency. This wealth of colour gives to the scenery of Portugal a quite distinctive character and is the one feature common to all its varieties.

The orography of Portugal cannot be scientifically studied except in relation to that of Spain, for there is no dividing line between the principal Portuguese ranges and the highlands of Galicia, Leon and Spanish Estremadura. Three so-called Portuguese systems are sometimes distinguished: (1) the Transmontane, stretching between the Douro and the Minho; (2) the Beirene, between the Douro and the Tagus; (3) the Transtagine, south of the Tagus. The following ranges belong to the Transmontane system, which is the southern extension of the mountains of Galicia: Peneda (4728 ft.), forming the watershed between the river Lima and the lower Minho; the Serra do Gerez (4817 ft.), which rises like a gigantic wall between the Lima and the Homem, and sends off a spur known as the Amarella, Oural and Nora, south-westward between the Homem and the Cavado; La Raya Seca, a continuation of Gerez, which culminates in Larouco (4390 ft.) and contains the sources of the Cavado; Cobreira (4196 ft.), which contains the sources of the river Ave and separates the basin of the Tamega from that of the Cavado; Marão (4642 ft.), Villarelho (3547 ft.) and Padrela (3763 ft.), forming together a large *massif* between the rivers Tamega, Tua and Douro; and Nogueira (4331 ft.) and Bornes (3944 ft.), which divide the valley of the Tua from that of the Sabor. The Beirene system comprises two quite distinct mountain regions. North of the Mondego it includes Montemuro (4534 ft.), separating the Douro from the upper waters of its left-hand tributary the Paiva; Gralheira (3681 ft.) between the Paiva and the Vouga; the Serra do Caramullo

(3511 ft.), between the Vouga and the Dão; and the Serra da Lapa (3215 ft.), which gives rise to the Paiva, Tavora, Vouga and Dão. South of these ranges, but nominally included in the same system, is the Serra da Estrella, the loftiest ridge in Portugal (6532 ft.). The Estrella Mountains, which enclose the headwaters of the Mondego in a deep ravine, stretch from north-east to south-west and are continued in the same direction by the Serra de Lousã (3944 ft.). They form the last link in the chain of mountain ranges, known to Spanish geographers as the Carpetano-Vetonica, which extends across the centre of the Peninsula from east to west. The greater part of the Serra da Estrella constitutes the watershed between the Mondego and Zezere. Lesser ranges, which are included in the Beirene system and vary in height from 2000 to 4000 ft., are the Mesas, between the rivers Cõa and Zezere; the Guardunha and Moradal, separating the Zezere from the Ponsul and Ocreza, tributaries of the Tagus; the Serra do Aire, and various ridges which stretch south-westward as far as the mountains of Cintra (*q.v.*). The Transiagic Mountains cannot rightly be described as a single system, as they consist for the most part of isolated ranges or *massifs*. The Serra da Arrabida (1637 ft.) rises between Cape Espichel and Setubal. São Mamede (3363 ft.), with the parallel and lower Serra de Portalegre, extends along part of the frontier of northern Alemtejo. Ossa (2129 ft.), Caixeiro (1483 ft.), Monfurado (1378 ft.) and Mendro (1332 ft.) form the high ground between the rivers Sado, Sorraia and Guadiana. East of the Guadiana the outliers of the Spanish Sierra Morena enter Portuguese territory. The Serra Grandola and Monte Cereal, two low ranges stretching from north to south, skirt the coast of southern Estremadura. In the extreme south the ranges are more closely massed together. They include Monchique, with the peak of Foya or Foia (2963 ft.), and various lower ranges. There are numerous large expanses of level country, the most notable of these being the plains (*campos*) of the Tagus valley, and of Aviz or Benavilla, Beja and Ourique, in Alemtejo; the high plateaux (*cimas*) of Mogadouro in Traz-os-Montes and Ourem between the Tagus and the upper Sorraia; the highly cultivated lowlands (*veigas*) of Chaves and Valença do Minho in the extreme north; and the marshy flats (*baixas*) along the coast of Alemtejo and the southern shore of the lower Tagus.

The three principal rivers which flow through Portugal to the sea—the Douro, Tagus and Guadiana—are described in separate articles. The chief Portuguese tributaries of the Douro are the Tamega, Tua and Sabor on the north, the Agueda, Cõa and Paiva on the south; of the Tagus, the Ocreza, Ponsul and Zezere on the north, the Niza and Sorraia on the south, while into the Guadiana, on its right or Portuguese bank, flow the Caia, Degebe, Cobres, Oeiras and Vascão. The whole country drains into the Atlantic, to which all the main rivers flow in a westerly direction except the Guadiana, which turns south by east in the lower part of its course. The Minho (Spanish *Miño*) is the most northerly river of Portugal, and in size and importance is only inferior to the three great waterways already mentioned. It rises in the highlands of Galicia, and, after forming for some distance the boundary between that province and Entre-Minho-e-Douro, falls into the sea below the port of Caminha. Its length is 170 m. Small coasters can ascend the river as far as Salvatierra in Galicia (20 m.), but larger vessels are excluded by a sandy bar at the mouth. Between the Minho and Douro the chief rivers are the Lima (Spanish *Limia* or *Antela*), which also rises in Galicia, and reaches the sea at Vianna do Castelo; the Cavado, which receives the Homicem on the right, and forms the port of Espozende in its estuary; and the Ave, which rises in the Serra da Cabreira and issues at the port of Villa do Conde. Between the Douro and Tagus the Vouga rises in the Serra da Lapa and reaches the sea through the lagoon of Aveiro; the Mondego flows north-east through a long ravine in the Serra da Estrella, and then bends back so as to flow west-south-west. Its estuary contains the important harbour of Figueira da Foz; its chief tributaries are the Dão on the right, and the Alva, Ceira and Arunca on the left; its length is 125 m. of which 52 m. are navigable by small coasters. Several comparatively unimportant streams, chief among which are the Liz and Sizandro, enter the Atlantic between the mouths of the Mondego and Tagus. Between the Tagus and Cape St Vincent the principal rivers are the Sado, which is formed by the junction of several lesser streams and flows north-west to the port of Setubal; and the Mira, which takes a similar direction from its headwaters south of Monte Vigia to the port of Villa Nova de Milfontes. On the south coast the united waters of the Odelouca and Silves form the harbour of Villa Nova de Portimão, and the Algoz, Algibre or Quarteira, and the Asseca flow into the sea farther east. Portugal abounds in hot and medicinal springs, such as those of Caldas de Monchique, Caldas da Rainha and Vidago.

Geology.—By far the greater part of Portugal is occupied by ancient rocks of Archean and Palaeozoic age, and by eruptive masses which probably belong to various periods. All the higher mountains are formed of these rocks, and it is only near the coast and in the plain of the Tagus that later deposits are found. The Mesozoic beds form an irregular triangle extending from Lisbon and Torres Novas on the south to Oporto on the north. There are also a narrow strip along the southern shores of the Algarve and a

few smaller patches along the western coast. The Tertiary deposits cover the plain of the Tagus and are found in other low-lying areas near the coast. Of the Lower Palaeozoic rocks the Ordovician appears to be the most widely-spread. Large areas have been ascribed to the Cambrian, but it is only at Villa Boim, about 6 m. W.S.W. of Elvas, that Cambrian fossils have been found. The Ordovician beds have yielded fossils in several places, Vallongo and Bussaco being amongst the best-known localities. The succession is similar to that of Brittany and Spain. Supposed Silurian beds have been described at Portalegre, and in the same neighbourhood Devonian fossils have been found. The Lower Carboniferous, which belongs to the "Culm" facies so widely spread in central Europe, occupies a wide area in southern Portugal; but the Upper Carboniferous is very restricted in extent, and occurs in small basins like those of the Central Plateau of France, resting unconformably upon the rocks below. The deposits in these basins consist largely of coarse sandstones and conglomerates, amongst which lie seams of coal. It is possible that some of these deposits may belong to the Permian or at least to the Permo-Carboniferous. Of the Mesozoic systems the Jurassic is the most widely-spread. Supposed Triassic beds are found, but they are confined chiefly to the eastern margin of the Mesozoic area north of Lisbon. The Jurassic deposits are partly marine and partly fresh-water or terrestrial, including beds of lignite. On the whole, excepting in eastern Algarve, the Upper Jurassic beds indicate the neighbourhood of a shore-line. The Cretaceous system is very limited in extent. Its most interesting feature is the occurrence near its summit, north of Cape Mondego, of sands and gravels containing plant remains. Here both Cretaceous and Tertiary forms are found, and the Mondego beds seem to represent the passage between the two systems. At the close of the Cretaceous period great eruptions of basalt and basaltic tuff took place, especially in the Lisbon area. The volcanic rocks then formed are followed by marine deposits of Oligocene and Miocene age. Towards the north these are associated with fresh-water limestones, indicating the presence of land in that direction. Marine Pliocene beds occur at the mouth of the Tagus. The contemporaneous beds inland are of fresh-water origin. Eruptive masses of various age are found in many localities. The Cintra granite sends veins into the base of the Upper Jurassic, and is very probably of Tertiary age. The Serra de Monchique is petrographically of great interest. It consists chiefly of elaeolite-syenite and other rocks derived from the same igneous magma.

Climate.—The climate of Portugal is equable and temperate. Lisbon, Coimbra, Evora and Oporto have mean temperatures between 60° and 61.5° F., and the daily variation nowhere exceeds 23°. This equability of temperature is partly caused by the very heavy rainfall precipitated on Portugal as one of the westernmost countries of Europe and the one most exposed to the Atlantic. The rainfall has been as heavy as 16 ft. in a year, and sometimes, as in the winter of 1909-1910, great damage is wrought by floods. Heavy fogs are also common along the coast, rendering it dangerous to ships. The rainfall is heaviest in the north and on the Serra da Estrella; it is least in Algarve. A fine climate and equability of temperature are not universal in Portugal; they are to be enjoyed mainly in Beira and Estremadura, especially at Cintra and Coimbra, and in the northern provinces. In the deep valleys where the mountains keep off the cool winds, it is excessively hot in summer; while on the summits of the mountains snow lies for many months. The meteorological station on the Serra da Estrella, with a mean annual temperature of 44.7° F., is the coldest spot in Portugal in which systematic observations are taken. Montalegre has a mean of 48.3° and Guarda of 50.3°. Even in Lisbon the yearly variation is not less than 50°. In Alemtejo the climate is very unfavourable, and, though the heat is not so great as in Algarve (where Lagos has a mean of 63°), the country has a more deserted appearance; while in winter when the Tagus overflows, unhealthy swamps are left. Notwithstanding that Algarve is hotter than Alemtejo, a profuse vegetation takes away much of the tropical effect. Portugal is very rarely visited by thunderstorms; but shocks of earthquake are frequently felt, and recall the great earthquake of Lisbon (*q.v.*) in 1755.

Fauna and Flora.—An account of the fauna of the Iberian Peninsula as a whole is given under SPAIN. Wolves are found in the wilder parts of the Serra da Estrella, and wild boars are preserved in some districts. As far as the constituents of its flora are concerned Portugal is not very dissimilar from Spain, but their distribution is peculiar. The vegetation of Spain is distributed in clearly marked zones; but over the whole of Portugal, except the hottest parts of Algarve and Alemtejo, the plants of northern Europe flourish side by side with cacti, palms, aloes and tree-ferns (see CINTRA). This is largely due to the fact that the moisture-laden winds from the Atlantic penetrate almost as far inland as the Portuguese frontier, but do not reach the interior of Spain. The soil is fertile, and the indigenous flora has been greatly enriched by the importation of such plants as the agave, the Mexican opuntia, the American maple, the Australian eucalyptus, the Scotch fir and the so-called Portuguese cypress (*Cupressus lusitanica*) from the Azores. There are many fine tracts of forest, among which may be mentioned the famous convent-wood of Bussaco (*q.v.*); cork

trees are extensively cultivated, Barbary oaks (*Quercus ballota*, Port. *azinheira*) furnish edible acorns and excellent timber for charcoal, and carob-trees (*Ceratonia siliqua*, Port. *alfarrobeira*) also produce edible seed-pods somewhat resembling beans. Elms, limes and poplars are common north of the Tagus, ilexes, araucarias, myrtles, magnolias and a great variety of conifers in all parts. The Serra da Estrela has a rich alpine flora, and the lagoon of Aveiro contains a great number of aquatic plants.

Inhabitants.—The population of Portugal numbered 4,550,699 in 1878, 5,049,729 in 1890 and 5,423,132 in 1900. These totals include the inhabitants of the Azores and Madeira, which together amounted to 406,865 in 1900. Few immigrants enter the country, but the birth-rate is about 30 per 1000, while the mortality is only about 20 per 1000. Large bodies of emigrants, chiefly recruited from the sober, hardy and industrious peasantry of the northern provinces, annually leave Portugal to seek fortune in America. A few go to the Portuguese colonies, the great majority to Brazil. Many of these emigrants return with considerable savings and settle on the land. The mortality is highest among male children, and the normal excess of females is in the proportion of 109 to 100. Six-sevenths of the population of continental Portugal inhabit the provinces north of the Tagus. The density of population is greatest in Madeira (479.5 per sq. m. in 1900), Entre-Minho-e-Douro (419.5) and the Azores (277.9), nowhere else does it reach 200 per sq. m. In Alemtejo the percentage sinks to 45.1, and for the whole country, including the islands, it amounts only to 152.8.

The Portuguese people is composed of many racial elements. Its earliest known ancestors were the Iberians (*q.v.*). The peasantry, especially in the north, are closely akin to the Galician and Asturian Spaniards in character, physique and dialect; and these three ethnical groups—Portuguese of the north, Galicians, Asturians—may perhaps be regarded as the purest representatives of the Spanish stock. The first settlers with whom they intermarried were probably Carthaginians, who were followed in smaller numbers by Greeks; but the attempts which have sometimes been made to ascribe certain attributes of the Portuguese to the influence of these races are altogether fanciful. The Romans, whose supremacy was not seriously threatened for some six centuries after the Punic Wars, gave to Portugal its language and the foundation of its civilization; there is, however, no evidence that they seriously modified the physical type or character of its people. In these respects the Suevic and Visigothic conquests left a more permanent impression, especially in the northern provinces. After 711 came the long period of Moorish (*i.e.* Arab and Berber) predominance. The influence of the Moors was greatest south of the Tagus. In Alemtejo, and still more in Algarve, Arab and Berber types are common; and the influence of these races can everywhere be discerned in the architecture, handicrafts and speech of the peasantry. So complete was the intellectual triumph of the Moors that an intermediate "Mozarabic" population arose, Portuguese in blood, Christian in religion, but Arab in language and manners. Many of the Mozarabs even adopted the characteristic Mohammedan rite of circumcision. Under the tolerant rule of Islam the Portuguese Jews rose to a height of wealth and culture unparalleled in Europe; they intermarried with the Christians both at this period and after their forced conversion by King Emanuel I. (1495–1521). After 1450 yet another ethnical element was introduced into the nation, through the importation of African slaves in vast numbers. Negroid types are common throughout central and southern Portugal. No European race confronted with the problem of an immense coloured population has solved it more successfully than the Portuguese and their kinsmen in Brazil; in both countries intermarriage was freely resorted to, and the offspring of these mixed unions are superior in character and intelligence to most half-breeds.

National Characteristics.—The normal type evolved from this fusion of many races is dark-haired, sallow-skinned, brown-eyed and of low stature. The poorer classes, above all the fishermen and small farmers, are physically much finer than the well-to-do, who are prone to excessive stoutness owing to their more sedentary habits. The staple diet of the labouring classes and

small farmers is fish, especially the dried codfish called *bacalhão*, rice, beans, maize bread and meal, olive oil, fruit and vegetables. Meat is rarely eaten except on festivals. In Alemtejo chestnuts and figs are important articles of diet. Drunkenness is extremely rare. There is no single national dress, but a great variety of picturesque costumes are worn. The sashes, broad-brimmed hats and copper-tipped quarterstaves of the men, and the brilliant cotton dresses and gold or silver filigree ornaments worn on holidays by the women are common throughout the country; but many classes have their own costumes, varying in detail according to the district or province. These costumes may be seen at their best at bull-fights and at such popular festivals as the *romarias* or pilgrimages, which combine religion with the attractions of a fair. The national sport of bull-fighting (*q.v.*) is conducted as humanely as possible, for the Portuguese are lovers of animals. The artistic sense of the nation is perhaps greatest among the peasantry, although Portugal has the most illiterate peasantry in western Europe. It is manifested in their poetry and music even more than in their admirable costumes and in the good taste which has preserved the Roman or Moorish forms of their domestic pottery. Even the men and women who till the soil are capable of improvising verse of real merit, and sometimes excel in the ancient and difficult art of composing extempore amoebean rhymes. In this way, although the ancient ballads are not forgotten, new words are also fitted to the plaintive folk-tunes (*fados*) which every farm-hand knows and sings, accompanied sometimes by a rude clarinet or bagpipes, but more frequently by the so-called Portuguese guitar—an instrument which resembles a mandolin rather than the guitars of Italy and Spain. The native dances, slow but not ungraceful, and more restrained than those of Andalusia or the south of France, are obviously Moorish in origin, and depend for their main effects on the movement of the arms and body. Many curious superstitions survive in the country districts, including the beliefs in witches (*feiticeiras*, *bruxas*) and werewolves (*lobishomens*); in sirens (*sereias*) which haunt the dangerous coast and lure fishermen to destruction; in fairies (*fadas*) and in many kinds of enchantment. It will be observed that the nomenclature of Portuguese folk-lore suggests that the popular superstitions are of the most diverse origin—Latin, Greek, Arabic, native: *lobishomem* is the Latin *lupus homo*, wolf-man, *sereia* is the Greek *σέρφη*, *bruxa* is Arabic, *feiticeira* and *fada* Portuguese. Other beliefs can be traced to Jewish and African sources.

Chief Towns.—The chief towns of Portugal are Lisbon (pop. 1900, 356,009), the capital and principal seaport; Oporto (167,955), the capital of the northern provinces and, after Lisbon, the most important centre of trade; the seaports of Setubal (22,074), Ilhavo (12,617), Povoia de Varzim (12,623), Tavira (12,175), Faro (11,789), Ovar (10,462), Olhão (10,000) Vianna do Castelo (10,000), Aveiro (9975), Lagos (8291), Leixões (7690) and Figueira da Foz (6221); and the inland cities or towns of Braga (24,202), Loulé (22,478), Coimbra (18,144), Evora (16,020), Covilhã (15,469), Elvas (13,981), Portalegre (11,820), Palmella (11,478), Torres Novas (10,746), Silves (9687), Lamego (9471), Guimarães (9104), Beja (8885), Santarem (8628), Vizeu (8057), Estremoz (7920), Monchique (7345), Castello Branco (7288), Abrantes (7255), Torres Vedras (6900), Thomar (6888), Villa Real (6716), Chaves (6388), Guarda (6124), Cintra (5914), Braganza (5535), Mafra (4769), Leiria (4450), Batalha (3858), Almeida (2330), Alcobaca (2309), Bussaco (1661). All these are described in separate articles.

Communications.—Up to 1851 there was practically no good carriage road in the country except the highway between Lisbon and Cintra. In 1853 the work of constructing a proper system of roads was undertaken, and by the end of the century all the larger towns were linked together by the main or "royal" highways to which the "district" and "municipal" roads were subsidiary. Each class of road was named after the authority responsible for its construction and upkeep. In some of the remoter rural districts there are only bridle-paths, or rough tracks, which become almost impassable in wet seasons, and are never suitable for vehicles less solid than the Portuguese ox-carts. The first railway was opened in 1853 to connect Lisbon with Badajoz. In 1910 1758 m. were completed, of which 672 m. were state lines. The Portuguese

railways meet the Spanish at Valença do Minho on the northern frontier, at Barca d'Alva, at Villar Formoso, near Valencia de Alcantara, and near Badajoz on the eastern frontier. In some of the chief towns there are electric tramways. The most important internal waterways are the lower Tagus and the Douro between Oporto and the Paiz do Vinho. In 1908, 11,045 vessels of 19,354,967 tons entered Portuguese seaports, but a very large majority of these ships were foreign, and especially British. The postal and telegraphic services are adequate; telephone systems are installed in Lisbon, Oporto and other large towns; and the Eastern Telegraph Co. has an important cable station at Carcavellos near Lisbon (*q.v.*).

Land Tenure.—Four modes of land tenure are common in Portugal. The poor and thinly-peopled region of Alemtejo is divided into large estates, and cultivated by tenant farmers. Numerous estates in various provinces are held on the metayage system (*q.v.*). In the north, where the land is much subdivided, peasant proprietorship and a kind of emphyteusis (see ROMAN LAW) are the most usual tenures. The Portuguese form of emphyteusis is called *aforamento*; the landlord parts with the user of his property in exchange for a quit-rent (*foro* or *canon*). He may evict his tenant should the rent be in arrear for five years, and may at any time distrain if it be overdue; but he cannot otherwise interfere with the holding, which the tenant may improve or neglect. Should the tenant sell or exchange his interest in the property, the right of pre-emption is vested in the landlord, and a corresponding right is enjoyed by the tenant should the quit-rent be for sale. As this tenure is very ancient, though modified in 1832 and 1867, the value of such holdings has been greatly enhanced with the improvement of the land and the decline in the purchasing power of currency.

Agriculture.—Many of the instruments and processes of Portuguese agriculture and viticulture were introduced by the Romans, and are such as Columella described in the 1st century A.D. The characteristic springless ox-cart which is used for heavy loads may be seen represented on Roman frescoes of even earlier date. One form of plough still used consists of a crooked bough, with an iron share attached. Oxen are employed for all field-work; those of the commonest breed are tawny, of great muscular power, very docile, and with horns measuring 5 or 6 ft. from tip to tip. The ox-yokes are often elaborately carved in a traditional pattern in which Gothic and Moorish designs are blended. The Moors introduced many improvements, especially in the system of irrigation; the characteristic Portuguese wells with their perpetual chains or buckets are of Moorish invention, and retain their Moorish name of *noras*. In all, rather more than 45% of the country is uncultivated, chiefly in Alemtejo, Traz-os-Montes and the Serra da Estrella. The principal grain-crops are maize, wheat and rye; rice is grown among the marshes of the coast. Gourds, pumpkins, cabbages and other vegetables are cultivated among the cereals. The large onions sold in Great Britain as Spanish are extensively produced in the northern provinces. Every district has its vineyards, the finest of which are in the Paiz do Vinho (see OPORTO and WINE). The bush vines of this region are more exposed to the attacks of *Oidium Tuckeri*, which invaded the country in 1851, and of *Phylloxera vastatrix*, which followed in 1863, than the more deeply-rooted vines trained on trellises or trees. Both these pests have been successfully combated, largely by the use of sulphur and by grafting immune American vines upon native stocks. In addition to grapes the commoner fruits include quinces, apples, pears, cherries, limes, lemons and loquats (Port. *nesbras*); Condeixa is famous for oranges, Amarante for peaches, Elvas for plums, the southern provinces for carobs and figs. Large quantities of olive oil are manufactured south of the Douro. Almost all cattle, except fighting-bulls, are stall-fed. The fighting-bulls are chiefly reared in the marshes and alluvial valleys; they are bred for strength and swiftness rather than size, and a good specimen should be sufficiently agile to leap over the inner barrier of the arena (about 68 in. high). Large herds of swine are fed in the oak and chestnut woods of Alemtejo; sheep and goats are reared in the mountains, where excellent cheeses are made from goats' milk.

Fisheries.—About 50,000 Portuguese are classed as hunters and fishermen. The majority of these are employed in the sardine and tunny fisheries. This industry is carried on in a fleet of more than 10,000 small vessels, including the whalers of the Azores and the cod-boats which operate outside Portuguese waters. The fishermen and fisherwomen form a quite distinct class of the people; both sexes are noted for their bodily strength, and the men for their bold and skillful seamanship. Tunny and sardines are cured and exported in large quantities, oysters are also exported, and many other sea fish, such as hake, sea-bream, whiting, conger and various flat-fish are consumed in the country. In the early years of the 20th century the competition of foreign steam trawlers inflicted much hardship on the fishermen. The average yearly value of the fish landed in Portugal (exclusive of cured fish from foreign countries) is about £800,000. Salmon, lampreys and eels are caught in some of the larger rivers; trout abound in the streams of the northern provinces; but many fresh-water fish common elsewhere in Europe, including pike, perch, tench and chub, are not found.

Mines.—It is usually stated that Portugal is rich in minerals, especially copper, but that want of capital and, especially in the south, of transport and labour, has retarded their exploitation. The mineral deposits of the country are very varied, but their extent is probably exaggerated. The average yearly output from 1901 to 1905 was worth less than £300,000. Copper is mined in southern Portugal. Common salt (chiefly from Alcacer do Sal near Setubal), gypsum, lime and marble are exported; marble and granite of fine quality abound in the southern provinces. Iron is obtained near Beja and Evora, tin in the district of Braganza. Lead, wolfram, antimony and auriferous quartz exist in the districts of Coimbra, Evora, Beja and Faro. Lignite occurs at many points around Coimbra, Leiria and Santarem; asphalt abounds near Alcobaga; phosphorite, asbestos and sulphur are common south of the Tagus. Petroleum has been found near Torres Vedras; pitchblende, arsenic, anthracite and zinc are also mined. Gold was washed from some of the Portuguese rivers before the Christian era, and among the Romans the auriferous sands of the Tagus were proverbially famous; it is, however, extremely improbable that large quantities of gold were ever obtained in this region, although small deposits of alluvial gold may still be found in the valleys of the Tagus and Mondego.

Manufactures.—The Methuen Treaty of 1703 prevented the establishment of some manufacturing industries in Portugal by securing a monopoly for British textiles, and it was only after 1892 that Portuguese cotton-spinning and weaving were fostered by heavy protective duties. In 20 years these industries became the most important in the country after agriculture, the wine and cork trades and the fisheries. In connexion with the wine trade there are many large cooperages; cork products are extensively manufactured for export. Lisbon is the headquarters of the ship-building trade. Here, and in other cities, tanning, distilling, various metallurgical industries, and manufactures of soap, flour, tobacco, &c., are carried on; the entire output is sold in Portugal or its colonies. There is a steady trade in natural mineral waters, which occur in many parts of continental Portugal and the Azores. From the 16th century to the 18th many artistic handicrafts were practised by the Portuguese in imitation of the fine pottery, cabinet-work, embroideries, &c., which they imported from India and Persia. Portuguese cabinet-work deteriorated in the 19th century; the glass-works and potteries of the Aveiro and Leiria districts have lost much of their ancient reputation; and even the exquisite lace of Peniche and Vianna do Castelo is strangely neglected abroad. The finest Caldas da Rainha china-ware, with its fantastic representations of birds, beasts and fishes, still commands a fair price in foreign markets; but the blue and white ware originally copied from Delft and later modified under the influence of Persian pottery is now only manufactured in small quantities, of inferior quality. Skillful copies of Moorish metal-work may be purchased in the goldsmiths' and silversmiths' shops of Lisbon and Oporto; conspicuous among these are the filigree ornaments which are bought by the peasant women as investments and by foreign visitors as curiosities. In 1900 the total industrial population of Portugal was 455,296.

Commerce.—The annual value of the foreign trade of Portugal amounts approximately to £19,000,000. The following table shows the value for five years of the exports, and of all imports not re-exported (exclusive of coin and bullion):—

Years.	Exports.	Imports.
1901	£6,284,800	£12,849,622
1902	£6,318,888	£12,354,800
1903	£6,800,710	£13,068,000
1904	£6,824,692	£13,801,622
1905	£6,460,000	£13,486,666

In 1910 the principal exports, in order of value, were wine (chiefly port, common wines and Madeira), raw and manufactured cork, preserved fish, fruits and vegetables, cottons and yarn, copper ore, timber, olive oil, skins, grain and flour, tobacco and wool. The imports were raw and manufactured cotton, wool and silk, wheat and maize, coal, iron and machinery, dried codfish, sugar, rice, hides and skins, oils. The United Kingdom, which annually purchases wine to the value of about £900,000 and cork to the value of about £500,000, is the chief consumer of Portuguese goods, and the chief exporter to Portugal. Germany and the United States rank respectively second and third among the countries which export to Portugal; Spain, which buys bullocks and pigs, Brazil, which buys wine, and the Portuguese colonies, which buy textiles, are among the chief purchasers of Portuguese products. In addition to its direct foreign commerce Portugal derives much benefit from its share in the trade between South America and Europe. Large liners from Liverpool, Southampton, London, Hamburg, Havre and Antwerp call regularly for passengers or cargo at Leixões or Lisbon, or both ports, on their way to and from South America (especially Brazil). In connexion with this trade an important tourist traffic, chiefly from Great Britain and Germany, was developed towards the end of the 19th century.

Banks and Money.—In 1910 the Bank of Portugal, to which the

treasury was deeply indebted, had a capital of £1,500,000, and a monopoly of note issue in continental Portugal, but the notes of the Ultramarine Bank circulated in the colonies. The notes of the Bank of Portugal in circulation amounted in value to about £14,000,000. For an account of the Monte Pio Geral, which is a combined bank, pawnbroking establishment and benefit society, see PAWNBROKING; the deposits in the Monte Pio and the State Savings Bank amounted in 1910 to some £5,228,000. There are also many private banks, including savings banks. Gold is the standard of value, but the actual currency is chiefly Bank of Portugal notes. The values of coin and notes are expressed in multiples of the *real* (plural *reis*), a monetary unit which does not actually exist. The milreis, 1000 reis of the par value of 4s. 5d. (or 4.5 milreis to the pound sterling) and the conto of reis (1000 milreis) are used for the calculation of large sums. Gold pieces of 10, 5, 2 and 1 milreis were coined up to 1891; 10, 5, and 2 testoon (*testão*) pieces, worth respectively 1000, 500 and 200 reis, are coined in silver; testoons of 100 reis and half testoons of 50 reis, in nickel; pieces of 20, 10 and 5 reis in bronze. The milreis fluctuates widely in value, the balance of exchange being usually adverse to Portugal; for the purposes of this article the milreis has been taken at par. The British sovereign is legal tender for 4500 reis, but in practice usually commands a premium. The metric system of weights and measures has been officially adopted, but many older standards are used, such as the *libra* (1.012 lb avoirdupois), *alqueire* (0.36 imperial bushel), *moio* (2.78 imp. bushels), *almude* of Lisbon (3.7 imp. gallons) and *almude* of Oporto (5.6 imp. gallons).

Finance.—For the five financial years, 1901–1902 to 1905–1906, the average revenue of Portugal was about £13,300,000 and the average expenditure £13,466,000. The chief sources of revenue were customs duties, taxes on land and industries, duties on tobacco and breadstuffs, the Lisbon octroi, receipts from national property, registration and stamps, &c. The heaviest expenditure (nearly £5,000,000) was incurred for the service of the consolidated debt; payments for the civil list, cortes, pensions, &c., amounted to more than £2,000,000, and the cost of public works to nearly as large a sum. The ministries of war and marine together spent about £2,500,000 each year. The practice of meeting deficits by loans, together with the great expenditure, after 1853, on public works, especially roads and railways, explains the rapid growth of the national debt in modern times. In 1853 the total public debt, internal and external, amounted to £2,082,680. It exceeded £90,000,000 in 1890, and in 1891–1892 the finances of the kingdom reached a crisis, from which there was no escape except by arranging for a reduction in the amount payable as interest (see *History*, below). By the law of the 26th of February 1892 30% was deducted from the internal debt payable in currency; by the law of the 20th of April 1893 66½% was deducted from the interest on the external debt, due in gold. A law of the 9th of August 1902 provided for the conversion of certain gold debts into three series of consolidated debt, at reduced interest. In 1909 the total outstanding debt amounted to £161,837,430, made up as follows: new external 3% converted in three series, £34,223,465; 4½% tobacco loan £7,267,480; internal 3% (quoted in London) £113,132,979. Internal debt at 3, 4 and 4½% was also outstanding to the amount of £7,213,506.

Constitution.—Up to October 1910 the government was an hereditary and constitutional monarchy, based on the constitutional charter which was granted by King Pedro IV. on the 29th of April 1826, and was afterwards several times modified; the most important changes were those effected by the acts of the 5th of July 1852, the 24th of July 1885, and the 28th of March and 25th of September 1895. The revolution of the 5th of October 1910 brought the monarchy to an end and substituted republican government for it. The monarchical constitution recognized four powers in the state—the executive, moderating, legislative and judicial. The two first of these were vested in the sovereign, who might be a woman, and who shared the legislative power with two chambers, the *Camara dos Pares* or House of Peers, and the *Camara dos Deputados* or House of Commons; these were collectively styled the *Cortes Geraes*, or more briefly the *Cortes*. The royal veto could not be imposed on legislation passed twice by both houses. The annual session lasted four months, and a general election was necessary at the end of every four years, or immediately after a dissolution. A committee representing both houses adjudicated upon all cases of conflict between Peers and Commons; should it fail to reach a decision, the dispute was referred to the sovereign, whose award was final. Up to 1885 some members sat in the House of Peers by hereditary right, while others were nominated for life. It was then decided that such rights should cease, except in the case of princes of royal blood and members then sitting, and that

when all the hereditary peerages had lapsed the house should be composed of the princes of the royal blood, the archbishops and bishops of the continental dioceses, a hundred legislative peers appointed by the king for life, and fifty elected every new parliament by the Commons. In 1895 the number of nominated life peers was reduced to ninety and the elective branch was abolished. Subject to certain limitations and to a property qualification, any person over 40 years of age was eligible to a peerage. The titles and social position of the Portuguese aristocracy were not affected when its political privileges were abolished. In the nomination of life peers, and in certain administrative matters the sovereign was advised by a council of state, whose twelve members were nominated for life and were principally past or present ministers. The sovereign exercised his executive power through a cabinet which was responsible to the cortes, and consisted of seven members, representing the ministries of (1) the interior, (2) foreign affairs, (3) finance, (4) justice and worship, (5) war, (6) marine and colonies, (7) public works, industry and commerce. The House of Commons was composed of 148 members, representing the 26 electoral divisions of Portugal, the Azores and Madeira, which returned 113 elected members and 35 representatives of minorities, and of 7 members representing the colonies. Peers, naturalized foreigners and certain employees of the state were unable to sit in the House of Commons; members were required to be graduates of one of the highest, secondary or professional schools, or to possess an income of not less than 400 milreis (£88). All members might, in connexion with their official duties, travel free on railways and ships owned by the state; but since 1892 none had received any salary except the colonial members, who were paid 100 milreis (£22) per month during the session, and 50 milreis (£11) per month during the remainder of the year. All male citizens 21 years old who could read and write, or who paid taxes amounting to 500 reis yearly, had the parliamentary franchise, except convicts, beggars, undischarged bankrupts, domestic servants, workmen permanently employed by the state and soldiers or sailors below the rank of commissioned officer. (For changes made under republican rule, see *History*, § 8.)

Local Government.—Continental Portugal was formerly divided for administrative purposes into six provinces which corresponded to a great extent with the natural geographical divisions of the country and are described in separate articles; the names of these, which are still commonly used, are Entre-Minho-e-Douro (also called Entre-Douro-e-Minho or Minho), Traz-os-Montes, Beira, Estremadura, Alentejo and Algarve. The province of Douro, another administrative division of less antiquity, comprised the present districts of Aveiro and Oporto, or part of Beira and Entre-Minho-e-Douro. The six ancient provinces were subdivided on the 28th of June 1833 into districts, each named after its chief town, as follows: Entre-Minho-e-Douro into Vianna do Castello, Braga, Oporto; Traz-os-Montes, into Villa Real, Braganza; Beira, into Aveiro, Vizeu, Coimbra, Guarda, Castello Branco; Estremadura, into Leiria, Santarem, Lisbon; Alentejo, into Portalegre, Evora, Beja; Algarve was renamed Faro. In 1910 the Azores comprised three districts and Madeira formed one. Each district was governed by a commission composed of (1) the civil governor, who was nominated by the central authority and presided over the commission; (2) the administrative auditor; and (3) three members chosen by indirect suffrage. The districts were divided into communes (*concelhos*), each administered by an elected council, and a mayor nominated by the central authority. The mayor could not preside over the council, which appointed one of its own members to preside and to give effect to its decisions. The communes were subdivided into parishes (*freguesias*), which were administered by the elected council (*junta de parochia*) over which the parish priest (*presbitero*) presided, and by the *regedor*, an official who represented the mayor of the commune and was nominated by the civil governor. The central authority had almost complete control over local administration through its representatives, the civil governor, mayors and *regedores*.

Justice.—In 1910 Portugal was divided into 193 judicial districts (*comarcas*), in each of which there was a court of first instance. The three courts of appeal (*tribunaes de relação*) sat at Lisbon, Oporto and Ponta Delgada (Azores), and there was a Supreme Court in Lisbon.

Colonies.—At the beginning of the 19th century Portugal possessed a larger colonial empire than any European power except Great Britain and Spain. At the beginning of the 20th century its transmarine possessions had been greatly reduced in size by the loss of Brazil, but were still only surpassed in extent

by those of three powers—Great Britain, France and Germany. Their total area was about 803,000 sq. m., of which 794,000 sq. m. are in Africa. They comprised, in Africa, the Cape Verde Islands, St Thomas and Prince's Islands, Portuguese Guinea, Angola and Portuguese East Africa, or Mozambique; in India, Goa, Damaun and Diu; in China, Macao; and in the Malay Archipelago part of Timor. All these are described in separate articles. In all the white population is in a minority; in most the climate is unsuitable for European colonization, nor is the commercial value of the colonies commensurate with their extent. Viewed as a whole, Portuguese administration has been carried on under difficulties which have rendered it costly and inefficient, the home government being compelled to contribute a large annual subsidy towards its maintenance. The amount paid in subsidies from 1870 to 1900 was about £15,000,000.

Religion.—Roman Catholicism was the state religion until 1910, but other creeds were tolerated, and the Church lost its temporal authority in 1834, when the monasteries were suppressed and their property confiscated for the first time. There are three ecclesiastical provinces—Braga, Lisbon and Evora, each under an archbishop. The archbishop of Braga, whose see is the most ancient, has the title of Primate; the archbishop of Lisbon has the honorary title of Patriarch, and is usually elected a cardinal. His province includes Madeira, the Azores and the West African colonies. There are fourteen dioceses, of which Oporto is the most important. The annual revenues of the upper hierarchy of the Church amounted, up to 1910, to about £65,000. In some of the larger towns the foreign residents have their own places of worship. (See further under *History*.)

Education.—Primary education is regulated by a law of 1844, under which children between the ages of 7 and 15 are bound to attend a school, should there be one within a mile, under penalty to the parents of a fine and deprivation of civil rights. This law has not been strictly enforced; primary education was never properly organized; and, according to census returns, the proportion of the population (including children) unable to read was 82.4% in 1878, 79.2 in 1890 and 78.6 in 1900. There were in 1910 5250 public and 1750 private primary schools. In the chief towns there are training schools for teachers. The system of secondary education was reorganized in 1894. In 1905 there were state lycées in each district capital and in Guimarães, Lamego and Amarante; 5 municipal lycées, at Celorico de Basto, Chaves, Ponte de Lima, Povoia de Varzim and Setubal; military and naval colleges; a secondary school for girls in Lisbon; numerous private secondary schools and ecclesiastical seminaries; industrial, commercial and technical schools; and pilot schools at Lisbon, Oporto, Faro and Ponta Delgada (Azores). Other important educational institutions are described under LISBON and OPORTO. The national university is at Coimbra (*q.v.*).

Defence.—Under the monarchy, the army was maintained at its normal strength partly by voluntary enlistment and conscription, the chief law regulating it being that of 1887, as variously modified in subsequent years. The cortes fixed the number of conscripts to be enrolled in each year: in 1905, 15,000 men for the army, 1000 for the navy, 500 for the municipal guards and 400 for the fiscal guards. The organization of the army was based on the acts of the 7th of September 1899 and the 24th of December 1901. With certain exceptions all men over 21 years of age were liable for service—3 years in the regular army, 5 years in the first reserve and 7 years in the second reserve; but exemption could always be purchased. In time of war, the municipal guards, numbering about 2200, and the fiscal guards, numbering about 5200, might be incorporated in the army. The total effective force of the active army on a peace footing was 1787 officers, 31,281 men, 6479 horses and mules and 100 guns. The total effective force on a war footing, inclusive of reservists, municipal guards and fiscal guards, was 4221 officers, 178,603 men, 19,600 horses and mules and 336 guns. Lisbon, Elvas and Angra in the Azores, were considered first-class fortresses, but only Lisbon had modern defences. The Portuguese navy in 1910 consisted of 1 armoured vessel, 5 protected cruisers, 2 third-class cruisers, 19 gunboats, 1 torpedo gunboat, 4 torpedo boats, 16 river gunboats, 4 transports and 3 training ships. Twelve other vessels, including 2 submarines, were under construction. The whole fleet was manned by about 5000 men.

BIBLIOGRAPHY.—Numerous official reports, chiefly statistical, are published periodically in Lisbon; a few are written in French, the majority in Portuguese. Read in conjunction with the British consular and diplomatic reports, they afford a comprehensive survey of the movement of population, the progress of trade, &c. The following state papers deserve special notice: *Caminhos de ferro* (1877, &c.), *Commercio e navigação* (annual, issued by the Ministry of Marine), *Le Portugal vinicole* (1900), *Le Portugal . . . agricole* (1900), *Notas sobre Portugal* (2 vols., 1908). For geology, see the section of *Le Portugal . . . agricole* written by P. Choffat and entitled "Aperçu de la géologie de Portugal," also "The Work of the Portuguese Geological Survey," by Philip Lake, in *Science*

Progress (1896) v. 439-453; both these summaries refer to the most important original papers. Two illustrated volumes by Oswald Crawford, *Portugal Old and New* (London, 1880) and *Round the Calendar in Portugal* (London, 1890) contain much valuable information on agriculture, viticulture and peasant life in the northern provinces. *Through Portugal*, by Major Martin Hume (London, 1907) and *Lisbon and Centro*, by A. A. Inchbold (London, 1908), describe the towns, &c., most frequently visited by tourists, and are illustrated in colours. *Le Portugal* (Paris, 1899), by 18 writers, is a brief but encyclopaedic description of continental Portugal. See also *Portugal: its Land and People*, by W. H. Koebel (London, 1909), and *Portuguese Architecture*, by W. C. Watson (London, 1908). The following books deal comprehensively with the Portuguese colonies; *As Colonias portuguesas*, by E. J. de Vasconcellos (2nd ed., Lisbon, 1903), *Les Colonies portugaises*, by A. de Almada Negreiros (Paris, 1908). (K. G. J.)

HISTORY

Throughout the centuries which witnessed the destruction of Carthaginian power by Rome, the establishment and decline of Latin civilization, the invasion by Alani, Suevi and other barbarian races, the resettlement under Visigothic rule and the overthrow of the Visigoths by Arab and Berber tribes from Africa, Portugal remained an undifferentiated part of Hispania, without sign of national consciousness. The Iberian Peninsula was one; and its common history is related under SPAIN. It is true that some Portuguese writers have sought to identify their race with the ancient Lusitani, and have claimed for it a separate and continuous existence dating from the 2nd century B.C. The revolt of Lusitania against the Romans has been regarded as an early manifestation of Portuguese love of liberty, Viriathus as a national hero. But this theory, which originated in the 15th century and was perpetuated in the title of *The Lusitads*, has no historical foundation. In 1095 Portugal was an obscure border fief of the kingdom of Leon. Its territories, far from the centres of European civilization and consisting largely of mountain, moorland and forest, were bounded on the north by the Minho, on the south by the Mondego. Its name (*Portu-calia, Terra portucalensis*) was derived from the little seaport of Portus Cale or Villa Nova de Gaia, now a suburb of Oporto, at the mouth of the Douro. Its inhabitants, surrounded by Moorish or Spanish enemies and distracted by civil war, derived such rudiments of civilization as they possessed from Arabic or Leonese sources. But from these obscure beginnings Portugal rose in four centuries to be the greatest maritime, commercial and colonial power in Europe.

The history of the nation comprises eight periods. (1) Between 1095 and 1279 a Portuguese kingdom was established and extended until it reached its present continental limits. (2) Between 1279 and 1415 the monarchy was gradually consolidated in spite of resistance from the Church, the nobles and the rival kingdom of Castile. (3) In 1415 began a period of crusades and discoveries, culminating in the discovery of an ocean-route to India (1497-1499). (4) From 1499 to 1580 Portugal acquired an empire stretching from Brazil eastward to the Moluccas, reached the zenith of its prosperity and entered upon a period of swift decline. (5) Spanish kings ruled over Portugal from 1581 to 1640. (6) The chief event of the years 1640 to 1755 was the restoration of the Portuguese monarchy. (7) Between 1755 and 1826 the reforms of Pombal and the Peninsular War prepared the country for a change from absolutism to constitutional monarchy. (8) In 1826 the era of constitutional government began.

1. *The Establishment of the Monarchy.*—The origin of Portugal, as a separate state, was an incident in the Christian reconquest of Spain. Towards the close of the 11th century crusading knights came from every part of Europe to aid the kings of northern and central Spain in driving out the Moors. Among these adventurers was Count Henry of Burgundy, an ambitious warrior who, in 1095, married Theresa, natural daughter of Alphonso VI., king of Leon. The county of Portugal, which had already been won back from the Moors (1055-1064), was included in Theresa's dowry. Count Henry ruled as a vassal of Alphonso VI., whose Galician marches were thus secured against any sudden Moorish raid. But in

1109 Alphonso VI. died, bequeathing all his territories to his legitimate daughter Urraca, and Count Henry at once invaded Leon, hoping to add to his own dominions at the expense of his suzerain. After three years of war against Urraca and other rival claimants to the throne of Leon, Count Henry himself died in 1112. He left Theresa to govern Portugal north of the Mondego during the minority of her infant son Afonso Henriques (Alphonso I.): south of the Mondego the Moors were still supreme.

Theresa renewed the struggle against her half-sister and suzerain Urraca in 1116-1117, and again in 1120; in 1121 she was besieged in Lanhoso and captured. But a peace was negotiated by the archbishops Diogo Gelmires of Santiago de Compostela and Burdino of Braga, rival churchmen whose wealth and military resources enabled them to dictate terms. Bitter jealousy existed between the two prelates, each claiming to be primate of "all the Spains," and their antagonism had some historical importance in so far as it fostered the growth of separatist tendencies among the Portuguese. But the quarrel was temporarily suspended because both Gelmires and Burdino had reason to dread the extension of Urraca's authority. It was arranged that Theresa should be liberated and should continue to hold the county of Portugal as a fief (*honor*) of Leon. During the next five years she lavished wealth and titles upon her lover Fernando Peres, count of Trava, thus estranging her son, the archbishop of Braga and the nobles, most of whom were foreign crusaders. In 1128, after her power had been crushed in another unsuccessful conflict with Leon and Castile, she was deposed by her own rebellious subjects and exiled in company with Peres. She died in 1130.

Alphonso, who became count of Portugal in 1128, was one of the warrior heroes of medieval romance; his exploits were sung by troubadours throughout south-western Europe, and even in Africa "ibn Errik"—the son of Henry—was known and feared. The annals of his reign have been encumbered with a mass of legends, among which must be included the account of a cortes held at Lamego in 1143; probably also the description of the Valdevez tournament, in which the Portuguese knights are said to have vanquished the champions of Leon and Castile. Alphonso was occupied in almost incessant border fighting against his Christian or Moorish neighbours. Twelve years of campaigning on the Galician frontier were concluded in 1143 by the peace of Zamora, in which Alphonso was recognized as independent of any Spanish sovereign, although he promised to be a faithful vassal of the pope and to pay him a yearly tribute of four ounces of gold. In 1167, however, the war was renewed. Alphonso succeeded in conquering part of Galicia, but in attempting to capture the frontier fortress of Badajoz he was wounded and forced to surrender to Ferdinand II. of Leon (1169). Ferdinand was his son-in-law, and was probably disposed to leniency by the imminence of a Moorish invasion in which Portugal could render useful assistance. Alphonso was therefore released under promise to abandon all his conquests in Galicia.

He had already won many victories over the Moors. At the beginning of his reign the religious fervour which had sustained the Almoravide dynasty was rapidly subsiding; in Portugal independent Moorish chiefs ruled over cities and petty states, ignoring the central government; in Africa the Almohades were destroying the remnants of the Almoravide power. Alphonso took advantage of these dissensions to invade Alemtejo, reinforced by the Templars and Hospitallers, whose respective headquarters were at Soure and Thomar. On the 25th of July 1139 he defeated the combined forces of the Moors on the plains of Ourique, in Alemtejo. Legend has magnified the victory into the rout of 200,000 Moslems under five kings; but so far was the battle from being decisive that in 1140 the Moors were able to seize the fortress of Leiria, built by Alphonso in 1135 as an outpost for the defence of Coimbra, his capital. In 1144 they defeated the Templars at Soure. But on the 15th of March 1147 Alphonso stormed the fortress of Santarem, and about the same time a band of crusaders on their way to Palestine landed

at Oporto and volunteered for the impending siege of Lisbon. Among them were many Englishmen, Germans and Flemings, who were afterwards induced to settle in Portugal. Aided by these powerful allies, Alphonso captured Lisbon on the 24th of October 1147. This was the greatest military achievement of his reign. The Moorish garrisons of Palmella, Cintra and Almada soon capitulated, and in 1158 Alcacer do Sal, one of the chief centres of Moorish commerce, was taken by storm. At this time, however, the Almohades had triumphed in Africa and invaded the Peninsula, where they were able to check the Portuguese reconquest, although isolated bands of crusading adventurers succeeded in establishing themselves in various cities of Alemtejo. The most famous of these free-lances was Giraldo Sempavor ("Gerald the Fearless"), who captured Evora in 1166. In 1171 Alphonso concluded a seven years' truce with the Moors; weakened by his wound and by old age, he could no longer take the field, and when the war broke out afresh he delegated the chief command to his son Sancho. Between 1179 and 1184 the Moors retrieved many of their losses in Alemtejo, but were unable to retake Santarem and Lisbon. Alphonso died on the 6th of December 1185. He had secured for Portugal the status though not the name of an independent kingdom, and had extended its frontier southwards from the Mondego to the Tagus. He had laid the foundation of its navy and had strengthened, if he did not inaugurate, that system of co-operation between the Crown and the military orders which afterwards proved of incalculable service in the maritime and colonial development of the nation.

Sancho I. continued the war against the Moors with varying fortune. In 1189 he won Silves, then the capital of Algarve; in 1192 he lost not only Algarve but the greater part of Alemtejo, including Alcacer do Sal. A peace was then arranged, and for the next eight years Sancho was engaged in hostilities against Alphonso IX. of Leon. The motives and course of this indecisive struggle are equally obscure. It ended in 1201, and the last decade of Sancho's reign was a period of peaceful reform which earned for the king his popular name of *o Povoador*, the "maker of towns." He granted fresh charters to many cities, legalizing the system of self-government which the Romans had bequeathed to the Visigoths and the Moors had retained or improved. Lisbon had already (1179) received a charter from Alphonso I. Sancho also endeavoured to foster immigration and agriculture, by granting estates to the military orders and municipalities on condition that the occupiers should cultivate or colonize their lands. Towards the close of his reign he became embroiled in a dispute with Pope Innocent III. He had insisted that priests should accompany their flocks in battle, had made them amenable to secular jurisdiction, had withheld the tribute due to Rome and had even claimed the right of disposing of ecclesiastical domains. Finally he had quarrelled with Martinho Rodrigues, the unpopular bishop of Oporto, who was besieged for five months in his palace and then forced to seek redress in Rome (1209). As Sancho was in weak health and had no means of resisting Papal pressure, he made full submission (1210); and after bestowing large estates on his sons and daughters, he retired into the monastery of Alcobaca (*q.v.*), where he died in 1211.

The reign of Alphonso II. ("the Fat") is noteworthy for the first meeting of the Portuguese cortes, to which the upper hierarchy of the Church and the nobles (*fidalgos* and *Alphonso ricos homens*) were summoned by royal writ. The king was no warrior, but in 1212 a Portuguese contingent aided the Castilians to defeat the Moors at Las Navas de Tolosa, and in 1217 the ministers, bishops and captains of the realm, reinforced by foreign crusaders, retook Alcacer do Sal. Alphonso II. repudiated the will of his father, refused to surrender the estates left to his brothers, who went into exile, and only gave up the property bequeathed to his sisters after a prolonged civil war in which Alphonso IX. of Leon took part against them. Even then he compelled the heiresses to take the veil. His attempts to strengthen the monarchy and fill the treasury at the expense of the Church resulted in his excommunication by

Pope Honorius III., and Portugal remained under interdict until Alphonso II. died in 1223.

Sancho II. succeeded at the age of thirteen. To secure the removal of the interdict the leading statesmen who were identified with the policy of his father—Gonçalo Mendes the chancellor, Pedro Annes the lord chamberlain **Sancho II., 1223-1248.** (*mordomo-mór*) and Vicente, dean of Lisbon—resigned their offices. Estevão Soares, archbishop of Braga, placed himself at the head of the nobles and churchmen who threatened to usurp the royal power during Sancho II.'s minority, and negotiated an alliance with Alphonso IX., by which it was arranged that the Portuguese should attack Elvas, the Spaniards Badajoz. Elvas was taken from the Moors in 1226, and in 1227 Sancho assumed control of the kingdom. He reinstated Pedro Annes, made Vicente chancellor, and appointed Martim Annes chief standard-bearer (*alferes mór*). He continued the crusade against the Moors, who were driven from their last strongholds in Alemtejo, and in 1239-1244, after a dispute with Rome which was once more ended by the imposition of an interdict and the submission of the Portuguese ruler, he won many successes in the Algarve. But his career of conquest was cut short by a revolution (1245), for which his marriage to a Castilian lady, D. Mecia Lopez de Haro, furnished a pretext. The legitimacy of the union has been questioned, on grounds which appear insufficient; but of its unpopularity there can be no doubt. The bishops, resenting the favour shown by Sancho to his father's anti-clerical ministers, took advantage of this unpopularity to organize the rebellion. They found a leader in Sancho's brother Alphonso, count of Boulogne, who owed his title to a marriage with Matilda, countess of Boulogne. The pope issued a bull of deposition in favour of Alphonso, who reached Lisbon in 1246; and after a civil war lasting two years Sancho II. retired to Toledo, where he died in January 1248.

One of the first acts of the usurper, and one of the most important, was to abandon the semi-ecclesiastical titles of visitor **Alphonso III., 1248-1279.** (*visitador*) or defender (*curador*) of the realm, and to proclaim himself king (*rei*). Hitherto the position

of the monarchy had been precarious; as in Aragon the nobles and the church had exercised a large measure of control over their nominal head, and though it would be pedantry to over-emphasize the importance of the royal title, its assumption by Alphonso III. does mark a definite stage in the evolution of a national monarchy and a centralized government. A second stage was reached shortly afterwards by the conquest of Algarve, the last remaining stronghold of the Moors. This drew down upon Portugal the anger of Alphonso X. of Leon and Castile, surnamed the Wise, who claimed suzerainty over Algarve. The war which followed was ended by Alphonso III. consenting to wed Donna Beatriz de Guzman, illegitimate daughter of Alphonso X., and to hold Algarve as a fief of Castile. The celebration of this marriage, while Matilda, countess of Boulogne and first wife of Alphonso III., was still alive, entailed the imposition of an interdict upon the kingdom. In 1254 Alphonso III. summoned a cortes at Leiria, in which the chief cities were represented, as well as the nobles and clergy. Fortified by their support the king refused to submit to Rome. At the cortes of Coimbra (1261), he further strengthened his position by conciliating the representatives of the cities, who denounced the issue of a debased coinage, and by recognizing that taxation could not be imposed without consent of the cortes. The clergy suffered more than the laity under a prolonged interdict, and in 1262 Pope Urban VI. legalized the disputed marriage and legitimized Dom Diniz, the king's eldest son. Thus ended the contest for supremacy between Church and Crown. The monarchy owed its triumph to its championship of national interests, to the support of the municipalities and military orders, and to the prestige gained by the royal armies in the Moorish and Castilian wars. In 1263 Alphonso X. renounced his claim to suzerainty over Algarve, and thus the kingdom of Portugal simultaneously reached its present European limits and attained its complete independence. Lisbon was henceforth recognized as the capital. Alphonso III. continued to reign until his death in 1279, but the

peace of his later years was broken by the rebellion (1277-1279) of D. Diniz,¹ the heir-apparent.

2. *The Consolidation of the Monarchy: 1279-1415.*—The chief problems now confronting the monarchy were no longer military, but social, economic and constitutional. It is true that the reign of Diniz was not a period of uninterrupted peace. At the outset his legitimacy was disputed by his brother Alphonso, and a brief civil war ensued. Hostilities between Portugal and the reunited kingdoms of Leon and Castile were terminated in 1297 by a treaty of alliance, in accordance with which Ferdinand IV. of Leon and Castile married Constance, daughter of Diniz, while Alphonso, son of Diniz, married Beatrice of Castile, daughter of Ferdinand. A further outbreak of civil war, between the king and the heir-apparent, was averted in 1293 by the queen-consort Isabella of Portugal, who had married Diniz in 1281, and was canonized for her many virtues in the 16th century. She rode between the hostile camps, and succeeded in arranging an honourable peace between her husband and her son.

These wars were too brief to interfere seriously with the social reconstruction to which the king devoted himself. At his accession the Portuguese people was far from homogeneous; it would be long before its component **Diniz, 1279-1325.** races—Moors and Mozarabs of the south, Galicians of the north, Jews and foreign crusaders—could be fused into one nationality. There were also urgent economic problems to be solved. The Moors had made Alemtejo the granary of Portugal, but war had undone their work, and large tracts of land were now barren and depopulated. Commerce and education had similarly been subordinated to the struggle for national existence. The machinery of administration was out of date and complicated by the authority of feudal and ecclesiastical courts. The supremacy of the Crown, though recognized, was still unstable. It was Diniz who initiated the needful reforms. He earned his title of the *rei lavrador* or "farmer king" by introducing improved methods of cultivation and founding agricultural schools. He encouraged maritime trade by negotiating a commercial treaty with England (1294) and forming a royal navy (1317) under the command of a Genoese admiral named Emmanuele di Pezagna (Manoel Pessanha). In 1290 he founded the university of Coimbra (*q.v.*). He was a poet and a patron of literature and music (see *Literature*, below). His chief administrative reforms were designed to secure centralized government and to limit the jurisdiction of feudal courts. He encouraged and nationalized the military orders. In 1200 the Portuguese knights of São Thiago (Santiago) were definitely separated from the parent Spanish order. The orders of Crato and of St Benedict of Aviz had already been established, the traditional dates of their incorporation being 1113 and 1162. After the condemnation of the Templars by Pope Clement V. (1312) an ecclesiastical commission investigated the charges against the Portuguese branch of the order, and found in its favour. As the Templars were rich, influential and loyal, Diniz took advantage of the death of Clement V. to maintain the order under a new name; the Order of Christ, as it was henceforth called, received the benediction of the pope in 1319 and subsequently played an important part in the colonial expansion of Portugal.

Alphonso IV. adhered to the matrimonial policy initiated by Diniz. He arranged that his daughter Maria should wed Alphonso XI. of Castile (1328), but the marriage **Alphonso IV., 1325-1357.** precipitated the war it was intended to avert, and peace was only restored (1330) after Queen Isabella had again intervened. Pedro, the crown prince, afterwards

married Constance, daughter of the duke of Peñafiel (near Valladolid), and Alphonso IV. brought a strong Portuguese army to aid the Castilians against the Moors of Granada and their African allies. In the victory won by the Christians on the banks of the river Salado, near Tarifa, he earned his title of Alphonso the Brave (1340). In 1347 he married his daughter Leonora

¹Throughout this article the abbreviation *D.* is used for the Portuguese title *Dom* and for its feminine form *Dona* (see *DOMINUS*).

(Lenor) to Pedro IV. of Aragon. The later years of his reign were darkened by the tragedy of Inez de Castro (*q.v.*). He died in 1357, and the first act of his successor, Pedro the Severe,

Pedro I., 1357-1367. was to take vengeance on the murderers of Inez. Throughout his reign he strengthened the central government at the expense of the aristocracy and the Church, by a stern enforcement of law and order. In 1361, at the cortes of Elvas, it was enacted that the privileges of the clergy should only be deemed valid in so far as they did not conflict with the royal prerogative. Pedro maintained friendly relations with England, where in 1352 Edward III. issued a proclamation in favour of Portuguese traders, and in 1353 the Portuguese envoy Affonso Martins Alho signed a covenant with the merchants of London, guaranteeing mutual good faith in all commercial dealings.

The foreign policy of Diniz, Alphonso IV. and Pedro I. had been, as a rule, successful in its main object, the preservation of peace with the Christian kingdoms of Spain; in consequence, the Portuguese had advanced in prosperity and culture. They had supported the monarchy because it was a national institution, hostile to the tyranny of nobles and clergy. During the reign of Ferdinand (1367-1383) and under the regency of Leonora the ruling dynasty ceased to represent the national will; the Portuguese people therefore made an end of the dynasty and chose its own ruler. The complex events which brought about this crisis may be briefly summarized.

Ferdinand, a weak but ambitious and unscrupulous king, claimed the thrones of Castile and Leon, left vacant by the death of Pedro I. of Castile (1369); he based his claim on the fact that his grandmother Beatrice belonged to the legitimate line of Castile. When the majority of the Castilian nobles refused to accept a Portuguese sovereign, and welcomed Henry of Trastamara (see SPAIN: *History*), as Henry II. of Castile, Ferdinand allied himself with the Moors and Aragonese; but in 1371 Pope Gregory XI. intervened, and it was decided that Ferdinand should renounce his claim and marry Leonora, the daughter of his successful rival. Ferdinand, however, preferred his Portuguese mistress, Leonora Telles de Menezes, whom he eventually married. To avenge this slight, Henry of Castile invaded Portugal and besieged Lisbon. Ferdinand appealed to John of Gaunt, who also claimed the throne of Castile, on behalf of his wife Constance, daughter of Pedro I. of Castile. An alliance between Portugal and England was concluded; and although Ferdinand made peace with Castile in 1374, he renewed his claim in 1380, after the death of Henry of Castile, and sent João Fernandes Andeiro, count of Ourem, to secure English aid. In 1381 Richard II. of England despatched a powerful force to Lisbon, and betrothed his cousin Prince Edward to Beatrice, only child of Ferdinand, who had been recognized as heiress to the throne by the cortes of Leiria (1376). In 1383, however, Ferdinand made peace with John I. of Castile at Salvaterra, deserting his English allies, who retaliated by ravaging part of his territory. By the treaty of Salvaterra it was agreed that Beatrice should marry John I. Six months later Ferdinand died, and in accordance with the terms of the treaty Leonora became regent until the eldest son of John I. and Beatrice should be of age.

Leonora had long carried on an intrigue with the count of Ourem, whose influence was resented by the leaders of the aristocracy, while her tyrannical rule also aroused bitter opposition. The malcontents chose D. John, grand-master of the knights of Aviz and illegitimate son of Pedro the Severe, as their leader, organized a revolt in Lisbon, and assassinated the count of Ourem within the royal palace (Dec. 6, 1383). Leonora fled to Santarem and summoned aid from Castile, while D. John was proclaimed defender of Portugal. In 1384 a Castilian army invested Lisbon, but encountered a heroic resistance, and after five months an outbreak of plague compelled them to raise the siege. John I. of Castile, discovering or alleging that Leonora had plotted to poison him, imprisoned her in a convent at Tordesillas, where

she died in 1386. Before this, Nuno Alvares Pereira, constable of Portugal, had gained his popular title of "The Holy Constable" by twice defeating the invaders, at Atoleiro and Trancoso in the district of Guarda.

On the 16th of April 1385 the cortes assembled at Coimbra declared the crown of Portugal elective, and at the instance of João das Regras, the chancellor, D. John was chosen king. No event in the early constitutional history of Portugal is more important than this election, which definitely affirmed the national character of the monarchy. The choice of the grand-master of Aviz ratified the old alliance between the Crown and the military orders; his election by the whole cortes not only ratified the alliance between the Crown and the commons, but also included the nobles and the Church. The nation was unanimous.

Ferdinand had been the last legitimate descendant of Count Henry of Burgundy. With John I. began the rule of a new dynasty, the House of Aviz. The most urgent matter which confronted the king—or the group of statesmen, led by João das Regras and the "Holy Constable" who inspired his policy—was the menace of Castilian aggression. But on the 14th of August 1385 the Portuguese army, aided by 500 English archers, utterly defeated the Castilians at Aljubarrota. By this victory the Portuguese showed themselves equal in military power to their strongest rivals in the Peninsula. In October the "Holy Constable" won another victory at Valverde; early in 1386 5000 English soldiers, under John of Gaunt, reinforced the Portuguese; and by the treaty of Windsor (May 9, 1386), the alliance between Portugal and England was confirmed and extended. Against such a combination the Castilians were powerless; a truce was arranged in 1387 and renewed at intervals until 1411, when peace was concluded. D. Diniz, eldest son of Inez de Castro, claimed the throne and invaded Portugal in 1398, but his supporters were easily crushed. The domestic and foreign policy pursued by John I. until his death in 1433 may be briefly described. At home he endeavoured to reform administration, to encourage agriculture and commerce, and to secure the loyalty of the nobles by grants of land and privileges so extensive that, towards the end of his reign, many nobles who exercised their full feudal rights had become almost independent princes. Abroad, he aimed at peace with Castile and close friendship with England. In 1387 he had married Philippa of Lancaster, daughter of John of Gaunt; Richard II. sent troops to aid in the expulsion of D. Diniz; Henry IV., Henry V. and Henry VI. of England successively ratified the treaty of Windsor; Henry IV. made his ally a knight of the Garter in 1400. The convent of Batalha (*q.v.*), founded to commemorate the victory of Aljubarrota, is architecturally a monument of the English influence prevalent at this time throughout Portugal.

The cortes of Coimbra, the battle of Aljubarrota and the treaty of Windsor mark the three final stages in the consolidation of the monarchy. A period of expansion oversea began in the same reign, with the capture of Ceuta in Morocco. The three eldest sons of King John and Queen Philippa—Edward, Pedro and Henry, afterwards celebrated as Prince Henry the Navigator—desired to win knighthood by service against the Moors, the historic enemies of their country and creed. In 1415 a Portuguese fleet, commanded by the king and the three princes, set sail for Ceuta. English men-at-arms were sent by Henry V. to take part in the expedition, which proved successful. The town was captured and garrisoned, and thus the first Portuguese outpost was established on the mainland of Africa.

3. *The Period of Discoveries: 1415-1499.*—Before describing in outline the course of the discoveries which were soon to render Portugal the foremost colonizing power in Europe it is necessary to indicate the main causes which contributed to that result. As the south-westernmost of the free peoples of Europe, the Portuguese were the natural inheritors of that work of exploration which had been carried on during the middle ages,

Cortes of Coimbra.

John I., 1385-1433.

chiefly by the Arabs. They began where the Arabs left off, by penetrating far into the Atlantic. The long littoral of their country, with its fine harbours and rivers flowing westward to the ocean, had been the training-ground of a race of adventurous seamen. It was impossible, moreover, to expand or reach new markets except by sea: the interposition of Castile and Aragon, so often hostile, completely prevented any intercourse by land between Portugal and other European countries. Consequently the Portuguese merchants sent their goods by sea to England, Flanders, or the Hanse towns. The whole history of the nation had also inspired a desire for fresh conquests among its leaders. Portugal had won and now held its independence by the sword. The long struggle to expel the Moors, with the influence of foreign Crusaders and the military orders, had given a religious sanction to the desire for martial fame. Nowhere was the ancient crusading spirit so active a political force. To make war upon Islam seemed to the Portuguese their natural destiny and their duty as Christians.

It was the genius of Prince Henry the Navigator (*q.v.*) that co-ordinated and utilized all these tendencies towards expansion. Prince Henry placed at the disposal of his captains the vast resources of the Order of **Prince Henry the Navigator.** Christ, the best information and the most accurate instruments and maps which could be obtained. He sought to effect a junction with the half-fabulous Christian Empire of "Prester John" by way of the "Western Nile," *i.e.* the Senegal, and, in alliance with that potentate, to crush the Turks and liberate Palestine. The conception of an ocean route to India appears to have originated after his death. On land he again defeated the Moors, who attempted to re-take Ceuta in 1418; but in an expedition to Tangier, undertaken in 1436 by King Edward (1433-1438), the Portuguese army was defeated, and could only escape destruction by surrendering as a hostage Prince Ferdinand, the king's youngest brother. Ferdinand, known as "the Constant," from the fortitude with which he endured captivity, died unransomed in 1443. By sea Prince Henry's captains continued their exploration of Africa and the Atlantic. In 1433 Cape Bojador was doubled; in 1434 the first consignment of slaves was brought to Lisbon; and slave trading soon became one of the most profitable branches of Portuguese commerce. The Senegal was reached in 1445, Cape Verde was passed in the same year, and in 1446 Alvaro Fernandes pushed on almost as far as Sierra Leone. This was probably the farthest point reached before the Navigator died (1460). Meanwhile colonization progressed in the Azores and Madeira, where sugar and wine were produced; above all, the gold brought home from Guinea stimulated the commercial energy of the Portuguese. It had become clear that, apart from their religious and scientific aspects, these voyages of discovery were highly profitable. Under Alphonso V., surnamed the African (1443-1481), the Gulf of Guinea was explored as far as Cape St Catherine, and three expeditions (1458, 1461, 1471) were sent to Morocco; in 1471 Arzila (Asila) and Tangier were captured from the Moors. Under John II. (1481-1495) the fortress of São Jorge da Mina, the modern Elmina (*q.v.*), was founded for the protection of the Guinea trade in 1481-1482; **Exploration under Alphonso V. and John II.** Diogo Cam (*q.v.*), or Cão, discovered the Congo in 1482 and reached Cape Cross in 1486; Bartholomeu Diaz (*q.v.*) doubled the Cape of Good Hope in 1488, thus proving that the Indian Ocean was accessible by sea. After 1492 the discovery of the West Indies by Columbus rendered desirable a delimitation of the Spanish and Portuguese spheres of exploration. This was accomplished by the treaty of Tordesillas (June 7, 1494) which modified the delimitation authorized by Pope Alexander VI. in two bulls issued on the 4th of May, 1493. The treaty gave to Portugal all lands which might be discovered east of a straight line drawn from the Arctic Pole to the Antarctic, at a distance of 370 leagues west of Cape Verde. Spain received the lands discovered west of this line. As, however, the known means of measuring longitude were so inexact that the line of demarcation could not in practice be determined (see J. de Andrade Corvo in *Journal*

das Sciencias Mathematicas, xxxi. 147-176, Lisbon, 1881), the treaty was subject to very diverse interpretations. On its provisions were based both the Portuguese claim to Brazil and the Spanish claim to the Moluccas (see MALAY ARCHIPELAGO: *History*). The treaty was chiefly valuable to the Portuguese as a recognition of the prestige they had acquired. That prestige was enormously enhanced when, in 1497-1499, Vasco da Gama (*q.v.*) completed the voyage to India.

While the Crown was thus acquiring new possessions, its authority in Portugal was temporarily overshadowed by the growth of aristocratic privilege. At the cortes of Evora (1433) King Edward had obtained the enactment of a law¹ declaring that the estates granted by John I. to his adherents could only be inherited by the direct male descendants of the grantees, and failing such descendants, should revert to the Crown. After the death of Edward further attempts to curb the power of the nobles were made by his brother, D. Pedro, duke of Coimbra, who acted as regent during the minority of Alphonso V. (1438-1447). The head of the aristocratic opposition was the duke of Braganza, who contrived to secure the sympathy of the king and the dismissal of the regent. The quarrel led to civil war, and in May 1449 D. Pedro was defeated and killed. Thenceforward the grants made by John I. were renewed, and extended on so lavish a scale that the Braganza estates alone comprised about a third of the whole kingdom. An unwise foreign policy simultaneously injured the royal prestige, for Alphonso married his own niece, Joanna, daughter of Henry IV. of Castile, and claimed that kingdom in her name. At the battle of Toro, in 1476, he was defeated by Ferdinand and Isabella, and in 1478 he was compelled to sign the treaty of Alcantara, by which Joanna was relegated to a convent. His successor, John II. (1481-1495) reverted to the policy of matrimonial alliances with Castile and friendship with England. Finding, as he said, that the liberality of former kings had left the Crown "no estates except the high roads of Portugal," he determined to crush the feudal nobility and seize its territories. A cortes held at Evora (1481) empowered judges nominated by the Crown to administer justice in all feudal domains. The nobles resisted this infringement of their rights; but their leader, Ferdinand, duke of Braganza, was beheaded for high treason in 1483; in 1484 the king stabbed to death his own brother-in-law, Ferdinand, duke of Vizeu; and 80 other members of the aristocracy were afterwards executed. Thus John "the Perfect," as he was called, assured the supremacy of the Crown. He was succeeded in 1495 by Emanuel (Manoel) I., who was named "the Great" or "the Fortunate," because in his reign the sea route to India was discovered and a Portuguese Empire founded.

4. *The Portuguese Empire: 1499-1580.*—In 1500 King Emanuel assumed the title "Lord of the conquest, navigation and commerce of India, Ethiopia, Arabia and Persia," which was confirmed by Pope Alexander VI. in 1502. It was now upon schemes of conquest that the energy of the nation was to be concentrated, although the motives which called forth that energy were unchanged. "We come to seek Christians and spices," said the first of Vasco da Gama's sailors who landed in India: and the combination of missionary ardour with commercial enterprise which had led to the exploration of the Atlantic led also to the establishment of a Portuguese Empire. This expansion of national interests proceeded rapidly in almost every quarter of the known world. In the North Atlantic Gaspar and Miguel Corte-Real penetrated as far as Greenland (their "Labrador") in 1500-1501; but these voyages were politically and commercially unimportant. Equally barren was the intermittent fighting in Morocco, which was regarded as a crusade against the Moors. In the South Atlantic, however, the African coast was further explored, new settlements were founded, and a remarkable development of Portuguese-African civilization took place in the kingdom of Kongo (see ANGOLA).

¹ Known as the *lei mental*, because it was supposed to fulfil the intention which John I. had in mind when the grants were made.

Pedro Alvares Cabral, sailing to India, but steering far westward to avoid the winds and currents of the Guinea coast, reached Brazil (1500) and claimed it for his sovereign. João da Nova discovered Ascension (1501) and St Helena (1502); Tristão da Cunha was the first to sight the archipelago still known by his name (1506). In East Africa the small Mahomedan states along the coast—Sofala, Mozambique, Kilwa, Brava, Mombasa, Malindi—either were destroyed or became subjects or allies of Portugal. Pedro de Covilham had reached Abyssinia (*q.v.*) as early as 1490; in 1520 a Portuguese embassy arrived at the court of “Prester John,” and in 1541 a military force was sent to aid him in repelling a Mahomedan invasion. In the Indian Ocean and Arabian Sea, one of Cabral’s ships discovered Madagascar (1501), which was partly explored by Tristão da Cunha (1507); Mauritius was discovered in 1507, Socotra occupied in 1506, and in the same year D. Lourenço d’Almeida visited Ceylon. In the Red Sea Massawa was the most northerly point frequented by the Portuguese until 1541, when a fleet under Estevão da Gama penetrated as far as Suez. Hormuz, in the Persian Gulf, was seized by Alphonso d’Albuquerque (1515), who also entered into diplomatic relations with Persia. On the Asiatic mainland the first trading-stations were established by Cabral at Cochin and Calicut (1501); more important, however, were the conquest of Goa (1510) and Malacca (1511) by Albuquerque, and the acquisition of Diu (1535) by Martim Affonso de Sousa. East of Malacca, Albuquerque sent Duarte Fernandes as envoy to Siam (1511), and despatched to the Moluccas two expeditions (1512, 1514), which founded the Portuguese dominion in the Malay Archipelago (*q.v.*). Fernão Pires de Andrade visited Canton in 1517 and opened up trade with China, where in 1557 the Portuguese were permitted to occupy Macao. Japan, accidentally discovered by three Portuguese traders in 1542, soon attracted large numbers of merchants and missionaries (see JAPAN, § viii.). In 1522 one of the ships of Ferdinand Magellan (*q.v.*)—a Portuguese sailor, though in the Spanish service—completed the first voyage round the world.

Up to 1505 the Portuguese voyages to the East were little more than trading ventures or plundering raids, although a few “factories” for the exchange of goods were founded in Malabar. In theory, the objects of *Almeida and Albuquerque*. King Emanuel’s policy were the establishment of friendly commercial relations with the Hindus (who were at first mistaken for Christians “not yet confirmed in the faith,” as the king wrote to Alexander VI.) and the prosecution of a crusade against Islam. But Hindu and Mahomedan interests were found to be so closely interwoven that this policy became impracticable, and it was superseded when D. Francisco d’Almeida (*q.v.*) went to India as first Portuguese viceroy in 1505. Almeida sought to subordinate all else to sea power and commerce, to concentrate the whole naval and military force of the kingdom on the maintenance of maritime ascendancy; to annex no territory, to avoid risking troops ashore, and to leave the defence of such factories as might be necessary to friendly native powers, which would receive in return the support of the Portuguese fleet. Almeida’s statesmanship was to a great extent sound. The Portuguese could never penetrate far inland; throughout the 16th century their settlements were confined to the coasts of Asia, Africa or America, and the area they were able effectively to occupy was far less than the area of their empire in the 20th century. A Chinese critic, quoted by Faria y Sousa, said of them that they were like fishes, “remove them from the water and they straightway die.” It is thus absurd to speak of a “Portuguese conquest of India”; in a land campaign they would have been outnumbered and destroyed by the armies of any one of the greater Indian states. But their artillery and superior maritime science made them almost invulnerable at sea, and their principal military achievements consisted in the capture or defence of positions accessible from the sea, *e.g.* the defence of Cochin by Duarte Pacheco Pereira in 1504, the defence of Diu (*q.v.*) in 1538 and 1546.

Alphonso d’Albuquerque (*q.v.*), who succeeded Almeida in

1509, found it necessary to modify the policy formulated by his predecessor. Command of the sea could not be maintained—least of all in the monsoon months—while the Portuguese fleets were based on Lisbon, which could only be reached after a six months’ voyage; and experience had proved that almost every Portuguese factory required a fortress for its defence when the fleets were absent. Portugal, like every great maritime trading community from Carthage to Venice, discovered that the ideal of “sea power and commerce” led directly to empire. In 1510 Albuquerque seized Goa, primarily as a naval base, and in so doing recognized the fact that his country was committed to a policy of territorial aggrandisement. Other sea-ports and islands were conquered or colonized in rapid succession, and by 1540 Portugal had acquired a line of scattered maritime possessions extending along the coasts of Brazil, East and West Africa, Malabar, Ceylon, Persia, Indo-China and the Malay Archipelago. The most important settlements in the East were Goa, Malacca and Hormuz.

To a superficial observer the prosperity of Portugal might well seem to have culminated during this period of expansion. Vast profits were derived from the import trade in the innumerable products of the tropics, of which Portugal was the sole purveyor in Europe. This influx of wealth furnished the economic basis for a sudden development of literary and artistic activity, inspired by contrast with the new world of the tropics. The 16th century was the golden age of Portuguese literature; humanists, such as Damião de Goes (*q.v.*), and scientists, such as the astronomer Pedro Nunes (Nonius), played conspicuous parts in the great intellectual movements of the time; a distinctive school of painters arose, chief among them being the so-called “Grão Vasco” (Vasco Fernandes of Vizeu); in architecture the name of King Emanuel was given to a new and composite style (the Manoeline or Manoellian), in which decorative forms from India and Africa were harmonized with Gothic and Renaissance designs; palaces, fortresses, cathedrals, monasteries, were built on a scale never before attempted in Portugal; and even in the minor arts and handicrafts—in goldsmith’s work, for example, or in pottery—the influence of the East made itself felt. Oriental splendour and Renaissance culture combined to render social life in Lisbon hardly less brilliant than in Rome or Venice.

In order to understand the apparently sudden collapse of Portuguese power in 1578–1580 it is necessary to examine certain facts and tendencies which from the first rendered a catastrophe inevitable. Chief among these were the extent of the empire and its organization, the financial and commercial policy of its rulers, the hostility, often wantonly provoked, of the chief Oriental states, the depopulation of Portugal and the slave trade, the expulsion of the Jews, the growth of ecclesiastical influence in secular affairs, and the decadence of the monarchy.

It is necessary to exclude Brazil from any survey of the Portuguese imperial system, because the colonization of Brazil (*q.v.*) was effected on distinctive lines. Otherwise the *Imperial Organization* whole empire was governed on a more or less uniform system, although it included communities of the most diverse nature—protectorates such as Hormuz and Ternate in the Moluccas, colonies such as Goa and Madeira, captaincies under military rule such as Malacca, tributary states such as Kilwa, fortified factories as at Colombo and Cochin. West of the Cape the settlements in Africa and the Atlantic were governed, as a rule, by officials directly nominated by the king. East of the Cape the royal power was delegated to a viceroy or governor—the distinction was purely titular—whose legislative and executive authority was almost unlimited during his term of office. The vicerealty was created in 1505, and from 1511 the Indian capital was Goa. Between 1505 and 1580 only four holders of the office—Almeida (1505–1509), Albuquerque (1509–1515), D. Vasco da Gama (1524) and D. João de Castro (1545–1548)—were men of marked ability and high character. All officials, including the viceroy and naval and military officers, were usually appointed for no more than three years. Although few large

salaries were paid, the perquisites attached to official positions were enormous; at the beginning of the 17th century, for example, the captain of Malacca received not quite £300 yearly as his pay, but his annual profits from other sources were estimated at £20,000. Even judges were expected to live on their perquisites, in the shape of bribes. The competition for appointments was naturally very keen; Couto mentions the case of one grantee who received the reversion of a post to which 30 applicants had a prior claim.¹ Such reversions could be sold, bequeathed, or included in the dowries of married women; the right of trading with China might be part of the endowment of a school; a monastery or a hospital might purchase the command of a fortress. In 1538 the viceroy, D. Garcia de Noronha, publicly sold by auction every vacant appointment in Portuguese India—an example followed in 1614 by the king. Hardly less disastrous than the system by which officials were chosen and paid was the influence exercised by the Church. Simão Botelho, an able revenue officer, was denied absolution in 1543 because he had reorganized the Malacca customs-house without previously consulting the Dominicans in that city. In 1560 a supposed tooth of Buddha was brought to Goa; the raja of Pegu offered £100,000 for the relic, and as Portuguese India was virtually bankrupt the government wished to accept the offer; but the archbishop intervened and the relic was destroyed.

The empire in the East was rarely solvent. Almeida and Albuquerque had hoped to meet the expense of administration mainly out of the fees extorted for safe-conducts at sea and trading-licences, with the tribute wrung from native states and the revenue from Crown lands in India. But the growth of expenditure—chiefly of an unremunerative kind, such as the cost of war and missions—soon rendered these resources inadequate; and after 1515 the empire became ever more dependent on the spoils of hostile states and on subsidies from the royal treasury in Lisbon. Systematic debasement of the coinage was practised both in India, where the monetary system was extremely complex,² and in Portugal; and owing to the bullionist policy adopted by Portuguese financiers little permanent benefit accrued to the mother country from its immense trade. Seeking for commercial profit, not in the exchange of commodities, but solely in the acquisition of actual gold and silver, and realizing that the home market could not absorb a tithe of the merchandise imported, the Lisbon capitalists sent their ships to discharge in Antwerp (where a Portuguese staple was established in 1503), or in some other port near the central markets of Europe. The raw materials purchased by Flemish, German or English traders were used in the establishment of productive industries, while Portugal received a vast influx of bullion, most of which was squandered on war, luxuries or the Church.

In theory the most lucrative branches of commerce, such as the pepper trade, were monopolies vested in the Crown; **Commercial Policy.** the chartered companies and associations of merchant adventurers, which afterwards became the pioneers of British and Dutch colonial development, had no counterpart in Portuguese history, except in the few cases in which trading concessions were granted to military or monastic orders. But the Crown frequently farmed out its monopolies to individual merchants, or granted trading-licences by way of pension or reward. These were often of great value; e.g. in 1612 the right of sending a merchant ship to China was valued at £25,000. Great loss was necessarily inflicted on native traders by the monopolist system, which pressed most hardly on the Mahomedans, who had been the chief carriers in Indian waters. Two great powers, Egypt and Turkey, challenged the naval and commercial supremacy of the Portuguese, but an Egyptian armada was destroyed by Almeida in 1509, and though Ottoman fleets were on several occasions (as in 1517 and 1521) despatched from Suez or Basra, they failed to achieve any success, and the Portuguese were able to close the two principal trade routes

between India and Europe. One of these trade routes passed up the Persian Gulf to Basra, and thence overland to Tripoli, for Mediterranean ports, and to Trebizond, for Constantinople. The other passed up the Red Sea to Suez, and thence to Alexandria, for Venice, Genoa and Ragusa. But by occupying Hormuz the Portuguese gained command of the Gulf route; and though they thrice failed to capture Aden (1513, 1517, 1547), and so entirely to close the Red Sea, they almost destroyed the traffic between India and Suez by occupying Socotra and sending fleets to cruise in the Strait of Bab el-Mandeb. In Malacca they possessed the connecting link between the trade-routes of the Far and Middle East, and thus they controlled the three sea-gates of the Indian Ocean and Arabian Sea—the Straits of Hormuz, Bab el-Mandeb and Malacca—and diverted the maritime trade with Europe to the Cape route.

During the critical period in which their empire was being established (c. 1505–1550) the Portuguese were fortunate in escaping conflict with any Oriental power of the first rank except Egypt and Turkey; for the Bahmani **Relations with Oriental States.** sultanate of the Deccan had been already disintegrated before 1498, and the Mughals and Mahrattas were still far off. A coalition of the minor Mahomedan states was prevented by the great Hindu kingdom of Vijayanagar, which comprised the southern half of the Indian Peninsula. Vijayanagar gave the militant Mahomedanism of Northern India no opportunity for a combined attack on the Portuguese settlements. After 1565, when the power of Vijayanagar was broken at the battle of Talikot, a Mussulman coalition was at last formed, and the Portuguese were confronted by a line of hostile states stretching from Gujarat to Achin; but by this time they were strong enough to hold their own. It is characteristic of their native policy that they had not only refrained from aiding Vijayanagar in 1565, but had even been willing to despoil their Hindu allies. In 1543 Martim Afonso de Sousa, governor of India, organized an expedition to sack the Hindu temples at Conjeveram in Vijayanagar itself, and similar incidents are common in Indo-Portuguese history. Albuquerque was almost the only Portuguese statesman who strove to deal justly with both Hindus and Mahomedans, to respect native customs, and to establish friendly relations with the great powers of the East. Apart from the rigorous restrictions imposed by his successors upon trade, the sympathies of the natives were estranged by the harshness and venality of Portuguese administration, by such barbarities as the wholesale mutilation of non-combatants in war-time, and by religious persecution. After the arrival of the Franciscan missionaries, in 1517, Goa gradually became the headquarters of an immense proselytizing organization, which by 1561 had extended to East Africa, China, Japan and the Malay Archipelago (see GOA: *Ecclesiastical History*). Wherever the Portuguese were supreme they endeavoured to obtain converts by force. The widespread resentment thus aroused was a frequent cause of insurrection, and between 1515 and 1580 not a single year passed without war between the Portuguese and at least one African or Asiatic people.

Centuries of fighting against the Moors and Castilians had already left Portugal thinly populated; large tracts of land were uncultivated, especially in Alemtejo, and wolves **Depopulation.** were still common throughout the kingdom. It was impossible, from the first, to garrison the empire with trained men. As early as 1505 one of Almeida's ships contained a crew of rustics unable to distinguish between port and starboard; soon afterwards it became necessary to recruit convicts and slaves, and in 1538 a royal pardon was granted to all prisoners who would serve in India, except criminals under sentence for treason and canonical offences. Linschoten estimates that of all those who went to the East not one in ten returned. The heaviest losses were due to war, shipwreck and tropical diseases, but large numbers of the underpaid or unpaid soldiers deserted to the armies of native states. It is impossible to give more than approximately accurate statistics of the resultant depopulation of Portugal; but it seems probable that the inhabitants of the kingdom decreased from about 1,800,000 or 2,000,000 in 1500 to

¹ *Decadas*, XII. i. 10.

² See R. S. Whiteway, *Rise of the Portuguese Power*, &c. (London, 1898), pp. 67–72.

about 1,080,000 in 1586. The process of decay was hastened by frequent outbreaks of plague, sometimes followed by famine; a contemporary manuscript estimates that no fewer than 500 persons died daily in Lisbon alone during July, August and September 1569, and in some other years the joint effects of plague and famine were little less disastrous.

While the country was being drained of its best citizens, hordes of slaves were imported to fill the vacancies, especially into the southern provinces.¹ Manual labour was thus discredited; the peasants sold their farms and emigrated or flocked to the towns; and small holdings were merged into vast estates, unscientifically cultivated by slaves and comparable with the *latifundia* which caused so many agrarian evils during the last two centuries of the Roman republic. The decadence of agriculture partly explains the prevalence of famine at a time when Portuguese maritime commerce was most prosperous. The Portuguese intermarried freely with their slaves, and this infusion of alien blood profoundly modified the character and physique of the nation. It may be said without exaggeration that the Portuguese of the "age of discoveries" and the Portuguese of the 17th and later centuries were two different races. Albuquerque, foreseeing the dangers that would arise from a shortage of population in his colonies, had encouraged his soldiers to marry captive Brahman and Mahomedan women, and to settle in India as farmers, shopkeepers or artisans. Under his rule the experiment was fairly successful, but the married colonists afterwards became a privileged caste, subsisting upon the labour of their slaves, and often disloyal to their rulers. Intermarriage led to the adoption, even by the rich, and especially by women (see GOA), of Asiatic dress, manners and modes of thought. Thus in the East, as in Europe, slavery reacted upon every class of the Portuguese.

The banishment, or forcible conversion, of the Jews deprived Portugal of its middle class and of its most scientific traders and financiers. Though the Jews had always been compelled to reside in separate quarters called *Juderías*, or Jewries, they had been protected by the earlier Portuguese kings. Before 1223 their courts had received autonomy in civil and criminal jurisdiction; their chief rabbi was appointed by the king and entitled to use the royal arms on his seal. Alphonso V. even permitted his Jewish subjects to live outside the *Juderías*, relieved them from the obligation to wear a distinctive costume (enforced in 1325), and nominated a Jew, Isaac Abrabanel (*q.v.*), as his minister of finance. In culture the Portuguese Jews surpassed their rulers. Many of them were well versed in Aristotelian and Arabic philosophy, in astronomy, mathematics, and especially in medicine. Three Hebrew printing-presses were established between 1487 and 1495; both John II. and Emanuel I. employed Jewish physicians; it was a Jew—Abraham Zacuto ben Samuel—who supplied Vasco da Gama with nautical instruments; and Jews were employed in the overland journeys by which the Portuguese court first endeavoured to obtain information on Far Eastern affairs. The Jews paid taxes on practically every business transaction, besides a special poll-tax of 30 *dinheiros* in memory of the 30 pieces of silver paid to Judas Iscariot; and for this reason they were protected by the Crown. For centuries they were also tolerated by the commons; but the other orders—ecclesiastics and nobles—resented their religious exclusiveness or envied their wealth, and gradually fostered the growth of popular prejudice against them. In 1449 the Lisbon *Juderías* were stormed and sacked, and between 1450 and 1481 the cortes four times petitioned the Crown to enforce the anti-Jewish provisions of the canon law. John II. gave asylum to 90,000 Jewish refugees from Castile, in return for a heavy poll-tax and on condition that they should leave the country within eight months, in ships furnished by himself. These ships were not provided in time, and the Jews who were thus unable to depart were enslaved,

¹ In the north, which had been relatively immune from wars agriculture was more prosperous and the peasants more tenacious of their land; hence the continuance of peasant proprietorship and the rarity of African types between the Douro and the Minho.

while their children were deported to the island of St Thomas, and there left to survive as best they might. In 1496 Emanuel I. desired to wed Isabella, daughter of Ferdinand and Isabella, but found that he was first required to purify his kingdom of the Jews, who were accordingly commanded to leave Portugal before the end of October 1497. But in order to avoid the economic dangers threatened by such an exodus, every Jew and Jewess between the ages of 4 and 24 was seized and forcibly baptized (19th March): "Christians" were not required to emigrate. In October 20,000 adults were treated in the same way. These "New Christians" or "Maranos," as they were called, were forbidden to leave the country between 1498 and 1507. In April 1506 most of those who resided in Lisbon were massacred during a riot, but throughout the rest of Emanuel's reign they were immune from violence, and were again permitted to emigrate—an opportunity of which the majority took advantage. Large numbers settled in Holland, where their commercial talent afterwards greatly assisted the Dutch in their rivalry with the Portuguese.

The Reformation never reached Portugal, but even here the critical tendencies which elsewhere preceded Reform, were already at work. Their origin is to be sought not so much in the Revival of Learning as in the fact that the Portuguese had learned, on their voyages of discovery, to see and think for themselves. The true scientific spirit may be traced throughout the *Roteiros* of D. João de Castro (*q.v.*) and the *Colloquios* of Garcia de Orta—men who deserted books for experiment and manifested a new interest in the physical world. But orthodox churchmen feared that even in Portugal this appeal from authority to experience would lead to an attack upon religious doctrines previously regarded as beyond criticism. To check this dangerous movement of ideas, they demanded the introduction of the Inquisition into Portugal. The agents of the "New Christians" in Rome long contrived, by lavish bribery and with the support of many enlightened Portuguese, to delay the preliminary negotiations; but in 1536 the Holy Office was established in Lisbon, where the first *auto-da-fé* was held in 1540, and in 1560 its operations were extended to India. It seems probable that the influence of the tribunal upon Portuguese life and thought has been exaggerated. *Autos-da-fé* were rare events; their victims were not as a rule serious thinkers, but persons accused of sorcery or Judaizing, nor were they more numerous than the victims of the English laws relating to witchcraft and heresy. But the worst vices of the Inquisition were the widespread system of delation it encouraged by paying informers out of the property of the condemned, and its action as a trading and landholding association. Quite as serious, in their effects upon national life, were the severe censorship to which all printed matter was liable before publication and the control of education by the Jesuits. Poetry and imaginative literature usually escaped censure; but histories were mutilated and all original scientific and philosophical work was banned. Portuguese education centred in the national university of Coimbra, which had long shown itself ready to assimilate new ideas; between 1537 and 1547 John III. persuaded many eminent foreign teachers—among them the Scottish humanist George Buchanan (*q.v.*) and the French mathematician Élie Vinet—to lecture in its schools. But the discipline of the university needed reform, and the task was entrusted to the Jesuits. By 1555 they had secured control over Coimbra—a control which lasted for two centuries and extended to the whole educational system of the country. The effects of this change upon the national character were serious and permanent. Portugal sank back into the middle ages. The old initiative and self-reliance of the nation, already shaken by years of disaster, were now completely undermined, and the people submitted without show of resistance to a theocracy disguised as absolute monarchy.

Emanuel I. had been a fearless despot, such as Portugal needed if its scattered dependencies were to remain subject to the central government. During his reign (1495–1521) the Church was never permitted to encroach upon the royal

The Slave Trade.

The Inquisition and the Jesuits.

prerogative. He even sent ambassadors to Rome to protest against ecclesiastical corruption, as well as to checkmate the Venetian diplomatists who threatened Europe with Ottoman vengeance if the Portuguese commercial monopoly were not relaxed. The Oriental magnificence of these embassies, notably that of 1514, and the fact that a king of Portugal dared openly to criticize the morals of the Vatican, temporarily enhanced the prestige of the monarchy. But Emanuel I. was the last great king of the Aviz dynasty. He had pursued the traditional policy of intermarriage with the royal families of Castile and Aragon, hoping to weld together the Spanish and Portuguese dominions into a single world-wide

“Sebastianism” became a religion; its votaries were numbered by thousands, and four impostors arose in succession, each claiming to be the *rei encuberto*, or “hidden king,” whose advent was so ardently desired (see SEBASTIAN).

There was no surviving prince of the Aviz dynasty except the aged, feeble and almost insane Cardinal Prince Henry, who, as a younger son of Emanuel I., now became king. Henry died on the 31st of January 1580, and the throne was thus left vacant. There were five principal claimants—Philip II. of Spain; Philibert, duke of Savoy; Antonio, prior of Crato; Catherine, duchess of Braganza; and Ranuccio, duke of Parma—whose relationship to Emanuel I. is shown in the following table:—

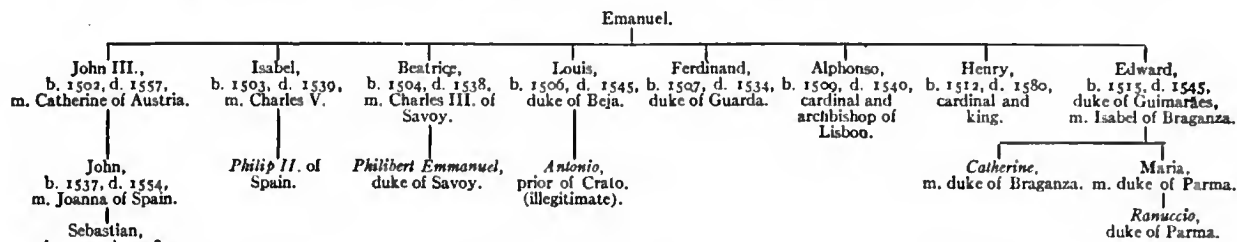

empire ruled by the house of Aviz. His ambition narrowly missed fulfilment, for Prince Miguel, his eldest son, was recognized (1498) as heir to the Spanish thrones. But Miguel died in infancy, and his inheritance passed to the Habsburgs. Frequent intermarriage, often so far within the prohibited degree as to require a papal dispensation, may possibly explain the weakened vitality of the Portuguese royal family, which was now subject to epilepsy, insanity and premature decay. The decadence of the monarchy as a national institution was reflected in the decadence of the cortes, which was rarely summoned between 1521 and 1580. John III. (1521-1557) was a ruler of fair ability, who became in his later years wholly subservient to his ecclesiastical advisers. He was succeeded by his grandson Sebastian (1557-1578), aged three years. Until the king came of age (1568), his grandmother, Queen Catherine, a fanatical daughter of Isabella the Catholic, and his great-uncle, Prince Henry, cardinal and inquisitor-general, governed as joint regents. Both were dominated by their Jesuit confessors, and a Jesuit, D. Luiz Gonçaves da Camara, became the tutor and, after 1568, the principal adviser of Sebastian.

The king was a strong-willed and weak-minded ascetic, who entrusted his empire to the Jesuits, refused to marry, although the dynasty was threatened with extinction, and spent years in preparing for a crusade against the **The Disaster of Al Kasr.** Moors. The wisest act of John III. had been his withdrawal of all the Portuguese garrisons in Morocco except those at Ceuta, Arzila and Tangier. Sebastian reversed this policy. His first expedition to Africa (1574) was a mere reconnaissance, but four years later a favourable opportunity for invasion arrived. A dethroned sultan of Morocco, named Mulai Ahmad (Mahommed XI.), offered to acknowledge Portuguese suzerainty if he were restored to the throne by Portuguese arms, and Sebastian eagerly accepted these terms. The flower of his army was in Asia and his treasury was empty; but he contrived to extort funds from the “New Christians,” and collected a force of some 18,000 men, chiefly untrained lads, worn-out veterans, and foreign free-lances. At Arzila, where he landed, he was joined by Mulai Ahmad, who could only muster 800 soldiers. Thence Sebastian sought to proceed overland to the seaport of El Araish, despite the advice of his ally and of others who knew the country. After a long desert march under an August sun, he took up an indefensible position in a valley near Al Kasr al Kebir (*q.v.*). On the morrow (Aug. 4, 1578) they were surrounded by the superior forces of Abd el Malek, the reigning sultan, and after a brave resistance Sebastian was killed and his army almost annihilated. So overwhelming was the disaster that the Portuguese people refused to believe the truth. It was rumoured that Sebastian still lived, and would sooner or later return and restore the past greatness of his country.

Tentative and hardly serious claims were also put forward by Pope Gregory XIII., as *ex officio* heir-general to a cardinal, and by Catherine de' Medici, as a descendant of Alphonso III. and Matilda of Boulogne.

5. *The “Sixty Years’ Captivity”*: 1581-1640.—The university of Coimbra declared in favour of Catherine, duchess of Braganza, but the prior of Crato was the only rival who offered any serious resistance to Philip II. D. Antonio proclaimed himself king and occupied Lisbon. The advocates of union with Spain, however, were numerous, influential, and ably led by their spokesmen in the cortes, Christovão de Moura and Antonio Pinheiro, bishop of Leiria. The duke of Braganza was won over to their side, chiefly by the promise that he should be king of Brazil if Philip II. became king of Portugal—a promise never fulfilled. Above all, the Church, including the Society of Jesus, naturally favoured the Habsburg claimant, who represented its two foremost champions, Spain and Austria. In 1581 a Spanish army, led by the duke of Alva, entered Portugal and easily defeated the levies of D. Antonio at Alcantara. The prior escaped to Paris and appealed to France and England for assistance. In 1582 a French fleet attempted to seize the Azores in his interest, but was defeated. In 1589 an English fleet was sent to aid the prior in a projected invasion of Portugal, but owing to a quarrel between its commanders, Sir Francis Drake and Sir John Norris, the expedition was abandoned. D. Antonio returned to Paris, where he died in 1594.

Meanwhile the victory of Alcantara left Philip II. supreme in Portugal, where he was soon afterwards crowned king. His constitutional position was defined at the Cortes of Thomar (1581). Portugal was not to be regarded as a conquered or annexed province, but as a separate kingdom, joined to Spain solely by a personal union similar to the union between Castile and Aragon under Ferdinand and Isabella. At Thomar Philip II. promised to maintain the rights and liberties conceded by his predecessors on the Portuguese throne, to summon the Cortes at frequent intervals, and to create a Portuguese privy council which should accompany the king everywhere and be consulted on all matters affecting Portuguese interests. Brazil and the settlements in Africa and Asia were still to belong to Portugal, not to Spain, and neither in Portugal nor in its colonies was any alien to be given lands, public office, or jurisdiction. On these terms the political union of the Iberian Peninsula was accomplished. It was the final stage in a process of accretion dating back to the beginnings of the Christian reconquest in the 8th century. Asturias had been united with Leon, Leon with Castile, Castile with Aragon. All these precedents seemed to indicate that Spain and Portugal would ultimately form one state; and despite the strong nationalism which their separate language and

history had inspired among the Portuguese, the union of 1581 might have endured if the terms of the Thomar compact had been observed. But few of the promises made in 1581 were kept by the three Spanish kings who ruled over Portugal—Philip II. (1581–1598), Philip III. (1598–1621) and Philip IV. (1621–1640).¹ The cortes was only once summoned (1619), and the government of Portugal was entrusted by Philip III. chiefly to Francis duke of Lerma, by Philip IV. chiefly to Olivares (*q.v.*). The kingdom and its dependencies were also involved in the naval disasters which overtook Spain. Faro in Algarve was sacked in 1595 by the English, who ravaged the Azores in 1596; and in many parts of the world English, French and Dutch combined to harass Portuguese trade and seize Portuguese possessions. (See especially BRAZIL; INDIA; MALAY ARCHIPELAGO.) Union with Spain had exposed Portugal to the hostility of the strongest naval powers of western Europe, and had deprived it of the power to conclude an independent peace.

Insurrections in Lisbon (1634) and Evora (1637) bore witness to the general discontent, but until 1640 the Spanish ascendancy was never seriously endangered. In 1640 war with France and a revolution in Catalonia had taxed the military resources of Spain to the utmost. The royal authority in Portugal was delegated to Margaret of Savoy, duchess of Mantua, whose train of Spanish and Italian courtiers aroused the jealousy of the Portuguese nobles, while the harsh rule of her secretary of state, Miguel de Vasconcellos de Brito, provoked the resentment of all classes. Even the Jesuits, whose influence in Portugal had steadily increased since 1555, were now prepared to act in the interests of Cardinal Richelieu, and therefore against Philip IV. A leader was found in John, 8th duke of Braganza, who as a grandson of the duchess Catherine was descended from Emanuel I. The duke, however, was naturally indolent, and it was with difficulty that his ambitious and energetic Castilian wife, D. Luiza de Guzman, obtained his assent to the proposed revolution. He refused to take any active part in it; but D. Luiza and her confidential adviser, João Pinto Ribeiro, recruited a powerful band of conspirators among the disaffected nobles. Their plans were carefully elaborated, and on the 1st of December 1640 various strategic points were seized, the few partisans of Spain who attempted resistance were overpowered, and a provisional government was formed under D. Rodrigo da Cunha, archbishop of Lisbon, who was appointed lieutenant-general of Portugal.

6. *The Restoration: 1640–1755.*—On the 13th of December 1640 the duke of Braganza was crowned as John IV., and on the 19th of January 1641 the cortes formally accepted him as king. The whole country had already declared in his favour and expelled the Spanish garrisons, an example followed by all the Portuguese dependencies. Thus the "Sixty Years' Captivity" came to an end and the throne passed to the house of Braganza. But the Portuguese were well aware that they could hardly maintain their independence without foreign assistance, and ambassadors were at once sent to Great Britain, the Netherlands and France. The struggle between the Crown and the parliament prevented Charles I. from offering aid, but he immediately recognized John IV. as king. Richelieu and the states-general of the Netherlands despatched fleets to the Tagus; but commercial rivalry in Brazil and the East led soon afterwards to a colonial war with the Dutch, and Portugal was left without any ally except France.

The Portuguese armies were at first successful. D. Matheus d'Albuquerque defeated the Spaniards under the baron of Molingen at Montijo (May 26, 1644), and throughout the reign of John IV. (1640–1656) they suffered no serious reverse. But great anxiety was caused by a plot to restore Spanish rule, in which the duke of Caminha and the archbishop of Braga were implicated; and especially by the action of Mazarin, who had assumed control of French foreign policy in 1642. At the congress of Münster (1643) he refused to make the independence of Portugal a condition of

¹ Philip I., II. and III. of Portugal.

peace between France and Spain; and in a letter dated the 4th of October 1647 he even offered the Portuguese Crown to the duke of Longueville—an offer which illustrates the weakness of John IV. and the dependence of Portugal upon France.

John IV. was succeeded by his second son, Alphonso VI. (1656–1683), who was then aged thirteen. During the king's minority the queen-mother, D. Luiza, acted as regent. She prosecuted the war with vigour, and on the 14th of January 1659 a Portuguese army commanded by D. Antonio Luiz de Menezes, count of Cantanhede, defeated the Spaniards under D. Luiz de Haro at Elvas. In March 1659, however, the war between France and Spain was ended by the treaty of the Pyrenees; and D. Luiz de Haro, acting as the Spanish plenipotentiary, obtained the inclusion in the treaty of a secret article by which France undertook to give no further aid to Portugal. Neither Louis XIV. nor Mazarin desired the aggrandisement of Spain at the expense of their own ally; they therefore evaded the secret article by sending Marshal Schomberg to reorganize the Portuguese army (1660), and by helping forward a marriage between Charles II. of England and Catherine of Braganza, the sister of Alphonso VI. This project had been already mooted by D. Luiza, who had foreseen the restoration of the Stuart monarchy, and had in 1650 welcomed the exiled princes Rupert and Maurice at the court of John IV. The dowry to be paid by Portugal was fixed at £500,000 and the cession to Great Britain of Bombay and Tangier. In May 1663 the marriage was celebrated, and thus Great Britain took the place of France as the active ally of Portugal.

Meanwhile, on the 20th of June 1662, the regency had been terminated by a palace revolution. Alphonso VI. declared himself of age and seized the royal authority; D. Schomberg Luiza retired to a convent. The king was feeble and *Castello Melhor* and vicious, but had wit enough to leave the conduct of affairs to stronger hands. D. Luiz de Sousa e Vasconcellos, count of Castello Melhor, directed the policy of the nation while Schomberg took charge of its defence. The army, reinforced by British troops under the earl of Inchiquin and by French and German volunteers or mercenaries, was led in the field by Portuguese generals, who successfully carried out the plans of Schomberg. On the 8th of June 1663 the count of Villa Flor utterly defeated D. John of Austria, and retook Evora, which had been captured by the invaders; on the 7th of July 1664 Pedro de Magalhães defeated the duke of Osuna at Ciudad Rodrigo; on the 17th of June 1665 the marquess of Marialva destroyed a Spanish army led by the marquess of Carraceña at the battle of Montes Claros, and Christovão de Brito Pereira followed up this victory with another at Villa Viçosa. The Spaniards failed to gain any compensating advantage, and on the 13th of February 1668 peace was concluded at Lisbon, Spain at last consenting to recognize the independence of the Portuguese kingdom.

The signature of the treaty of Lisbon had been preceded by another palace revolution. Castello Melhor, hoping to secure further French support for his country, had arranged a marriage between Alphonso VI. and Marie Françoise Elisabeth, daughter of Charles Amadeus of Nemours, and grand-daughter of Henry IV. of France. The marriage, celebrated in 1666, caused the downfall both of Castello Melhor and of the king. Queen Marie detested Alphonso and fell in love with his brother D. Pedro; and after four months of a hated union she left the palace and applied to the chapter of Lisbon cathedral to annul her marriage on the ground of non-consummation. D. Pedro imprisoned the king and assumed the regency; on the 1st of January 1668 his authority was recognized by the cortes; on the 24th of March the annulment of the queen's marriage was pronounced and confirmed by the pope; on the 2nd of April she married the regent. Castello Melhor was permitted to escape to France, while Alphonso VI. was banished to Terceira in the Azores. A conspiracy to restore him to the throne was discovered in 1674, and he was removed to Cintra, where he died in 1683.

Pedro II., who had acted as regent for fifteen years, now

became king. His reign (1683-1706) is a period of supreme importance in the economic and constitutional history of Portugal. The goldfields of Minas Geraes in Brazil, discovered about 1693, brought a vast revenue in royalties to the Crown, which was thus enabled to govern without summoning the cortes to vote supply. In 1697 the cortes met for the last time before the era of constitutional government. Even more important was the change effected when the Whig ministry of Great Britain sent John Methuen to Lisbon to negotiate a commercial agreement. The Methuen Treaty, signed on the 27th of December 1703, detached Portugal from the French alliance, and made her for more than 150 years a commercial and political satellite of Great Britain. Its most far-reaching provisions were those which admitted Portuguese wines to the British market at a lower rate of duty than was imposed upon French and German wines, in return for a corresponding preference to English textiles. The demand for "Port" and "Madeira" was thus artificially stimulated to such an extent that almost the whole productive energy of Portugal was concentrated upon the wine and cork trades. Other industries, including agriculture, were neglected, and even food-stuffs were imported from Great Britain. The disastrous economic results of the treaty were temporarily concealed by the influx of gold from Brazil, the check upon emigration from the wine-growing northern provinces, and the military advantages of alliance with Great Britain. Nor was the virtual abolition of the cortes seriously felt at first, owing to the excellent internal administration of Pedro II. and his minister the duke of Cadaval.

Pedro II. had at first wished to remain neutral in the impending struggle between Philip V. and the archduke Charles, rival claimants for the throne of Spain. But Queen Marie had died in 1683, and in 1687 Cadaval had induced the king to marry Maria Sophia de Neuberg, daughter of the elector-palatine. Louis XIV. of France, who had hoped through the influence of Queen Marie to secure Portuguese support for his own grandson Philip V., realized that this second marriage might thwart his policy, and strove to redress the balance by creating a strong party at the court of Lisbon. He so far succeeded that in 1700 Pedro II. recognized Philip V. as king of Spain and in 1701 protected a French fleet in the Tagus against the British. It was this incident that caused the despatch of the Methuen mission and the renewal of the Anglo-Portuguese alliance in 1703. On the 7th of March 1704 a British fleet under Sir George Rooke reached Lisbon, convoying the archduke Charles and 10,000 British troops, who were joined by a Portuguese army under D. João de Sousa, marquess das Minas, and at once invaded Spain. (For the campaigns of 1704-13, see SPANISH SUCCESSION, WAR OF THE.) In 1705 Pedro II. was compelled by failing health to appoint a regent, and chose his sister, Catherine of Braganza, queen-dowager of England. On the death of the king (Dec. 9, 1706) Cadaval arranged a marriage between his successor John V. (1706-1750) and the archduchess Marianna, sister of the archduke Charles, thus binding Portugal more closely to the Anglo-Austrian cause. The strain of the war was acutely felt in Portugal, especially in 1711, when the French admiral Duguay-Trouin sacked Rio de Janeiro and cut off the Brazilian treasure-ships. At last, on the 6th of February 1715, nearly two years after the treaty of Utrecht, peace between Spain and Portugal was concluded at Madrid.

Never was the Portuguese Crown richer than in the years 1715-1755; rarely had the kingdom prospered less. The commercial and financial evils rife under the last archy and kings of the Aviz dynasty were now repeated. More gold had been discovered in Matto Grosso, diamonds in Minas Geraes. As in the 16th century immense quantities of bullion were imported by the treasury, and were lavished upon war, luxury and the Church, while agriculture and manufactures continued to decline, and the countryside was depopulated by emigration to Brazil. John V. was a spendthrift and a bigot. He gave and lent enormous sums to successive

popes, and at the bidding of Clement XI. he joined a "crusade" against the Turks in which his ships helped to win a naval action off Cape Matapan (1717). For these services he received the title of *Fidelissimus*, "Most Faithful"; "Majesty" had already been adopted by John IV. instead of the medieval "Highness," and the new style was intended to place the king of Portugal on an equality with his Most Christian Majesty of France and his Most Catholic Majesty of Spain. John V. was also empowered to create a multitude of new ecclesiastical dignities, and the archbishop of Lisbon was granted the rank and style of Patriarch *ex officio*. To the patriarchate was appended a Sacred College of 24 prelates, who were privileged to officiate in the scarlet robes of cardinals, while the patriarch wore the vestments of a second pope. Though regiments were disbanded, fleets put out of commission and fortresses dismantled to save the cost of their upkeep, the Crown paid nearly £100,000 yearly for the maintenance of this new hierarchy, and squandered untold wealth on the erection of churches and monasteries. In the church of São Roque in Lisbon, the decoration of a single chapel measuring 17 ft. by 12 ft. cost £225,000; the expenditure on the convent-palace of Mafra (*q.v.*) exceeded £4,000,000.

John V. was succeeded by his son Joseph (1750-1777). Five years afterwards Portugal was overtaken by the tremendous disaster of the Lisbon earthquake (see LISBON), which, as Oliveira Martins justly observes, was "more than a cataclysm of nature; it was a moral revolution." It brought the Restoration period to an end (1755). Throughout that period the monarchy had occupied a precarious position, dependent until 1668 for its very existence, and after 1668 for its stability, on foreign support. Its policy had been moulded to suit France or Great Britain, while its internal administration had normally been directed by the Church. The cortes had grown obsolete; the feudal aristocracy were become courtiers. Once more, as in 1580, Portugal was governed by ecclesiastics in the name of an absolute monarch; once more, as in 1580, the chief strength of the ecclesiastical party was the Society of Jesus, which still controlled the conscience and mind of the nation and of its nominal rulers, through the confessional and the schools.

7. *The Reform of the Monarchy: 1755-1826.*—The unity of Portuguese history is hard to perceive in the years which witnessed the rise and fall of the Pombaline régime, the reign of the mad queen Maria, the Peninsular War and the subsequent chaos of revolutionary intrigue. At first sight it seems absurd to characterize this period of despotism ending in war, ruin and anarchy as a period of reform. Nevertheless, it is possible to trace through the apparent chaos an uninterrupted movement from absolutism to representative institutions. Pombal liberated the monarchy from clerical domination, and thus unwittingly opened the door to those "French principles," or democratic ideas, which spread rapidly after his downfall in 1777. The destruction of an obsolete political system, begun by Pombal, was completed by the Peninsular War; while French invaders and British governors together quickened among the Portuguese a new consciousness of their nationality, and a new desire for political rights, which rendered inevitable the change to constitutional monarchy.

Two days after the accession of King Joseph, Sebastião José de Carvalho e Mello, better known as the marquess of Pombal (*q.v.*), was appointed secretary of state for foreign affairs and war. In a few months he gained an ascendancy over the king's mind which lasted until the end of the reign, and was strengthened by the courage and wisdom shown by Pombal at the time of the great earthquake. His policy was to strengthen the monarchy and to use it for the furtherance of a comprehensive scheme of reform. Beginning with finance and commerce, he reversed the bullionist policy of his predecessors and reorganized the entire system of taxation. He sought to undo the worst consequences of the Methuen treaty by the creation of national industries, establishing a gunpowder factory and a sugar refinery in 1751, a silk industry in 1752, wool, paper and glass factories after 1750. Colonial development was fostered, and the commercial dependence of Portugal upon

*Pombal,
1750-1777.*

Great Britain was reduced, by the formation of chartered companies, the first of which (1753) was given control of the Algarve sardine and tunny fisheries. The Oldembourg Company (1754) received a monopoly of trade with the Portuguese colonies in the East; extensive monopolist rights were also conceded to the Pará and Maranhão Company (1755) and the Pernambuco and Parahyba Company (1759). In Lisbon a chamber of commerce (*Junta do commercio*) was organized in 1756 to replace an older association of merchants, the *Meza dos homens de negocio*, which had attacked the Pará Company; and in the same year the Alto Douro Company was formed to control the port-wine trade and to break the monopoly enjoyed by a syndicate of British wine merchants. This company met with strong opposition, culminating in a rising at Oporto (February 1757), which was savagely suppressed.

Both his commercial policy and his desire to strengthen the Crown brought Pombal into conflict with the Church and the aristocracy. In 1751 he had made all sentences passed by the Inquisition subject to revision by the Crown. The liberation of all slaves in Pará and Maranhão except negroes (1755), and the creation of the Pará Company, were prejudicial to the interests of the Jesuits, whose administrative authority over the Indians of Brazil was also curtailed. Various charges were brought against the Society by Pombal, and in September 1759, after five years of heated controversy (see **JESUITS**), he published a decree of expulsion against all its members in the Portuguese dominions. His power at court had previously been strengthened by the so-called Tavora plot. The marquess and marchioness of Tavora and their two sons, with the duke of Aveiro, the count of Atouguia and other noblemen, were accused of complicity in an attempt upon the life of King Joseph (September 1758). Pombal appointed a special tribunal to judge the case; many of the accused, including those already mentioned, were found guilty and executed; and an attempt was made to implicate the Jesuits. Pombal's enemies declared that he himself had organized the attack upon the king, in such a manner as to throw suspicion upon his political opponents and to gain credit for himself. This accusation was not proved, but the history of the Tavora plot remains extremely obscure. The expulsion of the Jesuits involved Portugal in a dispute with Pope Clement XIII.; in June 1760 the papal nuncio was ordered to leave Lisbon, and diplomatic relations with the Vatican were only resumed after the condemnation of the Jesuits by Clement XIV., in July 1773.

His victory over the Jesuits left Pombal free to develop his plans for reform. He devoted himself especially to education and defence. A school of commerce was founded in 1759; in 1760 the censorship of books was transferred from an ecclesiastical to a lay tribunal; in 1761 the former Jesuit college in Lisbon was converted into a college for the sons of noblemen; in 1768 a royal printing-press was established; in 1772 Pombal provided for a complete system of primary and secondary education, entailing the foundation of 837 schools. He founded a college of art in Mafra; he became visitor of Coimbra University, recast its statutes and introduced the teaching of natural science. Funds for these reforms were to a great extent provided out of the sequestered property of the Jesuits; Pombal also effected great economies in internal administration. He abolished the distinction between Old and New Christians, and made all Portuguese subjects eligible to any office in the state. Far-reaching reforms were at the same time carried out in the army, navy and mercantile marine. In 1760 Admiral Boscawen had violated Portuguese neutrality by burning four French ships off Lagos; Pombal protested and the British government apologized, but not before the military weakness of Portugal had been demonstrated. Two years later, when the Family Compact involved Portugal in a war with Spain, Pombal called in Count William of Lippe-Bückeburg to reorganize the army, which was reinforced by a British contingent under Brigadier-General John Burgoyne, and was increased from 5000 to 50,000 men. The Spaniards were at first successful, and captured Braganza and Almeida; but they were subsequently defeated at Villa Velha and Valencia de Alcantara, and the Portuguese fully held their

own up to the signature of peace at Fontainebleau, in February 1763. Towards the close of the reign, a long-standing controversy with Spain as to the frontier between Brazil and the Spanish colonies threatened a renewal of the war; but in this crisis Pombal was deprived of power by the death of King Joseph (Feb. 20, 1777) and the accession of his daughter Maria I.

The queen was married to her uncle, who became king consort as Pedro III. Pombal's dismissal, brought about by the influence of the queen-mother Mariana Victoria, *Maria I.*, did not involve an immediate reversal of his policy. *Pedro III.* The controversy with Spain was amicably settled *and D. John.* by the treaty of San Ildefonso (1777); and further industrial and educational reforms were inaugurated, chief among them being the foundation, in 1780, of the Royal Academy of Sciences. Queen Maria, who had previously shown signs of religious mania, became wholly insane after 1788, owing to the deaths of Pedro III. (May 1786), of the crown prince D. Joseph, and of her confessor, the inquisitor-general D. Ignacio de San Caetano. Her second son, D. John, assumed the conduct of affairs in 1792, although he did not take the title of regent until 1799. Meanwhile a two-fold reaction—on one side clericalist, on the other democratic—had set in against the reforms of Pombal. D. John told William Beckford in 1786 that "the kingdom belonged to the monks," and his consort Carlota Joaquina, daughter of Charles IV. of Spain, exercised a powerful influence in favour of the Church. But new ideas had been introduced with the new system of education, and the inevitable revolt against absolutism had resulted in the formation of a Radical party, which sympathized with the Revolution in France and carried on an active propaganda through the numerous masonic lodges which were in fact political clubs. D. John became alarmed, and the intendant of police in Lisbon, D. Diogo Ignacio de Pina Manique, organized an elaborate system of espionage which led to the imprisonment or exile of many harmless enthusiasts.

From similar motives, a treaty of alliance with Spain was signed at Aranjuez in March 1793; 5000 Portuguese troops were sent to assist in a Spanish invasion of France; a Portuguese squadron joined the British Mediterranean fleet. *Relations with Spain, France and Great Britain, 1793-1806.* But in July 1795 Spain concluded a peace with the French republic from which Portugal, as the ally of Great Britain, was deliberately excluded. In 1796 Spain declared war upon Great Britain, and in 1797 a secret convention for the partition of Portugal was signed by the French ambassador in Madrid, General Pérignon, and by the Spanish minister Godoy. D. John appealed for help to Great Britain, which sent him 6000 men, under Sir Charles Stuart, and a subsidy of £200,000. Though Spain, through the influence of D. John's father-in-law Charles IV., still remained neutral, a state of war between Portugal and France existed until 1799. D. John then reopened negotiations with Napoleon, and Lucien Bonaparte was sent to dictate terms in Madrid. But D. John dared not consent to close the harbours of Portugal against British ships. England was the chief market for Portuguese wine and grain; and the long Portuguese littoral was at the mercy of the British navy. Compelled to choose between fighting on land and fighting at sea, D. John rejected the demands of Lucien Bonaparte, and on the 10th of February 1801 declared war upon Spain. His territories were at once invaded by a Franco-Spanish army, and on the 6th of June 1801 he was forced to conclude the peace of Badajoz, by which he ceded the frontier fortress of Olivenza to Spain, and undertook to pay 20,000,000 francs to Napoleon and to exclude British ships from Portuguese ports. Napoleon was dissatisfied with these terms, and although he ultimately ratified the treaty, he sent General Lannes to Lisbon as his ambassador, instructing him to humiliate the Portuguese and if possible to goad them into a renewal of the war. The same policy was continued by General Junot, who succeeded Lannes in 1804. Junot required D. John to declare war upon Great Britain, but this demand was not immediately pressed owing to the preoccupation of Napoleon with greater affairs, and in October 1805 Junot left Portugal.

By his Berlin decree of the 21st of November 1806 Napoleon

required all continental states to close their ports to British ships. As Portugal again refused to obey, another secret Franco-Spanish treaty was signed at Fontainebleau on the 27th of October 1807, providing for the partition of Portugal. Entre-Minho-e-Douro was to be given to Louis II. of Etruria in exchange for his Italian kingdom; Algarve and Alemtejo were to form a separate principality for Godoy; the remaining provinces were to be garrisoned by French troops until a general peace should be concluded. To give effect to these terms, General Junot hastened westward across Spain, at the head of 30,000 French soldiers and a large body of Spanish auxiliaries. So rapid were his movements that there was no time to organize effective resistance. On the 20th of November D. John, acting on the advice of Sir Sidney Smith, British naval commander in the Tagus, appointed a council of regency and sailed for Brazil, convoyed by Sir Sidney Smith's squadron. For a detailed account of the subsequent military operations, see PENINSULAR WAR.

Junot, who was everywhere well received by the Portuguese democrats, entered Lisbon at the end of November 1807. He assumed command of the Portuguese army, divided the kingdom into military governments, and, on the 1st of February 1808 announced that the Braganza dynasty had forfeited its right to the throne. He himself hoped to succeed D. John, and sought to conciliate the Portuguese by reducing the requisition demanded

by Napoleon from 40,000,000 francs to 20,000,000. But the action of the French troops in occupying the fortresses of northern Spain provoked in May 1808 a general rising in that country, which soon spread to Portugal. The Spanish garrison in Oporto expelled the French governor and declared for the Braganzas, compelling Junot to march towards the north. He left Lisbon under the control of a regency, headed by the bishop of Oporto, who applied to Great Britain for help, promoted an insurrection against the French, and organized *juntas* (committees) of government in the larger towns. On the 1st of August 1808 Sir Arthur Wellesley, with 9000 British troops, landed at Figueira da Foz. He defeated a French division at Roleia ("Roleia") on the 17th, and on the 21st won a victory over Junot at Vimeiro ("Vimiera"). Fearing an attack by Portuguese auxiliaries and the arrival of British reinforcements under Sir John Moore, Junot signed the convention of Cintra by which, on the 30th of August 1808, he agreed to evacuate Portugal (see WELLINGTON). The regency appointed by D. John was now reconstituted and in October Sir John Moore assumed command of all the allied troops in Portugal. From Lisbon Moore marched north-eastward with about 32,000 men to assist the Spanish armies against Napoleon; his subsequent retreat to join Sir David Baird in Galicia, in January 1809, diverted the pursuing army under Napoleon to the north-west, and temporarily saved Portugal from attack.

In February Major-General William Carr Beresford was given command of the Portuguese army. Organized and disciplined by British officers, the native troops played a gallant part in the subsequent campaigns. In March 1809 the second invasion of Portugal began; Soult crossed the Galician frontier and captured Oporto, while an auxiliary force under General Lapisse advanced from Salamanca. On the 22nd of April, however, Wellesley, who had been recalled after the convention of Cintra, landed in Lisbon. On the 12th of May he forced the passage of the Douro, subsequently retaking Oporto and pursuing Soult into Spain. Valuable assistance had been rendered by the Portuguese generals Antonio da Silveira and Manoel de Brito Mousinho—the first a leader, the second an organizer.

After the battle of Wagram (July 6, 1809) the French armies in the Peninsula received large reinforcements, and Marshal Masséna, with 120,000 men, was ordered to operate against Portugal. He crossed the frontier in June 1810 and besieged Almeida, which capitulated on the 27th of August. Wellesley, who had now become Viscount Wellington, opposed his march south-

wards, and won a victory at Bussaco on the 27th of September; but Masséna subsequently turned the position of the allied army on the Serra de Bussaco, and caused Wellington to fall back upon the fortified lines which he had already constructed at Torres Vedras. Here he stood upon the defensive until the invaders should be defeated by starvation. The Portuguese troops cut Masséna's communications; the peasants, under instructions from Wellington, had already laid waste their own farms, destroyed the roads and bridges by which Masséna might retreat, and burned their boats on the Tagus. On the 5th of March 1811, after a winter of terrible sufferings, Masséna's retreat began; he was harassed by the allied troops all the way to Sabugal, where the last rearguard action in Portugal took place on the 3rd of April. The invaders retired with a loss of nearly 30,000 men; Almeida was retaken on the 6th; and the remainder of the war was fought out on Spanish and French soil. The Portuguese troops remained under Wellington's command until 1814, and distinguished themselves in many actions, notably at Salamanca and on the Nivelle.

At the congress of Vienna (1814-1815) Portugal was represented by three plenipotentiaries, who were instructed to press for the retrocession of Olivenza and to oppose the restoration of French Guiana, which the Brazilians had conquered in 1809. Neither object was attained; and this failure, which was attributed to the lack of British support, hastened the reaction against British influence which had already begun. Since 1808 Portugal had theoretically been governed by the regency representing D. John. But as the regency was corrupt and unable to co-operate with Wellington and Beresford, the British government had demanded that Sir Charles Stuart (son of the Sir Charles Stuart mentioned above) should be appointed one of its members. The real control of affairs soon afterwards passed into the strong hands of Stuart and Beresford; and while the war lasted the Portuguese acquiesced in what was in fact an autocracy exercised by foreigners. In 1815, however, they desired to resume their independence. A further cause of dissatisfaction was the mutual jealousy of Portugal and Brazil. The colony claimed as high a political status as the mother-country, and by a decree dated the 16th of January 1815 it was raised to the rank of a separate kingdom. Thenceforward, until 1822, the Portuguese sovereignty was styled the United Kingdom of Portugal, Brazil and the Algarves. The importance of this change became apparent when Queen Maria I. died (March 1816) and D. John succeeded to the united thrones as John VI. The king refused to leave Brazil, partly owing to the intrigues of Carlota Joaquina, who hoped to become queen of an independent Brazilian kingdom. Thus Portugal, which had been almost ruined by the war, was now humiliated by the failure of her diplomacy at Vienna and by her continued dependence upon Great Britain and Brazil. The resultant discontent found expression in the cry of "Portugal for the Portuguese" and in the demand for a constitution.

In 1817 a military revolt (*pronunciamento*) in Lisbon was crushed by Beresford, and the leader, General Gomes Freire de Andrade, was executed; but on the 16th of August 1820, after Beresford had sailed to Brazil to secure the return of John VI., a second rising took place in Oporto. It soon spread southward. A new council of regency was established in Lisbon, the British officers were expelled from the army; Beresford, on his return from Brazil, was not permitted to land; a constituent assembly was summoned. This body suppressed the Inquisition and drew up a highly democratic constitution, by which all citizens were declared equal before the law and eligible to any office; all class privileges were abolished, the liberty of the Press was guaranteed, and the government of the country was vested in a single chamber, subject only to the suspensive veto of the Crown. So extreme a change was disliked by most of the powers and by many Portuguese, especially those of the clerical party. Great Britain insisted on the return of John VI., who entrusted the government of Brazil to his elder son D. Pedro and landed in Portugal on the 3rd of July 1821. In 1822, on the advice of

Invasion by Junot, November 1807-August 1808.

Results of the War.

Invasion by Soult, March-May 1809.

The Constitutional Movement, 1820-1826.

Invasion by Masséna, June 1810-April 1811.

D. Pedro, he swore to obey the constitution (thenceforward known as the "constitution of 1822"). But his younger son, D. Miguel, and the queen, Carlota Joaquina, refused to take the oath; and in December 1822 sentence of banishment was pronounced against them, though not enforced. They had many supporters at home and abroad. French troops had invaded Spain in the interests of Ferdinand VII. (1823), and the French government was prepared to countenance the absolutist party in Portugal in order to check British influence there. Another military revolt broke out in Traz-os-Montes on the 3rd of February 1823, its leader being the count of Amarante, who was opposed to the constitution. D. Miguel appealed to the army to "restore liberty to their king," and the army, incensed by the loss of Brazil (1822), gave him almost unanimous support. At this juncture John VI., vainly seeking for a compromise, abrogated the constitution of 1822, but appointed as his minister D. Pedro de Sousa Holstein, count (afterwards duke) of Palmella and leader of the "English" or constitutional party. These half-measures did not satisfy D. Miguel, whose soldiers seized the royal palace in Lisbon on the 30th of April 1824. Palmella was arrested, and John VI. forced to take refuge on the British flagship in the Tagus. But the united action of the foreign ministers restored the king and reinstated Palmella; the insurrection was crushed; D. Miguel submitted and went into exile (June 1824).

In Brazil also a revolution had taken place. The Brazilians demanded complete independence, and D. Pedro sided with them. The Portuguese garrison of Rio de Janeiro was overpowered; on the 7th of September 1822 D. Pedro declared the country independent, and on the 12th of October he was proclaimed constitutional emperor. He took no notice of the constituent assembly in Lisbon, which on the 19th of September had ordered him to return to Portugal on pain of forfeiting his right to inherit the Portuguese Crown. By the end of 1823 all Portuguese resistance to the new régime in Brazil had been overcome.

John VI. died on the 10th of March 1826, leaving (by will) his daughter D. Isabel Maria as regent for Pedro I. of Brazil, who now became Pedro IV. of Portugal. A crisis was evidently imminent, for Portugal would not tolerate an absentee sovereign who was far more Brazilian than Portuguese. The unsatisfied ambition of Carlota Joaquina and the hostility between absolutists and constitutionalists might at any moment precipitate a civil war. To conciliate the Portuguese, Pedro IV. drew up a charter (known as the "charter of 1826") which provided for moderate parliamentary government on the British model. To conciliate the Brazilians, he undertook (by decree dated May 2nd 1826) to surrender the Portuguese Crown to his daughter D. Maria da Gloria (then aged seven); but this abdication was made contingent upon her marriage with her uncle D. Miguel, who was first required to swear fidelity to the charter.

8. *Constitutional Government.*—The charter of 1826 forms the basis of the present Portuguese constitution and the starting-point of modern Portuguese history. That history comprises four periods: (a) From 1826 to 1834 the clerical and absolutist parties led by D. Miguel united every reactionary element throughout the kingdom in a last unsuccessful stand against constitutional government; (b) From 1834 to 1853 the main problem for Portuguese statesmen was whether the constitution, now accepted as inevitable, should embody the radical ideas of 1822 or the moderate ideas of 1826; (c) From 1853 to 1889 there was a period of transition marked by the rise of three new parties—Progressive, Regenerator, Republican; (d) From 1889 to 1908 the Progressives and Regenerators monopolized the control of public affairs, but the strength of Republicanism was not to be gauged by its representation in the cortes. At the beginning of the 20th century the question whether the monarchy should be replaced by a republic had become a living political issue, which was decided by the revolution of October 5, 1910.

The charter was brought to Lisbon by Sir Charles Stuart in July 1826. The absolutists had hoped that D. Pedro would abdicate unconditionally in favour of D. Miguel, and the council

of regency at first refused to publish the charter. They were forced to do so (July 12) by a *pronunciamento* issued by D. João Carlos de Saldanha de Oliveira e Daun, count *The* of Saldanha and commander of the army in Oporto. *Absolutist Reaction.* Saldanha, a prominent constitutionalist, threatened to march on Lisbon if the regency did not swear obedience to the charter by the 31st of July. Amid wild enthusiasm the charter was proclaimed on that day, and on the 3rd of August Saldanha became head of a Liberal ministry. An absolutist counter-revolution at once broke out in the north. It was organized by the marquess of Chaves, and supported openly by the Church and the Miguelite majority of the army; secret assistance was also given by Spain. As civil war appeared imminent, Canning despatched 5000 British troops under Sir William Clinton to restore order, and to disband the troops under Chaves. By March 1827 Clinton and Saldanha had secured the acceptance of the charter throughout Portugal.

In October 1826 D. Miguel also swore to obey the charter and was betrothed to his niece D. Maria da Gloria (Maria II.). Pedro IV. appointed him regent in July 1827 and in February 1828 he landed in Lisbon, where he was received with cries of "Viva D. Miguel I., rei absoluto!" In March he dissolved the parliament which had met in accordance with the charter. In April the Tory ministry under Wellington withdrew Clinton's division, which was the mainstay of the charter. In May D. Miguel summoned a cortes of the ancient type, which offered him the Crown; and on the 7th of July 1828 he took the oath as king. Saldanha, Palmella, the count of Villa Flor (afterwards duke of Terceira), and the other constitutionalist leaders were driven into exile, while scores of their adherents were executed and thousands imprisoned. Austria and Spain supported D. Miguel, who was able to dispose of the vast wealth of Carlota Joaquina; Great Britain and France remained neutral. Only the emperor D. Pedro and a handful of exiles upheld the cause of Maria II., who returned to Brazil in 1829.

The Azores, although the majority of their inhabitants favoured absolutism, now became a centre of resistance to D. Miguel. In 1828 the garrison of Angra declared *The* for Maria II., endured a siege lasting four months, *Miguelite Wars.* and finally took refuge in the island of Terceira, where it was reinforced by volunteers from Brazil and constitutionalist refugees from England and France. In March 1829 Palmella established a regency on the island, on behalf of Maria II.; and D. Miguel's fleet was defeated in Praia Bay on the 12th of August. Fortune played into the hands of Palmella, Saldanha, Villa Flor and their followers in Terceira. In 1830 a Whig ministry came into office in Great Britain; the "July revolution" placed Louis Philippe on the throne of France; Carlota Joaquina, the power behind D. Miguel's throne, died on the 7th of January. The fanaticism of the clerical and absolutist parties in Portugal (collectively termed *apostolicos*) was enhanced by recrudescence of Sebastianism. Men saw in the brutal boor D. Miguel (*q.v.*) a personification of the hero-king Sebastian, whose second advent had been expected for two and a half centuries. In the orgy of persecution, outrages were committed on British and French subjects; and a French squadron retaliated by seizing D. Miguel's fleet in the Tagus (July 1831). In Brazil, D. Pedro abdicated (April 1831); he determined to return to Europe and conduct in person a campaign for the restoration of Maria II. He was received with enthusiasm by Louis Philippe. In Great Britain Palmella raised a loan of £2,000,000 and purchased a small fleet, of which Captain Sartorius, a retired British naval officer, was appointed admiral. In February 1832 the "Liberators," as they were styled, sailed from Belleisle to the Azores, with D. Pedro aboard the flagship. In July they reached Portugal and occupied Oporto, but the expected constitutionalist rising did not take place. The country was almost unanimous in its loyalty to D. Miguel, who had 80,000 troops against the 6500 (including 500 French and 300 British) of D. Pedro. But the Miguelites had no navy, and no competent general. They besieged D. Pedro in Oporto from July 1832 to July 1833, when the duke of Terceira and

Captain Charles Napier, who had succeeded Sartorius, effected a daring and successful diversion which resulted in the capture of Lisbon, (July 24, 1833). Maria II. arrived from France in September. The war went in her favour, largely owing to the brilliant generalship of Saldanha and the financial straits to which D. Miguel was reduced. In April 1834 a Quadruple Alliance was concluded between France, Spain, Great Britain and the government of Maria II. The allied army defeated the Miguelites at Asseiceira on the 16th of May, and D. Miguel surrendered at Evora-Monte on the 24th. By the convention of Evora-Monte he was condemned to perpetual banishment from the Peninsula. On the 24th of September D. Pedro died. During the few months in which he acted as regent for his daughter, he had transformed Portugal from a semi-feudal into a modern state. Tithes, many hereditary privileges and all monopolies were abolished; every convent was closed and its property nationalized; the Jesuits, who had returned after the death of Pombal, were again expelled; the charter of 1826 was restored.

Maria II. was fifteen years old at her accession. She was twice married—in December 1834 to Augustus, duke of Leuchtenberg, who died four months afterwards; and in April 1836 to Ferdinand of Saxe-Coburg, who received the title of king consort in September 1837. Both the queen and the king consort were strangers to Portugal, and could exercise little control over the turbulent factions whose intrigues and *pronunciamentos* made orderly government impossible. There were three political parties: the Miguelites, who were still strong enough to cause trouble; the Chartists, who advocated the principles of 1826; the Septembrists, who advocated those of 1822 and took their name from the successful *coup d'état* of the 9th-11th of September 1836. By this *coup d'état* the constitution of 1822 was substituted for the charter of 1826; and a Septembrist ministry under the Viscount Sá da Bandeira replaced the Chartist ministry under Saldanha, Terceira and Palmella. A counter-revolution, planned in the royal palace at Belem and hence known as the *Belemzada*, was frustrated in November 1836; and in 1837 a Chartist insurrection was crushed after severe fighting. This was known as the "War of the Marshals," from the rank of the two Chartist leaders, Saldanha and Terceira. In 1839 a moderate ministry took office, with Antonio Bermudo da Costa Cabral as its real, though not its ostensible, head. A *pronunciamento* by Costa Cabral led to the restoration of the charter on the 10th of February 1842, and a Cabral government was formed under the nominal leadership of Terceira. Costa Cabral, who became count of Thomar in 1845, ruled despotically, despite many insurrections, until May 1846, when a coalition of Miguelites, Septembrists and Chartist malcontents drove him into exile. On this occasion the rebellion—known as the "War of Maria da Fonte"—proved formidable. Oporto was held by a revolutionary *junta*, and Saldanha, who had become prime minister, persuaded the Quadruple Alliance to intervene. In June 1847 the Oporto *junta* surrendered, under promise of an amnesty, to a combined British and Spanish force, and the convention of Gramido (July 24, 1847) ended the war. Saldanha was rewarded with a dukedom, and retained office until June 1849. The dictatorial rule of his successor—the returned exile, Thomar—provoked another successful rising on the 7th of April 1851. Thomar again fled from the country; Saldanha again became prime minister, but at the head of a moderate coalition. He remained in power during five years of unbroken peace (1851-1856), and carried many useful reforms. The most important of these was the so-called Additional Act of the 5th of July 1852, which amended the charter of 1826 by providing for the direct election of deputies, the decentralization of the executive, the creation of representative municipal councils, and the abolition of capital punishment for political offences. Maria II. died on the 13th of November 1853, and was succeeded by her eldest son D. Pedro, during whose ministry the king consort D. Ferdinand acted as regent.

Under the brothers Pedro V. (1853-1861) and Luiz (1861-

1889) Portugal obtained a respite from civil strife. Both monarchs delegated the conduct of affairs to their ministers, who constructed new railways, reformed the educational system, and gradually improved the economic condition of the kingdom and its colonies. Pedro V. came of age and assumed the government on the 16th of November 1855, in 1857 he married Princess Stephanie of Hohenzollern. The only political disturbance which marred the peace of his reign arose out of the seizure of the "Charles et Georges," a French slave-trader which was captured off Mozambique. Napoleon III. sent a fleet to the Tagus and demanded an indemnity, which Portugal was compelled to pay. In 1860-1861 cholera ravaged the whole kingdom, and especially the capital. The king died of this disease on the 11th of November 1861, and two of his brothers, D. Ferdinand and D. John, died shortly afterwards. D. Luiz was absent at the time, and his father D. Ferdinand again became regent until his return, soon after which (1862) the new king married Maria Pia, daughter of Victor Emanuel II. of Italy. In 1869 slavery was abolished in every Portuguese colony. In 1870 the duke of Saldanha, the last survivor of the turbulent statesmen of Queen Maria's reign, threatened an appeal to arms if the king would not dismiss his minister, the duke of Loulé, an advanced Radical and freemason, whose influence, dating from the reign of Pedro V., was viewed with disfavour by Saldanha, as well as by more conservative politicians. The king yielded; and Saldanha himself became prime minister, retaining office until 1874, when, at the age of 80, he was sent as ambassador to London. He had been by far the most influential man in Portugal, and his death in 1876 was followed by a regrouping of political parties.

The party of the Regenerators (*Regeneradores*), formed in 1852 out of a coalition of Septembrists and Chartists, had already been disintegrated. Its more radical elements, known at first as the Historic Left, were in 1877 reorganized as the Progressives (*Progressistas*). Its more conservative elements carried on the tradition and retained the name of the original Regenerators. Besides these two monarchist parties—the Regenerators or Conservative right and the Progressives or Constitutional left—a strong Republican party was formed in 1881. There were also the Miguelites, active but impotent intriguers; and the advocates of Iberian union, who became prominent in 1867, 1869, 1874, and especially in July 1872, when many well-known politicians were implicated in a fantastic conspiracy for the establishment of an Iberian republic. Portuguese nationalism was too strong for these advocates of union with Spain, whose propaganda was discredited as soon as any national interest was seriously endangered. This was the case in 1872, when Great Britain claimed the southern part of Delagoa Bay. The claim was submitted to the arbitration of M. Thiers, the French president, whose successor, Marshal Macmahon, delivered an award in favour of Portugal on the 19th of April 1875 (see DELAGOA BAY).

King Luiz died on the 19th of October 1889, and was succeeded by his son D. Carlos (*q.v.*). Colonial affairs had for some time received close attention. In 1885 Portugal recognized the Congo Free State, and admitted its sovereignty over the north bank of the Lower Congo, although, in an unratified treaty of 1884, Great Britain had recognized both banks of the river as Portuguese territory. In 1886 Germany, France and Portugal defined by treaty the limits of their adjacent spheres of influence, and on the 26th of March 1887 Macao, hitherto leased to Portugal, was formally ceded by the Chinese government. In 1889 a resolution unanimously adopted by both chambers invited the ministry, of which José de Castro was president and Barros Gomes foreign minister, to press forward the territorial claims of Portugal in East and Central Africa. Shortly after the accession of King Carlos this active policy led to a dispute with Great Britain (see AFRICA, § 5). A Portuguese force under Major Serpa Pinto had invaded the

Pedro V.
and Luiz.

Maria II.,
1834-1853.

Political
Parties.

Colonial
Affairs:
Relations
with Great
Britain.

Shiré highlands in order to forestall their annexation by the British, and the British government demanded satisfaction. Public opinion rendered compliance difficult until a British squadron was despatched to the mouth of the Tagus, and the British minister presented an ultimatum (Jan. 11, 1890), requiring the withdrawal of all Portuguese forces from the Shiré. Barros Gomes was then able to yield under protest; but disturbances at once broke out in Lisbon and Oporto, and the ministry resigned. A coalition government took office on the 14th of January, with Serpa Pimentel as prime minister and J. Hintze-Ribeiro as foreign minister. The king, in a letter to Queen Victoria, declined for the time being to receive the Order of the Garter, which had just been offered him, and on the 6th of February the government addressed a circular letter to the powers, proposing to submit the issues in dispute to a European conference. Meanwhile a Republican rising was suppressed in Lisbon, and many suspected officers were degraded. On the 20th of August an Anglo-Portuguese agreement was negotiated in London, but the cortes refused to ratify it. The ministry therefore resigned, and on the 14th of October Abreu e Sousa formed a new cabinet, which arranged with Great Britain a *modus vivendi* for six months, pending the conclusion of another agreement. The British government was ready to make concessions, but more than one collision took place between Portuguese troops in Manica and the forces of the British South Africa Company. The defeat of the Portuguese was the chief cause of a serious military rising in Oporto, which broke out on the 30th of January 1891. The suppression of this rising so far enhanced the prestige of the cabinet that the cortes forthwith approved the convention with Great Britain; and the definitive treaty, by which Portugal abandoned all claim to a trans-African dominion, was ratified by the cortes on the 28th of May. Relations with Great Britain, however, remained far from cordial until the celebration of the fourth centenary of Vasco da Gama's voyage to India afforded the opportunity for a *rapprochement* in 1898.

The extravagant management of the railways guaranteed by the state had entailed such heavy deficits that the payment of **Financial Crisis of 1892.** the coupon of the railway state loan, due on the 2nd of January 1892 had to be suspended. Thus arose a serious financial crisis, involving three changes of ministry. In May the Portuguese government committed a formal act of bankruptcy by issuing a decree reducing the amount then due to foreign bondholders by two-thirds. The bondholders' committees, supported by some of the powers concerned, protested against this illegal action. A compromise was at last arranged by Hintze-Ribeiro, who assumed office in February 1893 as head of a Progressive government. His cabinet promised only slightly better terms to the foreign bondholders, but it relieved the financial tension in some degree; and by coming to an agreement with Germany in East Africa and with Great Britain in South Africa as to the delimitation of frontiers, he minimized the risks of conflict with either country.

Portugal observed neutrality on the outbreak of the Anglo-Boer War, but the permission it conceded to the British consul at Lourenço Marques to search for contraband of war among goods imported there, and the free passage accorded to an armed force under General Carrington from Beira through Portuguese territory to Rhodesia, were vehemently attacked in the Press and at public meetings. The award of the Swiss arbitrators in the matter of the Delagoa Bay railway was given in 1900 (see LOURENÇO MARQUES). Portugal was condemned to pay 15,314,000 francs compensation; and this sum (less than was expected) was immediately raised by loan from the Portuguese Tobacco Company.

A law of the 8th of August 1901 regulated the conditions of election to the lower house, thus ending a long series of parliamentary reforms. The most important of these had provided for the gradual extinction of the right of hereditary peers to sit in the upper house (July 24, 1885), had reduced the number of deputies and fixed the qualifications required for the exercise of

the franchise (March 28, 1895); and had abolished the elective branch in the upper house (Sept. 25, 1895). These changes left untouched the most serious evil in Portuguese public life. The two great parties, Progressives and Regenerators, were largely composed of professional politicians whose votes were determined by their private interests. Skilful manipulation of the electoral returns enabled these two parties to hold office in fairly regular rotation; hence arose the popular nickname of *rotativos*, applied to Progressives and Regenerators alike. The same methods enabled them to obstruct the election of Republican and Independent candidates.

Under such a system of government it was natural that economic issues should still dominate Portuguese politics at the beginning of the 20th century. Year by year the budget showed a deficit, and the indebtedness of the state increased. A large proportion of the expenditure was unproductive, corruption was rife in the public services, and the poverty of the overtaxed peasant and artisan classes gave rise to sporadic outbreaks of violence. In 1902 the students at Coimbra and Oporto organized an agitation against the proposed conversion of the gold debt; and anti-clerical riots, followed by a strike, rendered necessary the proclamation of martial law in Aveiro. In January 1903 an insurrection of peasants armed with scythes took place at Fundão; the imposition of a new market tax provoked riots at Coimbra in March; a serious strike of weavers took place at Oporto in June. In the same year the general distress was intensified by the failure of the Rural and Mortgage Bank of Brazil. In these circumstances Republicanism rapidly gained ground. Its real strength was masked by the system which enabled any ministry in power to control the election of candidates to the cortes. In April 1896, for example, only one Republican deputy was returned, although it was notorious that the Republican party could command a majority in many constituencies. Though the army as a whole was monarchist, certain regiments had become imbued with revolutionary ideals, which were fortified by the unwise employment of soldiers and sailors for the suppression of industrial disputes. During the weavers' strike the cruiser "Rainha D. Amelia" was converted into a temporary prison, and at Fundão, Aveiro and elsewhere troops had been ordered to fire on men with whom they sympathized. In November 1902, while King Carlos was in England, a military rising was organized in Oporto, but never took place. On the 23rd of April 1903 a body of cavalry and artillery mutinied in Lisbon and proclaimed a republic; but they were overpowered and ultimately transported to Mozambique. Such incidents, unimportant in themselves, were symptoms of a dangerous state of public opinion, which was debarred from expression in the cortes.

The constitution empowered the sovereign to veto any bill, to dissolve or prorogue the cortes, and to govern by means of ministerial decrees. The use of these extraordinary powers would be a breach of constitutional practice, but not of law. King Carlos had already been criticized for alleged excessive interferences in politics. An experiment in government by decree had been made in May—October 1894; it was repeated in September 1905, when the king consented to prorogue the cortes until January 1906 in order to postpone discussion of the terms upon which the tobacco monopoly was to be allocated. A general election, in February 1906, was followed by three changes of ministry, the last of which, on the 19th of May, inaugurated the régime known in Portugal as the *dictadura* or dictatorship. João Franco, the new prime minister, was conspicuous among Portuguese politicians for his integrity, energy and courage; he intended to reform the national finances and administration—by constitutional means, if possible. The cortes, opened on the 6th of June 1906, was dissolved on the 14th; another election took place, preceded by an official announcement that on this occasion all votes would be fairly counted; and the *Franquistas* or "New Regenerators" obtained a majority. When the

Constitutional Changes, 1885-1901.

Republicanism and the Army.

The Dictatorship, 1906-1908.

cortes met, on the 20th of September, the opposition accused King Carlos of complicity in grave financial scandals. It was admitted that he had borrowed largely from the treasury, on the security of his civil list, and the Republican deputies accused him of endeavouring to assign the tobacco monopoly to one of his own foreign creditors, in settlement of the debt. Franco organized a coalition in defence of the Crown, but in January 1907 business in the cortes was brought to a standstill and many sittings ended in uproar. The attacks on the king were repeated at the trial of the poet Guerra Junqueiro, who was indicted for *lèse-majesté*. All parties believed that the ministry would fall, and the *rolativos* prepared once more to divide the spoils of office, when, on the 2nd of May 1907, João Franco reconstructed his cabinet, secured the dissolution of the cortes and announced that certain bills still under discussion would receive the force of law. His partisans in the press hailed the advent of a second Pombal, and their enthusiasm was shared by many enlightened Portuguese, who had previously held aloof from politics but now rallied to the support of an honest dictator. Backed by these forces, as well as by the king and the army, Franco effected some useful reforms. But his opponents included not only the Republicans, the professional politicians and those officials who feared inquiry, but also the magistracy, the district and municipal councils, and the large body of citizens who still believed in parliamentary government. The existing debt owed by D. Carlos to the nation was assessed at £154,000. This sum was ostensibly paid by the transference to the treasury of the royal yacht "Amélia" and certain palaces; but the cost and upkeep of the "Amélia" had been paid with public money, while the palaces had long been maintained as state property. These transactions, though perhaps necessary to save the credit of the sovereign at the least possible cost, infuriated the opposition. Newspapers and politicians openly advocated rebellion; Franco had recourse to coercion. Seditious journals were suppressed; gaols and fortresses were crowded with prisoners; the upper house, which was hostile to the dictator, was deprived of its judicial powers and reconstituted on a less democratic basis (as in 1826); the district and municipal councils were dissolved and replaced by administrative commissions nominated by the Crown (Jan. 1, 1908).

The ministerial press from time to time announced the discovery of sensational plots against the king and the dictator.

It is, however, uncertain whether the assassination of King Carlos and the crown prince (see CARLOS I.), on the 1st of February 1908, was part of a widely organized conspiracy; or whether it was the act of an isolated band of fanatics, unconnected with any political party. The republican press applauded the murder; the professional politicians benefited by it. But the regicide Buiça and his associates probably acted on their own initiative. The immediate results were the accession of Prince Manoel or Manuel (Emanuel II.) to the throne and the resignation of Franco, who sailed for Genoa. A coalition ministry, representing all the monarchist parties, was formed under the presidency of Admiral Ferreira do Amaral. The administrative commissions appointed by Franco were dissolved; the civil list was reduced; the upper house was reconstituted. A general election took place; in April the cortes met and the balance of power between Progressives and Regenerators was restored. On the 6th of May 1908 D. Manoel swore to uphold the constitution and was acclaimed king by the cortes. His uncle D. Afonso (b. 1865) took a similar oath as crown prince on the 22nd of March 1910.

The failure of the dictatorship and the inability of the monarchists to agree upon any common policy had discredited the existing régime, and at the general election of August 1910 the Republican candidates in Lisbon and Oporto were returned by large majorities. On the 3rd of October the murder of a distinguished Republican physician, Dr Miguel Bombarda, precipitated the revolution which had been organized to take place in Lisbon ten days later. The Republican soldiers in Lisbon, aided by armed civilians and by the warships in the Tagus, attacked the loyal

The Revolution of 1910.

garrison and municipal guards, shelled the Necessidades Palace, and after severe street-fighting (Oct. 4th-6th) became masters of the capital. The king escaped to Ericeira, and thence, with the other members of the royal family, to Gibraltar. Soon afterwards they travelled undisturbed to England, where the king was received by the duke of Orleans. Throughout Portugal the proclamation of a republic was either welcomed or accepted without further resistance. A provisional government was formed under the presidency of Dr Theophilo Braga (b. 1843), a native of the Azores, who had since 1865 been prominent among Portuguese men of letters (see *Literature*, below). The new government undertook to carry out part of the Republican programme before summoning a constituent assembly to remodel the constitution. Among its most important acts were the expulsion of the religious congregations which had returned after 1834, the nationalization of their property, and the abolition, by decree, of the council of state, the upper house and all hereditary titles or privileges. The Republican programme also included the separation of Church and State, and the concession of local autonomy (on federal lines, if possible) to the provinces and colonies of Portugal.

BIBLIOGRAPHY.—1. **Sources.**—There are separate articles on the Portuguese 15th- and 16th-century chroniclers, G. E. de Azurara, J. de Barros, D. de Goes, F. Lopes, J. Osorio da Fonseca, R. de Pina, G. de Resende and L. de Sousa, and on the 19th-century historians, A. Herculano and J. P. Oliveira Martins. The most important collections of documents are *Collecção dos livros inéditos*, &c., ed. J. F. Corrêa da Serra (11 vols., Lisbon, 1790-1804); *Quadro elemental das relações politicas e diplomaticas de Portugal*, ed. first by the Viscount de Santarem (1856-1861) and afterwards, under the title of *Corpo diplomatico portuguez*, by L. A. Rebello da Silva (vols. i-iv.), J. J. da Silva Mendes Leal (v-ix.) and J. C. de Freitas Moniz (x., &c.). The *Collecção de tratados*, &c. (30 vols., Lisbon, 1856-1879), was ed. successively by Viscount J. F. Borges de Castro and J. Justice Biker; it was continued by the Royal Academy as the *Nova collecção de tratados* (2 vols., Lisbon, 1890-1891). See also *Portugaliae monumenta historica*, ed. A. Herculano and J. J. da Silva Mendes Leal (12 parts, Lisbon, 1856-1897); Diogo Barbosa Machado, *Bibliotheca lusitana* (4 vols., Lisbon, 1741-1759); Innocencio da Silva and (after vol. x.) P. W. de Brito Aranha, *Diccionario bibliographico portuguez* (Lisbon, 1858, &c.). Periodicals containing valuable historical matter are the *Arquivo historico portuguez* (Lisbon, 1903, &c.), the *Boletim* of the Lisbon Geographical Society (1873, &c.), and *Portugalia* (Oporto, 1898, &c.).

2. **General Histories.**—The *Historia de Portugal*, by J. P. Oliveira Martins (2 vols., 4th ed., Lisbon, 1901), is a series of brilliant impressionist studies. There is a popular illustrated *Historia de Portugal*, by A. Ennes, M. Pinheiro Chagas and others, in 37 parts (Lisbon, 1877-1883). See also H. Morse Stephens, *Portugal*, 4th ed., with additional chapter on the reign of D. Carlos, by Martin Hume (London, 1908); E. MacMurdo, *History of Portugal* (2 vols., London, 1888-1889); H. Schaefer, *Geschichte von Portugal* (5 vols., 2nd ed., Hamburg, 1874).

3. **Special Periods.**—A. Herculano's classic *Historia de Portugal* (4 vols., Lisbon, 1846-1853) covers the period up to 1279. II. da Gama Barros, *Historia da administração publica em Portugal nos seculos XVII. e XVIII.* (2 vols., Lisbon, 1895-1896) is a scientific study of the highest value. For the periods 1415-1460 and 1750-1777, see the authorities quoted under HENRY THE NAVIGATOR, and POMBAL. A critical bibliography for the period 1460-1580 is given by K. G. Jayne, in *Vasco da Gama*, &c. (London, 1910). For later history, see L. A. Rebello da Silva, *Historia de Portugal nos seculos XVII. e XVIII.* (5 vols., Lisbon, 1860-1871); J. M. Latino Coelho, *Historia de Portugal desde os fins do XVIII. seculo até 1814* (3 vols., Lisbon, 1874-1891); the authorities cited under PENINSULAR WAR; S. J. da Luz Soriano, *Historia da guerra em Portugal* (19 vols., Lisbon, 1866-1890); J. P. Oliveira Martins, *Portugal contemporaneo (1826-1868)*, (2 vols., 4th ed., Lisbon, 1906); J. L. Freire de Carvalho, *Memorias . . . para . . . a usurpação de D. Miguel* (4 vols., Lisbon, 1841-1849); Sir C. Napier, *An Account of the War . . . between D. Pedro and D. Miguel* (2 vols., London, 1835); W. Bollaert, *The Wars of Succession of Portugal and Spain, from 1821 to 1840* (2 vols., London, 1870). (K. G. J.)

LITERATURE

The Portuguese language can be most conveniently described in relation to the other languages of the Peninsula (see SPAIN: *Language*). Portuguese literature is distinguished by the wealth and variety of its lyric poetry, by its primacy in bucolic verse and prose, by the number of its epics and historical books, by the relative slightness of the epistolary element, and by the almost complete absence of the memoir. Rich as its *romanceiro* is, its volume is far less than the Spanish, but the *cançoneiros*

remain to prove that the early love songs of the whole Peninsula were written in Portuguese, while the primitive prose redaction of *Amadis*, the prototype of all romances of chivalry, was almost certainly made in Portugal, and a native of the same country produced in the *Diana* of Montemôr (Montemayor) the masterpiece of the pastoral novel. *The Lusíads* may be called at once the most successful epic cast in the classical mould, and the most national of poems, and the great historical monuments and books of travel of the 16th and 17th centuries are worthy of a nation of explorers who carried the banner of the Quinas to the ends of the earth. On the other hand Portugal gave birth to no considerable dramatist from the time of Gil Vicente, in the 16th century, until that of Garrett in the 19th, and it has failed to develop a national drama.

Its geographical position and history have rendered Portugal very dependent for intellectual stimulus and literary culture on foreign countries, and writers on Portuguese literature are wont to divide their subjects into periods corresponding to the literary currents from abroad which have modified its evolution. To summarize, the first literary activity of Portugal was derived from Provence, and Provençal taste ruled for more than a century; the poets of the 15th century imitated the Castilians, and the 16th saw the triumph of Italian or classical influence. Spain again imposed its literary standards and models in the 17th century, France in the 18th, while the Romantic movement reached Portugal by way of England and France; and those countries, and in less degree Germany, have done much to shape the literature of the 19th century. Yet as regards the Peninsula, the literatures of Portugal and Castile act and react on one another and if the latter gave much, she also received much, for nearly every Portuguese author of renown from 1450 until the 18th century, except Antonio Ferreira, wrote in Spanish, and some, like Jorge de Montemôr and Manoel de Mello, produced masterpieces in that language and are numbered as Spanish classics. Again, in no country was the victory of the Italian Renaissance and the classical revival so complete, so enduring.

But notwithstanding all its dependence on classical and foreign authors, Portuguese literature has a distinct individuality which appears in the romanceiro, in the songs named *cantares de amigo* of the *cancioneiros*, in the *Chronicles* of Fernão Lopes, in the *Historia tragico-maritima*, in the plays of Gil Vicente, in the bucolic verse and prose of the early 16th century, in the *Letters* of Marianna Alcoforado and, above all, in *The Lusíads*.

Early Period.—Though no literary documents belonging to the first century of Portuguese history have survived, there is evidence that an indigenous popular poetry both

Poetry. sacred and profane existed, and while Provençal influences moulded the manifestations of poetical talent for nearly two hundred years, they did not originate them. The close relations that prevailed between the reigning houses of Portugal, Provence and Aragon, cemented by intermarriages, introduced a knowledge of the *gay science*, but it reached Portugal by many other ways—by the crusaders who came to help in fighting the Moors, by the foreign prelates who occupied Peninsular sees, by the monastic and military orders who founded establishments in Portugal, by the visits of individual singers to court and baronial houses, but chiefly perhaps by the pilgrims who streamed from every country along the Frankish way to the far-famed shrine of Santiago de Compostela. Already by the end of the 12th century the lyric poetry of the troubadours had found cultivators in Portugal, and a few compositions which have come down to us bear a date slightly anterior to the year 1200. One of the earliest singers was D. Gil Sanches, an illegitimate son of Sancho I., and we possess a *cantar de amigo* in Galician-Portuguese, the first literary vehicle of the whole Peninsula, which appears to be the work of Sancho himself, and addressed to his concubine, A. Ribeirinha. The pre-Alphonsine period to which these men belong runs from 1200 to 1245 and produced little of moment, but in 1248 the accession of King Alphonso III., who had lived thirteen years in France, inaugurated a time of active and rich production which is

illustrated in the *Cancioneiro da Ajuda*, the oldest collection of Peninsular verse. The apogee of palace poetry dates from 1275 to 1280, when young King Diniz displayed his exceptional talents in a circle formed by the best troubadours of his father Alphonso III. and the veterans of his grandfather Alphonso II., whose song-book, *Cantigas de S. Maria*, contains the choicest religious verse of the age. Diniz, who had been educated by Amyeric of Cahors, proved himself the most fecund poet-king of his day, though the pleiad of *fidalgos* forming his court, and the *jograes* who flocked there from all parts, were fewer in number, less productive, and lacked the originality, vigour and brilliance of the singers who versified round Alphonso III.

The principal names of the Dionysian period (1284–1325) which is illustrated in the *Cancioneiro da Vaticana* are the king himself and his bastards D. Alphonso Sanches and D. Pedro, count of Barcellos. Of the two last, the former sings of love well and sincerely, while the latter is represented by love songs replete with false sentiment and by some rather gross songs of *maldizer*, a form which, if it rarely contains much poetical feeling or literary value, throws considerable light on the society of the time.

The verses of Diniz, essentially a love poet, are conventional in tone and form, but he can write pretty ballads and pastorals when he allows himself to be natural. The Portuguese troubadours belonged to all social classes, and even included a few priests, and though love was their favourite topic they used every kind of verse, and in satire they hold the palm. In other respects they are inferior to their Provençal masters. Speaking generally, the *cancioneiros* form monotonous reading owing to their poverty of ideas and conventionality of metrical forms and expression, but here and there men of talent who were poets by profession and better acquainted with Provençal literature endeavoured to lend their work variety by the use of difficult processes like the *lexaprem* and by introducing new forms like the *pastorela* and the *descorti*. It is curious to note that no heroic songs are met with in the *cancioneiros*; they are all with one exception purely lyrical in form and tone. The death of King Diniz proved a severe blow to troubadour verse, and the reign of his successor Alphonso IV. witnessed a profound decadence of court poetry, while there is not a single poem by a Portuguese author in the last half of the 14th century, and only the names of a few authors have survived, among them the Galicians Vasco Pires de Camoens, an ancestor of Luiz de Camoens, and the typical lover Macias. The *romanceiro*, comprising romances of adventures, war and chivalry, together with religious and sea songs, forms a rich collection of ballad poetry which continued in process of elaboration throughout the whole of the middle ages, but unfortunately the oldest specimens have perished and scarcely any of those existing bear a date anterior to the 15th century.

Epic poetry in Portugal developed much later than lyric, but the signal victory of the united Christian hosts over the Moors at the battle of the Salado in 1340 gave occasion to an epic by Alphonso Giraldes of which some fragments remain.

The first frankly literary prose documents appear in the 14th century, and consist of chronicles, lives of saints and genealogical treatises. The more important are the *Chronica breve do archivo nacional*, the *Chronicas de S. Cruz* *Early Prose.* *de Coimbra*, the *Chronica da conquista do Algarve* and the *Livros dos Linhagens*, aristocratic registers, portions of which, like the story of King Arthur, have considerable literary interest. All the above may be found in the *Portugaliae monumenta historica, scriptores*, while the Life of St Elizabeth of Portugal is included in the *Monarchia lusitana*; Romania has printed the following hagiographical texts belonging to the same century—the *Vida de Eufrosina*, the *Vida de Maria Egyptica* and the *Vida de Sancto Amaro*; the *Vida de Santo Eloy* has appeared in the *Instituto* and the *Vida dos Santos Barlaão e Josafate* has been issued by the Lisbon Academy of Sciences.

Romances of chivalry belonging to the various cycles must have penetrated into Portugal at an early date, and the *Nobiliario* of the Conde D. Pedro contains the genealogy of Arthur and the adventures of Lear and Merlin. There exists a mid-14th-century *Historia do Santo Graal*, and an unprinted *Josep*

ab *Aramadia*, while, though the MS. is lost, we have abundant evidence of the existence of a primitive Portuguese prose redaction of *Amadis de Gaula* anterior to the present Spanish text. Furthermore, the *Livro de Esopo* published by Dr Leite de Vasconcellos also belongs to the period, and there are other works in MS.

The 15th Century.—In the reign of John I. the court became an important literary centre, the king himself composed a *Livro de Montaria*, so far unedited, and his sons are rightly described as Camoens as "*inclyta geração, altos Infantes.*" King Edward (Duarte) collected a precious library composed of the ancient classics, some translated by his order, as well as medieval poems and histories, and he wrote a moral treatise *Leal conselheiro*, and hints on horsemanship, or *Livro da ensinança de bem cavalgar toda sella*. His brother D. Pedro also wrote a moral treatise *Da virtuosa Benfeitoria*, and caused Vegetius's *De re militari* and Cicero's *De officiis* to be turned into Portuguese. This travelled prince brought back from Venice a MS. of Marco Polo, the gift of the Senate, and is still remembered by the people through the story *Livro das viagens do Infante D. Pedro o qual andou ás sete partidas do mundo*, reprinted almost yearly, of which he is the hero. All the monarchs of the 15th century were highly educated men and patrons of letters; indeed, even that typical medieval knight Alphonso V. confesses, in his correspondence with Azurara, that the sword avails nothing without the pen. The age is noted for its chronicles, beginning with the anonymous life of the Portuguese Cid, the Holy Constable Nuno Alvares Pereira, told in charming infantile prose, the translated *Chronica da fundição do moesteyro de Sam Vicente*, and the *Vida de D. Tello*. Fernão Lopes (*q.v.*), the father of Portuguese history and author of chronicles of King Pedro, King Ferdinand and King John I., has been called by Southey the best chronicler of any age or nation. Gomes Eannes de Azurara completed Lopes's chronicle of King John by describing the capture of Ceuta, and wrote a chronicle of D. Pedro de Menezes, governor of the town down to 1437, and a chronicle of D. Duarte de Menezes, captain of Alcacer, but his capital work is the chronicle of the conquest of Guinea (see AZURARA).

Though not a great chronicler or an artist like Lopes, Ruy de Pina (*q.v.*) is free from the rhetorical defects of Azurara, and his chronicles of King Edward and King Alphonso V. are characterized by unusual frankness, and meritorious both as history and literature. All these three writers combined the posts of keeper of the archives and royal chronicler, and were, in fact, the king's men, though Lopes at least seems rather the historian of a people than the oracle of a monarch. Garcia de Resende (*q.v.*) appropriated Pina's chronicle of King John II., and after adding a wealth of anecdote and gossip and casting the glamour of poetry over a somewhat dry record, he reissued it under his own name. The taste for romances of chivalry continued throughout the 15th century, but of all that were produced the only one that has come down to us is the *Estorea do Imperador Vespasiano*, an introduction to the Graal Cycle, based on the apocryphal gospel of Nicodemus.

The Constable D. Pedro of Portugal, son of the prince of that name already referred to, has left some verses marked by elevation of thought and deep feeling, the *Satyra de Verse. felice e infelice vida*, and the death of his sister inspired his *Tragedia de la reína Isabel*; but he is best remembered by his *Coplas del contempto del mundo* in the *Cancioneiro Geral*. Though he actually drafted the first in his native tongue, all these poems are in Castilian, and D. Pedro is one of the first representatives of those Spanish influences which set aside the Provençal manner and in its place adopted a taste for allegory and a reverence for classical antiquity, both imported from Italy. It was to the constable that the marquis de Santillana addressed his historic letter dealing with the origins of Peninsular verse. The court poetry of the reigns of King Alphonso V. and King John II., so far as it survives, is contained in the lyrical collection known as the *Cancioneiro Geral*, compiled by Garcia de Resende and printed in 1516. Nearly three hundred authors are there represented by pieces in Portuguese and Castilian, and they

include D. João Manuel, D. João de Menezes, João Rodrigues de Sá e Menezes, Diogo Brandão, Duarte de Brito and Fernão da Silveira. The literary progenitors of the *cancioneiro* were the Spanish poets Juan de Mena, Jorge Manrique, Garcí-Sanchez de Badajoz and Rodriguez del Padron, and its main subjects are love, satire and epigram. The epic achievements of the Portuguese in that century, the discoveries and the wars in Africa, hardly find an echo, even in the verses of those who had taken part in them. Instead, an atmosphere of artificiality surrounds these productions, and the verses that reveal genuine poetical feeling are very few. They include a lament of Garcia de Resende on the death of Ignez de Castro which probably inspired the inimitable stanzas dedicated to the same subject in *The Lusíads*, the *Fingimento de Amores* by Diogo Brandão, the *Coplas* of D. Pedro already referred to, and a number of minor pieces. However, some names appeared in the *Cancioneiro Geral* which were to be among the foremost in Portuguese literature, e.g. Bernardim Ribeiro, Christovam Falcão, Gil Vicente, and Sá de Miranda, who represent the transition between the Spanish school of the 15th and the Italian school of the 16th century, the members of which are called *Os Quinhentistas*. Ribeiro and Falcão, the introducers of the bucolic style, put new life into the old forms, and by their eclogues in *redondilhas*, breathing the deepest and most genuine feeling in verses of perfect harmony, they gave models which subsequent writers worked by but could never equal.

The Drama.—The history of the modern drama begins with religious plays, followed at a later period by moralities, and thence, by an easy transition, by the farce. This transition from the presentment of traditional types to the modern play can be traced in the works of Gil Vicente, the father of the Portuguese theatre. His first efforts belonged to the religious drama, and some of the more notable had edification for their object, e.g. the *Barca do Inferno*, but even in this class he soon introduces the comic element by way of relief, and in course of time he arrives at pure comedy and develops the study of character. For a detailed description and criticism of his work, see VICENTE.

In the various towns where he stayed and produced his plays, writers for the stage sprang up, and these formed the *Eschola Velha* or school of Gil Vicente. To name the best known, Evora, the city of culture, produced Afonso Alvarez, author of religious pieces, Antonio Ribeiro, nicknamed "the Chiado," an unfrocked friar with a strong satirical vein who wrote farces in the Bazochian style, and his brother Jeronimo Ribeiro. In Santarem appeared Antonio Prestes, a magistrate who drew from his judicial experience but evinced more knowledge of folk-lore than dramatic talent, while Camoens himself was so far influenced by Gil Vicente, whose plays he had perhaps seen performed in Lisbon, that in spite of his Coimbra training he never exchanged the old forms for those of the classical comedy. His *Amphitryons* is a free imitation of the Latin, yet thoroughly national in spirit and cast in the popular *redondilha*; the dialogue is spirited, the situations comic. *King Seleucus* derives from Plutarch and has a prose prologue of real interest for the history of the stage, while *Filodemo* is a clever tragi-comedy in verse with prose dialogues interspersed. Another poet of the same school is Balthazar Dias, the blind poet, whose simple religious *autos* are still performed in the villages, and are continually reprinted, the best liked being the *Auto of St Alexis*, and the *Auto of St Catherine*. He is purely medieval in subject and spirit, his lyrics are perfect in form and expression, his diction thoroughly popular. One of the last dramatists of the 16th century belonging to the old school was Simão Machado, who wrote the *Comedy of Diu* and the *Enchantments of Alsea*, two long plays almost entirely in Spanish, and full of digressions only made tolerable by the beauty of their lyrics.

Except Camoens, all these men, though disciples of Gil Vicente, are decidedly inferior to him in dramatic invention, fecundity and power of expression, and they were generally of humble social position. Moreover the favour of the court was withdrawn on the death of Gil Vicente, and this meant much, for

there existed no educated middle class to support a national theatre. At the same time the old dramatists had to face the opposition of the classical school, which appealed to the cultured, and the hostility of the Inquisition, which early declared war on the popular plays on account of their grossness, and afterwards through the index prohibited altogether even the religious *autos*, as it had condemned the Italian comedies. The way was thus clear for the Jesuits, who, with their Latin tragi-comedies or dramatized allegories written to commemorate saints or for scholastic festivals, succeeded for a time in supplanting both the popular pieces of the old school and the plays modelled on the masterpieces of Greece and Rome. The old dramatists came to write for the lower classes only, and though the school lingered on, its productions were performed solely by travelling companies at country fairs. Though we know that much has perished, the four Indexes of the 16th century give some idea of the rich repertory of the popular theatre, and of the efforts necessary to destroy it; moreover, the Spanish Index of 1559, by forbidding *autos* of Gil Vicente and other Portuguese authors, is interesting evidence of the extent to which they were appreciated in the neighbouring country.

The Renaissance.—The movement commonly called the Renaissance reached Portugal both indirectly through Spain and directly from Italy, with which last country it maintained close literary relations throughout the 15th century. King Alphonso V. had been the pupil of Matthew of Pisa and summoned Justus Balduinus to his court to write the national history in Latin, while later King John II. corresponded with Politian, and early in his reign the first printing-press got to work. In the next century many famous humanists took up their abode in Portugal. Nicholas Cleynarts taught the Infant Henry, afterwards cardinal and king, and lectured on the classics at Braga and Evora, Vasaes directed a school of Latin at Braga, and George Buchanan accompanied other foreign professors to Coimbra when King John III. reformed the university. Many distinguished Portuguese teachers returned from abroad to assist the king at the same time, among them Ayres Barbosa from Salamanca, André de Gouveia of the Parisian college of St Barbe, whom Montaigne dubbed "the greatest principal of France," Achilles Estaço and Diogo de Teive.

At home Portugal produced André de Resende (*q.v.*), author of the *Historia da antiguidade da cidade de Evora* and *De antiquitatibus Lusitaniae*, and Francisco de Hollanda, painter, architect, and author of, *inter alia*, the *Quatro dialogos da pintura antiga*. Moreover, women took a share in the intellectual movement of the time, and the sisters Luisa and Angela Sigêa, Joanna Vaz and Paula Vicente, daughter of Gil Vicente, constituted an informal female academy under the presidency of the Infanta D. Maria, daughter of King Manoel. Luisa Sigêa was both an orientalist and a Latin poetess, while Publica Hortensia de Castro, after a course of humanities, philosophy and theology, defended theses at Evora in her eighteenth year.

The Italian school was founded by Sá de Miranda (*q.v.*), a man of noble character who, on his return in 1526 from a six years' stay in Italy, where he had foregathered with the leading writers of the day, initiated a reform of Portuguese literature which amounted to a revolution. He introduced and practised the forms of the sonnet, canzon, ode, epistle in *oitava rima* and in tercets, and the epigram, and raised the whole tone of poetry. At the same time he gave fresh life to the national redondilha metre (*medida velha*) by his *Cartas* or *Satiras* which with his *Eclogues*, some in Portuguese, others in Castilian, are his most successful compositions. His chief disciple, Antonio Ferreira (*q.v.*), a convinced classicist, went further, and dropping the use of Castilian, wrote sonnets much superior in form and style, though they lack the rustic atmosphere of those of his master, while his odes and epistles are too obviously reminiscent of Horace. D. Manoel de Portugal, Pero de Andrade Caminha, Diogo Bernardes, Frei Agostinho da Cruz and André Falcão de Resende continued the erudite school, which, after considerable opposition, definitely triumphed in the person of Luiz de Camoens. The *Lima* of Bernardes

contains some beautiful eclogues as well as *cartas* in the bucolic style, while the odes, sonnets, and eclogues of Frei Agostinho are full of mystic charm. Camoens (*q.v.*) is, as Schlegel remarked, an entire literature in himself, and some critics rate him even higher as a lyric than as an epic poet. He unites and fuses the best elements of the Italian and the popular muse, using the forms of the one to express the spirit and traditions of the other, and when he employs the *medida velha*, it becomes in his hands a vehicle for thought, whereas before it had usually served merely to express emotions.

His *Lusiads*, cast in the Virgilian mould, celebrates the combination of faith and patriotism which led to the discoveries and conquests of the Portuguese, and though the *Epic Poetry* voyage of Vasco da Gama occasioned its composition and formed the skeleton round which it grew, its true subject is the *peito illustre lusitano*. Immediately on its appearance *The Lusiads* took rank as the national poem *par excellence*, and its success moved many writers to follow in the same path; of these the most successful was Jeronymo Corte Real (*q.v.*). All these poems, like the *Elegiada* of Luis Pereira Brandão on the disaster of Al Kasr, the *Primeiro cerco de Diu* of the chronicler Francisco de Andrade, and even the *Affonso Africano* of Quevedo, for all its futile allegory, contain striking episodes and vigorous and well-coloured descriptive passages, but they cannot compare with *The Lusiads* in artistic value.

The return of Sá de Miranda from Italy operated to transform the drama as well as lyric poetry. He found the stage occupied mainly by religious plays in which there appeared *The Classical Comedy and Tragedy*. no trace of the Greek or Roman theatre, and, admiring what he had seen in Italy, he and his followers protested against the name *auto*, restored that of *comedy*, and substituted prose for verse. They generally chose the plays of Terence as models, yet their life is conventional and their types are not Portuguese but Roman-Italian. The revived classical comedy was thus so bound down by respect for authority as to have little chance of development, while its language consisted of a latinized prose from which the emotions were almost absent. Though it secured the favour of the humanists and the nobility, and banished the old popular plays from both court and university soon after Gil Vicente's death, its victory was shortlived. Jorge Ferreira de Vasconcellos, who produced in the *Eufrosina* the first prose play, really belongs to the Spanish school, yet, though he wrote under the influence of the *Celestina*, which had a great vogue in Portugal, and of Roman models, his types, language and general characteristics are deeply national. However, even if they had stage qualities, the very length of this and his other plays, the *Ulisipo* and the *Aulegraphia*, would prevent their performance, but in fact they are novels in dialogue containing a treasury of popular lore and wise and witty sayings with a moral object. So decisive was the success of Jorge Ferreira's new invention, notwithstanding its anonymity, that it decided Sá de Miranda to attempt the prose comedy. He modelled himself on the Roman theatre as reflected by the plays of Ariosto, and he avowedly wrote the *Estrangeiros* to combat the school of Gil Vicente, while in it, as in *Os Vilhalpandos*, the action takes place in Italy. Antonio Ferreira, the chief dramatist of the classical school, knew both Greek and Latin as well as Miranda, but far surpassed him in style. He attempted both comedy and tragedy, and his success in the latter branch is due to the fact that he was not content to seek inspiration from Seneca, as were most of the tragedians of the 16th century, but went straight to the fountain heads, Sophocles and Euripides. His *Bristo* is but a youthful essay, but his second piece, *O Cioso*, is almost a comedy of character, though both are Italian even in the names of the personages. Ferreira's real claim to distinction, however, rests on *Ignez de Castro* (see FERREIRA).

The principal form taken by prose writing in the 16th century was historical, and a pleiad of distinguished writers arose to narrate the discoveries and conquests in Asia, Africa and the ocean. Many of them saw the achievements they relate and were inspired by patriotism to record them, so that their writings

lack that serene atmosphere of critical appreciation which is looked for if history is to take its place as a science. In the four decades of his *Asia*, João de Barros, the Livy of his country, tells in simple vigorous language the "deeds achieved by the Portuguese in the discovery and conquest of the seas and lands of the Orient." His first decade undoubtedly influenced Camoens, and together the two men fixed the Portuguese written tongue, the one by his prose, the other by his verse. The decades, which were continued by Diogo do Couto, a more critical writer and a clear and correct stylist, must be considered the noblest historical monument of the century (see BARROS). Couto is also responsible for some acute observations on the causes of Portuguese decadence in the East, entitled *Soldado pratico*.

The word encyclopaedist fits Damião de Goes, a diplomatist, traveller, humanist and bosom friend of Erasmus. One of the most critical spirits of the age, his chronicle of King Manoel, the Fortunate Monarch, which he introduced by one of Prince John, afterwards King John II., is worthy of the subject and the reign in which Portugal attained the apogee of its greatness. Goes (*q.v.*) wrote a number of other historical and descriptive works in Portuguese and Latin, some of which were printed during his residence in the Low Countries and contributed to his deserved fame. After twenty years of investigation at Goa, Fernão Lopes de Castanheda issued his *Historia do descobrimento e conquista da Índia pelos Portuguezes* (Lisbon, 1552-1554 and 1561), a book that ranks besides those of Barros and Couto. Antonio Galvão, who, after governing the Moluccas with rare success and integrity, had been offered the native throne of Ternate, went home in 1540, and died a pauper in a hospital, his famous treatise only appearing posthumously. The *Tratado dos diversos . . . caminhos por onde a pimenta e especiaria veyo da India . . . e assim de todos os descubrimentos . . . que são feitos em a era de 1560* has been universally recognized as of unique historical value. Like the preceding writers, Gaspar Correia or Corréa lived long years in India and embodied his intimate knowledge of its manners and customs in the picturesque prose of the *Lendas da India*, which embraces the events of the years 1497 to 1550. Among other historical works dealing with the East are the *Commentarios de Affonso d'Albuquerque*, an account of the life of the great captain and administrator, by his natural son, and the *Tratado das cousas da China e de Ormuz*, by Frei Gaspar da Cruz.

Coming back to strictly Portuguese history, we have the uncritical *Chronica de D. João III.* by Francisco de Andrade, and the *Chronica de D. Sebastião* by Frei Bernardo da Cruz, who was with the king at Al Kasr al Kebir, while Miguel Leitão de Andrade, who was taken prisoner in that battle, related his experiences and preserved many popular traditions and customs in his *Miscellanea*. Bishop Osorio (*q.v.*), a scholar of European reputation, wrote chiefly in Latin, and his capital work, a chronicle of King Manoel, is in that tongue.

The books of travel of this century are unusually important because their authors were often the first Europeans to visit or at least to study the countries they refer to. They include, to quote the more noteworthy, the *Descobrimto de Frolida*, the *Itinerario* of Antonio Tenreiro, the *Verdadeira informação das terras do Preste João* by Francisco Alvares and the *Ethiopia oriental* by Frei João dos Santos, both dealing with Abyssinia, the *Itinerario da terra santa* by Frei Pantaleão de Aveiro, and that much-translated classic, the *Historia da vida do padre Francisco Xavier* by Padre João de Lucena. Fernão Cardim in his *Narrativa epistolar* records a journey through Brazil, and Pedro Teixeira relates his experiences in Persia. But the work that holds the palm in its class is the *Peregrinação* which Fernão Mendes Pinto (*q.v.*), the famous adventurer, composed in his old age for his children's reading. While Mendes Pinto and his book are typically Portuguese of that age, the *Historia tragicomarmarítima*, sometimes designated the prose epic of *saudade*, is equally characteristic of the race of seamen which produced it. This collection of twelve stories of notable wrecks which befell Portuguese ships between 1552 and 1604 contains that of the

galleon "St John" on the Natal coast, an event which inspired Corte-Real's epic poem as well as some poignant stanzas in *The Lusíads*, and the tales form a model of simple spontaneous popular writing.

The romance took many forms, and in two of them at least works appeared which exercised very considerable influence abroad. The *Menina e moça* of Bernardim Ribeiro, a tender pastoral story inspired by *saudade* for his lady-love, probably moved Montemôr or Montemayor (*q.v.*) to write his *Diana*, and may some fifty years later have suggested the *Lusitania transformada* to Fernão Alvares do Oriente, who, however, like Ribeiro, owes some debt to Sannazaro's *Arcadia*. To name the *Palmeirim d'Inglaterra* of Moraes (*q.v.*) is to mention a famous book from which, we are told, Burke quoted in the House of Commons, while Cervantes had long previously declared that it ought to be guarded as carefully as the works of Homer. Like most successful romances of chivalry, it had a numerous progeny, but its sequels, *D. Duardos* by Diogo Fernandes, and *D. Ciarisel de Bretanha* by Gonçalves Lobato, are quite inferior. The historian Barros tried his youthful pen in a romance of chivalry, the *Chronica do Imperador Clarimundo*, while in another branch, and a popular one in Portugal, the Arthurian cycle, the dramatist Ferreira de Vasconcellos wrote *Sagramor* or *Memorial das proesas da segunda Tavola Redonda*. A book of quite a different order is the *Contos de proveito e exemplo* by Fernandes Trancoso, containing a series of twenty-nine tales derived from tradition or imitated from Boccaccio and others, which enjoyed deserved favour for more than a century.

Samuel Usque, a Lisbon Jew, deserves a place to himself for his *Consolaçam ás tribulações de Israel*, where he exposes the persecutions endured by his countrymen in every age down to his time; the book takes the dialogue form, and its diction is elegant and pure. The important part taken by Portuguese prelates and theologians at the Council of Trent stimulated religious writing, most of it in Latin, but Frei Bartholomeu dos Martyres, archbishop of Braga, wrote a *Cathecismo da doutrina Christã*, Frei Luiz de Granada a *Compendio de Doutrina Christã* and *Sermões*, all in Portuguese, and other notable pulpit orators include Diogo de Paiva de Andrade, Padre Luiz Alvares, Dom Antonio Pinheiro and Frei Miguel dos Santos, who preached at the obsequies of King Sebastian.

Among the moralists of the time three at least deserve the title of masters of prose style, Heitor Pinto for his *Imagens da vida Christã*, Bishop Arráz for his *Dialogos*, and Frei Thomé de Jesus for his noble devotional treatise *Trabalhos de Jesus*, while the maxims of Joanna da Gama, entitled *Ditos da Freira*, though lacking depth, form a curious psychological document. The ranks of scientists include the cosmographer Pedro Nunes (Nonius), a famous mathematician, and the botanist Garcia da Orta, whose *Colloquios dos simples e drogas* was the first book to be printed in the East (1563), while the form of Aristotelian scholastic philosophy known as *Philosophia conimbricensis* had a succession of learned exponents. As, however, their vehicle was Latin, a mere mention must suffice, and for the same reason only the title of a notable book by Francisco Sanches can be given, the *De nobili et prima universalí scientia quod nihil scitur*.

In 1536 Fernão de Oliveira published the first Portuguese grammar, and three years later the historian Barros brought out his *Cartinha para aprender a ler*, and in 1540 his *Grammatica*. Magalhães Gandavo printed some rules on orthography in 1574. Nunes de Leão also produced a treatise on orthography in 1576 and a work on the origins of the language in 1605, and Jeronymo Cardoso gave his countrymen a Latin and Portuguese dictionary.

The 17th Century.—The gigantic efforts put forth in every department of activity during the 16th century led to the inevitable reaction. Energy was worn out, patriotic ardour declined into blind nationalist vanity, and rhetoric conquered style. From a literary as from a political point of view the 17th century found Portugal in a lamentable state of decadence which dated from

Romances,
&c.

Os Seiscen-
tistas.
Lyric
Poetry.

the preceding age. In 1536 the Inquisition began its work, while between 1552 and 1555 the control of higher education passed into the hands of the Jesuits. Following the Inquisition and the Jesuits came two other obstacles to the cultivation of letters, the censorship of books and the Indexes, and, as if these plagues were not enough, the Spanish domination followed. Next the taint of Gongorism appeared, and the extent to which it affected the literature of Portugal may be seen in the five volumes of the *Fenix renascida*, where the very titles of the poems suffice to show the futilities which occupied the attention of some of the best talents. The prevailing European fashion of literary academies was not long in reaching Portugal, and 1647 saw the foundation of the *Academia dos Generosos* which included in its ranks the men most illustrious by learning and social position, and in 1663 the *Academia dos Singulares* came into being; but with all their pedantry, extravagances and bad taste, it must be confessed that these and similar corporations tended to promote the pursuit of good literature. In bucolics there arose a worthy disciple of Ribeiro in Francisco Rodrigues Lobo (*q.v.*), author of the lengthy pastoral romances *Corte na aldêa* and *Primavera*, the songs in which, with his eclogues, earned him the name of the Portuguese Theocritus. The foremost literary figure of the time was the encyclopaedic Francisco Manoel de Mello (*q.v.*), who, though himself a Spanish classic, strove hard and successfully to free himself from subservience to Spanish forms and style. Most of the remaining lyricists of the period were steeped in Gongorism or, writing in Spanish, have no place here. It suffices to mention Soror Violente do Céu, an exalted mystic called "the tenth muse," Bernarda Ferreira de Lacerda, author of the *Soledades de Bussaco*, the *Laura do Anfrizo* of Manoel Tagarro, the *Sylvia de Lizardo* of Frei Bernardo de Brito, and the poems of Frei Agostinho das Chagas, who, however, is better represented by his *Cartas espirituais*. Satirical verse had two notable cultivators in D. Thomas de Noronha and Antonio Serrão de Castro, the first a natural and facile writer, the second the author of *Os Ratos da Inquisição*, a facetious poem composed during his incarceration in the dungeons of the Inquisition, while Diogo de Sousa Camacho showed abundant wit at the expense of the slaves of Gongorism and Marinism.

The gallery of epic poets is a large one, but most of their productions are little more than rhymed chronicles and have almost passed into oblivion. The *Ulysses* of Gabriel Pereira de Castro describes the foundation of Lisbon by Ulysses, but, notwithstanding its plagiarism of *The Lusíads* and faults of taste, these ten cantos contain some masterly descriptive passages, and the *ottava rima* shows a harmony and flexibility to which even Camoens rarely attained; but this praise cannot be extended to the tiresome *Ulyssipo* of Sousa de Macedo. The *Malaca conquistada* of Francisco de Sá de Menezes, having Alphonso d'Albuquerque for its hero, is prosaic in form, if correct in design. Rodriguez Lobo's twenty cantos in honour of the Holy Constable do him no credit, but the *Viriato tragico* by that travelled soldier Garcia de Mascarenhas has some vigorous descriptions, and critics reckon it the best epic of the second class.

In point of style the historians of the period are laboured and rhetorical; they were mostly credulous friars who wrote in their cells, and no longer, as in the 16th century, travellers and men of action who described what they had seen.

Frei Bernardo de Brito began his ponderous *Monarchia Lusitana* with the creation of man and ended it where he should have begun, with the coming of Count Henry to the Peninsula. His contribution is a mass of legends destitute of foundation or critical sense, but both here and in the *Chronica de Cister* he writes a good prose. Of the four continuers of Brito's work, three are no better than their master, but Frei Antonio Brandão, who dealt with the period from King Alphonso Henriques to King John II., proved himself a man of high intelligence and a learned, conscientious historian.

Frei Luiz de Sousa, a typical monastic chronicler, although he had begun life as a soldier, worked up the materials collected by

others, and after much *labor limae* produced the panegyric *Vida de D. Frei Bartholemeu dos martyres*, the *Historia de S. Domingos*, and the *Annaes d'el rei D. João III.* His style is lucid and vivid, but he lacks the critical sense, and the speeches he puts into the mouths of his characters are imaginary. Manoel de Faria y Sousa (*q.v.*), a voluminous writer on Portuguese history and the arch-commentator of Camoens, wrote, by an irony of fate, in Spanish, and Mello's classic account of the Catalonian War is also in that language, while, by a still greater irony, Jacinto Freire de Andrade thought to picture and exalt the Cato-like viceroy of India by his grandiloquent *Vida de D. João de Castro*.

Other historical books of the period are the valuable *Discursos* of Severim de Faria, the *Portugal restaurado* of D. Luis de Menezes, conde de Ericeira, the ecclesiastical histories of Archbishop Rodrigo da Cunha, the *Agiologio lusitano* of Jorge Cardoso and the *Chronica da Companhia de Jesus* by Padre Balthazar Telles. The last also wrote an *Historia da Ethiopia*, and, though the travel literature of this century compares badly with that of the preceding, mention may be made of the *Itinerario da India por terra até a ilha de Chipre* of Frei Gaspar de S. Bernardino, and the *Relação do novo caminho através da Arabia e Syria* of Padre Manoel Godinho.

In the 17th century the religious orders and especially the Jesuits absorbed even more of the activities and counted for more in the public affairs of Portugal than in the preceding age. The pulpit discharged some of the functions of the modern press, and men who combined the gifts of oratory and writing filled it and distinguished themselves, their order and their country. The Jesuit Antonio Vieira (*q.v.*), missionary, diplomat and voluminous writer, repeated the triumphs he had gained in Bahia and Lisbon in Rome, which proclaimed him the prince of Catholic orators. His 200 sermons are a mine of learning and experience, and they stand out from all others by their imaginative power, originality of view, variety of treatment and audacity of expression. His letters are in a simple conversational style, but they lack the popular locutions, humour and individuality of those of Mello. Vieira was a man of action, while the oratorian Manoel Bernardes lived as a recluse, hence his sermons and devotional works, especially *Luz e Calor* and the *Nova Floresta*, breathe a calm and sweetness alien to the other, while they are even richer treasures of pure Portuguese. Perhaps the truest and most feeling human documents of the century are the five epistles written by Marianna Alcoforado (*q.v.*) known to history as the *Letters of a Portuguese Nun*. Padre Ferreira de Almeida's translation of the Bible has considerable linguistic importance, and philological studies had an able exponent in Amaro de Roboredo.

The popular theatre lived on in the *Comedias de Cordel*, mostly anonymous and never printed its existence would hardly be known were it not for the pieces which were placed on the Index. The popular *autos* that have survived are mainly religious, and show the abuse of metaphor and the conceits which derive from Gongora. All through this century Portuguese dramatists, who aspired to be heard, wrote, like Jacintho Cordeiro and Mattos Fragoso, in Castilian, though a brilliant exception appeared in the person of Francisco Manoel de Mello (*q.v.*), whose witty *Auto do fidalgo aprendiz* in redondilhas is eminently national in language, subject and treatment. Until the Restoration of 1640 the stage remained spellbound by the Spaniards, and when a court once more came to Lisbon it preferred Italian opera, French plays, and *zarzuelas* to dramatic performances in the vernacular, with the result that both Portuguese authors and actors of repute disappeared.

The 18th Century.—The first part of the 18th century differs little from the preceding age except that both affectation and bad taste tended to increase, but gradually signs appeared of a literary revolution, which preceded the political and developed into the Romantic movement. Men of liberal ideas went abroad, chiefly to France, to escape the stupid tyranny that ruled in Church and state, and to their exhortation and example

are largely due the reforms which were by degrees inaugurated in every branch of letters. Their names were among others Alexandre de Gusmão, the Cavalheiro de Oliveira, Ribeiro Sanches, Corrêa da Serra, Brotero and Nascimento. They had a forerunner in Luiz Antonio Verney, who poured sarcasm on the prevailing methods of education, and exposed to good effect the extraordinary literary and scientific decadence of Portugal in an epoch-making work, the *Verdadeiro methodo de estudar*.

From time to time literary societies, variously called academies or arcadias, arose to co-operate in the work of reform. In 1720 King John V., an imitator of Louis XIV., established the academy of history. The fifteen volumes of its *Memorias*, published from 1721 to 1756, show the excellent work done by its members, among whom were Caetano de Sousa, author of the colossal *Historia da Casa Real portugueza*, Barbosa Machado, compiler of the invaluable *Bibliotheca Lusitana*, and Soares da Silva, chronicler of the reign of King John I.

The Royal Academy of Sciences founded in 1780 by the 2nd duke of Lafões, uncle of Queen Maria I., still exists, though its output and influence are small. Its chief contributions to knowledge were the *Diccionario da lingua portugueza*, still unfinished, and the *Memorias* (1788-1795), and it included in its ranks nearly all the learned men of the last part of the 18th century. Among them were the ecclesiastical historian Frei Manoel do Cenaculo, bishop of Beja, the polygraph Ribeiro dos Santos, Caetano do Amaral, a patient investigator of the origins of Portugal, João Pedro Riberio, the founder of modern historical studies, D. Francisco Alexandre Lobo, bishop of Vizeu, whose essays on Camoens and other authors show sound critical sense and a correct style, Cardinal Saraiva, an expert on ancient and modern history and the voyages of his countrymen, and Frei Fortunato de S. Boaventura, a historical and literary critic.

In 1756 Cruz e Silva (*q.v.*), with the aid of friends, established the *Arcadia Ulyssiponense*, "to form a school of good sayings and good examples in eloquence and poetry." The most considered poets of the day joined the Arcadia and individually wrote much excellent verse, but they all lacked creative power. The principal Greek and Latin authors were the models they chose, and Garção, the most prominent Arcadian, composed the *Cantata de Dido*, a gem of ancient art, as well as some charming sonnets to friends and elegant odes and epistles. The bucolic verse of Quita, a hair-dresser, has a tenderness and simplicity which challenge comparison with Bernardim Ribeiro, and the *Marilia* of Gonzaga contains a celebrated collection of bucolic-erotic verse. Their conventionality sets the lyrics of Cruz e Silva on a lower plane, but in the *Hyssope* he improves on the *Lutrin* of Boileau. After a chequered existence, internal dissensions caused the dissolution of the Arcadia in 1774. It had only gained a partial success because the despotic rule of Pombal, like the Inquisition before him, hindered freedom of fancy and discussion, and drove the Arcadians to waste themselves on flattering the powerful. In 1790 a New Arcadia came into being. Its two most distinguished members were the rival poets Bocage (*q.v.*) and Agostinho de Macedo (*q.v.*). The only other poet of the New Arcadia who ranks high is Curvo Semedo; but the Dissidents, a name bestowed on those who stood outside the Arcadias, included two distinguished men now to be cited, the second of whom became the herald of a poetical revolution. No Portuguese satirist possessed such a complete equipment for his office as Nicolao Tolentino, and though a dependent position depressed his muse, he painted the customs and follies of the time with almost photographic accuracy, and distributed his attacks or begged for favours in sparkling verse. The task of purifying and enriching the language and restoring the cult of the Quinhentistas was perseveringly carried out by Francisco Manoel de Nascimento (*q.v.*) in numerous compositions in prose and verse, both original and translated. Shortly before his death in Paris he became a convert to the Romantic movement, and he prepared the way for its definite triumph in the person of

Almeida Garrett, who belonged to the *Filintistas*, or followers of Nascimento, in opposition to the *Elmanistas*, or disciples of Bocage.

Early in the 18th century the spirit of revolt against despotism led to an attempt at the restoration of the drama by authors sprung from the people, who wrote for spectators as coarse as they were ignorant of letters. Its centres were the theatres of the Bairro Alto and Mouraria, and the numerous pieces staged there belong to low comedy. The *Operas portuguezas* of Antonio José da Silva (*q.v.*), produced between 1733 and 1741, owe their name to the fact that *arias*, *minuets* and *modinhas* were interspersed with the prose dialogue, and if neither the plots, style, nor language are remarkable, they have a real comic force and a certain originality. Silva is the legitimate representative in the 18th century of the popular theatre inaugurated by Gil Vicente, and though born in Brazil, whence he brought the *modinha*, he is essentially a national writer. Like Silva's operas, the comedies of Nicolao Luiz contain a faithful picture of contemporary society and enjoyed considerable popularity. Luiz divided his attention between heroic comedies and comedies *de capa y espada*, but of the fifty-one ascribed to him, all in verse, only one bears his name, the rest appeared anonymously. His method was to choose some Spanish or Italian play, cut out the parts he disliked, and substitute scenes with dialogues in his own way, but he has neither ideals, taste nor education; and, except in *Os Maridos Peraltas*, his characters are lifeless and their conventional passions are expressed in inflated language. Notwithstanding their demerits, however, his comedies held the stage from 1760 until the end of the century.

Meanwhile the Arcadia also took up the task of raising the tone of the stage, but though the ancients and the classic writers of the 16th century were its ideals, it drew immediate inspiration from the contemporary French theatre. All its efforts failed, however, because its members lacked dramatic talents and, being out of touch with the people, could not create a national drama.

Garção (*q.v.*) led the way with the *Theatro Novo*, a bright little comedy in blank verse, and followed it up with another, *Assemblea ou partida*; but he did not persevere. Figueiredo felt he had a mission to restore the drama, and wrote thirteen volumes of plays in prose and verse, but, though he chose national subjects, and could invent plots and draw characters, he could not make them live. Finally, the bucolic poet Quita produced the tragedies *Segunda Castro*, *Hermione* and two others, but these imitations from the French, for all the taste they show, were stillborn, and in the absence of court patronage, which was exclusively bestowed on the Lisbon opera, then the best equipped in Europe, Portugal remained without a drama of its own.

Sacred eloquence is represented by Fr. Alexandre Palhares, a student of Vieira, whose outspoken attack on vice in high places in a sermon preached before Queen Maria led to his exile from court. The art of letter-writing had cultivators in Abbade Costa, Ribeiro Sanches, physician of Catherine II. of Russia, Alexandre de Gusmão, and the celebrated Cavalheiro de Oliveira, also author of *Memorias politicas e literarias*, published at the Hague, whither he had fled to escape the Inquisition. Philological studies were pursued with ardour and many valuable publications have to be recorded, among them Bluteau's *Vocabulario Portuguez*, the *Reflexões sobre a lingua portugueza* and an *Arte poetica* by Francisco José Freire, the *Exercícios* and *Espirito da lingua e eloquencia* of Pereira de Figueiredo, translator of the Vulgate, and Viterbo's *Elucidario*, a dictionary of old terms and phrases which has not been superseded. Finally the best literary critic and one of the most correct prose writers of the period is Francisco Dias Gomes.

The 19th Century and After.—The 19th century witnessed a general revival of letters, beginning with the Romantic movement, of which the chief exponents were Garrett (*q.v.*) and Herculano (*q.v.*), both of whom had to leave Portugal on account of their political liberalism, and it was inaugurated in the

field of poetry. Garrett read the masterpieces of contemporary foreign literature during his exiles in England and France, and, imbued with the national spirit, he produced in 1825 the poem *Camões*, wherein he broke with the established rules of composition in verse and destroyed the authority of the Arcadian rhymers. His poetry like that of his fellow *emigré*, the austere Herculano, is eminently sincere and natural, but while his short lyrics are personal in subject and his longer poems historical, the verse of Herculano is generally subjective and the motives religious or patriotic. The movement not only lost much of its virility and genuineness, but became ultra-Romantic with A. F. de Castilho (*q.v.*), whose most conspicuous followers were João de Lemos and the poets of the collection entitled *O Trovador*; Soares de Passos, a singer for the sad; the melodious Thomas Ribeiro, who drew his inspiration from Zorilla and voiced the opposition to a political union with Spain in the patriotic poem *D. Jayme*. Mendes Leal, a king in the heroic style, Gomes de Amorim and Bulhão Pato, belong more or less to the same school. On the other hand José Simões Dias broke with the Romantic tradition in which he had been educated, and successfully sought inspiration from popular sources, as his *Peninsulares* proves.

In 1865 there arose a serious and lengthy strife in the Portuguese Parnassus, which came to be known as the Coimbra question, from its origin in the university city. Its immediate cause was the preface which Castilho contributed to the poem *Moçidade* of Pinheiro Chagas, and it proclaimed the alliance of poetry with philosophy. The younger men of letters regarded Castilho as the self-elected pontiff of a mutual-praise school, who, ignorant of the literary movement abroad, claimed to direct them in the old paths, and would not tolerate criticism. The revolt against his primacy took the form of a fierce war of pamphlets, and led ultimately to the dethronement of the blind bard. The leaders in the movement were Anthero de Quental (*q.v.*) and Dr Theophilo Braga, the first a student of German philosophy and poetry, the second a disciple of Comte and author of an epic of humanity, *Visão dos tempos*, whose immense work in the spheres of poetry, criticism and literary history, marred by contradictions, but abounding in life, cannot be judged at present. In the issue literature gained considerably, and especially poetry, which entered on a period of active and rich production, still unchecked, in the persons of João de Deus (*q.v.*) and the Coimbraans and their disciples. The *Campo de flores* contains some of the most splendid short poems ever written in Portuguese, and an Italian critic has ventured to call João de Deus, to whom God and women were twin sources of inspiration, the greatest love poet of the 19th century. Simplicity, spontaneity and harmony distinguished his earlier verses, which are also his best, and their author belongs to no school but stands alone. A preponderance of reflection and foreign influences distinguish the poets now to be mentioned. Anthero de Quental, the chief of the Coimbraans, enshrined his metaphysical neo-Buddhistic ideas overshadowed by extreme pessimism, and marked the stages of his mental evolution, in a sequence of finely-wrought sonnets. These place him in the sacred circle near to Heine and Leopardi, and, though strongly individualistic, it is curious to note in them the influence of Germanism on the mind of a southerner and a descendant of the Catholic navigators of the 16th century. *Odes modernas*, written in youth, show "Santo Anthero," as his friends called him, in revolutionary, free-thinking and combative mood, and are ordinary enough, but the prose of his essays, e.g. *Considerations on the Philosophy of Portuguese Literary History*, has that peculiar refinement, clearness and conciseness which stamped the later work of this sensitive thinker. A subtle irony pervades the *Rimas* of João Penha, who links the Coimbraans with Guerra Junqueiro and the younger poets. Partly philosophical, partly naturalistic, Junqueiro began with the ironical composition, *A Morte de D. João*; in *Patria* he evoked in a series of dramatic scenes and lashed with satire the kings of

the Braganza dynasty, and in *Os Simples* he interprets in sonorous stanzas the life of country-folk by the light of his powerful imagination and pantheistic tendencies. The *Claridades de Sul* of Gomes Leal, a militant anti-Christian, at times recall Baudelaire, and flashes of genius run through *Anti-Christo*, which is alive with the instinct of revolt. The *Só* of the invalidish Antonio Nobre is intensely Portuguese in subjects, atmosphere and rhythmic sweetness, and had a deep influence. Cesario Verde sought to interpret universal nature and human sorrow, and the Parnassian Gonçalves Crespo may be termed a deeper, richer Coppée. His *Miniaturas* and *Nocturnos* have been re-edited by his widow, D. Maria Amalia Vaz de Carvalho, a highly gifted critic and essayist whose personality and *cerce* call to mind the 18th-century poetess, the Marquiza de Alorna. The French symbolists found an enthusiastic adept in Eugenio de Castro. Antonio Feijo and José de Sousa Monteiro have written verse remarkable by its form, while perhaps the most considered of the later poets are Antonio Corrêa de Oliveira and Lopes Vieira. Many other genuine bards might be mentioned, because the Portuguese race can boast of an unceasing flow of lyric poetry.

Garrett took in hand the reform of the stage, moved by a desire to exile the translations on which the playhouses had long subsisted. He chose his subjects from the national history, and began with the *Auto de Gil Vicente*, in which he resuscitated the founder of the theatre, and followed this up with other prose plays, among which the *Alfageme de Santarem* takes the palm; finally he crowned his labours by *Frei Luiz de Sousa*, a tragedy of fatality and pathos and one of the really notable pieces of the century. The historical bent thus given to the drama was continued by the versatile Mendes Leal, by Gomes da Amorim and by Pinheiro Chagas, who all however succumbed more or less to the atmosphere and machinery of ultra-Romanticism, while the plays of Antonio Ennes deal with questions of the day in a spirit of combative liberalism. In the social drama, Ernesto Biester, and in comedy Fernando Caldeira, also no mean lyric poet, are two of the principal names, and the latter's pieces, *A Mantilha da Renda* and *A Madrugada*, have a delicacy and vivacity which justifies their success. The comedies of Gervasio Lobato are marked by an easy dialogue and a sparkling wit, and some of the most popular of them were written in collaboration with D. João de Camara, the leading dramatist of the day, one of whose pieces, *Os Velhos*, has been translated and staged abroad. To Henrique Lopes de Mendonça, scholar, critic and poet, we owe some strong historical plays as well as the piece *Zé Palonso*, written with Lobato, which made a big hit. The playwrights also include Julio Dantas, and Dr Marcellino Mesquita, author of *Leonor Telles* and other historical dramas, as well as of a powerful piece, *Dôr suprema*.

Herculano led the way in the historical romance by his *Lendas e narrativas* and *O Monasticon*, two somewhat laboured productions, whose progenitor was Walter Scott; they still find readers for their impeccable style. Their most popular successors have been *A Moçidade de D. João V.* and *A ultima corrida de touros reaes em Salvaterra* by Rebelo da Silva, and *Um Anno na Corte* by the statesman, Andrade Corvo, the first and the last superior books. The novel shares with poetry the predominant place in the modern literature of Portugal, and Camillo Castello Branco (*q.v.*), Gomes Coelho and Eça de Queiroz are names which would stand very high in any country. The first, a wonderful impressionist though not perhaps a great novelist, describes to perfection the domestic and social life of Portugal in the early part of the 19th century. His remarkable works include *Amor de Perdição*, *Amor de Salvação*, *Retrato de Ricardina*, and the series entitled *Novellas do Minho*; moreover some of his essays in history and literary criticism, such as *Bohemia do Espirito*, rank only next to his romances. Gomes Coelho, better known as *Julio Diniz*, records his experiences of English society in Oporto in *A Familia inglesa*, and for his romantic idealism he has been dubbed British; Portuguese critics have accused him of imitating Dickens.

His stories, particularly *As Pupillas do Snr. Reitor*, depict country life and scenery with loving sympathy, and hold the reader by the charm of the characters, but Diniz is a rather subjective monotonous writer who lacks the power to analyse, and he is no psychologist. Eça de Queiroz (*q.v.*) founded the Naturalist school in Portugal by a powerful book written in 1871, but only published in 1875, under the title *The Crime of Father Amaro*; and two of his great romances, *Cousin Basil* and *Os Maias*, were written during his occupancy of consular posts in England. *The Relic* conveys the impressions of a journey in Palestine and in parts suggests his indebtedness to Flaubert, but its mysticism is entirely new and individual; while the versatility of his talent further appears in *The Correspondence of Fradique Mendes*, where acute observation is combined with brilliant satire or rich humour. The later portion of *The City and the Mountains*, for the truth and beauty of its descriptive passages, is highly praised, and many pages are already quoted as classic examples of Portuguese prose. Among other novelists are Oliveira Marreca, Pinheiro Chagas, Arnaldo Gama, Luis de Magalhães and Teixeira de Queiroz, the last of whom is almost as distinctly national a writer as Castello Branco himself.

Years of persevering toil in archives and editions of old chronicles prepared Herculano for his *magnum opus*, the *Historia de Portugal*. The *Historia da Origem e Estabelecimento da Inquisição em Portugal* followed and confirmed the position of its author as the leading modern historian of the Peninsula, and he further initiated and edited the important series *Portugaliae Monumenta historica*. The Visconde de Santarem, and Judice Biker in geography and diplomatics, produced standard works; Luz Soriano compiled painstaking histories of the reign of King Joseph and of the Peninsular War; Silvestre Ribeiro printed a learned account of the scientific, literary and artistic establishments of Portugal, and Lieut.-Colonel Christovam Ayres was the author of a history of the Portuguese army. Rebello da Silva and the voluminous and brilliant publicists, Latino Coelho and Pinheiro Chagas, wrote at second hand and rank higher as stylists than as historians. Gama Barros and Costa Lobo followed closely in the footsteps of Herculano, the first by a *Historia da Administração publica em Portugal nos Seculos XII. a XV.*, positively packed with learning, the second by a *Historia da Sociedade em Portugal no Seculo XV.* Though he had no time for original research, Oliveira Martins (*q.v.*) possessed psychological imagination, a rare capacity for general ideas and the gift of picturesque narration; and in his philosophic *Historia de Portugal*, his sensational *Portugal contemporaneo*, *Os Filhos de D. João* and *Vida de Nun' Alvarez*, he painted an admirable series of portraits and, following his master Michelet, made the past live again. Furthermore the interesting volumes of his *Bibliotheca das Sciencias Sociaes* show extensive knowledge, freshness of views and critical independence and they have greatly contributed to the education of his countrymen.

Ramalho Ortigão, the art critic, will be remembered principally for the *Farpas*, a series of satirical and humorous sketches of Portuguese society which he wrote in collaboration with Queiroz. Julio Cesar Machado and Fialho de Almeida made their mark by many humorous publications, and, in the domain of pure literary criticism, mention must be made of Antonio Pedro Lopes de Mendonça, Rebello da Silva, Dr Joaquim de Vasconcellos, Mme Michaëlis de Vasconcellos, Silva Pinto, the favourite disciple of Castello Branco, and of Luciano Cordeiro, founder of the Lisbon Geographical Society, whose able monograph, *Soror Marianna*, vindicated the authenticity of the *Letters of a Portuguese Nun* and showed Marianna Alcoforado to be their authoress. Excellent critical work was also done by Moniz Barreto, whose early death was a serious loss to letters.

In scientific literature hardly a single department lacks a name of repute even outside Portugal. The press has accompanied the general progress, and ever since Herculano founded and wrote in the *Panorama*, the leading writers have almost without

exception made both name and livelihood by writing for the papers, but as pure journalists none has excelled Antonio Rodriguez Sampaio, Antonio Augusto Teixeira de Vasconcellos and Emygdio Navarro.

The leading Portuguese orators of the 19th century, with the exception of Malhão, were not churchmen, as in the past, but politicians. The early days of parliamentary rule produced Manoel Fernandes Thomás and Manoel **Oratory.** Borges Carneiro, but the most brilliant period was that of the first twenty-five years of constitutional government after 1834, and the historic names are those of Garrett, Manoel da Silva Passos, and the great tribune and apostle of liberty, José Estevão Coelho de Magalhães. The ill-fated Vieira de Castro excited the greatest admiration by his impassioned speeches in the Chamber of Deputies during the 'sixties; the nearest modern counterpart to these distinguished men is the orator Antonio Candido Ribeiro da Costa.

BIBLIOGRAPHY.—The corner-stones are the *Bibliotheca Lusitana* of Barbosa Machado and the *Dictionario bibliographico portuguez*, by Innocencio da Silva, with Brito Aranha's supplement; while the *Bibliotheca Hispana Nova* of Nicolao Antonio (1783-1788) may also be referred to. Subsidiary to these are the *Manual bibliographico portuguez* of Dr Pinto de Mattos, the admirable *Catalogo razornado de los Autores portuguezes que escribieron en Castellano*, compiled by Garcia Peres (1890), and such publications as Figanieri's *Catalogo dos Manuscriptos portuguezes no Museu Britannico* (1853). The only full general history of the literature comes from the prolific pen of Dr Theophilo Braga (second and revised edition in 32 vols.). The volumes positively bulge with information and contain much acute criticism, but their value is diminished by frequent and needless digressions and by the fantastic theorizings of their author, a militant Positivist. Of one-volume books on the same subject, Dr Braga's *Curso da Historia da Litteratura portugueza* and his *Theoria da Historia da Litteratura portugueza* (3rd ed., 1881) may be recommended, though the plainer *Historia da Litteratura portugueza*, by Dr Mendes dos Remedios (3rd ed., 1908) has the considerable advantage for foreign students of including a large number of selected passages from the authors named. See also the *Chrestomathia archaica* of J. J. Nunes (1905). Among foreign studies the palm must be given to the "Geschichte der portugiesischen Litteratur" by the eminent scholar, Mme Michaëlis de Vasconcellos, in the *Grundriss der rom. Philologie* of Gröber (1893-1894). Among general critical studies are Costa e Silva's *Ensaio biographico-critico* and the masterly work of Menendez y Pelayo, *Historia de las ideas estaticas en España*.

Coming to special periods, the student may consult, for the cancioneros, Mme Michaëlis de Vasconcellos, *op. cit.*, and her great edition of the *Cancioneiro da Ajuda* (1904); also H. R. Lang, *Das Liederbuch der Königs Denis von Portugal* (1894). Lopes de Mendonça treats of the literature of the 16th and 17th centuries in articles in the *Annaes das sciencias e letras*; and the *Memorias de litteratura portugueza* printed by the Lisbon Academy of Sciences (1792-1814) contain essays on the drama and the Arcadia, but the 19th century has naturally received most attention. For that period, see Lopes de Mendonça, *Memoirs da litteratura contemporanea* (1855); Romero Ortiz, *La Litteratura portugueza en el siglo XIX.* (1869), containing much undigested information; and Maxime Formont, *Le Mouvement poetique contemporain en Portugal*, an able sketch; but the soundest review is due to Moniz Barreto, whose "Litteratura portugueza contemporanea" came out in the *Revista de Portugal* for July 1889. Students of the modern novel in Portugal should refer to the essays of J. Pereira de Sampaio ("Bruno") *A Geração Nova* (1886).

Portugal still lacks a collection equivalent to Rivadeneyra's *Biblioteca de autores españoles*, contenting itself with the *Par-nasso lusitano* (6 vols., 1826) and a *Corpus illustrium poetarum lusitanorum qui latine scripserunt* (1745-1748), and though much has been accomplished to make the classics more available, even yet no correct, not to say critical, texts of many notable writers exist. The *Cancioneiro de Ajuda* by Mme Vasconcellos, is the perfection of editing, and there are diplomatic editions of other cancioneros, e.g. *Il Canzoniere portoghese della Bibliotheca Vaticana*, by E. Monaci (1875), of which Dr Braga hurriedly prepared a critical edition; *Il Canzoniere portoghese Colacci-Brancuti* by E. Molteni (1880), and the *Cancioneiro Geral* (1846). The *Romanceiro portuguez* of V. E. Hardung is incomplete. (E. Pr.)

PORTUGUESE EAST AFRICA, or MOZAMBIQUE. This Portuguese possession, bounded E. by the Indian Ocean, N. by German East Africa, W. by the Nyasaland Protectorate, Rhodesia and the Transvaal, S. by Tongaland (Natal), has an area of 293,500 sq. mi. It is divided in two by the river Zambezi. The northern portion, between the ocean and Lake Nyasa and the Shiré river, is a compact block of territory, squarish in

shape, being about 400 m. long by 360 m. broad. South of the Zambezi the province consists of a strip of land along the coast varying from 50 to 200 m. in depth. Along the Zambezi itself Portuguese territory extends west as far as the Loangwa confluence, some 600 m. by river.

Physical Features.—The coast-line extends from 26° 52' S. to 10° 40' S., and from south to north makes a double curve with a general trend outward, *i.e.* to the east. It has a length of 1430 m. Some 40 m. north of the Natal (Tongoland) frontier is the deep indentation of Delagoa Bay (*q.v.*). The land then turns outward to Cape Corrientes, a little north of which is Inhambane Bay. Bending westward again and passing several small islands, of which the chief is Bazaruto, Sofala Bay is reached. Northward the Zambezi with a wide delta pours its waters into the ocean. From this point onward the coast is studded with small islands, mainly of coral formation. On one of these islands is Mozambique, and immediately north of that port is Conducia Bay. Somewhat farther north are two large bays—Fernaio Veloso and Memba. There is a great difference in the character of the coast north and south of Mozambique. To the north the coast is much indented, abounds in rocky headlands and rugged cliffs while, as already stated, there is an almost continuous fringe of islands. South of Mozambique the coast-line is low, sandy and lined with mangrove swamps. Harbours are few and poor. The difference in character of these two regions arises from the fact that in the northern half the ocean current which flows south between Madagascar and the mainland is close to the coast, and scours out all the softer material, while at the same time the coral animalcules are building in deep waters. But south of Mozambique the ocean current forsakes the coast, allowing the accumulation of sand and alluvial matter. North of Fernao Veloso and Memba the largest bays are Pemba (where there is commodious anchorage for heavy draught vessels), Montepuesi and Tunghi, the last named having for its northern arm Cape Delgado, the limit of Portuguese territory.

Orographically the backbone of the province is the mountain chain which forms the eastern escarpment of the continental plateau. It does not present a uniformly abrupt descent to the plains, but in places—as in the lower Zambezi district—slopes gradually to the coast. The Lebombo Mountains, behind Delagoa Bay, nowhere exceed 2070 ft. in height; the Manica plateau, farther north, is higher. Mt Doe rises to 7875 ft. and Mt Panga to 7610 ft. The Gorongozo massif with Mt Miranga (6550 ft.), Enhatete (6050 ft.), and Gogogo (5900 ft.) lies north-east of the Manica plateau, and is, like it, of granitic formation. Gorongozo, rising isolated with precipitous outer slopes, has been likened in its aspect to a frowning citadel. The chief mountain range, however, lies north of the Zambezi, and east of Lake Chilwa, namely, the Namuli Mountains, in which Namuli Peak rises to 8860 ft., and Molisani, Mruli and Mresi attain altitudes of 6500 to 8000 ft. These mountains are covered with magnificent forests. Farther north the river basins are divided by well-marked ranges with heights of 3000 ft. and over. Near the south-east shore of Nyasa there is a high range (5000 to 6000 ft.) with an abrupt descent to the lake—some 3000 ft. in six miles. The country between Nyasa and Ibo is remarkable for the number of fantastically shaped granite peaks which rise from the plateau. The plateau lands west of the escarpment are of moderate elevation—perhaps averaging 2000 to 2500 ft. It is, however, only along the Zambezi and north of that river that Portuguese territory reaches to the continental plateau.

Besides the Zambezi (*q.v.*) the most considerable river in Portuguese East Africa is the Limpopo (*q.v.*) which enters the Indian Ocean about 100 m. north of Delagoa Bay. The Komati (*q.v.*), Sabi, Busi and Pungwe south of the Zambezi; the Lukugu, Lurio, Montepuesi (Mtepwesi) and Msalu, with the Rovuma (*q.v.*) and its affluent the Lujenda, to the north of it, are the other rivers of the province with considerable drainage areas. The Sabi rises in Mashonaland at an altitude of over 3000 ft., and after flowing south for over 200 m. turns east and pierces the mountains some 170 m. from the coast, being joined near the Anglo-Portuguese frontier by the Lundi. Cataracts entirely prevent navigation above this point. Below the Lundi confluence the bed of the Sabi becomes considerably broader, varying from half a mile to two miles. In the rainy season the Sabi is a large stream and even in the "dries" it can be navigated from its mouth by shallow draught steamers for over 150 m. Its general direction through Portuguese territory is east by north. At its mouth it forms a delta 60 m. in extent. The Busi (220 m.) and Pungwe (180 m.) are streams north of and similar in character to the Sabi. They both rise in the Manica plateau and enter the ocean in Pungwe Bay, their mouths but a mile or two apart. The lower reaches of both streams are navigable, the Busi for 25 m., the Pungwe for about 100 m. At the mouth of the Pungwe is the port of Beira. Of the north-Zambezi streams the Lukugu, rising in the hills south-east of Lake Chilwa, flows south and enters the ocean not far north of Quilimane. The Lurio, rising in the Namuli Mountains, flows north-east, having a course of some 200 m. The Montepuesi and the Msalu drain the country between the Lurio and Rovuma basins. Their banks are in general well defined and the wet season rise seems fairly constant.

Geology.—The central plateau consists of gneisses, granites and schists of the usual East African type which in part or in whole are to be referred to the Archaean system. The next oldest rocks belong to the Karroo period. Their principal occurrence is in the Zambezi basin, where at Tete they contain workable seams of coal, and have yielded plant remains indicating a Lower Karroo or Upper Carboniferous age. Sandstones and shales, possibly of Upper Karroo age, form a narrow belt at the edge of the foot-plateau. Upper Cretaceous rocks crop out from beneath the superficial deposits along the coast belt between Delagoa Bay and Mozambique. The Cenomanian period is represented in Conducia by the beds with *Puzosia* and *Acanthoceras*, and in Sofala and Busi by the beds with *Alectryonia unguolata* and *Exogyra columba*. The highest Cretaceous strata occur in Conducia, where they contain the huge ammonite *Pachydiscus conducensis*. The Eocene formation is well represented in Gazaland by the nummulitic limestones which have been found to extend for a considerable distance inland. Basalts occur at several localities in the Zambezi basin. On the flanks of Mount Milanje there are two volcanic cones which would appear to be of comparatively recent date; but the most interesting igneous rocks are the rhyolitic lavas of the Lebombo range.

Climate.—The climate is unhealthy on the coast and along the banks of the Zambezi, where malaria is endemic. With moderate care, however, Europeans are able to enjoy tolerably good health. On the uplands and the plateaus the climate is temperate and healthy. At Tete, on the lower Zambezi, the annual mean temperature is 77.9° F., the hottest month being November, 83.3°, and the coldest July, 72.5°. At Quilimane, on the coast, the mean temperature is 85.1°, maximum 106.7° and minimum 49.1°. The cool season is from April to August. The rainy season lasts from December to March, and the dry season from May to the end of September. November is a month of light rains. During the monsoons the districts bordering the Mozambique Channel enjoy a fairly even mean temperature of 76.1°, maximum mean 88.7°, and minimum mean 65.3°.

Fauna.—The fauna is rich, game in immense variety being plentiful in most districts. The carnivora include the lion, both of the yellow and black-maned varieties, leopard, spotted hyena, jackal, serval, civet cat, genet, hunting dog (*Lycan pictus*) in the Mozambique district, mongoose and spotted otter, the last-named rare. Of ungulate the elephant is plentiful, though large tuskers are not often shot. The black rhinoceros is also common, and south of the Zambezi are a few specimens of white rhinoceros (*R. simus*). The rivers and marshes are the home of numerous hippopotami, which have, however, deserted the lower Zambezi. The wart-hog and the smaller red hog are common. A species of zebra is plentiful, and herds of buffalo (*Bos caffer*) are numerous in the plains and in open woods. Of antelopes the finest are the eland and sable antelope. The kudu is rare. Waterbuck, hartebeeste (*Bubalis lichtensteini*), brindled gnu and tsessebe (south of the Zambezi, replaced north of that river by the lechwe and puku), reedbuck, bushbuck, impala, duiker, klipspringer and oribi are all common. The giraffe is not found within the province. Of edentata the scaly ant-eater and porcupine are numerous. Among rodentia hares and rabbits are abundant. There are several kinds of monkeys and lemureids, but the anthropoids are absent. Crocodiles, lizards, chameleons, land and river tortoises are all very numerous, as are pythons (some 18 ft. long), cobras, puff-adders and vipers. Centipedes and scorpions and insects are innumerable. Among insects mosquitoes, locusts, the tsetse fly, the hippo-fly, cockroaches, phylloxera, termites, soldier ants and flying ants are common plagues. As has been indicated, the Zambezi forms a dividing line not crossed by certain animals, so that the fauna north of that river presents some marked contrasts with that to the south.

Bird-life is abundant. Among the larger birds flamingoes are especially common in the Mozambique district. Cranes, herons, storks, pelicans and ibises are numerous, including the beautiful crested crane and the saddle-billed stork (*Mycteria senegalensis*), the last-named comparatively rare. The eagle, vulture, kite, buzzard and crow are well represented, though the crested eagle is not found. Of game birds the guinea fowl, partridge, bustard, quail, wild goose, teal, widgeon, mallard and other kinds of duck are all common. Other birds numerously represented are parrots (chiefly a smallish green bird—the grey parrot is not found), ravens, hornbills, buntings, finches, doves, a variety of cuckoo, small wag-tails, a starling with a beautiful burnished bronze-green plumage, spur-winged plovers, stilt birds, ruffs and kingfishers.

Flora.—The flora is varied and abundant, though the custom of the natives to burn the grass during the dry season gives to large areas for nearly half the year a blackened, desolate appearance. Six varieties of palms are found—the coco-nut, raphia, wild date, borassus (or fan palm), hyphaene and *Phoenix spinosa*. The coco-nut is common in the coast regions and often attains 100 ft.; the date palm, found mostly in marshy ground and by the banks of small rivers, is seldom more than 20 ft. in height. Of the many timber trees a kind of cedar is found in the lower forests; ironwood and ebony are common, and other trees resemble satin and rosewood. The *Khaya senegalensis*, a very large tree found in ravines and by river banks, affords durable and easily-worked timber; there are

several varieties of vitex and of ficus, notably the sycamore, which bears an edible fruit. Excellent hardwood is obtained from a species of grevia. Other characteristic trees are the mangrove (along the sea shore), sandal-wood, gum copal, baobab and bombax, and, in the lower plain, dracaenas (dragon trees), candelabra euphorbia, and many species of creepers and flowering shrubs. The thorny smilax and many other prickly creepers and shrubs are abundant. Acacias are numerous, including the gum-yielding variety, while landolphia rubber vines grow freely in the forests. Among plants of economic value the coffee, cotton, indigo and tobacco plants are found, as well as the castor oil and other oleaginous plants. Bananas, mangoes and pineapples grow in great profusion. Among flowers crinum lilies, lotus, gentians, gladioli, lobelias, violets (scentless), red and yellow immortelles (confined to the higher elevations) and yellow and blue amomums are common. Of grasses the bamboo is common. *Phragmites communis*, spear grass, with its waving, snowy plumes, grows 12 to 14 ft. and is abundant along the river banks and along the edges of the marshes. (For the flora of the Nyasa region see BRITISH CENTRAL AFRICA.)

Inhabitants.—Portuguese East Africa is sparsely inhabited, the estimated population (1909) being 3,120,000; 90% of the inhabitants belong to various Bantu tribes, from whose ranks most of the natives employed in the Transvaal gold mines are recruited. The most important in the northern half of the province are the Yaos (*q.v.*) and the Ma Kua (Makwa). The Makwa, notwithstanding the presence of Arabs, Banyans (Hindus) and Battias in all the coast districts, have preserved in a remarkable degree their purity of race, although their language has undergone considerable change (see BANTU LANGUAGES). Most of the country between the Rovuma and the Zambezi is populated by branches of this race, governed by numerous petty chiefs. The Makwa are divided into four families or groups—the Low Makwa, the Lomwe or Upper Makwa, the Maua and the Medo. Yao possess the country between the Msalu river and Nyasa. The dominant race between the Zambezi and the Mazoe are the Tavala, other tribes in the same region being the Maravi, Senga, Muzimba and Muzuzuro. They are mainly of Zulu origin. Between the Zambezi and the Pungwe are the Barue, Batoka, &c. In the district south of the Pungwe river, known as Gazaland, the ruling tribes are of Zulu origin, all other tribes of different stock being known as Tongas. For the most part these Tongas resemble the Basutos. They are of peaceful disposition. They occupy themselves with stock-raising and agriculture. The white inhabitants numbered about 9000 in 1909. They are chiefly Portuguese and British and nearly a half live in Lourenço Marques. There are many Portuguese half-castes.

Chief Towns.—The chief towns are Lourenço Marques, Mozambique, Quilimane, Inhambane, Beira, Chinde and Sofala, all separately noticed. The other European settlements are Chingune (see SOFALA), Angoxa and Ibo on the coast, and Sena, Tete and Zumbo on the Zambezi. Angoxa lies midway between Quilimane and Mozambique, dates from the 17th century, and is a small and little frequented port. Ibo, founded by the Portuguese at the beginning of the 17th century, is built on an island, likewise called Ibo, in 12° 20' S., 40° 38' E. off the northern arm of Montepuesi Bay, and 180 m. north of Mozambique. Ibo Island is one of a group known as the Querimba archipelago. The harbour is sheltered but shallow. The town attained considerable dimensions in the 17th century and was made the headquarters of the Cape Delgado district in the 18th century. The most prominent buildings are two forts, one disused. The other, called San João, is star-shaped and was built, according to an inscription over the gateway, in 1791. The Zambezi towns (Sena, Tete and Zumbo) mark the limits of penetration made by the Portuguese inland. Comparatively important places in the 17th and early part of the 18th centuries, with the decline of Portuguese power they fell into a ruinous condition. The opening up of Rhodesia and British Central Africa in the last quarter of the 19th century gave them renewed life. Sena, some 150 m. by river from Chinde, is built at the foot of a hill on the southern side of the Zambezi, from which it is now distant 2 m., though in the middle of the 16th century the river flowed by it. Sena possesses an 18th-century fort, a

modern government house and a church dedicated to St Marcal.

Tete, founded about the same time as Sena, is also on the south bank of the Zambezi. It is about 140 m. by the river above Sena. Since 1804 there has been a regular service of steamers between Tete and Chinde. Of the ancient town little remains save the strongly-built fort and the church. The new town dates from about 1860, when there was a revival of the trade in gold dust and ivory. This trade, however, became practically extinct by 1903; the gold dust traffic through exhaustion of supplies, and the ivory trade through diversion to other routes. A transit trade to British possessions north and south of Tete has been developed, and in 1906 some gold mines in the neighbourhood began crushing ore. Zumbo is picturesquely situated just below the Loangwe confluence and commands large stretches of navigable water on the Loangwe and middle Zambezi. The 17th-century town was deserted in consequence of the hostility of the natives. In 1859 David Livingstone found on its site nothing but the ruins of a few houses. Since then a new settlement has been made, and Zumbo has acquired some transit trade with Rhodesia.

On the line of railway from Beira to Rhodesia the most important town is Massi Kessi (Portuguese Maçequese) in the centre of the Manica goldfields. It lies 2500 ft. above the sea, 194 m. north-west of Beira by rail, and is close to the British frontier. Along the railway from Lourenço Marques to the Transvaal frontier are stations marking the position of small settlements. The last Portuguese station is named Ressano Garcia; the first Transvaal station Komati Poort.

Communications.—The Zambezi is navigable by light draught steamers throughout its course in Portuguese territory with one break at the Kebrassa Rapids—400 m. from its mouth. By means of the Shiré affluent of the Zambezi there is direct steamer and railway connexion with British Central Africa. The navigability of the other rivers of the province has been indicated. From Lourenço Marques railways run to Swaziland and the Transvaal, and from Beira there is a railway to Rhodesia. These lines, built to foster trade with countries beyond Portuguese territory, link the ports named to the British railway systems in South and Central Africa. The route for a railway to connect Beira with Sena was surveyed in 1906–1907, a route from Quilimane to the Zambezi being also surveyed. A light railway (50 m. long) goes inland from Matamba, on Inhambane Bay, serving northern Gazaland. Native caravan routes traverse every part of the country, but these are mere tracks, and in general communication is difficult and slow.

Lourenço Marques, Beira, Mozambique and other ports are in telegraphic communication with Europe via South Africa and Zanzibar, and a cable connects Mozambique with Madagascar. Inland telegraph lines connect the ports with the adjacent British possessions. British, German and Portuguese steamship lines maintain regular communication between Lourenço Marques and other ports and Europe and India. In 1908 some 1700 vessels of 3,400,000 tons visited the ports of the province.

Agriculture and Other Industries.—The country from the Rovuma to the Zambezi is of great fertility, the richest portion being that between Angoxa and Quilimane. In the basin of the Zambezi the soil is fertilized by the inundations of the river. The low coast land of the Gaza country is almost equally fruitful. A great part of the country is suitable for the growth of the sugar-cane, rice, ground-nuts, coffee and tobacco. The two last named plants, as also cotton, vanilla, tea and cloves, are not a success in the Quilimane region, where coco-nuts and ground-nuts are the chief crops. Rubber vines are largely grown in the Mozambique district and the Mozambique Company has large plantations of coffee and sugar. There are numerous sugar factories and rice plantations in the Zambezi district. The natives devote their attention to the raising of oleaginous crops and of maize, cassava, beans, &c. Wheat and other cereals are grown in the valley of the Zambezi. Large herds of cattle are raised. The system prevails in many districts of dividing the land into *prazos* (large agricultural estates) in which the natives cultivate various crops for the benefit of the European leaseholder, who is also tax-collector for his district and can claim the tax either in labour or produce.

Fish are plentiful along the coast, and pearls are obtained off the Bazaruto Isles. Turtles are caught in the Querimba archipelago. Spirits, sugar, fibres and pottery are practically the only commodities manufactured. The hunting of game for ivory and skins affords employment to large numbers of people.

Mineral Resources.—There are immense deposits of coal in the neighbourhood of Tete and near Delagoa Bay, and adjoining the coalfields ironstone of the best quality is plentiful. Malachite and copper are found in the interior, north-west of Mozambique. The

whole of the region north of Delagoa Bay to the Zambezi and inland to and beyond the Portuguese frontier is auriferous, and ancient gold workings abound. Many writers have sought to identify this region with the land of Ophir. In Manica several gold mines are worked. In 1906-1907 a rich formation similar to the American "placer" deposits was discovered in the Manica goldfields. Gold mines are also worked at Missale and Chifumbaze, to the north of Tete. The Missale mines are just south of the frontier of British Central Africa. Petroleum is found near Inhambane, as is also a curious elastic-like substance named inhangellite, resembling bitumen, chiefly derived from masses of a gelatinous alga (see *Kew Bulletin*, No. 5, 1907).

Commerce.—The chief exports are rubber, sugar, coal (from the Transvaal), beeswax, coco-nuts, copra and mangrove bark, ivory (including hippopotamus teeth and rhinoceros horns), skins and hides, ground-nuts, and oilseeds, monkey-nuts, mealies, cattle (to Madagascar), cotton, tobacco, gold and other minerals. The principal imports for consumption in the province are cotton goods, hardware and foodstuffs. The "Kaffir" trade is largely in cheap wines of a highly deleterious character, blankets, hats and shoes, brass wire and Venetian beads. Immense quantities of cheap wine are bought by the natives. There is at Lourenço Marques and at Beira a large transit trade to and from the Transvaal and Rhodesia respectively. The average annual value of the external trade of the province for the five years 1901-1905 was about £5,500,000. In 1909 the total trade of the province—including re-exports and goods in transit—exceeded £10,000,000. Fully 50% of this trade was in transit to or from the Transvaal. (See further LOURENÇO MARQUES; BEIRA, &c.) The trade of the province is chiefly with Great Britain, India, Germany and Portugal. The retail trade both at the seaports and in the settlements inland is largely in the hands of British Indians—Banyans, Battias and Parsees.

On the coast there are several native ports of call, between which and Madagascar a large surreptitious trade in slaves was carried on until 1877. With this island, and also with Zanzibar, there is a large general coasting trade.

Administration, Revenue, &c.—Formerly called Mozambique, the province since 1891 bears the official title of State of East Africa. It is under a governor-general, appointed for three years, and for administrative purposes is divided into several districts. There is a government council, instituted in 1907, composed partly of officials and partly of elected representatives of the commercial, industrial and agricultural communities. There is also a provincial council "with the attributions of an administrative and account tribunal." In each district is a subsidiary council. The governor-general resides at Lourenço Marques and has under his immediate direction the Delagoa Bay district. Gazaland (*q.v.*) and the district of Inhambane are also governed directly by Portuguese officials. The greater part of the country between the Sabi River and the Zambezi, including the Manica and Sofala regions, is administered, under a charter granting sovereign rights for 50 years from 1891, by the Companhia de Moçambique, which has its headquarters at Beira. The Quilimane, Chinde and Zambezi regions are administered by representatives of the governor-general, with headquarters at Mozambique. The Zambezi Company has large trading concessions over this district. North of the Quilimane district the coast region and adjacent islands go under the name of Angoxa. The territory between the Lurio and Rovuma rivers and Lake Nyasa is governed by the Companhia do Nyasa under a royal charter. Revenue is obtained largely from customs and a hut tax on natives. The annual revenue of the province is about £1,000,000. A military force, about 4000 strong, is maintained, including 1200 to 1400 Europeans. Education is chiefly in the hands of Roman Catholic missionaries.

History.—It is uncertain at what period the east coast of Africa south of Somaliland was first visited by the maritime races of the east. There is, however, no reason to doubt that by the 10th century A.D. the Arabs had occupied the seaboard as far south as Sofala, and that they carried on an active trade between East Africa and Arabia, the Persian Gulf and India. The Arabs built fine towns and exercised control over the coast peoples, but do not appear to have pushed their conquests far inland. They had extensive commercial dealings, chiefly in gold, ivory and slaves, with the Bantu potentates who ruled over the middle Zambezi valley and the country now known as Mashonaland. Until the close of the 15th century the Arab supremacy was unchallenged. But in 1498 Vasco da Gama entered the mouth of a river which he called Rio dos Bons Sinaes (River of Good Tokens), as there he first found himself in contact with the civilization of the East. This stream was the Quilimane River, taken by the Portuguese a little later to be the main mouth of the Zambezi. From this river da Gama continued his voyage, putting in at Mozambique and Mombasa on his way to India. Hostilities between the Arabs and Portu-

guese* broke out almost immediately; da Gama, indeed, in his first voyage had some trouble with the sultan of Mozambique. In 1502 da Gama paid a visit to Sofala to make inquiries concerning the trade in gold carried on at that place, and the reports as to its wealth which reached Portugal led to the despatch in 1505 of a fleet of six ships under Pedro da Nhaya with instructions to establish Portuguese influence at Sofala. Da Nhaya was allowed to build a fort close to the Arab town. The fort, built in three months, was shortly afterwards attacked by a band of Bantus, who acted on the instigation of the Arabs. The attackers were driven off and the Arabs forced to acknowledge Portuguese rule. In 1509 a captain of Sofala and a factor, or chief trader, were sent out, and from this time the trade of the port fell to the Portuguese. Sofala, however, was not a suitable harbour for the refitting and provisioning of ships on the way to India, and to obtain such a port Mozambique was seized and fortified in 1507. By 1510 the Portuguese were masters of all the former Arab sultanates on the East African coast. The northern half of this region, from Kilwa to Mukdishu, has passed out of their possession; here it is only necessary to outline the history of the country still under the Portuguese Crown.

For forty years Sofala was their only station south of the Zambezi. Thence they traded with the monomotapa or chief of the "Mocaranga" (*i.e.* the Makalanga or Karanga) in whose territory were the mines whence the gold exported from Sofala was obtained. At that time this chief was a powerful potentate exercising authority over a wide area (see MONOMOTAPA). The efforts made by the Portuguese from Sofala to reach him were unsuccessful. It was probably the desire to penetrate to the "land of gold" by an easier route that led, in 1544, to the establishment of a station on the River of Good Tokens, a station from which grew the town of Quilimane. About the same time the Portuguese penetrated inland along the Zambezi, known then as the River of Sena, and founded the trading ports of Sena and Tete, or, perhaps, annexed already existing Arab towns of those names. It was at this period also that Lourenço Marques and a companion, sent out by the captain of Mozambique, entered Delagoa Bay and opened up trade with the natives. This was the most southerly point occupied by the Portuguese. For three centuries however the fine harbour was little used, and its ultimate development was due to the discovery of another "land of gold"—the Witwatersrand—beyond Portuguese territory. In the 16th century the Portuguese turned their energies towards the Zambezi valley. In 1569 their East African dominions, hitherto dependent on the vicereignty of India, were made a separate government with headquarters at Mozambique.

Francisco Barreto, a former viceroy of India, appointed governor of the newly formed province, was instructed by King Sebastian to conquer the country of the gold mines. The route via the Zambezi, and not that by Sofala, was chosen by Barreto—in opposition to the desires of his council, but in accord with the advice of a Dominican friar named De Monclares. This advice proved fatal owing to the deadly climate of the Zambezi valley. Barreto's expedition, including over 1000 Europeans, started in November 1569, and from Sena marched south, an arrangement having been come to with the monomotapa by which the Portuguese were granted a right of way to the gold mines on condition of their attacking a rebel vassal of that chieftain. Barreto attacked and defeated this rebel, but received no help from the monomotapa, and his force was so greatly weakened by deaths and disease that he was obliged to return to Sena, whence he went to Mozambique to put down disorder among the Portuguese there. He returned to Sena in 1570, only to die a few days after his arrival. His successor Vasco Fernandes Homem, got together another expedition and made his way inland from Sofala to a region where he saw the ground being worked for gold. The comparative poorness of the mine filled him, it is stated, with disappointment, and he returned to Sofala. Thus these, the most important efforts made by the Portuguese to obtain possession of the interior, ended in failure.

Towards the end of the 16th century the Portuguese posts on the Zambezi were attacked by hordes of savages known as Muzimba, and Tete and Sena were destroyed. The captain-general of Mozambique—the province had been again attached to the Indian vicerealty—was only able to make peace on promise not to interfere with matters which concerned only the native tribes. Thereafter the Portuguese often had to defend even the coast towns from attacks by the Bantus. Still they held one or two posts in the interior besides those on the Zambezi. Of these the chief appears to have been Masapa, on the river Mansovo, *i.e.* Mazoe, in what is now Mashonaland, and about 150 m. by road from Tete. Near Masapa dwelt the monomotapa, an insignificant chieftain, the power of the Makalanga having been broken by revolts of once subject tribes and by dissensions among the Makalanga themselves. In 1629 a treaty was concluded with a claimant to the chieftainship who embraced Christianity. This man, known as the Monomotapa Philippe, declared himself a vassal of Portugal, and with the help of Dominican friars and a number of half-breeds established his authority.

The Portuguese, however, failed to make any effective use of their East African possessions. Among the causes of their non-success in the years immediately following the period of conquest must be reckoned the "Sixty Years' Captivity" (1580-1640), when the Spanish and Portuguese crowns were united, and the neglect of Africa for the richer possessions in India and the Far East. A more important and permanent reason for the non-development of Mozambique province was its unhealthy and enervating climate, which prevented European colonization. The few thousands of Portuguese who went out were chiefly officials, and they and the small body of planters led in general a life of indolence and debauchery. Commerce too was hampered and good government rendered impossible through the system of farming out the administration to officials who were in return granted a monopoly of trade, and even when this system was abandoned trade was confined to Portuguese subjects.¹ But for many years the Jesuits and Dominicans were unceasing in their endeavours to win the native races to Christianity, the friars being the most energetic section of the white community. The first Jesuit missionaries began work in the province in the neighbourhood of Inhambane in 1560; in the same year another Jesuit, Gonçalo da Silveira, made his way to the zimbabwe (chief kraal) of the monomotapa, by whose orders he and his converts were strangled (March 16, 1561). Mission work was soon afterwards begun by the Dominicans and the two orders between them had agents spread over the greater part of the country from Mozambique southward. They gained thousands of at least nominal converts, notably the heir of one of the monomotapas, who was baptized in 1652 and who, renouncing his heirship, became vicar of the convent of Santa Barbara in Goa. But during the 18th century the zeal of the missionaries declined; in 1759 the Jesuits were expelled, and two years later the Dominicans were sent to Goa. At that time they had been, together with a few white, Goanese and half-caste traders, for fully a century practically the only representatives of Portugal in the interior (the towns on the Zambezi excepted). Portugal's influence was confined to helping one tribe in its quarrel with another, in return for favours received. The Portuguese were quite unable to take advantage of the disunion of the natives to establish their own supremacy. The exhaustion and enfeeblement of Portugal had, in short, its natural effect in Africa. In the early years of the 18th century the Arabs wrested from the Portuguese their African possessions north of Cape Delgado; the Dutch, French and British had been for some time menacing their trade and possessions in the south. In 1604, 1607 and again in 1662 the Dutch unsuccessfully attacked Mozambique, which was also attacked by the Arabs in 1670. The merchants of Sofala and Mozambique had, since the middle of the 17th century, found a new source of wealth in the export of slaves to Brazil, a trade due directly to the capture of the ports of Angola by the Dutch (1640-1648), but

¹ Until 1853, when commerce was made free to all nations.

continued until nearly the middle of the 19th century.² Other trade declined steadily, the continual state of warfare among the tribes of the inland plateaus greatly reducing the production of gold.

In 1752 the government of the East African possessions was again separated from that of Goa, and twenty years later Francisco José Maria de Lacerda e Almeida, a man of high attainments, made governor of the province at his own request, endeavoured to reform the administration. Lacerda is chiefly remembered for his journey to the heart of Central Africa, where he died in October 1798. Lacerda had conceived the idea of establishing a chain of Portuguese posts across the continent from Mozambique to Angola, and his statesmanlike prescience was shown by his prediction that the seizure of Cape Town by the British would lead to the extension of British rule over Central Africa, thus isolating the Portuguese provinces on the east and west coasts. After Lacerda's death a state of apathy and decay was again manifest throughout Portuguese East Africa. During the greater part of the 19th century the country south of the Zambezi was devastated by hordes of savages of Zulu origin (see GAZALAND).

The discoveries of David Livingstone in the Zambezi basin in the period 1850-1865 attracted the attention of the British to those regions and led to the establishment of British settlements at the southern end of Lake Nyasa and in the Shiré highlands. These events aroused anxiety in Lisbon, which was increased when the British obtained a prepondering influence in Matabele, Mashona and Manica lands—the lands of the earlier monomotapas. With sudden energy the Portuguese engaged in the "scramble for Africa," and though the result was disappointing to the patriotic feelings of the people they secured from their powerful neighbours—Great Britain and Germany—much better terms than might have been anticipated, having regard to the extremely limited area over which they exercised any sort of jurisdiction. The story of the partition is set forth fully in AFRICA, § 5. Before the "scramble" began, Portugal had been fortunate in securing, in 1875, as the result of arbitration, complete possession of the fine harbour of Delagoa Bay, the southern half of which had been claimed by Great Britain in virtue of acts of annexation in 1823 and later years.

The pressure of political events and the commercial activity of her rivals induced Portugal to take steps to develop the agricultural and mineral resources of the territory secured to her by international agreements. Imitating the policy of Great Britain, charters conveying sovereign powers were granted to the Mozambique Company in 1891, and to the Nyasa Company in 1893. Both these companies, as well as the Zambezi Company (which lacks a charter), undertook to open up the territory committed to their care. In all of them British capital is largely engaged. The total decay of Sofala, the removal of the seat of government from Mozambique to Lourenço Marques, the rise of the last named port and of Beira (both largely dependent on the transit trade with British possessions), all served to mark the changed condition of affairs. An agreement concluded in 1909 between the Transvaal and Portugal gave Delagoa Bay from 50 to 55% of the import trade with the Transvaal, the Portuguese agreeing further to facilitate the recruitment of natives in the province for work on the Rand mines. The development, in the early years of the 20th century, of rubber, rice, sugar and other plantations also gave a new impetus to commerce.

BIBLIOGRAPHY.—E. de Vasconcellos, *As Colonias portuguesas*, pp. 212-299 (2nd ed., Lisbon, 1903) and A. Negreiros, *La Mozambique* (Paris, 1904). The last named, somewhat untrustworthy in the historical sketch, is valuable for its flora and fauna sections. For the regions south of the Zambezi see R. C. F. Maugham, *Portuguese East Africa* (London, 1906) and *Zambesia* (London, 1909); *O Territorio de Manica e Sofala . . . 1892-1900* (Lisbon, 1902), a monograph prepared by the Mozambique Company; Commandant Smits, "La Compagnie à charte de Mozambique" in *Le Mouvement géographique* of Brussels (1906). For the districts north of the Zambezi

² Slavery was not abolished until 1878.

see W. B. Worsfold, *Portuguese Nyassaland* (London, 1899); Major J. Stevenson-Hamilton's paper in *Geog. Journ.* (Nov. 1909); V. A. d'Eça, "Esboço geographico-historico dos territorios portugueses entre o Indico e o Nyassa" in *Bol. soc. geo. Lisboa* (1901). For geology consult A. A. F. de Andraada, "A Geological Reconnaissance of the Portuguese Territories between Lorenzo Marques and the Zambezi River," review in *Geol. Mag.* (1897); R. B. Newton, "Note on the Occurrence of Nummulitic Limestone in South-eastern Africa," *Geol. Mag.* (1896); Paul Choffat, *Crétacique de conducia, com. d. service géol. du Portugal* (1903). Ethnology and philology have received considerable attention. See M. M. Feio, *Indigènes de Moçambique* (Lisbon, 1900); J. V. do Sacramento, "Apontames sobre a lingua macua" in *Bol. soc. geo. Lisboa*, 22nd and 23rd series (1904 and 1905); H. A. Junod, *Les Chants et les contes des Ba-Ronga de la baie de Delagoa* (Lausanne, 1897). For history see G. M'C. Theal's *Records of South-Eastern Africa* (9 vols., London, 1898-1903), containing texts of original documents and MSS., with translations in English; *History and Ethnography of South Africa to 1795* (3 vols., London, 1907-1910); and *The Portuguese in South Africa* (London, 1896); Père Courtois, *Notes chronologiques sur les anciennes missions catholiques au Zambezi* (Lisbon, 1889); João dos Santos, *Ethiopia orientalis* . . . (Lisbon, 1609), an account of the travels of one of the early missionaries in Mozambique. A reprint, edited by M. D'Azevedo, was published at Lisbon in 1891. Valuable records of the state of the country in the last half of the 19th century are contained in the reports to the foreign office of the British consuls at Mozambique, notably those of Lieut. H. E. O'Neill, R.N., and Lyons McLeod. See also O'Neill's *The Mozambique and Nyassa Slave Trade* (London, 1885); McLeod's *Travels in Eastern Africa, with the Narrative of a Residence in Mozambique* (London, 1860); and *Travels . . . [in] Eastern and Central Africa* (London, 1879) from the journals of Captain J. F. Elton (consul at Mozambique), compiled by H. B. Cotterill. See further D. and C. Livingstone, *Narrative of an Expedition to the Zambesi and its Tributaries, &c.* (London, 1865), and the works cited under DELAGOA BAY and ZIMBABWE. Reference may also be made to the bibliography under BRITISH CENTRAL AFRICA. (F. R. C.)

PORTUGUESE GUINEA, a Portuguese colony in West Africa, extending along the Guinea coast from Cape Roxo in 12° 19' N. to the Cogan estuary in 10° 50' N. Inland it reaches to 13° 40' W., being enclosed landward by French territory, the Casamance district of Senegal to the N., and French Guinea E. and S. (For map, see FRENCH WEST AFRICA.) The colony has an area of about 14,000 sq. m., and a population variously estimated at from 200,000 to 800,000. It consists largely of a low-lying deltaic region, together with an adjacent archipelago of small islands called the Bissagos.

The coast-line is deeply indented by estuaries into which flow numerous rivers whose sources are in the elevated region on the eastern border of the colony. The largest estuary, the Geba, receives the river of the same name, the Mancoa, a northerly affluent, and the Rio Grande or Comba; the last a large stream rising in the highlands of Futa Jallon. North of the Geba estuary is the Rio Cacheo, while in the south is the Rio Cassini, in reality an arm of the sea. These rivers and estuaries are connected with one another and with many smaller rivers by a network of lagoons; and the Bissagos Islands, which lie off the Geba estuary, formed at one time part of the mainland. The Bissagos, protected seaward by dangerous breakers, consist of over thirty islands, besides many small reefs. The largest island, Orango, is the most southerly of the group and some 30 m. from the coast. Bulama and Bissao, islands of more importance, lie close to the mainland. The larger rivers can be ascended by vessels of considerable size for distances of 40 to 150 m., but navigation is rendered difficult by strong currents and the shifting nature of the channels as well as by hidden rocks and the great difference between high and low water. The climate is unhealthy, with a mean temperature of about 78° F. The rainfall is heavy, thunderstorms being frequent in the wet season, which lasts from May to October.

Flora and Fauna.—Large forest regions extend behind the mangrove-lined lagoons. Their characteristic trees are the oil and date palms, the baobab, the shea-butter tree, ebony, mahogany and calabash trees, and the acacia. Rubber vines are fairly abundant. Besides the forests, densest along the river valleys, there are extensive tracts of grassland and park-like country. Fruit trees include the papaw, with fruit the size of ostrich eggs, the guava, custard apple, mango, the banana, the orange and the citron. The tobacco, indigo and cotton plants grow wild, and the coffee plant is also found. Ground-nuts and kola nuts are cultivated, and rice and millet are the chief crops grown.

The elephant is found in the district between the Geba and Grande rivers, and hippopotamus are numerous. Other animals include the panther, wild boar, various antelopes, baboons, chimpanzees and large snakes. Crocodiles and sharks abound in the rivers. Birds include the pelican, heron, marabout, the trumpet bird and innumerable yellow parrots. Partridges and woodcock are also

found. The hills of the termites are a notable feature in many parts of the country.

Inhabitants.—The people of the interior are mostly Mandingo (*q.v.*) and Fula (*q.v.*). The coast regions and the islands are inhabited by negro tribes which live side by side without mixing, each preserving their own customs, dress, language and type. They exhibit great attachment to the soil and are profoundly religious, being noted specially for their respect for family life and ancestral worship. Neither Christianity nor Mahomedanism has made much headway among them. Going from south to north the chief tribes are the Nalu, who dwell by the Cassini and are keen traders and lovers of peace; the Biafare or Biaffade, who occupy the region between the sea and the Rio Grande and jealously guard their country from strangers; the Bulam (Mankaje), living in the island of Bulama, and much given to adorning their bodies by long cuts formed into patterns; the Balanta, a piratical folk inhabiting the banks of the Geba; the Papel of the island of Bissao, formerly cannibals, an industrious agricultural tribe which furnishes the majority of the educated Africans employed by the Portuguese; the Manjak or Mandiagi, and a branch of the Felup peoples, these last living near the Rio Cacheo in savage isolation and much given to waylaying and pillaging strangers. The Manjak inhabit the country between the Mancoa and the Cacheo, and the neighbouring islands. They are a hospitable and clever people, very adaptable, do not object to leaving their tribal lands, and are said to keep their word. Excellent seamen, good artisans and sharp traders, they maintain a sort of feudal system. Their houses are surrounded by walls, which are pierced with loopholes and provided with towers at the angles. The rooms are built round a courtyard. They examine the entrails of fowl to foretell good or evil events. The burial customs are elaborate. The body is smoked and, the skin having been removed, it is sewn up in a number of *pagas* (native cloths) and placed in a coffin fastened by gilded nails. Bright tissues are wrapped round the coffin, on which are hung little bells of copper and small brass mirrors. The seaward islands of the Bissagos are inhabited by an independent and warlike tribe of fishers and pirates called Bidiogos. Their women wear a short skirt made of palm leaves.

The natives who adopt Portuguese names and who form the bulk of the townsmen in the European settlements are called Gurmettes. They furnish the levies with which the authorities occasionally make war on the native tribes. The chief centres of trade are Bissao, on the island of the same name, which is surrounded by old fortifications; Cacheo, on the Rio Cacheo, also fortified; and Bulama (Boulam) on Bulama Island, the seat of the government. The European population consists of a few Portuguese officials, soldiers, traders and convicts, and a few traders of other nationalities.

History.—Bulama Island was discovered by Portuguese navigators in 1446, but was not formally claimed by Portugal until 1752, about which time she founded a station at Bissao, while in 1669 a post had been established on the Rio Grande. In 1870 a claim made by Great Britain to Bulama and a part of the mainland was disallowed by the arbitrator appointed (President Grant of the U.S.A.). The inland limits of the Portuguese sphere were fixed by a convention concluded with France in 1886, and the frontier was delimited during 1900-1903. Though so long settled in the district—the only part of the Guinea coast west of the Gabun left in her possession—Portugal has done little towards its development. With a fertile and well-watered soil, exceedingly rich in natural products, there is not much commerce, and such trade as exists, chiefly in non-Portuguese hands, is hampered by excessive customs duties and vexatious regulations. In 1905 the external trade of the colony was not more than £160,000 and was less than it had been twenty years previously. Ground-nuts, rubber, wax and ivory are the principal exports. Revenue and expenditure are about £50,000 a year. Portuguese authority does not in fact extend much beyond the few stations maintained, nor has the local government won the confidence of the natives. In 1908 Bissao and some European settlements on the mainland were besieged by the Papel and other tribes and troops had to be sent from Portugal before order could be restored. If however agriculture and commerce suffer, the ethnologist and zoologist find in this easily accessible little enclave a rich field for investigation, the almost nominal sovereignty of Portugal having left the country, practically uninfluenced by European culture, in much the same condition that it was in the 16th and 17th centuries.

See J. E. Giraud, "La Guinée portugaise" in *Bull. soc. géog. Marseille* (1905), vol. xxix.; A. L. de Fonseca, "Guiné" in *Bull. soc. géog. Lisboa* (1905), vol. xxiii.; R. Wagner, "Portugiesisch

Guinea: Land und Leute," in *Deutsche Rundschau*. (1905), vol. xxvii.; E. de Vasconcelles, *As Colonias portuguesas* (Lisbon, 1896-1897); and J. Machat, *Les Rivières du sud* (Paris, 1906), in which are cited many papers dealing with Portuguese Guinea.

PORTUNUS, or **PORTUMNUS**, in Roman mythology, originally the god of gates and doors (Lat. *porta*), and as such identified with Janus and represented with a key in his hand. Gradually he came to be recognized as a separate deity, who protected the harbours (*portus*) and ensured a safe return to seafarers. (Cicero, *Nat. deor.* ii. 26; Virgil, *Aen.* v. 241). With the introduction of the Greek gods, he became merged in Palaemon-Melicertes. He had a special priest (flamen portunalis) and temples on the Tiber near the Aemilian bridge and near Ostia, where a festival was celebrated in his honour on the 17th of August. Mommsen unhesitatingly identifies Portunus with the river-god Tiberinus, from the fact that the festival is also called Tiberinalia in the *fasti* of Philocalus; Marquardt regards him rather as the tutelary deity of warehouses.

See J. Marquardt, *Römische Staatsverwaltung* (1885), iii. 327, note 10.

PORTUS, an ancient harbour of Latium, Italy, on the right bank of the Tiber, at its mouth. For its origin see OSTIA. Claudius constructed the first harbour here, 2½ m. north of Ostia, enclosing an area of 170 acres, with two long curving moles projecting into the sea, and an artificial island, bearing a lighthouse, in the centre of the space between them; the harbour thus opened directly to the sea on the north-west and communicated with the Tiber by a channel on the south-east. The object was to obtain protection from the prevalent south-west wind, to which the river mouth was exposed. Though Claudius, in the inscription which he caused to be erected in A.D. 46, boasted that he had freed the city of Rome from the danger of inundation, his work was only partially successful. Nero gave the harbour the name of Portus Augusti. It was probably Claudius who constructed hither the direct road from Rome, the Via Portuensis (15 m.) which ran over the hills as far as the modern Ponte Galera, and then straight across the plain. An older road, the Via Campana, ran along the foot of the hills, following the right bank of the Tiber, and passing the grove of the Arval Brothers at the sixth mile, to the *Campus salinarum romanarum*, the saltmarsh on the right bank—from which indeed it derived its name (see *Notizie degli Scavi*, 1888, p. 228).

The site can still be fairly clearly traced in the low ground to the east of Fiumicino, and the lighthouse is represented in bas-reliefs. The harbour is generally supposed to have been protected by two moles with a breakwater in front, on which stood the lighthouse, with an entrance on each side of it. Trial soundings made in 1907 showed that the course of the right-hand mole is represented by a low sandhill, while the central breakwater was only some 190 yds. long, and probably divided from each of the two moles by a channel some 125 yds. wide. The existence of two entrances is, indeed, in accordance with the evidence of coins and literary tradition, though the position of that on the left is not certain, and it may have been closed in later times. The whole course of the left-hand mole has not yet been traced, but it seems to have protected not only the south-west but a considerable portion of the north-west side of the harbour. In A.D. 103 Trajan constructed another harbour farther inland—a hexagonal basin enclosing an area of 97 acres, and communicating by canals with the harbour of Claudius, with the Tiber direct, and with the sea, the last now forming the navigable arm of the Tiber (reopened for traffic by Gregory XIII. and again by Paul V.), and bearing the name Fossa trajana, though its origin is undoubtedly due to Claudius. The basin itself is still preserved, and is now a reedy lagoon. It was surrounded by extensive warehouses, remains of which may still be seen: the fineness of the brickwork of which they are built is remarkable. Farther to the east is a circular building in brick with niches; it is called the temple of Portumnus. To the east again is the so-called Arco di Nostra Donna, a gateway (possibly originally built by Trajan) in the fortifications which surround the port and are attributed to the time of Constantine. Many other remains of buildings exist; they were more easily traceable in the 16th century when Pirro Ligorio and Antonio Labacco made plans of the harbour. Considerable excavations were carried on in 1868, but unfortunately with the idea of recovering works of art and antiquities; and the plan and description given by R. Lanciani (*Annali del istituto*, 1868, 144 sqq.) were made under unfavourable circumstances. By means of these works Portus captured the main share of the harbour traffic of Rome, and though the importance of Ostia did not at once decrease we find Portus already an episcopal see in Constantine's time not very

long (if at all) after Ostia, and as the only harbour in the time of the Gothic wars. Its abandonment dates from the partial silting up of the right arm of the Tiber in the middle ages, which restored to Ostia what little traffic was left. To the west of the harbour is the cathedral of S. Rufina (10th century, but modernized except for the campanile) and the episcopal palace, fortified in the middle ages, and containing a number of ancient inscriptions from the site. On the island (Isola Sacra) just opposite is the church of S. Ippolito, built on the site of a Roman building, with a picturesque medieval campanile (13th century?); 2 m. to the west is the modern village of Fiumicino at the mouth of the right arm of the Tiber, which is 21 m. west-south-west by rail from Rome. It is a *frazione*, or portion of the commune of Rome. Three miles to the north is the pumping station by which the lowland (formerly called Stagno di Maccarese, now reclaimed and traversed by many drainage canals) between here and Maccarese is kept drained (Bonifica di Maccarese) (see TIBER). See H. Dessau in *Corp. inscr. latin.* xiv. 1 sqq. (Berlin, 1887); J. Carcopino in *Notizie degli Scavi* (1907), p. 734. (T. As.)

PORT-VENDRES, a seaport of south-western France, in the department of Pyrénées-Orientales, in an inlet of the Mediterranean Sea, 19½ m. S.S.E. of Perpignan by rail. Pop. (1906), 2525. Port-Vendres, the ancient *Portus Veneris*, is fourth in importance of the French Mediterranean ports, and forms a good harbour of refuge. Its trade, which is with Spain, Greece and Algeria, is in cork, carobs, grain and wine, &c.

PORUS (4th century B.C.), an Indian prince, ruler of the country between the rivers Hydaspes and Acesines at the time of the invasion of Alexander the Great. In the battle on the banks of the Hydaspes he offered a desperate resistance, and Alexander, struck by his independent spirit, allowed him to retain his kingdom, which he increased by the addition of territory. From this time Porus was a loyal supporter of Alexander. He still held the position of a Macedonian satrap when assassinated some time between 321 and 315 B.C.

See Arrian v. 18, 19; Plutarch, *Alexander*, 60; Quintus Curtius viii. 14.

PORZIO, CAMILLO (1526-1580?), Italian historian, belonged to a wealthy and noble Neapolitan family, and was the son of the philosopher, Simone Porzio. He studied law, first at Bologna and later at Pisa, and after graduating *in utroque jure*, practised as a lawyer in Naples. He died in 1580. His chief literary work is *La Congiura dei baroni*, a history of the unsuccessful conspiracy of the Neapolitan barons against King Ferdinand I. of Naples in 1485; it is based on the authentic records of the state trials, but is prejudiced in favour of the royal power. It was first published by Manutius in Rome in 1565. Of Porzio's other works, the *Storia d'Italia* (from 1547 to 1552), of which only the first two books have survived, is the most important. The best edition of these two works is that edited by C. Monzani (Florence, 1855).

PORZIO, SIMONE (1497-1554), Italian philosopher, was born and died at Naples. Like his greater contemporary, Pomponazzi, he was a lecturer on medicine at Pisa (1546-1552), and in later life gave up purely scientific study for speculation on the nature of man. His philosophic theory was identical with that of Pomponazzi, whose *De immortalitate animi* he defended and amplified in a treatise *De mente humana*. There is told of him a story which illustrates the temper of the early humanistic revival in Italy. When he was beginning his first lecture at Pisa he opened the meteorological treatises of Aristotle. The audience, composed of students and townspeople, interrupted him with the cry *Quid de anima?* (We would hear about the soul), and Porzio was constrained to change the subject of his lecture. He professed the most open materialism, denied immortality in all forms and taught that the soul of man is homogeneous with the soul of animals and plants, material in origin and incapable of separate existence.

POSEIDON, in Greek mythology, god of the sea and of water generally, son of Cronus and Rhea, and brother of Zeus and Pluto. The connexion of his name with *πόσις*, *πόντος*, *ποταμός*, is generally accepted. When the three brothers deposed their father Cronus the kingdom of the sea fell by lot to Poseidon. His home was in a golden palace in the depths of the sea near Aegae in Achaëa. In his hand he bore a trident, wherewith he lashed the sea into fury, split the rocks, and caused horses and

fountains to spring from them. But, while he caused storms and shipwrecks, he could also send favouring winds; hence he was known as *Sotēr*, "the preserver." Another of his titles was *Gaecochoos*, "the supporter of earth," the sea being supposed to support the earth and keep it firmly in its place. He was the god of navigation and his temples stood especially on headlands and isthmuses. Every occupation connected with the sea was under his protection, and seafaring people, especially the Ionians, regarded themselves as his descendants. As god of the sea he disputed with other deities for the possession of the land. Earthquakes were thought to be produced by Poseidon shaking the earth—hence his epithet of *Enosichthon*, "Earth-shaker"—and hence he was worshipped even in inland places which had suffered from earthquakes. The seismic wave was also his work; the destruction of Helice in Achaea by such a wave (373 B.C.) was attributed to his wrath (Strabo viii. 384). The island of Delos was thought to have been raised by him, and about 198, when a new island appeared between Thera and Therasia, the Rhodians founded a temple of Poseidon on it (Strabo i. 57). Thessaly was said to have been a lake until he opened a way for the waters through the Vale of Tempe (Herodotus vii. 129). Poseidon was also the god of springs, which he produced by striking the rock with his trident, as he did on the acropolis of Athens when disputing with Athena for the sovereignty of Athens (Herodotus viii. 55; Apollodorus iii. 14). As such he was called *Nymphagetes*, the leader of the nymphs of springs and fountains, a god of fresh water, probably his original character, and in this connexion was *φυτάμιος* (*phytalmios*), a god of vegetation, frequently associated with Demeter. In regard to the contest with Athena, it is probable that Poseidon is really Erechtheus, a local deity ousted by Athena and transformed into an agricultural hero. Dr Farnell, however, holds that Erechtheus and Poseidon were originally independent figures, and that both Erechtheus and Athena were prior to Poseidon. As he gave, so he could withhold, springs of water; thus the waterless neighbourhood of Argos was supposed to be the result of his anger. Black bulls, symbolical of the stormy sea, were sacrificed to him, and often thrown alive into rivers; in Ionia and Thessaly bull-fights took place in his honour; at a festival of his at Ephesus the cupbearers were called "bulls," and the god himself was surnamed "Bull Poseidon." The horse was especially associated with his worship; he was said to have produced the first horse by striking the ground in Thessaly with his trident (Virgil, *Georgics*, i. 12). At the fountain of Dīnē in Argolis horses bitted and bridled were sacrificed to him by being drowned (Pausanias viii. 7, 2), and similarly Sextus Pompeius sought to propitiate him by throwing horses into the sea (Dio Cassius xlviii. 48). He bore the surname of "Horse Neptune" (*Ποσειδῶν ἵππιος*), and was regarded as the tamer as well as the creator of the steed. In the deme of Colonus he was worshipped with Athena, the reputed inventor of the bridle. Various explanations of the title *ἵππιος* have been given: (1) that the horse represented the corn-spirit; (2) the resemblance of the crested waves to horses; (3) the impression of horses' hoofs near the god's sacred springs, and the shaking of the earth by them when galloping (see Farnell, *Cults of the Greek States*, iv. 20). Poseidon plays a considerable part in Greek legend. In the Trojan War he takes the side of the Greeks, because he had been cheated of his reward by Laomedon, king of Troy, for whom he had built the walls of the city. The binding of his son Polyphemus by Odysseus brings upon the hero the wrath of Poseidon, from which he is only protected by the united influence of the rest of the gods. He is famous for his numerous amours, especially with the nymphs of springs and fountains; his offspring were mostly wild and cruel, like the sea—the Laestrygones, Polyphemus, Antaeus, Procrustes and the like. He was worshipped as a national god by the Ionians, who took his worship over with them from Peloponnesus to Asia Minor. His chief sanctuary was at Mycale, where the Panionia, the national festival of the Ionians, was held. Other seats of his worship were in Thessaly, Boeotia and Peloponnesus. At Taenarum in Laconia he had a famous cave-like temple, with an asylum,

and on the island of Tenos he was worshipped as the physician, probably in reference to the health-giving properties of the sea air. By far the most famous of his festivals was that celebrated every alternate year on the isthmus of Corinth, at which the "Isthmian games" were held. Here a colossal statue of him was set up in bronze by the Greeks after their victory over the Persians. The horse, the dolphin (the symbol of the calm sea) and the pine-tree, with wreaths of which the Isthmian victors were crowned, were sacred to him. Horses and black bulls, boars and rams were offered to him, sometimes human beings. His attributes are the trident and the dolphin (sometimes the tunny fish.)

As represented in art Poseidon resembles Zeus, but possesses less of his majestic calm, his muscles are more emphasized, and his hair is thicker and somewhat dishevelled. He is generally naked; his right leg rests on a rock or the prow of a ship; he carries a trident in his hand, and is gazing in front of him, apparently out to sea; sometimes he is standing on the water, swinging his trident, or riding in his chariot over the waves, accompanied by his wife Amphitrite, the Nereids and other inhabitants of the sea. It is in keeping with his restless character that he is rarely found sitting. He sometimes wears a long robe, sometimes a light scarf. Scopas, in a famous group, represented him surrounded by the denizens of the sea, escorting Achilles to the islands of the blest. In modern Greece St Nicholas has taken the place of Poseidon as patron of sailors. But the Zacynthians have a special seagod, half man, half fish, who dwells under the sea, rides on dolphins or in a car drawn by dolphins, and wields a trident. By the Romans Poseidon was identified with Neptune (*q.v.*).

See E. Gerhard, *Über Ursprung, Wesen und Geltung des Poseidon* (1851), with references to authorities in conveniently arranged notes; Preller-Robert, *Griechische Mythologie* (1894); O. Gruppe, *Griechische Mythologie* (1906), vol. ii.; and especially L. R. Farnell, *Cults of the Greek States* (1907), vol. iv., where special attention is drawn to the ethnological aspect of the cult of Poseidon.

POSEN, an eastern province of the kingdom of Prussia, in the German Empire, bounded N. by the Prussian province of West Prussia, E. by Russian Poland and S. and W. respectively by the Prussian provinces of Silesia and Brandenburg. Its area is 11,186 sq. m. and the population shows a density of 177.5 inhabitants to the square mile. Posen belongs to the north German plain, and consists of a low plateau intersected by the beds of the Netze, the Warthe and the Obra. These three rivers drain into the Oder, but part of the province falls within the basin of the Vistula, which forms the frontier for a short distance on the north-east. By means of the Bromberger canal the Netze is joined with the Brake and then through this river with the Vistula. The surface is dotted with small lakes and ponds, and there are many broad fens and marshes. The soil is light and sandy, but much of the land reclaimed in the boggy districts is very fertile. Upwards of 61% of the area is under tillage, 13% is occupied by pasture and meadows and 20% by forests, mostly fir. The principal crops are rye, the chief cereal grown, wheat, oats, barley, potatoes, beets and hops. The vine is cultivated to some extent in the south-west corner, and tobacco is also grown. The marshy tracts often afford excellent pasture and support large numbers of cattle, sheep and goats. The mineral resources of the province are practically restricted to lignite and salt. Besides brewing and distilling, the chief products are machinery, sugar, cloth, tobacco and bricks. Trade in timber and agricultural produce is facilitated by the network of railways, navigable rivers and canals, but both industry and trade are somewhat cramped by the duties imposed at the Russian frontier. The population of the province in 1905 was 1,986,637, including 1,347,958 Roman Catholics, 605,312 Protestants and 30,433 Jews. The Roman Catholics are mainly Poles, of whom there are upwards of 1,000,000 in Posen, while the great bulk of the 900,000 Germans are Protestants. About 57% of the population was returned in 1905 as "rural," in spite of the large number of so-called "towns," only five of which, however, have more than 20,000 inhabitants—Posen, Bromberg, Hohensalza, Gnesen and Schneidemühl. The province of Posen was long the worst-educated part of the German dominions, but of recent years this blemish has been removed. Thus while in 1882-1883 the ratio of illiterate recruits amounted to 9.75%, in 1901 less than one quarter per cent of

the military drafts were without schooling. The province returns 15 members to the Reichstag, 29 to the Prussian Lower House of the Prussian Diet, and is represented in the Upper House by 19 members. It is divided into two districts, those of Bromberg and Posen.

History.—The history of Posen, comprehending some part of the old kingdom of Poland, including its most ancient capital, Gnesen, falls within the scope of the article POLAND. Its political connexion with Prussia began in 1772, when the districts to the north of the Netze fell to the share of that power in the first partition of Poland. The rest followed in 1793, and was united with the Netze district to form the province of South Prussia. In 1807, after the peace of Tilsit, Posen was incorporated with the grand duchy of Warsaw, but in 1815 it reverted to Prussia under the style of the grand duchy of Posen. In 1848 the Polish inhabitants of the province revolted and had to be put down by force, and, in spite of the efforts of the Prussian government, they remain in language and culture separated from their German compatriots.

The tide of German immigration into Posen began at an early period and flowed strongly in the 13th and following centuries. The industrious German settlers were welcomed by the Polish nobles and were the founders of most of the towns, in which they lived after their own customs and were governed by their own laws. They established manufactures, introduced the cultivation of hops, reclaimed the waste soil, and did much to improve agriculture. In the 16th century Protestantism was widely diffused by their means. A strong reaction set in in the following century, and persecution of the Protestants went hand in hand with the ravages of war in hastening the political, intellectual and agricultural decline of the district. By the 18th century the burghers had sunk to the level of "städtische Bauern," or peasants with municipal privileges, and poverty and misery were widely spread.

In the latter part of the 19th century, however, this state of things began to be greatly modified owing to the strong Polish national movement which threatened to drive back the boundaries of Germanism in the eastern provinces of Prussia, as they had already been driven back in Bohemia. Hitherto the most important class in Posen had been the Polish nobles, of whom many were very poor; but the economic development of the country and the break-up of the large estates into peasant holdings, which created a comparatively wealthy Polish middle class, threatened German ascendancy more seriously than had the traditional nationalism of the nobles. To combat this the Prussian government entered on a policy of the compulsory Germanization of the Polish population. In 1872 an administrative ordinance made German the medium of instruction in the schools "wherever possible," and the police commissaries who attended public meetings were instructed to close any meeting at which speeches were delivered in Polish. In April 1888 the Prussian parliament passed a law establishing a commission for the purpose of buying the land of the Poles in Posen and West Prussia, and letting it out to German colonists. The sum of 100,000,000 marks (£5,000,000) was voted for this work, to which in 1898 a like sum was added. In fifteen years an area of nearly 600 sq. m. of land was bought from the Poles, over one-half in Posen, and on this over 4000 families were settled. In spite of this policy, however, the Polish element continued to gain, this being partly due to immigration over the eastern border, partly to the repressive policy of the Prussian government, which converted what had been an aristocratic opposition into one that is popular and radical. In 1902 much scandal was caused by the revelation made in the Prussian parliament of the methods used in the attempt to Germanize the Poles; and Count Bülow had to confess that "corporal punishment was out of place in religious instruction"; Polish children having been beaten for refusing to say the Lord's Prayer in German (see *Ann. Reg.*, 1901, p. 278). In his speech of the 13th of January 1903, in which he made the above admission, Count Bülow also had to admit the failure of the Prussian policy. Fresh legislation was passed in May, devoting another 250,000,000 marks (£12,500,000) to the policy of German colonization, and forbidding the German colonists to sell their land to Poles.¹ The laws forbidding the use of the Polish language in the schools were retained, in spite of an agitation in Germany itself for their repeal. Yet, three years later, Baron von Rheinbaben, the Prussian minister of finance, complained that in fifteen years the German population of East Prussia had diminished by 630,000, while Polish immigrants had in five years numbered 300,000; at the same time he confessed that the Poles were vastly increasing their economic resources at the expense of the German element. As a result of this report a further sum of £100,000 was voted for "provincial colonization" and to prevent German emigration.

In 1906 the Prussian government was made somewhat ridiculous by the strike of some 100,000 Polish school children, who objected to being whipped for refusing to answer questions in German. The petition of the archbishop of Posen that the children should be allowed to receive religious instruction in Polish having been rejected by the Prussian minister of education, he issued on the 17th of October a pastoral allowing parents to confine religious instruction

to home or priestly teaching. As a result parents were fined or imprisoned for withdrawing their children from religious instruction. The repressive efforts of the government, however, culminated in the bill, introduced in the session of 1907 by Prince Bülow, providing for the compulsory expropriation of Polish landowners in favour of Germans. This bill, which applied to "the districts in which the safety of the endangered German element could only be ensured by additional allotments to German settlers"—i.e. Posen and West Prussia—was passed, in spite of the strenuous opposition of some of the most conspicuous nobles in Prussia, in the session of 1908. At the same time under the Public Meetings Bill, introduced in 1907 and now passed, no language save German was to be used at any public meetings other than international congresses, &c.—save during actual parliamentary elections (*Ann. Reg.*, 1908, p. 290). How opposed to the general sentiment of Germany the Prussian policy in Posen was, was shown in February 1909, when it was condemned, though without effect, by a resolution of the German imperial parliament. In January 1910 the Prussian policy was again arraigned in the German parliament in connexion with the "Kattowitz incident," Herr von Delbrück justifying the removal of a number of minor officials, for voting for Polish candidates at a municipal election, on the ground that the officials of the empire deserted the ground on which the constitution of the empire rested if they failed to support Prussia in her struggle (The Times, January 13, 1910, 5 d.). Herr von Bethmann Hollweg expressed himself later in the Prussian parliament to the same effect (*ibid.* January 20 and 22).

For the history of Posen see Wuttke, *Städtebuch des Landes Posen* (Leipzig, 1864); C. Meyer, *Geschichte des Landes Posen* (Posen, 1887), and *Geschichte der Provinz Posen* (Gotha, 1891); Knoop, *Sagen und Erzählungen aus der Provinz Posen* (Posen, 1894); E. von Bergmann, *Zur Geschichte der Entwicklung deutscher, polnischer und jüdischer Bevölkerung in der Provinz Posen seit 1824* (Tübingen, 1883); E. Schmidt, *Geschichte des Deutschtums im Lande Posen unter polnischer Herrschaft* (Bromberg, 1904); Stumple, *Polenfrage und Ansiedelungskommission. Darstellung der staatlichen Kolonisation in Posen* (Berlin, 1902); Wegener, *Der wirtschaftliche Kampf der Deutschen mit den Polen um die Provinz Posen* (Posen, 1903); the *Handbuch für die Provinz Posen, Nachweisung der Behörden, Anstalten, Institute und Vereine* (Posen, 1905); and the publications of the *Historische Gesellschaft für die Provinz Posen* (Posen, 1882 seq.). See further the official work *Zwanzig Jahre deutscher Kulturarbeit 1886-1906* (Berlin, 1907). A good account of the Prussian policy in Posen, from an outside point of view, will be found in the *Annual Register*, passim.

POSEN (Polish *Poznan*), a city, archiepiscopal see and fortress of Germany, capital of the province of Posen, situated in a wide and sandy plain at the confluence of the Cybina and the Warthe, 150 m. E. from Berlin and 103 m. from Breslau. Pop. (1885), 68,315; (1895), 73,239; (1905), 136,808, of whom nearly one-half are Germans and about one-tenth Jews. Posen lies at the centre of a network of railways connecting it with Berlin, Breslau, Thorn, Kreuzburg, and Schneidemühl. The inner line of fortifications was removed in 1902 and the city has been completely modernized. The principal part of Posen, on the left bank of the Warthe, comprises the old town (Alstadt) and the modern quarter created by the Prussians after 1793. On the right bank lie Wallischei (a district inhabited by Poles) and some other suburbs. Posen has fifteen Roman Catholic and three Evangelical churches and several synagogues. The cathedral contains many interesting objects of art, but, with the exception of the Gothic Marienkirche of the 15th century, none of the churches is notable. The old town-hall is a quaint Slavonic adaptation of Romanesque forms. The royal castle, begun in 1905 and completed in 1910 at a cost of £250,000, is a pretentious building in what is officially called Romanesque style. It was intended as an effort to conciliate the Poles, and was opened by the emperor William II., with imposing ceremonies, on the 20th of August 1910. Posen possesses an "Emperor William" library with 200,000 volumes, and the Raczynski library with 50,000. Other principal buildings are the two theatres, the Emperor Frederick museum, founded in 1894, the Polish museum and the various public offices. Industries include the manufacture of agricultural machinery, spirits, furniture and sugar, also milling and brewing. There is an active trade, both by rail and river, in corn, cattle, wood, wool and potatoes. Posen is the headquarters of the V. army corps, and has a garrison of 6000 men.

Posen, one of the oldest towns in Poland and the residence of some of the early Polish princes, including Boleslaus I.,

¹ *Annual Register* (1902), p. 280 seq.

became the seat of a Christian bishopric about the middle of the 10th century. The original settlement was on the right bank of the Warthe, but the new town, established on the opposite bank by German settlers about 1250, soon became the more important part of the double city. Posen became a great *dépôt* for the trade between Germany and western Europe on the one hand and Poland and Russia on the other. Many foreign merchants made the city their residence, and these included a colony of Scots, who exported produce to Edinburgh. The city attained the climax of its prosperity in the 16th century, when its population, according to one estimate, reached 80,000. The intolerance shown to the Protestants, the troubles of the Thirty Years' War, the plague and other causes, soon conspired to change this state of affairs, and in the 18th century the population sank to 12,000. New life was infused into the city after its annexation by Prussia at the second partition of Poland in 1793, and since this date its growth has been rapid.

See Lukaszewicz, *Historisch-statistisches Bild der Stadt Posen 968-1793* (Ger. trans., Posen, 1881); Ohlenschläger, *Kurzgefasste Geschichte und Beschreibung der Stadt Posen* (Posen, 1886); Warschauer, *Stadtbuch von Posen* (Posen, 1892); and *Führer durch Posen* (Posen, 1895).

POSIDIPPUS (3rd cent. B.C.), Greek dramatist, of Cassandrea in Macedonia, the last and one of the most distinguished of the writers of the new comedy. He began to write for the stage in 289 B.C., and, according to Suidas, wrote 40 plays, of which 17 titles and some fragments have been preserved. He appears to have gone somewhat out of the beaten track in his choice of subjects, and it is evident that cooks held an important position in his list of characters. His comedies were frequently imitated by the Romans (Aulus Gellius ii. 23), and it is considered very probable that the *Menæchmi* (a comedy of errors) of Plautus is an adaptation either from the "Ὀμοιοί, or from some unknown comedy of Posidippus, called *Δίδυμοι*, or perhaps *Μέναιχομοι*. His statue in the Vatican is considered a masterpiece of ancient art.

Fragments in A. Meineke, *Poetarum comicorum graecorum fragmenta* (1855).

POSIDIPPUS is also the name of a writer of epigrams (c. 270 B.C.), of which about 30 are preserved in the Greek Anthology.

See W. Christ, *Griechische Literaturgeschichte* (1898).

POSIDONIUS (c. 130-50 B.C.), nicknamed "the Athlete," Stoic philosopher, the most learned man of his time (so Strabo τῶν κατ' ἡμᾶς φιλοσόφων πολυμαθέστατος, Galen ἐπιστημονικώτατος) and perhaps of all the school. A native of Apamea in Syria and a pupil of Panaetius, he spent after his teacher's death many years in travel and scientific researches in Spain (particularly at Gades), Africa, Italy, Gaul, Liguria, Sicily and on the eastern shores of the Adriatic. When he settled as a teacher at Rhodes (hence his surname "the Rhodian") his fame attracted numerous scholars; next to Panaetius he did most, by writings and personal intercourse, to spread Stoicism in the Roman world, and he became well known to many leading men, such as Marius, Rutilius Rufus, Pompey and Cicero. The last-named studied under him (78-77 B.C.), and speaks as his admirer and friend. He visited Rome, e.g. on an embassy in 86 B.C., but probably did not settle there as a teacher.

His works, now lost, were written in an attractive style and proved a mine of information to later writers. The titles and subjects of more than twenty of them are known. In common with other Stoics of the middle period, he displayed eclectic tendencies, following the older Stoics, Panaetius, Plato and Aristotle. His admiration for Plato led him to write a commentary on the *Timæus*; in another way it is shown by important modifications which he made in psychological doctrine. Unquestionably more of a polymath than a philosopher, he appears uncritical and superficial. But at the time his spirit of inquiry provoked Strabo's criticism as something alien to the school (τὸ αἰτιολογικὸν καὶ τὸ ἀριστοτέλειον, ὅπερ ἐκλίνουσιν οἱ ἡμέτεροι). In natural science, geography, natural history, mathematics and astronomy he took a genuine interest. He sought to determine the distance and magnitude of the sun, to calculate the diameter of the earth and the influence of the moon on the tides. His history of the period from 146 to 88 B.C., in fifty-two books, must have been a valuable storehouse of facts. Cicero, who submitted to his criticism the memoirs which he had written in Greek of his consulship,

made use of writings of Posidonius in *De natura deorum*, bk. ii., and *De divinatione*, bk. i., and the author of the pseudo-Aristotelian treatise *De mundo* also borrowed from him.

See Zeller, *Philosophie der Griechen*, iii. 1, 570-584 (in Eng. trans., *Eclecticism*, 56-70); C. Müller, *Fragmenta historicorum graecorum*, iii. 245-296; J. Bake, *Posidonii Rhodii reliquiae* (Leiden, 1810), a valuable monograph; R. Scheppig, *De Posidonio rerum gentium terrarum scriptore* (Berlin, 1869); R. Hirzel, *Untersuchungen zu Ciceros philosophischen Schriften*, i. 191 seq., ii. 257 seq., 325 seq., 477-535, 756-789, iii. 342-378 (Leipzig, 1877); Thiaucourt, *Essai sur les traités philosophiques de Cicéron* (Paris, 1885); Schmekel, *Die Philosophie der mittlern Stoa* (1892); Arnold, *Untersuchungen über Theophrastus von Mytilene und Posidonius von Apamea* (1882). (See also STOICS.)

POSITIVE (or **PORTABLE**) **ORGAN**, a medieval chamber organ which could be carried from place to place without being taken to pieces, and when played was placed on a table or stool and required a blower for the bellows, as well as a performer. It was larger and more cumbersome than the portable (*q.v.*), with which it has often been confounded. The positive had usually but one kind of pipe, the open diapason of 2 ft. tone, and in the 16th century the best types had three registers by means of which each note could be sounded with its fifth and octave, or each by itself, or again in combinations of twos. The positive differed from the regal in having flue pipes, whereas the latter had beating reeds in tiny pipes, one or two inches long, concealed behind the keyboard. During the early middle ages most of the pneumatic organs belonged to this type.

A well-known instance of an early positive or portable organ of the 4th century occurs on the obelisk erected to the memory of Theodosius the Great, on his death in A.D. 395. Among the illuminated manuscripts of the British Museum miniatures abound representing interesting varieties of the portable organ of the middle ages; such as Add. MS. 29902 (fol. 6) and Add. MS. 27695b (fol. 13), Cotton MS. Tiberius A VII. fol. 104d., all of the 14th century, Add. MS. 28962, Add. MS. 17280, both of the 15th century. These little organs were to be found at every kind of function, civil and religious; they were used in the dwellings and chapels of the rich; at banquets and court functions; in choirs and music schools; and in the small orchestras of Peri and Monteverdi at the dawn of the musical drama or opera. (K. S.)

POSITIVISM (derived from *ponere*, whence *positus*, that which is laid down, certain), a philosophical term, applied somewhat loosely to any system which confines itself to the data of experience and declines to recognize a priori or metaphysical speculations. In this sense the term may be applied to empirical philosophers in general. Thus Hume is a positivist in the sense that he specifically restricts philosophy to the sphere of observation, and regards the causal relation as being nothing more than what we have been accustomed to expect. Similarly Mill, Spencer and physical scientists generally view the universe from the positivist standpoint. In its commonest acceptation, however, positivism is both narrower and wider than this. The term is specifically used of the philosophy of Auguste Comte, who applied the term to his system according to which knowledge is based exclusively on the methods and discoveries of the physical or "positive" sciences. According to Comte human thought passes through three stages—*theological*, *metaphysical* and *positive*. The final stage, positivism, is the understanding of the universe not as composed of a multitude of individuals each with volition, but as an ordered organism governed by necessary laws (see further **COMTE**). The outcome of this positivism is the substitution for revealed religion of a religion of humanity—according to Huxley "Catholicism minus Christianity"—in which God is replaced by Humanity. This religion was to have its special priesthood, ritual and organization.

Positivism has, therefore, two distinct sides, the philosophical and the religious or mystical. Philosophical positivism has had distinguished representatives in France, Germany and England, and in the wider sense indicated above may be regarded as one of the two or three chief influences on modern philosophical development. Though the details of Comte's philosophic structure, e.g. the classification of the sciences, are without important significance, the positivistic tendency is prominent in all systems of thought which deny the supernatural and the metaphysical. Agnosticism, Phenomenalism, Rationalism, Materialism all manifest the positivist spirit, denying what may be succinctly described as the *metempirical*.

In France the Comtian tradition was maintained with important reservations and the abandonment of the religious aspect by Littré (*q.v.*), Taine and others. In Germany many of the followers of Kant have in greater or less degree maintained the view that all true knowledge depends upon the observation of objective phenomena. The distinctly religious aspect has been comparatively unimportant, except in so far as modern social evolutionist ethics may be regarded as religious in character. In England, however, a number of prominent Positivists have carried out Comte's original ideal of a Church of Humanity with ritual and organization. The chief building (in Chapel Street, Lamb's Conduit Street, London) is adorned with busts of the saints of humanity, and regular services are held. Positivist hymns are sung and addresses delivered. Among the leaders of this movement have been Frederic Harrison, Richard Congreve, E. S. Beesly and J. H. Bridges (d. 1906). Services are also held weekly in Essex Hall, London, and there are a few other centres in the provinces, including a prosperous church in Liverpool.

POSSE COMITATUS (Lat. "power of a county"), a summons to every male in the county, between the ages of fifteen and twenty, to be ready and apparelled, at the command of the sheriff and the cry of the county, to maintain peace and pursue felons. Ecclesiastical persons, peers and such as laboured under any infirmity were not compellable to attend. Owing to the establishment of county police, the sheriff does not now pursue felons, but by the Sheriffs Act (1887, sec. 8, sub-sec. 2) the calling out of the posse comitatus is expressly authorized if the sheriff finds any resistance in the execution of a writ. In view of the sheriff's duty to raise, if necessary, the posse comitatus it is no answer by him, for non-execution of a writ, to say that he was resisted.

See P. E. Mather, *Sheriff Law*.

POSSESSION (Lat. *possessio, possidere*, to possess), in law, a term derived from Roman law. The Roman conception of possession has been generally adopted, but not the Roman deductions from the conception. The subject of possession has become more difficult owing to the various senses in which the term has been interpreted. Thus it has been said to be either a right or a fact conferring a right, or both together. The latter is the view of Savigny, the leading authority upon the subject (*Recht des Besitzes*, translated by Sir Erskine Perry, 1848). Further, there is a want of agreement among legal writers as to the amount of right or rights that it confers. All that can be said with safety is that possession stands in a position intermediate between simple detention and absolute ownership, and that it implies two elements, physical detention and mental intention to hold the thing possessed as one's own. These difficulties being borne in mind, the definition of W. A. Hunter may be accepted: "Possession is the occupation of anything with the intention of exercising the rights of ownership in respect of it" (*Roman Law*, p. 209). Possession is inchoate or incomplete ownership; it is on its way to become ownership. In the case of the public domain of Rome (*ager publicus*) the possession was really the important matter, the *dominium* being practically of no value. Possession in Roman law was either *natural* or *civil*. The former was mere occupation, the latter such occupation as ripened by prescription into ownership. Possession exclusive against the world (including the true owner) was called "adverse possession." A servitude, such as a right of way, could not be held in true possession, but was said to be in "quasi-possession." The quasi-possessor, however, had possessory remedies. In Roman law a broad distinction was drawn between possession and ownership (*dominium*).¹ They were protected by different remedies—possession by interdict, ownership by action. This difference can only be explained by history. Here again, unfortunately, authorities differ. According to Savigny, a Roman citizen who had become a tenant of part of the *ager publicus* could not by any length of holding obtain more than a quasi-ownership, but one of which it would have been morally unjust to have deprived him. "The only legal remedies of which the tenants could avail themselves, if ejected or threatened with disturbance, were the possessory interdicts, summary processes of Roman law which were either expressly devised by

the praetor for their protection, or else, according to another theory, had in older times been employed for the provisional maintenance of possessions pending the settlement of questions of legal right" (Maine, *Ancient Law*, ch. viii.). Savigny regards the protection of possession as an extension of the protection of the person. The same view was taken by the English court of exchequer in *Rogers v. Spence*, 13 M. & W. R. p. 581. According to Hunter (*Roman Law*, pp. 206, 221), Savigny overlooked the needs of aliens. It was the needs of aliens, incapable of the full proprietary rights of Roman citizens, that led to the invention by the praetor of a means of giving them equitable rights in the land, and protecting them in the enjoyment of these rights. Savigny attributes only two rights to possession in Roman law—acquisition of ownership by possession for a given time (*usucapio, longi temporis possessio*) and protection of possession from disturbance (*interdictum*). Others have included further rights—*inter alia*, the right to use force in defence of possession, and the right to have the burden of proof, in a contest as to the title, thrown upon the adversary: "In pari causa possessor potior haberi debet." The position of the possessor in Roman law was very strong. If a *bona fide* possessor, he could bring an action for *furtum* even against the owner, if a *mala fide* possessor of land, he was so far protected that he could not be ejected by force. A *mala fide* possessor of movables could, however, acquire no rights.²

It has been already stated that there is both a physical and a mental element in the conception of possession. This does not necessarily mean that corporal contact is in all cases requisite, or that the intention to hold the thing possessed as one's own may not be abandoned for a time. The control may be potential as well as actual. An estate may be possessed without the possessor going upon the land at all, and the possession of goods may be given by delivering the key of the warehouse in which they are stored. In international law the possession of part as giving a title to the whole has been of great importance (see INTERNATIONAL LAW). Where goods are pledged or bailed for a specific purpose the intention of the pledgor or bailor to hold them as his own is suspended during the existence of the limited right of the pledgee or bailee, to whom a fragment of the possession has passed. In Roman law the pledgor had *possessio ad usucapionem*, the pledgee *possessio ad interdicta*. The possession of the pledgee or bailee has been called "derivative possession." Possession may be exercised through another ("animo nostro, corpore alieno"), as through a servant, who has not true possession.³ Possession so exercised has been called "representative possession." As soon as the representative determines to assume control on his own behalf or to submit to the control of another, the possession of the principal is gone. Possession may be transferred or lost. It is lost when either the *corpus* or the *animus* (to use the terms of Roman law) ceases to exist. It may be lost by the representatives in cases where the principal might have lost it.

In both Roman and English law the possessory tended to supersede the proprietary remedies from their greater convenience—that is to say, the plaintiff based his claim or the defendant his right upon possession rather than property. The English possessory action may have been directly suggested by the interdict. Bracton (103b) identifies the assise of novel disseisin, the most common form of possessory action, with the interdict *unde vi*. In England ejectment had practically superseded other real actions before the latter were (with the exception of dower, writ of dower and *quare impedit*) expressly abolished by the Real Property Limitation Act 1833, s. 36. The action for the recovery of land, introduced by the Judicature Acts, is the modern representative of the action of ejectment.

² This does not agree with English law, where in certain cases a thief can give a good title to stolen goods, though he has no title himself.

³ Much of the law of master and servant is based upon the Roman law of master and slave. The servant, like the slave, has not possession of his master's goods even though they are in his custody, unless, indeed, the circumstances are such that he ceases to be a servant and becomes a bailee.

¹ The distinction is very important, as it affects the contract of sale. The contract was not to transfer ownership, as in English law, but only *vacua possessio*.

The right of a party to recover possession is enforced by a writ of possession.

Possession gives in English law, speaking generally, much the same rights as in Roman law. Thus it serves to found a title (see LIMITATION, STATUTES OF; PRESCRIPTION), and to throw the onus of proof upon the claimant. In an action for the recovery of land the defendant need only allege that he is in possession by himself or by his tenant, and (where such an allegation is necessary) that he had no notice to quit. The chief differences between Roman and English law, arising to some extent from the differences in the history of the two systems, are that the former did not give to derivative possessors (except in the case of pledge) the remedies of possessors, as does English law, and that Roman law is stricter than English in requiring that possession to found *usucapio* should (except in the case of *jus aquae ducendae*) be *ex justo titulo*, or under colour of right (see PRESCRIPTION). There is one case of constructive possession which is peculiar to English law—that is, where possession is said to be given by a deed operating under the Statute of Uses (see "Orme's Case," *L. R.* 8, C. P. p. 281).

In English law the doctrine of possession becomes practically important in the following cases. (1) Possession serves as a convenient means of division of estates (see REAL PROPERTY). One of the divisions of estates is into estates in possession and estates in reversion or remainder. It also serves as a division of personal property (*q.v.*). A close in action is said to be reduced into possession when the right of recovery by legal proceedings has become a right of enjoyment. (2) Possession gives a title against a wrongdoer. In the case of real property it is regarded as *prima facie* evidence of seisin.¹ In the case of personal property the mere possession of a finder is sufficient to enable him to maintain an action of trover against one who deprives him of the chattel² (see the leading case of *Armory v. Delamirie*, 1 Str. 504). (3) What is called "unity of possession" is one of the means whereby an easement is extinguished. Thus the owner of close A may have had a right of way over close B, while the latter belonged to a different owner. If the two closes come to be owned by the same person, the right of way is extinguished, but may under certain circumstances revive on the separation of the ownership. (4) Possession is very important as an element in determining the title to goods under 13 Eliz. c. 5, the Bills of Sale Act 1878 and the Bankruptcy Acts 1883 to 1890. It may be said that as a general rule retention of possession by the transferor or an absolute assignment or a colourable delivery of possession to the transferee is strong *prima facie* evidence of fraud. (5) Possession of goods or documents of title to goods is generally sufficient to enable agents and others to give a good title under the Factors' Acts (see FACTOR). (6) In criminal law the question of possession is important in founding the distinction between larceny and embezzlement. If the goods are in the possession of the master and he gives them to the custody of his servant for a specific purpose and the servant steals them, it is larceny; if they have never come into the master's possession, as if a clerk receives money on his master's behalf, it is embezzlement. Recent possession of stolen goods is always regarded as a presumption that the person in whose possession they are stole them or received them knowing them to have been stolen. In the case of a charge of receiving stolen goods evidence may be given that there was found in the possession of the accused other property stolen within the preceding period of twelve months, 34 & 35 Vict. c. 112, s. 19. (For possession in criminal law, see Stephen, *Digest of the Criminal Law*, note xi.) (7) Actions of possession of ships fall within the jurisdiction of the admiralty division. This jurisdiction in the case of British vessels depends upon the Admiralty Court Act 1861 (24 Vict. c. 10, s. 8), in the case of foreign vessels (in which the jurisdiction is rarely exercised) upon the general powers of the court as a maritime court.

The doctrines of adverse possession (in the old English sense, which was not identical with the Roman law, for the real owner must have actually or by fiction been disseised) and of *possessio fratris* are now of only antiquarian interest. The Statutes of Limitation have superseded the first. The only question now is, not whether possession has been adverse or not, but whether twelve years have elapsed since the right accrued. The maxim "*possessio fratris de feodo simplici sororem facit esse haeredem*" (Coke upon Littleton,

14b) has been altered by the rule of descent introduced by the Inheritance Act 1833, under which descent is traced from the purchaser. At one time possessory suits were occasionally maintained in England, and more frequently in Ireland, for the quieting of possession after proof of three years' possession before the filing of the bill. But such suits are now obsolete (see *Neill v. Duke of Devonshire*, 8 A. C. 146). There was one characteristic case in old English law in which possession was maintained by means of what was called "continual claim," made yearly in due form, where the person having the right was prevented by force or fear from exercising it (Coke upon Littleton, 253b). Continual claim was abolished by the Real Property Limitation Act 1833, s. 11.

Scotland.—In Scotland possessory actions still exist *eo nomine*. Actions of molestation, of removing, and of mails (payments) and duties are examples. A possessory judgment is one which entitles a person who has been in possession under a written title for seven years to continue his possession (*Watson, Law Dict., s.v. "Possessory Judgment"*).

United States.—Here the law in general agrees with that of England. Possessory rights are taxed in some of the states. Louisiana follows Roman law closely. Possession of incorporeal rights (to use the unscientific language of the Code) is called quasi-possession, and the division of possession into natural and civil is maintained (Civil Code, ss. 3389-3419).

In addition to the authorities cited may be mentioned Smith, *Dict. of Antiquities, s.v. "Possessio"*; Markby, *Elements of Law*; Holland, *Elements of Jurisprudence*; Holmes, *The Common Law* (lect. vi.); Pollock and Wright, *Possession in the Common Law*.

(J. W.)

POSSESSION, the term given to the supposed control of a human body and mind by an alien spirit, human or non-human; or the occupation by an alien spirit of some portion of a human body, causing sickness, pain, &c. The term *obsession* (Lat. for siege) is sometimes used as equivalent to possession; sometimes it denotes spirit control exercised from without, or it may mean no more than a maniacal monoideism. From an anthropological point of view possession may be conveniently classed as (a) inspirational, (b) demoniacal, (c) pathological, according to the view taken of the reason for or effect of the spiritual invasion of the possessed person.

a. In inspirational possession the oracle spirit is held to have entered the person in order to foretell the future or to proclaim the will of a god; the god himself may be regarded as speaking through the mouth of his devotee; among peoples in the lower stages of culture possession by spirits of the dead is inspirational, especially where there is any kind of ancestor worship in vogue. This kind of possession, so far as is known, does not appear among some of the lowest peoples, e.g. the Australians; but it is common in Africa, Polynesia and Asia, where European influence has not led to its decay. Many of the classical oracles were regarded as due to divine inspiration. The manifestations are often voluntarily induced and are provoked in many different ways; in classical times the eating of laurel leaves, the inhaling of fumes which ascended from a cleft in the rocks of Delphi, the drinking of intoxicating liquors, or of a more widely found means of inducing the phenomena—blood—were all in use. In the Malay Peninsula the medicine-man inhales incense which rises in clouds from a censer and hangs like a mist round his head; similar hypnotic effects are produced in Egypt in the case of divining boys by means of drugs. In Fiji the priest sat before a dish of scented oil and anointed himself with it, till in a few minutes he began to tremble and was finally strongly convulsed. In parts of India, draughts of blood from the neck of the newly decapitated victim were the means of rousing the priest to frenzy; while in Siberia, America and many parts of Africa drumming, contortions and orgiastic dancing are more commonly found. According to another account, the Fijian priest provoked the onset of the trance by a method in use in ordinary hypnotic practice; he sat amid dead silence before a whale's tooth, at which he gazed steadfastly.

The symptoms of supposed possession by a god differ as widely as do those of the hypnotic trance. In Hawaii the god Oro gave his oracles by inspiring the priest, who ceased to speak or act as a voluntary agent, his frenzied utterances being interpreted by the attendant priests. In the Malay Peninsula the *parawang*, after censuring himself, lies down on his back, with his head shrouded, and awaits the moment of inspiration. The tiger spirit which is the familiar of all Malay *parawangs* manifests its presence by a low lifelike growl and the *parawang* scratches at the mat, gives a series of catlike leaps and licks up from the floor the handfuls of rice scattered there. But his state seems to be far removed from the ecstasy of the Hawaiian priest, though it must be remembered that no test of bona fides is possible in either case. We meet with another stage in Tahiti in the lofty declamation of the possessed priests, who thus afford a parallel to the utterances of many modern mediums. Finally in Africa, where the frenzied form of possession is also common, we find at Sofala the manifestations of possession

¹ "Seisin" and "possession" are used sometimes as synonyms, as generally by Bracton; at other times they are distinguished: thus there can be possession of a term of years, but no seisin (Noy, *Maxims*, p. 2). It seems doubtful, however, how far in English law a tenant for years has true possession, for he is in law only a bailiff or servant of the landlord. But he certainly has possessory remedies, like the quasi-possessor in Roman law.

² Compare the *Code Napoléon*, art. 2279: "En fait de meubles la possession vaut titre."

were confined to the simple dramatic imitation of the voice of the dead king, whose soul was believed to give counsel in this manner to his successor.

b. Demoniacal possession is a widely spread explanation of such psychopathological conditions as epilepsy, somnambulism, hysteria, &c.; especially in the East Indian field lycanthropy (*q.v.*) and magical power (for evil) are commonly attributed to possession. Much of the evidence is that of native witnesses, and where European observers have succeeded in examining a case for themselves they have generally been guiltless of all knowledge of psychopathology and of the possibilities of suggestion; their statements are therefore to be accepted only with reserve. Demoniacal possession is familiar to us from the New Testament narratives; there seems to be no reason to suppose that the cases there recorded were due to anything but disease; but the view is still occasionally maintained by Christian apologists that real demon possession existed in Judaea. Demoniacs in the New Testament are stated to live among the tombs, to be deaf and dumb, or blind, to be possessed by a multitude of evil spirits or to suffer from high fever as a result of possession; the demons are said to pass into the bodies of animals or to reside in waterless places. No facts are recorded which are not explicable either as the ordinary symptoms of mental disease or as the result of suggestion (*q.v.*).

c. In the lower stages of culture all diseases are explained as due to the invasion of the body by disease spirits (see ANIMISM), but the effects are supposed to be physiological, not psychical as in demoniacal possession. The infringement of a totemic *tabu*, the wrath of an ancestor or other dead person or the malice of a disease spirit, such as the Malay *hantus*, or of any non-human spirit, may set up pathological conditions, according to animistic philosophy. Such cases, as well as those of demoniacal possession, which may be distinguished from the inspirational form by their invariably involuntary character, are dealt with by a variety of means such as spells, purifications, sacrifices to the possessing spirit, or coercion of various sorts (see EXORCISM).

We have few data as to the distribution of the phenomena here classified. Cases of inspirational or demoniacal possession were known in classical times; but the demon of Socrates must rather be classed as a case of sensory automatism. In our own day they are reported from the greater part of Asia, Africa and Polynesia, and they seem to occur in America, though our information is scanty. On the other hand in New Guinea and Australia they are practically unknown, though automatisms are put down to the agency of the dead.

From the psychological point of view the classification is again threefold: (a) as noted above, the majority of cases of so-called possession are simply psychopathological; (b) another class, the existence of which has only been recognized within recent times are the cases of secondary or multiple personality; the apparent independence and occasional conflict of primary and secondary selves has been explained by the theory of possession; but it has been possible in one of the most severe cases on record to unify the two personalities and memories after what the patient described as a struggle between them for supremacy, which would inevitably have suggested possession as the explanation, had not the issue of the case been the amalgamation of the two streams of consciousness. (c) The problem of the third class of cases, which may be termed mediumistic, is still unsolved. The medium (*q.v.*) or sensitive appears to have at command in the trance state a store of memories connected with the lives of deceased friends of a sitter (*i.e.* a person present at the séance), such memories being dealt with from the standpoint of the deceased person (who is termed the communicator); sometimes the memories are connected with the friends of a person not actually present or with articles placed in the hands of the medium, the owners being absent or dead. Mediumistic cases have undergone elaborate investigation at the hands of the Society for Psychical Research, and no serious attempt has been made to invalidate the facts set forward by the investigators; but so far no satisfactory explanation has been suggested. On the one hand thought transference or telepathy (*q.v.*) appears to be insufficient, unless we assume that the powers of a medium far transcend anything demonstrable in ordinary telepathic experiments; for the facts stated by or through the medium about the communicator seem in many cases to be known in their entirety to no single living person. If thought transference is the explanation, we must admit that the medium can (1) ransack all living brains for facts, (2) select those which are

pertinent (*i.e.* known to the communicator) and (3) combine them in such a way as to suggest that the source of the information is the dead person. On the other hand, although, as we have seen, the communications show knowledge homologous to that of the deceased, they demonstrably do not include the whole of his knowledge; more than one attempt has been made to obtain from communicators the contents of sealed letters, written during their lifetime and kept from the knowledge of all other human beings till the seal was broken; but such attempts have so far failed, and the failure seems to form conclusive evidence both against possession and against other explanations based on the supposition that the dead are communicating.

BIBLIOGRAPHY.—For anthropological data see Bastian, *Der Mensch; Contemporary Review*, xxvii. 369; Ellis, *Tshi-speaking Peoples*; Naevius, *Demon Possession*; Radloff, *Das Schamanentum*; Skeat, *Malay Magic*; Stoll, *Suggestion und Hypnotismus*; Tylor, *Primitive Culture*; Verdun, *Le Diable dans les missions*; Maury, *La Magie*, p. 258 seq.; Chamberlain, *Things Japanese*, s.v. "Fox." For discussion of New Testament facts see W. M. Alexander, *Demoniacal Possession in the New Testament*; Conybeare, in *Jewish Quarterly Review*, viii. 576, ix. 59, 444, 581; Herzog's *Realencyclopädie*, s.v. "Dämonische." For patristic literature see Bingham, *Antiquities*, iii. For mediumistic possession see Myers, *Human Personality*; and the same author on "Pseudopossession" in *Proc. S.P.R.* xv. 384; *Proc. S.P.R.* vi. 436-450, viii. 1-167, xiii. 284-582, xvi. 1-536, xvii. 61-244, &c. For medical and psychological observations see Griesinger, *Mental Pathology*; James, *Principles of Psychology*; Janet, *Névroses et idées fixes*; Kraft-Ebbing, *Psychiatrie*; Sidis and S. P. Goodhart, *Multiple Personality*. (N. W. T.)

PÖSSNECK, a town of Germany, in the duchy of Saxe-Meiningen, 21 m. by rail S. of Jena, on the Kotschau. Pop. (1905), 12,702. It has a Gothic Evangelical church built about 1390, and a Gothic town-hall erected during the succeeding century. Its chief industries are the making of flannel, porcelain, furniture, machines, musical instruments and chocolate. The town has also tanneries, breweries, dyeworks and brickworks. Pössneck, which is of Slavonic origin, passed about 1300 to the landgrave of Thuringia. Later it belonged to Saxony and later still to the duchy of Saxe-Coburg-Saalfeld, passing to Saxe-Meiningen in 1826.

See E. Koch, *Aus Pössnecks Vergangenheit* (Pössneck, 1894-1895); the same writer, *Beiträge zur urkundlichen Geschichte der Stadt Pössneck* (Pössneck, 1896-1900); and the *Geschichte der Stadt Pössneck*, published by the *Pössnecker Zeitung* (Pössneck, 1902).

POST. 1. (An adaptation in O. Eng. of the Lat. *postis*, from *ponere*, to place), a stock, stake or stump, particularly an upright timber used as a support in building, as part of the framework of a door, as a boundary mark, &c., and formerly as a convenient object to which to attach public notices, &c., whence the verb "to post," to publish a notice, advertisement, &c., by affixing it in a conspicuous position, hence to make a statement with regard to an event or person, *e.g.* the "posting" of a defaulter, or of a ship as overdue or missing at Lloyd's.

2. (An adaptation of the Fr. *poste*, station, position, Ital. *posta* or *posto*, formed from the past participle *positus*, of Lat. *ponere*, to place), position, station, a position occupied by a soldier or body of soldiers, especially one specifically allotted to a soldier, such as the round of a sentry, hence a place of employment, an office. The sense of station has developed into the particular application of the word and its various derivatives, "postal," "postage," &c., to the service connected with the delivery of letters (see POST AND POSTAL SERVICE). From the earliest times as we see from the *avyapeta* of the Persian kings (*Herod.* viii. 08), the speedy despatch of messages, letters, &c., was attained by relays of men and horses stationed at regular intervals. This is paralleled by the *dispositi equites* of Roman times and by the elaborate system of the Great Khan which Marco Polo describes on the roads of China. The *New English Dictionary* finds the earliest use of the O. Fr. *postes* and the Ital. *posta* for these stations of men and horses in Marco Polo's account. The Medieval Latin expression for the couriers was *caballarii postarum*, riders of the posts. From the stations or relays of horses the word was early applied to the riders themselves, and later to the mail carried by means of the "posts," and thence to the whole service. At the first establishment of

regular posts in the 16th century in England, they served two purposes, the carrying of the king's letters and the exclusive supply of horses for his couriers and for other travellers, the first being called the "posts of the packet," the second "the thorough posts." When, in 1780, the monopoly of supplying post-horses was taken away from the "postmasters," the term was retained for the "posting" establishments for travellers throughout the country, as well as in such words as "post-boy" and "post-chaise." The expression "post-haste," generally used adverbially in the sense of "with the utmost speed," was originally a superscription, "haste, post, haste," on letters that needed the greatest despatch, and was a command addressed to the "post," the bearer of the message. The peculiar use of "postmaster" as the name of the "scholars" of Merton College, Oxford, has not been explained. It occurs in the college records first as the name of a building (Postmasters' Hall) outside the college, in which the scholars (called *portionistae* or *portionistae*) lived until about 1575. The suggestion that "postmaster" is a corruption of *portionista* is far-fetched, and there is nothing to support the theory that the scholars, as servitors to the masters, stood behind them at table and were thus called *post-magistri*.

POST, and POSTAL SERVICE. The germ of modern postal systems is to be looked for in the earliest organized establishment of a staff of government couriers. In the postal system of Spain and the German empire there is express record of permission to government couriers to carry letters for individuals in April 1544; and within fifteen or sixteen years that permission had grown into a legalized and regulated monopoly, whence the counts of Taxis drew part of their profits as postmasters-general. In Great Britain existing private letters of the 15th century—some, perhaps, of the 14th—bear endorsements which show that they were conveyed by relays of men and horses maintained under the control of the government, and primarily intended for its special service. In several states on the continent of Europe the universities had inland postal establishments of a rudimentary sort at an early date. The university of Paris organized a postal service almost at the beginning of the 13th century, and it lasted in a measure until 1719. In various parts of Europe mercantile guilds and brotherhoods were licensed to establish posts for commercial purposes. But everywhere—as far as the accessible evidence extends—foreign posts were under state control.

GREAT BRITAIN

Early History (c. 1533-1836).

As early as the middle of the 13th century entries occur in the wardrobe accounts of the kings of England of payments to royal messengers for the conveyance of letters. In the supervision of these royal messengers lies the germ of the office of postmaster-general. The first English postmaster of whom a distinct account can be given is Sir Brian Tuke, who is described (1533) in the records as "Magister Nunciorum, Cursorum, sive Postarum," "both in England and in other parts of the king's dominions beyond the seas." But long subsequent to this appointment of a postmaster-general the details of the service were frequently regulated by proclamations and by orders in council. Thus, among the royal proclamations in the library of the Society of Antiquaries, there is one of Philip and Mary (undated, but apparently of 1555) which regulates the supply of horses for the conveyance of letters to Dover. Again, in July 1556 the lords of the council ordered "that the postes betwene this and the North should eche of them keepe a booke, and make entrie of every lettre that he shall receive, the tyme of the deliverie thereof unto his hands, with the parties names that shall bring it unto him." Much of the business of the foreign postal service to and from England during the earlier years of Queen Elizabeth was managed by the incorporated "merchant strangers," who appointed a special postmaster. When that office fell vacant in 1568 they quarrelled about a successor; and the quarrel cost them their privilege.¹

¹ F. Windebank to Sir W. Cecil: "All the Italians were unwilling

The accession of James I. to the English throne, by necessitating a more frequent communication between London and Scotland, led to improvements in the postal service. Special posts had already been established by the magistrates of certain Scottish towns to convey their despatches to and from the court. Thus in 1590 a messenger was appointed by the magistrates of Aberdeen with the title of "council-post."² The new royal orders of 1603 directed (1) that the postmasters at the various stages should enjoy the privilege of letting horses to "those riding in post (that is to say) with horn and guide," by commission or otherwise, and to that end they were charged to keep or have in readiness a sufficient number of post-horses; (2) that the lawful charge for the hire of each horse should be, for public messengers, at the rate of 2½d. a mile, "besides the guides' groats," private travellers being left to make their own agreements. Finally, it was directed that every postmaster should keep at least two horses for the express conveyance of government letters, and should forward such letters within a quarter of an hour of their receipt, and that the posts should travel at the rate of not less than 7 m. an hour in summer and 5 m. in winter.³

In 1607 the king granted to John Stanhope, first Baron Stanhope of Harrington, and to his son Charles Stanhope, afterwards second Lord Stanhope, jointly and to the survivor of them, the postmastership of England under the title of "Master of the Posts and Messengers," with a fee of 100 marks a year, together with all "avails and profits" belonging to the office. In 1619 a separate office of "postmaster-general of England for foreign parts" was created in favour of Matthew de Quester⁴ and Matthew de Quester the younger. The new office was regarded by the existing postmaster-general, Charles, Lord Stanhope, as an infringement of his own patent. A long dispute ensued in the king's bench and before the lords of the council.⁵ In 1626 by an order in council liberty was granted to all companies of merchants, including the merchant adventurers, to send their letters and despatches by messengers of their own choosing. A year afterwards this liberty was revoked, except for the Company of Merchant Adventurers. Lord Stanhope, however, continued to carry letters abroad by his agents, and obtained a warrant prohibiting De Quester from interfering. It shows strikingly the confusion of postal affairs at this period to find a statement addressed to the privy council by the postmasters of England to the effect that they had received no payments "ever since the last day of November 1621 till this present time, June 1628"—the arrears amounting to £22,626.

The rights of the postmasters were also infringed by private individuals, as by one Samuel Jude in 1629 in the west of England.⁶ In 1632 the foreign postmastership was assigned by De Quester, who had lost his son, to William Frizell and Thomas Witherings. Letters-patent were granted to them to give their voices to Raphael, . . . but inclined to favour Godfrey" (*Dom. Cor. Eliz.* xlviii. § 65, State Paper Dept., Rolls Office). Raphael was a German, Godfrey an Englishman.

² Kennedy, *Annals of Aberdeen*, i. 262.

³ *Book of Proclamations*, p. 67 (S. P. O.; now in Rolls House); *Report from the Secret Committee on the Post Office*, (1844) appendix, pp. 38-40.

⁴ Or "De l'Equester," as he is called in Latch's *Reports of King's Bench Cases*, p. 87.

⁵ These disputes were much embittered by the growing jealousies of English against foreign merchants. The proofs of this in the state correspondence of Elizabeth's day are abundant, but there were many statesmen who took larger views. See, e.g. John Johnson's "Brief Declaration for the . . . erecting and maintaining of the Staple . . . in England" (June 1582), *Dom. Corresp. Eliz.* cliv. No. 30; and compare the same writer's "Discourse for the repairing the decayed State of the Merchants," &c. (July 22, 1577), *ibid.* cxiv. No. 39, with Leake's "Discourse," &c., of the same year (*ibid.* cxi. 1 seq.), and with John Hales's "Letter to Sir W. Cecil" (March 20, 1559), *ibid.* iii., where he describes the merchant strangers as being "spies for foreign princes," and with Cecil's "Reasons to move a Forbearing of the Restitution of the Intercourse to Antwerp" (1564), *ibid.* xxxv. No. 33 (in Rolls House).

⁶ See *Analytical Index to the Remembrancia*, p. 418, as quoted by H. B. Wheatley in the *Academy* of the 27th of December 1879, p. 464.

Under
James I.

The De
Questers.

jointly, the 15th of March 1633.¹ Witherings took the labouring oar, and ranks as the first of many conspicuous postal reformers.

Witherings. Under him one Richard Poole obtained a special postmastership for the service of the court. Among the earliest measures of improvement taken under the new patent was an acceleration of the continental mail service. For this purpose the patentees made a contract with the count of Thurn and Taxis, hereditary postmaster of the Empire and of Spain. At this time there was still but one mail weekly between London, Antwerp and Brussels, and the transit occupied from four to five days. By a subsequent contract with Count Thurn two mails weekly were secured and the transit made ordinarily in two days.² In June 1635 Witherings submitted to the king a proposal "for settling of staffets or pacquet-posts betwixt London and all parts of His Majesty's dominions, for the carrying and re-carrying of his subjects' letters," which contains curious notices of the state of internal communications. The net charge to the Crown of the existing posts is stated to be £3400 per annum. Letters, it is said, "being now carried by carriers or footposts 16 or 18 m. a day, it is full two months before any answer can be received from Scotland or Ireland to London. If any of His Majesty's subjects shall write to Madrid in Spain, he shall receive answer sooner and surer than he shall out of Scotland or Ireland." By the new plan it was proposed that all letters for the northern road should be put into one "portmantle," and directed to Edinburgh, with separate bags directed to such postmasters as lived upon the road near to any city or town corporate. The journey from London to Edinburgh was to be performed within three days. The scheme was approved on the 31st of July 1635, the proclamation establishing eight main postal lines—namely, the great northern road, to Ireland by Holyhead, to Ireland by Bristol, to the marches of Wales by Shrewsbury, to Plymouth, to Dover, to Harwich and to Yarmouth. The postage of a single letter was fixed at 2d. if under 80 m., 4d. if between 80 and 140 m., 6d. if above 140 m., 8d. if to Scotland. It was provided that no other messengers or footposts should carry letters to any places so provided, except common known carriers, or a particular messenger "sent on purpose with a letter by any man for his own occasions," or a letter by a friend, on pain of exemplary punishment.³ In February 1638 another royal proclamation ratified an agreement between Witherings and De Noveau, postmaster to the French king, for the conveyance of the mails into France by Calais, Boulogne, Abbeville and Amiens.⁴

But in 1640 the active postmaster was accused of divers abuses and misdemeanours, and his office sequestered into the hands of Philip Burlamachi of London, merchant, who was to execute the same under the inspection of the principal secretary of state.⁵ Witherings then assigned his patent to Robert Rich, earl of Warwick, and a long contest ensued in both houses of parliament. The sequestration was declared by a vote in parliament in 1642 to be illegal. Nevertheless the dispute gave repeated occupation to both houses during the period from 1641 to 1647, and was diversified by several affrays, in which violent hands were laid upon the mails. In 1643 the post office yielded only £5000 a year. In 1644 the Lords and Commons by a joint ordinance appointed Edmund Prideaux "to be master of the posts, messengers and couriers." In 1646 the opinion of the judges was taken on the validity of Witherings's patent (assigned to Lord Warwick), and they pronounced that "the clauses of restraint in the said patent are void and not good in law; that, notwithstanding these clauses be void, the patent is good for the rest."⁶ It is evident, therefore, that any

¹ Minute in "House of Lords' Papers" (1633), *Fourth Report of Hist. MSS. Commission* (1874), app. The papers there calendared contain many proofs of Witherings's activity and ability. See also appendix to *Fifth Report* (1875), and "A proclamation concerning the Postmaster of England for Forraigne Parts" (July 19, 1632), in Rymer's *Foedera*, xix. 385.

² *Egerton MS.* (Brit. Mus.), No. 2543, fol. 5 seq.

³ Rymer, *Foedera*, xix. 649. ⁴ *Ibid.* xx. 192. ⁵ *Ibid.* xx. 429.

⁶ *Journals of the House of Commons*, ii. 81, 82, 95, 470, 493, 500,

prohibition to carry letters must be by act of parliament to have force of law.

In 1650 an attempt was made by the common council of London to organize a new postal system on the great roads, to run twice a week. This scheme they temporarily carried into effect as respects Scotland. But Mr **Under Cromwell.** Attorney-General Prideaux urged on the council of state that, if the new enterprise were permitted, besides intrenching on the rights of the parliament, some other means would have to be devised for payment of the postmasters. Both houses resolved (1) that the offices of postmasters, inland and foreign, were, and ought to be, in the sole power and disposal of the parliament, and (2) that it should be referred to the council of state to take into consideration all existing claims in relation thereto. Of these there were five under the various patents which had been granted. Thereupon the Protector was advised that the management of the post office should be entrusted to John Thurloe by patent upon the expiration of John Manley's existing contract. Thurloe was to give security for payment of the existing rent of £10,000 a year. Ultimately the posts, both inland and foreign, were farmed to John Manley for £10,000 a year, by an agreement made in 1653. Meanwhile an attorney at York, named John Hill, placed relays of post-horses between that city and London, and undertook **John Hill's Reforms.** the conveyance of letters and parcels at half the former rates. He also formed local and limited partnerships in various parts of the kingdom for the extension of his plan, which aimed to establish eventually a general penny postage for England, a twopenny postage for Scotland and a fourpenny postage for Ireland. But the post office was looked upon by the government of the day as, first, a means of revenue, and secondly, a means of political espionage.⁷ The new letter-carriers were "trampled down" by Cromwell's soldiery. The inventor had a narrow escape from severe punishment. He lived to publish (1659) the details of his plan, at the eve of the Restoration, in a pamphlet entitled *A Penny Post: or a Vindication of the Liberty and Birthright of every Englishman in carrying Merchants and other Man's letters, against any Restraint of Farmers, &c.* It is probable that this publication⁸ helped to prepare the way for those measures of partial but far-reaching reform which were effected during the reign of Charles II. The rates of postage and the rights and duties of postmasters were settled under the Protectorate by an act of parliament of 1657, c. 30. In 1659 the item, "by postage of letters in farm, £14,000," appears in a report on the public revenue.⁹

The government of the Restoration continued to farm the post office upon conditions similar to those imposed by the act of 1657, but for a larger sum. Henry Bishop, the **Under Charles II.** first postmaster-general in the reign of Charles II., contracted to pay a yearly rent of £21,500, these new arrangements being embodied in the Act 12 Charles II. c. 35 (1660), entitled "An Act for Erecting and Establishing a Post Office." A clause proposing to frank all letters addressed to or sent by members of parliament during the session was

501, 658 seq.; *Journals of the House of Lords*, v. 343, 387, 450, 469-473, 500 seq.; *Report from Secret Committee on the Post Office*, Appendix, pp. 60-69.

⁷ Illustrations of this may be seen (in the state-paper department of the general record office) among the correspondence between Sir John Coke and Lord Conway, and also in many other state letters, as well after the outbreak of the great rebellion as before it. There is in the Bodleian Library (MS. Rawlinson, A. 477) a minute account of the methods alleged to have been pursued in the systematic and periodical examination of letters entrusted to the post office. The paper is not authenticated by any signature, and is undated. But it is an original document of the time of Charles II., addressed to Mr. Bridgman, clerk of the council, and drawn up to recommend the adoption of a like practice, but with greater dexterity than that used by Dr. Dorislaus and Samuel Morland, who, according to this narrative, formed the Cromwellian board of examiners for post-office letters, and who read all that were addressed to foreign parts.

⁸ There is a copy in the library of the British Museum, from which H. B. Wheatley has given the abstract quoted above.

⁹ *Journals of the House of Commons*, vii. 627.

rejected by the Lords. But the indenture enrolled with the letters-patent contained a proviso for the free carriage of all letters to or from the king, the great officers of state and also the single inland letters only of the members of that present parliament during that session. It also provided that the lessee should permit the secretaries of state, or either of them, to have the survey and inspection of all letters at their discretion. Bishop was succeeded by Daniel O'Neill¹ in 1662, on similar terms. In the consequent proclamation, issued on the 25th of May 1663, it was commanded that "no postmasters or other officers that shall be employed in the conveying of letters, or distributing of the same, or any other person or persons, . . . except by the immediate warrant of our principal secretaries of state, shall presume to open any letters or packets not directed unto themselves." In 1677 the general post office comprised in the chief office, under Henry Bennet, earl of Arlington, as postmaster-general, seventy-five persons, and its profits were farmed for £43,000 a year. There were then throughout England and Scotland 182 deputy postmasters, and in Ireland 18 officers at the Dublin office and 45 country postmasters. "The number of letters missive," says a writer of the same year, "is now prodigiously great. . . . A letter comprising one whole sheet of paper is conveyed 80 m. for twopence. Every twenty-four hours the post goes 120 m., and in five days an answer may be had from a place 300 m. distant."² By an act of the 15th Charles II. ("An Act for Settling the Profits of the Post Office on the duke of York, and his Heirs-Male"), and by a subsequent proclamation issued in August 1683, it was directed that the postmaster-general should "take effectual care for the conveyance of all bye-letters, by establishing correspondences . . . in all considerable market-towns with the next adjacent post-stage," and the rights of the postmasters as to hiring horses were again emphasized.

During the possession of the post-office profits by the duke of York a London penny post was established by the joint enterprise of William Dockwra, a searcher at the customs-house, and of Robert Murray, a clerk in the excise office. The working-out of the plan fell to the first-named, and in his hands it gave in April 1680—although but for a short time—far more extensive postal facilities to the Londoners than even those afforded 160 years later by the plans of Sir Rowland Hill. Dockwra carried, registered and insured, for a penny, both letters and parcels up to a pound in weight and £10 in value. He took what had been the mansion of Sir Robert Abdy in Lime Street as a chief office, established seven sorting and district offices, and between 400 and 500 receiving-houses and wall-boxes. He established hourly collections, with a maximum of ten deliveries daily for the central part of the city, and a minimum of six for the suburbs. Outlying villages, such as Hackney and Islington, had four daily deliveries; and his letter-carriers collected for each despatch of the general post office throughout the whole of the city and suburbs. Suits were laid against him in the court of king's bench for infringing on the duke of York's patent, and the jealousies of the farmers eventually prevailed. The penny post was made a branch of the general post. Dockwra, after the Revolution of 1688, obtained a pension of £500 a year (for a limited term) in compensation of his losses. In 1697 he was made comptroller of the London office. Eleven years later his improvements were outvied by Charles Povey, the author of schemes for improving coinage, and also of a curious volume, often wrongly ascribed to Defoe, entitled *The Visions of Sir Heister Ryley*. Povey took upon himself to set up a foot-post under the name of the "halfpenny carriage," appointed receiving-houses, and employed several persons to collect and deliver letters for hire within the cities of London and Westminster and borough of Southwark, "to the great prejudice of

¹ The trusted friend but not always the trusted adviser of the duke of Ormonde. O'Neill's correspondence exists among the duke's papers, in part at Kilkenny Castle, in part (extensively) among the Carte MSS. in the Bodleian; and it abounds in incidental illustrations of postal administration in both England and Ireland.

² Quoted in *Gent. Mag.* (1815), xxxv. 309, 310.

the revenue," as was represented by the postmaster-general to the lords of the treasury. Povey was compelled to desist.

At this period the postal system of Scotland was distinct from that of England. It had been reorganized early in the reign of Charles II., who in September 1662 had appointed Patrick Grahame of Inchbrakie to be postmaster-general of Scotland for life at a salary of £500 Scots. But it would seem from the proceedings of the Scottish privy council that the rights and duties of the office were ill defined; for immediately after the appointment of Grahame the council commissioned Robert Mein, merchant and keeper of the letter-office in Edinburgh, to establish posts between Scotland and Ireland, ordained that Linlithgow, Kilsyth, Glasgow, Kilmarnock, Dumboag, Ballantrae and Portpatrick should be stages on the route, and granted him the sum of £200 sterling to build a packet-boat to carry the mail from Portpatrick to Donaghadee.³

Perhaps the earliest official notice of the colonial post is to be seen in the following paragraph from the records of the general court of Massachusetts in 1639. "It is ordered that notice be given that Richard Fairbanks his house in Boston is the place appointed for all letters which are brought from beyond the seas, or are to be sent thither to be left with him; and he is to take care that they are to be delivered or sent according to the directions; and he is allowed for every letter a penny, and must answer all miscarriages through his own neglect in this kind." The court in 1667 was petitioned to make better postal arrangements, the petitioners alleging the frequent "loss of letters whereby merchants, especially with their friends and employers in foreign parts, are greatly damaged; many times the letters are imputed (?) and thrown upon the exchange, so that those who will may take them up, no person, without some satisfaction, being willing to trouble their houses therewith." In Virginia the postal system was yet more primitive. The colonial law of 1657 required every planter to provide a messenger to convey the despatches as they arrived to the next plantation, and so on, on pain of forfeiting a hoghead of tobacco in default. The government of New York in 1672 established "a post to goe monthly from New York to Boston," advertising "those that bee disposed to send letters, to bring them to the secretary's office, where, in a lockt box, they shall be preserved till the messenger calls for them, all persons paying the post before the bagg be sealed up."⁴ Thirty years later this monthly post had become a fortnightly one. The office of postmaster-general for America had been created in 1692.

The act of the 9th of Queen Anne which consolidated the posts of the empire into one establishment, and, as to organization, continued to be the great charter of the post office until the reforms of 1838-1850 mainly introduced by Sir Rowland Hill. The act of Anne largely increased the powers of the postmaster-general. It reorganized the chief letter-offices of Edinburgh, Dublin and New York, and settled new offices in the West Indies and elsewhere. It established three rates of single postage, viz. English, 3d. if under 80 m. and 4d. if above, and 6d. to Edinburgh or Dublin. It continued to the postmaster-general the sole privilege "to provide horses to persons riding post." And it gave, for the first time, parliamentary sanction to the power, formerly questionable, of the secretaries of state with respect to the opening of letters, by enacting that "from and after the first day of June 1711 no person or persons shall presume . . . to open, detain or delay . . . any letter or letters . . . after the same is or shall be delivered into the general or other post office, . . . and before delivery to the persons to whom they are directed, or for their use, except by an express warrant in writing under the hand of one of the principal secretaries of state, for every such opening, detaining or delaying."

Nine years after the passing of the act of Anne the cross-posts were farmed to the well-known "humble" Ralph Allen—the lover of peace and of humanity.⁵ Allen became the inventor of the cross-roads postal system, having made an agreement that the new profits so created should be his own during his lifetime. His improvements were so successful that he is said to have netted during forty-two years an average profit of nearly £12,000 a year.

³ Lang, *Historical Summary of the Post Office in Scotland*, pp. 4, 5. Miles, "History of the Post Office," in the *American Banker's Magazine*, new series, vol. vii. p. 358 seq.

⁴ "Is there a variance? enter but this door, Barked are the courts; the contest is no more." Pope's "humble Allen" was also the "Allworthy" of Fielding.

Early
Scottish
Postal
System.

Early
Colonial
Posts.

Act of Con-
solidation.

Cross-road
Posts.

The postal revenue of Great Britain, meanwhile, stood thus:—

Gross and Net Income, 1724-1774.

Year	Gross Produce.			Net Revenue.		
	£	s.	d.	£	s.	d.
1724	178,071	16	9	96,339	7	5
1734	176,334	3	1	91,701	11	0
1744	194,461	8	7	85,114	9	4
1754	214,300	10	6	97,365	5	1
1764	225,326	5	8	116,182	8	5
1774	313,032	14	6	164,077	8	4

The system of burdening the post-office revenue with pensions, nearly all of which had no public connexion with the postal service, and some of which were unconnected with any public service, was begun by Charles II., who granted to Barbara, duchess of Cleveland, £4700 a year, and to the earl of Rochester £4000 a year, out of that revenue. The example was followed until, in 1694, the pensions so chargeable amounted to £21,200. Queen Anne granted a pension of £5000 to the duke of Marlborough, charged in like manner. In March 1857 the existing pensions ceased to be payable by the post office, and became chargeable to the consolidated fund.

In October 1782 the notice of the manager of the Bath theatre, John Palmer (1742-1818), was attracted to the postal service.

So habitual were the robberies of the post that they came to be regarded as necessary evils. The officials urged the precaution of sending all bank-notes and bills of exchange in halves, and pointed the warning with a philosophical remark that "there are no other means of preventing robberies with effect." At this period the postal system was characterized by extreme irregularity in the departure of mails and delivery of letters by an average speed of about 3½ m. in the hour, and by a rapidly increasing diversion of correspondence into illicit channels. The net revenue, which had averaged £167,176 during the ten years ending with 1773, averaged but £159,625 during the ten years ending with 1783. Yet, when Palmer suggested that by building mail-coaches expressly adapted to run at a good speed, by furnishing a liberal supply of horses, and by attaching an armed guard to each coach the public would be greatly benefited, and the post-office revenue considerably increased, the officials maintained that the existing system was all but perfect. Lord Camden, however, brought the plan under the personal notice of Pitt, who insisted on its being tried. The experiment was made in August 1784, and its success exceeded all anticipation. The following table shows the rapid increase of revenue under the new arrangements:—

Gross and Net Income, 1784-1805.

Year.	Gross Income.			Net Revenue.		
	£	s.	d.	£	s.	d.
1784	420,101	1	8	196,513	16	7
1785	463,753	8	4	261,409	18	2
1790	533,198	1	9	331,179	18	8
1795	745,238	0	0	414,548	11	7
1800	1,083,950	0	0	720,981	17	1
1805	1,317,842	0	0	944,382	8	4

It had been at first proposed to reward Palmer by a grant for life of 2½% on a certain proportion of the increased net revenue, which would eventually have given him some £10,000 a year, but this proposition fell through. Pitt, however, appointed Palmer to be comptroller-general of postal revenues, an office which was soon made too hot for him to hold. He obtained a pension of £3000 a year, and ultimately, by the act 53 Geo. III. c. 157 (1813), after his case had received the sanction of five successive majorities against government, an additional sum of £50,000. Every sort of obstruction was placed in the way of his reward, although nearly a million had been added to the annual public revenue, and during a quarter of a century the mails had been conveyed over an aggregate of some seventy millions of miles without the occurrence of one serious mail robbery.¹

¹ Debates of both Houses of Parliament in 1808 relative to the Agreement for the Reform and Improvement of the Post Office, passim. See also H. Joyce, *The History of the Post Office* (1893).

Scotland shared in the advantages of the mail-coach system from the first. Shortly before its introduction the local penny post was set on foot in Edinburgh by Peter Williamson, the keeper of a coffee-room in the hall of Parliament House. He employed four letter-carriers, in uniform, appointed receivers in various parts of the city, and established hourly deliveries.² The officials of the post, when the success of the plan had become fully apparent, gave Williamson a pension, and absorbed his business, the acquisition of which was subsequently confirmed by the Act 34 Geo. III. c. 17 (1794). A dead-letter office was established in 1784. But in Ireland in 1801 only three public carriages conveyed mails. There were, indeed, few roads of any sort, and none on which coaches could travel faster than four miles an hour.³ At this period the gross receipts of the Irish post office were £80,040; the charges of management and collection were £59,216, or at the rate of more than 70%; whilst in Scotland the receipts were £100,651, and the charges £16,896, or somewhat less than 17%.⁴

In the American colonies postal improvements may be dated from the administration of Franklin, who was virtually the last colonial postmaster-general, as well as the best. In one shape or another he had forty years' experience of postal work, having been appointed postmaster at Philadelphia in October 1737. When he became postmaster-general in 1753 he visited all the chief post offices throughout Pennsylvania, New Jersey, New York and New England, looking at everything with his own eyes. His administration cannot be better summed up than we find it to be in a sentence or two which he wrote soon after his dismissal. Up to the date of his appointment, he says, "the American post office had never paid anything to that of Britain. We [i.e. himself and his assistant] were to have £600 a year between us, if we could make that sum out of the profits of the office. . . . In the first four years the office became above £900 in debt to us. But it soon after began to repay us; and before I was displaced by a freak of the minister's, we had brought it to yield three times as much clear revenue to the Crown as the post office of Ireland. Since that imprudent transaction they have received from it—not one farthing."

The interval between the development of Palmer's methods, and the reforms introduced twenty-seven years later by Sir Rowland Hill, is chiefly marked by the growth of the packet system, under the influence of steam navigation, and by the elaborate investigations of the revenue commissioners of 1826 and the following years. In some important particulars these mark out practical and most valuable reforms, but they contrasted unfavourably with the lucidity and reasoning of Rowland Hill's *Post Office Reform*.

As early as 1788 the cost of the packets employed by the post office attracted parliamentary attention. In that year the "commissioners of fees and gratuities" reported that in the preceding seventeen years the total cost of this branch had amounted to £1,038,133; and they naturally laid stress on the circumstance that many officers of the post office were owners of such packets, even down to the chamber-keeper. At this time part of the packet service was performed by hired vessels, and part by vessels which were the property of the Crown. The commissioners recommended that the latter should be sold, and the entire service be provided for by public and competitive tender. The subject was again inquired into by the finance committee of 1798, which reported that the recommendation of 1788 had not been fully acted upon, and expressed its concurrence in that recommendation. The plan was then to a considerable extent enforced. But the war rapidly increased the expenditure. The average (£61,000) of 1771-1787 had increased in 1797 to £78,439, in 1810 to £105,000, in 1814 to £160,603. In the succeeding years of peace the expense fell to an average of about £85,000. As early as 1818 the "Rob Roy" plied regularly between Greenock and Belfast; but no use was made of steam navigation for the postal service until 1821, when the postmaster-general established Crown packets. The expenditure under the new system, from that date to 1829 inclusive, was thus reported by the commissioners of revenue inquiry in 1830:—

Cost of Packet Service, 1820-1829.⁵

Year.	£	Year.	£
1820 ⁶	85,000	1825	110,838
1821 ⁷	134,868	1826	144,592
1822	115,429	1827	159,250
1823	93,725	1828	117,260
1824	116,602	1829	108,305

The general administration of postal affairs at this period was still characterized by repeated advances in the letter rates, and the

² Lang, *Historical Summary of the Post Office in Scotland*, 15.

³ Minutes of Evidence before Select Committee on Taxation of Internal Communication (1837), evidence of Sir Edward Lees, p. 397.

⁴ Report, &c., of Select Committee on Postage.

⁵ Twenty-second Report of the Commissioners of Revenue Inquiry, pp. 4-6.

⁶ Last year of exclusive sailing packets.

⁷ First year of steam-packets.

twenty years previous to Rowland Hill's reforms by a stationary revenue. The following table will show the gross receipts, the charges of collection and management, and the net revenue (omitting fractions of a pound) of the post office of Great Britain. We give the figures for the year 1808 for the purpose of comparison.

Year.	Gross Income.	Charges of Collection, &c.	Charges per cent. of Gross Income.	Net Revenue.	Population of United Kingdom.
1808	£ 1,552,037	£ 451,431	29	£ 1,100,606	—
1815-16	2,193,741	594,045	27	1,599,696	19,552,000
1818-19	2,209,212	719,622	32½	1,489,590	—
1820-21	2,132,235	636,290	29	1,495,945	20,928,000
1824-25	2,255,239	655,914	29	1,599,325	22,362,000
1826-27	2,392,272	747,018	31	1,645,254	—
1836-37	2,206,736	609,220	27½	1,597,516	25,605,000
1838-39	2,346,278	686,768	29	1,659,510	—

Before passing to the reform of 1839 we have to revert to that important feature in postal history—the interference with correspondence for judicial or political purposes. We have already seen (1) that this assumption had no parliamentary sanction until the enactment of the 9th of Queen Anne; (2) that the enactment differed from the royal proclamations in directing a special warrant for each opening or detention of correspondence. It is a significant gloss on the statute to find that for nearly a century (namely, until 1798 inclusive) it was not the practice to record such warrants regularly in any official book.¹ Of the use to which the power was applied the state trials afford some remarkable instances. At the trial of Bishop Atterbury, for example, in 1723 certain letters were offered in evidence which a clerk of the post office deposed on oath "to be true copies of the originals, which were stopped at the post office and copied, and sent forward as directed." Hereupon Atterbury asked this witness "if he had any express warrant under the hand of one of the principal secretaries of state for opening the said letters." But the lords shelved his objection on the grounds of public expediency. Twenty-nine peers recorded their protest against this decision.² But the practice thus sanctioned appears to have been pushed to such lengths as to elicit in April 1735 a strong protest and censure from the House of Commons. A committee of inquiry was appointed, and after receiving its report the house resolved that it was "an high infringement of the privileges of the . . . Commons of Great Britain in Parliament that letters of any member should be opened or delayed without a warrant of a principal secretary of state."

Sir Rowland Hill's Reforms (1836-1842).

Rowland Hill's pamphlet (*Post Office Reform*) of 1837 took for its starting-point the fact that, whereas the postal revenue showed for the past twenty years a positive though slight diminution, it ought to have showed an increase of £507,700 a year in order to have simply kept pace with the growth of population, and an increase of nearly four times that amount in order to have kept pace with the growth of the analogous though far less exorbitant duties imposed on stage-coaches. The stage-coach duties had produced, in 1815, £217,671; in 1835 they produced £498,497. In 1837 there did not exist any precise account of the number of letters transmitted through the general post office. Hill, however, was able to prepare a sufficiently approximate estimate from the data of the London district post, and from the sums collected for postage. He thus calculated the number of chargeable letters at about 88,600,000, that of franked letters at 7,400,000, and that of newspapers at 30,000,000, giving a gross total of about 126,000,000. At this period the total cost of management and distribution was £696,569. In the finance accounts of the year (1837) deductions are made from the gross revenue for letters "refused, missent, redirected," and the like, which amount to about £122,000. An analysis of the component parts of this expenditure assigned £426,517 to cost of primary distribution and £270,052 to cost of secondary distribution and miscellaneous charges. A further analysis of the primary distribution expenditure gave £282,308 as the probable outgoings for receipt and delivery, and £144,209 as the probable outgoings for transit. In other words, the expenditure which hinged upon the *distance* the letters had to be conveyed was

£144,000, and that which had nothing to do with distance was £282,000. Applying to these figures the estimated number of letters and newspapers (126,000,000) passing through the office, there resulted a probable average cost of $\frac{8}{10}$ of a penny for each, of which $\frac{2}{10}$ was cost of transit and $\frac{5}{10}$ cost of receipt, delivery, &c. Taking into account, however, the greater weight of newspapers and franked letters as compared with chargeable letters, the apparent average cost of *transit* became, by this estimate, but about $\frac{9}{10}$, or less than $\frac{1}{10}$ of a penny.

A detailed estimate of the cost of conveying a letter from London to Edinburgh, founded upon the average weight of the Edinburgh mail, gave a still lower proportion, since it reduced the apparent cost of transit, on the average, to the thirty-sixth part of one penny. Hill inferred that, if the charge for postage were to be made proportionate to the whole expense incurred in the receipt, transit and delivery of the letter, and in the collection of its postage, it must be made *uniformly* the same from every post-town to every other post-town in the United Kingdom, unless it could be shown how we are to collect so small a sum as the thirty-sixth part of a penny. And, inasmuch as it would take a ninefold weight to make the expense of transit amount to one farthing, he further inferred that, taxation apart, the charge ought to be precisely the same for every packet of moderate weight, without reference to the number of its enclosures.

At this period the rate of postage actually imposed (beyond the limits of the London district office) varied from 4d. to 1s. 8d. for a single letter, which was interpreted to mean a single piece of paper not exceeding an ounce in weight; a second piece of paper or any other enclosure, however small, constituted the packet a double letter. A single sheet of paper, if it at all exceeded an ounce in weight, was charged with fourfold postage. The average charge on inland general post letters was nearly 9d. for each. It was proposed that the charge for primary distribution—that is to say, the postage on all letters received in a post-town, and delivered in the same or in any other post-town in the British Isles—should be at the uniform rate of one penny for each half-ounce—all letters and other papers, whether single or multiple, forming one packet, and not weighing more than half an ounce, being charged one penny, and heavier packets, to any convenient limit, being charged an additional penny for each additional half-ounce. It was further proposed that stamped covers should be sold to the public at such a price as to include the postage, which would thus be collected in advance.³ By the public generally, and pre-eminently by the trading public, the plan was received with favour. By the functionaries of the post office it was denounced as ruinous and visionary. In 1838 petitions poured into the House of Commons. A select committee was appointed, which reported as follows:—

"The principal points which appear to your committee to have been established in evidence are the following: (1) the exceedingly slow advance and occasionally retrograde movement of the post office revenue during the . . . last twenty years; (2) the fact of the charge of postage exceeding the cost in a manifold proportion; (3) the fact of postage being evaded most extensively by all classes of society, and of correspondence being suppressed, more especially among the middle and working classes of the people, and this in consequence, as all the witnesses, including many of the post office authorities, think, of the excessively high scale of taxation; (4) the fact of very injurious effects resulting from this state of things to the commerce and industry of the country, and to the social habits and moral condition of the people; (5) the fact, as far as conclusions can be drawn from very imperfect data, that whenever on former occasions large reductions in the rates have been made, these reductions have been followed in short periods of time by an extension of correspondence proportionate to the contraction of the rates; (6) and, as matters of inference from fact and of opinion—(i.) that the only remedies for the evils above stated are a reduction of the rates, and the establishment of additional deliveries, and more frequent despatches of letters; (ii.) that owing to the rapid extension of railroads there is an urgent and daily increasing necessity for making such changes; (iii.) that any moderate reduction in the rates would

¹ *Report of Secret Committee on the Post Office* (1844), p. 9.

² *Lords' Journals*, xxii. 183-186; *State Trials*, xvi. 540 seq.

³ *Post Office Reform*, 27 seq.

occasion loss to the revenue, without in any material degree diminishing the present amount of letters irregularly conveyed, or giving rise to the growth of new correspondence; (iv.) that the principle of a low uniform rate is just in itself, and, when combined with prepayment and collection by means of a stamp, would be exceedingly convenient and highly satisfactory to the public."

A bill to enable the treasury to establish uniform penny postage was carried in the House of Commons by a majority of 100, and became law on the 17th of August 1839. A temporary office was created to enable Rowland Hill to superintend the working out of his plan. The first step taken was to reduce, on the 5th of December 1839, the London district postage to 1d. and the general inland postage to 4d. the half-ounce (existing lower rates being continued). On the 10th of January 1840 the uniform penny rate came into operation throughout the United Kingdom—the scale of weight advancing from 1d. for each of the first two half-ounces, by gradations of 2d. for each additional ounce, or fraction of an ounce, up to 16 oz. The postage was to be prepaid, and if not to be charged at double rates. Parliamentary franking was abolished. Postage stamps were introduced in May following. The facilities of despatch were soon afterwards increased by the establishment of day mails.

But on the important point of simplification in the internal economy of the post office, with the object of reducing its cost without diminishing its working power, little was done. The plan had to work in the face of rooted mistrust on the part of the workers. Its author was (for a term of two years, afterwards prolonged to three) the officer, not of the post office, but of the treasury. He could only recommend measures the most indispensable through the chancellor of the exchequer. It happened, too, that the scheme had to be tried at a period of severe commercial depression. Nevertheless, the results actually attained

Results. in the first two years were briefly these: (1) the chargeable letters delivered in the United Kingdom, exclusive of that part of the government correspondence which theretofore passed free, had already increased from the rate of about 75,000,000 a year to that of 196,500,000; (2) the London district post letters had increased from about 13,000,000 to 23,000,000, or nearly in the ratio of the reduction of the rates; (3) the illicit conveyance of letters was substantially suppressed; (4) the gross revenue, exclusive of repayments, yielded about a million and a half per annum, which was about 63% of the amount of the gross revenue in 1839. These results at so early a stage, and in the face of so many obstructions, vindicated the new system.

Seven years later (1849) the 196,500,000 letters delivered throughout the United Kingdom in 1842 had increased to nearly 329,000,000. In addition, the following administrative improvements had been effected: (1) the time for posting letters at the London receiving-houses extended; (2) the limitation of weight abolished; (3) an additional daily despatch to London from the neighbouring (as yet independent) villages; (4) the postal arrangements of 120 of the largest cities and great towns revised; (5) unlimited writing on inland newspapers authorized on payment of an additional penny; (6) a summary process established for recovery of postage from the senders of unpaid letters when refused; (7) a book-post established; (8) registration reduced from one shilling to sixpence; (9) a third mail daily put on the railway (without additional charge) from the towns of the north-western district to London, and day mails extended within a radius of 20 m. round the metropolis; (10) a service of parliamentary returns, for private bills, provided for; (11) measures taken, against many obstacles, for the complete consolidation of the two heretofore distinct corps of letter-carriers—an improvement (on the whole) of detail, which led to other improvements thereafter.¹

Later History (1842-1905).

When Sir R. Hill initiated his reform the postmaster-general was the earl of Lichfield, the thirty-first in succession to that

¹ Hill, *History of Penny Postage* (1880), appendix A (*Life, &c.*, ii. 438). Part of the strenuousness of the opposition to this measure arose, it must be owned, from the "high-handedness" which in Sir R. Hill's character somewhat marred very noble faculties. The change worked much harm to some humble but hardworking and meritorious functionaries.

office after Sir Brian Tuke. Under him the legislation of 1839 was carried out in 1840 and 1841. In September 1841 he was succeeded by Viscount Lowther.

In the summer of 1844 the statement that the letters of Mazzini, then a political refugee, long resident in England, had been systematically opened, and their contents communicated to foreign governments, by Sir James Graham, secretary of state for the home department, aroused much indignation. The arrest of the brothers Bandiera,² largely in consequence of information derived from their correspondence with Mazzini, and their subsequent execution at Cosenza made a thorough investigation into the circumstances a public necessity. The consequent parliamentary inquiry of August 1844, after retracing the earlier events connected with the exercise of the discretionary power of inspection which parliament had vested in the secretaries of state in 1710, elicited the fact that in 1806 Lord Spencer, then secretary for the home department, introduced for the first time the practice of recording in an official book all warrants issued for the detention and opening of letters, and also the additional fact that from 1822 onwards the warrants themselves had been preserved. The whole number of such warrants issued from 1806 to the middle of 1844 inclusive was stated to be 323, of which no less than 53 had been issued in the years 1841-1844 inclusive, a number exceeding that of any previous period of like extent.

The committee of 1844 proceeded to report that "the warrants issued during the present century may be divided into two classes—1st, those issued in furtherance of criminal justice . . . ; 2nd, those issued for the purpose of discovering the designs of persons known or suspected to be engaged in proceedings dangerous to the State, or (as in Mazzini's case) *deeply involving British interests*, and carried on in the United Kingdom or in British possessions beyond the seas. . . . Warrants of the second description originate with the home office. The principal secretary of state, of his own discretion, determines when to issue them, and gives instructions accordingly to the under-secretary, whose office is then purely ministerial. The mode of preparing them, and keeping record of them in a private book, is the same as in the case of criminal warrants. *There is no record kept of the grounds on which they are issued*, except so far as correspondence preserved at the home office may lead to infer them.³ . . . The letters which have been detained and opened are, unless retained by special order, as sometimes happens in criminal cases, closed and resealed, without affixing any mark to indicate that they have been so detained and opened, and are forwarded by post according to their respective superscriptions."⁴

Almost forty years later a like question was again raised in the House of Commons (March 1882) by some Irish members, in relation to an alleged examination of correspondence at Dublin for political reasons. Sir William Harcourt on that occasion spoke thus: "This power is with the secretary of state in England. . . . In Ireland it belongs to the Irish government. . . . It is a power which is given for purposes of state, and the very essence of the power is that no account [of its exercise] can be rendered. To render an account would be to defeat the very object for which the power was granted. If the minister is not fit to exercise the power so entrusted, upon the responsibility cast upon him, he is not fit to occupy the post of secretary of state."⁵ The House of Commons accepted this explanation; and in view of many grave incidents, both in Ireland and in America, it would be hard to justify any other conclusion.

The increase in the number of postal deliveries and in that of the receiving-houses and branch-offices, together with the numerous improvements introduced into the working economy of the post office, when Rowland Hill at length obtained the means of fully carrying out his reforms by his appointment as secretary,

² *Ricordi dei fratelli Bandiera e dei loro compagni di martirio in Cosenza*, p. 47 (Paris, 1844).

³ *Report from the Secret Committee on the Post Office* (1844), p. 11.

⁴ *Ibid.*, pp. 14-17.

⁵ Hansard, *Debates*, vol. cclxvii. cols. 294-296 (session of 1832).

**Opening and
Detention of
Letters.**

**Increase in
Postal
Business,
1839-1857.**

speedily gave a more vigorous impulse to the progress of the net revenue than had theretofore obtained. During the seven years 1845-1851 inclusive the average was but £810,951. During the six years 1852-1857 inclusive the average was £1,166,448—the average of the gross income during the same septennial period having been £2,681,835.

Number of Letters: Gross and Net Income, 1838-1857.

Year ending	Estimated No. of Chargeable Letters.	Gross Income.	Cost of Management.	Net Revenue.	Postage charged on Government.
Jan. 5, 1838	—	£ 2,339,737	£ 687,313	£ 1,652,424	£ 38,528
" 1842	196,500,191	1,499,418	938,168	561,249	113,255
" 1847	299,586,762	1,963,857	1,138,745	825,112	100,354
" 1852	360,647,187	2,422,168	1,304,163	1,118,004	167,129
Dec. 31, 1857	504,421,000	3,035,713	1,720,815	1,314,898	135,517

Within a period of eighteen years under the penny rate the number of letters became more than sixfold what it was under the rates of 1838. When the change was first made the increase of letters was in the ratio of 122.25% during the year. The second year showed an increase on the first of about 16%. During the next fifteen years the average increase was at the rate of about 6% per annum. Although this enormous increase of business, coupled with the increasing preponderance of railway mail conveyance (invaluable, but costly), carried up the post office expenditure from £757,000 to £1,720,800, yet the net revenue of 1857 was within £350,000 of the net revenue of 1839. During the year 1857 the number of newspapers delivered in the United Kingdom was about 71 millions, and that of book-packets (the cheap carriage of which is one of the most serviceable and praiseworthy of modern postal improvements) about 6 millions.

Since 1858 the achievements of the period 1835-1857 have been eminently surpassed. This period includes the establishment of postal savings banks (1861) and the transfer to the state of the telegraphic service (1870). These improvements are dealt with in separate articles. The British postal business has grown at a more rapid rate than the population of the United Kingdom. Some of the causes of this development must be sought within the post office department, e.g. improved facilities, lower charges and the assumption of new functions; but others are to be found in the higher level of popular education, the increase of wealth, industry and commerce, and the rapid expansion of Greater Britain.

The following table shows the growth of letters delivered:—*United Kingdom*.—Estimated inland delivery of letters, 1839-1905, with the increase per cent. per annum. Also the average number to each person, 00,000's omitted.

Year ending 31st December until 1876, and thereafter the Financial Year ending 31st March.	Delivered in England and Wales.				Total in England and Wales.	Increase per cent. per annum.	Average number to each person.	Total in Scotland.	Increase per cent. per annum.	Average number to each person.	Total in Ireland.	Increase per cent. per annum.	Average number to each person.	Total in United Kingdom.	Increase per cent. per annum.	Average number to each person.
	By Country Officers.	Increase per cent. per annum.	In London District, including Local Letters.	Increase per cent. per annum.												
Estimated No. of Letters, 1839	—	—	—	—	60,0	—	—	8,0	—	—	8,0	—	—	76,0	—	—
" " Franks, 1839	—	—	—	—	5,1	—	—	3	—	—	1,0	—	—	6,5	—	—
" " Letters, 1840	88,0	—	44,0	—	132,0	120.0	8	19,0	143.5	7	18,0	119.2	2	169,0	22.2	7
Average of 5 years, 1841-1845	122,0	10.7	57,0	9.0	179,0	10.2	11	24,0	9.2	9	24,0	9.5	3	227,0	10.0	8
" " 1846-1850	180,0	5.5	79,0	5.5	259,0	5.2	15	34,0	4.2	12	34,0	5.0	4	327,0	5.0	12
" " 1851-1855	233,0	6.5	97,0	5.0	330,0	6.0	18	41,0	5.2	14	39,0	3.5	6	410,0	5.7	15
" " 1856-1860	302,0	4.2	125,0	5.5	427,0	4.5	22	51,0	3.2	16	45,0	3.0	7	523,0	4.2	18
" " 1861-1865	373,0	5.7	161,0	5.7	534,0	5.7	29	61,0	0.5	20	53,0	3.2	9	648,0	5.5	22
" " 1866-1870	472,0	4.2	192,0	3.2	664,0	4.0	31	76,0	4.7	24	60,0	3.2	11	868,0	4.0	26
Year 1871	501,0	0.5	220,0	7.0	721,0	2.5	32	80,0	1.2	24	66,0	3.0	13	867,0	2.3	27
" 1875	580,0	4.8	266,7	6.5	846,8	5.3	35	90,9	0.9	26	70,5	0.8	13	1,008,3	4.6	31
" 1880-1881	650,9	1.7	330,4	6.6	981,3	3.3	38	104,9	3.0	29	78,7	3.8	15	1,165,1	3.3	34
" 1884-1885	757.2	2.7	391.1	4.1	1,148.3	3.2	42	122.9	2.6	32	89.1	1.6	18	1,360.3	2.9	38
" 1890-1891	924.4	3.3	538.4	4.0	1,462.8	3.5	50	143.2	2.1	36	99.8	3.1	21	1,709.0	3.4	45
" 1894-1895 ¹	993.3	2.0	508.8	11.6	1,502.1	3.1	50	156.0	1.4	38	112.8	4.0	24	1,770.9	2.3	46
" 1900-1901 ²	1,312.7	2.9	664.3	5.0	1,977.0	3.6	61	202.4	2.8	47	144.2	2.2	32	2,323.6	3.4	57
" 1905-1906	1,559.9	3.2	753.4	3.6	2,313.3	3.3	68	238.1	3.7	51	155.8	0.1	36	2,707.2	3.1	62

¹ It was discovered in the course of this year that the estimated figures for previous years had been swollen by an imperfect method of reckoning the London letters, &c. In 1883 as many as 2,770,000 valentines were sent through the post. The numbers gradually

The rates of inland letter postage have been altered as follows. From the 5th of October 1871 to the 1st of July 1885 the charges were: not exceeding 1 oz. one penny; over 1 oz. and not exceeding 2 oz. three halfpence, and an additional halfpenny for every 2 oz., so that the postage on a letter weighing between 10 and 12 oz. was 4d. On a letter weighing over 12 oz. and not exceeding 13 oz. the postage was 1s. 1d., and increased 1d. for each succeeding ounce. On the 1st of July 1885 the postage on letters over 12 oz. was reduced, and the gradation of charge beyond 2 oz. was made uniform, at the rate of one halfpenny for each additional ounce. Thus a letter weighing over 12 and not exceeding 14 oz. was charged 4½d., 14 to 16 oz. 5d., and so on. Notwithstanding this change, it was found as late as 1895 that 95% of the letters sent through the post weighed not more than 1 oz. each.

Inland Letter Rates.

Among a number of postal and telegraphic concessions made to the public on the 22nd of June 1897, the sixtieth anniversary of Queen Victoria's accession to the throne, were new rates for letters as follows:—

Not exceeding 4 oz.	1
Over 4 oz. and not exceeding 6 oz.	1½
" 6 " " with ½d. for each succeeding 2 oz.	2

This change, while it saved both the post office and the public the trouble of testing the weight of a large number of letters, had also the advantage of simplicity of calculation—one halfpenny is charged for each 2 oz., with a minimum charge of 1d.

Arrangements were at the same time made to ensure a delivery of letters by postmen at every house in the United Kingdom. It was estimated that 16 millions of letters, whose owners had previously to fetch them from the post office or from some point on a postman's walk, would thus be added to the official delivery. The estimate proved to be much under the mark, some 60 millions being added to the letters brought annually into the official delivery under this arrangement. Financial considerations have now been entirely disregarded for the benefit of these letters, and the cost of their delivery alone greatly exceeds the whole revenue derived from them.

In studying the statistics of letters delivered, it should be remembered that the figures for any particular year are affected by circumstances like a general election or a boom in trade, as well as by changes in the rates or condition of the post office services. The letters from foreign countries have been stimulated by lower charges, and those from the colonies by the imperial penny post, to which reference is made below.

decreased until in 1890 only 320,000 were observed. Christmas cards have, however, considerably increased.

² Since the 22nd of June 1897, all packets over 2 oz., formerly counted as book packets, are reckoned as letters.

On the 12th of February 1892 letter cards bearing an imprinted penny stamp, and made to be fastened against inspection, were issued to the public at a charge of 1s. for 10 cards. The charge was reduced almost at once to 9d. for 8 cards. Similar cards have long been in use on the continent of Europe, but they do not enjoy much popularity in Great Britain either with the post office, which finds them inconvenient to handle in sorting and stamping, or with the public. The number issued annually is about 10 millions, not counting those of private manufacturers.

The following table gives the number of post cards:—

Estimated Number of Post Cards delivered in the United Kingdom, and the Increase per cent. per Annum.

Year.	England and Wales.		Scotland.		Ireland.		United Kingdom.	
	Number.	Inc. per cent. per annum.	Number.	Inc. per cent. per annum.	Number.	Inc. per cent. per annum.	Number.	Inc. per cent. per annum.
1872 . .	64,000,000	—	8,000,000	—	4,000,000	—	76,000,000	—
1875 . .	73,369,100	11·6	9,206,300	6·7	4,540,900	5·5	87,116,300	10·7
1881-1882	114,251,500	10·4	14,651,400	9·3	6,426,100	6·9	135,329,000	10·1
1884-1885	134,100,000	4·3	18,400,000	5·5	7,900,000	3·1	160,400,000	4·4
1889-1890	184,400,000	8·4	22,900,000	5·0	9,800,000	5·4	217,100,000	7·8
1893-1894	209,100,000	1·4	27,400,000	2·2	12,000,000	6·2	248,500,000	1·6
1894-1895*	271,600,000	29·9	28,700,000	4·7	12,500,000	4·2	312,800,000	25·9
		dec.						
1895-1896	268,300,000	1·2	32,200,000	12·2	14,000,000	12·0	314,500,000	0·6
		inc.						
1900-1901	359,400,000	4·9	41,600,000	2·0	18,000,000	6·5	419,000,000	4·7
1905-1906	676,500,000	9·6	91,000,000	5·0	32,800,000	6·8	800,300,000	9·0

*Private cards with adhesive stamps first allowed in this year.

Post cards were first introduced in Austria on the 1st of October 1869, and were first issued in Great Britain on the 1st of October 1870. Only one kind of card was employed, and this was sold for one halfpenny; but on the complaints of the stationers, a charge of 3d. per dozen for the material of the card was made in 1872, and permission was given for private persons to have their own cards stamped at Somerset House. In 1875 a stouter card was put on sale, and the charges were raised to 7d. per dozen for thin cards and 8d. per dozen for stout cards. In 1889 the charges were reduced, and they are now sold at 10 for 5d. and 11 for 6d. respectively. On the 1st of September 1894, private post cards with an adhesive halfpenny stamp were allowed to pass by post, and the result has been greatly to diminish the number of cards purchased through the post office. It is estimated that 232 out of the 400 millions of cards delivered in 1899-1900 were private cards. The sizes of the official cards were again altered in January 1895 and November 1899. The regulations forbidding anything but the address to be written on the address side of a post card were made less stringent on the 1st of February 1897; and in 1898 unpaid post cards, which were previously charged as unpaid letters, were allowed to be delivered on payment of double the post card rate. These various changes, especially the use of the private card and the popularity of illustrated post cards, have contributed to the rapid increase in the number of post cards sent by post. Reply post cards were first issued on the 1st of October 1893. Their use has not been extensive. Only about 1½ million are issued yearly.

Book Packets and Samples.—The table at foot of page shows the estimated number of book packets, circulars and samples delivered in the United Kingdom, and the increase per cent. per annum. The rate of 3d. for 2 oz. for the book post has remained unaltered since the 1st of October 1870. Changes have been made in the regulations defining the articles which may be sent by book post, and prescribing the mode of packing them so as to admit of easy examination for

the purpose of detecting letters, &c., sent by the halfpenny post. The book post received a great impetus in 1892 (May 28) by the permission to enclose book packets in unsealed envelopes. Complaint is, however, made that such envelopes form a dangerous trap for small letters, which are liable to slip inside the flaps of open envelopes. But as the rate of postage for articles weighing over 2 oz. is now the same for letters and for book packets, articles over that weight derive no advantage from being sent in open covers.

Sample Post.—The sample or pattern post, which was confined to bona-fide trade patterns and samples on the 1st of October 1870, was then assimilated to the book post (3d. for 2 oz.); but the restriction was difficult to enforce and irritating to the public, and the sample post was abolished on the 5th of October 1871, when the rates of letter postage were lowered. It was re-established on the 1st of October 1887 (1d. for 4 oz. or under, and 3d. for each succeeding 2 oz.); but when the Jubilee letter rates were introduced (June 22, 1897) it lost its *raison d'être*, and ceased to exist for inland purposes.

Newspapers.—The table on next page shows the estimated number of newspapers delivered in the United Kingdom, and the increase per cent. per annum.

The carriage of newspapers by the post office does not show the same elasticity as other post office business. This is due largely to the improved system of distribution adopted by newspaper managers and especially to the extension of the halfpenny press. The practice of posting a newspaper after reading it, under a co-operative arrangement, has practically ceased to exist. The carriage of newspapers by post

is conducted by the post office at a loss.

It has been frequently stated on behalf of the post office that the halfpenny post is unremunerative. Representations are, however, made from time to time in favour of lower postage for literature of all kinds. It may therefore be of interest to mention that the postmaster-general of the United States has, in successive annual reports, deplored the effect on the post office service of the cheap rates for "second-class matter." The cost of carriage over so large a territory is heavier than in the United Kingdom; but the postmaster-general states that the low rates of postage "involve a sheer wanton waste of \$20,000,000 or upwards a year." Facilities like the extension of free delivery are stifled, and the efficiency of the whole service cramped by the loss thus sustained. In the United Kingdom the rules respecting the halfpenny post were greatly simplified and brought into effect on the 1st of October 1906. The halfpenny post can be used only

Year.	England and Wales.		Scotland.		Ireland.		United Kingdom.	
	Number.	Inc. per cent. per annum.	Number.	Inc. per cent. per annum.	Number.	Inc. per cent. per annum.	Number.	Inc. per cent. per annum.
1872 . .	90,000,000	—	13,000,000	—	11,000,000	—	114,000,000	—
1875 . .	133,394,900	15·2	15,723,700	—	9,548,000	—	158,666,600	11·7
1881-1882	228,999,400	12·3	27,875,000	15·0	14,164,300	16·9	271,038,700	12·8
1884-1885	269,400,000	8·1	34,500,000	10·0	16,500,000	18·9	320,400,000	8·8
1889-1890	378,200,000	7·5	42,100,000	3·7	21,600,000	9·6	441,900,000	7·3
1894-1895	522,500,000	6·7	60,800,000	8·2	31,300,000	10·2	614,600,000	7·0
		dec.		dec.		dec.		dec.
1898-1899 ¹	590,900,000	3·6	75,100,000	2·3	35,500,000	5·3	701,500,000	3·5
		inc.		inc.		inc.		inc.
1900-1901	619,300,000	4·0	77,800,000	3·7	35,300,000	8·6	732,400,000	4·2

¹ Book packets over 2 oz. transferred to the letter post as a result of the Jubilee changes.

for packets not exceeding 2 oz. in weight. The length of a packet must not exceed 2 ft., while 1 ft. is the limit in width or depth. Any printed or written matter not in the nature of a letter may be sent by the halfpenny post, but every packet must be posted either without a cover or in an unfastened envelope, or in a cover which can be easily removed. The number of halfpenny packets delivered in 1906-1907 was 933,200,000.

Year.	England and Wales.		Scotland.		Ireland.		United Kingdom.	
	Number.	Inc. per cent. per annum.	Number.	Inc. per cent. per annum.	Number.	Inc. per cent. per annum.	Number.	Inc. per cent. per annum.
1872 . . .	87,000,000	—	12,000,000	—	10,000,000	—	109,000,000	—
1875 . . .	93,345,600	2·3	13,819,100	4·5	13,884,700	10·2	121,049,400	3·4
1881-1882	108,651,700	5·7	15,477,300	2·4	16,660,100	4·7	140,789,100	5·2
1884-1885	110,700,000	·7	16,900,000	0·9	16,100,000	0·5	143,700,000	0·7
1889-1890	126,600,000	6·1	16,700,000	0·6	16,000,000	—	159,300,000	4·9
		dec.		dec.		dec.		dec.
1894-1895 ¹	117,500,000	9·5	17,300,000	2·3	17,000,000	2·3	151,800,000	7·9
		inc.		inc.		inc.		inc.
1899-1900	125,000,000	5·9	19,300,000	7·8	19,100,000	4·9	163,400,000	6·0
1900-1901	127,800,000	2·2	19,300,000	—	20,700,000	8·4	167,800,000	2·7

The inland parcel post began on the 1st of August 1883. No parcel might exceed 7 lb in weight, 3½ ft. in length, of 6 ft. in length and girth combined. The rates were: not exceeding 1 lb, 3d.; exceeding 1 lb, but not exceeding 3 lb, 6d.; exceeding 3 lb, but not exceeding 5 lb, 9d.; exceeding 5 lb, but not exceeding 7 lb, 1s. The following table shows the number of parcels delivered in the United Kingdom:—

Year ending 31st March.	Number of Parcels.
1884	14,000,000
1885	22,910,040
1890	42,852,600
1895	57,136,000
1900	75,448,000
1905	97,231,000

Arrangements were made with the railway companies, under which they receive 55% of the postage on each parcel sent by train. This arrangement, which was to hold good for 21 years, proved, however, an onerous one, and on the 1st of June 1887 the post office started a parcel coach between London and Brighton. The coach, replaced in 1905 by a motor van, travelled by night, and reached Brighton in time for the first delivery. The experiment proving successful, other coach and motor services were started at different dates between London and other places in the provinces, the mail services performed by motor vans amounting in 1906 to nearly forty. Nearly 11½ millions of parcels were conveyed by the post office in 1900-1901 without passing over a railway.

On the 1st of May 1896, the maximum weight was increased to 11 lb, and the postage rates were reduced: not exceeding 1 lb, 3d.; for each succeeding lb, 1½d.; the charge for a parcel of 11 lb was thus 1s. 6d. New rates were subsequently introduced and the rates for parcels now are: not exceeding 1 lb, 3d.; 2 lb, 4d.; 3 lb, 5d.; 5 lb, 6d.; 7 lb, 7d.; for each succeeding lb up to 11 lb, 1d. The length of a parcel must not exceed 3 ft. 6 in.; length and girth combined must not exceed 6 ft. By the Post Office (Literature for the Blind) Act 1906, the postage on packets of papers and books impressed for the use of the blind was greatly reduced, the rates being fixed at: not exceeding 2 oz., ¼d.; exceeding 2 oz. and not exceeding 2 lb, 1d.; not exceeding 5 lb, 1½d.; not exceeding 6 lb, 2½d.

The number of letters registered by the public in the United Kingdom in 1884-1885 amounted to 11,365,151. In the next ten years the numbers oscillated between 10,779,555 (1886-1887) and 12,132,144 (1892-1893); but since 1894-1895, when 11,958,264 letters were registered, the number steadily increased, until it stood at 19,029,114 for 1903-1904. It decreased, however, 2·8% in 1904-1905, increased ·7 in the following year, but declined again by ·8% in 1906-1907. It has been surmised² that the introduction of

Registered Letters.

¹ See note to table of *Letters Delivered*.

² *Thirty-second Report of Postmaster-General.*

postal orders checked the growth of registered letters for some years after 1880. In 1886 a system of insurance for registered letters was adopted. The ordinary registration fee entitled the owner, in case of loss, to recover compensation for the post office up to a limit of £2. For an additional insurance fee of 1d. the limit was raised to £5, and for 2d. to £10. Various changes have since been made, and the separate insurance system

has been abolished. At present a registration fee of 2d. entitles to compensation up to £5, 3d. £20, and each additional penny to a further £20, up to a maximum of £400. The system of registration has also been extended to parcels.

On the 1st of February 1891 the railway letter service came into operation. At passenger stations on the principal railways a letter not exceeding 4 oz. in weight may be handed in at the booking office for conveyance by the next train. A fee of 2d. is payable to the railway company as well as the ordinary postage of 1d.

Railway Letters.

The letter may be addressed to a railway station to be called for. If it bears any other address it is posted on arrival at its proper station. The number of packets so sent is about 200,000 a year.

The express delivery service dates from the 25th of March 1891. A private company formed for the purpose of supplying the public on demand with an express messenger to execute errands was found to be infringing the postmaster-general's monopoly both as regards the conveyance of letters and the transmission of communications by electricity. The services of the company were, however, much appreciated by the public. The government accordingly authorized the post office to license the existing company to continue its business, on the payment of royalties, till 1903,³ and to start an express service of its own.

Express Letters.

Messengers can be summoned from the post office by telephone, and arrangements can be made with the post office for the special delivery of all packets arriving by particular mails in advance of the ordinary postman. The sender of a packet may have it conveyed by express messenger all the way, or may direct that, after conveyance by ordinary post to the terminal post office, it shall then be delivered by special messenger. The fees, in addition to ordinary postage, were originally fixed at 2d. for the first mile, 3d. for the second mile, and 1s. a mile additional when the distance exceeded 2 m. and there was no public conveyance. Under the present regulations the fee is 3d. for each mile covered by special messenger before delivery. No charge is made for postage in respect of the special service, but if the packet is very weighty or the distance considerable, and no public conveyance is available, the sender must pay for a cab or other special conveyance.

Letters and parcels to or from a number of foreign countries and colonies may also be marked for express delivery after transmission by post; and residents in London, not having a delivery of ordinary letters on Sunday, may receive on that day express letters from home or abroad which have come too late for express delivery on Saturday nights. The total number of express services in 1905-1906 was 1,578,746. In many cases one of these services included the delivery of batches of letters, so that in London alone 1,010,815 express services were performed, including 47,601 deliveries in advance of the postmen.

There are various central dépôts for dealing with "dead" or returned letters. The principal office is in London. In the year 1905-1906 10,868,272 letters were received at the various returned letter offices, of which 1,008,017 could neither be delivered to the addresses nor returned to the senders. Such of these as contain nothing of value are at once destroyed, and no record of them is kept. The

Returned Letters.

³ Afterwards extended to the 31st of March 1922.

others are recorded, and (if not previously claimed by the owners) their contents are sold by auction at intervals. If the owner applies after the sale, the proceeds are handed over to him. In addition to these 10 millions of letters, there were many others disposed of at head post offices, whence they were returned direct and unopened to the senders, whose names and addresses appeared on the outside of the letters. The total number of post cards received in the various offices as undelivered was

oo's omitted.

Country or Colony.	Despatched from the United Kingdom.		Destined for the United Kingdom.	
	Letters and Post Cards.	Circulars, Book Packets, Patterns, Newspapers.	Letters and Post Cards.	Circulars, Book Packets, Patterns, Newspapers.
EUROPE.	lb	lb	lb	lb
Austria-Hungary . . .	52,0	392,0	41,0	118,0
Belgium and Luxemburg .	88,0	358,0	87,0	201,0
Denmark, Norway and Sweden . . .	78,0	314,0	65,0	132,0
France (including Algeria and Tunis) . . .	329,0	1,426,0	354,0	1,152,0
Germany . . .	310,0	1,656,0	378,0	1,090,0
Gibraltar (including Tangier), Malta and Cyprus .	46,0	413,0	64,0	44,0
Holland . . .	140,0	302,0	90,0	450,0
Italy . . .	73,0	613,0	66,0	172,0
Russia . . .	49,0	325,0	35,0	92,0
Spain, Portugal and Azores .	50,0	536,0	47,0	85,0
Switzerland . . .	66,0	490,0	55,0	147,0
Turkey, Greece, Rumania and Balkan States . . .	25,5	305,0	23,0	65,0
Totals . . .	1,306,5	7,130,0	1,305,0	3,748,0
ASIA.	lb	lb	lb	lb
Asiatic Turkey and Persia .	8,5	100,0	5,0	35,0
India (including Aden) . . .	230,0	2,828,0	164,0	432,0
Ceylon, Straits Settlements and East Indies . . .	56,0	755,0	40,0	90,0
China and Japan . . .	54,0	762,0	55,0	84,0
Totals . . .	348,5	4,445,0	264,0	641,0
AFRICA.	lb	lb	lb	lb
South African Colonies . . .	323,0	2,671,0	237,0	530,0
East Coast of Africa (British and Portuguese Possessions), Mauritius, &c. . .	16,0	186,0	10,0	15,0
West Coast of Africa, Madeira, Canary Islands, Cape Verde, St Helena and Ascension . . .	31,0	382,0	32,0	20,0
Egypt . . .	40,0	398,0	28,0	64,0
Totals . . .	410,0	3,637,0	307,0	629,0
AMERICA.	lb	lb	lb	lb
United States . . .	397,0	2,850,0	431,0	2,488,0
Canada and Newfoundland .	248,0	1,891,0	187,0	616,0
Mexico and Central American States . . .	11,0	177,0	11,0	13,0
Brazil, Argentine Republic, Uruguay and Paraguay . . .	39,0	621,0	35,0	78,0
Chile, Peru and Bolivia . . .	15,0	195,0	17,0	34,0
Ecuador, Colombia and Venezuela . . .	7,0	83,0	3,0	4,0
West Indies (British and Foreign) . . .	49,0	449,0	31,0	47,0
Totals . . .	766,0	6,266,0	715,0	3,280,0
AUSTRALASIA.	lb	lb	lb	lb
Commonwealth of Australia . . .	122,0	1,600,0	80,0	534,0
New Zealand, Fiji, &c. . .	56,0	753,0	40,0	333,0
Totals . . .	178,0	2,353,0	120,0	867,0
Grand totals . . .	3,009,0	23,831,0	2,711,0	9,165,0

2,656,770; halfpenny packets, 12,439,377; newspapers, 473,346; and parcels, 248,526; 195,145 of these last were re-issued. Articles sent by the halfpenny post are destroyed at the head offices if they cannot be delivered; but the sender may have such articles returned if he writes a request to that effect on the outside of the packet, together with his name and address, and pays a second postage on the return of the packet. The number of registered letters and letters containing property sent through the post with insufficient addresses was 320,041. These letters contained £16,887 in cash and bank-notes, and £656,845 in bills, cheques, money orders, postal orders and stamps. The coin found loose in the post amounted to £1,380, as well as £12,272 in cheques and other forms of remittance.

The table in opposite column shows the estimated weight of the mails (excluding parcels) exchanged with the British colonies and foreign countries in 1905-1906. *Foreign Mails.* The number of letters and post cards may be roughly taken at 40 to the lb.

During the same year 2,474,003 parcels were despatched out of the United Kingdom, and 1,431,035 were received from the British colonies and other countries. Germany, with 356,423, received the largest number of any one country, and easily heads the list of countries from which parcels were imported into the United Kingdom, with 474,669, France coming next with 254,490.

On the 1st of January 1889 a weekly all-sea service to the Australasian colonies was opened. The rates were 4d. per ½ oz. for letters, and 2d. for post cards, as compared with 6d. and 3d. by the quicker route. In the Budget of 1890 provision was made for a lower and uniform rate of postage from the United Kingdom to India and the British colonies generally. The rates, which had hitherto varied from 2½d. to 4d., 5d., or 6d. per ½ oz., were fixed at 2½d. per ½ oz. The change took effect on the 1st of January 1891, and resulted at the outset in a loss of £100,000 a year. The fourth postal union congress, which met at Vienna in May and June 1891 (third congress at Lisbon, February and March 1885), took a further step in the direction of uniformity, and on the 1st of October 1891 the 2½d. rate was extended to foreign as well as colonial letters from the United Kingdom. The Australasian colonies gave their adhesion to the Union at this congress, and the Cape signified its adhesion at the next congress (Washington, May and June 1897), while British Bechuanaland and Rhodesia entered in 1900, and the whole of the British Empire is now included in the international union. Abyssinia, Afghanistan, Arabia, China and Morocco are the chief countries which remain outside. The rate was 2½d. the first oz., and 1½d. per oz. afterwards.

Advantage was taken of the presence in England of special representatives of India and the principal British colonies to hold an imperial postal conference in London in June and July 1897, under the presidency of the duke of Norfolk, postmaster-general. Chiefly at the instance of Canada the duke announced that on and from Christmas Day 1898 an imperial penny post would be established with such of the British colonies as were prepared to reciprocate. The new rates (1d. per ½ oz.), which had long been advocated by Mr Henniker Heaton, were adopted then or shortly afterwards by the countries within the empire, with the exceptions of Australasia and the Cape, where the 2½d. rate remained unaltered. The Cape came afterwards into the scheme, and New Zealand joined in 1902. Australia did not see its way to make the necessary financial arrangements, but in 1905 agreed to receive without surcharge letters from other parts of the empire prepaid at 1d. per ½ oz. and reduced its outward postage to 2d. per ½ oz., raised to 1 oz. in 1907. In 1911 penny postage was adopted throughout the commonwealth and to the United Kingdom. Owing to the special relations existing between the governments of Egypt and the United Kingdom, penny postage for letters passing between the United Kingdom and Egypt and the Sudan was introduced in December 1905; and

the Egyptian post office subsequently arranged for the adoption of this rate with many of the British colonies. On the 1st of October 1908 penny postage was established between Great Britain and the United States on the same lines as the imperial penny post.

At the 1897 conference it was proposed that the parcel rates with British possessions should be lowered and simplified by the adoption of a triple scale for parcels exchanged by sea, namely, 1s. up to 3 lb, 2s. from 3 to 7 lb, and 3s. from 7 to 11 lb. This scale has been adopted by many of the British colonies. The parcel post has been gradually extended to nearly the whole civilized world, while the rates have in many cases been considerably reduced. The United States remained an exception, and in 1902 an agreement was concluded with the American Express Company for a parcel service. In April 1904 an official service was established with the United States post office, but the semi-official service is still maintained with the American Express Company. By the official service the limit of weight was 4 lb 6 oz., and the postage 2s. per parcel; by the semi-official service parcels up to 11 lb in weight may be sent, the rates ranging from 3s. to 6s. On the 1st of July 1908 the rates were revised. The limit of weight was increased to 11 lb, the rate for a parcel being 1s. 6d. for a parcel up to 3 lb in weight, 2s. 6d. up to 7 lb, 3s. 6d. up to 9 lb and 4s. 6d. for 11 lb.

On the 1st of January 1885 the post office at Malta was transferred from the control of H.M. postmaster-general to that of the local administration, and a similar change was made as regards Gibraltar on the 1st of June 1896.

Remarkable improvements have been effected in the speed and frequency of the mails sent abroad, and contracts are entered into from time to time with the various **Foreign Mail Service.** mail steamship companies for additional or improved services. The transit charges for special trains conveying mails through France and Italy for Egypt, India, Australia and the Far East have been successively reduced until they now stand at the ordinary Postal Union transit rates.

Mention should be made of the Army post office, which is now an essential accompaniment of military operations. On the outbreak of hostilities in South Africa in 1899, the **Army Post Office Corps.** the British post office supplied 10 officers and 392 men to deal with the mails of the forces, sell postage stamps, deal in postal orders, &c. Contingents were also sent by the Canadian, Australian, and Indian post offices. Including telegraphists and men of the army reserve, 3400 post office servants were sent to the front.

MONEY ORDER DEPARTMENT

The money order branch of the post office dates from 1792.¹ It was begun with the special object of facilitating the safe **Money Orders.** conveyance of small sums to soldiers and sailors, the thefts of letters containing money being frequent. Two schemes were put forward, one similar to the present money order system. There were doubts whether the post office had power to adopt the system, and it was not officially taken up. Six officers of the post office, however, called the "clerks of the roads," who were already conducting a large newspaper business with profit to themselves, came forward with a plan, which was encouraged by the postmaster-general, who also bore the cost of advertising it, and even allowed the advices of the money orders to go free by post under the "frank" of the secretary to the post office. In 1798 the clerks of the roads gave up the scheme, and three post office clerks known as "Stow and Company" took it over. The death of Stow in 1836 left one sole proprietor who had a capital of £2000 embarked on the concern. In 1838 the government determined to take over the business and compensated the proprietor with an allowance of over £400 a year. The rates of commission fixed by the government were 1s. 6d. for sums exceeding £2 and under £5, and 6d. for all sums not exceeding £2. In 1840 these rates were reduced to 6d. and 3d. respectively. The number and aggregate amount of the orders issued (inland, colonial and

foreign) in different periods from the reorganization until 1905 is as follows:—

Years.	Number.	Amount.
1839	188,921	£ 313,124
1849	4,248,891	8,152,643
1861-1865 (average)	8,055,227	16,624,503
1875	16,819,874	27,688,255
1880-1881	16,935,005	26,003,582
1885-1886	11,318,380	24,832,421
1890-1891	10,260,852	27,867,887
1895-1896	10,900,963	29,726,817
1900-1901	13,263,567	39,374,665
1905-1906	13,596,153	44,612,785

The decrease in the number of inland money orders till 1890-1891 was due to the competition of postal orders, and to the reduction (Jan. 1, 1878) of the charge for registering a letter from 4d. to 2d.²

In 1862 the issue of orders for larger sums was allowed: not exceeding £7, 9d.; not exceeding £10, 1s.

On the 1st of May 1871 a scale of charges was fixed as follows: orders not exceeding 10s., 1d.; not exceeding £1, 2d.; not exceeding £2, 3d.; and so on, an additional penny being charged per £. For sums of £10 the rate was 1s. It was found, however, that the low rate of 1d. for small orders did not provide a profit, and the rates were raised on the 1st of January 1878 to: orders not exceeding 10s., 2d.; not exceeding £2, 3d. On the 1st of September 1886 the rates were altered as follows: orders not exceeding £1, 2d.; not exceeding £2, 3d.; not exceeding £4, 4d.; not exceeding £7, 5 d.; not exceeding £10, 6d. On the 1st of February 1897 new rates were introduced; on orders not exceeding £3, 3d.; over £3 and not exceeding £10, 4d.

The cost of a money order transaction (at least 3d.) is very little affected by the amount of the remittance, and it was thought undesirable to continue the unremunerative business of sending small sums by money order at less than cost price at the expense of the senders of larger orders. The needs of smaller remitters appeared to be sufficiently met by postal orders and the registered letter post. It appeared, however, that the new charges fell with great severity upon mutual benefit societies, like the Hearts of Oak, which sent large numbers of small money orders every week, and on the 1st of May 1897 the 2d. rate was restored for orders not exceeding £1. This society and others now use postal orders instead of money orders. In 1905 the limit for money orders was extended to £40, and the rates are: sums over £10 and not exceeding £20, 6d.; sums over £20 and not exceeding £30, 8d.; sums over £30 and not exceeding £40, 10d.

Money orders may be sent to almost any country in the world. The rates are as follows: for sums not exceeding £1, 3d.; £2, 6d.; £4, 9d.; £6, 1s.; £8, 1s. 3d.; £10, 1s. 6d.; and for countries on which orders may be issued for higher amounts (limit £40), 3d. for every additional £2 or fraction of £2. **Foreign and Colonial Money Orders.**

The money order system is largely used by the British government departments for the payment of pensions, separation allowances, remittance of bankruptcy dividends, &c.; and free orders may be obtained by the public, under certain conditions, for the purpose of remitting their taxes. The cost of management of the money order office was reduced by the substitution, since 1898, of a number of women clerks for men and boys.

On the 2nd of September 1889 the issue of telegraphic money orders between London and seventeen large towns was begun as an experiment, and on the 1st of March 1890 the system was extended to all head post offices, and branch offices in the United Kingdom. Two years later it was extended to every office which transacts both money order and telegraph business. The rates, which have been several times revised, are (1) a poundage at the ordinary rate for inland money orders, (2) a charge for the official telegram of advice to the office of payment at the ordinary rate for inland telegrams, the minimum being 6d., and (3) a supplementary fee of 2d. for each order. The sender of a telegraph money order may give instructions that, instead of being left at the post office to be called for, it should be delivered at the payee's residence, and that it should be crossed **Telegraph Money Orders.**

¹ An historical outline is given in the *Forty-Second Report of Postmaster-General* (1896), p. 26.

² The total sums remitted did not fall off to the same extent, showing that the small orders alone were effected. The average amount for ordinary inland orders is now £2, 19s. 5d.

for payment through a bank. He may also, on paying for the extra words, send a short private message to his correspondent in the telegram of advice.

Telegraph money orders may also be sent to Algeria, Austria, Belgium, Bulgaria, Denmark, Egypt, Faeroe Islands, France, Germany, Holland, Hungary, Iceland, Italy, Luxemburg, Monaco, Norway, Rumania, Sweden and Switzerland. A fee of 2d. is required in addition to the usual money order commission and the cost of the telegram. The system is being rapidly extended to other countries.

The telegraph inland money orders in 1905-1906 amounted to 503,543, and the sums so remitted to £1,646,882, an average of £3. 1s. The number of telegraph money order transactions between the United Kingdom and foreign countries amounted to 18,787, representing £139,402.

Postal orders were first issued on the 1st of January 1881. For some years before that date postmasters-general had considered the possibility of issuing orders for fixed amounts at a small commission to replace money orders for sums under 20s., which had failed to be remunerative. When the plan was submitted to a committee appointed by the treasury, it was objected that postal orders as remitting media would be less secure than money orders. This was met in part by giving a discretionary power to fill in the name of the post office and also of the payee. Another objection which was urged, namely, that they would prove to be an issue of government small notes under another name, was quickly disproved. Parliament sanctioned the scheme in 1880. The first series were:—

	1s., 1s. 6d., 2s. 6d., 5s., 7s. 6d.
Poundage	½d. 1d.
	10s., 12s. 6d., 15s., 17s. 6d., 20s.
Poundage	2d.

In 1884 a new series was issued and a provision made that broken amounts might be made up by affixing postage stamps, to the value of 5d., to the orders. Postal orders have become increasingly popular as a means of remitting small amounts, especially since the introduction in 1903 of new denominations, rendering it possible to obtain a postal order for every complete sixpence from 6d. to 21s. From 6d. to 2s. 6d. the poundage is ½d., from 3s. to 15s., 1d., from 15s. 6d. up to 21s., 1½d. Postal orders are also furnished with counterfoils, as a means of keeping a record of the number and amount of each order posted. Orders for amounts of 10s. and upwards are printed in red ink. A system of interchange of postal orders between the United Kingdom and India and the British colonies, and also between one colony and another, has been instituted. British postal orders are obtainable also at post offices in Panama, Constantinople, Salonica and Smyrna, and on H.M. ships. The following table shows the number and value of postal orders issued from the beginning to the 31st of March 1907 (000's omitted):—

Year.	Number.	Value.
		£
1881-1882	4,462	2,006
1883-1884	12,286	5,028
1885-1886	25,790	10,788
1890-1891	48,841	19,178
1895-1896	64,076	23,896
1900-1901	85,390	29,881
1906-1907	101,658	40,484

It remains to be added that the various statutes relating to the post office, except those relating to telegraphs and the carriage of mails, were consolidated by the Post Office Act 1908. The act repealed and superseded 26 acts wholly and 10 acts in parts. Sections 1-11 deal with the duties of postage; §§ 12-19 with the conditions of transit of postal packets; §§ 20-22 with newspapers; §§ 23-25 with money orders; §§ 26-32 with ship letters; §§ 33-44 with the postmaster-general and officers; §§ 45-47 with the holding, &c., of land; §§ 48-49 with the extension of postal facilities and accommodation; §§ 50-69 with post office offences; §§ 70-78 with legal proceedings, and §§ 79-94 with regulations, definitions, &c.

SAVINGS BANKS.¹

The establishment of post office savings banks was practically suggested in the year 1860 by Charles William Sykes of Huddersfield, whose suggestion was cordially received by W. E. Gladstone, then chancellor of the *Savings Banks.* exchequer, to whose conspicuous exertions in parliament the effectual working-out of the measure and also many and great improvements in its details are due. Half a century earlier (1807) it had been proposed to utilize the then existing and rudimentary money order branch of the post office for the collection and transmission of savings from all parts of the country to a central savings bank to be established in London. A bill to that effect was brought into the House of Commons by S. Whitbread, but it failed to receive adequate support, and was withdrawn. When Sykes revived the proposal of 1807 the number of savings banks managed by trustees was 638, but of these about 350 were open only for a few hours on a single day of the week. Only twenty throughout the kingdom were open daily. Twenty-four towns containing upwards of ten thousand inhabitants each were without any savings bank. Fourteen counties were without any. In the existing banks the average amount of a deposit was £4. 6s. 5d.

Gladstone's Bill, entitled "An Act to grant additional facilities for depositing small savings at interest, with the security of Government for the due repayment thereof," became law on the 17th of May 1861, and was brought into operation on the 16th of September following. The banks first opened were in places theretofore unprovided. In February 1862 the act was brought into operation in Scotland and in Ireland. Within two years nearly all the money order offices of the United Kingdom became savings banks, and the expansion of the business was continual. The growth of business is shown in the following table:—

Year ending 31st December.	Average Number of Accounts.	Average Amount of Deposits.	Average Balance in each Account.	Average Number of Offices.
1863-1868	663,000	7,000,000	£ s d 11 3 5	3,390
1869-1874	1,373,000	18,000,000	13 5 3	4,498
1875-1880	1,889,000	29,000,000	15 12 5	5,742
1881-1885	3,088,000	42,000,000	13 11 3	7,348
1886-1890	4,248,000	59,000,000	13 16 10	9,025
1891-1895	5,776,000	83,000,000	14 7 0	10,888

The code of the 1st of November 1888 did not enlarge the limits of deposits or make any great and conspicuous change in the general system, but the postmaster-general obtained power to offer certain facilities for the transfer of money from one account to another, for the easier disposal of the funds of deceased depositors by means of nominations, and in various ways for the convenience of the customers of the bank. Arrangements were made for reducing to 1s. the cost of certificates of births, deaths and marriages required for savings bank purposes. In July 1889 Local Loans 3% Stock was made available for purchase through the post office savings bank.

"In July 1891," says the report of the postmaster-general in 1897, "another Act of Parliament was passed by which the maximum amount which might be deposited was raised from £150 to £200, inclusive of interest. The annual limit remained at £30, but it was provided that, irrespective of that limit, depositors might replace in the bank the amount of any one withdrawal made in the same year. The object of this provision was to avoid curtailing the saving power of a person who might be driven by emergency to make an inroad upon his store, but who might nevertheless, when the emergency had passed, find himself none the poorer and able to replace the money withdrawn.

"The act provided also that where on any account the principal and interest together exceeded £200, interest should cease only on the amount in excess of £200, whereas previously interest ceased altogether when it had brought the balance of an account up to £200.

"The next striking development of the Savings Bank arose out of the Free Education Act, passed in September 1891. The

¹ For a succinct account of the history of the post office savings bank, "so far as depositors and the general public are concerned," see *Forty-third Report of Postmaster-General (1897)*, pp. 32 seq.

government of the day desired that advantage should be taken of the opportunity to inculcate upon parents and children alike a lesson of thrift—that they should save the school pence which they were no longer bound to pay. The Education Department and the postmaster-general worked in concert to realize this end. School managers were urged to press the matter upon all concerned, special stamp slips were prepared and issued, managers were supplied on credit with stocks of stamps to be sold to the children, and clerks from the nearest post offices attended at schools to open accounts and receive deposits. The arrangement began in January 1892; about 1400 schools adopted the scheme at once, and three years later this number had risen to 3000. A sum of nearly £14,000 was estimated to have been deposited in schools in 5 months, and about £40,000 in the first year. Concurrently with the spread of the stamp-slip system in the schools, the extension of School Penny Banks, connected intimately with the Savings Bank, was a conspicuous result of the effort to turn into profitable channels the pence which no longer paid school fees.

"In December 1893 another Act of Parliament extended the annual limits of deposits from £30 to £50. The maximum of £200 remained unchanged, but it was provided that any accumulations accruing after that amount had been reached should be invested in government stock unless the depositor gave instructions to the contrary.

"In December 1893 arrangements were made for the use of the telegraph for the withdrawal of money from the savings bank. Postmasters-general had hesitated long before sanctioning this new departure. It was known that the system was in force abroad, and it was recognized that there might be, and doubtless were, cases in the United Kingdom where the possibility of withdrawing money without delay might be all-important, and might save a depositor from debt and distress. But, on the other hand, it was strongly held that the cause of thrift was sometimes served by interposing a delay between a sudden desire to spend and its realization; and it was also held to be essential to maintain a marked distinction between a bank of deposit for savings and a bank for keeping current accounts."

On the whole, the balance of opinion was in favour of the change, and two new methods of withdrawal were provided. A depositor might telegraph for his money and have his warrant sent to him by return of post, or he might telegraph for his money and have it paid to him in an hour or two on the authority of a telegram from the savings bank to the postmaster. The first method cost the depositor about 9d., the second cost him about 1s. 3d. for the transaction. On the 3rd of July 1905 a new system of withdrawal was instituted, under which a depositor, on presentation of his book at any post office open for savings bank business, can withdraw immediately any sum not exceeding £1. Depositors have availed themselves extensively of this system. During 1906, 4,758,440 withdrawals, considerably more than one-half of the total number of withdrawals, were made "on demand," and as a consequence the number of withdrawals made by telegraph fell to 122,802, against 168,036 in the previous year (during only half of which the "on demand" system was in force).

By an act which came into force on the 1st of January 1895 building societies, duly incorporated, were enabled to deposit at any one time a sum not exceeding £300, and to buy government stock up to £500 through the savings bank.

Savings Bank Finance.—The increase in the deposits lodged in the post office savings bank must be ascribed to a variety of causes. Numbers of trustee banks have been closed, and have transferred their accounts to the post office bank; greater facilities have been offered by the bank; the limits of deposit in one year, and of total deposit, have been raised; and, since October 1892, deposits may be made by cheque; while the long-continued fall in the rate of interest made the assured 2½% of the post office savings bank an increasing temptation to a class of investors previously accustomed to look elsewhere. The high price of consols, due in part to the magnitude of purchases on savings bank account, proved a serious embarrassment to the profitable working of the bank, which had shown a balance of earnings on each year's working until 1896, after paying its expenses and 2½% interest to its depositors. Economical working minimized, but did not remove the difficulty. The average cost of each transaction, originally nearly 7d., has been brought down to 5½d. Down to the year 1896, £1,598,767 was paid into the exchequer under § 14 of the Act 40 Vict. c. 13, being the excess of interest which had accrued year by year. But since 1895 there have been deficits in each year, and in 1905, owing principally to the reduced rate on consols, the expenditure exceeded the income by £88,094.

The central savings bank having outgrown its accommodation in Queen Victoria Street, London, a new site was

purchased in 1898 for £45,000 at West Kensington, and the foundation-stone of a new building, costing £300,000, was laid by the prince of Wales on the 24th of June 1899. The entire removal of the business was carried out in 1903.

Under the Workmen's Compensation Act of 1897, sums awarded as compensation might be invested in the post office savings bank. This arrangement proved so convenient that an act of 1900 authorized a similar investment of money paid into an English county court in ordinary actions at common law, and ordered to be invested for the benefit of an infant or lunatic. In 1906 a committee was appointed to go into the question as to whether the post office should provide facilities for the insurance of employers in respect of liabilities under the Workmen's Compensation Acts, but no scheme was recommended involving post office action either as principal or agent. Post offices, however, exhibit notices drawing attention to the liabilities imposed by the act of 1906, and sub-postmasters are encouraged to accept agencies in their private capacity for insurance companies undertaking this class of insurance.

Inducements to Thrift.—By arrangement with the war office in July 1893, the deferred pay of soldiers leaving the army was invested on their behalf in the post office savings bank, but it was found that the majority of the soldiers draw out practically the whole amount at once, and the experiment was discontinued in 1901. At the request of large employers of labour, an officer of the savings bank attends at industrial establishments on days when wages are paid, and large numbers of workmen have thus been induced to become depositors. The advantages of the savings bank appear to be now thoroughly appreciated throughout the United Kingdom, as shown by the following table:—

	On the 31st of December 1900.			
	Number of Depositors.	Total Amount to Credit of Depositors.	Average Amount to Credit of each Depositor.	Proportion of Depositors to Population.
England and Wales	7,685,317	£ 122,365,193	£. s. d. 15 18 5	1 in 4
Scotland	372,801	5,126,299	13 15 0	1 in 12
Ireland	381,865	8,058,153	21 2 1	1 in 12
Totals	8,439,983	135,549,645	16 1 3	1 in 5
On the 31st of December 1905.				
England and Wales	9,027,112	£ 135,668,450	£. s. d. 15 0 7	1 in 3·8
Scotland	451,627	6,205,339	13 14 10	1 in 10·4
Ireland	484,310	10,237,351	21 2 9	1 in 9·1
Totals	9,963,049	152,111,140	15 5 4	1 in 4·3

Between the foundation of the bank and the end of 1899, upwards of £648,000,000, inclusive of interest, was credited to depositors, of which £474,000,000 was withdrawn. There were 232,634,596 deposits, 81,804,509 withdrawals, 27,071,556 accounts opened, and 18,631,573 accounts closed. The cross-entries, or instances where the account is operated upon at a different office from that at which it was opened, amounted to 33%. It is chiefly in respect of this facility that the post office savings bank enjoys its advantage over the trustee savings bank. In 1905, 16,320,204 deposits were made, amounting to £42,300,617. In the same year the withdrawals numbered 7,155,283, the total sum withdrawn being £42,096,037. The interest credited to depositors was £3,567,206, and the total sum standing to their credit on the 31st of December 1900 was £152,111,140.

A classification of accounts opened for 3 months in 1896, and assumed to be fairly typical, showed the following results:—

Occupation as stated by Depositors in opening Account.	Percentage to Total.
Professional	1·55
Official	2·81
Educational	1·01
Commercial	3·88
Agricultural and fishing	1·83
Industrial	18·43
Railway, shipping and transport	2·96
Tradesmen and their assistants	8·14
Domestic service	8·61
Miscellaneous	0·37
Married women, spinsters and children	50·41

Women and children of all ranks are believed to be 60.59 of the total number of depositors.

The accounts open at the end of 1895 showed the following division of deposits:—

		Per cent.
Balances not exceeding	£50	36.1
Exceeding £50 and not exceeding	100	24.5
" 100 " " "	150	17.3
" 150 " " "	200	14.8
" 200 " " "		7.3
		100.0

The division according to number of accounts, in the same groups, was 90.8, 5.3, 2.2, 1.3 and 0.4 respectively.

Investments in Government Stock.—In September 1888 the minimum amount of government stock which might be purchased or sold through the post office savings bank was reduced from £10 to 1s., and it was also provided that any person who had purchased stock through the savings bank could, if he so desired, have it transferred to his own name in the books of the Bank of England. The act of 1893 raised the limit of stock to £200 in one year, and £500 in all; but any depositor might purchase stock, to replace stock previously sold, in one entire sum during that year. If a depositor exceeds the authorized limits of deposit in the post office savings bank, the excess is invested in stock by the post office on his behalf. The investments of depositors in government stock, however, have a tendency to decrease, and the sales, on the other hand, to increase, as will be seen from the following table:—

Year.	Investments.		Sales.		Average price of Consols.	No. of Depositors.	Total holding of Stock.
	No.	Amount.	No.	Amount.			
1901	46,550	£3,192,154	13,574	£761,629	94½	109,509	£12,786,190
1902	40,893	2,694,447	17,221	1,054,193	94½	118,696	14,285,617
1903	47,726	3,131,172	17,742	1,085,578	90½	131,343	16,165,548
1904	39,633	2,507,546	18,848	1,131,543	88½	138,582	17,357,950
1905	32,301	2,212,285	22,824	1,507,219	89½	139,992	17,877,644

Annuities and Life Insurances.—The act of 1882, which came into operation on the 3rd of June 1884, utilized the machinery of the post office savings bank for annuities and life insurances, which had been effected through the post office at selected towns in England and Wales since the 17th of April 1865. Under the act of 1882 all payments were to be made by means of money deposited in the savings bank, and an order could be given by a depositor that any sum—even to 1d. a week—should be devoted to the purchase of an annuity or insurance so long as he retained a balance in the savings bank. In February 1896 new life insurance tables came into operation, with reduced annual rates, and with provision for payment of sums insured at various ages as desired. The following table shows the business done from 1901 to 1905:—

Year.	ANNUITIES.										LIFE INSURANCES.								
	Immediate.					Deferred.					Contracts entered into.			Receipts.			Payments.		
	Contracts entered into.		Receipts.	Payments.		Contracts entered into.		Receipts.	Payments.		No.	Amount of Insurances.	Receipts.		Payments.				
	No.	Amount of Annuities.	Amount.	No.	Amount.	No.	Amount of Annuities.	No.	Amount.	No.			Amount.	No.	Amount.	No.	Amount of claims on death and surrender.		
1901	1,764	£42,268	£562,159	33,269	£527,371	142	£3,066	1,365	£23,630	1,075	£14,175	920	£44,296	21,972	£22,647	380	£12,992		
1902	1,679	42,791	558,770	34,375	548,251	139	2,973	1,353	21,764	1,164	17,172	722	34,646	22,553	23,045	389	14,646		
1903	1,763	43,973	557,981	35,463	571,904	157	3,424	1,366	24,489	1,210	14,689	592	31,413	22,672	23,063	387	13,126		
1904	1,768	41,000	520,538	36,607	594,502	128	2,492	1,366	21,011	1,297	16,167	517	28,629	22,323	23,031	465	16,878		
1905	1,840	45,488	573,205	37,686	614,406	158	3,204	1,386	24,287	1,347	16,965	741	37,011	21,836	23,376	449	15,593		

TELEGRAPHS AND TELEPHONES

The history of the development of telegraphy and the early proposals for the transference to the state of the telegraph monopoly will be found in the article TELEGRAPHY.

Telegraphs. On the 5th of February 1870 the Telegraph Act of the previous year took effect. The post office assumed control of telegraphic communication within the United Kingdom, and it became possible to send telegrams throughout the country at a uniform charge irrespective of locality or distance. In 1885 sixpenny telegrams were introduced. The charge for a written telegram which came into force in 1870 was one shilling for the first twenty words, and threepence for every

additional five words, the addresses of sender and receiver being sent free. In 1885 the charge was reduced to a halfpenny a word throughout, including addresses (a system of abbreviated addresses, which could be registered on payment of a guinea a year, being introduced), with a minimum charge of sixpence. To obviate the damage and interruption resulting from storms large numbers of wires have been laid underground.

In 1891 the terms under which a new telegraph office was opened, on the request of a person or persons who undertook to guarantee the post office against loss, were reduced. In 1892 rural sanitary authorities were empowered to give such guarantees out of the rates. In 1897, as part of the Jubilee concessions, the government undertook to pay one-half of any deficiency under guarantees. During the six years ended in 1891 the average number of telegraph offices guaranteed each year was 77. From 1892 to 1897 the average rose to 167. In 1905 and 1906 it amounted to 152. The number of telegraph offices opened without guarantee has increased apace, and there are now 12,993 telegraph offices in all. As part of the Jubilee scheme the charges for portage were reduced as follows: Up to 3 miles free; beyond 3 m., 3d. per m., reckoned from the post office; and arrangements were made for the free delivery at all hours of the day or night of any telegram within the metropolitan postal district. The cost of free delivery up to 3 m. was estimated at £52,000 a year.

Foreign Telegrams.—The sixth international telegraph conference, held at Berlin in 1884, effected a reduction in the charges to many countries. *E.g.* the rate per word was reduced for Russia from 9d. to 6½d., Spain 6d. to 4½d., Italy 5d. to 4½d., and India 4s. 7d. to 4s. The cost of repeating a message was reduced from one-half to one-fourth of the original charge for transmission. At the next conference (1890) held at Paris, further considerable reductions were effected. The rates to Austria-Hungary and Italy were reduced from 4½d. to 3d., Russia 6½d. to 5½d., Portugal 5½d. to 4½d., Sweden 5d. to 4d., Spain 4½d. to 4d., Canary Islands 1s. 7½d. to 1s., &c. The minimum charge for any foreign (European) telegram was fixed at 10d. The eighth conference (Budapest, 1896) succeeded in making the following reductions, among others, from the United Kingdom: China 7s. to 5s. 6d., Java 6s. to 5s., Japan 8s. to 6s. 2d., Mauritius 8s. 9d. to 5s., Persia 2s. 5d. to 1s. 9d. At this conference it was made incumbent upon every state adhering to the union to fix in its currency an equivalent approaching as nearly as possible the standard rate in gold, and to correct and declare the equivalent in case of any important fluctuation.

The limit of letters in one word of plain language was raised from 10 to 15, and the number of figures from 3 to 5. The International Telegraph Bureau was also ordered to compile an enlarged official vocabulary of code words, which it is proposed to recognize as the sole authority for words which may be used in cypher telegrams sent by the public. (See Appendix to *Postmaster-General's Report*, 1897.) See further TELEGRAPH.

Ten years of state administration of the telegraphs had not passed before the postmaster-general was threatened with a formidable rival in the form of the telephone, which assumed a practical shape about the year 1878, the first exchange in the United Kingdom being established in

the City of London in that year. The history of the telephone service and the growth of the industry are set out in the article TELEPHONE.

POST OFFICE STAFF

The staff of the post office on the 31st of March 1906 amounted to 195,432. Of these 41,081 were women, a proportion of over one-fifth of the staff. The postmasters numbered 875 (including 10 employed abroad), and the sub-postmasters 21,027.

preference was given to army, navy and royal marine pensioners, and men of the army reserve. Due regard was paid to the legitimate claims of telegraph messengers or other persons who had prospects of succeeding to these situations. In August 1897 the government decided to reserve one-half of all suitable vacancies for ex-soldiers and sailors, as postmen, porters and labourers, and preference has been shown to them for employment as lift-attendants, caretakers, &c.

Finance.—The following table shows the financial working of the post office:—

Year.	Revenue.				Expenditure.								Net Revenue.	
	Postal Receipts.	Extra Receipts.	Estimated Value of Services to other Departments.	Total.	Sites and Buildings.		Superannuations and other Non-effective Charges.	Salaries, Wages, &c.	Conveyance of Mails.	Packet Service.	Other Expenditure.			Total.
					Purchase.	Erection.					Under P. O. Votes.	Under other Votes.		
1884-1885	£ 7,808,911	£ 382,002	£ 198,336	£ 8,389,249	£ 72,464	£ 80,234	£ 150,742	£ 2,829,210	£ 1,154,211	£ 728,413	£ 515,892	£ 136,999	£ 5,668,165	£ 2,721,084
1889-1890	9,467,165	36,279	218,037	9,721,481	70,900	79,840	53,021	3,359,563	1,249,821	664,342	553,910	142,788	6,275,085	3,446,396
1894-1895	10,748,014	—	277,446	11,025,460	12,597	175,390	188,919	4,597,355	1,395,282	729,813	677,524	178,464	7,955,344	3,070,116
1899-1900	13,192,020	—	202,315	13,394,335	115,294	169,008	269,092	5,963,399	2,474,118	759,307	719,944	213,747	9,683,009	3,710,336
1900-1901	13,776,886	—	218,584	13,995,470	81,949	175,000	286,238	6,277,275	1,516,859	764,804	726,101	236,677	10,064,903	3,030,567
1905-1906	16,823,349	24,363	216,311	17,064,023	75,759	250,127	377,131	7,737,010	1,821,758	687,109	604,927	295,191	11,849,012	5,540,897

The total number of offices (including branch offices) was 22,088. The unestablished staff, not entitled to pension, made up chiefly of telegraph boys, and of persons who are employed for only part of the day on post office business, included 87,753 out of the grand total, and almost the whole of the sub-postmasters. The pay and prospects of almost all classes have been greatly improved since 1884, when the number stood at 91,184. The principal schemes of general revision of pay have been: 1881, Fawcett's scheme for sorting-clerks, sorters and telegraphists (additional cost £210,000 a year), and for postmen, 1882, £110,000; Raikes's various revisions, 1888, chief clerks and supervising officers, £6230; 1890, sorting-clerks, sorters and telegraphists, £179,600; 1890, supervising force, £65,000; 1890, London sorters, £20,700; 1891, London overseers, £9400; 1891, postmen, £125,650; Arnold Morley, 1884, London overseers, £1400, and rural auxiliaries, £20,000.

A committee was appointed in June 1895 with Lord Tweedmouth as chairman, to consider the pay and position of the post office staff, excluding the clerical force and those employed at headquarters. The committee reported on the 15th of December 1896 and its recommendations were adopted at an immediate increased expense of £139,000 a year, which has since risen to £500,000. In 1897 additional concessions were made at a cost of £100,000 a year.

In July 1890 a number of postmen in London went out on strike. Over 450 were dismissed in one morning, and the work of the post office was carried on without interruption. The men received no sympathy from the public, and most of them were ultimately successful in their plea to be reinstated. A quasi-political agitation was carried on during the general election of 1892 by some of the London sorters, who, under the plea of civil rights, claimed the right to influence candidates for parliament by exacting pledges for the promise of parliamentary support. The leaders were dismissed, and the post office has upheld the principle that its officers are to hold themselves free to serve either party in the State without putting themselves prominently forward as political partisans. Parliament has been repeatedly asked to sanction a parliamentary inquiry to reopen the settlement of the Tweedmouth Committee, and the telegraphists have been especially active in pressing for a further committee. The rates of pay at various dates since 1881 are set out with great fullness in the Parliamentary papers (*Postmen*, No. 237 of 1897; *Sorters, Telegraphists, &c.*, No. 230 of 1898, and *Report of the Select Committee on Post Office Servants*, 1907; this latter contains important recommendations for the removal of many grievances which the staff had been long agitating to have removed).

In November 1891 an important change was made in the method of recruiting postmen, with the object of encouraging military service, and providing situations for those who after serving in the army or navy are left without employment at a comparatively early age. In making appointments to the situation of postman,

POSTAGE STAMPS

For all practical purposes the history of postage stamps begins in the United Kingdom. A post-paid envelope was in common use in Paris in the year 1653. Stamped postal letter-paper (*carta postale bollata*) was issued to the public by the government of the Sardinian States in November 1818, and stamped postal envelopes were issued by the same government from 1820 until 1836.¹ Stamped wrappers for newspapers were made experimentally in London by Charles Whiting, under the name of "go-frees," in 1830. Four years later (June 1834), and in ignorance of what Whiting had already done, Charles Knight, the well-known publisher, in a letter addressed to Lord Althorp, then chancellor of the exchequer, recommended similar wrappers for adoption. From this suggestion apparently Rowland Hill, who is justly regarded as the originator of postage stamps, got his idea. Meanwhile, however, the adhesive stamp was made experimentally by James Chalmers in his printing-office at Dundee in August 1834.² These experimental stamps were printed from ordinary type, and were made adhesive by a wash of gum. Chalmers had already won local distinction by his successful efforts in 1822, for the acceleration of the Scottish mails from London. Those efforts resulted in a saving of forty-eight hours on the double mail journey, and were highly appreciated in Scotland.

Rowland Hill brought the adhesive stamp under the notice of the commissioners of post office inquiry on the 13th of February 1837. Chalmers made no public mention of his stamp of 1834 until November 1837.

Rowland Hill's pamphlet led to the appointment of a committee of the House of Commons on the 22nd of November 1837, "to inquire into the rates and modes of charging postage, with a view to such a reduction thereof as may be made without injury to the revenue." This committee reported in favour of Hill's proposals; and an act was passed in 1839, authorizing the treasury to fix the rates of postage, and regulate the mode of their collection, whether by prepayment or otherwise. A premium of £200 was offered for the best, and £100 for the next best, proposal for bringing stamps into use, having regard to

¹ *Stamp-Collector's Magazine*, v. 161 seq.; J. E. Gray, *Illustrated Catalogue of Postage Stamps*, 6th ed., 167.

² Patrick Chalmers, *Sir Rowland Hill and James Chalmers, Inventor of the Adhesive Stamp* (London, 1882), *passim*. See also the same writer's pamphlet, entitled *The Position of Sir Rowland Hill made plain* (1882), and his *The Adhesive Stamp: a Fresh Chapter in the History of Post-Office Reform* (1881). Compare Pearson Hill's tract, *A Paper on Postage Stamps*, in reply to Chalmers, reprinted from the *Philatelic Record* of November 1881. Pearson Hill has therein shown conclusively the priority of publication by Sir Rowland Hill. He has also given proof of James Chalmers's express acknowledgment of that priority. But he has not weakened the evidence of the priority of invention by Chalmers.

"(1) the convenience as regards the public use; (2) the security against forgery; (3) the facility of being checked and distinguished at the post office, which must of necessity be rapid; and (4) the expense of the production and circulation of the stamps." To this invitation 2600 replies were received, but no improvement was made upon Rowland Hill's suggestions. A further Minute, of the 26th of December 1839, announced that the treasury had decided to require that, as far as practicable, the postage of letters should be prepaid, and such prepayment effected by means of stamps. Stamped covers or wrappers, stamped envelopes, and adhesive stamps were to be issued by government. The stamps were engraved by Messrs Perkins, Bacon & Petch, of Fleet Street, from Hill's designs, and the Mulready envelopes and covers by Messrs Clowes & Son, of Blackfriars. The stamps were appointed to be brought into use on the 6th of May 1840, but they appear to have been issued to the public as early as the 1st of May. The penny stamp, bearing a profile of Queen Victoria, was coloured black, and the twopenny stamp blue, with check-letters in the lower angles (in all four angles from April 1858). Up to the 28th of January 1854 the stamps were not officially perforated, except in the session of 1851, when stamps, perforated by a Mr Archer, were issued at the House of Commons post office. In 1853 the government purchased Archer's patent for £4000. The stamps were first water-marked in April 1840.

The canton of Zürich was the first foreign state to adopt postage stamps, in 1843. The stamps reached America in the same year, being introduced by the government of Brazil. That of the United States did not adopt them until 1847; but a tentative issue was made by the post office of New York in 1845. An adhesive stamp was also issued at St Louis in the same year, and in Rhode Island in the next. In Europe the Swiss cantons of Geneva (1844) and of Basel (1845) soon followed the example set by Zürich. In the Russian Empire the use of postage stamps became general in 1848 (after preliminary issues at St Petersburg and in Finland in 1845). France issued them in 1849. The same year witnessed their introduction into Tuscany, Belgium and Bavaria, and also into New South Wales. Austria, Prussia, Saxony, Spain, Italy, followed in 1850. The use of postage stamps seems to have extended to the Hawaiian Islands (1851?) a year before it reached the Dutch Netherlands (1852). Within twenty-five years of the first issue of a postage stamp in London, the known varieties, issued in all parts of the world, amounted to 1391. Of these 841 were of European origin, 333 were American, 59 Asiatic, 55 African. The varieties of stamp issued in the several countries of Oceania were 103. Of the whole 1391 stamps no less than 811 were already obsolete in 1865, leaving 580 still in currency.

ENGLISH ISSUES

(i.) *Line-engraved Stamps.*

Halfpenny Stamp.—First issue, October 1, 1870: size 18 mm. by 14 mm.; lake-red varying to rose-red.

One Penny Stamp.—*First issue*, 1st (for 6th) May 1840: the head executed by Frederick Heath, from a drawing by Henry Corbould of William Wyon's medal struck to commemorate her majesty's visit to the City of London on the 9th of November 1837: size 22½ mm. by 18½ mm.; black, watermarked with a small crown; a few sheets in 1841 struck in red, two essays were made in April and October 1840 in blue and blue-back; imperforate. The *second issue*, January 20, 1841, differed only from the first issue as to colour—red instead of black. It is stated¹ that the colour, "though always officially referred to as 'red,' was really a red-brown, and this may be regarded as the normal colour; but considerable variations in tone and shade (brick-red, orange-red, lake-red) occurred from time to time, often accentuated by the blueing of the paper, though primarily due to a want of uniformity in the method employed for preparing the ink." The change of colour from black was made in order to render the obliteration (now in black instead of red ink) more distinct; imperforate. *Third issue*, February 1854: small crown watermark; perforated 16 (i.e. 16 holes to 2 centimetres). The *fourth issue*, January 1855, differed only from the third issue in being perforated 14. *Fifth issue*, February 1855: from a new die, with minute variations of engraving. In the second die the eyelid is more distinctly shaded, the nostril more curved, and the band round the hair has a thick dark line forming its lower edge. Small crown watermark; perforated 16 and 14. *Sixth issue*, July 1855: large crown watermark; perforated 14; a certain number 16. *Seventh issue*, January 1858: carmine-rose varying from pale to very deep. Large crown watermark; perforated, chiefly 14. *Eighth issue*, April 1, 1864:

check-letters in all four corners instead of two only; large crown watermark; perforated 14.

In 1880 the line-engraved one penny stamps were superseded by the surface-printed one of similar value in venetian red, designed and printed by Messrs De la Rue & Co.

Three-halfpenny Stamp.—October 1, 1870: large crown watermark; lake-red; perforated 14. Superseded in October 1880 by De la Rue's surface-printed stamp.

Twopenny Stamp.—*First issue*, 1st (for 6th) May 1840: small crown watermark; light blue, dark blue; imperforate. *Second issue*, March 1841: small crown watermark; white line below "Postage" and above "Twopence"; dull to dark blue; imperforate. *Third issue*, February (?) 1854: small crown watermark; blue, dark blue; perforated 16. *Fourth issue*, March 1855: small crown watermark; blue, dark blue; perforated 14. *Fifth issue*, July 1855: large crown watermark; blue; perforated 16; blue, dark blue; perforated 14. *Sixth issue*, May (?) 1857: large crown watermark; white lines thinner, blue, dark blue; perforated 14; dark blue; perforated 16. *Seventh issue*, July 1858: large crown watermark; white lines as in fifth issue; deep to very deep blue; perforated 16. *Eighth issue*, April (?) 1869: large crown watermark; white lines thinner; dull blue, deep to very deep blue, violet blue; perforated 14. Superseded in December 1880 by De la Rue's surface-printed stamp.

(ii.) *Embossed Stamps.*

Produced by Dryden Brothers, of Lambeth, from designs submitted by Mr Ormond Hill of Somerset House, engraved after Wyon's medal.

Sixpence.—March 1, 1854: violet, reddish lilac, dark violet; imperforate. Superseded in October 1856 by De la Rue's surface-printed stamp.

Tenpence.—November 6, 1848: pale to very deep chestnut-brown; imperforate. Superseded by De la Rue's surface-printed stamp in 1867.

One Shilling.—September 11, 1847: emerald green, pure deep green, yellow-green; imperforate. Superseded in November 1856 by De la Rue's surface-printed stamp.

(iii.) *Surface-printed Stamps before 1880.*

Twopence-half-penny.—*First issue*, July 1, 1875: small anchor watermark; lilac-rose; perforated 14. *Second issue*, May 1876: orb watermark; lilac-rose, perforated 14. *Third issue*, February 5, 1880: orb watermark; cobalt, and some ultramarine; perforated 14. *Fourth issue*, March 23, 1881: large crown watermark; bright blue; perforated 14.

Threepence.—All perforated 14. *First issue*, May 1, 1862: heraldic emblems watermark; carmine (pale to deep). *Second issue*, March 1, 1865: same watermark as above; carmine-pink. *Third issue*, July 1867: watermarked with a spray of rose; carmine-pink, carmine-rose. *Fourth issue*, July 1873: watermark as third issue; carmine-rose. *Fifth issue*, January 1, 1881: watermark large crown; carmine-rose. *Sixth issue*, January 1, 1883: watermark as fifth issue; purple shades overprinted with value in deep pink.

Fourpence.—All perforated 14. *First issue*, July 31, 1855: watermark small garter; deep and dull carmine. *Second issue*, February 1856: watermark medium garter; pale carmine. *Third issue*, November 1, 1856: watermark medium garter; dull rose. *Fourth issue*, January 1857: watermark large garter; dull and pale to deep rose, pink. *Fifth issue*, January 15, 1862: watermark large garter; carmine-rose, vermilion-red. *Sixth issue*, July 1865: watermark large garter; pale to dark vermilion. *Seventh issue*, March 1, 1876: watermark large garter; pale vermilion. *Eighth issue*, February 27, 1877: watermark large garter; pale sage-green. *Ninth issue*, July 1880: watermark large garter; mouse-brown. *Tenth issue*, January 1, 1881: watermark large crown; mouse-brown.

Sixpence.—All perforated 14. *First issue*, October 21, 1856: no letters in angles; watermark heraldic emblems; dull lilac. *Second issue*, December 1, 1862: small white letters in angles; otherwise as first issue. *Third issue*, April 1, 1865: large white letters in angles; otherwise as first issue. *Fourth issue*, June 1867: watermark spray of rose; otherwise as third issue; some in bright lilac. *Fifth issue*, March 1869: as fourth issue; lilac, deep lilac, purple-lilac. *Sixth issue*, April 1, 1872: as fourth issue; bright chestnut-brown. *Seventh issue*, October 1872: as fourth issue; buff. *Eighth issue*, April 1873: as fourth issue; greenish grey. *Ninth issue*, April 1, 1874: watermarked as fourth issue; large coloured letters in angles; greenish grey. *Tenth issue*, January 1, 1881: large crown watermark; otherwise as ninth issue. *Eleventh issue*, January 1, 1883: as tenth issue; purple, overprinted with value in deep pink.

Eightpence.—September 11, 1876: watermark large garter; chrome-yellow, pale yellow; perforated 14.

Ninepence.—All perforated 14. *First issue*, January 15, 1862: watermark heraldic emblems; ochre-brown, bright bistre. *Second issue*, December 1, 1865: watermark as above; bistre-brown, straw. *Third issue*, October 1867: watermark spray of rose; straw.

Tenpence.—July 1, 1867: watermark spray of rose; red-brown; perforated 14.

¹ Wright and Creeke, *History of the Adhesive Stamp of the British Isles available for Postal and Telegraph Purposes* (London, 1899).

One Shilling.—All perforated 14. *First issue*, November 1, 1856: watermark heraldic emblems; no letters in angles; dull green, pale to dark green. *Second issue*, December 1, 1862: as above; small white letters in angles; pale to dark green. *Third issue*, February 1865: as above; large white letters in angles; pale to dark green, bluish green. *Fourth issue*, August 1867: watermark spray of rose; otherwise as third issue; pale to dark green, bluish green. *Fifth issue*, September 1873: large coloured letters in angles; otherwise as fourth issue; light to dark green, bluish green. *Sixth issue*, October 14, 1880: as fifth issue; pale red-brown. *Seventh issue*, June 15, 1881: watermark large crown; otherwise as sixth issue; pale red-brown.

Two Shillings.—Watermark spray of rose; perforated 14. *First issue*, July 1, 1867: pale to full blue, very deep blue. *Second issue*, February 1880: light brown.

Five Shillings.—*First issue*, July 1, 1867: watermarked with a cross *paté*; pink, pale rose; perforated 15½ by 15. *Second issue*, November 1882: watermark large anchor; carmine-pink; perforated 14.

Ten Shillings.—*First issue*, September 26, 1878: watermark cross *paté*; green-grey; perforated 15½ by 15. *Second issue*, February 1883: watermark large anchor; green-grey; perforated 14.

One Pound.—*First issue*, September 26, 1878: watermark cross *paté*; brown-violet; perforated 15½ by 15. *Second issue*, December 1882: watermark large anchor; brown-violet; perforated 14.

(iv.) After 1880.

In 1880–1881 the halfpenny, penny, three-halfpenny and two-penny surface-printed stamps superseded the line-engraved stamps of the same value, and a new surface-printed stamp of fivepence was introduced. These stamps are distinguished from the stamps already described by the absence of plate-numbers and (except in the penny stamp) of check-letters in the corners; also by the coarser style of engraving necessary for printing by machines driven by steam-power.

One Halfpenny.—*First issue*, October 14, 1880: large crown watermark; pale green, bluish green, dark green; perforated 14. *Second issue*, April 1, 1884: slate-blue.

One Penny.—January 1, 1880: large crown watermark; venetian red; perforated 14.

Three-halfpence.—October 14, 1880: large crown watermark; venetian red; perforated 14.

Twopence.—December 8, 1880: large crown watermark; pale to very deep carmine red; perforated 14.

Fivepence.—March 15, 1881: large crown watermark; dark dull indigo, indigo-black; perforated 14.

The Customs and Inland Revenue Act which came into force on June 1, 1881, made it unnecessary to provide separate penny stamps for postal and fiscal purposes. By an act of 1882 (45 & 46 Vict. c. 72) it became unnecessary to provide separate stamps for postal and fiscal purposes up to and including stamps of the value of 2s. 6d. A new series was therefore issued:—

One Penny.—All perforated 14. *First issue*, July 12, 1881: large crown watermark; 14 pearls in each angle; purple-lilac, purple. *Second issue*, December 12, 1881: as first issue; 16 pearls in each angle; purple.

Three-halfpence.—April 1, 1884: large crown watermark; purple; perforated 14.

Twopence.—Ditto.

Twopence-halfpenny.—Ditto.

Threepence.—Ditto.

Fourpence.—Ditto, except in colour (sea-green).

Fivepence.—As fourpence.

Sixpence.—Ditto.

Ninepence.—Ditto.

One Shilling.—Ditto.

Two Shillings and Sixpence.—July 22, 1883: watermark large anchor; purple, dull lilac, dark purple; perforated 14.

Five Shillings.—April 1, 1884: ditto; pale to very deep carmine.

Ten Shillings.—Ditto; pale blue, cobalt, light to dull blue.

One Pound.—*First issue*, April 1, 1884: large crown watermark, 3 appearing in each stamp; brown-violet; perforated 14. *Second issue*, January 27, 1891: same watermark; bright green; perforated 14.

Five Pounds.—March 21, 1882: large anchor watermark; orange-vermilion, vermilion, bright vermilion; perforated 14.

Following upon the report of a committee of officials of the General Post Office and Somerset House, a series of new stamps, commonly known as the "Jubilee" issue, was introduced on January 1, 1887, all of which between one halfpenny and one shilling exclusive were printed either in two colours or on a coloured paper, so that each stamp was printed in part in one or other of the doubly fugitive inks—green and purple.

One Halfpenny.—January 1, 1887: large crown watermark; orange-vermilion to bright vermilion; perforated 14.

Three-halfpence.—January 1, 1887: as the halfpenny; green and purple.

Twopence.—Ditto: green and scarlet to carmine.

Twopence-halfpenny.—January 1, 1887: blue paper; watermark large crown; dark purple; perforated 14.

Threepence.—January 1, 1887: yellow paper; watermarked with a large crown; purple; perforated 14.

Fourpence.—January 1, 1887: watermark and perforation as in threepence; green and brown.

Fourpence-halfpenny.—September 15, 1892: as the fourpence; green and carmine.

Fivepence.—January 1, 1887: as the fourpence; purple and blue.

Sixpence.—January 1, 1887: pale red paper; watermarked with a large crown; purple; perforated 14.

Ninepence.—January 1, 1887: large crown watermark; purple and blue; perforated 14.

Tenpence.—February 24, 1890: as the ninepence; purple and carmine-red.

One Shilling.—January 1, 1887: as the ninepence; green.

The various fiscal stamps admitted to postage uses, the over-printed official stamps for use by government departments, and the stamps specially surcharged for use in the Ottoman Empire, do not call for detailed notice in this article.

The distinctive telegraph stamps are as follows:—

One Halfpenny.—April 1, 1880: shamrock watermark; orange vermilion; perforated 14.

One Penny.—February 1, 1876: as the halfpenny; reddish brown.

Threepence.—Perforated 14. *First issue*, February 1, 1876: watermark spray of rose; carmine. *Second issue*, August 1881: watermark large crown; carmine.

Fourpence.—March 14, 1877: watermark large garter; pale sage-green; perforated 14.

Sixpence.—Perforated 14. *First issue*, March 1, 1877: watermark spray of rose; greenish-grey. *Second issue*, July 1881: as first issue; watermark large crown.

One Shilling.—Perforated 14. *First issue*, February 1, 1876: watermark spray of rose; green. *Second issue*, October 1880: watermark spray of rose; pale red-brown. *Third issue*, February 1881: watermark large crown; pale red brown.

Three Shillings.—Perforated 14; slate blue. *First issue*, March 1, 1877: watermark spray of rose. *Second issue*, August 1881: watermark large crown.

Five Shillings.—*First issue*, February 1, 1876: watermark cross *paté*; dark to light rose; perforated 15 by 15½. *Second issue*, August 1881: watermark large anchor; carmine-rose; perforated 14.

Ten Shillings.—March 1, 1877: watermark cross *paté*; green-grey; perforated 15 by 15½.

One Pound.—March 1, 1877: watermark shamrock; brown-purple; perforated 14.

Five Pounds.—March 1, 1877: watermark shamrock; orange-vermilion; perforated 15½ by 15.

In addition to these, there were stamps specially prepared for the army telegraphs.

BRITISH COLONIES AND DEPENDENCIES

Australian Commonwealth.—In 1905 there were 6654 post offices open; 311,401,539 letters and cards, 171,844,868 newspapers, book-packets and circulars, 2,168,810 parcels, and 13,680,239 telegrams were received and despatched; the revenue was £2,738,146 and the expenditure £2,720,735.

New Zealand.—In 1905 there were 1937 post offices open; 74,767,288 letters and cards, 47,334,263 newspapers, book-packets and circulars, 392,017 parcels, and 5,640,219 telegrams were dealt with. The revenue from the post office was £410,968, and from telegraphs £273,911, while the expenditure on the post office was £302,146 and on telegraphs £276,581.

Dominion of Canada.—In 1905 there were 10,879 post offices open; 331,792,500 letters and cards, 60,405,000 newspapers, book-packets and circulars, and 58,338 parcels were received and despatched. The revenue from the post office amounted to £1,053,548, and from telegraphs £28,727, while the expenditure was, on the post office £952,652 and on telegraphs £78,934.

Cape of Good Hope.—The number of post offices open in 1905 was 1043; 7,506,600 letters and cards, 3,706,960 newspapers, book-packets and circulars, 536,800 parcels, and 6,045,228 telegrams were dealt with. The revenue from the post office was £423,056, and from telegraphs £206,842 the expenditure being, £456,171 on the post office and £272,863 on telegraphs.

British India.—In 1905 there were 16,033 post offices open; 597,707,867 letters and cards, 76,671,197 newspapers, book-packets and circulars, 4,541,367 parcels, and 9,098,345 telegrams were dealt with. The revenue from the post office was £1,566,704 and from telegraphs £733,193, while the expenditure was, on the post office, £1,199,557 and on telegraphs £546,914.

FRANCE

The French postal system was founded by Louis XI. (June 19, 1464), was largely extended by Charles IX. (1565), and received considerable improvements at various *Early History.* periods under the respective governments of Henry IV. and Louis XIII. (1603, 1622, 1627 seq.).¹

In 1627 France originated a postal money-transmission system, a system of cheap registration for letters. The postmaster who thus anticipated modern improvements was Pierre d'Alm ras, a man of high birth, who gave about £20,000 (of modern money) for the privilege of serving the public. The turmoils of the Fronde wrecked much that he had achieved. The first farm of postal income was made in 1672, and by farmers it was administered until June 1790. To increase the income postmaster-ships for a long time were not only sold but made hereditary. Many administrative improvements of detail were introduced, indeed, by Mazarin (1643), by Louvois (c. 1680 seq.), and by Cardinal de Fleury (1728); but many formidable abuses also continued. The revolutionary government transferred rather than removed them. Characteristically, it put a board of postmasters in room of a farming postmaster-general and a controlling one. Napoleon (during the consulate²) abolished the board, recommitted the business to a postmaster-general as it had been under Louis XIII., and greatly improved the details of the service; Napoleon's organization of 1802 is, in substance, that which now obtains, although, of course, large modifications and developments have been made from time to time.³

The university of Paris, as early as the 13th century, possessed a special postal system, for the abolition of which in the 18th it received a large compensation. But it continued to possess certain minor postal privileges until the Revolution.⁴

Mazarin's edict of the 3rd of December 1643 shows that France at that date had a parcel post as well as a letter post. That edict creates for each head post office throughout the kingdom three several officers styled respectively (1) comptroller, (2) weigher, (3) assessor; and, instead of remunerating them by salary, it directs the addition of one-fourth to the existing letter rate and parcel rate, and the division of the surcharge between the three. Fleury's edicts of 1728 make sub-postmasters directly responsible for the loss of letters or parcels; they also make it necessary that senders should post their letters at an office, and not give them to the carriers, and regulate the book-post by directing that book parcels (whether MS. or printed) shall be open at the ends.⁵ In 1758, almost eighty years after Dockwra's establishment of a penny post in London, an historian of that city published an account of it, which in Paris came under the eye of Claude Piarron de Chamouset,⁶ who obtained letters-patent to do the like, and, before setting to work or seeking profit for himself, issued a tract with the title, *M moire sur la petite-poste  tablie   Londres, sur la mod le de laquelle on pourrait en  tablir de semblables dans les plus grandes villes d'Europe.* The reform was successfully carried out.

By this time the general post office of France was producing

¹ For the details, see *Ency. Brit.*, 8th ed., xviii. 420-424, and Maxime Du Camp, "L'Administration des Postes," in *Revue des deux mondes* (1865), 2nd series, vol. lxxvii. 169 seq.

² 28 Pluiose, an XII. = the 18th of February 1804.

³ Le Quien de la Neufville, *Usages des postes* (1730), pp. 59-67, 80, 121-123, 147-149, 286-291; Maxime du Camp, *op. cit. passim*; Pierre Cl ment, *Appr ciation des cons quences de la r forme postale, passim*; Loret, *Gazette rim e* (Aug. 16, 1653); Fureti re, *Le Roman Bourgeois* (in Du Camp, *ut supra*); "Die ersten Posteinrichtungen, u.s.w.," in *L'Union postale*, viii. 138; *Ordonnances des Rois de France*, as cited by A. de Rothschild, *Histoire de la poste-aux-lettres* (3rd ed., 1876), i. 171, 216, 269. We quote M. de Rothschild's clever book with some misgivings. It is eminently sparkling in style, and most readable; but its citations are so given that one is constantly in doubt lest they be given at second or even at third hand instead of from the sources. The essay of M. du Camp is, up to its date, far more trustworthy. He approaches his subject as a publicist, M. de Rothschild as a stamp-collector.

⁴ There are several charters confirmatory of this original privilege. The earliest of these is of 1296 (Philip "the Fair").

⁵ *Ordonnances*, &c., as above.

⁶ There is an interesting biographical notice of Piarron de Chamouset in *Le Journal officiel* of July 5, 1875.

a considerable and growing revenue. In 1676 the farmers had paid to the king £48,000 in the money of that day. A century later they paid a fixed rent of £352,000, and covenanted to pay in addition one-fifth of their net profits. In 1788—the date of the last letting to farm of the postal revenue—the fixed and the variable payments were commuted for one settled sum of £480,000 a year. The result of the devastations of the Revolution and of the wars of the empire together is shown strikingly by the fact that in 1814 the gross income of the post office was but little more than three-fifths of the net income in 1788. Six years of the peaceful government of Louis XVIII. raised the gross annual revenue to £928,000. On the eve of the Revolution of 1830 it reached £1,348,000. Towards the close of the next reign the post office yielded £2,100,000 (gross). Under the revolutionary government of 1848-1849 it declined again (falling in 1850 to £1,744,000); under that of Napoleon III. it rose steadily and uniformly with every year. In 1858 the gross revenue was £2,296,000, in 1868 £3,596,000.

The ingenuity of the French postal authorities was severely tried by the exigencies of the German War of 1870-71. The first contrivance was to organize a pigeon service (see *Pigeon and Balloon Posts.*) carrying microscopic despatches prepared by the aid of photographic appliances.⁷ The number of postal pigeons employed was 363, of which number fifty-seven returned with despatches. During the height of the siege the English postal authorities received letters for transmission by pigeon post into Paris by way of Tours, subject to the regulations that no information concerning the war was given, that the number of words did not exceed twenty, that the letters were delivered open, and that 5d. a word, with a registration fee of 6d.,⁸ was prepaid as postage. At this rate the postage of the 200 letters on each folio was £40, that on the eighteen pellicles of sixteen folios each, carried by one pigeon, £11,520. Each despatch was repeated until its arrival had been acknowledged by balloon post; consequently many were sent off twenty and some even more than thirty times. The second step was to establish a regular system of postal balloons, fifty-one being employed for letter service and six for telegraphic service. To M. Durnouf belongs much of the honour of making the balloon service successful. On the basis of experiments carried out by him a decree of the 26th of September 1870 regulated the new postal system. Out of sixty-four several ascents, each costing on the average about £200, fifty-seven achieved their purpose, notwithstanding the building by Krupp of twenty guns, supplied with telescopic apparatus, for the destruction of the postal balloons. Only five were captured, and two others were lost at sea. The aggregate weight of the letters and newspapers thus acrially mailed by the French post office amounted to about eight tons and a half, including upwards of 3,000,000 letters; and, besides the aeronauts, ninety-one passengers were conveyed. The heroism displayed by the French balloon postmen was equalled by that of many of the ordinary letter-carriers in the conveyance of letters through the catacombs and quarries of Paris and its suburbs, and, under various disguises, often through the midst of the Prussian army. Several lost their lives in the discharge of their duty, in some cases saving their despatches by the sacrifice.⁹ During the war the Marseilles route for the Anglo-Indian mails was abandoned. They were sent through Belgium and Germany, by the Brenner Pass to Brindisi, and thence by Italian packets to Alexandria. The French route was resumed in 1872.¹⁰

⁷ The despatches carried by the pigeons were in the first instance photographed on a reduced scale on thin sheets of paper, the original writing being preserved, but after the ascent of the twenty-fifth balloon leaving the city an improved system was organized. The communications, whether public despatches, newspapers or private letters, were printed in ordinary type, and micro-photographed on to thin films of collodion. Each pellicle measured less than 2 in. by 1, and the reproduction of sixteen folio pages of type contained above 3000 private letters. These pellicles were so light that 50,000 despatches, weighing less than 1 gramme, were regarded as the weight for one pigeon. In order to ensure their safety during transit the films were rolled up tightly and placed in a small quill which was attached longitudinally to one of the tail feathers of the bird. On their arrival in Paris they were flattened out and thrown by means of the electric lantern on to a screen, copied by clerks, and despatched to their destination. This method was afterwards improved upon, sensitive paper being substituted for the screen, so that the letters were printed at once and distributed.

⁸ *Seventeenth Report of the Postmaster-General*, p. 7.

⁹ Boissay, "La Poste et la t l graphie pendant le si ge de Paris," in *Journal des  conomistes*, 3rd series, vol. xxii. pp. 117-129 and pp. 273-282. Cf. *Postal Gazette* (1883), i. 7.

¹⁰ *Sixteenth Report of the Postmaster-General*, p. 8.

The comparative postal statistics for all France during the years 1900 and 1905 stands thus:—

	1900.	1905.
	No.	No.
Letters	980,629,000	1,113,090,000
Post-cards	62,591,000	450,889,000
Newspapers, printed matter, samples, circulars, &c.	1,390,246,000	1,441,713,000
Value of money } French francs	1,422,736,000	1,834,360,000
orders } Internatl. „	56,210,000	73,229,000
Value of postal orders	40,688,000	54,582,000
Receipts } £	209,982,000	261,454,000
	8,399,000	10,458,000

The savings banks system of France, so far as it is connected with the postal service, dates only from 1875, and began then (at first) simply by the use of post offices as agencies and feeders for the pre-existing banks. Prior to the postal connexion the aggregate of the deposits stood at £22,920,000. In 1877 it reached £32,000,000. Postal savings banks, strictly so called, began only during the year 1881. At the close of 1882 they had 210,712 depositors, with an aggregate deposit of £1,872,938 sterling; in 1905 they had 12,134,523 depositors, with an aggregate deposit of £229,094,155.

The union of the telegraph with the post office dates only from 1878. The following table gives the figures for 1900 and 1905:—

	1900.	1905.
Length of line		
{ kilometres	117,559	129,826
{ miles	73,004	80,622
Length of wire		
{ kilometres	388,814	418,331
{ miles	241,453	259,784
Total gross receipts } francs	43,977,000	46,490,000
	£ 1,759,000	£ 1,860,000
Number of messages forwarded:		
Home service	36,723,000	39,433,000
International	3,374,000	3,686,000
Amount of International telegraphic money orders:		
From foreign countries to France (Total francs)	6,145,455	10,239,546
From France to foreign countries (Total francs)	6,124,913	4,754,960

The postal telephonic system began in 1879. The following table gives the figures for 1901 and 1905:—

	1901.	1905.
Length of line		
{ kilometres	30,142	46,992
{ miles	18,718	29,182
Length of wire		
{ kilometres	453,287	498,389
{ miles	281,491	309,500
Messages	175,340,000	232,727,645
Receipts		
{ francs	17,518,000	23,495,000
{ £	701,000	940,000

BIBLIOGRAPHY.—P. d'Alméra, *Règlement sur le port des lettres* (1627); Le Quien de la Neufville, *Usages des postes* (1730); Rowland Hill, *Report to the Chancellor of the Exchequer on the French Post Office* (1837); *Annuaire des postes* (from 1850—); M. du Camp, "De L'administration . . . et de l'hôtel des postes," in *Revue des deux mondes* (1865), 3rd series; *Revue des postes et télégraphes* (pub. at various periods); A. de Rothschild, *Histoire de la poste aux-lettres* (1875); "Entwicklung des Post- u. Telegraphenwesens in Frankreich," in *Archiv f. Post. u. Telegraphie* (1882); "Die französischen Postsparkassen," and other articles, in *L'Union postale* (Berne).

AUSTRIA-HUNGARY

The Austrian postal system is among the oldest on record. Vienna possessed a local letter post and a parcel post, on the plan of prepayment, as early as May 1772, at which date no city in Germany possessed the like. This local post was established by a Frenchman (M. Hardy) and managed by a Dutchman (Schooten).¹ Thirteen years after its organization it became merged in the imperial post. The separate postal organizations of the empire (Austria) and of the kingdom (Hungary) date from 1867. In Austria the post office and the telegraph office are

¹ Loeper, "Organisation des postes de ville," in *L'Union postale* vii. 1 seq.

placed under the control of the minister of commerce, in Hungary under that of the minister of public works. The following table gives the figures for 1900 and 1904:—

Austria.

	1900.	1904.
Post offices No.	6,895	8,327
Letters and post-cards	1,193,418,000	1,421,107,000
Newspapers	116,000,000	144,986,000
Packet post:		
Ordinary packets kilogs.	37,521,000	44,624,000
Registered packets } kronen	8,043,570,000	8,323,179,000
and letters } £	335,148,000	346,799,000
Receipts } kronen	107,718,000	123,919,000
	£ 4,488,000	£ 5,163,000
Expenses } kronen	98,412,000	121,749,000
	£ 4,100,000	£ 5,073,000

Hungary.

	1900.	1904.
Post offices No.	4,923	5,097
Letters, newspapers, &c.	487,670,000	584,081,000
Packet post:		
Ordinary packets	17,730,000	21,367,000
Packets with de- } korona	6,256,900,000	4,936,403,000
clared value and } £	260,704,000	205,683,000
money letters		
Reimbursements and } korona	1,095,591,000	1,253,440,000
money orders } £	45,649,000	52,226,000
Postal orders } korona	27,470,000	30,397,000
	£ 1,145,000	£ 1,266,000
Receipts } korona	47,103,000	57,067,000
	£ 1,962,000	£ 2,378,000
Expenses } korona	39,912,000	44,560,000
	£ 1,663,000	£ 1,857,000

GERMAN EMPIRE

The Prussian postal system developed mainly by the ability and energy of Dr Stephan, to whom the organization of the International Postal Union² was so largely indebted, into the admirably organized post and telegraph office of the empire—began with the Great Elector, and with the establishment in 1646 of a Government post from Cleves to Memel. Frederick II. largely extended it, and by his successor the laws relating to it were consolidated. In Strasburg a messenger code existed as early as 1443. A postal service was organized at Nuremberg in 1570. In 1803 the rights in the indemnity-lands (*Entschädigungsländer*) of the counts of Taxis as hereditary imperial postmasters were abolished. The first mail steam-packet was built in 1821; the first transmission of mails by railway was in 1847; the beginning of the postal administration of the telegraphs was in 1849; and, by the treaty of postal union with Austria, not only was the basis of the existing system of the posts and telegraphs of Germany fully laid, but the germ was virtually set of the International Postal Union. That treaty was made for ten years on the 6th of April 1850, and was immediately accepted by Bavaria. It came into full operation on the 1st of July following, and then included Saxony, Mecklenburg-Strelitz and Holstein. Other German states followed; and the treaty was renewed in August 1860.

The following table gives figures for 1900 and 1905:—

	1900.	1905.
Post offices No.	32,135	33,105
Letters received	2,893,555,000	3,855,369,000
Letters and parcels } received (value		
declared) } £	10,508,000	10,518,000
Parcels received (value not } No.	15,984,425	16,215,800
declared) } £	153,985,000	186,038,000
Postal orders re- } ceived	126,217,209	162,800,261.
	1000 marks	7,868,860
		9,807,934

² The International Postal Union was founded at Berne in 1874. All the countries of the world belong to it, with the exception of Afghanistan, Baluchistan, China, Abyssinia and Morocco. Congresses have been held at Paris (1878), Lisbon (1885), Vienna (1891), Washington (1897) and Rome (1906).

Telegraphs.¹

		1900.	1905.
Length of line	kilometres	108,500	117,738
	miles	67,378	73,115
of which under-ground	kilometres	10,969	11,460
	miles	6,812	7,117
Length of wire	kilometres	424,500	469,801
	miles	263,614	291,746
of which under-ground	kilometres	49,934	52,014
	miles	31,009	32,301
Number of offices open to the public		20,768	26,912
Receipts	Marks	33,065,590	39,592,009
	£	1,625,724	1,946,607
Number of messages:			
Home service		28,643,849	30,275,833
International		12,356,840	15,300,309

¹ Exclusive of Württemberg and Bavaria.

Telephones.

		1901.	1905.
Length of line	miles	59,460	85,450
Length of wire	"	731,174	1,672,415
Number of messages		766,226,337	1,207,400,000

BIBLIOGRAPHY.—Von Beust, *Versuch einer ausführlichen Erklärung des Postregals, . . . insbesondere in Anschauung d. h. röm. Reichs Teutscher Nation* (3 vols., Jena, 1747-1748); *Avis instructif au public . . . pour la petite poste [de Vienne]* (1772); *Ueber die kleine Post in Wien* (1780); A. Flegler, *Zur Gesch. d. Posten* (1858); Stephan, Hein. *Gesch. d. preuss. Post* (1859); Fischer, *Die Verkehrsanstalten des deutschen Reichs* (1873); Von Linde, *Haftverbindlichkeit d. Postanstalt*; W. Kompe, *Das Handelsgesetzbuch u. das Postrecht*; Gad, *Die Haftpflicht d. d. Postanstalten* (1863); Eug. Hartmann, *Entwicklungsgesch. d. Posten* (1868); P. D. Fischer, *Die d. Post- und Telegraphie-Gesetzgebung*; O. Dambach, *Das Gesetz über das Postwesen des deutschen Reichs* (1881); *Archiv f. Post u. Telegraphie*; F. X. von Neumann-Spallart, *Uebersichten über Verkehr in d. Weltwirtschaft*; *Deutsche Verkehrszeitung*; W. Lenz, *Katechismus d. d. Reichspost*.

ITALY

The origin of the Italian post office may be traced virtually to Venice and to the establishment of the "Corrieri di Venezia" early in the 16th century. As early as 1818 the Sardinian post office issued stamped letter-paper. The total number of letters, newspapers and book-packets conveyed in 1862 was but 111,733,319. In 1900 there were 7234 post offices; letters conveyed amounted to 180,349,449, post cards 82,544,547, newspapers, &c., 301,495,580, samples 9,117,526, official letters, franked, 46,302,121, postal packets 8,170,988, and registered letters of a declared value of £12,931,026. The receipts amounted to £2,429,000 and the expenses to £1,980,000.

UNITED STATES

The early history of the post office in the British colonies in North America has been referred to above. Benjamin Franklin was removed by the home department from his office of postmaster-general in America in 1774. On the 26th of July 1775 the American Congress assumed direction of the post offices, re-appointing Franklin to his former post. Shortly afterwards, when Franklin was sent as ambassador to France, his son-in-law, Richard Bache, was made postmaster-general in November 1775.

In 1789 the number of post offices was 75; in 1800, 903; in 1825, 5677; in 1875, 35,734; in 1885, 51,252; in 1890, 62,401; in 1895, 70,064; in 1900, 76,688; and in 1905, 68,131.

The following table gives the financial statements for a number of years:—

Year.	Extent of post routes in miles.	Revenue.	Expenditure.
1875	277,873	\$26,791,360	\$33,611,309
1880	343,888	33,315,479	36,542,804
1885	365,251	42,560,844	49,533,150
1890	427,991	60,882,097	65,930,717
1895	456,026	76,983,128	86,790,172
1900	500,982	102,354,579	107,740,268
1905	486,805	152,826,585	167,399,169

The revenue quoted does not include any allowance for the large quantity of official matter carried for other public departments, &c., indeed, the postmaster-general, in his *Report* for 1906, estimated that if the due allowance were made it would add approximately \$20,000,000 to the revenue. The post office department is compelled to carry anything sent under a penalty frank, and franks are used by all the departments and their agents for the purpose of carrying everything they choose to send (*Report*, postmaster-general, 1893). The expenditure does not include the amounts certified to the Treasury for the transportation of mails over aided Pacific railways, or any allowance for the use of such buildings as are provided by the government.

Contrary to expectations repeatedly expressed, each year shows a deficit. This is partly explained by reductions in charges. The rate of postage on first-class matter was reduced from three cents to two cents on the 1st of October 1883, and the unit of weight was increased from half an ounce to one ounce on the 1st of July 1885. On the latter date, also, the postage on second-class matter was reduced from two cents to one cent per pound. This low rate has led to wholesale violation of the purpose of the law. In his report for 1899 Mr Emory Smith, postmaster-general, estimated that "fully one-half of all the matter mailed as second-class, and paid for at the pound rate, is not properly second-class within the intent of the law"; and that the cost of mere transportation of this wrongly classed matter exceeded the revenue derived from it by more than \$12,000,000 for the year.

Until 1863 the rates of postage were based upon the distances over which the mails were conveyed. In 1846 these rates were—not exceeding 300 m., three cents; exceeding 300 m., ten cents. In 1851 the rates were reduced to three cents for distances not exceeding 3000 m. and ten cents for distances exceeding 3000 m. The use of adhesive postage stamps was first authorized by act of Congress, approved on the 3rd of March 1847, and on the 1st of June 1856 prepayment by stamps was made compulsory. In 1863 a uniform rate of postage without regard to distance was fixed at three cents, and on the 1st of October 1883, the rate was further reduced to two cents, the equivalent of the British penny postage.

All mail matter for distribution within the United States is divided into four classes. *First-class matter* includes letters, postal cards, post cards and anything sealed or closed against inspection. *Second-class matter* includes all newspapers and periodicals exclusively in print that have been "entered as second-class matter," and are regularly issued at stated intervals as frequently as four times a year from a known office of publication and mailed by publishers or newsagents to actual subscribers or to newsagents for sale, and newspapers and publications of this class mailed by persons other than publishers. The rates of postage to publishers are one cent a pound, and to other than publishers, one cent for each four ounces. *Third-class matter* includes printed books, pamphlets, engravings and circulars in print or reproduced by a copying process. The rate for third-class matter is one cent for each two ounces. *Fourth-class matter* is all mailable matter not included in the three preceding classes which is so prepared for mailing as to be easily withdrawn from the wrapper and examined. The rate is one cent for each ounce.

The franking privilege, which had grown to be an intolerable abuse, was temporarily abolished in 1873, but the post office now carries free under official "penalty" labels or envelopes (i.e. envelopes containing a notice of the legal penalty for their unauthorized use) matter which is of an official character, the privilege being extended to congressmen and government officials (see FRANKING). As late as 1860 the mails conveyed nothing but written and printed matter. They now admit nearly every known substance which does not exceed four pounds in weight (this restriction does not apply to single books), and which from its nature is not liable to injure the mails or the persons of postal employés.

A delivery system existed in a number of cities of the Union in 1862, the carriers remunerating themselves by the collection of a voluntary fee of from one to two cents on each piece of mail delivered. A uniform free delivery system was first authorized by law on the 3rd of March 1863, and was established on the succeeding 1st of July in forty-nine cities. The number of carriers employed the first year was 685. On the 1st of July 1884 there were 3890 letter-carriers in one hundred and fifty-nine "free delivery cities."

The free delivery service has grown rapidly. On the 1st of July 1901, 866 cities and towns were included in the scheme, and

16,389 letter-carriers were serving a population of 32,000,000. An extension to rural districts was started in 1896, and by December 1901, 4,000,000 of the rural population were within the scope of free delivery. Since the 1st of October 1885 a system has been in force for the immediate delivery by special messengers of letters, parcels, &c., for addresses within certain areas. A special ten-cent stamp (or its equivalent) is required in addition to the ordinary postage.

The registry system did not attain any degree of excellence until after 1860; and the money-order system was first established in 1864. The aggregate number of money orders, domestic and foreign, issued during the fiscal year 1906 was 61,497,861, of the value of \$507,563,719. A step towards the popularization of the registry system was authorized in December 1899; letter-carriers in many city districts now accept and register letters at the door of the householder. Sea post offices for sorting mails during the Atlantic transit were established in December 1890 on the steamers of the North German Lloyd and Hamburg-American lines, and later on the vessels of the International Navigation Company. This plan effects a saving of from two to fourteen hours in the delivery of mails from Europe. The issue of "postal notes," commenced in 1883, was abandoned in 1894. The introduction of "postal checks" for small fixed amounts has been advocated. A new postal convention with Canada, removing the former restriction against sending merchandise, came into force on the 1st of March 1888. Uniformity of postage rates having been previously established, the United States and Canada became virtually one postal territory.

A convention for an exchange of parcels with Jamaica, admitting articles not exceeding 11 lb, was agreed to in 1887; and since then conventions on similar lines have been concluded with other colonies and countries in America. The first arrangement of the kind with any European country was made with Germany, and came into operation on the 1st of October 1899. The postal laws, regulations and domestic conditions of the United States have been extended, by act of Congress, to Porto Rico and Hawaii. The "island possessions" (Guam, the Philippine Archipelago and Tutuila) have also been brought within the scope of the domestic conditions, including the rates of postage. The service introduced into Cuba, though modelled on the American plan, is practically autonomous.

Telegraphs.—The formation of a postal telegraph system has continued to be a subject of discussion by the postmasters-general. In his report for the year 1888 D. M. Dickinson proposed the appointment of an expert commission authorized to erect short experimental lines. His successor, John Wanamaker, for four years vigorously advocated a limited postal telegraph service. Under this proposal, contracting telegraph companies were to furnish lines, instruments and operators, and to transmit messages at rates fixed by the government; the department was to receive a small sum per message, to cover its expenses in collection and delivery. In 1894 Mr Bissell expressed the opinion that a government system would be unprofitable and inexpedient.

Savings Banks.—The establishment of postal savings banks was also recommended by Mr Wanamaker in his reports for the years 1889 to 1892, and by J. A. Gary in 1897. What is regarded as a step in this direction was taken in 1898, when the postal regulations were modified to allow money orders to be made payable at the office of issue,—a "mild and very convenient adaptation of the European savings bank system, without the payment of interest" (Mr Emory Smith). Finally in 1910 a system of postal savings banks was authorized by Congress.

AUTHORITIES.—Postmaster-General's Annual Reports: Joyce, *History of the British Post Office* (1893); J. Wilson Hyde, *The Post in Grant and Farm* (1894); A. H. Norway, *History of the Packet Service* (1895); F. E. Baines, *Forty Years at the Post Office* (1895); Raikes, *Life of Rt. Hon. H. C. Raikes* (1898); *L'Union postale universelle, sa fondation et son développement* (Lausanne, 1900); mémoire publié par le bureau international à l'occasion de la célébration du xxv^{me} anniversaire de l'union 2-5 juillet 1900; *Statistique générale du service postal* (Bern); *Statistique générale de la télégraphie* (Bern).

The various postal and telegraph rates and regulations of the United Kingdom appear in the quarterly *Post Office Guide* (price 6d.). For the United States, see the *U.S. Official Postal Guide*. (T. A. I.)

POST AND PAIR, a card game popular in the 16th and 17th centuries. A hand consisted of three cards, a pair royal ranking highest, or failing this, the highest pair. Another name of the game was Pink.

POSTER, a placard in the form either of letterpress or illustration, for posting up or otherwise exhibiting in public to attract attention to its contents. According to Brewer's *Dictionary of Phrase and Fable*, before the Fire of London the rails and posts which protected foot-passengers in the streets were used for affixing theatrical and other announcements, whence the name of posting-bills or posters; and in later times the name has come more generally into use for any fairly large separate sheet, illustrated or not, used to attract publicity, even though not actually posted up. In the article **ADVERTISEMENTS** the use of posters is discussed, and newspaper posters (or contents bills) under **NEWSPAPERS**. But the illustrated poster has come to represent a special form of artistic design.

The earliest examples of pictorial posters were adorned with rough woodcuts. When lithography became a common commercial process, wood-blocks ceased to be employed. The modern artistic poster made a definite beginning in France about 1836, with a design by Lalance to advertise a book entitled *Comment meurent les femmes*. His example was followed by C. Nanteuil, D. A. M. Raffet, Gavarni, Bertrand, Grandville, Tony Johannot, E. de Beaumont, T. H. Frère, Edouard Manet and other artists of high repute. Most of these early designs were printed in black on white or tinted paper. Between 1860 and 1866 crude attempts at printing posters in colours were made in both France and England. In 1866 Jules Chéret began what was destined to be the most noticeable series of pictorial placards in existence, a series containing over a thousand items. Chéret was originally employed in a lithographic establishment in England before he began to work for himself, and he used his knowledge there acquired to adapt all three primary colours, economically used, to astonishingly brilliant ends. For a considerable time he remained without a rival, though he had hosts of imitators. Eugène Grasset, a decorative designer of great versatility, produced the first of a small number of placards which, though inferior as advertisements to those of Chéret, were learned and beautiful decorations. Somewhat later a sensation was caused in Paris by the mordantly grotesque posters of Henri de Toulouse-Lautrec, in which the artist reduced detail to a minimum and obtained bold effects by the employment of large masses of flat colour. Important work, similar in character to Lautrec's, was produced by Ibels, Bonnard, T. A. Steinlen and others. A new and contrary direction was given to poster design by Mucha, a Hungarian resident in Paris, whose placards are marked by delicate colour and richness of detail. The following are amongst French artists who have designed posters of conspicuous merit: J. L. Forain, Willette, Paléologue, Sinet, Jossot, Roedel, Mayet, Cazals, Bias, De Feure, A. Guillaume, Ranft, Réalier-Dumas, F. Valloton and Metivet. Occasionally eminent French painters, such as Carrière, Boutet de Monvel, Aman-Jean, Schwabe, have made essays in poster-designing.

In England the first artists of repute to attempt the pictorial placard were Godfrey Durand and Walter Crane; but the first bill to attract widespread attention was one by Fred Walker to advertise a dramatized version of *The Woman in White* (1871). This was engraved on wood by W. H. Hooper. Shortly after this time pictures by Royal Academicians and others began to be reproduced as advertisements (the best-known case being that of Sir John Millais's "Bubbles"), but these have nothing directly to do with poster-designing. Stacy Marks, Hubert von Herkomer (the great poster for the *Magazine of Art*), Sir Edward Poynter and Sir James Linton are among popular painters who have made special drawings for reproduction as posters.

About 1894 the English poster began to improve. Designs by Aubrey Beardsley for the Avenue Theatre, by Dudley Hardy for various plays, and by Maurice Greiffenhagen for *The Pall Mall Budget*, were widely noticed by reason of their originality, simplicity and effectiveness. Simplicity was carried even farther by "the Beggarstaff Brothers" (James Pryde and William Nicholson), whose posters are perhaps the most original yet produced by Englishmen. Among other British designers the following have executed artistic and interesting placards: Frank Brangwyn, R. Anning Bell, John Hassall, Cecil Aldin, Phil May, Leonard Raven-Hill, Henry Harland, Robert Fowler, Wilson Steer, Charles R. Mackintosh, MacNair and MacDonald, Edgar Wilson, Charles I. Foulkes, Mabel Dearmer, Albert Morrow and C. Wilhelm.

Poster design on the continent of Europe has been largely influenced by French work, but designs of much originality have been made in Germany, Belgium, Italy and Spain. In Germany, among the most typical posters are those of Sattler, Otto Fischer, Gysis, T. T. Heine, Speyer, Max Klinger, Dasio, Hofmann and L. Zumbusch. The principal Belgian designers include Privat Livemont, Rassenfosse, Berchmans, Meunier, Duyck and Crespin, V. Mignot, Donnay, Evenepoel, Cassiers and Toussaint. Of Italian designers those whose work is most characteristic are Mataloni and Hohenstein; while the best Spanish posters—those to advertise bull-fights and fairs—are mostly anonymous. The Spanish artists Utrillo and Casas have signed posters of more than

ordinary merit. Curious if not very artistic bills have been produced in Russia; and in Austria good work has been done by Orlik, Schliessmann, Oliva and Hynais.

In the United States of America, however, with the exception of some designs by Matt Morgan, few posters of artistic interest were produced before 1889, in which year Louis J. Rhead commenced a notable series of decorative placards. Will H. Bradley began to produce his curious decorative grotesque posters a little later. If American artists are behind Europeans in the artistic designing of large posters they have no rivals in the production of small illustrated placards for publishers of books and magazines. Chief among those who have devoted themselves to this branch of poster design is Edward Penfield. Others who have achieved success in it include Maxfield Parrish, Ethel Reed, Will Carqueville, J. J. Gould, J. C. Leyendecker, Frank Hazenplug, Charles Dana Gibson, Will Denslow, Florence Lundborg and Henry Mayer.

Exhibitions of artistic posters have been held in the chief cities of Europe and America, and the illustrated placard has already a literature of its own. In England a monthly magazine (*The Poster*) was for a time specially devoted to its interests, and collectors are numerous and enthusiastic.

See Ernest Maindron, *Les Affiches illustrées* (Paris, 1895); *Les Matres de l'affiche* (Paris); *Les Affiches étrangères illustrées* (Belgium, Austria, Great Britain, United States, Germany and Japan) (Paris, 1897); Charles Hiatt, *Picture Posters* (London, 1895); J. L. Spouse, *Das Moderne Plakat* (Dresden, 1897); Arsene Alexandre, M. H. Spielmann, H. C. Bunner and A. Jaccacci, *The Modern Poster* (New York, 1895). (C. H.)

POSTERN (from O. Fr. *posterne*, *posterle*, Late Lat. *posterula*, small back-door, *posterus*, behind), a small gateway in the enceinte of a castle, abbey, &c., from which to issue and enter unobserved. They are often called "sally ports." (See GATE.)

POSTHUMOUS, that which appears or is produced after the author or creator, and thus applied to a literary work or work of art published or produced after its author's death, or especially to a child born after the death of its father. The Latin *postumus*, latest, last, from which the word is derived, is formed from *post*, after, but it was in Late Latin connected with *humare*, to place in the ground (*humus*), to bury.

POSTICHE, a French term for a pretentious imitation, a counterfeit, particularly used of an inartistic addition to an otherwise perfect work of art. The French word was adapted from the Italian *posticcio*, from Latin *positus*, placed, added.

POSTIL, or APOSTIL, properly a gloss on a scriptural text, particularly on a gospel text, hence any explanatory note on other writings. The word is also applied to a general commentary, and also to a homily or discourse on the gospel or epistle appointed for the day. The word in Medieval Latin was *postilla*, and this has been taken to represent *post illa sc. verba textus*, i.e. "after these words of the text" (see Du Cange, *Glossarium*, s.v. *postillae*), but the form "apostil" may point to the Latin *appositum*, placed near or next to.

POSTILION (through the Fr. from the Ital. *postiglione*), a postboy, rider of a post-horse, hence any swift messenger, but more particularly the rider of the near horse of a vehicle drawn by two or more horses where there is no driver. The swift travelling postchaises of the 18th and early 19th centuries were usually driven by postilions.

POSTUMIA, VIA, an ancient highroad of northern Italy, constructed in 148 B.C. by the consul Spurius Postumius Albinus. It ran from the coast at Genua through the mountains to Dertona, Placentia (the termination of the Via Aemilia Lepidi) and Cremona, just east of the point where it crossed the Po. From Cremona the road ran eastward to Bedriacum, where it forked, one branch running to the left to Verona and thence to the Brenner, the other to the right to Mantua, Altinum and Aquileia. The military occupation of Liguria depended upon this road, and several of the more important towns owed their origin largely to it. Cremona was its central point, the distances being reckoned from it both eastwards and westwards.

(T. As.)

POSY (a shortened form of *pocsy*, Fr. *poésie*, poetry), a verse of poetry or a motto, either with a moral or religious sentiment or message of love, often inscribed in a ring or sent with a present, such as a bouquet of flowers, which may be the origin of the common use of the word for a nosegay or bouquet.

It has been suggested that this use is due to the custom of the symbolic use of flowers. Skeat quotes the title of a tract (*Heber's MSS. No. 1442*), "A new yeare's guifte, or a posie made upon certen flowers," &c. "Posy rings," plain or engraved gold rings with a "posy" inscribed on the inside of the hoops, were very frequently in use as betrothal rings from the 16th to the 18th centuries. Common "posies" were such lines as "In thee my choice I do rejoyce," "As God decreed so we agreed," and the like. There are several rings of this kind in the British Museum.

POTASHES, the crude potassium carbonate obtained by lixiviating wood ashes and evaporating the solution to dryness, an operation at one time carried out in iron pots—hence the name from "pot" and "ashes." The term potash or caustic potash is frequently used for potassium hydroxide, whilst such a phrase as sulphate of potash is now appropriately replaced by potassium sulphate. (See POTASSIUM.)

POTASSIUM [symbol K (from *kalium*), atomic weight 39.114 O=16], a metallic chemical element, belonging to the group termed the metals of the alkalis. Although never found free in nature, in combination the metal is abundantly and widely distributed. In the oceans alone there are estimated to be 1141×10^{12} tons of sulphate, K_2SO_4 , but this inexhaustible store is not much drawn upon; and the "salt gardens" on the coast of France lost their industrial importance as potash-producers since the deposits at Stassfurt in Germany have come to be worked. These deposits, in addition to common salt, include the following minerals: sylvine, KCl; carnallite, $KCl \cdot MgCl_2 \cdot 6H_2O$ (transparent, deliquescent crystals, often red with diffused oxide of iron); kainite, $K_2SO_4 \cdot MgSO_4 \cdot MgCl_2 \cdot 6H_2O$ (hard crystalline masses, permanent in the air); kieserite $MgSO_4 \cdot H_2O$ (only very slowly dissolved by water); besides polyhalite, $MgSO_4 \cdot K_2SO_4 \cdot 2CaSO_4 \cdot 2H_2O$; anhydrite, $CaSO_4$; salt, NaCl, and some minor components. These potassium minerals are not confined to Stassfurt; larger quantities of sylvine and kainite are met with in the salt mines of Kalusz in the eastern Carpathian Mountains. The Stassfurt minerals owe their industrial importance to their solubility in water and consequent ready amenability to chemical operations. In point of absolute mass they are insignificant compared with the abundance and variety of potassium silicates, which occur everywhere in the earth's crust; orthoclase (potash felspar) and potash mica may be quoted as prominent examples. Such potassium silicates are found in almost all rocks, both as normal and as accessory components; and their disintegration furnishes the soluble potassium salts which are found in all fertile soils. These salts are sucked up by the roots of plants, and by taking part in the process of nutrition are partly converted into oxalate, tartrate, and other organic salts, which, when the plants are burned, are converted into the carbonate, K_2CO_3 . It is a remarkable fact that, although in a given soil the soda-content may predominate largely over the potash salts, the plants growing in the soil take up the latter: in the ashes of most land plants the potash (calculated as K_2O) forms upwards of 90% of the total alkali. The proposition holds, in its general sense, for sea plants likewise. In ocean water the ratio of soda (Na_2O) to potash (K_2O) is 100 : 3.23 (Dittmar); in kelp it is, on the average, 100 : 5.26 (Richardson). Ashes particularly rich in potash are those of burning nettles, wormwood (*Artemisia absinthium*), tansy (*Tanacetum vulgare*), fumitory (*Fumaria officinalis*), and tobacco. In fact, the ashes of herbs generally are richer in potash than those of the trunks and branches of trees; yet, for obvious reasons, the latter are of greater industrial importance as sources of potassium carbonate. According to Liebig, potassium is the essential alkali of the animal body; and it may be noted that sheep excrete most of the potassium which they take from the land as sweat, one-third of the weight of raw merino consisting of potassium compounds.

To Sir Humphry Davy belongs the merit of isolating this element from potash, which itself had previously been considered an element. On placing a piece of potash on a platinum plate, connected to the negative of a powerful electric battery, and

bringing a platinum wire, connected to the positive of the battery, to the surface of the potassium a vivid action was observed: gas was evolved at the upper surface of the fused globule of potash, whilst at the lower surface, adjacent to the platinum plate, minute metallic globules were formed, some of which immediately inflamed, whilst others merely tarnished. In 1808 Gay-Lussac and Thénard (*Ann. chim.* 65, p. 325) obtained the metal by passing melted potash down a clay tube containing iron turnings or wire heated to whiteness, and Caradau (*ibid.* 66, p. 97) effected the same decomposition with charcoal at a white heat. This last process was much improved by Brunner, Wöhler, and especially by F. M. L. Donny and J. D. B. Mareska (*Ann. chim. phys.*, 1852, (3), 35, p. 147). Brunner's process consisted in forming an intimate mixture of potassium carbonate and carbon by igniting crude tartar in covered iron crucibles, cooling the mass, and then distilling it at a white heat from iron bottles, the vaporized metal being condensed beneath the surface of paraffin or naphtha contained in a copper vessel. It was found, however, that if the cooling be not sufficiently rapid explosions occurred owing to the combination of the metal with carbon monoxide (produced in the oxidation of the charcoal) to form the potassium salt of hexaoxybenzene. In Mareska and Donny's process the condensation is effected in a shallow iron box, which has a large exposed surface, capable of being cooled by damped cloths. When the distillation is finished the iron box, after cooling, is unclamped and the product turned out beneath the surface of paraffin. It is purified by redistilling and condensing directly under paraffin. Electrolytic processes have also been devised. Linnemann (*Journ. Prak. Chem.*, 1858, 73, p. 413) obtained the metal on a small scale by electrolysing potassium cyanide between carbon electrodes; A. Matthiessen (*Journ. Chem. Soc.*, 1856, p. 30) electrolysed an equimolecular mixture of potassium and calcium chlorides (which melts at a lower temperature than potassium chloride) also between carbon electrodes; whilst Castner's process, in which caustic potash is electrolysed, is employed commercially. The metal, however, is not in great demand, for it is generally found that sodium (*q.v.*), which is cheaper, and, weight for weight, more reactive, will fulfil any purpose for which potassium may be desired.

Pure potassium is a silvery white metal tinged with blue; but on exposure to air it at once forms a film of oxide, and on prolonged exposure deliquesces into a solution of hydrate and carbonate. Perfectly dry oxygen, however, has no action upon it. At temperatures below 0° C. it is pretty hard and brittle; at the ordinary temperature it is so soft that it can be kneaded between the fingers and cut with a blunt knife. Its specific gravity is 0.865; hence it is the lightest metal known except lithium. It fuses at 62.5°C. (Bunsen) and boils at 667°, emitting an intensely green vapour. It may be obtained crystallized in quadratic octahedra of a greenish-blue colour, by melting in a sealed tube containing an inert gas, and inverting the tube when the metal has partially solidified. When heated in air it fuses and then takes fire, burning into a mixture of oxides. Most remarkable, and characteristic for the group it represents, is its action on water. A pellet of potassium when thrown on water at once bursts out into a violet flame and the burning metal fizzes about on the surface, its extremely high temperature precluding absolute contact with the liquid, except at the very end, when the last remnant, through loss of temperature, is wetted by the water and bursts with explosive violence. The reaction may be written $2K + 2H_2O = 2KOH + H_2$, and the flame is due to the combustion of the hydrogen, the violet colour being occasioned by the potassium vapour. The metal also reacts with alcohol to form potassium ethylate, while hydrogen escapes, this time without inflammation: $K + C_2H_5.OH = C_2H_5.OK + H$. When the oxide-free metal is heated gently in dry ammonia it is gradually transformed into a blue liquid, which on cooling freezes into a yellowish-brown or flesh-coloured solid, potassamide, KNH_2 . When heated to redness the amide is decomposed into ammonia and potassium nitride, NK_3 , which is an almost black solid. Both it and the amide

decompose water readily with formation of ammonia and caustic potash. Potassium at temperatures from 200° to 400°C. occludes hydrogen gas, the highest degree of saturation corresponding approximately to the formula K_2H . In a vacuum or in sufficiently dilute hydrogen the compound from 200° upwards loses hydrogen, until the tension of the free gas has arrived at the maximum value characteristic of that temperature (Troost and Hautefeuille).

Compounds.

Oxides and Hydroxide.—Potassium forms two well-defined oxides, K_2O and K_2O_2 , whilst several others, of less certain existence, have been described. The monoxide, K_2O , may be obtained by strongly heating the product or burning the metal in slightly moist air; by heating the hydroxide with the metal: $2KHO + 2K = 2K_2O + H_2$; or by passing pure and almost dry air over the molten metal (Kühnemann, *Chem. Centr.*, 1863, p. 491). It forms a grey brittle mass, having a conchoidal fracture; it is very deliquescent, combining very energetically with water to form caustic potash. According to Holt and Sims (*Journ. Chem. Soc.*, 1894, p. 438), the substance as obtained above always contains free potassium.

Potassium hydroxide or caustic potash, KOH , formerly considered to be an oxide but shown subsequently to be a hydroxide of potassium, may be obtained by dissolving the metal or monoxide in water, but is manufactured by double decomposition from potassium carbonate and slaked lime: $K_2CO_3 + Ca(OH)_2 = 2KOH + CaCO_3$. A solution of one part of the carbonate in 12 parts of water is heated to boiling in a cast-iron vessel (industrially by means of steam-pipes) and the milk of lime added in instalments until a sample of the filtered mixture no longer effervesces with an excess of acid. The mixture is then allowed to settle in the iron vessel, access of air being prevented as much as practicable, and the clear liquor is syphoned off. The remaining mud of calcium carbonate and hydrate is washed, by decantation, with small instalments of hot water to recover at least part of the alkali diffused throughout it, but this process must not be continued too long or else some of the lime passes into solution. The liquors after a concentration in iron vessels are now evaporated in a silver dish, until the heavy vapour of the hydrate is seen to go off. The residual oily liquid is then poured out into a polished iron tray, or into an iron mould to produce the customary form of "sticks," and allowed to cool. The solid must be at once bottled, because it attracts the moisture and carbonic acid of the air with great avidity and deliquesces. According to Dittmar (*Journ. Soc. Chem. Ind.*, May 1884), nickel basins are far better adapted than iron basins for the preliminary concentration of potash ley. The latter begin to oxidize before the ley has come up to the traditional strength of specific gravity 1.333 when cold, while nickel is not attacked so long as the percentage of real KHO is short of 60. For the fusion of the dry hydrate nickel vessels cannot be used; in fact, even silver is perceptibly attacked as soon as all the excess of water is away; absolutely pure KHO can be produced only in gold vessels. Glass and (to a less extent) porcelain are attacked by caustic potash ley, slowly in the cold, more readily on boiling.

Solid caustic potash forms an opaque, white, stone-like mass of dense granular fracture; specific gravity 2.1. It fuses considerably below and is perceptibly volatile at a red heat. At a white heat the vapour breaks down into potassium, hydrogen and oxygen. It is extremely soluble in even cold water, and in any proportion of water on boiling. On crystallizing a solution, the hydrate $KOH \cdot 2H_2O$ is deposited; $2KOH \cdot 9H_2O$ and $2KOH \cdot 5H_2O$ have also been obtained. The solution is intensely "alkaline" to test-papers. It readily dissolves the epidermis of the skin and many other kinds of animal tissue—hence the former application of the "sticks" in surgery. A dilute potash readily emulsifies fats, and on boiling saponifies them with formation of a soap and glycerin. All commercial caustic potash is contaminated with excess of water (over and above that in the KHO) and with potassium carbonate and chloride; sulphate, as a rule, is absent. A preparation sufficing for most purposes is obtained by digesting the commercial article in absolute alcohol, decanting and evaporating the solution to dryness and fusing in silver vessels.

The peroxide, K_2O_2 , discovered by Gay-Lussac and Thénard, is obtained by heating the metal in an excess of slightly moist air or oxygen. Vernon Harcourt (*Journ. Chem. Soc.*, 1862, p. 267) recommends melting the metal in a flask filled with nitrogen and gradually displacing this gas by oxygen; the first formed grey film on the metal changes to a deep blue, and then the gas is rapidly absorbed, the film becoming white and afterwards yellow. It is a dark yellow powder, which fuses at a high temperature, the liquid on cooling depositing shining tabular crystals; at a white heat it loses oxygen and yields the monoxide. Exposed to moist air it loses oxygen, possibly giving the dioxide, K_2O_2 ; water reacts with it, evolving much heat and giving caustic potash, hydrogen peroxide and oxygen; whilst carbon monoxide gives potassium carbonate and oxygen at temperatures below 100°. A violent reaction ensues with phosphorus and sulphur, and many metals are oxidized by it, some with incandescence.

Halogen Compounds.—Potassium fluoride, KF, is a very deliquescent salt, crystallizing in cubes and having a sharp saline taste, which is formed by neutralizing potassium carbonate or hydroxide with hydrofluoric acid and concentrating in platinum vessels. It forms the acid fluoride KHF_2 , when dissolved in aqueous hydrofluoric acid, a salt which at a red heat gives the normal fluoride and hydrofluoric acid. Other salts of composition $\text{KF}\cdot 2\text{HF}$ and $\text{KF}\cdot 3\text{HF}$, have been described by Moissan (*Compt. rend.*, 1888, 106, p. 547).

Potassium chloride, KCl, also known as muriate of potash, closely resembles ordinary salt. It is produced in immense quantities at Stassfurt from the so-called "Abraumsalze." For the purpose of the manufacturer of this salt these are assorted into a raw material containing approximately, in 100 parts, 55–65 of carnallite (representing 16 parts of potassium chloride), 20–25 of common salt, 15–20 of kieserite; 2–4 of tachhydrite ($\text{CaCl}_2\cdot 2\text{MgCl}_2\cdot 12\text{H}_2\text{O}$), and minor components. This mixture is now wrought mainly in two ways. (1) The salt is dissolved in water with the help of steam, and the solution is cooled down to from 60° to 70° , when a quantity of impure common salt crystallizes out, which is removed. The decanted ley deposits on standing a 70% potassium chloride, which is purified by washing with cold water. Common salt principally goes into solution, and the percentage may thus be brought up to from 80 to 95. The mother-liquor from the 70% chloride is evaporated, the common salt which separates out in the heat removed as it appears, and the sufficiently concentrated liquor allowed to crystallize, when almost pure carnallite separates out, which is easily decomposed into its components (see *infra*). (2) Ziervogel and Tuchen's method.—The crude salt is ground up and then heated in a concentrated solution of magnesium chloride with agitation. The carnallite principally dissolves and crystallizes out relatively pure on cooling. The mother-liquor is used for a subsequent extraction of fresh raw salt. The carnallite produced is dissolved in hot water and the solution allowed to cool, when it deposits a coarse granular potassium chloride containing up to 99% of the pure substance. The undissolved residue produced in either process consists chiefly of kieserite and common salt. It is worked up either for Epsom salt and common salt, or for sodium sulphate and magnesium chloride. The potassiferous by-products are utilized for the manufacture of manures.

Chemically pure chloride of potassium is most conveniently prepared from the pure perchlorate by heating it in a platinum basin at the lowest temperature and then fusing the residue in a well-covered platinum crucible. The fused product solidifies on cooling into a colourless glass.

When hydrochloric acid gas is passed into the solution the salt is completely precipitated as a fine powder. If the original solution contained the chlorides of magnesium or calcium or sulphate of potassium all impurities remain in the mother-liquor (the sulphur as KHSO_4), and can be removed by washing the precipitate with strong hydrochloric acid. The salt crystallizes in cubes of specific gravity 1.995; it melts at about 800° and volatilizes at a bright red heat. When melted in a current of hydrogen or electrolysed in the same condition, a dark blue mass is obtained of uncertain composition. It is extensively employed for the preparation of other potassium salts, but the largest quantity (especially of the impure product) is used in the production of artificial manures.

Potassium bromide, KBr, may be obtained by dissolving bromine in potash, whereupon bromide and bromate are first formed, evaporating and igniting the product in order to decompose the bromate: $6\text{KHO} + 3\text{Br}_2 = 5\text{KBr} + \text{KBrO}_3 + 3\text{H}_2\text{O}$; $2\text{KBrO}_3 = 2\text{KBr} + 3\text{O}_2$ (cf. CHLORATES); but it is manufactured by acting with bromine water on iron filings and decomposing the iron bromide thus formed with potassium carbonate. In appearance it closely resembles the chloride, forming colourless cubes which readily dissolve in water and melt at 722° . It combines with bromine to form an unstable tribromide, KBr_3 (see F. P. Worley, *Journ. Chem. Soc.*, 1905, 87, p. 1107).

Potassium iodide, KI, is obtained by dissolving iodine in potash, the deoxidation of the iodate being facilitated by the addition of charcoal before ignition, proceeding as with the bromide. The commercial salt usually has an alkaline reaction; it may be purified by dissolving in the minimum amount of water, and neutralizing with dilute sulphuric acid; alcohol is now added to precipitate the potassium sulphate, the solution filtered and crystallized. It forms colourless cubes which are readily soluble in water, melt at 685° , and yield a vapour of normal density. It is sparingly soluble in absolute alcohol. Both the iodide and bromide are used in photography. Iodine dissolves in an aqueous solution of the salt to form a dark brown liquid, which on evaporation over sulphuric acid gives black acicular crystals of the tri-iodide, KI_3 . This salt is very deliquescent; it melts at 45° , and at 100° decomposes into iodine and potassium iodide. For the oxyhalogen salts see CHLORATE, CHLORINE, BROMINE and IODINE.

Potassium carbonate, K_2CO_3 , popularly known as "potashes," was originally obtained in countries where wood was cheap by lixiviating wood ashes in wooden tubs, evaporating the solution to dryness in iron pots and calcining the residue; in more recent practice the calcination is carried out in reverberatory furnaces. This product, known as "crude potashes," contains, in addition

to carbonate, varying amounts of sulphate and chloride and also insoluble matter. Crude potash is used for the manufacture of glass, and, after being causticized, for the making of soft soap. For many other purposes it must be refined, which is done by treating the crude product with the minimum of cold water required to dissolve the carbonate, removing the undissolved part (which consists chiefly of sulphate), and evaporating the clear liquor to dryness in an iron pan. The purified carbonate (which still contains most of the chloride of the raw material and other impurities) is known as "pearl ashes." Large quantities of carbonate used to be manufactured from the aqueous residue left in the distillation of beet-root spirit, *i.e.* indirectly from beet-root molasses. The liquors are evaporated to dryness and the residue is ignited to obtain a very impure carbonate, which is purified by methods founded on the different solubilities of the several components. Most of the carbonate which now occurs in commerce is made from the chloride of the Stassfurt beds by an adaptation of the "Leblanc process" for the conversion of common salt into soda ash (see ALKALI MANUFACTURE).

Chemically pure carbonate of potash is best prepared by igniting pure bicarbonate (see below) in iron or (better) in silver or platinum vessels, or else by calcining pure cream of tartar. The latter operation furnishes an intimate mixture of the carbonate with charcoal, from which the carbonate is extracted by lixiviation with water and filtration. The filtrate is evaporated to dryness (in iron or platinum vessels) and the residue fully dehydrated by gentle ignition. The salt is thus obtained as a white porous mass, fusible at a red heat (838°C. , Carnelley) into a colourless liquid, which solidifies into a white opaque mass. The dry salt is very hygroscopic; it deliquesces into an oily solution ("oleum tartari") in ordinary air. The most saturated solution contains 205 parts of the salt to 100 of water and boils at 135° . On crystallizing a solution monoclinic crystals of $2\text{K}_2\text{CO}_3\cdot 3\text{H}_2\text{O}$ are deposited, which at 100° lose water and give a white powder of $\text{K}_2\text{CO}_3\cdot \text{H}_2\text{O}$; this is completely dehydrated at 130° . The carbonate, being insoluble in strong alcohol (and many other liquid organic compounds), is much used for dehydration of the corresponding aqueous preparations. The pure carbonate is constantly used in the laboratory as a basic substance generally, for the disintegration of silicates, and as a precipitant. The industrial preparation serves for the making of flint glass, of potash soap (soft soap) and of caustic potash.

Potassium bicarbonate, KHCO_3 , is obtained when carbonic acid is passed through a cold solution of the ordinary carbonate as long as it is absorbed. Any silicate present is also converted into bicarbonate with elimination of silica, which must be filtered off. The filtrate is evaporated at a temperature not exceeding 60° or at most 70°C. ; after sufficient concentration it deposits on cooling anhydrous crystals of the salt, while the potassium chloride, which may be present as an impurity, remains mostly in the mother-liquor; the rest is easily removed by repeated recrystallization. If an absolutely pure preparation is wanted it is best to follow Wöhler and start with the "black flux" produced by the ignition of pure bitartrate. The flux is moistened with water and exposed to a current of carbonic acid, which, on account of the condensing action of the charcoal, is absorbed with great avidity. The bicarbonate forms large monoclinic prisms, permanent in the air. When the dry salt is heated to 190° it decomposes into normal carbonate, carbon dioxide and water.

Potassium sulphide, K_2S , was obtained by Berzelius in pale red crystals by passing hydrogen over potassium sulphate, and by Berthier as a flesh-coloured mass by heating the sulphate with carbon. It appears, however, that these products contain higher sulphides. On saturating a solution of caustic potash with sulphuretted hydrogen and adding a second equivalent of alkali, a solution is obtained which on evaporation in a vacuum deposits crystals of $\text{K}_2\text{S}\cdot 5\text{H}_2\text{O}$. The solution is strongly caustic. It turns yellow on exposure to air, absorbing oxygen and carbon dioxide and forming thiosulphate and potassium carbonate and liberating sulphuretted hydrogen, which decomposes into water and sulphur, the latter combining with the monosulphide to form higher salts. The solution also decomposes on boiling. The hydrosulphide, KHS, was obtained by Gay-Lussac on heating the metal in sulphuretted hydrogen, and by Berzelius on acting with sulphuretted hydrogen on potassium carbonate at a dull red heat. It forms a yellowish-white deliquescent mass, which melts on heating, and at a sufficiently high temperature it yields a dark red liquid. It is readily soluble in water, and on evaporation in a vacuum over caustic lime it deposits colourless, rhombohedral crystals of $2\text{KHS}\cdot \text{H}_2\text{O}$. The solution is more easily prepared by saturating potash solution with sulphuretted hydrogen. The solution has a bitter taste, and on exposure to the air turns yellow, but on long exposure it recovers its original colourless appearance owing to the formation of thiosulphate. *Liver of sulphur* or *hepar sulphuris*, a medicine known to the alchemists, is a mixture of various polysulphides with the sulphate and thiosulphate, in variable proportions, obtained by gently heating the carbonate with sulphur in covered vessels. It forms a liver-coloured mass. In the pharmacopoeia it is designated *potassa sulphurata*.

Potassium sulphite, K_2SO_3 , is prepared by saturating a potash solution with sulphur dioxide, adding a second equivalent of potash,

and crystallizing in a vacuum, when the salt separates as small deliquescent, hexagonal crystals. The salt $K_2SO_3 \cdot H_2O$ may be obtained by crystallizing the metabisulphite, $K_2S_2O_5$ (from sulphur dioxide and a hot saturated solution of the carbonate, or from sulphur dioxide and a mixture of milk of lime and potassium sulphate) with an equivalent amount of potash. The salt $K_2SO_3 \cdot 2H_2O$ is obtained as oblique rhombic octahedra by crystallizing the solution over sulphuric acid. On the isomeric potassium sodium sulphites see SULPHUR.

Potassium sulphate, K_2SO_4 , a salt known early in the 14th century, and studied by Glauber, Boyle and Tachenius, was styled in the 17th century *arcantum* or *sal duplicatum*, being regarded as a combination of an acid salt with an alkaline salt. It was obtained as a by-product in many chemical reactions, and subsequently used to be extracted from kainite, one of the Stassfurt minerals, but the process is now given up because the salt can be produced cheaply enough from the chloride by decomposing it with sulphuric acid and calcining the residuum. To purify the crude product it is dissolved in hot water and the solution filtered and allowed to cool, when the bulk of the dissolved salt crystallizes out with characteristic promptitude. The very beautiful (anhydrous) crystals have the habit of a double six-sided pyramid, but really belong to the rhombic system. They are transparent, very hard and absolutely permanent in the air. They have a bitter, salty taste. The salt is soluble in water, but insoluble in caustic potash of sp. gr. 1.35, and in absolute alcohol. It fuses at 1078° . The crude salt is used occasionally in the manufacture of glass. The acid sulphate or bisulphate, $KHSO_4$, is readily produced by fusing thirteen parts of the powdered normal salt with eight parts of sulphuric acid. It forms rhombic pyramids, which melt at 197° . It dissolves in three parts of water of 0° C. The solution behaves pretty much as if its two congeners, K_2SO_4 and H_2SO_4 , were present side by side of each other uncombined. An excess of alcohol, in fact, precipitates normal sulphate (with little bisulphate) and free acid remains in solution. Similar is the behaviour of the fused dry salt at a dull red heat; it acts on silicates, titanates, &c., as if it were sulphuric acid raised beyond its natural boiling point. Hence its frequent application in analysis as a disintegrating agent. For the salts of other sulphur acids, see SULPHUR.

Potassamide, NH_4K , discovered by Gay-Lussac and Thénard in 1871, is obtained as an olive green or brown mass by gently heating the metal in ammonia gas, or as a white, waxy, crystalline mass when the metal is heated in a silver boat. It decomposes in moist air, or with water, giving caustic potash and ammonia, in the latter case with considerable evolution of heat. On strong heating Tithesley (*Journ. Chem. Soc.*, 1894, p. 511) found that it decomposed into its elements. For the nitrite, see NITROGEN, for the nitrate see SALTPETRE and for the cyanide see PRUSSIC ACID; for other salts see the articles wherein the corresponding acid receives treatment.

Analysis, &c.—All volatile potassium compounds impart a violet coloration to the Bunsen flame, which is masked, however, if sodium be present. The emission spectrum shows two lines, K_α , a double line towards the infra-red, and $K\beta$ in the violet. The chief insoluble salts are the perchlorate, acid-tartrate and platinochloride. The atomic weight was determined by Stas and more recently by T. W. Richards and A. Stähler, who obtained the value 39.114 from analyses of the chloride, and by Richards and E. Meuller, who obtained the values 39.1135 and 39.1143 from analyses of the bromide (see *Abstr. J. C. S.*, 1907, ii. 615).

Medicine.

Pharmacology.—Numerous salts and preparations of potassium are used in medicine; viz. *Potassii Carbonis* (salt of tartar), dose 5 to 20 grs., from which are made (a) *Potassii Bicarbonas*, dose 5 to 30 grs.; (b) *Potassa Caustica*, a powerful caustic not used internally. From caustic potash are made (1) *Potassii Permanganas*, dose 1 to 3 grs., used in preparing *Liquor Potassii Permanganatis*, a 1% solution, dose 2 to 4 drs. (2) *Potassii Iodidum*, dose 5 to 20 grs.; from this are made the *Linamentum Potassii Iodidi cum sapone*, strength 1 in 10, and the *Unguentum Potassii Iodidi*, strength 1 in 10. (3) *Potassii Bromidum*, dose 5 to 30 grs. (4) *Liquor Potassae*, strength 27 grs. of caustic potash to the oz. *Potassii Citras*, dose 10 to 40 grs. *Potassii Acetas*, dose 10 to 60 grs. *Potassii Chloras*, dose 5 to 15 grs., from which is made a lozenge, *Trochiscus Potassii Chloratis*, each containing 3 grs. *Potassii Tartras Acidus* (cream of tartar), dose 20 to 60 grs., which has a subpreparation *Potassii Tartras*, dose 30 to 60 grs. *Potassii Nitras* (saltpetre), dose 5 to 20 grs. *Potassii Sulphas*, dose 10 to 40 grs. *Potassii Bichromas*, dose $\frac{1}{10}$ to $\frac{1}{2}$ gr.

Toxicology.—Poisoning by caustic potash may take place or poisoning by pearl ash containing caustic potash. A caustic taste in the mouth is quickly followed by burning abdominal pain, vomiting and diarrhoea, with a feeble pulse and a cold clammy skin; the post-mortem appearances are those of acute gastrointestinal irritation. The treatment is washing out the stomach or giving emetics followed by vinegar or lemon juice and later oil and white of egg.

Therapeutics.—Externally: Caustic potash is a most powerful irritant and caustic; it is used with lime in making Vienna paste,

which is occasionally used to destroy morbid growths. *Liquor potassae* is also used in certain skin diseases. The permanganate of potash is an irritant if used pure. Its principal action is as an antiseptic and disinfectant. If wet it oxidizes the products of decomposition. It is used in the dressing of foul ulcers. The 1% solution is an antidote for snake-bite.

Internally: Dilute solutions of potash, like other alkalis, are used to neutralize the poisonous effects of strong acids. In the stomach potassium salts neutralize the gastric acid, and hence small doses are useful in hyperchloridia. Potassium salts are strongly diuretic, acting directly on the renal epithelium. They are quickly excreted in the urine, rendering it alkaline and thus more able to hold uric acid in solution. They also hinder the formation of uric acid calculi. The acetate and the citrate are valuable mild diuretics in Bright's disease and in feverish conditions, and by increasing the amount of urine diminish the pathological fluids in pleuritic effusion, ascites, &c. In tubal nephritis they aid the excretion of fatty casts. The tartrate and acid tartrate are also diuretic in their action and, as well as the sulphate, are valuable hydragogue saline purgatives. Potassium nitrate is chiefly used to make nitre paper, which on burning emits fumes useful in the treatment of the asthmatic paroxysm. Lozenges of potassium chlorate are used in stomatitis, tonsillitis and pharyngitis, it can also be used in a gargle, 10 grs. to 1 fl. oz. of water. Its therapeutic action is said to be due to nascent oxygen given off, so it is local in its action. In large doses it is a dangerous poison, converting the oxyhaemoglobin of the blood into methaemoglobin. Internally the permanganate is a valuable antidote in opium poisoning. The action of potassium bromide and potassium iodide has been treated under bromine and iodine (*q.v.*). All potassium salts if taken in large doses are cardiac depressants, they also depress the nervous system, especially the brain and spinal cord. Like all alkalis if given in quantities they increase metabolism.

POTATO (*Solanum tuberosum*), a well-known plant which owes its value to the peculiar habit of developing underground slender leafless shoots or branches which differ in character and office from the true roots, and gradually swelling at the free end produce the tubers (potatoes) which are the common vegetable food. The nature of these tubers is further rendered evident by the presence of "eyes" or leaf-buds, which in due time lengthen into shoots and form the haulm or stems of the plant. Such buds are not, under ordinary circumstances, formed on roots. The determining cause of the formation of the tubers is not certainly known, but Professor Bernard has suggested that it is the presence of a fungus, *Fusarium solani*, which, growing in the underground shoots, irritates them and causes the swelling; the result is that an efficient method of propagation is secured independently of the seed. Starch and other matters are stored up in the tubers, as in a seed, and are rendered available for the nutrition of the young shoots. When grown under natural circumstances the tubers are relatively small and close to the surface of the soil, or even lie upon it. In the latter case they become green and have an acrid taste, which renders them unpalatable to human beings, and as poisonous qualities are produced similar to those of many *Solanaceae* they are unwholesome. Hence the recommendation to keep the tubers in cellars or pits, not exposed to the light. Among the nine hundred species of *Solanum* less than a dozen have this property of forming tubers, but similar growths are formed at the ends of the shoots of the common bramble, of *Convolvulus sepium*, of *Helianthus tuberosus*, the so-called Jerusalem artichoke, of *Sagittaria*, and other plants. Tubers are also sometimes formed on aerial branches, as in some Aroids, Begonias, &c. The production of small green tubers on the haulm, in the axils of the leaves of the potato, is not very unfrequent, and affords an interesting proof of the true morphological nature of the underground shoots and tubers. This phenomenon follows injury to the phloem in the lower parts of the stem, preventing the downward flow of elaborated sap. The injury may be due to gnawing insects, and particularly to the fungus *Corticium vagum*, var. *Solani* (*Rhizoctonia*).

The so-called fir-cone potatoes, which are elongated and provided with scales at more or less regular intervals, show also very clearly that the tuber is only a thickened branch with "eyes" set in regular order, as in an ordinary shoot. The potato tuber consists mainly of a mass of cells filled with starch and encircled by a thin corky rind. A few vessels and woody fibres traverse the tubers.

The chief value of the potato as an article of diet consists in the starch it contains, and to a less extent in the potash and other salts. The quantity of nitrogen in its composition is small, and hence it should not be relied on to constitute the staple article of diet. Letheby gives the following as the average composition of the potato—

Nitrogenous matters	2.1	Saline matter	0.7
Starch, &c.	18.8	Water	75.0
Sugar	3.2		
Fat	0.2		100.0

—a result which approximates closely to the average of nineteen analyses cited in *How Crops Grow* from Grouven. In some analyses, however, the starch is put as low as 13.30, and the nitrogenous matter as 0.92 (Dehérain, *Cours de chimie agricole*, p. 159). Boussingault gives 25.2% of starch and 3% of nitrogenous matter. Warington states that the proportion of nitrogenous to non-nitrogenous matter in the digestible part of potatoes is as 1 to 10.6. The composition of the tubers evidently varies according to season, soils, manuring, the variety grown, &c., but the figures cited will give a sufficiently accurate idea of it. The "ash" contains on the average of thirty-one analyses as much as 59.8% of potash, and 19.1% of phosphoric acid, the other ingredients being in very minute proportion. Where, as in some parts of northern Germany, the potato is grown for the purpose of manufacturing spirit great attention is necessarily paid to the quantitative analysis of the starchy and saccharine matters, which are found to vary much in particular varieties, irrespective of the conditions under which they are grown.

It is to the Spaniards that we owe this valuable esculent. The Spaniards met with it in the neighbourhood of Quito, where it was cultivated by the natives. In the *Cronica de Peru* of Pedro Cieça (Seville, 1553), as well as in other Spanish books of about the same date, the potato is mentioned under the name "battata" or "papa." Hieronymus Cardan, a monk, is supposed to have been the first to introduce it from Peru into Spain, from which country it passed into Italy and thence into Belgium. Carl Sprengel, cited by Professor Edward Morren in his biographical sketch entitled *Charles de l'Escluse, sa vie et ses œuvres*, states that the potato was introduced from Santa Fé into England by John Hawkins in 1563 (*Garten Zeitung*, 1805, p. 346). If this be so, it is a question whether the English and not the Spaniards are not entitled to the credit of the first introduction; but, according to Sir Joseph Banks, the plant brought by Drake and Hawkins was not the common English potato but the sweet potato.

In 1587 or 1588 De l'Escluse (Clusius) received the plant from Philippe de Sivry, lord of Waldheim and governor of Mons, who in his turn received it from some member of the suite of the papal legate. At the discovery of America, we are told by Humboldt, the plant was cultivated in all the temperate parts of the continent from Chile to Colombia, but not in Mexico. In 1585 or 1586, potato tubers were brought from what is now North Carolina to Ireland on the return of the colonists sent out by Sir Walter Raleigh, and were first cultivated on Sir Walter's estate near Cork. The tubers introduced under the auspices of Raleigh were thus imported a few years later than those mentioned by Clusius in 1588, which must have been in cultivation in Italy and Spain for some years prior to that time. The earliest representation of the plant is to be found in Gerard's *Herbal*, published in 1597. The plant is mentioned under the name *Papus orbiculatus* in the first edition of the *Catalogus* of the same author, published in 1596, and again in the second edition, which was dedicated to Sir Walter Raleigh (1599). It is, however, in the *Herbal* that we find the first description of the potato, accompanied by a woodcut sufficiently correct to leave no doubt whatever as to the identity of the plant. In this work (p. 781) it is called "Battata virginiana sive Virginia-norum, et Pappus, Potatoes of Virginia."

The "common potatoes" of which Gerard speaks are the tubers of *Ipomoea Batatas*, the sweet potato, which nowadays would not in Great Britain be spoken of as common. A second

edition of the *Herbal* was published in 1636 by Thomas Johnson, with a different illustration from that given in the first edition, and one which in some respects, as in showing the true nature of the tuber, is superior to the first. The phenomenon of growing out or "super-tuberation" is shown in this cut.

Previous to this (in 1629) Parkinson, the friend and associate of Johnson, had published his *Paradisus*, in which (p. 517) he gives an indifferent figure of the potato under the name of *Papas seu Battatas Virginianorum*, and adds details as to the method of cooking the tubers which seem to indicate that they were still luxuries. Chabreaus, who wrote in 1666, tells us that the Peruvians made bread from the tubers, which they called "chunno." He further tells us that by the natives *Virginieae insulae* the plant was called "openauk," and that it is now known in European gardens, but he makes no mention of its use as an esculent vegetable, and, indeed, includes it among "plantae malignae et venenatae." Heriot (*De Bry's Collection of Voyages*), in his report on Virginia, describes a plant under the same name "with roots as large as a walnut and others much larger; they grow in damp soil, many hanging together as if fixed on ropes; they are good food either boiled or roasted." The plant (which is not a native of Virginia) was probably introduced there in consequence of the intercourse of the early settlers with the Spaniards. The cultivation of the potato in England made but little progress, even though it was strongly urged by the Royal Society in 1663; and not much more than a century has elapsed since its cultivation on a large scale became general.

Botanists are agreed that the only species in general cultivation in Great Britain is the one which Bauhin, in his *Phytopanax*, p. 89 (1596), called *Solanum tuberosum esculentum*, a name adopted by Linnaeus (omitting the last epithet), and employed by all botanical writers. This species is probably native in Chile, but it is very doubtful if it is truly wild farther north. Baker (*Journ. Linn. Soc.*, 1884, xx. 489), has reviewed the tuber-bearing species of *Solanum* from a systematic point of view as well as from that of geographical distribution. Out of twenty so-called species he considers six to be really distinct, while the others are merely synonymous or trifling variations. The six admitted tuber-bearing species are *S. tuberosum*, *S. Maglia*, *S. Commersoni*, *S. cardiophyllum*, *S. Jamesii* and *S. oxycarpum*.

S. tuberosum is, according to Mr Baker, a native not only of the Andes of Chile but also of those of Peru, Bolivia, Ecuador and Colombia, also of the mountains of Costa Rica, Mexico and the south-western United States. It seems most probable, however, that some at least of the plants mentioned in the northern part of America are the descendants of cultivated forms. *S. Maglia* is a native of the Chilean coast as far south as the Chonos Archipelago, and was cultivated in the garden of the Horticultural Society at Chiswick in 1822, being considered by Sabine, in his paper on the native country of the wild potato, to be the true *S. tuberosum* and the origin of the cultivated forms. This species was also found by Darwin in Chile, and was considered by him, as by Sabine before him, to be the wild potato. Baker refers to the plants figured by Sabine (*Trans. Hort. Soc. Lond.* v. 249) (fig. 1) as being without doubt *S. Maglia*, but A. de Candolle (*Origine des Plantes cultivées*, p. 40) is equally emphatic in the opinion that it is *S. tuberosum*. *S. Commersoni* occurs in Uruguay, Buenos Aires and the Argentine Republic, in rocky situations at a low level. Under the name of *S. Ohronidii* it has been introduced into western France, where it is not only hardy but produces abundance of tubers, which are palatable, but have a slightly acid taste.



(From Sabine's figure in the *Trans. Hort. Soc. Lond.*, 1824, vol. v. pl. ii. See text.)

FIG. 1.—Wild Potato-plant in bloom. (¼ nat. size.)

S. cardiophyllum, described by Lindley in the *Journ. Hort. Soc.* is a native of the mountains of central Mexico at elevations of 8000 to 9000 ft. *S. Jamesii* is a well-defined species occurring in the mountains of Colorado, New Mexico and Arizona, and also in Mexico. In a wild state the tubers are not larger than marbles. *S. oxycarpum* is a

little known but very distinct tuberous species from central Mexico.¹

A review of the localities in which the presence of *S. tuberosum* and its tuber-bearing allies has been ascertained shows that, broadly, these varieties may be divided into mountainous and littoral. In either case they would not be subjected, at least in their growing season, to the same extremes of heat, cold and drought as plants growing on inland plains. Again, those forms growing at a high elevation would probably start into growth later in the season than those near the coast. The significance of these facts from a cultural point of view is twofold: for, while a late variety is desirable for culture in Great Britain, as ensuring more or less immunity from spring frost, it is, on the other hand, undesirable, because late varieties are more liable to be attacked by the potato disease (*Phytophthora infestans*) which as a rule appears about the time when the earliest varieties are ready for lifting, but before the late varieties are matured.

In cultivation the potato varies very greatly not only as to the season of its growth but also as to productiveness, the vigour and luxuriance of its foliage, the presence or relative absence of hairs, the form of the leaves, the size and colour of the flowers, &c. The tubers vary greatly in size, form and colour; gardeners divide them into rounded forms and long forms or "kidneys," and there are of course varieties intermediate in form. The colour of the rind, yellowish, brown or purple, furnishes distinctions, as does the yellow or white colour of the flesh. The colour of the eyes and their prominence or depression are relatively very constant characteristics. These variations have arisen chiefly through cross-breeding, though not entirely so, there being a few cases upon record of the production of "sports" from tubers that have become the parents of new varieties, but authentic cases of the sporting of tubers are few and far between. If, on the other hand, the true seeds of any of our cultivated varieties are sown, the seedlings show very wide variations from one another and from the parents. In this connexion it is very interesting to observe that Messrs Sutton of Reading find that the seedlings of many of the varieties of potato that occur spontaneously in different parts of America come quite true to type from seed.

The potato thrives best in a rather light friable loam; and in thin sandy soils the produce, if not heavy, is generally of very good quality. Soils which are naturally wet and heavy, as well as those which are heavily manured, are not suitable. Indeed it is best, except when there is ample space, to grow only the earlier kinds in gardens. If the soil is of fair quality the less manure used upon it the better, unless it be soot or lime. Gypsum, bone-dust, superphosphate of lime and nitrate of soda may also be used, and wood ashes are advantageous if the soil contains much vegetable matter; but the best results are usually obtained when farmyard manure is supplemented by artificials, not by using artificials alone.

Potatoes are commonly propagated by planting whole tubers or by dividing the tubers, leaving to each segment or "set" one or two eyes or buds. The "sets" are then planted in rows at a distance varying from 15 in. to 3 ft., the distance being regulated by the height of the stems, and that between the sets varying from 6 to 12 in., 8 in. being a good average space for garden crops, with 2 ft. between the rows. The sets may be put in 6 in. deep. The planting of whole tubers instead of the cut sets usually gives a better return.

¹ Although these six are the only species admitted as such by Baker, it is well to note some of the varieties. The *S. etuberosum* of Lindley, differing from the common *S. tuberosum* in not producing tubers, was found in Chile, and is probably not specifically distinct, although exceptional, for it is by no means very unusual to find even cultivated plants produce no tubers. *S. Fernandezianum* is, according to Baker, a form of *S. tuberosum*, but if so its habitat in the mountain woods of Juan Fernandez is climatically different from that in the dry mountains of central Chile, where the true *S. tuberosum* grows. *S. otites* was found more recently by André on the summit of Quindiu in Colombia, at a height of 11,483 ft. It produces tubers of the size of a nut. *S. Andreamum*, found by André at Cauca (6234 ft.), was considered by the traveller to be the true *S. tuberosum*, but this view is not shared by Baker, who named it after the discoverer. Its tubers, if it produces any, have not been seen. *S. immite* is probably only a slight variety of *S. tuberosum*, as are also the Venezuelan *S. colombianum*, *S. verrucosum*, *S. demissum* and *S. utile*. *S. Fendleri*, a native of the mountains of New Mexico and Arizona, was considered by Asa Gray to be likewise a form of *S. tuberosum*.

The full-sized tubers are, however, preferable to smaller ones, as their larger buds tend to produce stronger shoots, and where cut sets are used the best returns are obtained from sets taken from the points of the tubers—not from their base. Thomas Dickson of Edinburgh long ago observed that the most healthy and productive crop was to be obtained by planting unripe tubers, and proposed this as a preventive of the disease called the "curl," which sometimes attacks the young stems, causing them and also the leaves to become crumpled, and few or no tubers to be produced; in this connexion it is interesting to note that Scottish and Irish seed potatoes give a larger yield than English, probably on account of their being less matured. It has also been noted that the sprouting of the eyes of the potato may be accelerated if, while still unripe, it is taken up and exposed for some weeks to the influence of a scorching sun. The best sets are those obtained from plants grown in elevated and open situations, and it is also beneficial to use sets grown on a different soil.

The earliest crops should, if possible, be planted in a light soil and in a warm situation, towards the end of February, or as early as possible in March. In some cases the tubers for early crops are sprouted on a hotbed, the plants being put out as soon as the leaves can bear exposure.

The main crop should be planted by the middle of March, sprouted sets being used; late planting is very undesirable. Those intended for storing should be dug up as soon as they are fairly ripe, unless they are attacked by the disease, in which case they must be taken up as soon as the murrain is observed; or if they are then sufficiently developed to be worth preserving, but not fully ripe, the haulms or shaws should be pulled out, to prevent the fungus passing down them into the tubers; this may be done without disturbing the tubers, which can be dug afterwards.

Forcing.—The earliest crop may be planted in December, and successional ones in January and February; the varieties specially suited for forcing being chosen. The mode of cultivation adopted by the London market gardeners is thus in substance explained by Cuthill: A long trench, 5 ft. wide and 2 ft. deep, is filled with hot dung, on which soil to the depth of 6 in. is put. The sets employed are middle-sized whole potatoes, which are placed close together over the bed, covered with 2 in. of mould, and then hooped and protected with mats and straw, under which conditions they will sprout in about a month. A bed of the requisite length (sometimes 100 yds.) is then prepared of about 2 ft. thickness of hot dung, soil is put on to the depth of 8 in., and the frames set over all. The potatoes are then carefully taken up from the striking bed, all the shoots being removed except the main one, and they are planted 4 in. deep, radishes being sown thinly over them and covered lightly with mould. When the haulm of the potato has grown to about 6 in. in height the points are nipped off, in order to give the radishes fair play; and, although this may stop growth for a few days, still the potato crop is always excellent. After planting nothing more is required but to keep up the temperature to about 70°, admitting air when practicable, and giving water as required. The crop is not dug up until it has come to maturity.

Potatoes are also grown largely in hooped beds on a warm border in the open ground. The sets after having been sprouted, as above, are planted out in January in trenches 2 ft. deep filled with hot dung, the sets being planted 5 in. deep, and over all radishes are sown. The ridges are then hooped over, allowing about 2 ft. of space in the middle, between the mould and the hoop, and are covered with mats and straw, but as soon as the radishes come up they are uncovered daily, and covered again every night as a protection against possible frosts. This is continued till the potatoes are ready for digging in May.

Potatoes are sometimes grown in pots in heat, sprouted sets being planted in 11-in. pots about two-thirds full of soil, and placed near the glass in any of the forcing-houses, where a temperature of from 65° to 70° is to be maintained. The plants are duly watered and earthed up as they advance in growth.

POTATO DISEASES

There are few agricultural subjects of greater importance than the culture of the potato and the losses entailed by potato disease. It is not unusual in bad seasons for a single grower to lose £30 per acre in one season. In extreme cases every tuber is lost, as the produce will not even pay the cost of lifting.

The best-known disease of potatoes is caused by the growth of a fungus named *Phytophthora infestans*, within the tissues of the host plant, and this fungus has the peculiar property of piercing and breaking up the cellular tissues and setting up putrescence in the course of its growth. The parasite, which has a somewhat restricted range of host plants, chiefly invades the potato, *Solanum tuberosum*; the bittersweet, *S. Dulcamara*, and other species of *Solanum*. It is also very destructive to the tomato, *Lycopersicon esculentum*, and to all or nearly all

the other species of *Lycopersicum*. At times it attacks petunias and even scrophulariaceous plants, as *Anthocersis* and *Schizanthus*.

As a rule, although there are a few exceptions, the disease occurs wherever the potato is grown. It is known in South America in the home of the potato plant. In England the disease is generally first seen during the last ten days of July; its extension is greatly favoured by warm and showery weather. To the unaided eye the disease is seen as purplish brown or blackish blotches of various sizes, at first on the tips and edges of the leaves, and ultimately upon the leaf-stalks and the larger stems. On gathering the foliage for examination, especially in humid weather, these dark blotches are seen to be putrid, and when the disease takes a bad form the dying leaves give out a highly offensive odour. The fungus, which is chiefly within the leaves and stems, seldom emerges through the firm upper surface of the leaf; it commonly appears as a white bloom or mildew on the circumference of the disease-patches on the under surface. It grows within the tissues from central spots towards an ever-extending circumference, carrying putrescence in its course. As the patches extend in size by the growth of the fungus they at length become confluent, and so the leaves are destroyed and an end is put to one of the chief vital functions of the host plant. On the destruction of the leaves the fungus either descends the stem by the interior or the spores are washed by the rain to the tubers in the ground. In either case the tubers are reached by the fungus or its spores, and so become diseased. The fungus is very small in size, and under the microscope appears slightly whitish or colourless. The highest powers are required to see all parts of the parasite.

The accompanying illustration shows the habit and structure of the fungus. The letters A B show a vertical section through a fragment of a potato leaf, enlarged 100 diameters; A is the upper surface line, and B the lower; the lower surface of the leaf is shown at the top,

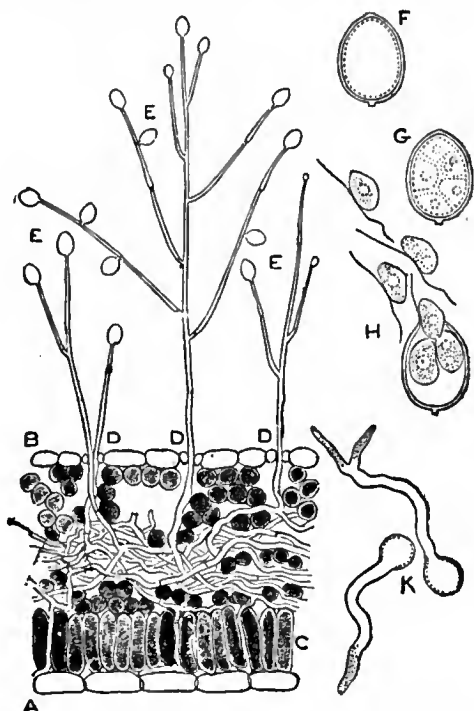

FIG. 2.—*Phytophthora infestans*. Fungus of Potato Disease.

the better to exhibit the nature of the fungus growths. Between A and B the loose cellular tissue of which the leaf is partly built up is seen in section, and at C the vertical palisade cells which give firmness to the upper surface of the leaf. Amongst the loose tissue of the leaf numerous transparent threads are shown; these are the mycelial threads or spawn of the fungus; wherever they touch the leaf-cells they pierce or break down the tissue, and so set up decomposition, as indicated by the darker shading. The lower surface of the potato leaf is furnished with numerous organs of transpiration or stomata, which are narrow orifices opening into the leaf and from which moisture is transpired in the form of vapour. Out of these small openings the fungus threads emerge, as shown at D, D, D. When the threads reach the air they branch in a tree-like manner, and each branch (sporangiophore) carries one or more ovate sporangia, as shown at E, E, E, which fall off and are carried by the wind. One is shown more highly magnified (400 diameters) at F; the contained protoplasm breaks up into a definite number of parts as at G, forming eight minute mobile bodies called "zoospores," each zoospore being furnished with two

extremely attenuated vibrating hairs termed "cilia," as shown at H. These zoospores escape and swim about in any film of moisture, and on going to rest take a spherical form, germinate and produce threads of mycelium as at K. The sporangia may also germinate directly without undergoing division. The mycelium from the germinating sporangia or zoospores soon finds its way into the tissues of the potato leaf by the organs of transpiration, and the process of growth already described is repeated over and over again till the entire potato leaf, or indeed the whole plant, is reduced to putridity.

The germinating spores are not only able to pierce the leaves and stems of the potato plant, and so gain an entry to its interior through the epidermis, but they are also able to pierce the skin of the tuber, especially in young examples. It is therefore obvious that, if the tubers are exposed to the air where they are liable to become slightly cracked by the sun, wind, hail and rain, and injured by small animals and insects, the spores from the leaves will drop on to the tubers, quickly germinate upon the slightly injured places, and cause the potatoes to become diseased. Earthing up therefore prevents these injuries, but where practised to an immoderate extent it materially reduces the produce of tubers. The labour entailed in repeated earthing up is also considered a serious objection to its general adoption.

The means of mitigating the damage done by this disease are (1) the selection of varieties found to resist its attacks; (2) the collection and destruction of diseased tubers so that none are left in the soil to become a menace to future crops; (3) care that no tubers showing traces of the disease are planted; (4) spraying with Bordeaux mixture at intervals from midsummer onwards. The last measure prevents the germination of the spores of the fungus on the leaves, and is a most useful mode of checking the spread of the disease; to be successful in its use, however, entails care in the preparation of the spray and thoroughness in its application. In spite of the many efforts in the direction of obtaining a resistant variety no great measure of success has been attained. The earlier varieties of potato appear to escape the disease almost entirely, as they are usually ready to be lifted before it becomes troublesome; while certain of the later varieties are much less prone to it than the majority. They do not appear, however, to maintain the same degree of immunity over a long period of years, but to become more and more open to the attack as the variety becomes older; nor do they always exhibit the same degree of immunity in different localities. Something may be done to mitigate the loss arising from the disease by selecting comparatively immune varieties from time to time.

Many ingenious attempts have been made to obtain a variety perfectly immune. Maule, thinking a hardier blood might be infused into the potato by crossing it with some of the native species, raised hybrids between it and the two common species of *Solanum* native in this country, *S. Dulcamara* and *S. nigrum*, but the hybrids proved as susceptible as the potato itself. Maule also tried the effect of grafting the potato on these two species and, though he succeeded, there is no record to show whether the product was any hardier than the parents. Dean (*Gard. Chron.*, Sept. 1876, p. 304) succeeded in grafting the potato on the tomato, and Messrs Sutton have carried out similar experiments on an extensive scale (*Journ. Roy. Hort. Soc.* 1899, xxiii. Proc. p. 20), but in no case have the variations produced proved disease-proof. Various experimenters, especially Fenn, have asserted that by engrafting an eye of one variety into the tuber of another, not only will adhesion take place but the new tubers will present great variety of character; this seems to be the case, but it can hardly be considered as established that the variations in question were the result of any commingling of the essences of the two varieties. The wound may simply have set up that variation in the buds the occasional existence of which has been already noted.

It is possible that the hybridizing of the potato with one or other of the wild types of tuberous *Solanums* may give rise to a variety which shall be immune, though unfortunately most are themselves liable to the attacks of the fungus, and one of the few crosses so made between the common potato and *Solanum Maglia* has exhibited the same undesirable trait. The form cultivated in England for some time under the name *Solanum tuberosum* (which, however, forms tubers and is probably not that known under this name by Lindley) seems so far to have escaped. In view of the fact that Biffen has proved that immunity from the attacks of a certain fungus in wheat is a transmissible recessive character reappearing in some of the individuals of the second generation, it would appear that there is great hope of securing an immune variety with the aid of this form. It is possible, too, that continued cultivation in the rich soil of gardens may induce that tendency to vary when seedlings are raised that is so marked a feature of the potato of commerce, in one or more of the other species of tuberous *Solanums*.

Another fungus attacking the leaves is *Macrosporium Solani* (fig. 3), but this attack usually comes earlier in the season than the foregoing. It is characterized by the curling of the leaves, which later show black spots due to the production of numerous dark spores in patches on the diseased leaves. The damage is often considerable, as the crop is greatly lessened by the interference with the functions of the leaf. The parasite may be held in check by spraying with Bordeaux mixture early in the season. The fungus passes the winter on pieces of leaf, &c., left on the ground. All such refuse should be cleared up and burned. A third fungus, *Cercospora concors*, also forms spots on the leaves and may be kept in check by the same means.



FIG. 3.—Portion of Leaf of Potato-Plant showing patches of a black mould, *Macrosporium Solani*, on the surface.

large numbers of *Bacillus solanacearum* in the tubes through which water is conveyed to the leaves from the roots. Their presence causes the appearance of blackish streaks in the stem and a dark ring some little distance below the surface in the tissues of the tuber. Tubers showing any trace of such a ring

Wilting of the foliage followed by the discoloration of the stem and branches is characteristic of a disease of the potato known as "Blackleg." This disease is due to the presence of

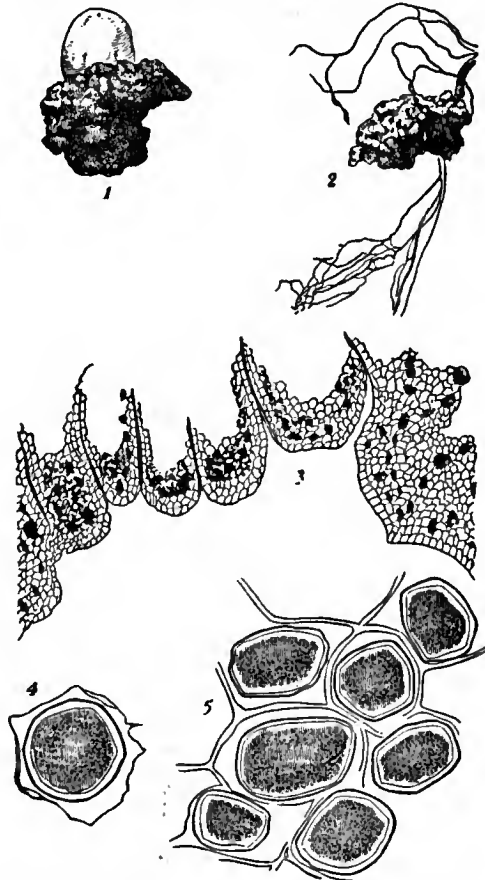

(From the *Journal of the Board of Agriculture and Fisheries*, by permission of the controller of H. M. Stationery Office.)

FIG. 4.—*Chrysosphyliis endobiotica* (*Oedomyces leproides*) in the Potato.

1 and 2, Tubers deformed by the fungus.
3, Section through diseased tissue showing dark masses of spores.
4 and 5, Tissue-cell, more highly magnified, showing enclosed spores.

should not be used for seed, and rotation of crops should be observed as a means of preventing the infection of the crop with the germ. Biting and sucking insects have been found to carry the bacilli from one plant to another.

The tubers frequently show scurfy or scab-like spots upon their surface, thus greatly depreciating their value for market purposes. The fungus, *Sorosporium scabies*, which is the cause of the scab, does not penetrate into the flesh of the tuber, nor detract from its edible properties. Excess of lime in the soil is said to favour the development of the fungus. Similar spots are produced on potatoes in America by the fungus *Oospora scabies*, and in both cases, if affected "seed" potatoes are steeped in a solution of $\frac{1}{2}$ pint formalin in 15 gallons of water for two hours before planting, the attack on the resulting crop is materially lessened. The fungus, *Oedomyces leproides*, produces large, blackish, irregular warts which sometimes involve the whole surface of the tuber. This disease is of recent introduction into Great Britain, but bids fair to become very troublesome. The spores of the fungus pass the winter in the soil and the delicate mycelium attacks the young shoots in the summer. These become brown, finally blackish and greatly contorted until a large scab is formed on the developing tuber, whence the name by which the disease is known—"black scab." Diseased potatoes left in the soil and even slightly diseased "sets" are a source of infection of succeeding crops. Rotation must be observed and no diseased sets planted.

The rotting of tubers after lifting may be due to various causes, but the infection of the tubers by the *Phytophthora* already mentioned is a frequent source of this trouble, while "Winter Rot" is due to the fungus *Nectria Solani*. This fungus finds conditions suitable for growth when the potatoes are stored in a damp condition; rotting from this cause rarely occurs when they are dried before being placed in heaps. The first signs of this fungus is the appearance of small white tufts of mycelium bursting through the skin of the tuber, the spores of the fungus being carried at the tips of the threads forming these tufts. This form of fruit is succeeded by others which have received different names, and lastly by the mature *Nectria* which forms minute red flask-shaped perithecia on parts of the rotted potatoes that have dried up. The intermediate forms are known as *Monosporium*, *Fusarium* and *Cephalosporium*. The pieces of dried-up potato with the spores of *Nectria* upon them are a source of infection in the succeeding year, and care should be taken that diseased tubers are not planted. Flowers of sulphur plentifully sprinkled over the potatoes before storing has been found to check the spread of the rot in the heap.

POTATO RACE, a running contest, where the winner is the first who collects in a basket or other receptacle a number of potatoes, usually eight, placed, as a rule two yards apart, along a straight line, and then crosses a finish line five or ten yards farther on.

POTATO WAR (*Kartoffelkrieg*), the name given by the Prussians to the War of the Bavarian Succession in 1778-79. The Prussians and a Saxon contingent, commanded by Frederick the Great and his brother Prince Henry, were opposed to two Austrian armies under Loudon and Lacy. The operations consisted almost entirely of manœuvres which had for their object the obtaining or the denial to the enemy of food-supplies. The war thus acquired the name of *Kartoffelkrieg*. Its duration was from the 3rd of July 1778 to the assembly of the congress of Teschen on the 10th of March 1779, and its total cost £4,350,000 and 20,000 men to all parties. The war may be studied from the military point of view as an extreme example of what Clausewitz calls "war with a restricted aim."

POTAWATOMI (properly *Potawatmik*, fire-makers, in allusion to their secession from the Ojibway, and their establishment of a separate council-fire), a tribe of North-American Indians of Algonquian stock. When first known (about 1670), they lived around Green Bay, Wisconsin. They subsequently moved south and eventually settled in lower Michigan. They were allied with the French in their wars against the Iroquois and took part in the conspiracy of Pontiac (*q.v.*). In the War of Independence they fought for England, as also in that of 1812. In 1846 most of them were removed to a reservation in Kansas. Of these the majority have abandoned their tribal relations and become citizens. Others are in Wisconsin and the bulk in Oklahoma. They now number some 2500.

POTCHEFSTROOM, a town of the Transvaal, 88 m. S.W. of Johannesburg and 222 m. N.E. of Kimberley by rail. Pop. (1904), 9348, of whom 6014 were whites. The town stands 4100 ft. above the sea on the banks of the Mooi River, 15 m.

above its junction with the Vaal. The streets are lined with fine willow trees, and there are public grounds in which are nurseries and a showyard. Golf links add to the attractions of the place, which is one of the healthiest in the Transvaal. In the neighbourhood are gold-mines; the reef appearing to be a continuation of the Witwatersrand reefs. The Vaal river goldfields, of which Venterskroon is the centre, are 16 to 20 m. south-east of Potchefstroom.

Potchefstroom was founded in November 1838 by Hendrik Potgieter, and is the oldest town in and first capital of the Transvaal. In 1862 it was the scene of civil war between rival Boer factions. In 1880-81 the garrison camped outside the town was besieged by Boers under Commandant P. A. Cronje. The British troops (250 in number) were confined to a fort 25 yds. square and lost over a third of their strength in killed and wounded before they surrendered on the 21st of March, the investment having begun on the 18th of December 1880. Charges of treachery were brought against Cronje for failing to notify the besieged that an armistice had been agreed to by the Boer leaders. Of this armistice Colonel R. W. C. Winsloe, who was in command of the British, became aware before the surrender took place. On the suggestion of Commandant General Joubert the capitulation was considered as cancelled and a detachment of British troops reoccupied the town until the conclusion of peace. In the Anglo-Boer War of 1899-1902 Potchefstroom was occupied by the British without opposition. (See TRANSVAAL: *History*.)

POTEMKIN, GRIGORY ALEKSANDROVICH, PRINCE (1739-1791), Russian statesman, was born at Chizheva near Smolensk. He was educated at the Moscow University, and in 1755 entered the "Reiter" of the Horse Guards. His participation in the *coup d'état* of the 8th of July 1762 attracted the attention of the new empress, Catherine II., who made him a *Kammerjunker* and gave him a small estate. The biographical anecdotes relating to him during the next few years are obscure and mostly apocryphal. In 1768 he quitted the Guards and was attached to the court as a *Kammerherr*, but in 1769 he volunteered for the Turkish War and distinguished himself at Khotin, Focshani and Larga, besides routing the Turks at Olta. It was not till 1771 that he became Catherine's prime favourite. In that year he was made an adjutant-general, lieutenant-colonel of the Preobrazhensky Guards, a member of the council of state, and, in the words of a foreign contemporary diplomatist, "the most influential personage in Russia." Somewhat later he was created a count, and appointed commander-in-chief and governor-general of "New Russia," as the conquered provinces in the Ukraine were then called. In 1776, at Catherine's request, the emperor Joseph II. raised Potemkin to the rank of a prince of the Holy Roman Empire. In 1775 he was superseded in the empress's graces by Zavadovsky; but the relations between Catherine and her former lover continued to be most friendly, and his influence with her was never seriously disturbed by any of her subsequent favourites. A whole mass of facts testify to the enormous and extraordinary influence of Potemkin during the next ten years. His correspondence with the empress was uninterrupted. The most important state documents passed through his hands. Catherine loaded him with gifts. He was deeply interested in the question of the southern boundaries of Russia and consequently in the fate of the Turkish Empire. It was he who, in 1776, sketched the plan for the conquest of the Crimea which was subsequently realized; and about the same period he was busy with the so-called "Greek project," which aimed at restoring the Byzantine Empire under one of Catherine's grandsons. In many of the Balkan states he had well-informed agents. After he became field marshal, in 1784, he introduced many reforms into the army, and built a fleet in the Black Sea, which, though constructed of very bad materials, did excellent service in Catherine's second Turkish War (1787-92). His colonizing system was exposed to very severe criticism, yet it is impossible not to admire the results of his stupendous activity. The arsenal of Kherson, begun in 1778, the harbour of Sevastopol and the

new fleet of fifteen liners and twenty-five smaller vessels, were monuments of his genius. But there was exaggeration in all he attempted. He spared neither men, money, nor himself in attempting to carry out his gigantic scheme for the colonization of the south Russian steppes; but he never calculated the cost, and more than three-quarters of the design had to be abandoned when but half finished. Catherine's famous expedition to the south in 1787 was a veritable triumph for Potemkin; for he contrived to conceal all the weak points of his administration and to present everything in a rose-coloured light. On this occasion he received the title of prince of Tauris. The same year the second Turkish War began, and the founder of New Russia took upon himself the responsibilities of commander-in-chief. But the army was ill-equipped and unprepared; and Potemkin in an hysterical fit of depression gave everything up for lost, and would have resigned but for the steady encouragement of the empress. Only after Suvarov had valiantly defended Kinburn did he take heart again, and besiege and capture Ochakov and Bender. In 1790 he conducted the military operations on the Dniester and held his court at Jassy with more than Asiatic pomp. In 1791 he returned to St Petersburg where, along with his friend Bezborodko (*q.v.*), he made vain efforts to overthrow the new favourite, Zubov, and in four months spent 850,000 roubles in banquets and entertainments, a sum subsequently reimbursed to him from the treasury. Then the empress grew impatient and compelled him (1791) to return to Jassy to conduct the peace negotiations as chief Russian plenipotentiary. On the 5th of October, while on his way to Nikolayev, he died in the open steppe, 40 m. from Jassy, in consequence of eating a whole goose while in a high state of fever.

Very various are the estimates of Potemkin. Neither during his life nor after his death did any two people agree about him. The German pamphlet: *Pansalim Fürst der Finsterniss und seine Geliebte*, published in 1794, is a fair specimen of the opinion of those who regarded him as the evil genius of Catherine and of Russia. But there were many, including the empress herself, who looked upon him as a man of manifold and commanding genius. He was indubitably the most extraordinary of all the Catherinian favourites. He was an able administrator, but wanting in self-control. Licentiousness, extravagance and an utter disregard for human life were his weak points, but he was loyal, generous and magnanimous. Nearly all the anecdotes related of him by Helbig, in the biography contributed by him to the journal *Minerva* (1797-1800), and freely utilized by later biographers, are absolutely worthless.

See V. A. Bilbasov, *Geschichte Katharinas II.* (Berlin, 1891-1893); C. de Larivière, *Catherine la Grande d'après sa correspondance* (Paris, 1895); Anonymous, *La Cour de Catherine II. Ses collaborateurs* (St Petersburg, 1899); A. V. Lopukhin, *Sketch of the Congress of Jassy, 1791* (Rus.; St Petersburg, 1893); *The Papers of Prince Potemkin, 1744-1793* (Rus.; St Petersburg, 1893-1895). (R. N. B.)

POTENTILLA (nat. order Rosaceae, *q.v.*), a border and rock-garden plant. Many of the species bear brilliantly coloured flowers and graceful foliage. A soil of a good loamy staple, enriched with rotten dung, will grow the potentilla to perfection. Potentillas may be increased, though not very freely, by parting them into as many pieces as there are crowns, the side growths being those which can usually be thus separated. This may be done in autumn or spring, and the plants will generally bloom the following season. The species and some of the varieties reproduce true from seed, and are readily increased by that means. The following are some of the best kinds: *aurea*, *atrosanguinea*, *davurica*, *formosa*, *nitida*, *n. atro-rubra*, *speciosa*, *tridentata* and *villosa*.

POTENTIOMETER, an instrument for the measurement of electromotive force and also of difference of electric potential between two points. The term potentiometer is usually applied to an instrument for the measurement of steady or continuous potential difference between two points in terms of the potential difference of the terminals of a standard voltaic cell of some kind, such as a Clark or Weston cell. The modern potentiometer has been developed out of an arrangement due to J. C. Poggendorff, employed also by J. Latimer Clark, but converted

into its modern direct reading form by J. A. Fleming in 1885 (see *Industries*, 1886, i. 152). In principle the modern potentiometer consists of an arrangement by means of which any potential difference not exceeding a certain assigned value can be compared with that of a standard cell having a known electromotive force. In simplest form it consists of a long, straight, fine, uniform wire stretched over a divided scale. The ends of this wire are connected to one or more secondary cells of constant electromotive force, a variable resistance being interposed so as to regulate the current flowing through the fine wire. To one end of this fine wire is attached one terminal of a sensitive galvanometer. Sliding contacts can be moved along the fine wire into any position. Supposing that the scale under this wire is divided into 2000 parts and that we are in possession of a standard Clark cell, the electromotive force being known at various temperatures, and equal, say, to 1.434 volts at 15° C. The first process is to set the potentiometer. The slider is placed so as to touch the fine wire at division No. 1434 on the fine wire, and the Clark cell is connected in between the sliding contact and one terminal of the galvanometer, so that its negative pole is connected through the galvanometer with that end of the fine wire to which the negative pole of the working battery is attached. The resistance in circuit with the fine wire is then altered until the galvanometer shows no deflection. We then know that the fall of potential down the 2000 divisions of the fine wire must be exactly 2 volts. If then we substitute for the standard cell any other source of electromotive force, we can move the slider into another position in which the galvanometer will show no deflection. The scale reading then indicates directly the electromotive force of this second source of potential. Thus, for instance, if an experiment were made with a Leclanché cell, and if the balancing-point were found to be at 1500 divisions on the scale, the electromotive force would be determined as 1.500 volts. Instead of adjusting in this manner the electromotive force of any form of cell, if we pass any constant current through a known resistance and bring wires from the extremities of that resistance into connexion with the slider and the galvanometer terminal, we can in the same way determine the fall of potential down the above resistance in terms of the electromotive force of the standard cell and thus measure the current flowing through the standard resistance.

In the practical form the potentiometer wire is partly replaced by a number of coils of wire, say 14 (see fig. 1), and the potentiometer wire itself has a resistance equal to one of these coils. One terminal of the galvanometer can then be shifted to the junction

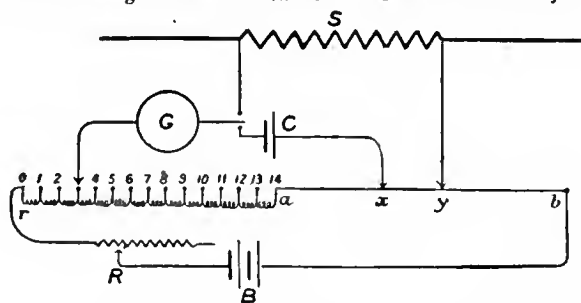

FIG. 1.

between any pair of consecutive coils and the slider shifted to any point on the potentiometer wire. By such an arrangement the potential difference can be measured of any amount from 0 to 1.5 volts. In some cases the potentiometer wire is wholly replaced by a series of coils divided into small subdivisions. We may employ such a potentiometer to measure large potential difference greater than the electromotive force of the working battery, as follows: The two points between which the potential difference is required are connected by high resistance, say of 100,000 ohms or more, and from the extremities of a known fraction of this resistance, say, 1/100 or 1/1000 or 1/10,000 wires are brought to the potentiometer and connected in between the slider and the corresponding galvanometer terminal. We can thus measure as described the drop in volts down a known fraction of the whole high resistance and therefore calculate the fall in potential down the whole of the high resistance, which is the potential difference required. The potentiometer and the divided resistance constitute a sort of electrical

scaleyard by means of which any electromotive force or difference of potential can be compared with the electromotive force of a standard cell. Very convenient and practical forms of potentiometer have been devised by Crompton (fig. 2), Nalder, Elliot Bros., Fleming

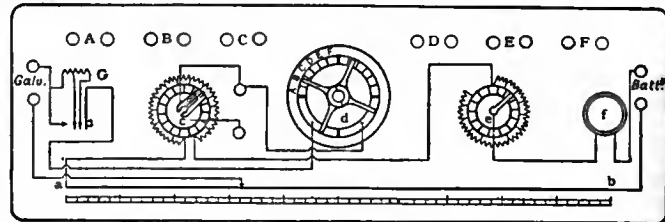

FIG. 2.—Diagram of the Internal Connexions of a Crompton Potentiometer.

- a b, The scale wire.
 c, The set of equal potentiometer coils in series with it.
 d, The double pole switch connecting the 6 pairs of terminals A B C D E F in succession to the slide contacts.
 e, The resistance coils.
 f, The rheostat.
 g, The galvanometer key.
 A, B, C, D, E, F, Terminals to which standard cell or voltages to be tested are attached.

and others. An essential accompaniment therefore of the potentiometer is a series of standard low resistances, say of 0.1, 0.01, 0.001 ohm, and also a series of higher resistances divided into known fractions. In practical work, the low resistances take the form of certain strips of metal which have on them two pairs of terminals, one termed "current terminals," and the other "potential terminals." These resistance strips, as they are called, are carefully adjusted so that the resistance between the potential terminals has a known low value. In order to measure the value of a continuous electric current, and therefore to calibrate any amperemeter we proceed as follows: The amperemeter is placed in series with a suitable low resistance strip, say of 0.01 ohm. From the potential terminals of the strip, wires are brought to the potentiometer so as to determine their potential difference in terms of the electromotive force of the standard Clark cell. An observation is then taken of the reading of the amperemeter and of the fall of resistance down the low resistance when a certain steady current is passing through the strip and amperemeter. Supposing that the potential fall down the strip is found to be .981 volt, the strip difference having a resistance of 0.1 ohm, it would be seen that the current passing through the strip was 98.1 amperes. If then the amperemeter scale reading was 100 it would show an error of that scale reading of minus 1.9 amperes or nearly 2%. In the same manner the potentiometer may be used to calibrate a voltmeter by the aid of a divided resistance of known value.

In electrical measurements connected with incandescent electric lamps the potentiometer is of great use, as it enables us to make accurately and nearly simultaneously two measurements, one of the current through the lamp and the other of the potential difference of the terminals. For this purpose a resistance, say, of one ohm is placed in series with the lamp and a resistance of 100,000 ohms placed across the terminals of the lamp; the latter resistance is divided into two parts, one consisting of 1000 ohms and the other of 99,000 ohms. The potentiometer enables us to measure therefore the current through the lamp by measuring the drop in volts down a resistance in series with it and the potential difference of the terminals of the lamp by measuring the drop in volts down the 100th part of the high resistance of 100,000 ohms connected across the terminals of the lamp.

Standard Cells.—A necessary adjunct to the potentiometer is some form of standard cell to be used as a standard of electromotive force. In the case of the Clark standard cell above mentioned the elements are mercury and zinc separated by a paste of mercurous sulphate mixed with a saturated solution of zinc sulphate. Other voltaic standards of electromotive force are in use, such as the Weston cadmium cell, the Helmholtz calomel cell, and the standard Daniell cell. The Clark cell is made in two forms, the board of trade or tubular form, and the H form of cell devised by Lord Rayleigh. The German experts seem to favour the latter form; the specification issued by the Physikalisch-Technische Reichsanstalt of Berlin may be found in the *Electrician*, xxxi. 265-266. The electromotive force of the cell diminishes with rise of temperature, the board of trade value being 1.434 volts at 15° C. and 1.434 (1 - 0.00077 (t - 15)) volts at t° C. A more exact expression is obtained if instead of 0.00077 the quantity 0.00078 + 0.000017 (t - 15) is used. In the Weston standard cell cadmium and cadmium sulphate are substituted for zinc and zinc sulphate; it has the advantage of a much smaller coefficient of temperature variation than the Clark cell. It is most conveniently made up in a glass vessel of H form, pure mercury and cadmium amalgam being the two elements (fig. 3).

¹ According to K. Kahle and W. Wien, the electromotive force of the H form of Clark cell is 1.4322 volts at 15° C.

and when made as directed below it has at t° C. an electromotive force E , volts, such that

$$E = 1.0184 - 0.0000406 (t - 20) - 0.0000095 (t - 20)^2 + 0.00000001 (t - 20)^3.$$

After the platinum wires have been sealed through the glass, a little aqua regia is placed in the cell until bubbles of gas arise from the platinum, when it is thrown out and replaced by a solution of mercurous nitrate. Then, by the use of another piece of platinum as anode, mercury is electrolytically deposited upon the platinum, which may also be amalgamated by making it white hot in a Bunsen flame and plunging it in mercury. To prepare the cadmium amalgam, one part of pure cadmium is dissolved in six parts of pure mercury, and the product while warm and fluid is placed in one limb of the cell and warmed, to ensure perfect contact with the platinum wire. The cadmium sulphate solution is prepared by digesting a saturated solution of cadmium sulphate with cadmium hydroxide to remove free acid, care being taken not to raise the temperature above 70° C., and then by digesting it still further with mercurous sulphate until no more precipitation occurs. The cadmium sulphate solution must be saturated and have free crystals of the salt in it. The mercurous sulphate must be free from acid, and made neutral by trituration with finely divided mercury. In making the paste, so much cadmium sulphate must be added that a saturated solution of that salt is formed and is present in the cell. The cell has the electromotive force above stated if the amalgam of cadmium has from 6 to 13 parts of mercury to 1 of cadmium. The German investigators seem to have a great preference for the H form of cell, but it is clear that a narrow tubular cell of the British board of trade form not only comes more quickly to the temperature of the water bath in which it is placed, but is more certain to be wholly at one temperature. In a modification of the H form devised by F. E. Smith, of the National Physical Laboratory (*Phil. Trans.*, A, 207, pp. 393-420), a contraction formed in the side of the vertical tube tends to hold the contents in place. Fig. 4 shows this cell, hermetically sealed, mounted in a brass case.

FIG. 3.—Lord Rayleigh's H form of Standard Voltaic Cell.

In cases when great accuracy is not required, a Daniell cell can be used as a standard of electromotive force. The form designed by J. A. Fleming (*Phil. Mag.*, 20, p. 126) consists of a U tube, one leg of which contains a rod of pure amalgamated zinc, and the other a rod of freshly electrotyped copper. The legs are filled with solutions of zinc sulphate and copper sulphate, the zinc rod being in the zinc sulphate and the copper rod in the copper sulphate. When so made, the cell has an electromotive force of 1.072 volts and no sensible temperature variation. The solutions are made by dissolving the purest recrystallized sulphate of copper and sulphate of zinc in distilled water. For the zinc solution, take 55.5 parts by weight of crystals of zinc sulphate ($ZnSO_4 \cdot 7H_2O$) and dissolve in 44.5 parts by weight of distilled water; the resulting solution should have a specific gravity of 1.200 at about 20° C. For the sulphate of copper solution, take 16.5 parts by weight of pure crystals of copper sulphate ($CuSO_4 \cdot 5H_2O$) and dissolve in 83.5 parts by weight of water; the resulting solution should have a specific gravity of 1.100 at 20° C. The solutions should be adjusted exactly to these densities and kept in stock bottles, from which the reservoirs of the cell should be filled up as required.

A form of potentiometer employing a vibration galvanometer and suitable for alternating current measurement by null methods has been devised by Dr Drysdale (see *Proc. Phys. Soc. Lond.* 1909, 21, 561.)

See J. A. Fleming, *Handbook for the Electrical Laboratory and Testing Room*, vol. i. (London, 1903)—vol. i contains on pp. 108-110 an extensive list of various original memoirs published on the Clark and Weston cells; G. D. Aspinall Parr, *Electrical Engineering Measuring Instruments* (London, 1903); W. C. Fisher, *The Potentiometer and its Adjuncts* (London, 1906).

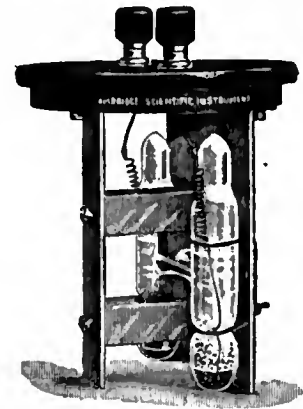

FIG. 4.—Method of mounting Weston Normal Cell. Brass case removed.

See J. A. Fleming, *Handbook for the Electrical Laboratory and Testing Room*, vol. i. (London, 1903)—vol. i contains on pp. 108-110 an extensive list of various original memoirs published on the Clark and Weston cells; G. D. Aspinall Parr, *Electrical Engineering Measuring Instruments* (London, 1903); W. C. Fisher, *The Potentiometer and its Adjuncts* (London, 1906).

See J. A. Fleming, *Handbook for the Electrical Laboratory and Testing Room*, vol. i. (London, 1903)—vol. i contains on pp. 108-110 an extensive list of various original memoirs published on the Clark and Weston cells; G. D. Aspinall Parr, *Electrical Engineering Measuring Instruments* (London, 1903); W. C. Fisher, *The Potentiometer and its Adjuncts* (London, 1906).

POTENZA (anc. *Potentia*), a town and episcopal see of Basilicata, Italy, capital of the province of Potenza, 103 m. by rail E. by S. of Naples. Pop. (1901), 12,313 (town); 16,163 (commune). Situated 2700 ft. above sea-level on an isolated hill above the Basento (anc. *Casuentus*), it is much exposed to winds and has a far more northerly climate than its position ($40^{\circ} 40' N.$) implies, and is indeed one of the coldest places in Italy (mean temp. Jan 37.8° , July 70.9° , for whole year $53^{\circ} F.$). It has been almost entirely rebuilt since the earthquake of 1857. It has a school of the industrial arts and sciences, grows good wine, and makes bricks.

The ancient *Potentia* lay some 470 ft. lower, by the river. Its name shows that it was of Roman origin, and its importance was no doubt due to its position at the intersection of the road leading west to the Via Popillia and north-east to the Via Appia, with the Via Herculia. No remains are visible, but a considerable number of inscriptions have been found.

Potentia must be distinguished from *Potentia* in Picenum, on the Adriatic coast, near the modern Porto di Recanati, a colony founded in 184 B.C., the same year as Pisaurum, but of which little is known.

The abandonment of the old site and the erection of the new town probably date from the earthquake of 1273. By the Angevines Potenza was made a domain of the San Severino family; in the beginning of the 15th century it was held by Francesco Sforza, and in 1435 it passed to the Guevara family; the Loffredi, who succeeded by marriage, continued in possession till the abolition of the great fiefs. In 1694 there was a severe earthquake; and the more terrible earthquake which on the 16th and the 17th of December 1857 passed through southern Italy, and in Basilicata alone killed 32,475 persons, laid the greater part of Potenza in ruins. In 1860 it was the first town to rise against the Neapolitan government.

POTGIETER, EVERHARDES JOHANNES (1808-1875), Dutch prose writer and poet, was born at Zwolle, in Overijssel, on the 17th of June 1808. He started life in a merchant's office at Antwerp. In 1831 he made a journey to Sweden, described in two volumes, which appeared at Amsterdam in 1836-1840. Soon afterwards he settled in Amsterdam, engaged in commercial pursuits on his own account, but with more and more inclination towards literature. With Heije, the popular poet of Holland in those days, and Bakhuizen van den Brink, the rising historian (see also GROEN VAN PRINSTERER), Potgieter founded *De Musen* ("The Muses," 1834-1836), a literary review, which was, however, soon superseded by *De Gids* ("The Guide"), a monthly, which became the leading magazine of Holland. In it he wrote, mostly under the initials of "W. D—g," a great number of articles and poems. The first collected edition of his poems (1832-1868) appeared in 2 vols. (Haarlem, 1868-1875), preceded by some of his contributions to *De Gids*, in 2 vols. also (Haarlem, 1864), and followed by 3 vols. of his *Studien en Schetsen* ("Studies and Sketches," Haarlem, 1879). Soon after his death (Feb. 3, 1875) a more comprehensive edition of Potgieter's *Verspreide en Nagelaten Werken* ("Miscellaneous and Posthumous Works") was published in 8 vols. by his friend and literary executor, Johan C. Zimmerman (Haarlem, 1875-1877), who likewise supervised a more complete edition of Potgieter's writings which appeared at Haarlem in 1885-1890 in 19 vols. Of Potgieter's *Het Noorden in Omtrekken en Tafreelen* ("The North in Outlines and Pictures") the third edition was issued in 1882, and an *édition de luxe* of his poems followed at Haarlem in 1893. Under the title of *Personen en Onderwerpen* ("Persons and Subjects") many of Potgieter's criticisms had collectively appeared in 3 vols. at Haarlem in 1885, with an introduction by Busken-Huet.

Potgieter's favourite master among the Dutch classics was Hooft, whose peculiarities in style and language he admired and imitated. The same vein of altruistic, if often exaggerated and biased, abhorrence of the wonted conventionalities of literary life runs through all his writings, even through his private correspondence with Huet, parts of which have been published. Potgieter remained to his death the irreconcilable enemy of the Dutch "Jan Salie," as the Dutchman is nicknamed who does not believe in the regeneration of the Dutch people. Potgieter held up the Netherlanders of the golden age of the

16th and 17th centuries as models to be emulated. In these views he essentially differed from Huet. Yet the two friends worked harmoniously together; and when Potgieter reluctantly gave up *De Gids* in 1865, it was Huet whom he chose as his successor. Both then proceeded to Italy, and were present at the Dante festivities at Florence, which in Potgieter's case resulted in a poem in twenty stanzas, *Florence* (Haarlem, 1868). In Holland Potgieter's influence has been very marked and beneficial; but his own style, that of ultra-purist, was at times somewhat forced, stilted and not always easily understood. (H. Tr.)

POTHIER, ROBERT JOSEPH (1699-1772), French jurist, was born at Orleans on the 9th of January 1699. He studied law for the purpose of qualifying for the magistracy, and was appointed in 1720 judge of the presidial court of Orleans, thus following in the footsteps of his father and grandfather. This post he held for fifty-two years. He paid particular attention to the correction and co-ordination of the text of the *Pandects*, his *Pandectae Justinianae in novum ordinem digestae* (Paris and Chartres, 1748-1752) being a classic in the study of Roman law. In 1749 he was made professor of law in the university of Orleans. He wrote many learned monographs on French law, and much of his work was incorporated almost textually in the French Code Civil. He died at Orleans on the 2nd of March 1772. Of his numerous treatises the following may be specially mentioned: *Traité des obligations* (1761); *Du Contrat de vente* (1762); *Du Contrat de bail* (1764); *Du Contrat de société* (1765); *Des Contrats de prêt de consommation* (1766); *Du Contrat de dépôt et de mandat* (1766); *Du Contrat de nantissement* (1767), &c. His works have several times been published in collected form (edited by Giffrein, 1820-1824; by Dupin, 1823-1825, and by Bugnet, 2nd ed. 11 vols. 1861-1862).

See Dupin, *Dissertation sur la vie et les ouvrages de Pothier* (Paris, 1825), and Frémont, *Vie de R. J. Pothier* (Orléans, 1850).

POTHOOK, an S-shaped metal hook for suspending a pot over a fire. While one extremity is hooked to the handle of the pot, the other is caught upon an iron crane moving on a pivot over the fire. Modern cooking-ranges have obviated the necessity for this arrangement, but it is still to be seen in great numbers of country cottages and farmhouse kitchens all over England, and in small artisans' houses in the west midlands and the north. In the elementary teaching of writing the "pot-hook" is a script of similar shape.

POTI, a seaport of Russian Transcaucasia, in the government of Kutais, at the mouth of the Rion on the coast of the Black Sea, 193 m. by rail W.N.W. of Tiflis and 35 m. by sea N. of Batum. Pop. (1882), 3112; (1897), 7666. The white walls of the fortress contrast with the green trees which surround them, and the lighthouse, 117 ft. high, is visible 17 m. Situated in a marshy delta not more than 2½ ft. above the level of the river, Poti is extremely unhealthy, fever and ague prevailing in summer and autumn. The Russians have improved the town and port, but the latter is still exposed to west and south-west gales. A new entrance was constructed in 1905, and a new inner harbour was at the same time under construction. The shipping trade amounts to £500,000 to £600,000 a year, almost entirely manganese ore, with some maize.

Poti represents the ancient Phasis, a commercial colony of the Greek city of Miletus. The present fortress was built in 1578 by Sultan Murad III. of Turkey at the time of a war with Persia. In 1640 it was destroyed by the Imeretians (Georgians), but it was restored and enlarged. The town was a great slave market. It was captured by the Russians in 1812 and 1829.

POTLATCH, a term, corrupted from a Nootka Indian word for "gift," for a ceremonial custom among some of the Indian tribes of north-west America, consisting in the distribution by an individual of his property among his friends and neighbours, who make equivalent gifts, with interest, in return.

POTOCKI, IGNATY (1741-1809), Polish statesman and writer, son of Eustachy Potocki, general of artillery of the army of Lithuania, was born at Podhajce. He was educated first at Warsaw beneath the eye of the pedagogic reformer Stanislaw Konarski (1700-1773), and subsequently in Italy, where he proposed to take orders. On returning home, however, he

abandoned this idea, and as a member of the newly instituted commission of education rendered invaluable services to his country for the next sixteen years. He earnestly desired a reform of the constitution also, and was thus attracted to the party of the Czartoryscy. Elected deputy to every diet since 1778, he was a conspicuous member of the patriotic opposition. In matters of importance nothing was done without his advice, and he was esteemed as much for his character as for his talents. His influence was at its height during the Four Years' Diet, 1788-1792. He was appointed a member of the committee for the reform of the constitution, defended eloquently the right of the towns to the franchise, and was an advocate of an alliance with Prussia. Thus he was one of the creators of the constitution of the 3rd of May 1791, although his aristocratic antecedents prevented him from going the lengths of the more radical reformers. On the formation of the confederation of Targowica, Potocki emigrated to Dresden; but on the outbreak of the revolution of 1794 returned to Poland, was appointed a member of the national government, and entrusted with the conduct of foreign affairs. On the fall of Warsaw he surrendered to Suvarov and was sent to Russia, where he remained till 1796. On his return to Poland he retired to the village of Klimuntowo, where for the next thirteen years he devoted himself to literature. At the end of the war of 1809 he was commissioned to go to Vienna to present to Napoleon the petitions of the Galicians for the incorporation of their province with the grand duchy of Warsaw. He died at Vienna the same year. The most notable of Potocki's works is: *Vom Entstehen und Untergange der polnischen Konstitutionen vom 3ten May 1791* (Lemberg, 1793).

See August Sokolowski, *Illustrated History of Poland* (Pol.), vol. iv. (Vienna, 1901). (R. N. B.)

POTOCKI, STANISLAW FELIX (1752-1805), Polish politician, son of Franciszek Salezy Potocki, palatine of Kiev, of the Tulczyn line of the family, was born in 1752. He entered the public service, and owing to the influence of his relations became grand standard-bearer of the Crown at the age of twenty-two. In 1782 he was made palatine of Russia, in 1784 a lieutenant-general, and in 1789 he purchased the rank of a general of artillery from the Saxon minister, Brühl, for 20,000 ducats. Elected deputy for Braclaw at the famous Four Years' Diet, he began that career of treachery which was to terminate in the ruin of his country. Yet his previous career had awakened many hopes in him. A *grand seigneur* ruling patriarchally in his vast estates, liberal, enlightened, a generous master and a professed patriot, his popularity culminated in 1784 when he presented an infantry regiment of 400 men as a free gift to the republic. But he identified the public welfare with the welfare of the individual magnates. His scheme was the division of Poland into an oligarchy of autonomous grandees exercising the supreme power in rotation (in fact a perpetual interregnum), and in 1788 he won over to his views two other great lords, Xavier Branicki and Severin Rzewuski. The election of Malachowski (*q.v.*) and Kazimierz Sapieha as marshals of the diet still further alienated him from the Liberals; and, after strenuously but vainly opposing every project of reform, he retired to Vienna whence he continued to carry on an active propaganda against the new ideas. He protested against the constitution of the 3rd of May 1791, and after attempting fruitlessly to induce the emperor Leopold to take up arms "for the defence of the liberties of the republic," proceeded with his friends in March 1792 to St Petersburg, and subsequently with the connivance of the empress Catherine formed the confederation of Targowica for the maintenance of the ancient institutions of Poland (May 14, 1792), of which he was the marshal, or rather the dictator, directing its operations from his castle at Tulczyn. When the May constitution was overthrown and the Prussians were already in occupation of Great Poland, Potocki (March 1793) went on a diplomatic mission to St Petersburg; but, finding himself duped and set aside, retired to Vienna till 1797, when he settled down at Tulczyn and devoted himself for the remainder of his life to the improvement of his estates. He wrote *On the*

Polish Succession (Pol.) (Amsterdam, 1789); *Protest against the Succession to the Throne* (Pol.) (ibid. 1790); and other political works.

See Friedrich Schulz, *Poland in the year 1793* (Pol.) (Warsaw, 1899); Josef Zajacek, *History of the Revolution of 1794* (Pol.) (Lemberg, 1881). (R. N. B.)

POTOMAC, a river in the east central part of the United States, having its source in the Alleghany Mountains and flowing S.E. into Chesapeake Bay. It is formed by the union of its north and south branches, about 15 m. S.E. of Cumberland, Maryland. The main stream has a length of about 450 m. and is navigable for large vessels for 113 m. above its mouth. The north branch, about 110 m. long, rises in the north-eastern part of West Virginia, pursues a north-easterly course, and forms part of the boundary between Maryland and West Virginia. The south branch has its sources in Highland county, Va., and in Pendleton county, W.Va., and flows north-east for about 140 m. until it joins the north branch. From the junction of these two streams until it reaches Harper's Ferry the Potomac river separates Maryland from West Virginia. At Harper's Ferry it receives the waters of the Shenandoah river and cuts through the Blue Ridge Mountains in a gorge noted for its scenic beauty. From this point to its mouth it forms the boundary between Virginia and Maryland. The stream crosses the Blue Ridge Mountains at an elevation of about 245 ft., and at Georgetown (Washington), 62 m. distant, it meets tidewater. Of this descent about 90 ft. occurs about 15 m. above Washington, at the Great Falls, a series of rapids about a mile long and including a cataract about 35 ft. high. Three and a half miles above Washington are the Little Falls, which mark the head of navigation. Large vessels, however, are prevented by a bridge from proceeding above Georgetown. At Washington there are two channels, with respective depths at mean low water of 18 and 21 ft. Large sums have been spent since 1870 on improving these channels. A few miles below the city the river broadens into a deep tidal estuary from $2\frac{1}{2}$ to 7 m. wide; and channels 24 ft. deep and 200 ft. wide through all the shoals were secured by the project of 1899. The Anacostia river, or "East Branch," which flows into the Potomac just south of Washington, is navigable for large vessels for about 2 m. and for small scows and lighters as far as Bladensburg, Md., $8\frac{3}{4}$ m. above its mouth; its natural channel was narrow and tortuous, and about 18 ft. deep; in 1909 improvements (begun in 1902) had procured a channel 20 ft. deep at mean low water and 380 ft. wide. The Chesapeake & Ohio Canal, from Georgetown to Cumberland, Md., follows the Potomac closely on the Maryland side. The shipments over the Potomac above Washington in 1907 were valued at \$7,596,494, and those below Washington at \$21,093,800, the principal commodities being sand and gravel, ice, oils, naval ordnance and supplies, and building and paving materials. The shipments on the Anacostia river were of much the same character, and in 1907 were valued at \$4,312,687.

POTOROO, or RAT KANGAROO, any member of the diprotodont marsupial sub-family *Potoroinae* (see MARSUPIALIA). None of them exceed a common rabbit in size. They inhabit Australia and Tasmania, are nocturnal, and feed on the leaves of grasses and other plants, as well as roots and bulbs, which they dig up with their forepaws; in this way some of them do considerable damage to cultivated crops. About ten species are known, presenting a considerable range of diversity in minor characters. The members of the type genus (*Potorous*) run, rather than leap, and do not use the hind feet for kicking. In the genus *Bettongia* the tail is prehensile, and with it they collect grass and twigs for making nests in their burrows.

POTOSÍ, a department of Bolivia occupying the south-western angle of that republic, bounded N. by Oruro, Cochabamba and Chuquisaca, E. by the two last departments and Tarija, S. by Argentina and W. by Chile and Oruro. Pop. (1900), 325,615, the larger part Indians; area, 48,801 sq. m. The eastern part of the department is traversed north to south by the eastern branch of the Andes, locally known as the Cordillera de los

Frailles and the Sierras de Chichas. Spurs and broken ranges project eastward from these, between which are the headstreams of the Pilcomayo and Guapay, the first flowing south-east to the La Plata, and the second north-east to the Madeira and Amazon. The Pilcomayo itself rises in the department of Oruro, but several of its larger tributaries belong to Potosí—the San Juan, Cotagaita and Tumusla in the south, and Cachimayo in the north. The western part of the department belongs to the great Bolivian *altiplanicie*, or southern extension of the Titicaca basin. It is a barren, saline waste, almost uninhabitable. In the north, bordering on the transverse ridge of which the Cerro de Tahuá (17,454 ft.) forms a part, is the depression known as the Pampa de Empeza, 12,080 ft. above sea-level, which is largely a region of morasses and saline plains. On and near the southern frontier is another transverse ridge, in part formed by the Sierra de Lipez, and in part by apparently detached groups of high peaks; it is a waterless desert like the Puna de Atacama.

Potosí is essentially a mining department, though agriculture and grazing occupy some attention in the eastern valleys. The western plateau is rich in minerals, especially silver and copper. The Huanchaca group of mines, situated on the slopes of the eastern Cordillera, overlooking the Pampa de Empeza, has the largest output of silver in Bolivia. The Pulacayo mine, belonging to this group, 15,153 ft. above sea-level, ranks next to the Broken Hill mine of Australia in production. Between 1873 and 1901 it yielded 4520 tons of silver, of an estimated value of £23,200,000. Farther south are the Portugalete mines, once very productive, and near the Argentine border are the Lipez mines. East of the Cordilleras are the famous "silver mountain" of Potosí, once the richest silver mine in the world; the snow-capped peak of Chorolque (18,452 ft.), which is claimed to have the highest mine in the world; Porco, a few miles south-west of Potosí; Guadalupe, Colquechaca and Aullagas. Besides silver, the Chorolque mines also yield tin, copper, bismuth, lead and wolfram. In 1907 the national government undertook railways from Potosí to Oruro, 205 m., and from Potosí to Tupiza, 155 m., to connect with the Central Northern line of Argentina, which was opened to Quiaca on the frontier on the 25th of May 1908. In western Potosí the department is traversed by the Antofagasta & Oruro railway (0.75 metre gauge). Besides Potosí, the capital of the department, the principal towns are Huanchaca (pop. about 10,000 in 1904), the seat of famous silver mines, 13,458 ft. elevation, and overlooking the Pampa de Empeza; Uyuni, 9 m. from Huanchaca, 12,100 ft. above sea-level, a small town but an important railway junction and commercial centre on the waterless plain, the shipping point and supply station for an extensive mining region; and Tupiza (pop. about 5000 in 1906), a prettily situated town near the Argentine frontier, on a small branch of the San Juan river, 9800 ft. above sea-level.

POTOSÍ, a city of Bolivia, capital of the department of Potosí, 47 m. (direct) S.W. of Sucre, or 88 m. by the post-road. Pop. (1906, estimate), 23,450. Potosí stands on a barren terrace on the northern slope of the Cerro Gordo de Potosí, 12,992 ft. above sea-level, and is one of the highest towns in the world. The famous *cerro* from which its name is taken rises above the town to a height of 15,381 ft., a barren, white-capped cone honeycombed with mining shafts. The town is regularly laid out with streets crossing each other at right angles. The smoke-begrimed buildings, many of which are unoccupied and in ruins, are commonly of adobe. A large plaza forms the conventional centre, around which are grouped various religious edifices, the government house, town hall, national college, the old "royal mint" dating from 1585, and the treasury. The city has a massive, plain cathedral, which in part dates from early colonial times, and in part from the closing years of Spanish rule. The water supply is derived from a costly system of reservoirs and aqueducts constructed by the Spanish government during the years of the city's greatest prosperity. There are 27 of these artificial lakes, and the aqueducts originally numbered 32, some of which are no longer serviceable. Rough mountain roads and pack animals are the only means of transportation to and from Potosí, but a railway from Oruro to Tupiza via Potosí, forming part of the projected Pan-American route, was contracted for in 1908. In 1611 the population of Potosí was reported to be 160,000, which probably included the whole mining district. A part of the diminution since then is explained by the fact that the great majority of the mines on the *cerro* have been abandoned.

The foundation of the city dates from 1547, two years after the first discovery of silver on the *cerro* by an Indian herder named Gualci. Charles V. conferred upon it the title of "villa imperial." From 1545 to 1800 the crown tax of one-fifth upon the mineral product amounted to £32,600,000, showing an acknowledged output of £163,000,000. The actual output, however, must have been much greater, as Spain was flooded with contraband silver, and there was a large trade in it at La Plata ports, whence it was taken to Brazil and Portugal. The total output to 1864 has been estimated at more than £400,000,000, but the annual output at the beginning of the 20th century barely exceeded 400,000 ozs. The struggle for independence began in Potosí on the 9th of November 1810, but the Spanish forces succeeded in retaining possession down to 1822.

POTOTAN, a town of the province of Iloilo, island of Panay, Philippine Islands, on the Jalaur river, about 17 m. N. of Iloilo. Pop. (1903), 37,373, including the population of Dingle (12,129) and Mina (4280), annexed after the census was taken. There is a fine church in the old town and a large stone church in Dingle; in the old town are several other buildings of masonry and some beautiful "fire" trees for shade. The principal industries are the cultivation of sugar-cane, Indian corn, rice, tobacco and hemp, and the raising of cattle, carabaos, sheep and horses.

POTSDAM, a town of Germany, the administrative capital of the Prussian province of Brandenburg, and one of the principal residences of the German Emperor, beautifully situated on the river Havel, 16 m. S.W. of Berlin, on the main line of railway to Magdeburg. Pop. (1905), 61,414. It is also connected with the capital by two local lines and by a steamboat service through the chain of lakes formed by the river. The greater part of the town lies on the right bank of the Havel and is connected with the Teltow suburb on the opposite bank by a long bridge (Lange Brücke). At the north end of this bridge rises the royal palace, a large quadrangular building of the 17th century, with a colonnade, chiefly interesting for the numerous relics it contains of Frederick the Great, who made it his favourite residence. At the south-eastern corner of the palace, close to the bridge, is the tree under which petitioners waited for the answer to their grievances, which Frederick the Great gave from an opposite window. It also contains reminiscences of Voltaire, who resided here for several years. The principal churches are the Nikolai-kirche; the Church of the Holy Ghost, built in 1728; the garrison church, containing the remains of Frederick the Great and his father, Frederick William I.; and the Friedenskirche, or Church of Peace, erected by Frederick William IV. in 1845-1850. To the Friedenskirche is attached a mausoleum built after the model of a chapel at Innichen in Tirol, in which are buried Emperor Frederick III. and his consort, the Princess Royal of Great Britain, and two of their children who died in infancy. Among other conspicuous buildings are the large barracks and other military establishments; the town hall; and the Brandenburg gate, in the style of a Roman triumphal arch. The town has fine statues of several of the Prussian kings, including Frederick the Great. The Lustgarten, the Wilhelmsplatz and the Plantage are open spaces laid out as pleasure-grounds and adorned with statues and busts. In spite of its somewhat sleepy appearance, Potsdam has manufactures of silk goods, chemicals, furniture, chocolate, tobacco and optical instruments. Market-gardening affords occupation to many of the inhabitants, and the cultivation of winter violets is a specialty. The Havel is well stocked with fish. On a wooded eminence to the south of the town lies the observatory with extensive premises.

Potsdam is almost entirely surrounded by a fringe of royal palaces, parks and pleasure-grounds, which fairly substantiate its claim to the title of a "German Versailles." Immediately to the west is the park of Sans Souci, laid out by Frederick the Great, and largely extended by Frederick William IV. It is in the formal French style of the period, and is adorned with fountains, statuary and artificial ruins. Near the palace is the famous windmill; now royal property, which, according to a tradition now regarded as doubtful, its owner refused to sell to the king, meeting threatened violence

by an appeal to the judges of Berlin. A little farther on is the Orangery, an extensive edifice in the Italian style, containing numerous pictures and other works of art. The park also includes the Charlottenhof, a reproduction of a Pompeian villa. At the west end of the park stands the New Palace, a huge brick edifice 375 ft. in length, erected by Frederick the Great at enormous expense in 1763-1769. It was occupied for a while by the emperor Frederick III., and was christened by him "Friedrichskron." On the accession of the emperor William II. its original name was restored. It is now the residence of the emperor. It contains reminiscences of Frederick and of Voltaire, a few pictures by ancient masters, a theatre, and a large hall decorated with shells and minerals. The spacious buildings at the back are devoted to the "Lehrbataillon," a battalion of infantry composed of drafts from different regiments trained here to ensure uniformity of drill throughout the army. To the north of Potsdam lies a small Russian village, Alexandrowka, built in 1826 to accommodate the Russian singers attached to the Prussian guards. A little to the east of it, on the Heiligersee, is the New Garden, containing the Marble Palace. The list of Potsdam palaces may be closed with two situated on the left bank of the Havel—one at Klein-Glienicke, formerly the country-seat of Prince Frederick Charles of Prussia (the "Red Prince"), and the other on the hill of Babelsberg. The latter, designed as a miniature copy of Windsor Castle, in the midst of a park in the English taste, was formerly the summer residence of the emperor William I.

Potsdam was originally a Slavonic fishing-village named Poztupimi, and is first mentioned in a document of 993. It became a town in the 14th century, but was unimportant until the great elector built a palace here between 1660 and 1682; and even at the close of his reign it only contained 3000 inhabitants. The elector Frederick William I. greatly enlarged Potsdam, and his stiff military tastes are reflected in the monotonous uniformity of the streets. Frederick the Great continued his father's work, and is the real creator of the modern splendour of the town, to which all his successors have contributed.

See H. C. P. Schmidt, *Geschichte und Topographie der Residenzstadt Potsdam* (Potsdam, 1825); G. Sello, *Potsdam und Sanssouci* (Breslau, 1888); Müggé, *Führer durch Potsdam und Umgebung* (Potsdam, 1896); Kopsisch, *Die königlichen Schlösser und Gärten zu Potsdam* (Berlin, 1854); and Bethge, *Die Hohenzollernanlagen Potsdams* (Berlin, 1889).

POTSDAM, a village of St Lawrence county, New York, U.S.A., in the township of Potsdam, on the Raquette river, about 68 m. N.E. of Watertown. Pop. of the village (1905) 4162; (1910) 4036; of the township (1905) 8992; (1910) 8725. The village is served by the New York Central & Hudson River railway. It has a public library and is the seat of a state Normal School (1869), an outgrowth of St Lawrence Academy (founded in 1810 by Benjamin Raymond and maintained by him until 1816, when it was incorporated); of the Thomas S. Clarkson Memorial School of Technology (1896), founded by his sisters in honour of Thomas Streatfield Clarkson (1837-1894); and of the Crane Normal Institute of Music. The village has a considerable trade in dairy products. In the neighbourhood are extensive quarries of the well-known "Potsdam sandstone," the uppermost division of the Cambrian system, described as a "fine-grained sandstone cemented with silica," and very durable. The House of Parliament at Quebec, All Saints Cathedral at Albany, New York, and many other public edifices were built of this stone.

The "Ten Towns" of St Lawrence county, including the township of Potsdam, were sold by the state in 1787. The first settlement was made on the Raquette river, close to the present village, in 1803; the township was incorporated in 1806 and the village in 1831. Potsdam was named after Potsdam in Prussia because of the occurrence in each locality of reddish sandstone.

POTT, AUGUST FRIEDRICH (1802-1887), German philologist, was born at Nettelrede, Hanover, on the 14th of November 1802. He studied in Göttingen, and in 1825 became schoolmaster at Celle, Hanover; but after two years removed to Berlin, where he became *privatdozent* at the university. He studied comparative philology, and in 1883 was made professor at Halle, where he lived till his death on the 5th of July 1887. His *Etymologische Forschungen* (1834-1836) entitled him to rank as Bopp's foremost disciple in the Indo-Germanic science of language. Pott also devoted much attention to the origins of the gipsies.

POTT, PERCIVAL (1714-1788), English surgeon, was born in London on the 6th of January 1714. He served his apprenticeship with Edward Nourse, assistant surgeon to St Bartholomew's Hospital, and in 1736 was admitted to the Barbers'

Company and licensed to practise. He became assistant surgeon to St Bartholomew's in 1744 and full surgeon from 1749 till 1787. He died in London on the 22nd of December 1788. The first surgeon of his day in England, excelling even his pupil, John Hunter, on the practical side, he introduced various important innovations in procedure, doing much to abolish the extensive use of escharotics and the actual cautery that was prevalent when he began his career. A particular form of fracture of the ankle which he sustained through a fall from his horse in 1756 is still described as Pott's fracture, and his book, *Some few Remarks upon Fractures and Dislocations*, published in 1768 and translated into French and Italian, had a far-reaching influence in Great Britain and France. "Pott's disease" is a spinal affection of which he gave an excellent clinical description in his *Remarks on that kind of Palsy of the Lower Limbs which is frequently found to accompany a Curvature of the Spine* (1779). Among his other writings the most noteworthy are *A Treatise on Ruptures* (1756), *Observations on the Nature and Consequences of those Injuries to which the Head is liable from external violence* (1768), and *Chirurgical Observations* (1775). There are several editions of his collected works; that published by Sir James Earle in 1790 contains a sketch of his life.

POTTER, ALONZO (1800-1865), American bishop of the Protestant Episcopal Church, was born at Beekman (now La Grange), Dutchess county, New York, on the 6th of July 1800. His ancestors, English Friends, settled in Portsmouth, Rhode Island, between 1640 and 1660; his father was a farmer, a Quaker, and in 1798 and in 1814 was a member of the New York Assembly. The son graduated at Union College in 1818, and in 1821-1826 was professor of mathematics and natural philosophy there. In 1824 he was ordained priest, and married a daughter of President Eliphalet Nott of Union College; she died in 1839, and in 1841 he married her cousin. He was rector of St Paul's Boston, from 1826 to 1831, when he became professor of moral and intellectual philosophy and political economy at Union. In 1838 he refused the post of assistant bishop of the eastern diocese (Maine, New Hampshire, Massachusetts and Rhode Island). He was vice-president of Union College in 1838-1845. After the suspension of Henry Ustick Onderdonk (1789-1858) from the bishopric of Pennsylvania Potter was chosen to succeed him, and was consecrated on the 23rd of September 1845. Owing to his failing health he visited England and France in 1858, and in April 1864 sailed from New York for California, but died on board ship in San Francisco harbour on the 4th of July 1865.

In 1846 he established the western and north-eastern convocations of priests in his diocese; from 1850 to 1860, when its corner-stone was laid, he laboured for the "Hospital of the Protestant Episcopal Church in Philadelphia"; and in 1861 he established the Philadelphia Divinity School. In 1842 with George B. Emerson (1797-1871) he published *The School and the Schoolmaster*, which had a large circulation and great influence. In 1847, 1848, 1849 and 1853 he delivered five courses of lectures on the Lowell Institute foundation. He advocated temperance reform and frequently delivered a lecture on the *Drinking Usages of Society* (1852); he was an opponent of slavery and published a reply to the pro-slavery arguments of Bishop John Henry Hopkins (1792-1868) of Vermont. He edited many reprints and collections of sermons and lectures, and wrote: *Political Economy* (1840), *The Principles of Science applied to the Domestic and Mechanical Arts* (1841), *Handbook for Readers and Students* (1843), and *Religious Philosophy* (1870).

See M. A. de Wolfe Howe, *Memoirs of the Life and Services of the Right Reverend Alonzo Potter, D.D.* (Philadelphia, 1871).

His brother, **HORATIO POTTER** (1802-1887), was born in Beekman, New York, on the 9th of February 1802. He graduated at Union College in 1826, was ordained a priest of the Protestant Episcopal Church in 1828, was rector for several months in Saco, Maine, and in 1828-1833 was professor of mathematics and natural philosophy at Washington (now Trinity) College, Hartford, Connecticut. In 1833-1854 he was rector of St Peter's, Albany; in November 1854 he was elected provincial bishop of New York in place of Benjamin Tredwell Onderdonk (1791-1861), who had been suspended, and upon Onderdonk's death he became bishop. In 1868 his diocese was divided, the new dioceses of Albany, Central New York and Long Island being

separated from it. Bishop Potter attended the Lambeth conferences of 1867 and 1868. His failing health put an end to his active service in 1883, when his nephew, H. C. Potter (*q.v.*), became his assistant. He died in New York City on the 2nd of January 1887.

POTTER, HENRY CODMAN (1835-1908), American Protestant Episcopal bishop, the son of Bishop Alonzo Potter, was born in Schenectady, New York, on the 25th of May 1835. He was educated in the Philadelphia Academy of the Protestant Episcopal Church and in the Theological Seminary of Virginia, where he graduated in 1857. He was ordained deacon in 1857 and priest in 1858; was rector of Christ Church, Greensburg, Pennsylvania, in 1858-1859, and of St John's Church, Troy, N. Y., in 1859-1866; refused the presidency of Kenyon College in 1863 and the bishopric of Iowa in 1875; was secretary of the House of Bishops in 1866-1883; and was assistant rector of Trinity Church, Boston, in 1866-1868, and rector of Grace Church, New York City, in 1868-1884. In October 1883 he was consecrated assistant to his uncle, Horatio Potter, bishop of New York, and in 1887 succeeded him. The Rev. David Hummel Greer (b. 1844) became his coadjutor in September 1903, and succeeded to the bishopric after the death of Bishop Potter in Cooperstown, N. Y., on the 21st of July 1908. During Bishop Potter's administration the corner-stone of the Cathedral of St John the Divine was laid (in 1892).

He was notable for his interest in social reform and in politics: as rector of Grace Church he worked to make it an "institutional church" with working-men's clubs, day nurseries, kindergartens, &c., and he took part in the summer work of the missions on the east side in New York City long after he was bishop; in 1900 he attacked the Tammany mayor (Robert A. Van Wyck) of New York City, accusing the city government of protecting vice, and was a leader in the reform movement which elected Seth Low mayor in the same year; he frequently assisted in settling labour disputes; he worked for the re-establishment of the army canteen and attempted to improve the saloon, which he called the "poor man's club"—notably by his taking part in the opening (August, 1904) of the unsuccessful Subway Tavern. He published: *Sisterhoods and Deaconesses at Home and Abroad* (1872); *The Gates of the East* (1876), a book of travels; *Sermons of the City* (1881); *Waymarks* (1892); *The Scholar and the State* (1897); *The East of To-day and Tomorrow* (1902); *The Industrial Situation* (1902); *Law and Loyalty* (1903), and *Reminiscences of Bishops and Arch-Bishops* (1906).

See Harriett A. Kayser, *Bishop Potter, the People's Friend* (New York, 1910).

His brother, **CLARKSON NOTT POTTER** (1825-1882), was a civil engineer, then (1848-1868) a practising lawyer in New York City, and in 1869-1875 and in 1877-1881 a Democratic member of the National House of Representatives. Another brother, **ROBERT BROWN POTTER** (1829-1887), a lawyer and a soldier, commanded the 51st New York Volunteers at Cedar Mountain, Second Bull Run and Antietam, was wounded at Antietam and at Petersburg, was commissioned major-general of volunteers in September 1865, and was mustered out in 1866. A third brother, **ELIPHALET NOTT POTTER** (1836-1901), was rector of the Church of the Nativity, South Bethlehem, Pennsylvania, in 1862-1869, was professor of ethics in Lehigh University in 1869-1871, and was president of Union College in 1871-1884, of Hobart College in 1884-1897, and of Cosmopolitan University, a correspondence school, in 1897-1901.

POTTER, JOHN (c. 1674-1747), archbishop of Canterbury, was the son of a linen-draper at Wakefield, Yorkshire, and was born about 1674. At the age of fourteen he entered University College, Oxford, and in 1693 he published notes on Plutarch's *De audiendis poetis* and Basil's *Oratio ad juvenes*. In 1694 he was elected fellow of Lincoln College, and in 1697 his edition of Lycophron appeared. It was followed by his *Archæologia graeca* (2 vols. 8vo, 1697-1708), the popularity of which endured till the advent of Dr William Smith's dictionaries. A reprint of his Lycophron in 1702 was dedicated to Graevius, and the *Antiquities* was afterwards published in Latin in the *Thesaurus* of Gronovius. Besides holding several livings he became in 1704 chaplain to Archbishop Tenison, and shortly afterwards was made chaplain-in-ordinary to Queen Anne. From 1708 he was regius professor of divinity and canon of Christ Church, Oxford; and from 1715 he was bishop of Oxford. In the latter year appeared his edition of Clement of Alexandria. In 1707 he published a *Discourse on Church Government*, and he took a prominent part in the controversy with Benjamin Hoadly,

bishop of Bangor. In January 1737 Potter was unexpectedly appointed to succeed Wake in the see of Canterbury. He died on the 10th of October 1747. His *Theological Works*, consisting of sermons, charges, divinity lectures and the *Discourse on Church Government*, were published in 3 vols. 8vo, in 1753.

POTTER, PAUL (1625-1654), Dutch animal painter, was born at Enkhuizen, Holland. He was instructed in art by his father, Peter Potter, a landscape and figure painter of some merit, and by Nicolas Moeyaert, of Amsterdam. Other masters and influences are mentioned by various writers, but more than any other of his contemporaries he learnt through direct study from nature. By the time he had attained his fifteenth year his productions were already much esteemed. In 1646 he went to Delft, where he became a member of the gild of St Luke. At the age of twenty he settled at the Hague, and there married in 1650. He was patronized by Maurice, prince of Orange, for whom he painted the life-size picture of the "Young Bull," now one of the most celebrated works in the gallery of the Hague. In 1652 he was induced by Burgomaster Tulp of Amsterdam to remove to that city. His constitution seems to have been feeble, and his health suffered from the unremitting diligence with which he pursued his art. He died on the 15th of January 1654 at the age of twenty-nine.

His paintings are generally small; early in life, however, he attempted, but with ill success, to work on a monumental scale, as in the "Bear Hunt" at the Rijks Museum and the "Boar Hunt" of the Carstanjen collection, Berlin. Even the famous "Equestrian Portrait of Tulp" in the Six collection, Amsterdam, is awkward and stiff and hard in handling. His animals are designed with careful accuracy, while the landscape backgrounds are introduced with spirit and appropriateness. His colour is clear and transparent, his execution firm and finished without being laboured. His view of nature is purely objective and unemotional; he painted with the greatest directness and simplicity the things he saw before him, and his paintings of horses and cattle are so individualized that they become faithful portraits of the animals. The best among his small portraits of horses are in the Louvre and in the Schwerin Gallery; and certain of his studies are the most brilliant of all.

The earliest dated picture of importance is "Abraham Entering Into Canaan" (1642), at the Germanic Museum in Nuremberg, in which he makes the Scriptural subject an excuse for painting the patriarch's herds, just as in his "Orpheus" of 1650 (Rijks Museum, Amsterdam) he makes similar use of the Greek myth. Among his finest works on a small scale are a cattle piece (1653) in the Duc d'Arenberg's collection, and a similar, though earlier, picture in the Munich Pinakothek. In spite of his early death Paul Potter produced a great number of works. He worked with feverish application, as though he were aware of the short span of life that was granted him. He executed a series of some twenty etchings, mainly of animals, which are simple and direct in method and handling. Here, as in painting, his precocity was remarkable: his large plate of the "Herdsman," produced when he was only eighteen, and that of the "Shepherd," which dates from the following year, show him at his best as an accomplished master of the point.

Potter's works have been engraved by Bartolozzi, Danckerts, Visscher, Le Bas and others. Authentic paintings from his brush command very considerable prices. At the Stover sale in 1890 "The Dairy Farm" realized the record price of £6090. There are two of his paintings at the National Gallery, three in Buckingham Palace and a few in the duke of Westminster's collection. On the continent of Europe the most numerous and representative examples are to be found at the Rijks Museum in Amsterdam, the Hermitage in St Petersburg, and the Dresden Gallery.

See *Paulus Potter, sa vie et ses œuvres*, by T. van Westreheene (the Hague, 1867); *Eaux-fortes de Paul Potter*, by Georges Gratez Duplessis; and an old but interesting volume, *Paul Potter, peintre de l'école hollandaise*, by C. L. F. Lecarpentier (Rouen, 1818). (P. G. K.)

POTTER, PHILIP CIPRIANI HAMBLEY (1792-1871), English musician, was born in London, the son of a pianoforte teacher, and godson of a sister of G. B. Cipriani, the painter. He was educated for the musical profession under Attwood, Callcott, Crotch and Woelfl; later at Vienna, where he received encouragement from Beethoven. In 1816 an overture by him was performed at a Philharmonic concert, and he began a distinguished career as a pianist. In 1822 he became a professor, and in 1832 principal (resigning in 1859) of the Royal Academy of Music; in

1860 an exhibition was founded there in his honour. Cipriani Potter composed many works, now mostly forgotten, though important in their day. He died on the 28th of September 1871.

POTTERIES, THE, a name popularly applied to a district of north Staffordshire, the principal seat of the china and earthenware industry in England. It lies in the valley of the Trent a little south of its source, and extends into tributary valleys and up the hills flanking them. For a distance of 9 m. from south-east to north-west, and about 3 m. from north-east to south-west, the district resembles one great town, but the chief centres are Burslem, Hanley, Longton, Stoke-on-Trent, Fenton and Tunstall. Under the "Potteries federation" scheme (1908) these towns were amalgamated in 1910 as one municipal borough under the name of Stoke-on-Trent. Newcastle-under-Lyme, though not sharing in the staple industry, may also be reckoned in the district. Among the lesser manufacturing centres Etruria, ranking as a suburb of Hanley, is well known for its connexion with Josiah Wedgwood, who founded works here in 1769. The Wedgwoods and the Mintons are the two most famous family names connected with the china industry of the district. Coal and coarse clay are the only local natural products necessary to the industry; the finer clay and other ingredients are brought from Cornwall and elsewhere. Ironstone is raised in the district. The North Staffordshire and London & North-Western railways and the Grand Trunk canal are the principal means of communication.

POTTHAST, AUGUST (1824-1898), German historian, was born at Höxter on the 13th of August 1824, and was educated at Paderborn, Munster and Berlin. He assisted G. H. Pertz, the editor of the *Monumenta Germaniae historica*, and edited the *Regesta pontificum romanorum, 1198-1304* (Berlin, 1874-1875). From 1874 to 1894 he was librarian of the German Reichstag. Potthast is chiefly known through his monumental *Bibliotheca historica medii ævi* (1862), a guide to the sources of European history in the middle ages. The work, in the form of an index, gives particulars of practically all the historical writers of Europe and their work between 375 and 1500. A new and enlarged edition appeared at Berlin in 1896. Potthast died on the 13th of February 1898.

POTTINGER, ELDRED (1811-1843), Anglo-Indian soldier and diplomatist, entered the Bombay Artillery in 1827, and after some years of regimental duty was appointed to the political department under Colonel (afterwards Sir Henry) Pottinger. In 1837 he made a journey through Afghanistan in disguise. Arriving at Herat, he found it threatened by a Persian army (with which were some Russian officers) and immediately made himself known to the Afghan commander, offering his services. The attack which soon followed was conducted with the greatest vigour, but the defence, inspired by Pottinger, was invariably successful, and after a year the siege was raised. For this great service Pottinger was thanked by the governor-general, the earl of Auckland, made brevet-major, and also received the C.B. He was also appointed political officer at Herat. In 1841 he was political officer in Kohistan when the revolt against Shah Shuja broke out there. Taking refuge with the Gurkha garrison of Charikar, Major Pottinger stood a siege of fourteen days, and then made an adventurous retreat to Kabul. Less than a fortnight after his arrival Sir William Macnaghten was murdered, and Pottinger succeeded to his position as envoy to the Afghan court. The apathy of the military leaders made resistance hopeless, and it only remained to negotiate for the withdrawal of the British mission. Pottinger himself was one of the hostages handed over to Akbar Khan, and thus escaped the massacre in the Khyber Pass. Released, after many months' captivity, by Sir George Pollock's army, he returned to India, and a year later died while visiting Hong-Kong.

POTTO, the native name of the West African slow-lemurs, popularly miscalled "sloths," and scientifically known as *Perodicticus*, a name referring to the aborted condition of the index finger, which forms their most distinctive feature. The ordinary potto (*P. potto*) is about the size of a squirrel, but with

large staring eyes, and a mere stump of a tail; its general colour is rufous brown. Bates's potto (*P. batesi*), of the Congo, is nearly allied; but the awantibo (*P. [Arctocebus] calabarensis*), of Old Calabar, differs by the complete loss of the tail (see PRIMATES).

POTTSTOWN, a borough of Montgomery county, Pennsylvania, U.S.A., on the Schuylkill river, 40 m. N.W. of Philadelphia. Pop. (1910 census) 15,599. Pottstown is served by the Pennsylvania and the Philadelphia & Reading railways, and by electric lines to neighbouring towns. In the borough is the Hill School (1851), an excellent secondary school for boys. There is trade with the surrounding country, which is devoted to farming and dairying and abounds in iron ore and limestone, but the principal industry is the manufacture of iron and steel, the first commercially important iron furnaces in Pennsylvania having been established near the site of Pottstown in 1716-1718. In 1905 the factory products were valued at \$8,144,723 (10.7% more than in 1900). Three miles from Pottstown, in an amusement park, are the "ringing rocks," which cover about an acre, and have varying tones when struck, so that tunes may be played upon them. Pottstown was settled and laid out in 1752 and was named Pottsgrove in honour of its founder, John Potts (1710-1768); in 1815 it was incorporated as a borough and in 1829 the present name was adopted.

POTTSVILLE, a borough and the county-seat of Schuylkill county, Pennsylvania, U.S.A., at Schuylkill Gap through Sharp Mountain on the Schuylkill river, about 90 m. N.W. of Philadelphia. Pop. (1910 census) 20,236. It is served by the Pennsylvania, the Lehigh Valley and the Philadelphia & Reading railways, and by the Eastern Pennsylvania railway company to the borough of Minersville (pop., 1910, 7240), about 4½ m. N.N.E., and to the other boroughs in the immediate neighbourhood, for which Pottsville is a business and shipping centre. It is picturesquely situated in the famous Schuylkill coalfield and on the old Schuylkill canal and Tumbling Run, and has a considerable number of summer visitors. There are large repair shops of the Pennsylvania and of the Philadelphia & Reading railways at Pottsville. In 1905 the total value of the factory products was \$5,805,788.

The first settlers here, a single family, were massacred by the Indians in August 1780; a second settlement was established about 1795, and an iron furnace was erected a few years later. In 1804 this furnace was purchased by John Pott (1759-1827), the founder of the borough; in 1807 coal was discovered; in 1816 the town was laid out; in 1828 it was incorporated as a borough; and in 1851 the borough became the county-seat. In 1854-1877 Pottsville was a centre of the Molly Maguire disturbances, and here a number of the leaders were tried and convicted in 1876-1877. In 1908 the borough of Yorkville (pop., 1900, 1125) was annexed to Pottsville.

POTWALLOPER, or **POTWALLER**, the name of a class of persons who were entitled in certain English boroughs to the parliamentary franchise. The word is usually taken to mean literally "one who boils a pot," from "wallop" or "gallop," which Skeat (*Etym. Dict.*, 1898) connects with the Old Low Ger. *wallen*, to boil, cf. "well," *i.e.* which springs or boils up. The "Potwalloper" was defined in *Curry's Case*, 1838 (*Falc and Filz.*, p. 311) as "one, whether he be a householder or a lodger, who has the sole dominion over a room with a fireplace in it, and who furnishes and cooks his own diet at his own fireplace." The Representation of the People Act (1832) reserved these ancient franchise rights to their then holders only. In the *Return of Parliamentary Constituencies* (Electors, &c.), 1898, there was one "potwalloper" on the register.

POUCHED MOUSE, the colonial name for any member of the polyprotodont marsupial genus *Phascologale* (see MARSUPIALIA). There are over a dozen species, none larger, the most much smaller than a rat. The food of these animals is almost entirely insects, which some pursue among the branches of trees, while others are purely terrestrial. Pouched mice are found throughout Australia, where all the species have uniformly coloured fur, and also in New Guinea and the Aru and some

of the adjacent islands, most of the Papuan forms being distinguished by striping on the back. In the view of Oldfield Thomas these marsupials fill the place held in Malaya by the tree-shrews, and in South America by the smaller opossums.

POUGHKEEPSIE, a city and the county-seat of Dutchess county, New York, U.S.A., and on the east bank of the Hudson river, 73 m. N. of New York City. Pop. (1910 census), 27,936. It is served by the New York Central & Hudson River, the New York, New Haven & Hartford, the West Shore, the Central New England, and the Poughkeepsie & Eastern (merged in the Central New England) railways, and by river steamboat lines on the Hudson. A cantilever railway bridge, 2260 ft. long (6767 ft., including approaches) and 200 ft. above the water, spans the Hudson at this point. The city is built partly on terraces rising 200 ft. above the river and partly on a level plateau above. On the Hudson here is the course for the inter-collegiate boat-races in which the American college crews (save those of Yale and Harvard, which row on the Thames at New London) have rowed annually, beginning in 1895, except in 1896, when the race was rowed at Saratoga. In the north-eastern part of the city is College Hill Park, and in the centre is Eastman Park (11 acres, originally the home of Harvey Gridley Eastman). Vassar College (*q.v.*), one of the most famous women's colleges in America, occupies extensive grounds a short distance east of the city. Other educational institutions are the Lyndon Hall School (1848) for girls, Putnam Hall (for girls), St Faith's School (Protestant Episcopal; removed in 1904 from Saratoga Springs, where it was founded in 1890), Riverview Military Academy (1836), and Eastman Business College, one of the largest commercial schools in the country, founded in 1850 by Harvey Gridley Eastman (1832-1878). Immediately north of Poughkeepsie is the Hudson River State Hospital for the Insane (1871); in the city are the Vassar Brothers' Hospital (1878), with which a nurses' training school is connected; the Vassar Brothers' Home (1881) for aged and infirm men; the Poughkeepsie Orphan House and Home for the Friendless (1847); the Old Ladies' Home (1870); the Pringle Memorial Home (1899), for aged and indigent men, and the Adriance Memorial Library (45,000 volumes in 1909). The city is a manufacturing centre of considerable importance; the factory products in 1905 were valued at \$7,206,914, an increase of 29.2% over 1900.

Poughkeepsie was settled by the Dutch about 1698, taking its name from an Indian word "Apokeepsing," or "Pooghkeepsing," which seems to have been the name of a waterfall on the river front. The New York legislature met in Poughkeepsie in 1778, 1780, 1781, 1782, 1788 and 1795, and here in 1788 met the convention which ratified for New York the Federal constitution (July 28). Poughkeepsie was incorporated as a village in 1799 and was chartered as a city in 1854.

POULTICE, a mass of linseed-meal, bread or other substance, sometimes of medicinal herbs, mixed with boiling water and enclosed in muslin or linen and applied to the skin to reduce inflammation, to induce warmth, or when mixed with mustard, &c., as a counter-irritant. The word seems to have been taken from the plural *pultes* of the Lat. *puls*, pottage, pulse, Gr. *πόλτος*.

POULTRY AND POULTRY-FARMING. The term "poultry" (from "poult," Fr. *poulet*, dim. of *poule*, a fowl) is usually regarded as including the whole of the domesticated birds reclaimed by man for the sake of their flesh and their eggs. The most important is the common fowl, which is remarkable as having no distinctive English name; but the present article also deals with the poultry-farming side of the turkey, the guinea-fowl, the duck and the goose. For purely zoological details the separate articles referred to should be consulted.

Fowls.—The common fowl (see FOWL) belongs to the restricted genus *Gallus*, of which four wild species are known—the Bankiva jungle fowl (*G. ferrugineus*), the Sonnerat jungle fowl (*G. sonnerati*), the Ceylon jungle fowl (*G. stanleyi*), and the forked-tail jungle fowl (*G. furcatus*). The origin of the domesticated breeds is ascribed by Darwin, Blyth and other naturalists to the Bankiva fowl, much stress being laid on the comparative want of fertility in the hybrids produced between this species

or the domesticated breeds and the other three forms of wild *Galli*, but it is probable that this want of fertility was due in great part to the unnatural conditions under which the parent and offspring were placed, as, if bred under more natural conditions, there is no difficulty in rearing these hybrids or in breeding from them with the domesticated varieties.

Breeds.—The number of poultry exhibitions has nowadays multiplied to such an extent that as many as twenty shows have been criticized in print in one week in Great Britain. Competition has increased the money value of prize fowls and created a large class—almost a profession—who have considerable pecuniary interests embarked in breeding and exhibiting such birds. This professionalism, and the interests at stake, have in turn naturally given rise to many proceedings of doubtful character, which it has been found needful to keep in check by an organization known as the Poultry Club. An enormous multiplication of varieties is another phase of this development, nearly all breeds having had their older subdivisions supplemented by new colours, produced through crossing and skilful selection, amidst which buff or orange, now bred in nearly all fowls, has had a curious popularity. While formerly the diminutive bantams were confined to a few well-marked varieties, all the large breeds of poultry have now been dwarfed into bantam size by the skill of breeders. To enter farther into this branch of the subject is beyond the scope of the present article, but it may be interesting to state that at a public auction in 1901 one prize fowl was sold for £150.

Game Fowls.—Game fowls differ less from the wild *Bankiva* than any other variety; they are, however, considerably larger, and carry the tail more erect than the wild birds. Game fowls in England were long cultivated not only as useful poultry, but on account of their combative tendencies for the cock-pit. The comb in the game is single, the beak massive, the spurs strong and very sharp. There is a tendency towards the assumption of the female plumage by the males, and distinct breeds of "henry" game are known. Game are highly esteemed for the table on account of their plumpness, the amount of the breast-meat, owing to the size of the pectoral muscles, being very great, from which cause, combined with their hardihood, they are most valuable for crossing with other breeds, as the Dorking. English-bred game have been reared of many varieties of colour, retaining in all cases their distinctive peculiarities of form. Game fowls have been reduced in size by selective breeding, and exceedingly minute game bantams have been produced with the distinguishing characters of the larger breed. But the long-legged and long-necked "stilty" game fowls, which resulted at one time from breeding for exhibition purposes, have been again superseded in favour of the old and genuine type.

Cochins.—This type, which must be regarded as including not only the birds generally so-called but also the Brahmas and Langshans, is of very large size, some of the males reaching the great weight of 16 or 17 lb. They are distinguished by a profusion of downy plumage, with small wings and tails; they are incapable of long flight, and the pectoral muscles are consequently but feebly developed. The Cochins originally imported from Shanghai were of several colours; some of the grey birds in America were crossed with the grey Chittagong, the Brahmas being the result of the cross, and they became established as a pure breed, faithfully reproducing their own type. The Langshans, a later importation, have fuller breasts and less abundant plumage. The exaggeration of fluff and leg-feather has removed all Cochins—it is to be feared permanently—from amongst popular and useful breeds, and in only less degree the Brahma, once the most popular breed of the day. On the other hand, new sub-breeds, based upon a cross from one or the other of the Asiatic races, have been multiplied and largely bred, these being all of smooth-legged type and somewhat less in size. A sub-variety of Cochin, raised in America, by crossing with a cuckoo-coloured breed long known as Dominiques, became fashionable under the name of Plymouth Rocks. They are cuckoo-coloured, viz. each feather is marked with transverse grey stripes on a lighter ground, and, as in all cuckoo-coloured breeds, the cocks are of the same colour as the hens; their legs are not feathered, and the plumage is not so loose as that of the more typical Cochins. To the original cuckoo-coloured Plymouth Rock have been added buff and white varieties; and by crossing Cochins and Brahmas with other fowls, American breeders produced another useful race of compact form with smooth yellow legs, and white feathers laced with black round the edges, called the silver-laced Wyandotte, to which were speedily added other colours and patterns of plumage. The feathered Langshan has given rise to the black Orpington with smooth legs; and a local cross of Cochin and Dorking prevalent in Lincolnshire, to a buff breed with smooth white legs, now called the buff Orpington, though quite unrelated to the former. All these are useful for table, and good layers.

Malayan Fowls.—The Malayan type has been long recognized as of Eastern origin. The birds are of large size, close and scant in plumage, with very long legs and necks. The *Gallus giganteus* of Temminck, which he regarded erroneously as a distinct species, belonged to this group, as did the Kulm fowl and the grey Chittagong of the United States. The Malays are of savage disposition. Several

smaller breeds of a somewhat similar type are known as Indian Game; some of these, as the Aseels, are of indomitable courage. Until the arrival of the so-called Cochin breeds from the north of China, Malays were the largest fowls known in Europe and were employed to impart size to other varieties by crossing.

Spanish.—The Spanish or Mediterranean type is well marked. The birds are of moderate size, with large single erect combs and white ear-lobes. In the black Spanish the whiteness of the ear-lobe extends over the face, and its size has been so greatly developed by cultivation that in some specimens it is 6 or 7 in. in length and several in breadth. Closely related to the Spanish, differing only in colour of plumage and extent of white face and ear-lobe, are the white and brown Leghorns, the slaty-blue Andalusians, the black Minorcas, &c. All are non-incubators, the desire to sit having been lost in the tendency to the increased production of eggs, which has been developed by the persistent and long-continued selection of the most fertile layers. The white-faced black Spanish, once the most widely kept, has almost disappeared; but the allied red-faced Minorca and the blue Andalusian have achieved great popularity as free layers of large white eggs; and the yellow-legged Leghorns of similar type, though rather smaller, have spread on all sides with much multiplication of varieties, the latest of which, with mottled black and white plumage, is termed the Ancona.

Hamburghs.—The Hamburghs, erroneously so called from a name given them in the classification adopted at the early Birmingham shows, are chiefly breeds of English origin. They have double combs and small white ear-lobes. There are various sub-varieties. Those with a dark crescent-like mark on the end of each feather of the hen are termed Spangled Hamburghs. Others are of uniform black plumage. A somewhat similar breed of smaller size, with each feather of the hens marked with transverse bands of black on a white or bay ground, is termed Pencilled Hamburghs; they were formerly known as Dutch Every-day-layers. These breeds are all non-sitters and lay a remarkably large number of eggs. Hamburghs in England have been depressed in recent years by the complicated system of breeding separate strains for each sex; but there has been introduced from Europe the hardy Campine or Braekel, resembling the pencilled Hamburgh in plumage, but larger and with a single comb, and laying a large egg in great numbers.

Crested Fowls.—The crested breeds (non-incubating) have long been cultivated on the continent of Europe and are admirably delineated in the pictures by Hondekoeter and other early Dutch artists. In Great Britain they are erroneously termed Polish. The development of the feathered crest is accompanied by a great diminution in the size of the comb, which is sometimes entirely wanting. The wattles also are absent in some breeds, their place being occupied by a large tuft of feathers, forming what is termed the "beard." In all the crested breeds there is a remarkable alteration of the cranium, the anterior part of the skull forming a prominent hollow tuberosity which contains a very large part of the brain. This portion of the brain-case is rarely entirely ossified. There are numerous sub-varieties of crested fowls. The best-known breeds in England are the spangled, with a dark mark at the end of each feather. This mark often assumes a crescent shape, the horns of the crescent sometimes running up each margin of the feather so as to form a black border; feathers so marked are termed "laced" by poultry-fanciers. There are also white Polish and a buff variety. A very distinct sub-variety is the black breed with a white crest on the head and large pendent wattles. A variety with the arrangement of these colours reversed was formerly known, but it has now become extinct. Some of the larger breeds of the west of Europe are closely related to the Polish. The *Crève-cœur* is a crested breed of uniform black colour; it is of large size and of great value for the table and for egg-production.

The Houdan is a black and white breed of very similar character. In some breeds the form of the body and structure of bones of the face closely resemble those of the Polish, but there is an absence of the feathered crest, the crescent-shaped comb becoming more largely developed; such are those known as Guelders, Bredas, and La Flèche, the latter being the best French fowl for eating. A small white-crested variety, profusely feathered on the legs, was received about 1864 from Turkey; they are known as Sultans. The older French breeds are less kept than formerly, but a race originated in France by crossing Houdans with Dorkings and light Brahmas, and known as the Faverolles, is a tender and quick-growing table fowl, and even in the Houdan district itself is displacing the Houdan, one of its ancestors. The Faverolles have single upright combs, beards and whiskers, slightly feathered legs, and five toes on each foot; and the general colour of the hen is salmon or fawn, with an almost white breast.

Dorkings.—The Dorking type includes fowls that have for many generations been bred for the supply of the London markets. They are all fleshy on the breast and of fine quality. The Dorkings have an extra toe, a monstrosity which leads to disease of the feet. The Surrey and Sussex fowls are four-toed. The coloured Dorkings were greatly increased in size by crossing with an Indian breed of the Malay type. The birds of the Dorking type are fair layers and good sitters. They are rather delicate in constitution, and are chiefly bred in the south of England. Crossed with the game breed they furnish a hardy fowl, plumper than the Dorking and larger than the

Game, which is of unsurpassed excellence for the table. Mating a Dorking cock with large game hens is found to be the most advantageous.

Silk Fowls.—These constitute a singular variety, in which the barbs of the feathers are not connected by barbules and the entire plumage has a loose fibrous appearance; similar variations are found amongst other species of birds, but are soon lost in a wild state. The silk fowl best known is that in which the plumage is perfectly white, whilst the skin, cellular tissue between the muscles, and the periosteum covering the bones are a deep blue-black, the comb and wattles being a dark leaden blue. The birds are admirable sitters and mothers, and are much valued for rearing pheasants, being of somewhat small size. Though of remarkable appearance when cooked, they are of good quality. In crosses with other breeds the silky character of the plumage is generally lost, but the dark skin and intermuscular cellular tissue remain and greatly lessen the value of the birds in the market.

Frizzled Fowls are birds in which each feather curls outwards away from the body. They are common in India, but are not adapted to the climate of Britain, as the plumage offers an imperfect protection against wet.

Rumpless Fowls are those in which the coccygeal vertebrae are absent; there is consequently no tail. By crossing, rumpless breeds of any variety may be produced. They are not desirable to cultivate, as, from the structural peculiarities, the eggs are very apt to escape being fertilized.

Dumpies or Creepers are birds in which the bones of the legs are so short that their progression is considerably interfered with. The best known are the Scotch dumpies.

Long-tailed Fowls, under the various names of Yokohama or Phoenix fowls, or Shinotawaro fowls, are singular varieties recently introduced from Japan, in which the sickle-feathers of the tail are 6 or 7 ft. long. In Japan they are said to assume a much greater length. One bird in the museum at Tokio is stated to have sickle-feathers 17 ft. long. In other respects the fowls are not peculiar, resembling the birds of the Game type.

Bantam.—This term is applied to fowls of a diminutive size without any reference to the particular breed. By careful selection and crossing with small specimens any variety can be reduced to the desired size. The Chinese had in the Summer Palace at Peking small Cochins weighing not more than 1 lb each. The Japanese have long possessed a dwarf breed with enormous tail and comb, and with very short legs. One of the most artificial breeds is the Sebright bantam, named after its originator. This bird has the laced or marginal feather of the Polish combined with the absence of male plumage in the cocks, so that it may be described as a hen-feathered breed with laced plumage. When perfect in marking it is of singular beauty, but is not remarkable for fertility.

Most of the modern changes in breeds, broadly speaking, have been in the direction of replacing poultry with chiefly fancy points by really useful fowls, yet it is noteworthy that they have been carried out by fanciers, or breeders for exhibition, proving that there has not been that practical antagonism between the aims of these breeders and the production of food which some have alleged. But there has further been, since 1890 especially, a remarkable development of what has been termed "utility" poultry-breeding.

Feeding and Egg-production.—These aspects of poultry-culture are closely connected, and in both such advances have been made as almost amount to a revolution. The breeders of the United States have led the way, and, though it had first been taught in England, were the first to practise generally the systematic breeding, year after year, from the best layers only. It had always been known that some hens would lay from 150 to 200 eggs in a year whilst many did not exceed 100, and some laid much less. This was tested (on a better stock than the average) at the Maine experimental station in 1898-1899, 260 pullets being selected, of which 5 died and 19 were stolen. Of the remainder, 39 laid 160 eggs each or more, and 22 less than 100, the rest coming between these figures; the five best laid 200, 201, 204, 206 and 208 eggs in twelve months, and the three worst only 36, 37 and 38 in the same time. From such figures the money value of selective breeding is apparent. As a proof of what may be done by systematic breeding, one American breeder obtained an average of 196 eggs per annum from as many as 600 white Leghorns, and another 194 eggs from 140 Plymouth Rocks; greater numbers have been obtained from single birds or small pens of fowls, but these are results from considerable flocks.

It has been proved, however, that such averages as these cannot be obtained unless they are fed for as well as bred for.

The most successful egg-farmers now feed their poultry on definite "rations," compounded so as to give what is termed a proper "nutritive ratio," or proportion of albuminoids to carbonaceous material. The basis of such feeding is analysis of foodstuffs, in some form which shows simply their percentages of albuminoids, fats or hydrocarbons, carbohydrates (starch, sugar, &c.), salts, crude husk or fibre, and water. Fats, being relatively much richer in carbon than the starch compounds, are generally multiplied by 2.25, and this product added instead to the carbohydrates; then the ratio of albuminoids or nitrogenous matter to this total of carbonaceous compounds is the "nutritive ratio." The following is a useful table of analyses made out in this way, taken from *The Book of Poultry*:—

Analyses of Poultry Foods.

Articles of Food.	Albuminoids or Flesh-formers.	Fats or Oils.	Fats x 2 1/4 = Value in Carbohydrates.	Carbohydrates.	Salts and Minerals.	Husk or Fibre.	Water.
<i>Grains and Meals.</i>							
Linseed meal	32.9	7.9 = 17.8		35.4	5.7	8.9	9.2
Beans and peas	24.0	1.5 = 3.4		48.0	2.5	10.0	14.0
Malt sprouts	23.2	1.7 = 3.8		48.5	5.7	10.7	10.2
Oatmeal	18.0	6.0 = 13.5		63.5	2.0	1.5	9.0
Middlings or Fine Sharps	16.0	4.0 = 9.0		57.0	4.5	4.5	14.0
Sunflower seed	16.0	21.5 = 48.4		21.4	2.6	29.0	9.5
Bran	15.5	4.0 = 9.0		44.0	6.0	16.5	14.0
Oats and ground oats	15.0	5.5 = 12.4		48.0	2.5	19.0	10.0
Wheat	12.0	1.8 = 4.0		70.1	1.8	2.3	12.0
Barley (and meal)	12.0	1.4 = 3.2		56.0	3.6	14.0	13.0
Millet seed	11.3	4.0 = 9.0		60.0	3.0	9.4	12.3
Maize	10.5	8.0 = 18.0		66.5	1.5	2.5	11.0
Rye	10.5	1.8 = 4.0		72.5	1.9	1.7	11.6
Buckwheat	10.0	2.2 = 5.0		62.2	2.0	11.0	12.6
Hempseed	10.0	21.0 = 47.2		45.0	2.0	14.0	8.0
Dari	9.5	4.5 = 10.1		68.7	1.5	3.3	12.5
White bread	8.8	1.8 = 4.0		56.4	0.5	0.0	32.5
Rice	6.6	0.4 = 0.9		80.0	0.0	0.0	13.0
Brewers' grains	5.4	1.6 = 3.6		12.5	1.0	3.8	75.7
<i>Vegetables.</i>							
Potatoes	6.5	0.0 = 0.0		41.0	2.0	0.0	50.5
Red clover	5.0	0.8 = 1.8		13.3	2.4	6.5	72.0
Meadow grass	3.5	1.0 = 2.2		13.5	2.0	4.7	75.3
Hay	8.4	2.6 = 5.8		41.0	6.2	27.2	14.6
Cabbage	2.4	0.4 = 0.9		3.8	1.4	1.5	90.5
Onions	1.5	0.2 = 0.5		4.8	0.5	2.0	91.0
Turnips	0.5	0.1 = 0.2		4.0	1.0	1.4	93.0
<i>Animal Foods.</i>							
Dry meat meal	71.2	13.7 = 30.8		0.3	4.1	0.0	10.7
Flesh of fowls	21.0	3.8 = 8.5		0.0	1.2	0.0	74.0
Horse-flesh	21.7	2.6 = 5.8		0.0	1.4	0.0	74.3
Lean of beef	20.5	3.5 = 7.9		0.0	1.6	0.0	74.4
Fresh-cut bone	20.2	26.1 = 58.7		0.0	24.0	0.0	29.7
Dried fish	48.4	11.6 = 26.1		0.0	29.2	0.0	10.8
Milk	4.0	3.5 = 7.9		4.8	0.7	0.0	87.0
Skim milk (separated)	3.1	0.3 = 0.7		5.3	0.7	0.0	90.6
Eggs (yolk only)	16.0	30.0 = 67.5		0.0	1.0	0.0	53.0
" (white only)	12.0	2.0 = 4.5		0.0	1.2	0.0	84.8

Many writers have introduced unnecessary complication into a very simple matter. Some elaborately compute the amount of "dry matter," which is needless if our analyses show the proportion of water, as above. Others have calculated "digestibility," on the theory that food not rejected as excrement is "retained in the body." This theory has a basis in the case of animals which consume a large amount of hard indigestible fibre, excreted in such a form as horse manure; but fowls macerate all they eat in the crop, and grind it in the gizzard, and in their case the excreta represent very little undigested food, but mainly the final result of the vital processes, and of food usefully employed in carrying these on. We may be sure that we more than allow for any factor of indigestibility if we merely leave out any crude husk or fibre, giving that to the fowl for whatever it is worth, and calculate our ratio direct from the figures of the table.

Two extremely simple cases will suffice as examples of the modern method. Potatoes are often cheap, but on account of their starchy composition require a "balance," and the same may be said of maize: one method of balancing each will show what is meant and the simplicity of the calculation. We will take potatoes and bran first.

Ratio of Potatoes and Bran.

	Albumi- noids.	Fat $\times 2\frac{1}{4}$.	Carbo- hydrates.	Salts.
1 lb Potatoes	6.5	0.0	41.0	2.0
1 lb Bran	15.5	9.0	44.0	6.0
	22.0	9.0	85.0 +9.0	8.0
			94.0	

Adding here the fats $\times 2\frac{1}{4}$ to the carbohydrates, we get the ratio of the mixture as 22 : 94, or about 1 : 4 $\frac{1}{4}$, which is very good. Coming next to the maize, let us suppose that it is desired to feed this as grain in the evening, and to "balance" it by an equal weight of "mash" or soft mixture in the morning. One way would be as follows:—

A Diet containing Maize.

	Albumi- noids.	Fat $\times 2\frac{1}{4}$.	Carbo- hydrates.	Salts.
3 lb Maize ($\times 3$)	31.5	54.0	199.5	4.5
1 lb Horse-flesh	21.7	5.8	0.0	1.0
2 lb Ground oats ($\times 2$)	30.0	24.8	96.0	5.0
	83.2	84.6	295.5 +84.6	10.5
			380.1	

This ration explains how in such a case we must multiply the figures for maize by 3, and those for oats by 2, being the proportions we are taking to one portion of horse-flesh. The ratio of this dietary comes out slightly lower than 1 : 4 $\frac{1}{4}$.

The proper ratio for feeding fowls has received much discussion. Dietic authorities mostly agree that about 1 : 5 is the best for maintenance of animal life generally, and more specifically that there should be of albuminoids about 18 parts in 100, of fats 7 and carbohydrates 75. That should suffice for growing chickens; but it is fairly obvious that fowls fattening may require more fat, while the constant production of eggs, whose high ratio is shown in the analyses, must require a larger amount of albuminoids. This fact is indicated by the hen herself, which when laying devours large earthworms, usually rejected with disgust at other times. She shows by this appetite how specially she needs albumen; and fowls on a wide range, though only fed with corn, may thus in summer "balance" a dietary for themselves by the worms and insects which they procure. When they cannot do this, more albumen must be supplied, and the general opinion of practical egg-farmers has tended towards a ratio of 1 : 4 or 1 : 4 $\frac{1}{4}$ for hens in full lay. One successful American breeder feeds as high as 1 : 3, and states that his results have been best at that figure.

Passing from theory, the greatest practical advance in poultry-feeding has probably been the discovery of the benefit to be derived from dividing the extra supply of albumen between fresh bones cut up small in a mill (known amongst breeders as "cut bone") and such green food as clover or cabbage. The bones contain a good proportion of fat, and of mineral salts also, which careful experiments have shown to be of great importance both in egg-production and for growing stock. Green food had until recently been looked upon chiefly as a corrective, or necessity for health, though it was known that fowls on a pasture grazed largely. But the nutritive ratio of clover is as high as 1 : 3, and American poultry-farmers now use it largely as really albuminous food, to promote laying. Its use in this way also allows more animal food to be used without ill effect; and to this free use of clover and cut bone in conjunction the improved results upon American egg-farms are largely due. The following is the "mash" ration on a successful American egg-farm, and represents a high forcing diet: middlings or sharps 100 lb, maize-meal 75 lb, gluten-meal (a highly nitrogenous by-product of American flour-milling) 25 lb, clover-meal 80 lb, meat-meal 35 lb, all weighed dry, mixed with boiling water in the evening, and kept covered all night.

The majority of poultry-farmers give their stock each day one feed of grain, and one of soft meal-food or "mash," but by no means agree as to the times for these meals. In England, morning mash and evening grain are almost universal, the latter giving more support during the long fast at night, and the former more rapid recuperation on cold mornings. But in America

and Canada, where the climate compels confinement of the fowls for months together in enclosed sheds, health and eggs can only be secured by constant "scratching," to promote which the grain is scattered amongst loose litter spread several inches deep. Many, therefore, prefer to scatter the grain in the morning and feed the mash at night, alleging that a good breakfast of mash makes the fowls lazy, with bad results. Others state that this is avoided by a rather scantier morning feed of mash, with a slight sprinkle of grain in the litter afterwards. In 1890 a careful experiment was made by the Massachusetts Agricultural College, two similar lots of pullets being fed upon similar food, on the two plans, for two periods of several months each, in summer and winter seasons, and each lot receiving, besides the morning and evening feeds, a slight sprinkle of millet in the litter, to promote exercise. In egg-production there was scarcely any difference, what little there was being in favour of the morning mash; and the birds thus fed became also somewhat the heaviest. The most remarkable result was that the weight of manure voided in the night was nearly double in the case of the evening-mash birds, showing the rapid digestion of mash food.

Artificial Incubation and Rearing.—In the separate article on INCUBATOR, details are given concerning the appliances used in artificial hatching and rearing, and the subject may be only briefly treated here.

Even in England the eggs hatched in incubators now probably equal, or nearly equal, those hatched under hens: in America the wide practice of artificial incubation is difficult to realize. Of small-sized machines one Illinois maker sold 14,800 in 1899; and in regard to large sizes, in 1900 at least seven names and addresses were known of operators who each used from 55 to as many as 85 machines, every machine holding 300 or more eggs: somewhat smaller plants were of course far more numerous. Experience on such a vast scale has led to a practical advance of considerable importance. While in England it is still usual to effect empirical adjustment of ventilation and moisture, the better American incubators now dispense with direct moisture altogether. It was remembered that the hen hatches without moisture, and equally so the egg-ovens of Egypt; the absence of direct air-current, and consequently of any rapid evaporation, being the obvious explanation. The manufacturers therefore set themselves to slow the movement of the air; and when this object was effectually accomplished, it was found that there was no need for moisture, and that the chicks also hatched out stronger and in higher proportion. The general opinion in the United States, where many farmers tested both hens and machines on a large scale, whilst still undecided between them, is that the proceeds of artificial incubation are superior by about 10%, and this is based upon hatches of thousands annually.

Artificial hatching necessitates artificial brooding, and in this also great changes have taken place, any real success in rearing having been for some years far behind that in hatching. The method universally attempted at first might be called the "coverlet" system, nestling material such as strips of flannel or wool, warmed from above, being provided for the chicks to nestle under, as they do under the feathers of the hen. Many were reared in this way, but failures were also terribly general, and these were ultimately traced to confinement and pollution and heating and rebreathing of the air, caused by the nestling material. That system is now abandoned, warmed but open chambers being provided, which the chicks use at pleasure, but which have no coverlet to rest upon their bodies. In some, heated pipes traverse the upper part of the chamber, some inches above the chicks; in others a warm iron plate radiates heat in the same way; in others warmed air is brought in by flues or openings; in some small ones the lamp itself burns in the chamber of the brooder: but the principle is common to all of a warmed shelter, open above, and generally with an outer chamber also, sheltered but not heated, which breaks the transition to the open air outside. In America a very large proportion of the chickens reared are brought up till hardy in the large "brooder-houses" mentioned below.

Poultry-farming.—Poultry-farming in a practical sense is now carried on somewhat extensively in various ways, understanding that term to include any case where poultry-culture is carried on for substantial profit, or as an important interest of the holding, beyond the mere breeding of prize birds for exhibition. The difficulty never had been, as some have stated, in ground getting tainted or rent costing too much. It is now well understood that in the English climate 100 birds per acre must not be exceeded, though it is far better to confine them to one-half or one-third of the space, while some crop is got off the remainder when they go yearly to absolutely fresh ground. The mere rent of an acre is not much for 100 fowls, but the real difficulty was and is that a fowl is such a *small* unit, entailing constant liability to small losses and wastes, and necessity for labour and oversight out of proportion. Hence at a time when 100 eggs per annum was thought a fair return for each bird, and there was but a poor and uncertain market for them, this difficulty was insuperable. A very different average production would now be worked for; while, on the other hand, the greater crowding into cities, and growing appreciation of eggs as an article of diet, have caused a market for "new-laid" eggs at good prices which previously did not exist. It is these changes which have altered the conditions.

The chief development in England at the beginning of the 20th century was a very large increase in the poultry kept upon farms. Formerly very few were kept, looked after casually by the mistress or a boy, and only expected to provide for the household and occasionally a few shillings in cash, while any food expressly fed to them was grudged. It has now been taught all over the country, by lecturers under the county council technical instruction committees, that poultry pay best of any branch upon a farm. It has become generally known that, provided they can be run over the farm by using detached houses, and not huddled together, a dozen hens per acre can be kept upon a holding without interfering with any other stock; indeed, the curious fact is observed that horses and cattle prefer to graze over grass that might be thought soiled by the fowls. Where the statement was once derided, it is now a commonplace of county council lecturers, that the additional manure thus made is really worth to the farm from sixpence per bird per annum for small breeds to as much as one shilling for very large ones. Out of a large number of similar instances collected in 1900, one specimen may be given. In Worcester-shire 210 fowls had the run of 100 acres, lots of 20 to 30 being kept in detached houses. From 20,000 to 25,000 eggs per annum were marketed, and 150 to 200 chickens, the food averaging about £40, and the cash return £90 to £100. The almost universal opinion is that the manure pays for the labour, and that the annual profit averages from 4s. to 5s. 6d. per head.

Poultry-farming on a larger scale than this is also carried on in connexion with the Sussex fattening industry, presently described. That was until recently a separate business, chickens being bought from neighbouring small rearers, or imported from Ireland, to go directly into fattening cages; and it has often been stated that rearing and fattening together were incompatible. This was so far true that the manure made by numbers of fattening poultry was very considerable, and had to be used upon a small holding kept in order to use it; such a holding, therefore, received as much as it could possibly bear, and was thereby "sickened" for live poultry running at large. But with an extra holding or larger holding this is not the case, and increasing competition and the desire for the two profits have led to a large amount of rearing and fattening combined. In 1894 one of the officers of the agricultural commission found 8000 chickens being reared and fattened annually on one farm of 200 acres, and this proved only a pioneer: in 1900 he found (amongst many such instances) 4000 reared upon 80 acres, 1500 upon 22 acres and 5000 upon an extra holding (taken for the purpose) of 40 acres. In most cases the main cereal crop was oats, to be fed to the fowls; and some cows were kept, the skim milk from which was used in the same way; but the poultry was the controlling interest of the whole.

On any such scale as this the manure becomes of great importance. About 1880 Dr Augustus Voelcker, chemist to the Royal Agricultural Society, made the following analysis of two samples, one moist or fresh dropped, the other freed from much moisture by storing under cover for four weeks:—

	Fresh Manure.	Partially Dried Manure.
Moisture	61·63	41·06
Organic matter and ammonia salts	20·19	38·19
Tribasic phosphate of lime	2·97	5·13
Magnesia, alkaline salts, &c.	2·63	3·13
Insoluble silicious matter (sand)	12·58	12·49
	100·00	100·00
Containing nitrogen	1·71	3·78
Equal to ammonia	2·09	4·59

Valued in the usual way, Dr Voelcker found that the moist manure was worth £2 per ton, and the drier stored manure £4 4s. per ton; but though the figures were indisputable, for many years such manure was practically unsaleable. Gradually in Sussex it became saleable at 6d. per bushel, and in 1900 some of the smaller fatters were selling it at prices varying from 4s. to 15s. per load; the larger men either used it themselves or obtained higher prices.

Really large poultry-farms are few in England, and to give quite recent facts would be to run the risk that they might prove ephemeral. It has been supposed that the common experience is failure after two years' trial, but this is unduly pessimistic. Even in 1901 two farms in Berkshire were selling eggs from over 2000 and 3000 laying hens; and there was one farm in the west of England, occupying 300 acres with the poultry (besides a shorthorn herd and other branches), which had a stock of 5000 pullets for laying, and had been in existence four years, a large capital amounting to thousands of pounds having been sunk in it. The owner explained that two years was the critical period, simply because for about that time there were practically no returns, and that in his case he had only "turned the corner" after three years. Though a practical man already, he had begun in a small way with one incubator and training one man; gradually extending, building up his own market, organizing his own selling agency, and building a mill to grind his own grain. Only such gradual extension by practical men can ever lead to success.

Besides the breeding of prize poultry, the changes mentioned in the early portion of this article have led to another class of breeding directed to the supply of pure races from good stock, but bred mainly for purposes of utility. The demand for such stock, at fair prices, though far below those for prize stock, is a good index of the development of the poultry industry. The establishments which supply it furnish eggs for hatching, or stock birds, or newly hatched chickens, which are now hatched in incubators and sold by thousands when only one day old, at which age they travel without needing food. Some of such establishments are quite large. One in Yorkshire occupies 43 acres solely devoted to this business.

Poultry-farming has reached its fullest development in the United States, owing no doubt to the apparently inexhaustible market; butcher's meat being far less eaten than in England, and poultry and eggs to a large extent replacing it as national food. More especially is there an enormous demand for small chickens, known as "broilers," weighing from 1½ lb to 2 lb only, destined to be split in half and broiled on a gridiron. These birds being unfattened, and ready at ten or twelve weeks, give a quick turnover with less expense and risk than older fatted birds; and this peculiar demand has largely dominated American poultry-farming, a great deal of which runs in the direction of great "broiler-plants" solely devoted to the hatching and rearing of these broilers, while large "brooder-houses," similar to those used in that business, are prevalent on more miscellaneous farms. The broiler business started at Hammonton in New Jersey about 1880-1885, when plant after plant was rapidly erected, some of which have since shut down; but many others

have taken their place, and some of the originals are still running. The chicks are all hatched in incubators (many plants running from 20 to 40 machines), and then transferred to long "brooder-houses," built with a corridor all along one side, the rest being divided into successive pens for the chickens. These latter are moved along every few days to the next of the pens, which are arranged so as to give rather more space as the birds grow larger. Each pen has next the corridor a "hover" or brooding-shelter. These have no nestling material, but only a roof or cover somewhat to retain the heat, closed by a curtain cut into strips in front; and are warmed by hot-water pipes running along the building. Generally these pipes run some inches above the chicks reposing on the floor, and are set rather on a slant, so as to be higher for the bigger chicks in the larger pens; but in some cases they run under the floor, and warm the air which enters under the hovers. Every hover, with its inmates, can be reached from the corridor at the back of all. In many cases the chickens are confined in these small pens until large enough, the floors being littered and regularly cleaned; but some raisers have also small outside yards which they use in fine weather. The mortality in nearly all plants is great, as might be supposed. There are said to be some at Hammonton which only market 30% of the eggs incubated, yet pay a modest profit at that, which is allowed for. On the one hand, a broiler realizes about four times the cost of its own hatching and food; on the other hand, the labour is very heavy and the loss considerable: these factors obviously give a very wide margin of possibilities as regards success or failure.

The most remarkable establishment of this kind, embodying some novel features, was erected in Ohio at the end of 1896 by J. Loughlin. The plant cost over \$60,000, and was designed to market 250 to 300 broilers per day regularly, weighing 1½ lb each, which were sold alive to one large dealer at \$3 per dozen. Each day an average of 450 eggs were started, the chicks from which went into one pen. For the chicks, while small, there were 30 small pens, each with 5 by 10 ft. of floor space, or at the rate of six chickens per sq. foot; and there were 60 larger pens each 8 by 12 ft. with outer runs to each of 8 by 20 ft. Every day the chickens were marketed from the ninetieth pen, and all the rest moved one pen forward, leaving the first small pen vacant for the day's batch: thus fully 22,000 birds were in the plant at one time.

In more general American poultry-farms the same system of "brooder-houses" largely prevails, and from many great numbers of broilers are sent to market; but as both heart and liver are perceptibly affected by such rearing, birds intended for stock are either taken out of doors early, or reared in detached brooders, as in England. Some establishments are mainly egg-farms, high averages being obtained by the system before described. Many breeders have a high reputation for their stock as layers, and derive large profit from selling stock or eggs to other farms. There are many immense duck-farms or "ranches," as mentioned below, which sell nothing except stock ducks or market ducklings. A great many combine the breeding and sale of exhibition poultry with some or all of these objects, fancy points being on the whole less distinct from useful qualities than in England, and the farmer and exhibitor far more commonly combined.

As a rule, American poultry-farmers employ long ranges of buildings divided into pens or houses, with enclosed yards in front; and the most remarkable fact is that interest can be paid upon the capital sunk in such buildings. The explanation in some cases is that much is put up by personal labour, while the cheapness of land and feed are also favourable. But the climatic conditions also differ. During the winter months the birds have to be confined in what are called "scratching-sheds," and American farmers have successfully reduced to a system the keeping of them healthy and in profit by scratching amongst litter in a small space. During this period the outer runs sweeten and recuperate; smaller runs therefore suffice, and the stock is kept closer and more compact. Another system is pursued, more especially about Rhode Island, called the "colony"

plan; detached rough houses, holding forty or fifty hens each, being scattered over the farm: there may be a hundred houses, but there is no fencing. This is very economical in buildings, but expensive in the labour of feeding and collecting eggs, and the system is only possible near the sea or where there is little snow. In several cases it has been abandoned for the system of housing and scratching-sheds.

There are a few very large establishments indeed in the United States, combining almost every branch. At the Meadow Brook Farm in Pennsylvania, occupying 80 acres, the buildings total 112,000 sq. ft. under cover, and the farm has sent to market in one year 25,000 chickens and 20,000 ducklings, besides selling many stock birds, and an enormous number of eggs for hatching at an average price of \$40 per 1000. Businesses like this are very exceptional; but farms on a more moderate scale are numerous, and intelligent American farmers reckon to make a profit of a dollar per annum for each head of their laying or breeding stock.

Table Poultry.—National taste governs the market for table poultry to a large extent. In England white meat, skin and legs are preferred, and at one time black legs or yellow skin were heavily discounted. More knowledge has largely removed that prejudice, but white has a market value still. In France exceedingly white and smooth skin is preferred, but buyers are indifferent to black legs. In America yellow skin and legs are actually preferred, such fowls being thought more juicy; but there has been some tendency towards white meat of late. Belgian feeders think the best result follows from crossing a yellow-skinned race upon a white-fleshed one. It is some confirmation of this idea that one of the best English table fowls is the produce of a cross between Dorkings and the yellow-skinned Indian game, while other similar instances might be cited. For some years past the quality of British table poultry has been shown by displays of plucked birds in connexion with the Christmas Smithfield Cattle Show. For many years France had a reputation for greatly surpassing British production; and as the best French fowls readily sell for £1 each and more in the Paris market, it would not be surprising if they were superior to such as have to be sold for 15s. per couple. French fatters appear to seek and obtain a smooth whiteness of fat under the skin—almost like that of a bladder of lard—which does not find favour in the British market; but the best judges have considered that the finest English specimens staged were equal to all comers, and some realized high prices. Foreign experts, equally with English, admit that England has now little to learn from any foreign feeders.

The chief supply of the best fowls for the London market has long come from the Sussex district whose centre is Heathfield: these are termed "Surrey" fowls, though Surrey now sends few in comparison. This local industry has been founded in a curious way upon the "ground oats" of the district, the whole grain being ground up, husk and all, nearly as fine as flour. This is done by a peculiar local dressing of the stones, which are "stitched" into little pits by a pointed pick, instead of being dressed into narrow grooves, as for flour-milling; and this meal is found specially suitable for feeding and fattening poultry. In early times cottagers crammed a few fowls with pellets of meal dipped in milk, but this method is now quite superseded by machine cramming, a rubber tube from the machine being introduced into the crop of each fowl, and a stroke of the foot on a pedal squeezing out a ration of thin, almost creamy, paste, composed of the ground oats, fat and sour skim-milk, a food which puts on flesh fast and makes it white and delicate. Great experience is required in this business. When killed and plucked, the fowls are placed in a trough whilst still warm, close side by side, and their backs and breasts pressed closer together by a board loaded with heavy weights. This combination of fattening and subsequent shaping constitutes the Sussex system, which is extending in some other parts of England; many excellent fowls, well fed, but unfattened, are also supplied from Lincolnshire (known as "Bostons") and other districts. The largest provincial towns have similar supplies in less degree.

In America larger fowls are called "roasters," to distinguish them from the broilers above described; and there has grown up in the eastern states a system of rearing these also in confinement. Hatching them begins in September, and the birds are at first reared in brooder-houses; but when large enough are placed about fifty together in small houses, with 6 by 8 ft. of floor, in small yards about 20 ft. square. One very successful raiser puts 200 birds into one pen 10 by 17 ft., in a warmed house, where they remain till killed at 7 lb or 8 lb weight. One firm had raised in this way, for seven years in succession, 2000 birds per annum upon half an acre of ground, but occasionally there is serious mortality in this kind of business, and as a rule only 60% are reared of those hatched, the loss of the rest being averaged and allowed for.

In western Europe there is some demand for chickens fattened quite young, weighing only 8 oz. to 12 oz. each, and known as *petits poussins*, or "milk chickens." In Belgium somewhat older ones,

weighing up to 1½ lb, are sold as *poulets de grains*. The demand for such birds in England is small, and confined to the West End of London, the flesh being too excessively tender for average English palates. Birds of similar sizes have lately been finding a market in the United States, as "squab broilers," but are split and broiled, and not fattened, the difference being that a whole bird is served for one portion.

Turkeys.—The varieties of the turkey (*q.v.*) differ chiefly as to colour. The principal English breeds are the bronze or Cambridge, the black or Norfolk, the fawn and the white. Of these the first, especially when crossed with the American, is the largest and most desirable.

Turkey-breeding has been largely dominated by the magnificent American bronze breed, derived from wild blood, and distinguished for size and weight. There is some question whether it does not require more space and fresher ground than the older English strains, and may not be more delicate on small holdings. French birds come largely to the Christmas market in London, but, as compared with English, are small. The chicks, when hatched after twenty-eight days' incubation, should be left undisturbed for twenty-four or thirty hours, during which time they are digesting the yolk that is absorbed into the intestinal canal at birth. No attempt should be made to cram them; their first food should consist of sweet fresh meal, soft custard made with equal parts of egg and milk set by a gentle heat, and, above all, abundance of some bitter milky herb, as dandelion, or, much better, lettuce running to seed, on which they can be reared successfully with very little food of any other description. The young turkeys progress much better if the hen has the range of a small enclosure from the first than if she is confined to a coop; thus reared they are much harder than when cooped and corn-fed, and not so susceptible to injury from slight showers; but a damp locality should be avoided. Turkey-hens are most persevering sitters, and are employed in France to hatch successions of sittings of hens' eggs. Turkeys can often be most advantageously reared by cottagers, as one or two hens only can be kept, one visit to the male being sufficient to fertilize the entire batch of eggs. The young turkeys find a larger proportion of their own food than fowls, and with a good free range cost but little until they are ready for fattening for the table. In places where the opportunity serves they may be allowed to roost in the trees with great advantage. Some wild flocks treated like pheasants are to be found in several of the large parks in Scotland as well as in England.

Guinea-fowls.—The guinea-fowl (*q.v.*) may be successfully reared in any dry locality provided it has a good range and trees in which to roost. The hen lays an abundance of eggs, which are generally hidden. The birds are useful as furnishing a supply of poultry for the table in the interval that ensues between the time when game are out of season and that before chickens arrive at maturity. On a dry, sandy and chalky soil and in a warm situation they are reared with ease, but are quite unsuited to damp, cold localities. The continued vociferation of the hen-birds renders their maintenance near a house very objectionable, as the cry is continued throughout great part of the night. Several variations of colour exist, but they do not require any detailed description.

Ducks.—All the varieties of the domesticated duck are descended from the common mallard or wild duck, *Anas boschas*, a species which, though timid in its wild state, is easily domesticated, and suffers changes of form and colour in a few generations. The most important breeds are: the Rouen, which, retaining the colour of the original species, grows to a large size; the Aylesbury, a large white breed with an expanded lemon-coloured bill; the Peking, a white breed with a pale yellowish tint in the plumage, and a very bright orange bill; two breeds which are entirely black. The smaller of these, which has been bred down to a very diminutive size, is remarkable for the extreme lustre of its feathers and the fact that its eggs are covered with a dark black pigment, which becomes less in quantity as each successive egg is deposited. It is known by the equally absurd names of East Indian, Labrador or Buenos Aires duck. The larger black variety, the Cayuga duck, has been introduced into England. Decoy or call ducks are small breeds of a very loquacious character, which were originally bred for the purpose of attracting the wild birds to the decoys. Some are of the natural colour, others are white. Amongst the less known breeds are the Duclair ducks of France, evidently the result of crossing white and coloured varieties. Among the breeds differing in structure may be mentioned the Indian Runner

duck, formerly called Penguin duck from its erect attitude, the hook-billed and the tufted ducks, &c. During the last fifteen years of the 19th century the first of these became very popular in England as a hardy forager and good layer, many birds laying 150 to 180 eggs in a year. It is small in body but good in flavour, and is a great favourite in many districts.

Formerly the greater number of ducklings came to the London market from the Vale of Aylesbury. This trade still continues, but the adherence of the Aylesbury duckers to old-fashioned methods, and the increasing demand, has led to great competition in other districts, such as Norfolk, Lancashire, Kent, &c. Some of the new duck-farmers market 10,000 to 15,000 annually, mostly hatched in incubators, and never allowed in the water or out of the small rearing-pens. In America, however, this kind of rearing has found its fullest development, the number who raise 10,000 ducklings or more being considerable, and a few sending to market, as above indicated, very large numbers indeed, requiring 40 to 80 incubators to keep up the supply. It is remarkable that while in England the Aylesbury is generally preferred, in America the Peking duck is universally used, and has been made by selection both larger and a better layer. Some duck-farmers in England have, however, also adopted the Peking. By good feeding the ducks are caused to lay in the winter months, when the eggs are hatched under hens, the young ducklings being reared in artificially warmed buildings or in the labourers' cottages; they are fed most liberally on soft food, soaked grits, boiled rice with tallow-melters' greaves, and in ten or twelve weeks are fit for the market; if killed before moulting their quills, which they do when about twelve weeks old, they are heavier than afterwards and much better eating. When ducklings are required for the early spring markets the old birds must be fed most freely to cause the production of eggs in cold weather, corn being given in vessels of water, and the birds must be shut up at night, or the eggs will be laid in the water, where they sink and become putrid. Duck-rearing is a very profitable industry, very high prices being paid for ducklings in the early months of the year. The so-called Muscovy duck is a Brazilian species, *Cairina moschata*, which is not reared for the market, although the young birds are edible. The drake not unfrequently mates with the common duck, and large but sterile hybrids are the result.

Geese.—The domestic goose (*q.v.*) of Europe is undoubtedly the descendant of the migratory Graylag goose, *Anser cinereus*, from which it differs chiefly by its increased size. Although domesticated since the time of the Romans, it has not been subject to much variation. The most important breeds are the large grey variety known as the Toulouse, the white breed known as the Embden, and the common variety frequently marked with dark feathers on the back, and hence termed "saddlebacks." After the Crimean War a Russian variety was introduced into England in which the feathers are singularly elongated, and even curled and twisted; this breed, termed the Sebastopol, is of small size and more important as a fanciers' breed than from a practical point of view. In some countries a second species is domesticated; it is usually termed the Chinese, knob-fronted or swan goose, *Anser cygnoides*. Though perfectly distinct as a species, having a different number of vertebrae in the neck and a loud clanging voice, it breeds freely with the common goose, and the hybrids produced are perfectly fertile.

Geese in England are declining in relative popularity. In Germany they are consumed to an enormous extent, and the British consul-general at Berlin reports that even the large domestic supplies have to be supplemented by considerable imports from Russia, a special "goose-train" of fifteen to forty cars arriving daily from the Russian frontier at that city. In America there has been increased interest in goose-breeding, and in the Chinese goose especially, which has been largely bred (with some trifling peculiarities) under the name of the African goose, and crossed with the Embden and Toulouse. The produce of this African cross is considered very fertile and profitable to rear.

Geese are much more exclusively vegetable feeders than ducks, and can only be kept to profit where they can obtain a large proportion of their food by grazing. The old birds should not be killed off, as they continue fertile to a great age. Geese are readily fattened on oats thrown into water, and the young, when brought rapidly forward for the markets, afford a very good profit. The Chinese, if well fed, lay at a much earlier date than the common species, and, if their eggs are hatched under large Cochon hens, giving three or four to each bird, the young are ready for the table at a very early period. The nest, as in all cases of ground-nesting birds, should be made on the earth and not in boxes, which become too dry and over-heated. In breeding for the market or for the sake of profit, the very large exhibition birds should be avoided, as many are barren from over-fatness, and none are so prolific as birds of fair average size.

National Interests and Commerce.—The foreign importations of eggs into Great Britain increased rapidly during the later years of the 19th century. Taking only alternate years for brevity's sake, the following table shows the amount, value and average price per 120 between 1870 and 1900:—

Number, Value and Price of Imported Eggs.

Year.	Number of Eggs.	Value.		Average Price.
		£	s.	d.
1870	430,842,240	1,102,080	6	1½
1872	531,591,720	1,762,000	7	11¼
1874	680,552,280	2,433,134	8	7
1876	753,026,040	2,620,396	8	4
1878	783,714,720	2,511,696	7	8¼
1880	747,408,600	2,235,451	7	2
1882	811,922,400	2,385,263	7	1
1884	993,608,760	2,910,493	7	0
1886	1,035,171,000	2,884,063	6	8
1888	1,126,793,000	3,083,167	6	6
1890	1,234,950,000	3,428,806	6	8
1892	1,336,730,000	3,794,718	6	10
1894	1,425,236,000	3,786,329	6	5
1896	1,589,401,000	4,184,656	6	4
1898	1,730,952,000	4,457,117	6	2
1900	2,025,820,560	5,406,141	6	5½

From such figures the conclusion might be drawn that foreign eggs were "ousting" British to a formidable extent; but such a conclusion is dispelled when we take into consideration questions of price and nationality. Imported eggs are of very different qualities and prices, France averaging for the year 1900, 7s. 7½d. per 120, Denmark 7s. 6½d., Belgium 6s. 2d., Germany 5s. 9½d. and Russia 5s. 6d., many of the latter being almost putrid when sold in England, and chiefly used in manufactures, for which, at a low price, they answer perfectly. Many eggs are sent from Russia to Germany, Belgium and even Denmark, so that some of these also come from her, at an original price with which no British producer could compete. A steady decline in imports of the higher priced French eggs, and an enormous increase of low-priced eggs, explain the drop in average price from 8s. 7d. per 120 in 1874 to 6s. 5½d. in 1900; and were this all, the inference would be simply that the selling price of eggs had fallen. But this is not so. While the higher priced foreign eggs have thus been largely displaced from the market, there has grown up a very large demand for British "new-laid" eggs, at prices much higher than any of the above. There is a wholesale market for such eggs in London. The lowest price (in May) for 1900 was 7s. 6d. to 8s. 6d., and the highest (in December) 19s. to 20s. per 120. The quantity of reputed "new-laid" British eggs now sold is enormous, and has grown up in the face of foreign imports, the native producer selling in spite of them, and at far better prices, many times more than he did, say, in 1875.

The following were the British imports of dead poultry and game for the last three years of the 19th century:—

Value of British Imports of Poultry and Game.

Year.	France.	Russia.	Belgium.	Other Countries.
	£	£	£	£
1898	217,703	164,498	127,923	127,368
1899	296,555	139,834	165,803	183,102
1900	333,148	199,282	213,603	264,327

The total for 1900 thus amounted to £1,010,360. The imports from France and Belgium are largely for the Christmas market. Those from Russia are chiefly very small fowls wrapped in paper and packed in cases of a hundred each, which come over frozen, to be sold at 1s. 2d. or 1s. 3d. each. Other sources include America, Canada and Australia, which have been sending smaller but increasing quantities of larger birds, packed in smaller numbers, and which realize 2s. 6d. to 3s. 6d. each, a few of the largest as much as 4s. each. Such supplies have somewhat affected the Sussex fattening industry, necessitating the production of a lower class of bird at a lower price and narrower margin; but they look rough and inferior in colour, and chiefly supply restaurant and hotel demand. The foreign birds being cold-storage goods, which must be consumed quickly when taken out, a fresh Sussex fowl of the same weight will always sell for considerably more.

There are no statistics of British poultry; in Ireland they are collected. The year 1851 closed a decade in which the number of holdings under ten acres had decreased enormously, and the number of poultry in Ireland was then returned as 7,470,694. In 1889 this number had doubled to 14,856,517, and in 1899 there were 18,233,520. The Irish Agricultural Organization Society is doing much to improve breeds and management, and the packing of eggs, of which Ireland is a considerable exporter to Great Britain. There is also now a considerable export of lean chickens for fattening to

Sussex and other parts of England, and a smaller number have also been fattened in Ireland.

In Australia most of the federated states have a produce export department, which receives eggs and dead poultry into cold storage and ships to London, managing, if desired, the whole business. That of South Australia shipped a good many eggs to England in 1895, but the temperature was found too low for eggs, and this trade has so far not developed. Dead poultry come in a similar way from West Australia and Victoria to London. In New South Wales such arrangements have inaugurated a small export business which seems the most active of any, and more seems known about the poultry industry in this state than in others. The government statistician estimated the number kept in 1900 at 3,180,000 fowls, 320,000 ducks, 234,000 turkeys and 97,000 geese, the annual consumption being about three-fourths of this, and of eggs about 97,000,000.

In Canada the government makes considerable effort to encourage poultry. It has established several stations where systematic fattening of chickens in the English manner is taught, and official experiments are also made on the results of various feeding-rations and other matters. From these stations shipments of fatted chickens were first made to Liverpool and London, commencing an export trade which shows signs of growth.

The poultry industry in the United States is the most gigantic in the world. By the census of 1900, which tabulates returns from 5,096,252 out of the 5,739,657 farms in the States, the number of fowls over three months old on the 1st of June 1900 was returned as 233,598,085, with 6,599,367 turkeys, 5,676,863 geese, and 4,807,358 ducks, or 250,681,673 birds in all, valued at 85,794,996 dollars. This, however, would include very few of the chickens raised that year, which would not have reached the age stated, and mainly represents breeding and laying stock, which thus averages about 49 birds to every holding; it also of necessity omits many of the smaller city-lot raisers. The value of the poultry raised during the whole year 1899 is given as 136,891,877 dollars, and of the eggs produced (1,293,819,186 dozen) at 144,286,186 dollars; a total year's product of over £56,000,000. Adding only a very moderate amount for city-lot and other small producers not making return, the poultry industry in America exceeded in value either the wheat crop, or swine or cotton crop.

The importance of poultry in France has long been recognized, being due mainly to the prevalence of moderately small holdings and the national disposition to small rural industries. The eggs exported are collected from the farmers by such a well-organized system that eggs collected on Wednesday are in the London market the following Tuesday. The home consumption of eggs is also enormous, so that when prices for foreign eggs decreased in England, the Paris market paid better. In 1900 the Paris Municipal Council reported the consumption of eggs in that city alone in the previous year as 212 per head. Eggs are imported from Italy to some extent.

The conditions in Belgium are somewhat similar to those in France. Some eggs are imported from Italy, and much of the home production is from imported Italian hens, kept laying for a year and then killed: eggs are exported chiefly to France, Great Britain and Germany. There is a fattening industry somewhat similar to that in Sussex, lean chickens being bought for fattening in certain markets. The chief export of these is to Germany, but there is some to the London market, especially in December.

In the Netherlands the number of poultry increased considerably during the last decade of the 19th century, excepting turkeys, which diminished. Taking 1900 as a typical year, there were 4,083,312 fowls, 430,022 ducks, 36,307 geese, and 13,130 turkeys; and there were about 70 special establishments for poultry-rearing, which were rather on the increase, chiefly for local requirements. Of eggs there were exported to Belgium 656,898, England 370,418 and Germany 3,212,845 kilos; but the imports were in excess of this by 2,916,269 kilos, and came chiefly from Russia. Dead fowls and ducks also go to the countries above named.

In Denmark there were in 1900 about 9,000,000 fowls, mostly local and Italian. The eggs exported numbered 332,000,000, practically all to England; there were imported 35,600,000, practically all Russian, re-exported to England. The flourishing export trade is due to a good co-operative system.

Germany is a large consumer rather than a producer of poultry products, and chiefly a carrier of her nominal exports. She imports eggs from Italy and Austria-Hungary as well as from Russia.

Austria-Hungary has a large trade in poultry and eggs. In 1900 the dual monarchy imported poultry to the value of £268,240 and eggs to the value of £1,230,655. But the exports of poultry amounted to £977,051, and of eggs to no less than £3,750,078. This country is therefore a very large producer, most of the eggs going to Germany, and some of them through her on to England.

Italy sends live fowls, for laying, to northern Europe, and eggs to Belgium and France.

In Russia the growth of the poultry industry has been very great since 1890. In that year her British trade was small: in 1900 she bulked largest of all countries in eggs sent to England direct, and some nominally from others really came from her. Her exports of eggs (reckoned as £1 = 10 roubles) were valued in 1898 at £3,113,386, and of live poultry (chiefly geese) at £637,000; but this latter sum is now exceeded by geese alone sent to Germany, as above noticed.

Her vast southern provinces are, of course, the origin of this produce, which is collected by dealers from the farmers, the price realized by the latter for eggs being in summer sometimes less than a rouble per hundred. The government has shown considerable interest in this growing industry in several ways, and produce is carried at almost incredibly low rates on the State railways; but the vast distances involved must always confine Russian produce to the supply of the cheaper class of demand in western Europe. (L. WR.)

POUNCE. (1) To drop upon and seize: properly said of a bird of prey seizing its victim in its claws. The substantive "pounce," from which the verb is formed, was the technical name in falconry for the claws on the three front toes of a hawk's claws, and so *The Book of St Albans* (1486) "Fryst the grete Clees behynde . . . ye shall call hom talons. . . The Clees within the fote ye shall call of right her Pownces." (2) To decorate metal by driving or punching a design into it from the under or back part of the surface; also to decorate cloth or other fabrics by punching or "pinking" holes, scalloping the edges, &c. Both these words seem to be variants of "punch" (*q.v.*), which comes ultimately from the Latin *pungere*, *punctum*, to prick, pierce. From them must be distinguished (3) "pounce," a preparation of powdered cuttle-fish or sandarach, the resin of the sandarach-tree, formerly used for drying ink on the roughened surface of vellum, parchment or paper where an erasure had been made; later, the word was also given to the black sand used generally as a dusting-powder for drying ink before the invention of blotting-paper. The "pounce-box" or "pouncet-box" was a familiar object on all writing-tables till that time. A similar box with pierced lid for holding perfumes or aromatic vinegar also bore the name. This word is formed from the Lat. *pumex*, pumice-stone, which was employed for securing a smooth surface on vellum, parchment, &c. The term "pounce" is also applied to a finely powdered gum of the juniper or to pipe-clay darkened with charcoal used in transferring designs to fabrics, wall-surfaces, &c., through holes pricked in the original drawing.

POUND.¹ (1) An enclosure in which cattle or other animals are retained until redeemed by the owners, or when taken in distraint until replevised, such retention being in the nature of a pledge or security to compel satisfaction for debt or damage done. Animals may be seized and impounded when (1) distrained for rent; (2) damage *feasant*, *i.e.* doing harm on the land of the person seizing; (3) straying; (4) taken under legal process. A pound belongs to the township or village or manor where it is situated. The pound-keeper is obliged to receive everything offered to his custody and is not answerable if the thing offered be illegally impounded.

By a statute of 1554, no distress of cattle can be driven out of the hundred where taken unless to a pound in the same county, within three miles of the place of seizure. This statute also fixes 4d. as the fee for impounding a distress. Where cattle are impounded the impounder is bound to supply them with sufficient food and water (Cruelty to Animals Acts 1849 and 1854); any person, moreover, is authorized to enter a place where animals are impounded without food and water more than twelve hours and supply them; and the cost of such food is to be paid by the owner of the animal before it is removed. A statute of 1690 gives treble damages and costs against persons guilty of *pound breach*; and by statute of 1843 (Pound Breach) persons releasing or attempting to release cattle impounded or damaging any pound are liable to a fine not exceeding £5, awardable to the person on whose behalf the cattle were distrained, with imprisonment with hard labour in default. In the old law books

¹ Pound, in sense (1), is represented late in O.E. by the compounds *pund-fold* and *pund-breche* and by the derivative *pyndan*, to dam up, enclose, and *for-pyndan*, to shut out. The origin is unknown; "pen," an enclosure, is from a different root; "pond" a small pool of water, is a Middle English variant of "pound." In sense (2) the O.E. and M.E. *pund*, Du. *pond*, Ger. *Pfund*, are derivatives of the Lat. indeclinable substantive *pondo*—really an ablative singular as if from *pondus* (2nd declension)—a variant of *pondus*, *ponderis*, weight. The Lat. *pondo* is used as a shortened form of *libra pondo*, pound by weight. Finally is the verb "to pound," to crush by beating, to strike or beat; this in O.E. is *punian*, the *d* being excrement as in "sound," noise. The word is rare outside English; cf. Mod. Du. *puin*, rubbish, broken stone.

varieties of pounds—as a common pound, an open pound and a close pound—are enumerated. By the Distress for Rent Act 1737 any person distraining for rent may turn any part of the premises into a pound *pro hac vice* for securing the distress. Pounds are not now much used. (F. WA.)

POUND (2)—(a) a measure of weight; (b) an English money of account. (a) The English standard unit of weight is the *avoirdupois* pound of 7000 grains. The earliest weight in the English system was the Saxon pound, subsequently known as the Tower pound, from the old mint pound kept in the Tower of London. The Tower pound weighed 5400 grains and this weight of silver was coined into 240 pence or 20 shillings, hence pound in sense (2) (a pound weight of silver). The pound troy, probably introduced from France, was in use as early as 1415 and was adopted as the legal standard for gold and silver in 1527. The act which abolished the Tower pound (18 Hen. VIII.: the "pounde Troye which exceedeth the pounde Tower in weight iii quarters of the oz.") substituted a pound of 5760 grains, at which the pound troy still remains. There was in use together with the pound troy, the merchant's pound, weighing 6750 grains, which was established about 1270 for all commodities except gold, silver and medicines, but it was generally superseded by the pound *avoirdupois* about 1330. There was also in use for a short time another merchant's pound, introduced from France and Germany; this pound weighed 7200 grains. The pound *avoirdupois* has remained in use continuously since the 14th century, although it may have varied slightly at different periods—the Elizabethan standard was probably 7002 grains. The standard pound troy, placed together with the standard yard in the custody of the clerk of the House of Commons by a resolution of the House of the 2nd of June 1758, was destroyed at the burning of the houses of parliament in 1834. In 1838 a commission was appointed to consider the restoration of the standards, and in consequence of their report in 1841 the pound *avoirdupois* of 7000 grains was substituted for the pound troy as the standard. A new standard pound *avoirdupois* was made under the direction of a committee appointed in 1834 (which reported in 1834), by comparison with authenticated copies of the original standard (see *Phil. Trans.* 1856). This standard pound was legalized by an act of 1855 (18 & 19 Vict. c. 72). The standard *avoirdupois* pound is made of platinum, in the form of a cylinder nearly 1.35 in. high and 1.15 in. in diameter. It has a groove or channel round it to enable it to be lifted by means of an ivory fork (for illustration see WEIGHTS AND MEASURES) and is marked "P.S. 1844. 1 lb." P.S. meaning Parliamentary Standard. It is preserved at the Standards Office, in the custody of the Board of Trade. Copies were also deposited at the Houses of Parliament, the Royal Mint, the Royal Observatory and with the Royal Society.

See the *Reports of the Standards Commission* (6 parts, 1868–1873), especially 3rd report (on the abolition of troy weight) and 5th report (on the business of the Standards Dept. and the condition of the official standards and apparatus; description of the re-verification of the various official standards, with diagrams).

(b) The English monetary unit is the pound; it was originally a pound *weight* of silver (hence written £ for *libra*, Lat. pound weight), coined into twenty shillings, and is now represented by the gold sovereign (*q.v.*). The pound Scots was at one time of the same value as the English pound, but through gradual debasement of the coinage was reduced at the accession of James I. to about one-twelfth of the value of the English pound, and was divided into twenty shillings, each about the value of an English penny. The Egyptian pound, written £E, is a gold coin of 100 piastres, and was made the monetary unit of the country by a decree of the 14th of November 1885. Its weight is 8.544 grammes of gold 0.875 fine and its value in English standard gold is £1, os. 6¼d. The Turkish pound is written £T. The Turkish monetary system is dealt with at length under **TURKEY: Monetary System.**

Valuable information from the historical point of view will be found in the *Reports of the Standards Commission* quoted above, and in H. W. Chisholm's *On the Science of Weighing and Measuring* (1877) and his *Seventh Annual Report* as warden of the standards;

R. Ruding, *Annals of the Coinage* (1819) and H. J. Chaney, *Our Weights and Measures* (1897).

POUSSIN, NICOLAS (1594-1665), French painter, was born at Les Andelys (Eure) in June 1594. Early sketches attracted the notice of Quentin Varin, a local painter, whose pupil Poussin became, till he went to Paris, where he entered the studio of Ferdinand Elle, a Fleming, and then of the Lorrainer L'Allemand. He found French art in a stage of transition: the old apprenticeship system was disturbed, and the academical schools destined to supplant it were not yet established; but, having met Courtois the mathematician, Poussin was fired by the study of his collection of engravings after Italian masters. After two abortive attempts to reach Rome, he fell in with the chevalier Marini at Lyons. Marini employed him on illustrations to his poems, took him into his household, and in 1624 enabled Poussin (who had been detained by commissions in Lyons and Paris) to rejoin him at Rome. There, his patron having died, Poussin fell into great distress. Falling ill he was received into the house of his compatriot Dughet and nursed by his daughter Anna Maria to whom in 1629, Poussin was married. Among his first patrons were Cardinal Barberini, for whom was painted the "Death of Germanicus" (Barberini Palace); Cardinal Omodei, for whom he produced, in 1630, the "Triumphs of Flora" (Louvre); Cardinal de Richelieu, who commissioned a Bacchanal (Louvre); Vincenzo Giustiniani, for whom was executed the "Massacre of the Innocents," of which there is a first sketch in the British Museum; Cassiano dal Pozzo, who became the owner of the first series of the "Seven Sacraments" (Belvoir Castle); and Fiéart de Chanteloup, with whom in 1640 Poussin, at the call of Sublet de Noyers, returned to France. Louis XIII. conferred on him the title of "first painter in ordinary," and in two years at Paris he produced several pictures for the royal chapels (the "Last Supper," painted for Versailles, now in the Louvre) and eight cartoons for the Gobelins, the series of the "Labours of Hercules" for the Louvre, the "Triumph of Truth" for Cardinal Richelieu (Louvre), and much minor work. In 1643, disgusted by the intrigues of Simon Vouët, Feuquières and the architect Lemercier, Poussin withdrew to Rome. There, in 1648, he finished for De Chanteloup the second series of the "Seven Sacraments" (Bridgewater Gallery), and also his noble landscape with Diogenes throwing away his Scoop (Louvre); in 1649 he painted the "Vision of St Paul" (Louvre) for the comic poet Scarron, and in 1651 the "Holy Family" (Louvre) for the duke of Créqui. Year by year he continued to produce an enormous variety of works, many of which are included in the list given by Félibien. He died on the 19th of November 1665 and was buried in the church of St Lawrence in Lucina, his wife having predeceased him.

The finest collection of Poussin's paintings as well as of his drawings is possessed by the Louvre; but, besides the pictures in the National Gallery and at Dulwich, England possesses several of his most considerable works: The "Triumph of Pan" is at Baisildon (Berkshire), and his great allegorical painting of the "Arts" at Knowsley. At Rome, in the Colonna and Valentini Palaces, are notable works by him, and one of the private apartments of Prince Doria is decorated by a great series of landscapes in distemper. Throughout his life he stood aloof from the popular movement of his native school. French art in his day was purely decorative, but in Poussin we find a survival of the impulses of the Renaissance coupled with conscious reference to classic work as the standard of excellence. In general we see his paintings at a great disadvantage, for the colour, even of the best preserved, has changed in parts, so that the keeping is disturbed; and the noble construction of his designs can be better seen in engravings than in the original. Amongst the many who have reproduced his works Audran, Claudine Stella, Picart and Pesne are the most successful.

Poussin left no children, but he adopted as his son Gaspar Dughet (Gasparo Duche), his wife's brother, who took the name of Poussin. **GASPAR POUSSIN** (1613-1675) devoted himself to landscape painting and rendered admirably the severer beauties of the Roman Campagna; a noteworthy series of works in tempera representing various sites near Rome is to be seen in the Colonna Palace; but one of his finest easel-pictures, the "Sacrifice of Abraham," formerly the property of the Colonna, is now, with other works by the same painter, in the National Gallery, London. The frescoes executed by Gaspar Poussin in S. Martino di Monti are in a bad state of preservation. The Louvre does not possess a single work by his hand. Gaspar died at Rome on the 27th of May 1675.

See Sandrart, *Acad. nob. art. pict.*; *Lettres de Nicolas Poussin* (Paris, 1824); Félibien, *Entretiens*; Gault de St Germain, *Vie de Nicolas Poussin* (1806); D'Argenville, *Abrégé de la vie des peintres*; Bouchitté, *Poussin et son œuvre* (1858); Emilia F. S. Pattison (Lady Dilke), *Documents inédits, Le Poussin, in L'Art* (1882).

POUT, also whiting-pout or bib (*Gadus luscus*), a fish of the family *Gadidae*. It is a small species abundant on the coasts of northern and western Europe, but less so in the Mediterranean. It is distinguished from other species of the genus *Gadus* by having a deep short body, with more or less distinct dark bars; a short and obtuse snout, not longer than the eye; the upper jaw the longer; and a long barbel at the chin. A black spot occupies the upper part of the base of the pectoral fin. Pout affect certain localities of limited extent, where a number may be caught with hook and line. They are excellent food, but must be eaten soon after capture. A pout of 5 lb is considered a very large specimen.

POUVILLON, ÉMILE (1840-1906), French novelist, was born at Montauban (Tarn et Garonne). He published in 1878 a collection of stories entitled *Nouvelles réalistes*. Making himself the chronicler of his native province of Quercy, he painted its scenery and its life with great clearness of outline and without exaggeration. His books include *Césette* (1881), the story of a peasant girl; *L'Innocent* (1884); *Jean-de-Jeanne* (1886); *Le Cheval bleu* (1888); *Le Vœu d'être chaste* (1900); *Chante-pleure* (1890); *Les Antibel* (1892); *Petites âmes* (1893); *Mademoiselle Clémence* (1896); *Pays et paysages* (1895); *Petites gens* (1905); *Bernadette de Lourdes* (1894), a mystery; and *Le Roi de Rome* (1898), a play. He died at Chambéry.

POVINDAH, a class of warrior nomadic traders in Afghanistan, who belong chiefly to the Nasir and Suliman Kuel tribes of Ghilzais. Their name, which designates their occupation, is derived from the same root as the Pushtu word for "to graze." They are almost wholly engaged in the carrying trade between India and Afghanistan and Central Asia. They assemble every autumn in the plains east of Ghazni, with their families, flocks, herds and long strings of camels and horses, laden with the goods of Bokhara and Kandahar; and forming caravans march through the Kakar and Waziri countries by the Zhob and Gomal passes of the Suliman hills. Entering Dera Ismail Khan district about October they leave their families and flocks, their arms and some two-thirds of their fighting men in the great grazing grounds which lie on either side of the Indus, and while some wander in search of employment, others pass on with their merchandise to the great cities of India, and even by rail as far as Calcutta, Karachi and Bombay. In the spring they again assemble, and return by the same route to their homes in the hills about Ghazni and Kalat-i-Ghilzai. When the hot season begins, the men, leaving their belongings behind them, move off again to Kandahar, Herat and Bokhara, with the Indian and European merchandise which they have brought from Hindustan. For generations the Waziris have carried on war to the knife with these merchant traders. To meet the opposition that awaited them on the road the Povindahs used to move heavily armed, in bodies of from 5000 to 10,000, and regular marches and encampments were observed under an elected khan or leader. But since the Gomal Pass was taken over by the British and opened up in 1889 there has been comparative security on the border. During the Second Afghan War the tribes on the Tank border were stirred up by emissaries from Kabul, and the Suliman Khel joined the Mahsud Waziris in their daring raid on the town of Tank in January 1879. Colonel Boisragon, who commanded at Dera Ismail Khan, moved out against the Povindah settlements in the mouth of the Gomal Pass and severely punished them. The Povindahs paid a fine of nearly Rs. 60,000 (£6000), and agreed that in future their migratory bands should be disarmed on their entry into British territory, their weapons to be deposited in a military arsenal, and returned to their owners when they again crossed the border.

POVOA DE VARZIM, a seaport of northern Portugal, in the district of Oporto; on a small and ill-sheltered bay, 18 m. N. of Oporto by the branch railway to Villa Nova de Famalicão. Pop. (1900), 12,623. In summer Povo de Varzim is the most

frequented sea-bathing resort in northern Portugal; it is also the headquarters of important sardine, hake, and sea-bream fisheries.

POWDER (through O. Fr. *poudre*, modern *poudre*, from Lat. *pulvis*, *pulveris*, dust), the small loose particles into which solid matter is disintegrated by such processes as grinding, crushing, pounding, &c., hence any preparation which takes the form of such loose uncompacted particles, the most familiar example of such preparation being that of gunpowder (*q.v.*). Many powders are found in medical uses, some of which have retained the name of their inventor, such as the compound powder of rhubarb, "Gregory powder," named after a Scottish doctor, James Gregory (1758-1822). Various preparations in form of powder are used for toilet purposes. During the period when the hair or wig was worn "powdered" or whitened, houses had a special room set apart for the process, known as the powdering-room or closet. In some birds, such as the herons, certain down-feathers or *plumulae* break off into a fine dust as fast as they are formed and form tracts defined in size and situation and known as "powder-down patches."

POWELL, FREDERICK YORK (1850-1904), English historian and scholar, was born in Bloomsbury, London, on the 14th of January 1850. Much of his childhood was spent in France and Spain, so that he early acquired a mastery of the language of both countries and an insight into the genius of the people. He was educated at Rugby School, and matriculated at Oxford as an unattached student, subsequently joining Christ Church, where he took a first-class in law and modern history in 1872. He was called to the bar at the Middle Temple in 1874, and married in the same year. He became law-lecturer and tutor of Christ Church, fellow of Oriol College, delegate of the Clarendon Press, and in 1894 he was made regius professor of modern history in succession to J. A. Froude. Although he never made any extensive contribution to history, he was a particularly stimulating teacher. He had been attracted in his school days to the study of Scandinavian history and literature, and he was closely allied with Professor Gudbrandr Vigfússon (d. 1889), whom he assisted in his *Icelandic Prose Reader* (1897), *Corpus poeticum boreale* (1887), *Origines islandicae* (1905), and in the editing of the Grimm Centenary papers (1886). He took a keen interest in the development of modern French poetry, and Verlaine, Mallarmé and Verhaeren all lectured at Oxford under his auspices. He was also a connoisseur in Japanese art. In politics his sympathies were with the oppressed of all nationalities; he had befriended refugees after the Commune, counting among his friends Jules Vallès' the author of *Les Réfractaires*; and he was also a friend of Stepniak and his circle. He died at Oxford on the 8th of May 1904.

See the *Life*, with letters and selections, by Oliver Elton (1906).

POWELL, GEORGE (c. 1658-1714), English actor and playwright, was the son of an actor of the same name (d. c. 1698), with whom, as the king of Bakam, he first appeared in 1687, as Emanuel in *The Island Princess*, Tate's version of Fletcher's play. He wrote or adapted *Alphonso, King of Naples* (1661), *Treacherous Brothers* (1676), and *Very Good Wife* (1693), and acted in them and in a long list of contemporary plays almost until his death. As a tragedian he succeeded to many of Betterton's parts, but not to his genius.

POWELL, JOHN WESLEY (1834-1902), American geologist and ethnologist, was born at Mount Morris, New York, on the 24th of March 1834. His parents were of English birth, but had moved to America in 1830, and he was educated at Illinois and Oberlin colleges. When the Civil War broke out he entered the Union Army as a private, and at the battle of Shiloh he lost his right arm. He continued, however, on active service and served as division chief of artillery before Vicksburg, reaching the rank of major of volunteers. In 1865 he was appointed professor of geology and curator of the museum in the Illinois Wesleyan University at Bloomington, and afterwards at the Normal University. In 1867 he commenced a series of expeditions to

¹ (1833-1885), member of the Commune of 1871.

the Rocky Mountains and the canyons of the Green and Colorado rivers, during the course of which (1869) he made a daring boat-journey of three months, through the Grand Canyon, the river channel not having previously been explored. In these travels he gathered much valuable information on the geology, and he also made a special study of the Indians and their languages. His able work led to the establishment under the U.S. government of the geographical and geological survey of the Rocky Mountain region with which he was occupied in 1870-1879. This survey, with those of Ferdinand Hayden (1820-1887) and Captain George M. Wheeler (b. 1842) was incorporated with the United States Geological and Geographical Survey under Clarence King (1842-1901) in 1879, when Powell became director of the Bureau of Ethnology, a department he had assisted in founding. On King's resignation in 1881, Powell was appointed director also of the Geological Survey, a post which he occupied until 1894. To him the present thorough organization of the U.S. Geological Survey is largely due.

His principal publications were *Exploration of the Colorado River of the West and its Tributaries* (1875), *Report on the Geology of the Eastern Portion of the Uinta Mountains* (1876), *Report on the Lands of the Arid Region of the United States* (1879), *Introduction to the Study of Indian Languages* (1880), *Canyons of the Colorado* (1895), *Truth and Error* (1898). Especially important were his observations on what is now termed the "Uinta type" of mountain structure: a broad, flattened anticline, from which the strata descend steeply into bordering low grounds and quickly resume their horizontality—being sometimes faulted, and affording evidence of enormous denudation. He died in Haven, Maine, on the 23rd of September 1902.

See F. S. Dellenbaugh, *Romance of the Colorado River* (New York, 1903), and *Canyon Voyage: Second Powell Expedition* (New York, 1908).

POWELL, VAVASOR (1617-1670), Welsh Nonconformist, was by birth a Radnorshire man and was educated at Jesus College, Oxford. About 1639 he entered upon the career of an itinerant preacher, and for preaching in various parts of Wales he was twice arrested in 1640; however, he was not punished and during the Civil War he preached in and around London. In 1646, when the victory of the parliamentary cause was assured, Powell returned to Wales, having received a certificate of character from the Westminster Assembly, although he had refused to be ordained by the Presbyterians. With a salary granted to him by parliament he resumed his itinerant preaching in Wales. In 1650 parliament appointed a commission "for the better propagation and preaching of the gospel in Wales," and Powell acted as one of the principal advisers of this body. For three years he was actively employed in removing from their parishes those ministers whom he regarded as incompetent. In 1653 he returned to London, and having denounced Cromwell for accepting the office of Lord Protector he was imprisoned. At the Restoration in 1660 he was arrested for preaching, and after a short period of freedom he was again seized, and he remained in prison for seven years. He was set free in 1667, but in the following year he was again a prisoner, and he was in custody when he died on the 27th of October 1670. Powell wrote several treatises and also some hymns, but his chief gifts were those of a preacher.

See *The Life and Death of Mr Vavasor Powell* (1671), attributed to Edward Bagshaw the younger; *Vavasoris Examen et Purgamen* (1654), by E. Allen and others; D. Neal, *History of the Puritans* (1822); and T. Rees, *History of Protestant Nonconformity in Wales* (1861).

POWER [WILLIAM GRATTAN] TYRONE (1797-1841), Irish actor, was born near Kilmacthomas on the 2nd of November 1797. At the age of fourteen he joined a company of strolling players, eventually getting small parts in the London theatres. On the sudden death of Charles Connor he was given his parts and was immediately recognized as the best stage Irishman of his generation, becoming a popular favourite in London, Dublin and America. He was on board the ill-fated "President" when she foundered at sea in March 1841. Power wrote and

performed several Irish plays, and published three novels and his *Impressions of America* (1836). He had married when twenty and left a widow and seven children, the oldest of whom, Sir William Tyrone Power, K.C.B. (b. 1819), became Commissary-general of the British army and was knighted in 1865.

POWER OF ATTORNEY, or **LETTER OF ATTORNEY**, is an authority under hand and seal empowering the person named therein to do some act on behalf of the principal, which otherwise could only be done by the principal himself. It is either general or special. A general power of attorney authorizes the agent to act for his principal in all matters, or in matters of a particular nature only, or in respect of a particular business. A special act of attorney authorizes the agent to represent his principal only in some particular specified act. It expires with death of the principal, and is revocable at his will, even by a verbal notice, unless it has been given for a valuable consideration. Moreover, the terms of the power are construed literally, and give such authority only as they confer expressly or by necessary implication. The Conveyancing Act of 1881 provides protection for any person making any payment or doing any act in good faith, in pursuance of a power of attorney, if before the time of the payment or act the donor of the power had died or become lunatic, of unsound mind, or bankrupt, or had revoked the power. The law relating to powers of attorney is a branch of the law of agency. (See **AGENT**; **PRINCIPAL** and **AGENT**.)

POWERS, HIRAM (1805-1873), American sculptor, the son of a farmer, was born at Woodstock, Vermont, on the 29th of June 1805. In 1819 his father removed to Ohio, about six miles from Cincinnati, where the son attended school for about a year, staying meanwhile with his brother, a lawyer in Cincinnati. After leaving school he found employment in superintending a reading-room in connexion with the chief hotel of the town, but, being, in his own words, "forced at last to leave that place as his clothes and shoes were fast leaving him," he became a clerk in a general store. His second employer in this line of business having invested his capital in a clock and organ factory, Powers set himself to master the construction of the instruments, displaying an aptitude which in a short time enabled him to become the first mechanic in the factory. In 1826 he began to frequent the studio of Mr Eckstein, and at once conceived a strong passion for the art of sculpture. His proficiency in modelling secured him the situation of general assistant and artist of the Western Museum, kept by a Frenchman named Dorfeuille, where his ingenious representation of the infernal regions to illustrate the more striking scenes in the poem of Dante met with extraordinary success. After studying thoroughly the art of modelling and casting, at the end of 1834 he went to Washington, where his remarkable gifts soon awakened general attention. In 1837 he settled in Florence, where he remained till his death. While he found it profitable to devote the greater part of his time to busts, his best efforts were bestowed on ideal work. In 1839 his statue of "Eve" excited the warm admiration of Thorwaldsen, and in 1843 he produced his celebrated "Greek Slave," which at once gave him a place among the leading sculptors of his time. Among the best known of his other ideal statues are the "Fisher Boy," "Il Penseroso," "Proserpine," "California," "America" (modelled for the Crystal Palace, Sydenham), and the "Last of his Tribe." He died on the 27th of June 1873.

See an article by T. A. Trollope in *Lippincott's Magazine* for February 1875.

POWER TRANSMISSION. The appliances connected with installations for the utilization of natural sources of energy may be classified into three groups:—

1. Prime movers, by means of which the natural form of energy is transformed into mechanical energy. To this group belong all such appliances as water turbines, steam turbines, steam engines and boilers, gas producers, gas engines, oil engines, &c.

2. Machinery of any kind which is driven by energy made available by the prime mover. To this group belong all machine

tools, textile machinery, pumping machinery, cranes—in fact every kind of machine which requires any considerable quantity of energy to drive it.

3. The appliances by means of which the energy made available by the prime mover is transmitted to the machine designed to utilise it. The term *power* is used to denote the rate at which energy is transmitted. The unit of power in common use is the horse power, and one horse power means a rate of transmission of 550 foot-pounds per second.

In many cases the prime mover is combined with the machine in such a way that the transmitting mechanism is not distinctly differentiated from either the prime mover or the machine, as in the case of the locomotive engine. In other cases the energy made available by the prime mover is distributed to a number of separate machines at a distance from the prime mover, as in the case of an engineer's workshop. In this case the transmitting mechanism by means of which the energy is distributed to the several machines has a distinct individuality. In other cases prime movers are located in places where the natural source of energy is abundant, namely, near waterfalls, or in the neighbourhood of coal-fields, and the energy made available is transmitted in bulk to factories, &c., at relatively great distances. In this case the method and mechanism of distribution become of paramount importance, since the distance between the prime mover and the places where the energy is to be utilized by machines is only limited by the efficiency of the mechanism of distribution.

Prime movers are considered in the articles **STEAM ENGINE**; **GAS ENGINE**; **OIL ENGINE**, and **HYDRAULICS**, and machines in various special articles. The methods and mechanisms of distribution or transmission alone form the subjects of the present article, and the different methods in general use readily fall into four divisions:—

- | | |
|----------------|----------------|
| 1. Mechanical. | 3. Pneumatic. |
| 2. Hydraulic. | 4. Electrical. |

I.—MECHANICAL

§ 1. *Methods.*—The mechanical transmission of power is effected in general by means of belts or ropes, by shafts or by wheel gearing and chains. Each individual method may be used separately or in combination. The problems involved in the design and arrangement of the mechanisms for the mechanical distribution of power are conveniently approached by the consideration of the way in which the mechanical energy made available by an engine is distributed to the several machines in the factory. By a belt on the fly-wheel of the prime mover the power is transmitted to the line shaft, and pulleys suitably placed along the line shaft by means of other belts transmit power, first, to small countershafts carrying fast and loose pulleys and striking gear for starting or stopping each engine at will, and then to the driving pulleys of the several machines. (See also **PULLEYS**.)

§ 2. *Quantitative Estimation of the Power Transmitted.*—In dealing with the matter quantitatively the engine crank-shaft may be taken as the starting point of the transmission, and the first motion-shaft of the machine as the end of the transmission so far as that particular machine is concerned.

Let T be the mean torque or turning effort which the engine exerts continuously on the crank shaft when it is making N revolutions per second. It is more convenient to express the revolutions per second in terms of the angular velocity ω , that is, in radians per second. The relation between these quantities is $\omega = 2\pi N$. Then the rate at which work is done by the engine crank shaft is $T\omega$ foot-pounds per second, equivalent to $T\omega/550$ horse power. This is now distributed to the several machines in varying proportions. Assuming for the sake of simplicity that the whole of the power is absorbed by one machine, let T_1 be the torque on the first motion-shaft of the machine, and let ω_1 be its angular velocity, then the rate at which the machine is absorbing energy is $T_1\omega_1$ foot-pounds per second. A certain quantity of energy is absorbed by the transmitting mechanism itself for the purpose of overcoming frictional and other resistances, otherwise the rate of absorption of energy by the machine would exactly equal the rate at which it was produced by the prime mover assuming steady conditions of working. Actually therefore $T_1\omega_1$ would be less than $T\omega$ so that

$$T_1\omega_1 = \eta T\omega, \quad (1)$$

where η is called the efficiency of the transmission. Considering now the general problem of a multiple machine transmission, if $T_1, \omega_1, T_2, \omega_2, T_3, \omega_3, \dots$ are the several torques and angular velocities of the respective first motion shafts of the machines,

$$(T_1\omega_1 + T_2\omega_2 + T_3\omega_3 + \dots) = \eta T\omega \quad (2)$$

expresses the relations which must exist at any instant of steady motion. This is not quite a complete statement of the actual conditions because some of the provided energy is always in course of being stored and unstored from instant to instant as kinetic energy in the moving parts of the mechanism. Here, η is the over-all efficiency of the distributing mechanism. We now consider the separate parts of the transmitting mechanism.

§ 3. Belts.—Let a pulley A (fig. 1) drive a pulley B by means of a leather belt, and let the direction of motion be as indicated by the arrows on the pulleys. When the pulleys are revolving uniformly, A

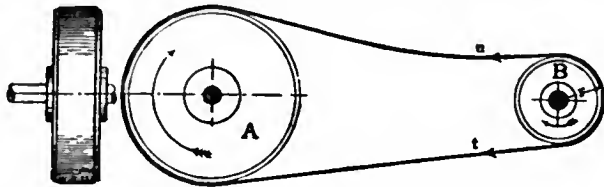

FIG. 1.

transmitting power to B, one side of the belt will be tight and the other side will be slack, but both sides will be in a state of tension. Let t and u be the respective tensions on the tight and slack side; then the torque exerted by the belt on the pulley B is $(t-u)r$, where r is the radius of the pulley in feet, and the rate at which the belt does work on the pulley is $(t-u)r\omega$ foot-pounds per second. If the horse-power required to drive the machine be represented by h.p., then

$$(t-u)r\omega = 550 \text{ h.p.}, \quad (3)$$

assuming the efficiency of the transmission to be unity. This equation contains two unknown tensions, and before either can be found another condition is necessary. This is supplied by the relation between the tensions, the arc of contact θ , in radians (fig. 2), the coefficient of friction μ between the belt and the pulley, the mass of the belt and the speed of the belt. Consider an element of the belt (fig. 2) subtending an angle $d\theta$ at the centre of the pulley, and let t be the tension on one side of the element and $(t+dt)$ the tension on the other side. The tension tending to cause the element to slide bodily round the surface of the pulley is dt . The normal pressure between the element and the face of the pulley due to the tensions is $t d\theta$, but this is diminished by the force necessary to constrain the element to move in the circular path determined by the curvature of the pulley. If W is the weight of the belt per foot, the constraining force required for this purpose is $Wv^2d\theta/g$, where v is the linear velocity of the belt in feet per second. Hence the frictional resistance of the element to sliding is $(t-Wv^2/g)\mu d\theta$, and this must be equal to the difference of tensions dt when the element is on the point of slipping, so that $(t-Wv^2/g)\mu d\theta = dt$. The solution of this equation is

$$\frac{t - Wv^2/g}{u - Wv^2/g} = e^{\mu\theta}, \quad (4)$$

where t is now the maximum tension and u the minimum tension, and e is the base of the Napierian system of logarithms, 2.718. Equations (3) and (4) supply the condition from which the power transmitted by a given belt at a given speed can be found. For ordinary work the term involving v may be neglected, so that (4) becomes

$$t/u = e^{\mu\theta}. \quad (5)$$

Equations (3) and (5) are ordinarily used for the preliminary design of a belt to calculate t , the maximum tension in the belt necessary to transmit a stated horse power at a stated speed, and then the cross section is proportioned so that the stress per square inch shall not exceed a certain safe limit determined from practice.

To facilitate the calculations in connexion with equation (5), tables are constructed giving the ratio t/u for various values of μ and θ . (See W. C. Unwin, *Machine Design*, 12th ed., p. 377.) The ratio should be calculated for the smaller pulley. If the belt is arranged as in fig. 1, that is, with the slack side uppermost, the drop of the belt tends to increase θ and hence the ratio t/u for both pulleys.

§ 4. Example of Preliminary Design of a Belt.—The following example illustrates the use of the equations for the design of a belt in the ordinary way. Find the width of a belt to transmit 20 h.p. from the flywheel of an engine to a shaft which runs at 180 revolutions per minute (equal to 18.84 radians per second), the pulley on the shaft being 3 ft. diameter. Assume the engine flywheel to be of such diameter and at such a distance from the driven pulley that the arc of contact is 120° , equal to 2.094 radians, and further assume that the coefficient of friction $\mu = 0.3$. Then from equation (5) $t/u = e^{2.094 \times 0.3} = 2.718^{0.6282}$; that is $\log t/u = 0.6282$, from which $t/u = 1.87$, and $u = t/1.87$. Using this in (3) we have $t(1-1/1.87) \cdot 1.5 \times 18.84 = 550 \times 20$, from which $t = 838$ lb. Allowing a working strength of 300 lb per square inch, the area required is 2.8 sq. in., so that if the belt is $\frac{1}{4}$ in. thick its width would be 11.2 in., or if $\frac{3}{8}$ in. thick, 15 in., approximately.

The effect of the force constraining the circular motion in diminishing the horse power transmitted may now be ascertained by calculating the horse power which a belt of the size found will actually transmit when the maximum tension t is 838 lb. A belt of the area found above would weigh about 1.4 lb. per foot. The velocity of the belt, $v = \omega r = 18.84 \times 1.5 = 28.26$ ft. per second. The term Wv^2/g therefore has the numerical value 34.7. Hence equation (2) becomes $(t-34.7)/(u-34.7) = 1.87$, from which, inserting the value 838 for t , $u = 464.5$ lb. Using this value of u in equation (1)

$$\text{H.P.} = \frac{(838 - 464.5) \times 18.84 \times 1.5}{550} = 19.15.$$

Thus with the comparatively low belt speed of 28 ft. per second the horse power is only diminished by about 5%. As the velocity increases the transmitted horse power increases, but the loss from this cause rapidly increases, and there will be one speed for every belt at which the horse power transmitted is a maximum. An increase of speed above this results in a diminution of transmitted horse power.

§ 5. Belt Velocity for Maximum Horse Power.—If the weight of a belt per foot is given, the speed at which the maximum horse power is transmitted for an assigned value of the maximum tension t can be calculated from equations (3) and (4) as follows:—

Let t be the given maximum tension with which a belt weighing W lb per foot may be worked. Then solving equation (4) for u , subtracting t from each side, and changing the signs all through: $t-u = (t-Wv^2/g)(1-e^{-\mu\theta})$. And the rate of working U , in foot-pounds per second, is

$$U = (t-u)v = (tv - Wv^3/g)(1-e^{-\mu\theta}).$$

Differentiating U with regard to v , equating to zero, and solving for v , we have $v = \sqrt{(tg/3W)}$. Utilizing the data of the previous example to illustrate this matter, $t = 838$ lb per square inch, $W = 1.4$ lb per foot, and consequently, from the above expression, $v = 80$ ft. per second approximately. A lower speed than this should be adopted, however, because the above investigation does not include the loss incurred by the continual bending of the belt round the circumference of the pulley. The loss from this cause increases with the velocity of the belt, and operates to make the velocity for maximum horse power considerably lower than that given above.

§ 6. Flexibility.—When a belt or rope is working power is absorbed in its continual bending round the pulleys, the amount depending upon the flexibility of the belt and the speed. If C is the couple required to bend the belt to the radius of the pulley, the rate at which work is done is $C\omega$ foot-pounds per second. The value of C for a given belt varies approximately inversely as the radius of the pulley, so that the loss of power from this cause will vary inversely as the radius of the pulley and directly as the speed of revolution. Hence thin flexible belts are to be preferred to thick stiff ones. Besides the loss of power in transmission due to this cause, the bending causes a stress in the belt which is to be added to the direct stress due to the tensions in the belt in order to find the maximum stress. In ordinary leather belts the bending stress is usually negligible; in ropes, however, especially wire rope, it assumes paramount importance, since it tends to overstrain the outermost strands and if these give way the life of the rope is soon determined.

§ 7. Rope Driving.—About 1856 James Combe, of Belfast, introduced the practice of transmitting power by means of ropes running in grooves turned circumferentially in the rim of



(From Abram Combe, *Proc. Inst. Mech. Eng.*)

FIG. 3.—Rope driving; half-crossed rope drive, separate rope to each groove.

the pulley (fig. 3). The ropes may be led off in groups to the different floors of the factory to pulleys keyed to the distributing shafting. A groove was adopted having an angle of about 45° .

and this is the angle now used in the practice of Messrs Combe, Barbour and Combe, of Belfast. A section of the rim of a rope driving wheel showing the shape of the groove for a rope 1 3/4 in. diameter is shown in fig. 4, and a rope driving pulley designed for six 1 3/4 in. ropes is shown in fig. 5. A rope is less flexible than a belt, and therefore care must be taken not to arrange rope drives with pulleys having too small a diameter relatively to the diameter of the rope. The principles of §§ 3, 4, 5 and 6, apply equally to ropes, but with the practical modification that the working stress in the rope is a much smaller fraction of the ultimate strength than in the

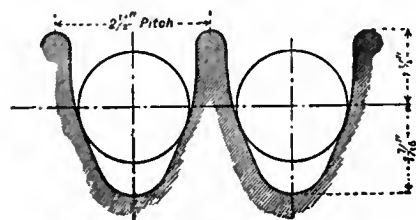

FIG. 4.

of §§ 3, 4, 5 and 6, apply equally to ropes, but with the practical modification that the working stress in the rope is a much smaller fraction of the ultimate strength than in the

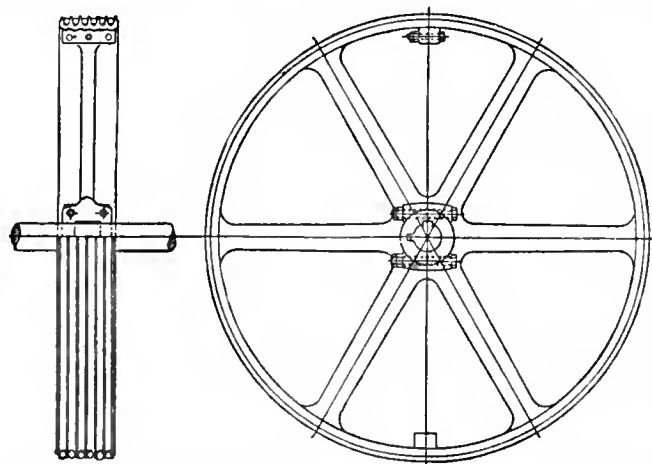

FIG. 5.—Rope Pulley, 10 ft. diam., 6 grooves, 2 1/2 in. pitch, weight about 35 cwt. Constructed by Combe, Barbour & Combe, Ltd., Belfast.

case of belting and the ratio of the tensions is much greater. The following table, based upon the experience of Messrs Combe, presents the practical possibilities in a convenient form:—

Diameter of Rope.	Smallest diameter of Pulley, which should be used with the Rope.	H.P. per Rope for smallest Pulley at 100 revs. per minute.
3/4 in.	14	5/8
1 in.	21	1
1 1/8 in.	42	8
2 in.	66	16

The speed originally adopted for the rope was 55 ft. per second. This speed has been exceeded, but, as indicated above, for any particular case there is one speed at which the maximum horse power is transmitted, and this speed is chosen with due regard to the effect of centrifugal tension and the loss due to the continual bending of the rope round the pulley. Instead of using one rope for each groove, a single continuous rope may be used, driving from one common pulley several shafts at different speeds. For further information see Abram Combe, *Proc. Inst. Mech. Eng.* (July 1896). Experiments to compare the efficiencies of rope and belt driving were carried out at Lille in 1894 by the *Société Industrielle du Nord de la France*, for an account of which see D. S. Capper, *Proc. Inst. Mech. Eng.* (October 1896). Cotton ropes are used extensively for transmitting power in factories, and though more expensive than Manila ropes, are more durable when worked under suitable conditions.

§ 8. *Shafts*.—When a shaft transmits power from a prime mover to a machine, every section of it sustains a turning couple

or torque T, and if ω is the angular velocity of rotation in radians per second, the rate of transmission is $T\omega$ foot-pounds per second, and the relation between the horse power, torque and angular velocity is

$$T\omega = 550 \text{ H.P.} \tag{6}$$

The problem involved in the design of a shaft is so to proportion the size that the stress produced by the torque shall not exceed a certain limit, or that the relative angular displacement of two sections at right angles to the axis of the shaft at a given distance apart shall not exceed a certain angle, the particular features of the problem determining which condition shall operate in fixing the size. At a section of a solid round shaft where the diameter is D inches, the torque T inch-pounds, and the maximum shearing stress f pounds per square inch, the relation between the quantities is given by

$$T = \pi D^3 f / 16, \tag{7}$$

and the relation between the torque T, the diameter D, the relative angular displacement θ of two sections L inches apart by

$$T = C\theta\pi D^4 / 32L, \tag{8}$$

where C is the modulus of rigidity for the material of the shaft. Observe that θ is here measured in radians. The ordinary problems of shaft transmission by solid round shafts subject to a uniform torque only can be solved by means of these equations.

Calculate the horse power which a shaft 4 in. diameter can transmit, revolving 120 times per minute (12.56 radians per second), when the maximum shearing stress f is limited to 11,000 lb per square inch. From equation (7) the maximum torque which may be applied to the shaft is $T = 138,400$ inch-pounds. From

$$(6) \text{ H.P.} = \frac{138,400 \times 12.56}{12 \times 550} = 264. \tag{9}$$

The example may be continued to find how much the shaft will twist in a length of 10 ft. Substituting the value of the torque in inch-pounds in equation (8), and taking 11,500,000 for the value of C,

$$\theta = \frac{138,400 \times 120 \times 32}{11,500,000 \times 3.14 \times 256} = 0.057 \text{ radians,}$$

and this is equivalent to 3.3° .

In the case of hollow round shafts where D is the external diameter and d the internal diameter equation (7) becomes

$$T = \pi f (D^4 - d^4) / 16D, \tag{10}$$

and equation (8) becomes

$$T = C\theta\pi (D^4 - d^4) / 32L. \tag{11}$$

The assumption tacitly made hitherto that the torque T remains constant is rarely true in practice; it usually varies from instant to instant, often in a periodic manner, and an appropriate value of f must be taken to suit any particular case. Again it rarely happens that a shaft sustains a torque only. There is usually a bending moment associated with it. For a discussion of the proper values of f, to suit cases where the stress is variable, and the way a bending moment of known amount may be combined with a known torque, see *STRENGTH OF MATERIALS*. It is sufficient to state here that if M is the bending moment in inch-pounds, and T the torque in inch-pounds, the magnitude of the greatest direct stress in the shaft due to the effect of the torque and twisting moment acting together is the same as would be produced by the application of a torque of

$$M + \sqrt{(T^2 + M^2)} \text{ inch-pounds.} \tag{11}$$

It will be readily understood that in designing a shaft for the distribution of power to a factory where power is taken off at different places along the shaft, the diameter of the shaft near the engine must be proportioned to transmit the total power transmitted whilst the parts of the shaft more remote from the engine are made smaller, since the power transmitted there is smaller.

§ 9. *Gearing Pitch Chains*.—Gearing is used to transmit power from one shaft to another. The shafts may be parallel; or inclined to one another, so that if produced they would meet in a point; or inclined to one another so that if produced they would not meet in a point. In the first case the gear wheels are called spur wheels, sometimes cog wheels; in the second case bevel wheels, or, if the angle between the shafts is 90° , mitre wheels; and in the third case they are called skew bevels. In all cases the teeth should be so shaped that the velocity ratio between the shafts remains

constant, although in very rare cases gearing is designed to work with a variable velocity ratio as part of some special machines. For the principles governing the shape of the teeth to fulfil the condition that the velocity ratio between the wheels shall be constant, see *MECHANICS*, § *Applied*. The size of the teeth is determined by the torque the gearing is required to transmit.

Pitch chains are closely allied to gearing; a familiar example is in the driving chain of a bicycle. Pitch chains are used to a limited extent as a substitute for belts, and the teeth of the chains and the teeth of the wheels with which they work are shaped on the same principles as those governing the design of the teeth of wheels.

If a pair of wheels is required to transmit a certain maximum horse power, the angular velocity of the shaft being ω , the pressure P which the teeth must be designed to sustain at the pitch circle is $550 \text{ H.P.}/\omega R$, where R is the radius of the pitch circle of the wheel, whose angular velocity is ω .

§ 10. *Velocity Ratio*.—In the case of transmission either by belts, ropes, shafts or gearing, the operating principle is that the rate of working is constant, assuming that the efficiency of the transmission is unity, and that the product $T\omega$ is therefore constant, whether the shafts are connected by ropes or gearing. Considering therefore two shafts, $T_1\omega_1 = T_2\omega_2$; that is $\omega_1/\omega_2 = T_2/T_1$; i.e. the angular velocity ratio is inversely as the torque ratio. Hence the higher the speed at which a shaft runs, the smaller the torque for the transmission of a given horse power, and the smaller the tension on the belts or ropes for the transmission of a given horse power.

§ 11. *Long Distance Transmission of Power*.—C. F. Hirn originated the transmission of power by means of wire ropes at Colmar in Alsace in 1850. Such a telodynamic transmission consists of a series of wire ropes running on wheels or pulleys supported on piers at spans varying from 300 to 500 ft. between the prime mover and the place where the power is utilized. The slack of the ropes is supported in some cases on guide pulleys distributed between the main piers. In this way 300 h.p. was transmitted over a distance of 6500 ft. at Freiberg by means of a series of wire ropes running at 62 ft. per second on pulleys 177 in. diameter. The individual ropes of the series, each transmitting 300 h.p., were each 1.08 in. diameter and contained 10 strands of 9 wires per strand, the wires being each 0.072 in. diameter. Similar installations existed at Schaffhausen, Oberursel, Bellegarde, Tortona and Zürich. For particulars of these transmissions with full details see W. C. Unwin's Howard Lectures on the "Development and Transmission of Power from Central Stations" (*Journ. Soc. Arts*, 1893, published in book form 1894). The system of telodynamic transmission would no doubt have developed to a much greater extent than it has done but for the advent of electrical transmission, which made practicable the transmission of power to distances utterly beyond the possibilities of any mechanical system.

See W. J. M. Rankine, *Treatise on Machinery and Millwork*; and W. C. Unwin, *Elements of Machine Design*; and for telodynamic transmission see F. Reuleaux, *Die Konstrukteur*. (W. E. D.)

II.—HYDRAULIC

The first proposal for a general transmission of hydraulic power was made by Bramah in 1802. In 1846 Lord Armstrong's hydraulic crane was erected at Newcastle, and was worked from the town water mains, but the pressure in such mains was too low and uncertain to secure satisfactory results. The invention of the accumulator in 1850 enabled much higher pressures to be used; since then 700 lb per square inch has been adopted in most private hydraulic power transmission plants. An attempt to give a public supply of hydraulic power was made in 1859, when a company was formed for laying mains in London along the river Thames between the Tower and Blackfriars, the engineer being Sir George Bruce; but though an act of parliament was obtained, the works were not carried out. The first public hydraulic supply station was established at Hull in 1877. In 1883 the General Hydraulic Power Works, Messrs Ellington and Woodall being the engineers, were started in London, and they now form the largest system of hydraulic power transmission in existence. Works of a similar character have since been established in several other towns. The general features of

hydraulic power transmissions are: (1) a central station where the hydraulic pressure is created, usually by means of steam pumping engines; (2) a system of distribution mains; (3) machines for utilizing the pressure. In cases of public supplies there is the further important matter of registration.

When dealing with any practical problem of hydraulic power transmission it is of the first importance to determine the maximum demand for power, its duration and frequency. If the duration of the maximum demand is limited and the frequency restricted—for instance, when a swing bridge has to be opened and closed only a few times in the course of a day—a small pumping plant and a large accumulator will be desirable. If the maximum demand is more or less continuous, as when hydraulic pressure is used for working a pump in a mine or a hydraulic engine in a workshop, the central station pumping engine must be capable of supplying the maximum demand without the aid of an accumulator, which may or may not, according to circumstances, be provided to serve as a regulator. A hydraulic accumulator (fig. 1) ordinarily consists of a hydraulic cylinder

Central
Station.

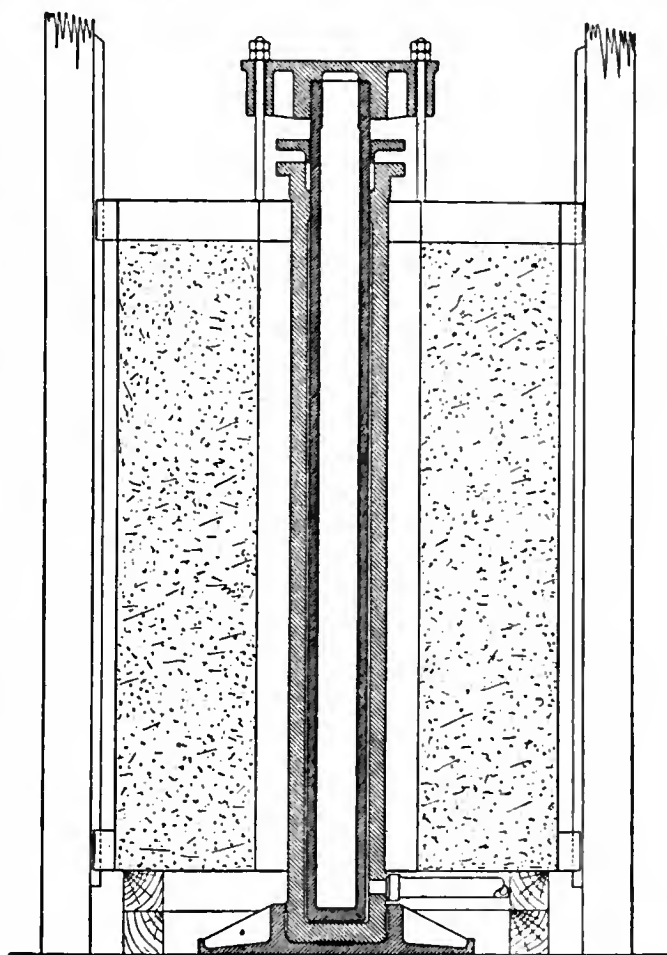

FIG. 1.

and ram, the ram being loaded with sufficient weight to give the pressure required in the hydraulic mains. If a pressure of 700 lb per square inch is wanted, the weight of the ram and its load, neglecting friction, must be 700 lb for each square inch of its area, and if the cylinder is full, i.e. the ram elevated to its full extent, the accumulator is a reservoir of power, exactly as if it were a tank at the same cubical extent placed at an elevation of about 1600 ft. above the mains and connected with them. The function of accumulators in hydraulic power distribution is frequently misunderstood, and it has been urged that as in practice the size of the reservoirs of power that can be obtained by their use is small, they are of little value. An accumulator having a ram 20 in. diameter by 20 ft. stroke loaded to 700 lb is

a fairly large one, but it contains only 439,740 foot-pounds of available energy. If the accumulator ram descended in one minute the horse power developed during that time would be 13.3, and until again pumped up its function would cease. Is so small a reservoir worth much? The correct answer to this question depends upon the surrounding circumstances. In the case of any general system of hydraulic power transmission it is certain that there will be very large and frequent variations in the combined demand for power, the periods of approximate maximum rarely exceeding in the aggregate 2 or 3 hours a day (see fig. 2). Where the area of supply is very extensive there are further subsidiary variations in small sections of the area. The main features of the combined load curves are fairly constant, but the local peaks are very erratic. Such conditions are favourable to the extensive use of accumulators.

When comparing the economy of hydraulic machinery which works intermittently, such as cranes and hoists, with other systems the effect of the hydraulic accumulator in reducing the maximum horse power required is often neglected. In consequence the comparison is vitiated, because the minimum cost of running a central station depends to a great extent upon the

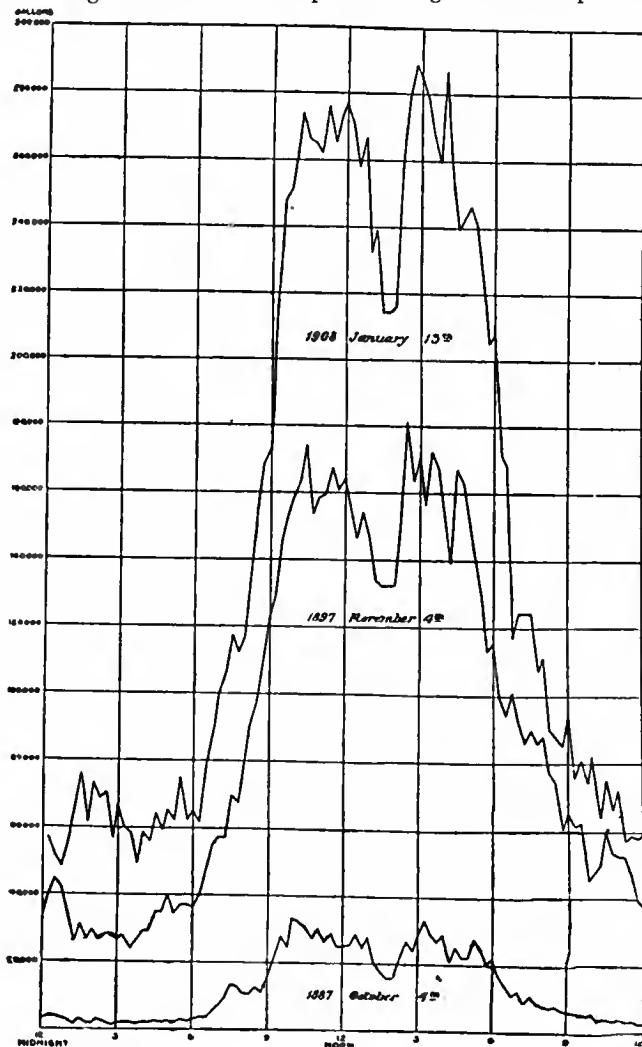

FIG. 2.

maximum demand, even though the maximum may be required only during a few minutes of the day. In the hydraulic system accumulators at the central stations perform the two distinct functions of reducing the maximum load on the pumps which supply the demand, and regulating automatically the speed of the pumps as the demand varies from minute to minute. In any large system where a number of pumping units are required they also allow a sufficient interval of time to start any additional units. Accumulators connected to the mains at a considerable distance from the central station reduce the variations

of pressure, and the size of mains required for a given supply of power, and therefore have a most important influence on the economy of distribution. The mechanical efficiency of hydraulic accumulators is very high, being from 95% to 98%, and they are practically indestructible.

When designing central stations the aim should be to employ pumping engines of such capacity that they can be worked as nearly as possible continuously at about their maximum output; the same consideration should, in the main, determine the size of the pumping units in a station where more than a single unit is employed. With a number of units, each can be worked, when in use, at or near the most economical speed. Moreover, reserve plant is necessary if the supply of power is to be constant, and where the units are many the actual reserve required is less than where the units are few.

An effect of the multiplication of power units is to increase the capital outlay; indeed, it may be stated quite generally that economy in working and maintenance cannot be obtained without a larger capital outlay than would be required for a simpler and less economical plant. A high degree of economy estimated on financial data—the ultimate base on which these practical questions rest—can only be obtained in large installations where the averaging effect of the combination of a large number of comparatively small intermittent demands for power is greatest. The term *load-factor*, since it was first coined by Colonel R. E. Crompton in 1891, has come into common use as an expression of the relation between the average and the maximum output from any central source of supply. No argument is required to show that a given central station plant working continuously at its maximum speed day and night all the year round, say for 8760 hours in a year, should produce the power more cheaply per unit, not only as to the actual running cost, but also as to the capital or interest charges, than the same plant running on the average at the same speed for, say, one-third the time, or 2920 hours. In this case the load-factor $2920/8760 = .333$, or 33.370%. The saving on the whole expenditure per unit is not in direct proportion to an increase in the load-factor, and its effect on the various items of expenditure is extremely variable. The influence is greatest on the capital charges, and it has no influence at all, or may even have a detrimental effect, on some items; for instance, the cost of repairs per unit of output may be increased by a high load-factor. Its effect on the coal consumption depends very much on the kind and capacity of the boilers in use; on whether the engines are condensing or non-condensing; on the hours of work of the engine staff, &c. The economic value of the load-factor is of great importance in every installation, but its influence on the cost of supply varies at each central station, and must be separately determined. There is a load-factor peculiar to each use for which the power is supplied, and the whole load-factor can only be improved by the combination of different classes of demands, which differ in regard to the time of day or season at which they attain their maximum. It is in this respect that the great economy of a public distribution of power is most apparent, though there is also, of course, a direct economy due simply to the presumably large size of the central stations of a public supply. Demands for power of every kind have unfortunately a tendency to arise at the same time, so that in the absence of storage of power there seems no prospect of the load-factors for general supply of power in towns exceeding, in the most favourable conditions, 40%. The load-factor of most public hydraulic power supplies is considerably under 30%. It is questionable, however, whether a very high load-factor conduces to economy of working expenses as a whole in any general supply of energy. The more continuous the supply during the twenty-four hours of the day the greater is the difficulty of executing repairs, and the greater the amount of the reserve plant required.

In all central station work where fluctuating loads have to be dealt with it is most important that there should be ample boiler power. In a comprehensive system of power supply demand arises in a very sudden and erratic manner, and to meet this by forcing the boilers involves greater waste of coal than keeping steam up in sufficient reserve boilers. For this purpose boilers with large water capacity, such as the Lancashire, are preferable to the tubular type, if sufficient space is available. Superheated steam and also thermal storage are advantageous. Feed water heaters or economizers should always be used, all steam and feed pipes should be carefully protected from radiation, and the pipe flanges should be covered; in short, to secure good results in coal consumption every care must be taken to minimise the stand-by losses which are such serious items in central station economy when the load-factor is low. Though hydraulic power has the peculiar advantage, as regards coal consumption, that it is the speed of the engines which varies with an intermittent demand, nevertheless at the London stations it has been found that during a year's working only from 60 to 75% of the coal efficiency of trial runs of the engines can be obtained—i.e. at least 25% of the coal is wasted through the stand-by losses and through the pumping engines having to run at less than full power.

To determine the scale on which a central station plant should be designed is frequently a difficult matter. The rate of growth of the expected demand for the power is an important factor, but it has been clearly established that the reduction of working expenses resulting from the increase of size of an undertaking proceeds in a diminishing ratio. Increase in output is in fact sometimes accompanied by more than a proportionate increase of expenses. During recent years there have been causes at work which have raised considerably the price of labour, fuel, other items of expense, and the law of the "diminishing ratio" has been masked.

On the diagram (fig. 3) of the costs of the London undertaking and the amount of power supplied, have been plotted points marking the total expenses of each year in relation to the output of power. These points for the years 1884-1899, and for output of from 50 to 700 million gallons followed approximately a straight line. Since 1899, however, though the output has increased from 708 millions to 1,040 million gallons, the costs per unit of output have been always considerably above the preceding periods. The details of the London supply given in table 1 partly explain this by the relatively high price of fuel, but an equally important factor has been the rise in the local rates, which in the period 1899-1909 have risen from 2d. up to 3d. per 1000 gallons. If the cost of fuel, rates and wages had remained constant the plotting of expenses in relation to output would have been approximately along the extension of the line AB. This line cuts the vertical axis at A above the origin O, and the line OA indicates the minimum amount of the expenses, and by implication the initial size of the first central station erected in London. The curve in this diagram gives the cost per 1000 gallons.

Whether it is more economical to have several smaller stations in any particular system of power transmission, or a single centre of supply, is mainly governed by the cost of the mains and the facilities for laying them in the area served. No general rule can, however, be formulated, for it is a question of balance of advantages, and the

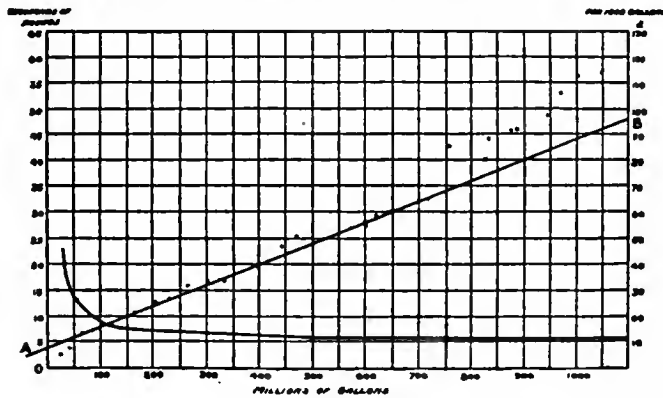

FIG. 3.

solution must be obtained by consideration of the special circumstances of each case. It has been found desirable as the demand for the power and the area within which it is supplied has enlarged, not only to increase the number of central stations but also their capacity. The first pumping station erected was installed with 4 pumping engines of 200 h.p. each. The pumping capacity of this station has been increased to 7 units. The station at Rotherhithe completed in 1904 has 8 units together 1600 h.p., and the plant at the new station at Grosvenor Road has 8 units equalling 2400 h.p. The pumping stations are situated about 3 m. apart and concurrently with the increase in their size it has been found desirable to introduce a system of feeder mains (see below).

There are in all five central stations at work in connexion with the public supply of hydraulic power in London, having an aggregate of 7000 i.h.p. All the stations and mains are connected together and worked as one system. There are 14 accumulators with a total capacity of 4000 gallons, most of them having rams 20 in. diameter by 23 ft. stroke. The pumping engines are able together to deliver 11,000 gallons per minute. Details of the London supply are given in fig. 3 and in table 1.

TABLE I.

Year.	Gallons Pumped.	Annual Load-factors.	Maximum 24 hours Load-factors.	Cost of Fuel per 1000 gallons.	Price of Fuel per ton in Bunkers.	Number of Machines at work.	Miles of Mains.
1880	163,883,000	0.328	0.524	3.11	10 9	1022	38
1894	400,316,000	0.338	0.553	1.96	10 0	2204	73
1898	620,662,000	0.340	0.483	1.98	11 3	3515	109
1903	888,925,000	0.361	0.491	2.7	14 3 ¹ / ₂	5337	146
1909	1,027,147,000	0.354	0.495	2.78	15 1	6504	168

The load-factors are calculated on the actual recorded maximum output, and not on the estimated capacity of the plant running or installed. The daily periods of maximum output are shown in fig. 2. The table shows that the load-factors have not been much affected either by the increase of the area of supply or by the increased consumption of power. The coal used has been principally Durham small. The capital cost of the London undertaking has been about £950,000. In the central station at Wapping, erected in 1891, there are six sets of triple-expansion, surface-condensing vertical pumping engines of 200 i.h.p. each; six boilers with a working pressure of 150 lb per square inch, and two accumulators with rams 20 in. diameter by 23 ft. stroke loaded up to 800 lb per square inch. The engines run at a maximum piston speed of 250 ft. per minute, and the pumps are single-acting, driven directly from the piston rods. The supply given from this station in 1909 was approximately 6,800,000 gallons per week, and the cost for fuel, wages, superintendence, lighting, repairs and sundry station expenses 4.28d. per 1000 gallons, the value of the coal used being 14s. 11-3d. per ton in bunkers. The capital cost of the station, including the land, was £70,000. The load-factor at this station for 1909 was .49, and the supply was maintained for 168 hours per week. The conditions are exceptionally favourable, and the figures represent the best result that has hitherto been obtained in hydraulic power central station work, having regard to the high price of fuel.

The installation in Hull differs little from the numerous private plants at work on the docks and railways of the United Kingdom. The value of the experiment was chiefly commercial, and the large public hydraulic power works established since are to be directly attributed to the Hull undertaking. In Birmingham gas engines are employed to drive the pumps. In Liverpool there are two central stations. The working pressure is 850 lb per square inch. There are 27 m. of mains, and about 1100 machines at work. In Manchester and Glasgow the pressure adopted is 1100 lb per square inch. In Manchester this pressure was selected principally in view of the large number of hydraulic packing presses used in the city, and the result has been altogether satisfactory. The works were established by the corporation in 1894, the central station being designed for 1200 i.h.p. Another station has since been built of equal capacity, and nearly 5 million gallons per week are being supplied to work about 2100 machines. Twenty-three miles of mains are laid.

In Antwerp a regular system of high-pressure hydraulic power transmission was established in 1894 specially to provide electric light for the city. The scheme was due to von Rysseburgh, an electrical engineer of Ghent, who came to the conclusion that the most economical way of installing the electric light was to have a central hydraulic station, and from it transmit the power through pipes to various sub-stations in the town, where it could be converted by means of turbines and dynamos into electric energy. The coal cost of the electricity supplied—0.88d. per kw. hour—compares favourably with most central electric supply stations, although the efficiency of the turbines and dynamos used for the conversion does not exceed 40%. Von Rysseburgh argued that hydraulic pumping engines would be more economical than steam-engines and dynamos, and that the loss in transmission from the central station to the consumer would be less with hydraulic converters than if the current were distributed directly. The loss in conversion, however, proved to be twice as great as had been anticipated, owing largely to defective apparatus and to under-estimation of the expense of maintaining the converting stations; and the net result was commercially unsatisfactory.

At Buenos Aires hydraulic mains are laid in the streets solely for drainage purposes. Each of the sumps, which are provided at intervals, contains two hydraulic pumps which automatically pump the sewage from a small section of the town into an outfall sewer at a higher level. The districts where this system is at work lie below the general drainage level of Buenos Aires. The average efficiency (pump h.p. to i.h.p.) is 41%, which is high, having regard to the low heads against which the pumps work. In this application all the conditions are favourable to hydraulic power transmission. The work is intermittent, there is direct action of the hydraulic pressure in the machines, and the load at each stroke of the pumps is constant. The same system has been adopted for the drainage of Woking and district, and a somewhat similar installation is in use at Margate.

Hydraulic power is supplied from the hydraulic mains on a sliding scale according to the quantity consumed. The minimum charge in London except for very large quantities is 1s. 6d. per 1000 gallons. In 1000 gallons at 750 lb per square inch there is an energy of $10,000 \times 1730 = 8.74$ h.p. hours; thus 1s. 6d. per 1000 gallons = 2d. 33,000 x 60 per h.p. hour nearly. This amount is made up approximately of 9d. per 1000 gallons for the cost of generation, distribution and general expenses including rates and 9d. for capital charges. The average rate charged to consumers in 1908 was about 2s. 4d. per 1000 gallons. Even under the most favourable circumstances it does not appear probable that hydraulic power at 750 lb per square inch can be supplied from central stations in towns on a commercial basis over any considerable areas at less than 1s. per 1000 gallons. Allowing

75% as the efficiency of the motor through which the power is utilized, this rate would give 1.83d. per brake or effective h.p. hour. This cost seems high, and it is difficult to believe that it is the best hydraulic power transmission can accomplish having regard to the well-established fact that the mechanical efficiency of a steam pumping engine is greater than any other application of a steam-engine, and that the power can be conveyed through mains without any material loss for considerable distances. Still, no other system of power transmission except gas seems to be better off, and there is no method of transmission by which energy could, at the present time, be supplied retail in towns with commercial success at such an average rate when steam is employed as the prime mover. The average rate charged for hydraulic power in London and elsewhere

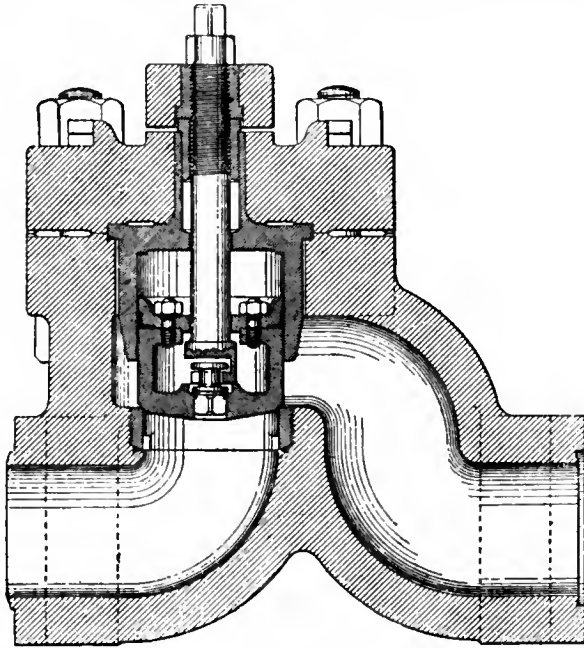

FIG. 4.

is much the same as the average rate charged for the supply of electrical energy to the ordinary consumer. Gas is undoubtedly cheaper, but in a large number of cases is mechanically inconvenient in its application. Hydraulic pressure, electrical energy and compressed air (with reheating) can all be transmitted throughout towns with approximately the same losses and at the same cost, because the power is obtained in each system from coal, boilers, and steam-engines, and the actual loss in transmission can be kept down to a small percentage. The use of any particular system of power does not, however, primarily depend upon the cost of running the central station and distributing the power, but mainly upon the mechanical convenience of the system for the purpose to which it is applied. One form of energy is, in practice, found most useful for one purpose, another form for another and no one can command the whole field.

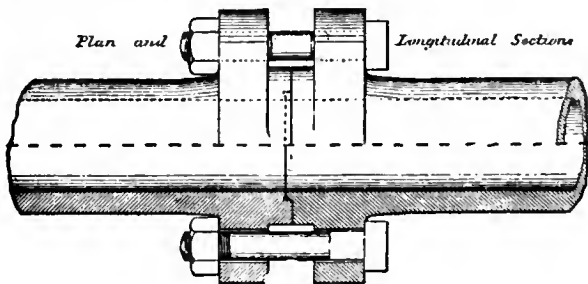

FIG. 5.

When water is employed as the fluid in hydraulic transmission the effects of frost must usually be provided against. In London and other towns, the water, before being pumped into the mains, is passed through the surface condensers of the engines, so as to raise its temperature. The mains are laid 3 ft. below the surface of the ground. Exposed pipes and cylinders are clothed, and means provided for draining them when out of use. When these simple precautions are adopted damage from frost is very rare. In special cases oil having a low freezing point is used, and in small plants good results have been obtained by mixing glycerin and methylated spirit with the water.

A few gas jets judiciously distributed are of value where there is a difficulty in properly protecting the machinery by clothing.

From the central station the hydraulic power must be transmitted through a system of mains to the various points at which it is to be used. In laying out a network of mains it is first necessary to determine what velocity of flow can be allowed. **Distribution.** Owing to the weight of water, the medium usually employed for hydraulic transmission, a low velocity is necessary in order to avoid shocks. The loss of pressure due to the velocity is

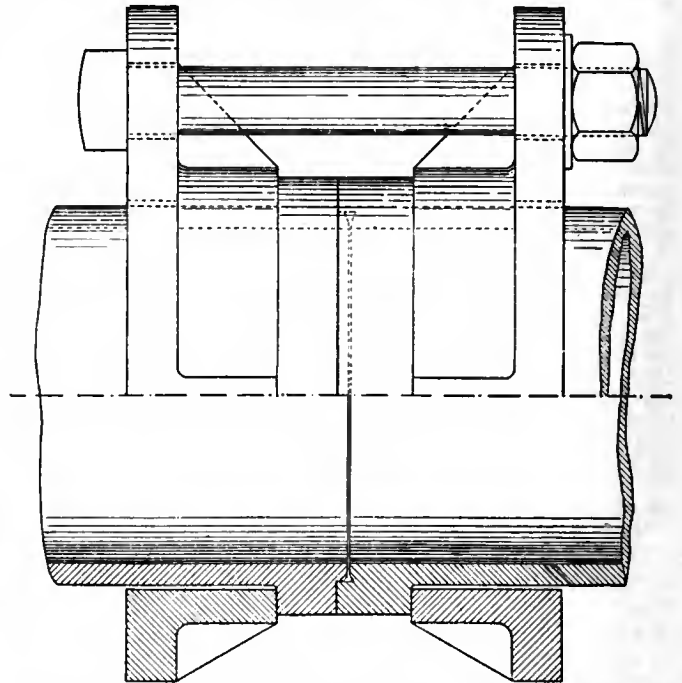

FIG. 6.—Half section and elevation at AB. Detail of 10" steel pipe. independent of the actual pressure employed, and at moderate velocities of 3 to 4 ft. per second the loss per 1000 yds. is almost a negligible quantity at a pressure of 700 lb per square inch. For practical purposes Box's formula is sufficiently accurate—

$$\text{Loss of head} = \frac{\text{gallons}^2 \times \text{length in yards}}{(\text{diameter of pipes in inches} \times 3)^5}$$

There is a further loss due to obstruction caused by valves and bends, but it has been found in London that a pressure of 750 lb at the central accumulators is sufficient to ensure a pressure of 700 lb throughout the system. The greatest distance the power is conveyed from the central stations in London is about 4 m. The higher the initial velocity the more variable the pressure; and in order to avoid this variation in any large system of mains it is usual to place additional accumulators at a

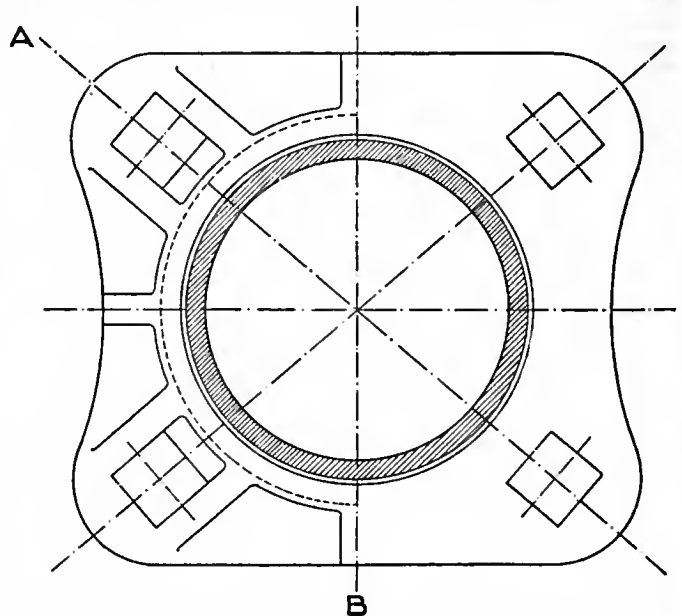

FIG. 6.—Half back elevation, half front elevation. Detail of 10" steel pipe.

distance from the central station. They act in the same way as air-vessels. The mains should be laid in circuit, and valves placed at intervals, so that any section can be isolated for repairs or for

making connexions without affecting the supply at other points. The main valves adopted in London are shown in fig. 4. Valves are also fixed to control all branch pipes, while relief valves, washouts and air valves are fixed as required.

The largest pipes used in London are 10 in. internal diameter, and the smallest laid in the streets are 2 in. The pipes from 8 in. and below are usually made in cast iron, flanged and provided with spigots and faucets. The joint (fig. 5) is made with a gutta-percha ring, though sometimes asbestos and leather packing rings are used. Cast iron pipes for hydraulic power transmission have been standardized by the Engineering Standards Committee. Fig. 6 shows the 10 in. steel main as used in London. The main was laid in 1903 from the Rotherhithe Pumping Station of the London Hydraulic Power Company through the Tower Subway, and is used as a feeder main for supply to the City. It is the first instance of the use of feeder mains in hydraulic transmission. The velocity of flow is 6 ft. per second, and is automatically disconnected from the general system should the pressure in this main fall below that of accumulator pressure. Other mains, similarly controlled, are now in use. Ellington's system of hydraulic feeder mains has been developed by the laying of a 6-in. steel main from the Falcon Wharf Station at Blackfriars to the Strand, over Waterloo Bridge.

The Falcon Wharf Pumping Station at Blackfriars was the original central station in London, and the accumulators there are loaded to 750 lb per square inch. The other pumping stations are situated about 3 m. from Falcon Wharf and about the same distance from each other. The accumulator pressure at the outlying stations is during the busy time of the day maintained at about 800 lb per square inch. Consequently the smaller variations in demand for power throughout the system caused very intermittent running of the plant at Falcon Wharf, and the load-factor there is very low. The pumping plant has now been considerably increased, and part of the plant is constructed to pump into the feeder main at pressures of 800, 900, or 1000 lb per square inch according to the demand existing from hour to hour in the Strand district. By this means the output from Falcon Wharf has been doubled with a much improved load-factor. The accumulator in this system is of special construction (fig. 7). The pressure 750 lb per square inch is maintained in the cylinder A from the ordinary hydraulic supply main. The working ram B forms the cylinder for the fixed hollow ram C which is connected to the 6 in. bore feeder main D. The balancing rams E, E attached to the fixed head F serve the purpose of adjusting the pressure in the feeder main from 800 to 1000 lb per square inch according to the quantity of pressure water required to be transmitted through it. The higher pressure is required when the velocity in this main is 10 ft. per second. There is an automatic control valve at the junction of the feeder main with the service mains in the Strand, adjusted so that the same effect is produced as if a pumping station were in operation at that point of equal capacity to the maximum flow through the 6 in. main. The length of the feeder main in this case is 2000 yds., and at 10 ft. per second there is a loss of pressure of 240 lb per square

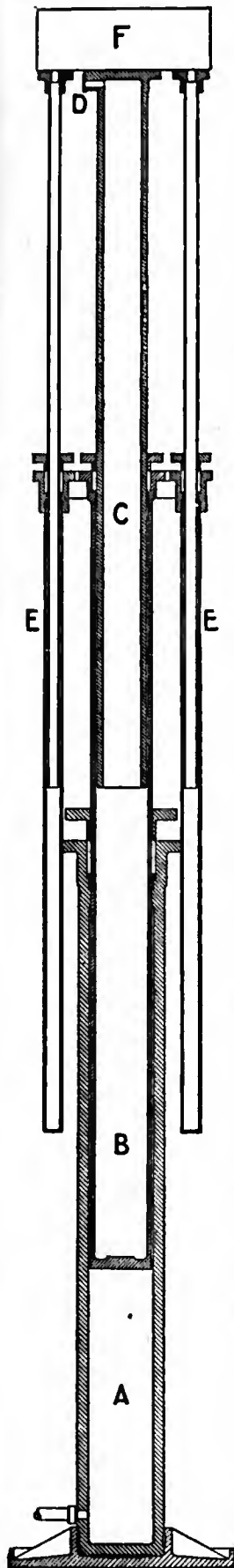

FIG. 7.

inch, but the effect on the coal consumption is almost negligible, as the maximum flow is seldom needed. The engines are specially constructed to take the pressure overload. The feeder main is made of steel. The economical limit of the use of feeder mains is reached when the additional running expenses involved equal the annual value of the saving effected in the capital expenditure.

In public supplies the power used is in all cases registered by meters, and since 1887 automatic instruments have been used at the central stations to record the amount supplied at each instant during the day and night. The ratio between the power registered at the consumers' machines and the power sent into the mains is the commercial efficiency of the whole system. The loss may be due to leakage from the mains or to defects in the meters; or if, as is often the case, the exhaust from the machines is registered, to waste on the consumers' premises. The automatic recorders give the maximum and minimum supplies during 24 hours every day, the maximum record showing the power required for a given number and capacity of machines, and the minimum giving an indication of the leakage. It has been found practicable to obtain an efficiency of 95% in most public power transmission plants over a series of years, but great care is required to produce so good a result. In some years 98% has been registered. Until 1888 no meters were available for registering a pressure of 700 lb per square inch, and all that could be done was to register the water after it had passed through the machines and lost its pressure. This method is still largely adopted; but now high-pressure meters give excellent results, exhaust registration is being superseded to a considerable extent by the more satisfactory arrangement of registering the power on its entry into the consumers' premises. In Manchester Kent's high-pressure meters are now used exclusively. Venturi meters have also been used with success for registering automatically the velocity of flow, and, by integration, the quantity in hydraulic power mains, and form a most useful check on the automatic recorders. The water after the pressure has been eliminated by passage through the machines, may run to a drain or be led back to the central station in return mains; the method adopted is a question of relative cost and convenience.

We proceed to the machines actuated by hydraulic power, and by a comparison of the useful work done by them with the work done by the engines and boilers at the central station the mechanical efficiency of the system as a whole can be gauged. At the central station and in the distribution there is no great difficulty in determining the efficiency within narrow limits; it should be 80% at the point of entry to the machine in which the pressure is used.

Where feeder mains are in use the efficiency of the system is necessarily reduced, owing to the higher velocities allowable in the feeder mains. Mechanical efficiency is then sacrificed for the sake of economy. The mechanical efficiency of the machines is a very uncertain quantity; the character of the machines and the nature of the conditions are so variable that a really accurate general statement is impossible. In most cases the losses in the machine are practically constant for a given size and speed of working; consequently the efficiency of a given machine may vary within very wide limits according to the work it has to do. For instance, a hydraulic pump of a given capacity, delivering the water to an elevation of 100 ft., will have an efficiency of 80%; but if the elevation of discharge is reduced to 15 ft., even though the hydraulic-pressure rams may be proportioned to the reduced head, the efficiency falls below 50%. The ultimate efficiency of the system, or $\frac{\text{pump h.p.}}{\text{i.h.p.}}$, in the one case is 64%, and in the other under 40%. In crane or lift work the efficiency varies with the size of the apparatus, with the load and with the speed. Efficiency in this sense is a most uncertain guide. Some of the most useful and successful applications of hydraulic power—as, for instance, hydraulic capstans for hauling wagons in railway goods yards—have a very low efficiency expressed on the ratio of work done to power expended. Hydraulic cranes for coal or grain hoisting have a high efficiency when well designed, but it is now very usual to employ grabs to save the labour of filling the buckets, and their use lowers the efficiency, expressed in tons of coal or grain raised, by 33% or even 50%. When hydraulic machines are fully loaded, 50% to 60% of the indicated power of the central station engine is often utilized in useful work done with a radius of 2 or 3 m. from the station. In very favourable circumstances the efficiency may rise to over 70% and in a great many cases in practice it no doubt falls below 25%. If, however, energy in any form can be obtained ready for use at a moderate rate, the actual efficiency of the machines (*i.e.* the ratio of the useful work done to the energy absorbed in the process) is not of very great importance where the use is intermittent.

Hydraulic pressure is more particularly advantageous in cases where the incompressibility of the fluid employed can be utilized, as in hydraulic lifts, cranes and presses. Hydraulic machines for these purposes have the peculiar and distinct advantage of direct action of the pressure on the moving rams, resulting in simplicity of construction, slow and steady movement of the working parts, absence of mechanical brakes and greatest safety in action. When the valve regulating the admission of the pressure to the hydraulic cylinder is closed, the water is shut in, and, as it is

incompressible, the machine is locked. Thus all hydraulic machines possess an inherent brake; indeed, many of them are used solely as brakes.

Hydraulic power transmission does not possess the flexibility of electricity, its useful applications being comparatively limited, but the simplicity, efficiency, durability and reliability of typical hydraulic apparatus is such that it must continue to occupy an important position in industrial development.

Sometimes a much higher pressure than 700 lb or 1000 lb per square inch is desirable, more particularly for heavy presses and for machine tools such as are used for riveting, for punching, shearing, &c. The development of these applications has been largely due to the very complete machinery invented and perfected by R. H. Tweddell. One of the principal installations of this kind was erected in 1876 at Toulon dockyard, where the machines are all connected with a system of mains of 2½-in. bore and about 1700 yds. long, laid throughout the yard, and kept charged at a pressure of 1500 lb per square inch by engines of 100 h.p. with two large accumulators. Marc Berrier-Fontaine, the superintending engineer of the dockyard, stated that the economy of the system over the separately-driven geared machines formerly used is very great. But while pressures so high as 3 tons per square inch (as in the 12,000-ton Armstrong-Whitworth press) have been used for forging and other presses, it is not desirable, in the distribution of hydraulic power for general

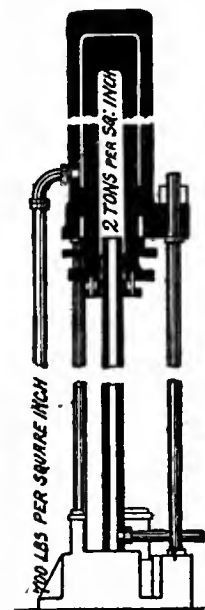

FIG. 8.

purposes, that 1000 lb per square inch should be much exceeded; otherwise the rams, which form the principal feature in nearly all hydraulic machines, if proportioned to the work required, will often become inconveniently small, and other mechanical difficulties will arise. The cost of the machinery also tends to become greater. In particular cases the working pressure can be increased to any desired extent by means of an intensifier (fig. 8).

An important application of hydraulic power transmission is for ship work, the system being largely adopted both in H.M. navy and for merchant vessels. Hydraulic coal-discharging machinery was fitted by Armstrong as early as 1854 on board a small steamer, and in 1868 some hopper barges on the Tyne were supplied with hydraulic cranes. A. Betts Brown of Edinburgh applied hydraulic power to ship work in 1873, and in the same year the first use of this power for gunnery work was effected by G. M. Rendel on H.M.S. "Thunderer." The pressure usually employed in H.M. navy is 1000 lb per square inch. Accumulators are not used and the engines have to be fully equal to supply directly the whole demand. The distance through which the power has to be transmitted is, of course, very short, and the high velocity of 20 ft. per second is allowed in the main pipes. The maximum engine-power

required under these conditions on the larger ships is very considerable. A recent development of hydraulic power on board ship is the Stone-Lloyd system of closing bulkhead doors. In hydraulic transmission of power it is usually the pressure which is employed, but there are one or two important cases in which the velocity of flow due to the pressure is utilized in the machine. Reference has already been made to the use of turbines working at 750 lb per square inch at Antwerp. The Pelton wheel has also been found to be adapted for use with such high pressures. Another useful application of the velocity due to the head in hydraulic transmission is in an adaptation of the well-known jet pump to fire hydrants. The value of the system of hydraulic transmission for the extinction of fire can hardly be overestimated where, as in London and most large towns, the ordinary pressure in the water mains is insufficient for the purpose.

AUTHORITIES.—Armstrong, *Proc. Inst. C.E.* (1850 and 1877); *Proc. Inst. Mech. E.* (1858 and 1868); Blaine, *Hydraulic Machinery* (1897); Davey, *Pumping Machinery* (1905); Dunkerley, *Hydraulics* (1907); Ellington, *Proc. Inst. C.E.* (1888 and 1893); *Proc. Inst. Mech. E.* (1882 and 1895); *Proc. Liverpool Eng. Soc.* (1880 and 1885); Greathhead, *Proc. Inst. Mech. E.* (1879); Marks, "Hydraulic Power," *Engineering* (1905); Parsons, "Sanitary Works, Buenos Aires," *Proc. Inst. C.E.* (1896); Robinson, *Hydraulic Power and Hydraulic Machinery* (1887); Tweddell, *Proc. Inst. C.E.* (1883 and 1894); *Proc. Inst. Mech. E.* (1872 and 1874); Unwin, *Transmission of Power* (1894), *Treatise on Hydraulics* (1907). (E. B. E.)

III.—PNEUMATIC

Every wind that blows is an instance of the pneumatic transmission of power, and every windmill or sail that catches the breeze is a demonstration of it. The modern or technical use of the term, however, is confined to the compression of air

at one point and its transmission to another point where it is used in motors to do work. The first recorded instance of this being done was by Denis Papin (b. 1647), who compressed air with power derived from a water-wheel and transmitted it through tubes to a distance. About 1800 George Medhurst (1759-1827) took out patents in England for compressing air. He compressed and transmitted air which worked motors, and he built a pneumatic automobile. William Mann in 1829 took out a patent in England for a compound air compressor. In his application he states: "The condensing pumps used in compressing I make of different capacities, according to the densities of the fluid to be compressed, those used to compress the higher densities being proportionately smaller than those previously used to compress it to the first or lower densities," &c. This is a very exact description of the best methods of compressing air to-day, omitting the very important inter-cooling. Baron Van Rathen in 1849 proposed to compress air in stages and to use inter-coolers between each stage to get 750 lb pressure for use in locomotives. For the next forty years inventors tried without success all manner of devices for cooling air during compression by water, either injected into the cylinder or circulated around it, and finally, with few exceptions, settled down to direct compression with no cooling worthy of mention. Only in the last ten years of the 19th century were the fundamental principles of economical air compression put into general practice, though all of them are contained in the patent of William Mann and the suggestion of Van Rathen.

The first successful application of compressed air to the transmission of power, as we know it, was at the Mont Cenis Tunnel in 1861. The form of compressor used was a system of water rams—several of them in succession—in which water was the piston, compressing the air upwards in the cylinder and forcing it out. Although the air came in contact with the water, it was not cooled, except slightly at the surface of the water and around the walls of the cylinders. The compressors were located near the tunnel, and the compressed air was transmitted through pipes to drilling machines working at the faces in the tunnel. Rotary drills were tried first, but were soon replaced by percussion drills adapted from drawings in the United States Patent Office, copied by a French and Italian commission from the patent of J. W. Fowle of Philadelphia. H. S. Drinker (*Tunneling, Explosive Compounds and Rock Drills*, New York, 1893) states positively that the first percussion drill ever made to work successfully was patented by J. J. Couch of Philadelphia in 1849. Shortly afterwards Fowle patented his drills, in which the direct stroke and self-rotating principle was used as we use it now. The first successful drill in the Hoosac Tunnel was patented in 1866 by W. Brooks, S. F. Gates and C. Burleigh, but after a few months was replaced by one made by Burleigh, who had bought Fowle's patent and improved it. Burleigh made a compressor, cooling the air during compression by an injected spray of water in the cylinders. The successful work in the Mont Cenis and Hoosac Tunnels with the percussion drilling machines caused the use of compressed air to spread rapidly, and it was soon found there were many other purposes for which it could be employed with advantage.

The larger tunnels and metal mines were naturally the earliest to adopt pneumatic transmission, often using it for pumping and hoisting as well as drilling. In Paris and Nantes, in Berne and in Birmingham (England), street tramways have been operated by pneumatic power, the transmission in these, however, being in tanks rather than pipes. Tanks on the cars are filled at the central loading stations with air at very high pressure, which is used in driving the motors, enough being taken to enable the car to make a trip and return to the loading station. Several attempts in pneumatic street traction were made in America, but failed owing to financial troubles and the successful introduction of electric traction. It is used very successfully, however, both in Europe and in America, in underground mine haulage, being especially adapted to coal mines, where electricity would be dangerous from its sparks. The copper smelting works at Anaconda, Montana, U.S.A., uses twelve large pneumatic

locomotives for charging the furnaces, removing slag, &c. Many stone quarries have a central plant for compressing air, which is transmitted through pipes extending to all working points, and operates derricks, hoists, drills, stone cutters, &c., by means of motors. Every considerable ironworks, railroad shop or foundry has its pneumatic transmission plant. Also in the erection of the larger steel bridges or buildings a pneumatic transmission system is part of the contractor's outfit, and many railways have a portable compressing plant on a car ready to be moved to any point as needed.

Dr Julius G. Pohle, of Arizona, patented in 1886, and introduced extensively, the use of compressed air for lifting water directly, by admitting it into the water column. His plan is largely adopted in artesian wells that do not flow, or do not flow as much as desired, and is so arranged that the air supply has a back pressure of water equal to at least half the lift. If it is desired to lift the water 30 ft. the air is admitted to the water column at least 30 ft. below the standing water surface. The air admitted being so much lighter than the water it displaces, the column 60 ft. high becomes lighter than the column 30 ft. high and is constantly released and flows out at the top. The efficiency of this method is only 20 to 40%, depending on the lift, but its adaptation to artesian wells renders it valuable in many localities.

A remarkable pneumatic transmission system was installed in 1890 by Priestly in the Snake River Desert, Idaho, U.S.A. On the north side of the river is a cliff, nearly perpendicular, about 300 ft. high. One hundred and ninety feet above the river, for a considerable distance along the cliff, streams of water gush out from between the bottom of the great lava bed and the hardened clay of the old lake bottom. Priestly, without knowledge of Pohle's system, built a pipe line down the bluff and trained the water into it in such a way that it carried a very considerable quantity of air in the form of bubbles along with it down the pipe, compressing it on the way. The air was collected at the bottom in a covered reservoir, and taken up the cliff again to the lower part of an inverted siphon pipe, one side of which reached down from the water-supply about 60 ft. and the other side reached up and over the bluff. Allowing the water to fill both sides of the pipe to the level of the water-supply, he admitted his compressed air at about 75 lb pressure into the long side of the pipe near the bottom, and soon had water flowing upwards over the cliff and irrigating a large tract of rich lava land. He had made a power, a transmission and a motor plant without a moving part. A similar compressor was installed near Montreal, Canada, in 1896; another at Ainsworth, British Columbia, in 1898; and another at Norwich, Connecticut, U.S.A., in 1902. These are called hydraulic air compressors and show an efficiency of about 70%. They are particularly adapted to positions where there is a large flow of water with a slight fall or head.

The actual transmission of power by air from the compressor to the motor is simple and effective. The air admits of a velocity of 15 to 20 ft. per second through pipes, with very slight loss by friction, and consequently there is no necessity for an expensive pipe system in proportion to the power transmitted. It is found in practice that, allowing a velocity as given above, there is no noticeable difference in pressure between the compressor and the motor several miles away. Light butt-welded tubing is largely used for piping, and if properly put in there is very slight loss from leakage, which, moreover, can be easily detected and stopped. In practice, a sponge with soap-suds passed around a joint furnishes a detective agency, the escaping air blowing soap bubbles. In good practice there need not be more than 1% loss through leakage and 1% possibly through friction in the pneumatic transmission of power.

Air develops heat on compression and is cooled by expansion, and it expands with heat and contracts with cold. For the purpose of illustration suppose a cylinder 10 ft. long containing 10 cub. ft. of air at 60° F., with a frictionless piston at one end. If this piston be moved 7½ ft. into the cylinder, so that the air is compressed to one-quarter of its volume, and none of the heat developed by compression be allowed to escape, the air will be under a pressure of 90 lb per square inch and at a temperature of 460° F. If this air be cooled down to 60° F. the pressure will be reduced to 45 lb per square inch, showing that the heat produced in the air itself during compression gives it an additional expansive force of 45 lb per square inch. The average force or pressure in compressing this air without loss of heat

is 21 lb per square inch, whereas if all the heat developed during compression had been removed as rapidly as developed the average pressure on the piston would have been only 11 lb per square inch, showing that the heat developed in the air during compression, when not removed as fast as developed, caused in this case an extra force of 10 lb per square inch to be used on the piston. If this heated air could be transmitted and used without any loss of heat the extra force used in compressing it could be utilized; but in practice this is impossible, as the heat is lost in transmission. If the piston holding the 2½ cub. ft. of air at 45 lb per square inch and at 60° F. were released the air expanding without receiving any heat would move it back within 3½ ft. of the end only, and the temperature of the air would be lowered 170° F., or to 110° F. below zero. If the air were then warmed to 60° F. again it would move the piston the remaining 3½ ft. to its starting point.

It is seen that the ideal air-compressing machine is one which will take all the heat from the air as rapidly as it is developed during compression. Such "isothermal compression" is never reached in practice, the best work yet done lacking 10% of it. It follows that the most inefficient compressing machine is one which takes away no heat during compression—that is, works by "adiabatic compression," which in practice has been much more nearly approached than the ideal. It also follows that the ideal motor for using compressed air is one which will supply heat to the air as required when it is expanding. Such "isothermal" expansion is often attained, and sometimes exceeded, in practice by supplying heat artificially. Finally, the most inefficient motor for using compressed air is one which supplies no heat to the air during its expansion, or works by adiabatic expansion, which was long very closely approached by most air motors. In practice isothermal compression is approached by compressing the air slightly, then cooling it, compressing it slightly again, and again cooling it until the desired compression is completed. This is called compression in stages or compound compression. Isothermal expansion is approximately accomplished by allowing the air to do part of its work (as expanding slightly in a cylinder) and then warming it, then allowing it to do a little more and then warming it again, and so continuing until expansion is complete. It will be seen that the air is carefully cooled during compression to prevent the heat it develops from working against compression, and even more carefully heated during expansion to prevent loss from cold developed during expansion. More stages of compression of course give a higher efficiency, but the cost of machinery and friction losses have to be considered. The reheating of air is often a disadvantage, especially in mining, where there are great objections to having any kind of combustion underground; but where reheating is possible, as W. C. Unwin says, "for the amount of heat supplied the economy realized in the weight of air used is surprising. The reason for this is, the heat supplied to the air is used nearly five times as efficiently as an equal amount of heat employed in generating steam." Practically there is a hot-air engine, using a medium much more effective than common air, in addition to a compressed-air engine, making the efficiency of the whole system extremely high. (A. De W. F.)

IV.—ELECTRICAL

Though the older methods of power transmission, such as wire ropes, compressed air and high-pressure water, are still worked on a comparatively small scale, the chief commercial burden has fallen upon the electric generator and motor linked by a transmission line. The efficiency of the conversion from mechanical power to electrical energy and back again is so high, and the facility of power distribution by electric motors is so great, as to leave little room for competition in any but very exceptional cases. The largest single department of electrical power transmission—that is, transmission for traction purposes—is at present almost wholly carried on by continuous currents. The usual voltage is 500 to 600, and the motors are almost universally series-wound constant-potential machines. The total amount of such transmission in daily use reaches probably a million and a half horse power. In long distance power transmission proper continuous currents are not used to any considerable extent, owing mainly to the difficulty of generating continuous currents at sufficient pressure to be available for such work, and the difficulty of reducing such pressure, even if it could be conveniently obtained, far enough to render it available for convenient distribution at the receiving end of the line. Single continuous current machines have seldom been built successfully for more than about 2000 to 3000 volts, if at the same time they were required to deliver any considerable amount of current. About 300 to 500 kilowatts per machine at this voltage appears to be the present limit, although it is by no means unlikely that the use of commutating poles and

other improvements may considerably increase these figures. For distances at which more than this very moderate voltage is desirable one must either depend on alternating currents or use machines in series. In American practice the former alternative is universally taken. On the continent of Europe a very creditable degree of success has been achieved by adopting the latter, and many plants upon this system are in use, mostly in Switzerland. In these generators are worked at constant current, a sufficient number in series being employed to give the necessary electromotive force.

Power Transmission at Constant Current.—In this system, which has been developed chiefly by M. Thury, power is transmitted from constant current generators worked in series, and commonly coupled mechanically in pairs or larger groups driven by a single prime mover. The individual generators are wound for moderate currents, generally between 50 and 150 amperes, and deliver this ordinarily at a maximum voltage of 2000 to 3500, the output per armature seldom being above 300 kw. For the high voltages needed for long distance transmission as many generators as may be required are thrown in series. In the Moutiers-Lyons transmission of 110 m., the most considerable yet installed on this system, there are four groups, each consisting of four mechanically-coupled generators. The common current is 75 amp., and the maximum voltage per group is about 15,000 volts, giving nearly 60,000 volts as the transmission voltage at maximum load. In the St Maurice-Lausanne transmission of about 35 m. the constant current is 150 amp. and the voltage per armature is 2300, five pairs being put in series for the maximum load voltage of 23,000.

Regulation in such plants is accomplished either by varying the field strength through an automatic governor or by similarly varying the speed of the generators. Either method gives sufficiently good results. The transmission circuit is of the simplest character, and the power is received by motors, or for local distribution by motor generators, held to speed by centrifugal governors controlling field-varying mechanism. For large output the motors, like the generators, are in groups mechanically coupled and in series. In the Moutiers-Lyons transmission motor-generators are even designed to give a three-phase constant potential distribution, and in reverse to permit interchange of energy between the continuous current and several polyphase transmission systems.

The advantages of the system reside chiefly in easier line insulation than with alternating currents and in the abolition of the difficulties due to line inductance and capacity. It is probably as easy to insulate for 100,000 volts continuous current as for 50,000 volts alternating current. Part of the difference is due to the fact that in the latter case the crest of the E.M.F. wave reaches nearly 75,000 volts, and in addition static effects and minor resonant rise of voltage must be reckoned with. There is some possibility, therefore, of the advantageous use of continuous current in case very great distances, requiring enormous voltages, have to be covered. In addition, a constant current plant is at full voltage only at brief and rare periods of maximum load instead of all the time, which greatly increases the average factor of safety in insulation.

On the other hand, the constant current generators are relatively expensive and of inconveniently small individual output for large transmission work, and require very elaborate precautions in the matter of insulation. Their efficiency is a little less than that of large alternators, but the difference is partially off-set by the transformers used with the latter for any considerable voltage. A characteristic advantage of the constant current system is the extreme simplicity and cheapness of the switching arrangements as compared with the complication and cost of the ordinary switch-board for a polyphase station at high voltage. Comparing station with station as a whole it is at least an open question whether the polyphase system would have any material advantage in cost per kw. in an average case. The principal gains of the alternating systems appear in the relative simplicity of the distribution. In dealing with a few large power units the constant current system has the best of the argument in efficiency, but in the ordinary case of widespread distribution for varied purposes the advantage is quite the other way.

The high-voltage constant-current plant lends itself with especial ease to operation, at least in emergency, over a grounded circuit. In some recent plants, e.g. Moutiers-Lyons, provision is made at the sub-stations for grounding the central point of the system and either line in case of need, and in point of fact the voltage drop in working grounded is found to be within moderate and practicable limits.

The possibilities of improvement in the system have by no means been worked out, and although it has been overshadowed by the

enormous growth of polyphase transmission it must still be considered seriously.

Transmission by Alternating Current.—The alternating current has conspicuous advantages. In the first place, whatever the voltage of transmission, the voltage of generation and that of distribution can be brought within moderate limits at a very high degree of efficiency by the use of transformers; and, in the second place, it is possible to build alternating-current generators of any required capacity, and for voltages high enough to permit the abolition of raising transformers except in unusual circumstances. At present such generators, giving 10,000 to 13,500 volts directly from the armature windings, are in common and highly successful use; and while the use of raising transformers is preferred by some engineers, experience shows that they cannot be considered essential, and are probably not desirable for the voltages in question, which are as great as at the present time seem necessary for the numerical majority of transmission plants. Polyphase generators, especially in large sizes, can be successfully wound up to more than double the figures just mentioned. The plant at Manojlovac, Dalmatia, has been equipped with four 30,000 volt three-phase generators, giving each about 5000 kw. at 42 ~ with 420 revolutions per minute, the full load efficiency being 94%. But for very large transmission work to considerable distances where much higher voltages are requisite such transformers cannot be dispensed with. Alternating currents are practically employed in the polyphase form, on account both of increased generator output in this type of apparatus and of the extremely valuable properties of the polyphase induction motors, which furnish a ready means for the distribution of power at the receiving end of the line. As between two- and three-phase apparatus the present practice is about equally divided; the transmission lines themselves, however, are, with rare exceptions, worked three-phase, on account of the saving of 25% in copper secured by the use of this system. Inasmuch as transformers can be freely combined vectorially to give resultant electromotive forces having any desired magnitudes and phase relations the passage from two-phase to three-phase, and back again, is made with the utmost ease, and the character of the generating and receiving apparatus thus becomes almost a matter of indifference. As regards such apparatus it is safe to say that honours are about even: sometimes one system proves more convenient, sometimes the other. The difficulty of obtaining proper single-phase motors for the varied purposes of general distribution has so far prevented any material use of single-phase transmission systems.

Generators for Power Transmission.—The generators are usually large two- or three-phase machines, and in the majority of instances they are driven by water-wheels. Power transmission on a large scale from steam plant has, up to the present, made no substantial progress, save as the networks of large electrical supply stations have in some cases grown to cover radii of many miles. The size of these generators varies from 100 or 200 kw. in small plants, up to 10,000 or more in the larger ones. Their efficiency ranges from 92% or thereabouts in the smaller sizes up to 96% or a fraction more in the largest, at full load. The voltage of these generators varies greatly. When raising transformers are used it is usually from 500 to 2500 volts; without them the generators are usually wound for 10,000 to 13,500 volts. Intermediate voltages have sometimes been employed, but are rather passing out of use, as they seem to fulfil no particularly useful purpose. The tendency at the present time, whatever the voltage, is towards the use of machines with stationary armatures and revolving field magnets, or towards a pure inductor type having all its windings stationary. At moderate voltages such an arrangement is merely a matter of convenience, but in high-voltage generators it is practically a necessity. Low-voltage machines are usually provided with polyodontal windings, these windings having several separate armature teeth per pole per phase, while the high-voltage machines are generally monodontal; in both classes the edges of the pole pieces are usually chamfered away in such form as to produce at least a close approximation to the sinusoidal form for the electromotive force. For this purpose, and to obtain a better inherent regulation under variations of load, the field magnets are, or should be, particularly powerful. In the best modern generators the variation of electromotive force from no load to full load, non-inductive, is less than 10% at constant field excitation. Closeness of inherent regulation is an important matter in generators for transmission work.

inasmuch as there is as yet no entirely successful method of automatic voltage regulation on very large units; and the less hand regulation the better. Moreover, the design which secures this result also tends to secure stability of wave form in the electromotive force, a matter of even greater importance. There has been much discussion as to the best wave form for use on alternating circuits, it having been conclusively shown that for a given fundamental frequency the sinusoidal wave does not give the most economical use of iron in the transformers. For transmission work, however, particularly over long lines, this is a matter of inconceivably small importance compared with the stability and the freedom from troubles from higher harmonics that result from the use of a wave as nearly sinusoidal as can possibly be obtained. In every alternating circuit the odd harmonics are considerably in evidence in the electromotive force, either produced by the structure of the generator or introduced by the transformers and other apparatus. These are of no particular moment in work upon a small scale, but in transmission on a large scale to long distances, or especially through underground cables, they are, as will be seen in the consideration of the transmission line itself, a serious menace. Inasmuch as the periodicity of an alternating circuit must be maintained sensibly constant for successful operation, great care is usually exercised to secure such governing of the prime movers as will give constant speed at the generators. This can now be obtained, in all ordinary circumstances, by several forms of sensitive hydraulic governors which are now in use. The matter of absolute periodicity has not yet settled itself into any final form. American practice is based largely upon 60 cycles per second, which is probably as high a frequency as can be advantageously employed. Indeed, even this leads to some embarrassment in securing good motors of moderate rotative speed, and the tendency of the frequency is rather downward than upward. An inferior limit is set by the general desirability of operating incandescent lamps off the transmission circuits. For this purpose the frequency should be held above 30 cycles per second; below this point, flickering of the lamps becomes progressively more serious, especially with lamps having the very slender metallic filaments now commonly employed—so serious, indeed, as practically to prohibit their successful use—and plants installed for such low frequencies are generally confined to motor practice, or to the use of synchronous converters, which are somewhat easier to build in large units at low than at high periodicities. Occasional plants for railway and heavy motor service operate at as low as 15 ~, and more at 25 ~. Nearly all the general work of power transmission, however, is carried on between 30 and 60 ~. The inferior limit at which it is possible successfully to operate alternating arc lamps is about 40 ~; and if these are to be an important feature in transmission systems the indications are that practice will tend towards a periodicity above 40 ~, at which all the accessory apparatus can be successfully operated. European practice is based generally upon a frequency of 50 ~, which admirably meets average conditions of distribution.

Transmission Lines.—Power transmission lines differ from those used for general electric distribution principally in the use of higher voltage and in the precautions entailed thereby. The economic principles of design are precisely the same here as elsewhere, save that the conductors vary less in diameter and far more in length. Inasmuch as transmission systems are frequently installed prior to the existence of a well-developed distribution system the conditions of load and the market for the power transmitted can seldom be predicted accurately; consequently, the cases are very rare in which Kelvin's law can be applied with any advantage; and as it is at best confined to determining the most economical conditions at a particular epoch this law is probably of less use in power transmission than in any other branch of electric distribution. A superior limit is set to the permissible loss of energy in the line by the difficulty attending regulation for constant potential in case the line loss is considerable. The inferior limit is usually set by the undesirability of too large an investment in copper, and lines are usually laid out from the standpoint of regulation rather than from any other. In ordinary practice it seldom proves advantageous to allow more than 15% loss in the line even under extreme conditions, and the cases are few in which less than 5% loss is advisable. These few cases comprise those in which the demand for power notably overruns the supply as limited by the maximum power available at the generating station, and also the few cases in which a loss greater than 5% would indicate the use of a line wire too small from a mechanical standpoint. It is not advisable to attempt to construct long lines of wire smaller than No. 2 American wire-gauge (.257 in. diameter), although occasionally wire as small as No. 4 (.204 in. diameter) may safely be employed. Smaller diameter than this involves considerable added difficulty of insulation in lines operated at voltages in excess of about 50,000. The vast majority of transmission lines are composed of overhead conductors. In rare instances underground cables are used. In single-phase work these are preferably of concentric form, which, however, gets too complicated in the three-phase lines generally employed to secure economy in copper; for the latter, triplicate cables, lead sheathed, laid in glazed earthenware ducts, seem to give the best results. On account of the cost and the difficulty of repair of such lines they are not extensively used, and cables have not yet been produced for the extremely high voltages desirable in some very long circuits,

although they are readily obtainable for voltages up to 30,000 or 40,000. As to the material of the conductors, copper is almost universally used. For very long spans, however, bronze wire of high tensile strength is occasionally employed as a substitute for copper wire, and more rarely steel wire; aluminium, too, is beginning to come into use for general line work. Bronze of high tensile strength (say 80,000 to 100,000 lb per square inch) has unfortunately less than half the conductivity of copper; and unless spans of many hundred feet are to be attempted it is better to use hard-drawn copper, which gives a tensile strength of from 60,000 to 65,000 lb to the square inch, with a reduction in conductivity of only 3 to 4%. As to aluminium, this metal has a tensile strength slightly less than that of annealed copper, a conductivity about 60% that of copper, and for equal conductivity is almost exactly one-half the weight. Mechanically, aluminium is somewhat inferior to copper, as its coefficient of expansion with temperature is 50% greater; and its elastic limit is very low, the metal tending to take a permanent set under comparatively light tension, and being seriously affected at less than half its ultimate tensile strength. Joints in aluminium wire are difficult to make, since the present methods of soldering are little better than cementing the metal with the flux; in practice the joints are purely mechanical, being usually made by means of tight-fitting sleeves forced into contact with the wire. With suitable caution in stringing, aluminium lines can be successfully used, and are likely to serve as a useful defence against increase in the price of copper. Whatever the material, most important lines are now built of stranded cable, sometimes with a hemp core to give added flexibility.

With respect to line construction the introduction of high voltages, say 40,000 and upwards, has made a radical change in the situation. The earlier transmission lines were for rather low voltages, seldom above 10,000. Insulation was extremely easy, and the transmission of any considerable amount of power implied heavy or numerous conductors. The line construction therefore followed rather closely the precedents set in telegraph and telephone construction and in low tension electric light service. In American practice the lines were usually of simple wooden poles set 40 to 50 to the mile, and carrying wooden cross-arms furnished with wooden pins carrying insulators of glass or porcelain. The poles were little larger than those used in telegraph lines, a favourite size being a 40-ft. pole about 8 in. in diameter at the top and 15 in. at the butt, set 6 to 7 ft. in the earth. Such poles commonly bore two cross-arms, the lower and longer carrying 4 pins, and the shorter upper arm 2 pins, so disposed that the upper pin on each side of the pole would form with the nearer pins below an equilateral triangle 18 to 24 in. on the side. The poles therefore carried two three-phase circuits one on either side, one or both circuits being spiralled. In European practice iron poles have been more frequently used, again following rather closely the model of telegraph practice, with similar spacing of poles, and with insulators, usually of porcelain, somewhat enlarged and improved over telegraph and electric light insulators, and spaced somewhat more widely. As between wooden and steel poles, the latter are of course the more durable and much the more costly. The difference in cost depends largely on the locality, and ultimately on the life of the wooden poles. This ranges from two or three up to ten or fifteen years, the latter figures only in favourable soils and when the lower ends of the poles have been thoroughly treated with some preservative. Under such conditions wood is often ultimately the cheaper material.

The use of very high voltages results in, for all moderate powers, the use of small and consequently light wires and in the necessity for heavy, large and costly insulators. For security against leakage and failure it becomes desirable to reduce the number of insulation points, and with the resulting lengthening of span to design the line as a mechanical structure. A transmission line is subject to three sets of stresses. The most considerable are those due to the longitudinal pull of the catenary depending on the weight and tension of the wires. Under ordinary conditions these strains are balanced and come into play only when there is breakage of one or more wires and consequent unbalancing. It has been the common practice to give the poles sufficient strength to withstand this pull without failing. The maximum amount of the pull may be safely taken at the sum of the elastic limits of the wires, since it is unsafe so to design the spans as to be subject to larger stresses.

There is also lateral stress on a line due to wind acting upon the poles and wires, the latter amounting to little unless their diameter is increased by a coating of sleet, a condition which gives maximum stresses on the line. Wind then tends to push the line over, and it also increases the longitudinal stresses, being added geometrically to the catenary stress. The actual possibility of wind pressure is very generally over-estimated, and has resulted in much needlessly costly construction. In the first place, save for actual tornadoes, for which no estimates can be given, even the highest winds at the level of any ordinary transmission line are of modest actual velocity. It is probable that no transmission line save on mountain peaks at a very high elevation is ever exposed to an actual wind velocity of 75 m. per hour, and only at intervals of years is a velocity of even 60 m. reached near the ground level. Further, the maximum wind velocities are practically never reached at very low temperatures when the line is under its maximum catenary stress, and sleet

formation, which takes place only within a very limited temperature range, is practically unknown under conditions of maximum wind.

The relation of wind velocity to pressure in case of a suspended wire or cable may be approximately expressed by the equation $P=0.0025V^2$, where P is the pressure per square foot of projected area of cable, and V is the actual wind velocity in miles per hour. Except for sleet conditions the wind pressure is, then, a matter of little concern. At times sleet may accumulate on bare wires to a thickness of half an inch to an inch. Even under these conditions the lateral stability of the line is a matter of less concern than the added component of stress in the catenary. The third element of line stress, the actual crushing stress of the wire load, is of no consequence in high voltage transmission work.

In scientific line design the best example has been set by the Italian engineers, who, realizing that the longitudinal strains, which are very severe in case of breakage of spans rigidly supported from pole to pole, are immediately relieved by a slight increase in catenary drop, have introduced the principle of longitudinal flexibility. The poles or towers of structural steel are so designed as to be fairly stiff against lateral pressure and are given secure foundation against overturning, but are deliberately designed to deflect lengthwise the line in the extreme case of breakage of wires so as at once to relieve the catenary tension without passing their elastic limit. In this way complete security is attained with a minimum of material and expense.

In recent construction both in America and Europe the tendency is to use steel poles or towers of ample height, 40 to 60 ft. and spans ranging from 300 to 600 ft., occasionally more. The catenary drop allowed is considerable, often 3 to 4% of the span length. Cross-arms and pins, when used, are commonly of iron or steel, and the interiors of the insulators are therefore fairly at earth potential. The insulators are of dense and hard-baked porcelain, built up of three or four shells cemented together to form a whole, with several deep petticoats to protect the inner surfaces from wetting. Such insulators may be 12 to 18 in. in diameter over all, and from top groove to base a little more. If well designed and made, insulators of this type can endure even under very heavy precipitation alternating voltages of 60,000 to 100,000 effective without flashing over, and double these figures when dry. For line voltages above 60,000 to 70,000 it is apparent that the insulating factor of safety would be seriously reduced, and some recent lines have been equipped with suspension insulators. These are in effect porcelain bells from 10 in. diameter upward strung together like a string of Japanese gongs. The bells are all the same size and are spaced about a foot apart, the suspensions being variously designed. These insulating groups can be as large as need be, and it is easy to push the aggregate insulation resistance, both dry and wet, far beyond the figures just mentioned. This suspension requires higher poles than the ordinary, but allows a considerable amount of longitudinal back lash, in case a wire burns off. Too extensive slip along the line is checked by guys fitted with strain insulators, like the suspension ones, at suitable intervals. The suspension insulator gives promise of successful use of voltages much higher than 100,000 volts. The wires on high voltage systems are generally widely spaced: very seldom less than 2 ft. between centres, and for the higher voltages something like 1 ft. for each 10,000 volts.

Voltage.—The most important factor in the economy of the conducting system is the actual voltage used for the transmission. This varies within very wide limits. For transmissions only a few miles in length the pressures employed may be from 2000 to 5000 volts, but for the serious work of power transmission less than 10,000 volts are now seldom used. This pressure, under all ordinary conditions and in all ordinary climates, can be and is used with complete success, and apparently without any greater difficulty than would be encountered at much lower voltage. It is regarded as the standard transmission voltage in American practice for short distances up to 10 or 15 m. Beyond this, and sometimes even on shorter lines, it is greatly increased; up to 20,000 volts there seems to be no material difficulty whatever in effecting and maintaining a sufficient insulation of the line. In the higher voltages there were in 1908 more than fifty plants in regular operation at 40,000 volts and above. Of these more than a score are operated at 60,000 volts and above. The highest working voltage employed in 1909 was 110,000 volts, which was successfully used in two American plants: that of the Grand Rapids—Muskegon (Michigan) system, and in the transmission work of the Central Colorado system. These both employ suspension insulators with five bells in series, and operate with no more trouble than falls to the lot of systems using ordinarily high voltages. The Rio de Janeiro transmission system, operates at 88,000 volts with large porcelain insulators, 17.5 in. in over-all diameter and 19.75 in height, carried on steel pins; the Kern River (California) plant at 75,000 volts with similar construction; the Missouri River Power Co. (Montana) at 70,000 volts, using glass insulators on wooden pins saturated with insulating material. There is no especial difficulty in building transformers for still higher pressures, the real problem lying in the insulation of the line. Taken as a whole these high voltage lines have given good service, those near the upper limit doing apparently as well as those near the lower, owing to more careful precautions in construction. Likewise the distances of

transmission have steadily risen. There are, all told, nearly a score of power transmissions over 100 m. in length, the longest distance yet covered being from De Sable to Sausalito (California), a distance of 232 m. This, like most other long American transmissions, is at 60~, and it is interesting to note that even over such distances there seems to be very little evidence of trouble due to frequency. In point of fact, those who have had the most experience with long distance transmission are the last to worry about the difficulties of using alternating current. Some unusual phenomena turn up in high voltage work, but they are rather interesting than alarming. The lines become self-luminous from "coronal" discharge at a little above 20,000 volts, and at 40,000 or 50,000 volts the phenomenon, which is sometimes aggravated by resonance, becomes of a striking, not to say startling, character. At above 100,000 volts this coronal discharge must be given serious consideration.

Resonance, in substance, is due to synchronism of the periodic electromotive force, or a harmonic thereof, with the electro-magnetic time-constant of the system. The frequency of the currents actually employed in transmission work is so low that resonance with the fundamental frequency must be extremely rare; resonance with the harmonics is, however, common—much commoner than is generally supposed. In every electromotive force wave the odd harmonics are more or less in evidence, particularly the third, fifth and seventh. If the electromotive force wave departs notably from a sinusoidal form, traces of harmonics up to at least the 15th may generally be found; the third, seventh and the alternate higher harmonics are manifest in flattening the crest of the wave. Supposing, what is seldom quite true, that the harmonics are symmetrically disposed in phase with the fundamental, all the harmonics tend somewhat to elevate the shoulders of the wave; a wave, therefore, with peaked shoulders and a depression in the centre is certain to be affected by harmonics, while if it has a high central crest, there is evidence of great predominance of the fifth and higher harmonics. Generally the harmonics are slightly out of phase with the fundamental, so that the wave is both deformed and unsymmetrical. As to the amplitude of these harmonics, the third is usually the largest, and may sometimes in commercial machines amount to as much as 20% of the amplitude of the fundamental, and frequently 10%. In machines giving nearly sinusoidal waves it is of course much less, but it is not difficult to find even the seventh and higher harmonics producing variations as great as 5%. Since, other things being equal, the rise in electromotive force due to resonance is directly proportional to the magnitude of the harmonics, and the chance of getting it increases rapidly with the presence of those of the higher orders, the desirability of using the closest possible approximation to a sinusoidal wave is self-evident. The greater the inductance and capacity of the system and the less its ohmic resistance, the greater the chance of getting serious resonance. As regards the distributed capacity and inductance due to the line alone, the ordinary conditions are not at all formidable; the general effect of such distributed capacity and inductance is to produce in the system a series of static waves, their length varying inversely with the frequency. At commercial frequencies the wave length is very great, so great that even in the longest lines at present employed only a small fraction of a single wave length appears; the total length of the line is generally much less than one quarter the complete wave length, and the only notable effect is a moderate rise of potential along the line. The time-constant of the alternating circuit is $T=0.0629\sqrt{LC}$, where L is the absolute self-induction in henrys and C the capacity in microfarads; and if the frequency, or a marked harmonic thereof, coincide with this time-period, resonance may safely be looked for, and resonance of the harmonics may appear conspicuously in lines of ordinary lengths. The following table gives the values, both L and C , per mile of three-phase circuit, of the sizes (American wire-gauge) ordinarily employed for transmission circuits, the wires being assumed to be strung 48 in. apart and about the height already indicated:—

Size No.	Diameter.	L.	C.
	inch.		
0000	0.460	0.00312	0.0167
000	0.410	0.00322	0.0164
00	0.365	0.00328	0.0160
0	0.325	0.00336	0.0157
1	0.289	0.00338	0.0154
2	0.258	0.00347	0.0151
3	0.229	0.00351	0.0148
4	0.204	0.00358	0.0145

In cases where underground cables form a part of the system, the above values of C are very largely increased, and the probability of resonance is in proportion enhanced. A still further complication is introduced by the capacity and inductance of the apparatus used upon the system, which may often be far greater than that due to the entire line, even if the latter be of considerable length. In point of fact, it is altogether probable that resonance due to the distributed capacity and inductance of the overhead line alone is of rare occurrence and generally of trivial amount, while it is equally probable

that resonance due to localized capacity and inductance other than that of the line conductors may, and often does, cause very serious disturbances upon the system. The subject has never been adequately investigated, but the tendency towards formidable sparking and arcing at various points on long-distance transmission systems is generally far greater than can be accounted for by consideration of the nominal voltages alone. The conditions may be still further complicated by the effect of earths or open circuits, which sometimes may produce, temporarily, appalling resonance phenomena, through bringing into action the capacity and inductance of the apparatus and introducing surges. In ordinary working the resonance of the harmonics is not very conspicuous, and the fact that it occurs not systematically, but only in special ways and under special conditions, indicates more strongly than anything else that the vital point is not the time-constant of the line alone, but those of the apparatus connected thereto. A definite and persistent tendency towards resonance may sometimes be effectively checked by the introduction of suitable inductance in the parts of the system most seriously affected, but the best general policy is to avoid as far as possible the presence of the higher harmonics, which are the chief sources of danger.

Closely allied to and connected with *resonance* is the phenomenon known as "surging," which is due to the discharge of the electromagnetic energy stored in a circuit containing inductance and capacity when that circuit is broken. This discharge is an oscillatory one, going on with decreasing amplitude until it is frittered away by resistance and other sources of loss. Its frequency is that of the system affected, and the surge may get reinforcement from resonance proper. It is sufficiently serious on its merits, however, since the resulting rise of voltage increases directly with the current and may produce terrific results when the break comes as the result of a short circuit. Minor surging occurs when there is a sudden and violent change in the conditions of the circuit even without an actual break. Such a change produces an impulsive redistribution of energy that may give a sharp rise in voltage. Every point of abrupt variation in the electrical constants on the system is liable to be affected by minor surges. Such disturbances when trivial are commonly referred to as "static." Surging, depending as it does on the current ruptured, may, and indeed often does, give particularly formidable effects on circuits of moderate voltage, while on high voltage transmission circuits the usually moderate current and the large margin of safety in the insulation are important ameliorating influences.

Maintenance.—Transmission lines are, when practicable, laid out through open country, and along roads which furnish easy access for inspection and repairs. The chief sources of danger in temperate climates are mechanical injury from the falling of branches of trees across the circuits, sleet and wind storms, and lightning. The first-mentioned difficulty may be avoided by keeping clear, so far as possible, of wooded country, and it should be remembered that, at the voltages customarily used for transmission, a twig the size of a lead-pencil falling across the wires may set up arcing, and it will end by burning the wires completely off—not directly by fusion, but by persistent arcing. A properly constructed overhead line is practically safe against all storms, save those of most extraordinary violence, and with care may be made secure even against these. As a matter of practice, interruptions of service upon transmission systems are very rarely due to trouble upon the main line itself, but are far more likely to occur in some part of the distributing system. The most dangerous combination of circumstances is a sleet storm sufficient to coat the wires with ice, followed by heavy winds; if the line, however, is constructed with proper factors of safety, bearing this particular danger in mind, there need be very little fear of serious results. Lightning is a much more formidable enemy. The lightning discharges observed upon electric circuits are of two general descriptions: first, a direct discharge of lightning upon the line, more or less severe, and always to be dreaded; and secondly, induced discharges due to lightning flashes which do not hit the line, or to static disturbances which may or may not produce actual lightning. Discharges of the former class are vastly more severe than those of the latter, and, fortunately, are somewhat rare. They may actually shatter the line, or may distribute themselves along it for a considerable distance, leaping from wire to pole, and thence to earth, without actually damaging the line to any marked degree. The induced discharges are felt principally in the apparatus, causing many of the burn-outs observed in transformers and generators. There is no complete protection against the effects of lightning upon the apparatus. Even the best lightning arresters are palliatives rather than preventives. If, however, a number of arresters are put in parallel, with reactance coils between them on the way towards the apparatus, the vast majority of lightning discharges, to whatever cause they may be due, will be deflected harmlessly to earth. Moreover, the apparatus itself has a considerable power of resistance, due to its high insulation. The ends of the line should be very thoroughly protected by such lightning arresters, and other points, such as prominent elevations along the line, should receive similar additional protection. In some cases a substantial steel-wire cable stretched along the tops of the poles several feet above the line wires and well grounded at frequent intervals has been found very advantageous. With the best protection at present available,

lightning is not a serious menace to continuity of service, and the apparatus of the distributing system is far more difficult to protect than the main line and its apparatus.

Sub-stations.—In most long-distance transmission work the transmission line itself terminates in a sub-station, which bears to the general distribution system precisely the same relations which are borne by a central electric supply station to its distributing lines. Such a sub-station should be treated, in fact, as a central station, receiving its electric energy from a distance instead of employing local generators driven by prime movers. The design of the sub-station, however, is somewhat different from that of the ordinary central station. The transmission lines terminate generally in a bank of reducing transformers, bringing the voltage from the 10,000 or higher voltage employed upon the line to the 2000 or more generally used in the distribution. These transformers are usually large, and their magnitude should be determined by the same considerations which apply to determining the size of the units to be employed in a generating station. The general rule to be followed is that the separate units shall be of such size that one of them may be dispensed with without serious inconvenience. In the case of transformers, the unit in two- or three-phase working is the bank of transformers, which must be used together. In Continental practice three-phase reducing transformers are frequently made to include all three phases in a single structure; this practice is less frequently followed in American plants, separate transformers being more often used in each phase. In this case, two or three transformers, according as the two- or three-phase system is used, constitute a single transformer unit in the sense just mentioned. If a change is to be made from three-phase line to two-phase distribution, the change is made by the appropriate vector connexion of the transformers. The full-load efficiency of large sub-station transformers is commonly 97 to 98%. In any case, the sub-station is furnished with voltage regulating appliances, to enable the voltage upon the distribution lines to be held constant and uniform. These regulators are, in practice, transformers with a variable transformation ratio. This is obtained in divers ways—sometimes by changing the inductive relations of the primary and secondary coils, sometimes by changing the relative number of effective turns in primary and secondary. Sets of these inductive regulators enable the voltage to be controlled over a sufficiently wide range to secure uniform potential on the system, and with a degree of delicacy that obviates any undesirable changes in voltage. The regulation is usually manual, no automatic regulator yet having proved entirely satisfactory. In very large systems it is worth noting that the so-called "skin effect" in alternating current conductors may become conspicuous. In the transmission circuits themselves the wires are, in practice, never large enough to produce any sensible difference in conductivity for continuous and for alternating currents. In the heavy omnibus-bars of a large sub-station this immunity may not be continued, but in such cases flat strips are frequently employed. If these are not more than, say, a centimetre in thickness, the "skin effect" is practically insignificant for all frequencies used commercially. Not infrequently the sub-station also contains devices for the changing of alternating to continuous current, usually synchronous converters feeding either traction system or electric lighting mains. Beyond these converters the system becomes an ordinary continuous-current system, and is treated as such. When very close regulation is necessary, motor-generators are often preferred to synchronous converters. Series arc lighting from transmission circuits is a much more serious problem. At the present time two methods are in vogue: first, the operation of continuous-current series-arc machines by synchronous or induction motors driven from the transmission system; and, secondly, series alternating apparatus for feeding alternating arcs. This apparatus consists either of constant-current transformers with automatically moving secondaries, or of inductive regulators, also automatic in their action, supplemented by transformers to supply them with the necessarily rather high voltage employed for arc distribution. As between these two systems practice is at present divided; electrically, the alternating apparatus gives a rather higher real efficiency, but involves the use of alternating arcs, which are somewhat less efficient, watt for watt, as light producers than the continuous-current arcs. The apparatus, however, requires practically no care, while the arc machines, driven by motors, require the same amount of care as if they were driven by other power. Arc light transformers, however, are likely to have low power factors, hardly above 0.8 at full load, and rapidly falling off at lower loads. Synchronous rectifiers changing the alternating current into a unidirectional current, suitable for use with arc lights, have been employed with some success, but not to any considerable extent. They are satisfactory in avoiding the use of alternating currents in the arc, and consume but little energy in the transformation from one form of current to the other, but involve the use of static transformers automatically giving constant current, which are somewhat objectionable on the score of low-power factor. Mercury rectifiers are now used rather extensively and give excellent results, although they are as yet of somewhat uncertain life, and, like the synchronous rectifiers, require special transformers when worked at constant current. In Continental practice arc lights are almost universally worked off constant

potential circuits, and hence the difficulties just considered are for the most part peculiar to American systems.

Distances of Transmission.—The ultimate determining factor in the distance to which power can be commercially transmitted is the economic side of the transmission, the maximum distance being the maximum distance at which the transmission will pay. As a mere engineering feat the transmission of power to a distance of many hundred miles is perfectly feasible, and, judging from the data available, the phenomena encountered in increasing the length of lines have not been of such character as to cause any hesitation in going still farther, provided the increase is commercially feasible. In American practice, it is within the truth to say that nearly all transmissions of reasonable size (say a few hundred kilowatts) to distances of twenty miles, or less, are pretty certain to pay. At distances up to fifty miles, in a large proportion of cases power can be delivered at prices which will enable it to compete with power locally generated by steam. From fifty to one hundred miles (on a large scale—several thousand kilowatts) the chances for commercial success are still good. The larger the amount of power transmitted, the better on the whole is the commercial outlook. The longest one yet operated has already been noted, and may be regarded as a commercial success. In certain localities where the cost of fuel is extremely high, transmissions of several hundred miles may prove successful from a commercial as well as an engineering standpoint, but the growth of industry, which indicates the necessity for such a transmission, may go on until, through improved facilities of transport, the cost of fuel may be greatly lowered and the economic conditions entirely changed. Such a modification of the conditions sometimes takes place much more quickly than would be anticipated at first sight, so that when very long distance transmissions are under consideration, the permanence of the conditions which will render them profitable should be a very serious subject of consideration. (L. BL.)

POWIS, EARLS AND MARQUESSSES OF. Before the Norman Conquest the Welsh principality of Powis, comprising the county of Montgomery and part of the counties of Brecknock, Radnor, Shropshire, Merioneth and Denbigh, was subject to the princes of North Wales. Early in the 12th century it was divided into upper and lower Powis. In 1283 Owen ap Griffin, prince of upper Powis, formally resigned his princely title (*nomen et circulum principatus*) and his lands to the English king Edward I. at Shrewsbury, and received the lands again as an English barony. (See *Montgomeryshire Collections*, 1868, vol. i.). This barony of Powis passed through female inheritance to the family of Cherleton and in 1421 to that of Grey. It fell into abeyance in 1551.

In 1587 Sir Edward Herbert (d. 1594), a younger son of William Herbert, earl of Pembroke, purchased some of the lands of the barony, including Red castle, afterwards Powis castle, near Welshpool, and in 1629 his son William (c. 1573-1656) was created Baron Powis. William's grandson, William, the 3rd baron (c. 1629-1695), was created earl of Powis in 1674 and Viscount Montgomery and marquess of Powis in 1687. The recognized head of the Roman Catholic aristocracy in England, Powis was suspected of complicity in some of the popish plots and was imprisoned in the Tower of London from 1678 to 1684. He followed James II. into exile and was created duke of Powis by the dethroned king. The English government deprived him of his estates, but these were restored to his son William, the 2nd marquess, in 1722. William, who had a somewhat chequered career as a Jacobite, died in October 1745, and when his son William, the 3rd marquess, died in 1748 the titles became extinct.

In 1748 Henry Arthur Herbert (d. 1772), who had been made Baron Herbert of Chirbury in 1743, was created Baron Powis and earl of Powis. He allied himself with the earlier holders of these titles, with which family he was distantly connected, by marrying Barbara, a niece of the 3rd marquess. The titles became extinct a second time when his son George Edward died in January 1801. George's sister and heiress, Henrietta Antonia (1758-1830), married Edward Clive (1754-1829), son and heir of the great Lord Clive. In 1794 he was made Baron Clive of Walcot, and in 1804, after serving as governor of Madras from 1798 to 1803, he was created Baron Powis and earl of Powis. His son Edward, the 2nd earl (1785-1848), took the name of Herbert in 1807 in lieu of that of Clive. He was a member of parliament from 1806 to 1839, and was elected in opposition to the Prince Consort, as chancellor of the university of

Cambridge in 1847. His second son was Lieut.-General Sir Percy Egerton Herbert (1822-1876), who distinguished himself in the Crimean War, and Sir Percy's son, George Charles (b. 1862), became the 4th earl in 1891.

POWNALL, THOMAS (1722-1805), British colonial statesman and soldier, was born at Saltfleetby, Lincolnshire, England, in 1722. He was educated at Lincoln and at Trinity College, Cambridge, where he graduated in 1743. He entered the office of the lords commissioners of trade and plantations, of which his brother John was then secretary; and in 1753 he went to America as private secretary to Sir Danvers Osborn, just appointed governor of New York. Osborn committed suicide soon after reaching New York (Oct. 6), but Pownall remained in America, devoting himself to studying the condition of the American colonies. At the Albany Congress, in 1754, he met Benjamin Franklin, and a life-long friendship between the two resulted. In 1756 he returned to England, and presented to Pitt a plan for a campaign against the French in Canada, to begin with the investment of Quebec. In 1757 Pitt appointed him governor of Massachusetts,¹ in which office he heartily supported Pitt's policy during the Seven Years' War, and in 1758 encouraged the equipment of a force of 7000 men, to be recruited and armed in New England; but the French power in America once broken, Pownall came more directly under the influence of the lords of trade, and his unwillingness to carry out the repressive policies of that body caused his transfer to the governorship of South Carolina in February 1760. This office he held nominally for about a year; but he never went to South Carolina, and in June 1760 he returned to England. In 1762-1763 he was commissary-general of the British troops in Germany. As member of parliament for Tregony in 1768-1774 and for Minehead in 1774-1780, he at first sided with the Whigs in opposing all plans to tax the American colonists, but he supported North's administration after the outbreak of the War of Independence. He died at Bath on the 25th of February 1805. In 1764 he published (at first anonymously) his famous *Administration of the Colonies* (other editions appeared in 1765, 1766, 1768 and 1774), in which he advocated a union of all British possessions upon the basis of community of commercial interests.

For an extended account of Pownall's career and a bibliography of his publications see *Thomas Pownall, M.P., F.R.S.* (London, 1908), by Charles A. W. Pownall, a distant kinsman, who attempts to prove that Pownall was the "author behind the scenes" of the "Letters of Junius" and "that Francis was his subordinate."

POYET, GUILLAUME (1473-1548), French magistrate, was born at Angers. After practising successfully as a barrister at Angers and Paris, he was instructed by Louise of Savoy, mother of the king, Francis I., to uphold her rights against the constable de Bourbon in 1521. This was the beginning of his fortunes. Through the influence of the queen-mother he obtained the posts of advocate-general (1530) and president of the parlement of Paris (1534), and became chancellor of France in 1538. He was responsible for the legal reform contained in the ordinance of Villers-Cotterets (1539), the object of which was to shorten procedure. This ordered the keeping of registers of baptisms and deaths, and enjoined the exclusive use of the French language in legal procedure. With the constable de Montmorency he organized an intrigue to ruin Admiral Chabot, and procured his condemnation in 1541; but after the admiral was pardoned, Poyet was himself thrown into prison, deprived of his offices, and sentenced to a fine of 100,000 livres. He recovered his liberty in 1545, and died in April 1548.

See C. Porée, *Guillaume Poyet* (Angers, 1898).

POYNINGS, SIR EDWARD (1459-1521), lord deputy of Ireland, was the only son of Robert Poynings, second son of the 5th Baron Poynings. His mother was a daughter of Sir William Paston, and some of her correspondence is to be found in the

¹ In September 1755 Pownall had been made lieutenant-governor of New Jersey, but he had little to do with the affairs of that province and resigned soon after his appointment to Massachusetts.

Paston Letters. Robert Poyning was implicated in Jack Cade's rebellion, and Edward was himself concerned in a Kentish rising against Richard III., which compelled him to escape to the Continent. He attached himself to Henry, earl of Richmond, afterwards King Henry VII., with whom he returned to England in 1485. By Henry VII. Poyning was employed in the wars on the Continent, and in 1493 he was made governor of Calais. In the following year he went to Ireland as lord deputy under the viceroyalty of Prince Henry, afterwards King Henry VIII. Poyning immediately set about Anglicizing the government of Ireland, which he thoroughly accomplished, after inflicting punishment on the powerful Irish clans who supported the imposture of Perkin Warbeck. He then summoned the celebrated parliament of Drogheda, which met in December 1494, and enacted the "Statutes of Drogheda," famous in Irish history as "Poyning's law" (see STATUTE: *Ireland*), which made the Irish legislature subordinate to, and completely dependent on, that of England, till its repeal in 1782. After defeating Perkin Warbeck at Waterford and driving him out of Ireland, Poyning returned to England in 1496, and was appointed warden of the Cinque Ports. He was employed both in military commands and in diplomatic missions abroad by Henry VII., and later by Henry VIII., his most important achievement being the successful negotiation of the "holy league" between England, Spain, the emperor, and the pope, in 1513. In 1520 he was present at the Field of the Cloth of Gold, in the arrangement of which he had taken an active part. He died in 1521. By his wife, Elizabeth Scot, Poyning left no surviving issue, and his estates passed through a collateral female line to the earl of Northumberland. He had several illegitimate children, one of whom, Thomas Poyning, was created Baron Poyning in 1545, but died in the same year without heirs.

See Sir Francis Bacon, *The History of the Reign of King Henry VII.* (London, 1641); Richard Bagwell, *Ireland under the Tudors* (2 vols., London, 1885); J. T. Gilbert, *History of the Viceroys of Ireland* (Dublin, 1865); J. A. Froude, *The English in Ireland* (3 vols., London, 1872-1874); Wilhelm Busch, *England under the Tudors*, ed. by James Gairdner (London, 1895).

POYNTER, SIR EDWARD JOHN, BART. (1836-), English painter, son of Ambrose Poynter, architect, was born in Paris on the 20th of March 1836. He pursued his art studies in England and in Paris (under Gleyre, 1856-1859), and exhibited his first picture at the Royal Academy in 1861. In 1869, after the exhibition of "Israel in Egypt" and "The Catapult," he was elected an Associate of the Royal Academy, and in 1876, the year of "Atalanta's Race," full Academician.

In the decorative arts he practised freely as a designer in fresco, mosaic, stained glass, pottery, tile-work and the like. While still quite a young man, he was encouraged by the architect William Burges, A.R.A., to design panels for his quaint Gothic cabinets; Messrs Powell obtained from him cartoons of designs for stained glass; for the decoration of Waltham Abbey church he was employed on a series of thirty important designs. Attracted by these, Dalziel Brothers commissioned a number of full-page drawings on wood for the illustration of their celebrated "Bible Gallery." The cartoons for "St George" and "St David," the mosaic panels now embellishing the outer lobby of the Palace of Westminster, were produced in 1870, and they were followed by the "Apelles" and "Phidias," in the same method of reproduction, in the Victoria and Albert Museum; by the important series of frescoes in St Stephen's, Dulwich—scenes from the life of the saint; by the decoration of the grill room at the Museum at South Kensington, with the tiles *en camaïeu*—an achievement strikingly successful and pregnant with results. Always a lover of water-colour drawing and of the art of landscape painting, he was elected to the Royal Society of Painters in Water Colours in 1883. In 1874 he designed the Ashantee medal; and in 1892, for the coinage of that year, the reverse of the shilling and florin, to the obverse of Mr Thomas Brock, R.A.

When the art teaching centre of South Kensington was assuming the importance it has since attained, Mr Poynter was appointed director for art in the Science and Art Department, and principal of the National Art Training Schools (now the Royal College of Art), and by virtue of his vigorous and successful administration he invested his office with a distinction which, after his resignation in 1881, it soon notoriously lacked.

The directorship of the National Gallery became vacant in 1894, and Poynter, profoundly versed in the works of the Old Masters, especially of the Italian schools, was appointed to the post, which he held for ten years. Under his rule the National Gallery of British Art, at Millbank, presented by the late Sir Henry Tate, became a department of the National Gallery, and thither were removed many pictures formerly in the British rooms at Trafalgar Square, as well as the Chantrey Collection from South Kensington, &c. One of the most important services by the director was the editing of the great *Illustrated Catalogue of the National Gallery* (1889-1900), in which every picture in the collection is reproduced—an unprecedented achievement in the annals of art-publishing.

On the death of Sir John Millais in 1896, Poynter was elected to the presidency of the Royal Academy, and was knighted. He was made a baronet in 1902.

Paintings.—Among Sir Edward Poynter's most notable pictures have been the following: "Israel in Egypt" (1867); "The Catapult" (1868); "Perseus and Andromeda" (1872); "Atalanta's Race" (1876); "The Fortune-Teller" (1877); "Nausicaa and Her Maidens" (1879); "Visit to Aesculapius" (1880), now in the Chantrey Collection in the Tate Gallery; "The Ides of March" (1883); "Diadumène" (1885), now destroyed; "On the Terrace" (1889); "The Meeting of Solomon and the Queen of Sheba" (1891); "Horae Serenae" and "Idle Fears" (1894), and numerous portraits and water-colour drawings.

Lectures.—In his series of Slade Lectures, delivered from 1875 to 1879, and first published in 1879 (republished, with additions, in 1897), Sir Edward Poynter deals with the whole subject of art education, considering in turn Decorative Art, Old and New Art, Systems of Art Education, Hints on the Formation of a Style, Training of Art Students, The Study of Nature, The Value of Things, Objects of Study, Professor Ruskin on Michelangelo (hotly controversial in tone), Influence of Art in Social Life, and Ancient Decorative Art.

See also Cosmo Monkhouse, "Sir E. J. Poynter, P.R.A.: His Life and Work," *Art Annual* (1897); M. H. Spielmann, "Sir E. J. Poynter, P.R.A., and his Studies," *The Magazine of Art* (1897).

POZHAREVATS (also written Passarowitz and Požarevac), a town in Servia, situated in the Morava valley, 4 m. E. of the Morava river and 8 m. S. of the Danube. The station for steamers, Dubravitsa, with its custom-house, standing on the banks of the Danube, forms practically the harbour of Pozharevats. The town has no special industry, but is the principal market of a very extensive and fruitful plain between the rivers Morava, Mlava and Danube. It is the capital of a department bearing the same name, and the seat of a prefecture, a tribunal of justice, a college and several national or normal schools. It has a large modern penitentiary, with a department for political offenders and a prison for women. Two miles to the west, towards Morava, is situated Lubichevo, a model farm and stud belonging to the government. The shady park and flower gardens are a popular resort of the people of Pozharevats. The town is known in the history of international treaties as the place at which the famous peace of Passarowitz between Austria and Turkey was concluded in 1718. Pop. (1900), 12,957.

Lignite is worked at Kostolats, 7 m. N. by E., and the hills between Pozharevats and Kostolats show many traces of Roman mines. A number of coins, sarcophagi and inscriptions found in the neighbourhood are also Roman.

POZOBLANCO, a town of southern Spain in the province of Cordova, near the head-waters of the Guadamatillas and of other small sub-tributaries of the Guadiana. Pop. (1900), 12,792. Pozoblanco is one of the chief towns in the lowlands of Los Pedroches, which lie between the Sierra de la Alcúdia on the north and the Sierra Morena on the south. Although there is no railway in the district, Pozoblanco has a thriving trade. Its fairs are famed for their exhibits of live stock and agricultural products. There are zinc and argentiferous lead mines in the neighbourhood, and manufactures of cloth and leather in the town itself.

POZZO DI BORGO, CARLO ANDREA, COUNT (1764-1842). Russian diplomatist, was born at Alata, near Ajaccio, of a noble Corsican family, on the 8th of March 1764, some four years before the cession of the island to France. He was educated

at Pisa, and in early life was closely associated with Napoleon and Joseph Bonaparte, the two families being at that time closely allied in politics. Pozzo was one of the two delegates sent to the National Assembly in Paris to demand the political incorporation of Corsica in France, and was subsequently one of the Corsican deputies to the Legislative Assembly, where he sat on the benches of the right until the events of August 1792. On his safe return to Corsica he was warmly received by Paoli, but found himself in opposition to the Bonaparte brothers, who were now veering to the Jacobin party. Under the new constitution Pozzo was elected *procureur-général-syndic*, that is, chief of the civil government, while Paoli commanded the army. With Paoli he refused to obey a summons to the bar of the Convention, and the definite breach with the Bonaparte family, who actively supported the revolutionary authorities, dates from this time. Eventually Paoli and Pozzo accepted foreign help, and from 1794 to 1796, during the English protectorate of Corsica, Pozzo was president of the council of state under Sir Gilbert Elliot. When Napoleon sent troops to occupy the island he was excepted from the general amnesty, and took refuge in Rome, but the French authorities demanded his expulsion, and gave orders for his arrest in northern Italy. After a short stay in London he accompanied in 1798 Sir Gilbert Elliot (now become Lord Minto) on an embassy to Vienna, where he lived for six years and was well received in political circles. Hatred of Napoleon was his dominant passion, and even as an exile of no official standing he was recognized as a dangerous enemy. In 1804 through the influence of Prince Adam Czartoryski he entered the Russian diplomatic service, and was employed in 1805 as Russian commissioner with the Anglo-Neapolitan, and in 1806 with the Prussian army. He was entrusted with an important mission to Constantinople in 1807, but the conclusion of the alliance between Alexander I. and Napoleon at Tilsit in July interrupted his career, necessitating a temporary retirement after the completion of his business with the Porte. He returned to Vienna, but on the demand of Napoleon for his extradition Metternich desired him to leave the capital. In London, where he found safety from Napoleon, he renewed many old ties, and remained in England until 1812, when he was recalled by Alexander. He diligently sought to sow dissension in the Bonaparte household, and in a mission to Sweden he secured the co-operation of Bernadotte against Napoleon. On the entry of the allies into Paris he became commissary general to the provisional government. At the Bourbon restoration General Pozzo di Borgo became Russian ambassador at the Tuileries, and sought to secure a marriage between the duke of Berry and the Russian grandduchess Anna, Alexander's sister. He assisted at the Congress of Vienna, and during the Hundred Days he joined Louis XVIII. in Belgium, where he was also instructed to discuss the situation with Wellington. The tsar dreamed of allowing an appeal to the people of France on the subject of the government of France in accordance with his vague liberalizing tendencies, but Pozzo's suggestions in this direction were met by violent opposition, the duke refusing to make any concessions to what he regarded as rebellion; but in Petersburg, on the other hand, his attachment to the Bourbon dynasty was considered excessive. During the early years of his residence in Paris Pozzo laboured tirelessly to lessen the burdens laid on France by the allies and to shorten the period of foreign occupation. That his French sympathies were recognized in Paris is shown by the strange suggestion that he should enter the French ministry with the portfolio of foreign affairs. He consistently supported the moderate party at court, and stood by the ministry of the duc de Richelieu, thus earning the distrust and dislike of Metternich, who held him responsible for the revival of Liberal agitation in France. His influence at the Tuileries declined with the accession of Charles X., whose reactionary tendencies had always been distasteful to him; but at the revolution of 1830, when the Tsar Nicholas was reluctant to acknowledge Louis Philippe, he did good service in preventing difficulties with Russia. In 1832 he visited Petersburg; the next year he was in London renewing

his relations with Wellington, and early in 1835 he was suddenly transferred to the London embassy in succession to Prince Lieven. Although he did not lose in official standing, Pozzo was aware that this change was due to suspicions long harboured in various quarters in St Petersburg that his diplomacy was too favourable to French interests. In London his health suffered, and he retired from the service in 1839 to spend the rest of his days in Paris, where he died on the 15th of February 1842. He had been made a count and peer of France in 1818.

See Ouvaroff, *Stein et Pozzo* (St Petersburg, 1846); *Correspondance diplomatique du comte Pozzo di Borgo et du comte de Nesselrode*, ed. by Charles Pozzo di Borgo (2 vols., Paris, 1890-1897); Vicomte A. Maggiolo, *Corse, France et Russie. Pozzo di Borgo, 1764-1842* (Paris, 1890); J.B.H.R. Capefigure, *Les Diplomates européens* (4 vols., 1843-1847).

POZZUOLI (anc. *Puteoli*, *q.v.*), a seaport and episcopal see of Campania, Italy, in the province of Naples, $7\frac{1}{2}$ m. W. of it by rail. Pop. (1906), 17,017 (town); 22,838 (commune). It is situated on and at the base of a hill projecting into the bay at Pozzuoli, separated from the main portion of the Gulf of Naples by the promontory of Posilipo. Its mineral baths are frequented in summer; and the volcanic *pozzolana* earth (also found near Rome), used now as in Roman times for making cement and concrete, derives its name from the place. In the middle ages Pozzuoli was frequently sacked and also damaged by the natural convulsions of 1108 and 1538. To the north-east of the town is the Solfatura, a half extinct volcano crater, in which sulphurous gases are exhaled.

PRABHU, the writer caste of Western India, corresponding to the Kayasth of Bengal. Though numbering only 21,941 in Bombay in 1901, they occupy a very high position socially and in the professions. The first Indian to be appointed to the executive council at Bombay was a Prabhu, of the well-known Chaubal family.

PRADIER, JAMES (1792-1862), French sculptor, was born at Geneva. He was a member of the French Academy, and a popular sculptor of the pre-Romantic period, representing in France the drawing-room classicism which Canova illustrated at Rome. His chief works are the Niobe group (1822), "Atalanta" (1850), "Psyche" (1824), "Sappho" (1852) (all in the Louvre), "Prometheus" (Tuileries Gardens), a bas-relief on the triumphal arch of the Carrousel, the figures of "Fame" on the Arc de l'Étoile, and a statue of J. J. Rousseau for Geneva. Besides these mention should be made of his "Three Graces" (1821).

PRADILLA, FRANCISCO (1847-), Spanish painter, was born at Villanueva da Gallago (Saragossa). Having studied first at the Fernando Academy, and then at the Spanish Academy in Rome, of which he was afterwards director, he became the leading historical painter of modern Spain. In 1896 he was appointed director of the Madrid Museum. Though he is best known for such large historical compositions as "Joan the Mad" (gold medal, Paris, 1878), and "The Surrender of Granada" (gold medal, Munich, 1883), in which he discarded the heavy colouring of Laurens for a lighter and more atmospheric key, he has painted many excellent genre pictures in the manner of Fortuny, and some decorative compositions in which he follows the example of Tiepolo. The best of these are his decorations in the Murgo Palace in Madrid. Among his best known works are "Elopement," "Strand at Vigo," "Procession in Venice," "La Fiorella," "Reading on the Balcony," "Don Alfonso the Warrior," and "Don Alfonso the Scholar." He became member of the Berlin Academy in 1892.

PRAED, WINTHROP MACKWORTH (1802-1839), English poet, was born in London on the 26th of July 1802. The old family name was Mackworth, the additional name of Praed being derived from the marriage of the poet's great grandfather with a Cornish heiress. His father, William Mackworth Praed, was a serjeant-at-law. His mother belonged to the English branch of the New England family of Winthrop. In 1814 Praed was sent to Eton College. He there founded a manuscript periodical called *Apis matina*. This was succeeded in October 1820 by the *Etonian*, a paper projected and

edited by Praed and Walter Blount, which appeared every month until July 1821, when the chief editor, who signed his contributions "Peregrine Courtenay," left Eton, and the paper died. Henry Nelson Coleridge, William Sidney Walker, and John Moultrie were the three best known of his coadjutors in this periodical, which was published by Charles Knight, and of which many interesting particulars are given in Knight's *Autobiography* and in Maxwell Lyte's *Eton College*. Before Praed left school he succeeded in establishing over a shop at Eton a "boys' library," the books of which are now amalgamated in the School Library. His career at Cambridge, where he matriculated at Trinity College, October 1821, was marked by exceptional brilliancy. He gained the Browne medal for Greek verse four times, and twice the chancellor's medal for English verse. He was bracketed third in the classical tripos in 1825, won a fellowship at his college in 1827, and three years later carried off the Seatonian prize. At the Union his speeches were only rivalled by those of Macaulay and of Charles Austin (1799-1874), who subsequently made a great reputation at the parliamentary bar. The character of Praed during his university life is described by Bulwer Lytton in the first volume of his *Life*. He began to study law, and in 1829 was called to the bar at the Middle Temple. He went the Norfolk circuit, where his prospects of advancement were bright, but the bias of his feelings inclined him towards politics, and after a year or two he devoted himself entirely to political life. Whilst at Cambridge he leaned to Whiggism, and even to the autumn of 1829 his feelings were bent towards the same side, but during the agitation for parliamentary reform his opinions changed, and when he was returned to parliament for St Germans (Dec. 17, 1830) his election was due to the Tory party. He sat for that borough until December 1832, and on its extinction contested the borough of St Ives, within the limits of which the Cornish estates of the Praeds were situated. The squibs which he wrote on this occasion were collected in a volume printed at Penzance in 1833 and entitled *Trash, dedicated without respect to James Halse, Esq., M.P.*, his successful competitor. Praed sat for Great Yarmouth from 1835 to 1837, and was secretary to the Board of Control during Sir Robert Peel's short administration. He sat for Aylesbury from 1837 until his death. During the progress of the Reform Bill he advocated the creation of three-cornered constituencies, in which each voter should have the power of giving two votes only, and maintained that freeholds within boroughs should confer votes for the boroughs and not for the county. Neither of these suggestions was then adopted, but the former ultimately formed part of the Reform Bill of 1866. He married in 1835 Helen Bogle. He died of consumption at Chester Square, London, on the 15th of July 1839.

Praed's lighter poetry was the perfection of ease. Mr Austin Dobson has justly praised his "sparkling wit, the clearness and finish of his style, and the flexibility and unflagging vivacity of his rhythm" (Ward's *English Poets*). It abounded in happy allusions to the characters and follies of the day. In his humorous effusions he found numerous imitators.

His poems were first edited by R. W. Griswold (New York, 1844); another American edition, by W. A. Whitmore, appeared in 1859; an authorized edition with a memoir by Derwent Coleridge appeared in 1864: *The Political and Occasional Poems of W. M. Praed* (1888), edited with notes by his nephew, Sir George Young, included many pieces collected from various newspapers and periodicals. Sir George Young separated from his work some poems, the work of his friend Edward Marlborough Fitzgerald, generally confused with his. Praed's essays, contributed to various magazines, were published in Morley's *Universal Library* in 1887.

PRAEFECT (*praefectus*), the title of various Roman officials, both civil and military. A praefect was not one of the magistrates proper; he was, strictly speaking, only the deputy or lieutenant of a superior magistrate or commander. The following were the most important.

1. The city praefect (*praefectus urbis*) acted at Rome as the deputy of the chief magistrate or magistrates during his or their absence from the city. Thus he represented in the earliest

times the king and in later times the consul or consuls when he or they were absent on a campaign or on other public duties, such as the celebration of the annual Latin festival on the Alban Mount. The absence of the chief magistrate for more than a single day rendered the appointment of a praefect obligatory; but the obligation only arose when *all* the higher magistrates were absent. Hence so long as the consuls were the only higher magistrates their frequent absence often rendered the appointment of a praefect necessary, but after the institution of the praetorship (367 B.C.) the necessity only arose exceptionally, as it rarely happened that both the consuls and the praetor were absent simultaneously. But a praefect continued to be regularly appointed, even under the empire, during *Praefectus* the enforced absence of all the higher magistrates *Urbis* at the Latin festival. The right and duty of appointing a praefect belonged to the magistrate (king, *Feriarum Latinarum*-dictator or consul) whose deputy he was, but it seems to have been withdrawn from the consuls by the Licinian law (367), except that they still nominated praefects for the time of the festival. No formalities in the appointment and no legal qualifications on the part of the praefect were required. The praefect had all the powers of the magistrate whose deputy he was, except that he could not nominate a deputy to himself. His office expired on the return of his superior. There could only be one city praefect at a time, though the dictator Caesar broke the rule by appointing six or eight praefects simultaneously.

Under the empire there was introduced a city prefecture which differed essentially from the above. Augustus occasionally appointed a city praefect to represent him in his absence from Italy, although the praetors, or even one of the consuls, remained in the capital. In the absence of Tiberius from Rome during the last eleven years of his reign (A.D. 26-37) the city prefecture, hitherto an exceptional and temporary office, became a regular and permanent magistracy; in all subsequent reigns the praefect held office even during the presence of the emperor in Rome. He was always chosen by the emperor and usually from men who had held the consulship; his office was regarded, like the censorship under the republic, as the crowning honour of a long political career. It was not conferred for any definite length of time, but might be held for years or for life. As under the republic, the praefect was not allowed to quit the city for more than a day at a time. His duty was the preservation of peace in the capital; he was, in fact, the chief of the police, being charged with the superintendence of the streets, markets and public buildings. He was further entrusted by Augustus with a summary criminal jurisdiction over slaves and rioters, which was, however, gradually extended till in the time of Severus or even earlier it embraced all offences by whomsoever committed. Further, he had the power of dealing with civil cases where his interference seemed requisite in the interests of the public safety, but such occasions were naturally few. By the beginning of the 3rd century, and perhaps earlier, appeals to the emperor in civil cases were handed over by him to be dealt with by the praefect. Except where special restrictions interfered, an appeal lay from the praefect to the emperor. Though not a military officer, the praefect commanded the city cohorts (*cohortes urbanae*), which formed part of the garrison of Rome and ranked above the line regiments, though below the guards (see **PRAETORIANS**). The military power thus placed in the hands of the chief of the police was one of the most sorely-felt innovations of the empire. The constitutional changes of Diocletian and Constantine extended still further the power of the praefect, in whom, after the disbanding of the guards and the removal from Rome of the highest officials, the whole military, administrative and judicial powers were centred.

2. Under the republic judicial praefects (*praefecti jure dicendo*) were sent annually from Rome as deputies of the praetors to administer justice in certain towns of the Italian allies. These towns were called prefectures (*praefecturae*). After the Social War (90-89 B.C.), when all Italy had received the Roman

franchise, such prefectures ceased to exist in fact, though the name was sometimes retained.

3. Under the empire the praetorians or imperial guards were commanded by one, two, or even three praefects (*praefecti praetorio*), who were chosen by the emperor from among the knights and held office at his pleasure. From the time of Alexander Severus the post was open to senators also, and if a knight was appointed he was at the same time raised to the senate. Down to the time of Constantine, who deprived the office of its military character, the prefecture of the guards was regularly held by tried soldiers, often by men who had fought their way up from the ranks. In course of time the command seems to have been enlarged so as to include all the troops in Italy except the corps commanded by the city praefect (*cohortes urbanae*). Further, the praetorian praefect acquired, in addition to his military functions, a criminal jurisdiction, which he exercised not as the delegate but as the representative of the emperor, and hence it was decreed by Constantine (331) that from the sentence of the praetorian praefect there should be no appeal. A similar jurisdiction in civil cases was acquired by him not later than the time of Severus. Hence a knowledge of law became a qualification for the post, which under Marcus Antoninus and Commodus, but especially from the time of Severus, was held by the first jurists of the age, (e.g. Papinian, Ulpian and Paullus), while the military qualification fell more and more into the background. Under Constantine the institution of the *magistri militum* deprived the praetorian prefecture altogether of its military character, but left it the highest civil office of the empire.

The title of "praefect" was borne by various other Roman officials, of whom we may mention the following:—

4. *Praefectus Socium (sociorum)*.—Under the republic the contingents furnished to the Roman armies by the Italian allies were commanded by Roman officers called *praefecti socium (sociorum)*, who were nominated by the consuls and corresponded to the tribunes in the legions.

5. *Praefectus Classium*.—Down to near the close of the republic a naval command was never held independently but only in connexion with the command of an army, and, when the general appointed an officer to command the fleet in his room, this lieutenant was styled "praefect of the fleet" (*praefectus classium*). When in 311 B.C. the people took the appointment of these lieutenants into their own hands the title was changed from "praefects" to *duo viri navales*, or "two naval men"; but under the empire the admirals went by their old name of praefects.

6. *Praefectus Fabrum*.—The colonel of the engineer and artillery corps (*fabri*) in a Roman army was called a praefect; he did not belong to the legion, but was directly subordinate to the general in command.

7. *Praefectus Annonae*.—The important duty of provisioning Rome was committed by Augustus (between A.D. 8 and 14) to a praefect, who was appointed by the emperor from among the knights and held office at the imperial pleasure.

8. *Praefectus Aegypti* (afterwards *Praefectus augustalis*).—Under the empire the government of Egypt was entrusted to a viceroy with the title of "praefect," who was selected from the knights, and was surrounded by royal pomp instead of the usual insignia of a Roman magistrate. He stood under the immediate orders of the emperor. The exceptional position thus accorded to Egypt was due to a regard on the part of the emperors to the peculiar character of the population, the strategic strength of the country, and its political importance as the granary of Rome. (J. G. Fr.)

9. *Praefectus Castrorum*, from the time of Augustus to Severus the title of the commander of the fixed camps of the legions in different parts of the empire. He was a purely military man appointed by the emperor, usually a centurion whose term of service was completed. From the time of Domitian, when each legion had a separate camp, the name of the legion was added to the title, e.g. *praefectus castrorum legionis xiii. gem.* (C.I.L. iii. 454). The duties of this officer included: the arrangement of the camp and medical service, the transport of the baggage, the construction of roads, bridges and fortifications, the supply of ammunition and engines of war.

10. *Praefectus Vigilum*, the commander of the seven *cohortes vigilum*, a night police force instituted by Augustus (A.D. 6). To each cohort, consisting of about 1000 men (chiefly freedmen), was entrusted the care of two of the fourteen city districts; one of its chief duties was that of a fire brigade. The policing of the city had formerly been one of the duties of the aediles, but was now transferred to the praefectus vigilum, appointed by the emperor from the equites. He exercised criminal jurisdiction in cases of incendiarism and offences committed against the law during the night, and in later times this jurisdiction was considerably extended.

The different kinds of praefects are fully discussed in Mommsen, *Römisches Staatsrecht* (1887) vols. ii., iii.; see also T. M. Taylor, *Constitutional and Political History of Rome* (1899). There is an excellent monograph on the *Praefectura urbis* by P. E. Vigneaux (1896). Mommsen deals very cursorily with the *praefectus castrorum*, but there is a special article by G. Wilmanns, in *Ephemeris epigraphica* (1872), vol. i., "De praefecto castrorum et praefecto legionis."

For the French *préfet* see PREFECT.

(X.)

PRAEMUNIRE (Lat. *praemonere*, to pre-admonish or forewarn), in English law an offence so called from the introductory words of the writ of summons issued to the defendant to answer the charge, "Praemunire facias A.B.," &c., i.e. "cause A.B. to be forewarned." From this the word came to be used to denote the offences, usually ecclesiastical, prosecuted by means of such a writ, and also the penalties they incurred. The statute of Richard II., Purchasing bulls from Rome (1392), is usually designated the Statute of Praemunire, but it is only one of numerous stringent measures (some still unrepealed, and, as a body, of the most confused character) passed for the purpose of putting restraint on the papal usurpation of authority in England. From the beginning of the 14th century papal aggression had been particularly active, more especially in two forms. The one, the disposal of ecclesiastical benefices, before the same became vacant, to men of the pope's own choosing; the other, the encouragement of resort to himself and his curia rather than to the courts of the country. The Statute of Provisors 1306, passed in the reign of Edward I., was, according to Coke, the foundation of all subsequent statutes of praemunire. This statute enacted "that no tax imposed by any religious persons should be sent out of the country whether under the name of a rent, tallage, tribute or any kind of imposition." A much greater check on the freedom of action of the popes was imposed by the Statute of Provisors (1350-1351) and the Statute of Praemunire passed in the reign of Edward III. The former of these, after premising "that the Pope of Rome, accroaching to him the seignories of possession and benefices of the holy Church of the realm of England doth give and grant the same benefices to aliens which did never dwell in England, and to cardinals, which might not dwell here, and to others as well aliens as denizens, as if he had been patron or advowee of the said dignities and benefices, as he was not of right by the laws of England . . .," ordained the free election of all dignities and benefices elective in the manner as they were granted by the king's progenitors. The Statute of Praemunire (the first statute so called) 1353, though expressly levelled at the pretensions of the Roman curia, excludes any direct reference to it in actual words. By it, the king "at the grievous and clamorous complaints of the great men and commons of the realm of England" enacts "that all the people of the king's ligeance of what condition that they be, which shall draw any out of the realm in plea" or any matter of which the cognizance properly belongs to the king's court shall be allowed two months in which to answer for their contempt of the king's rights in transferring their pleas abroad. The penalties which were attached to the offence under this statute involved the loss of all civil rights, forfeiture of lands, goods and chattels, and imprisonment during the royal pleasure.

Many other statutes followed that of 1353, but that passed in the sixteenth year of Richard II.'s reign is, as mentioned before, usually referred to as the Statute of Praemunire. This statute, after first stating "that the right of recovering the presentments to churches, prebends, and other benefices . . . belongeth only to the king's court of the old right of his crown, used and approved in the time of all his progenitors kings of England," proceeds to condemn the practice of papal translation, and after rehearsing the promise of the three estates of the realm to stand with the king in all cases touching his crown and his regalty, enacts "that if any purchase or pursue, or cause to be purchased or pursued in the court of Rome, or elsewhere, any such translations, processes, and sentences of excommunications, bulls, instruments or any other things whatsoever . . . he and his notaries, abettors and counsellors" shall be put out of the king's protection, and their lands,

tenements, goods and chattels forfeit to the king, and they shall be attached by their bodies or process made against them by *praemunire facias*. This statute, says Stubbs, was one of the strongest defensive measures taken during the middle ages against Rome and was called for by the conduct of the pope, who had forbidden the bishops to execute the sentences of the royal courts in suits connected with ecclesiastical patronage. The last ancient statute concerning praemunire, until the Reformation, was an extension in the reign of Henry IV. (1400) of the Statute of Provisors, by which all persons who accepted any provision from the pope to be exempt from canonical obedience to their proper ordinary were subjected to the penalties prescribed. The range and description of offences subject to the penalties of praemunire were greatly widened after the Reformation, so that acts of a very miscellaneous character were from time to time brought within the scope of enactments passed for a very different purpose. For instance, the penalties of praemunire were incurred, under an act of Queen Elizabeth (1571), for denying the Queen's title; and under an act of James I. the Statute of Monopolies (1623), for obtaining any stay of proceedings (other than by arrest of judgment or a writ of error) in any suit for a monopoly; under an act of Charles I. (1640) the attempting to restrain the importation or making of gunpowder was a praemunire; in the reign of Charles II. an act of 1661 made the asserting maliciously and advisedly, by speaking or writing, that both or either house of parliament has a legislative authority without the king, a praemunire. In the same reign, the Habeas Corpus Act 1679 made the committing of any man to prison out of the realm a praemunire, unpardonable even by the king. It thus appears that while the Crown by its prerogative might at any time remit the whole or any part of the punishment incurred by a praemunire, an exception was made in transgressions of the Statute of Habeas Corpus.¹ An act of William III. (1695) made serjeants, counsellors, proctors, attorneys, and all officers of courts practising without having taken the proper oaths guilty of a praemunire. By the Succession to the Crown Act 1707, verbally to assert the rights of a person to the Crown contrary to the Acts of Settlement and Union is praemunire (to do so by writing or printing is treason). The Royal Marriages Act 1772 is the last statute which subjects anyone to the penalties of a praemunire. A peer charged with praemunire is not entitled to trial by his peers, but is to be tried by a jury. The most famous historical instance of a prosecution of the Statute of Praemunire was that of Cardinal Wolsey in 1529.

AUTHORITIES.—*Statutes of the Realm*; Coke, *Institutes*; Collier, *Ecclesiastical History*; Hallam, *Middle Ages*; Reeves' *History of English Law*; Stephen's *Commentaries on the Laws of England*; Sir J. Stephen's *History of Criminal Law*; Sir T. E. Tomlin's *Law Dictionary*; Stubbs, *Constitutional History*. (T. A. I.)

PRAENESTE (mod. Palestrina), a very ancient city of Latium, lies 23 m. E. of Rome by the Via Praenestina (see below), on a spur of the Apennines facing the Alban Hills. To the natural strength of the place and its commanding situation Praeneste owed in large measure its historical importance. There are various legends as to its foundation. Objects in metal and ivory discovered in the earliest graves prove that as early as the 8th or 7th century B.C. Praeneste had reached a considerable degree of civilization and stood in commercial relations not only with Etruria but with the East. At this time the city was probably under the hegemony of Alba Longa, then the head of the Latin League. In 499 B.C., according to Livy, Praeneste withdrew from the Latin League, in the list of whose members given by Dionysius (v. 61) it occurs, and formed an alliance with Rome. After Rome had been weakened by the Gallic invasion (390) Praeneste joined its foes in a long struggle with Rome. The struggle culminated in the great Latin War (340-38), in which the Romans were victorious, and Praeneste was punished for

its share in the war by the loss of part of its territory. It was not, however, like most other Latin cities, embodied in the Roman state, but continued in the position of a city in alliance with Rome down to the Social War, when it received the Roman franchise (in 90 B.C., probably as one of those cities which had not rebelled or had laid down their arms at once), which in 215 B.C. some of its citizens—who had bravely held Casilinum against Hannibal, and only surrendered when pressed by hunger—had refused to accept.

As an allied city it furnished contingents to the Roman army and possessed the right of exile (*jus exilii*), i.e. persons banished from Rome were allowed to reside at Praeneste. To judge from the works of art and inscriptions of this period (338 to 90 B.C.), it must have been for the place a time of prosperity, and even luxury. The nuts of Praeneste were famous and its roses were amongst the finest in Italy. The Latin spoken at Praeneste was somewhat peculiar,² and was ridiculed to some extent by the Romans. In the civil wars of Sulla the younger Marius was blockaded in the town by the Sullans (82 B.C.); and on its capture Marius slew himself, the male inhabitants were massacred in cold blood, and a military colony was settled on part of its territory, though, possibly owing to the extravagance of the new *coloni*, we find that in 63 B.C. this was already in the possession of large proprietors. It was probably in 82 B.C. that the city was removed from the hill-side to the lower ground at the Madonna dell' Aquila, and that the temple of Fortune was enlarged so as to include much of the space occupied by the ancient city. From an inscription found in 1907 it appears that Sulla delegated the foundation of the new colony to M. Terentius Varro Lucullus, who was consul in 73 B.C. Under the empire Praeneste, from its elevated situation and cool salubrious air, became a favourite summer resort of the wealthy Romans, whose villas studded the neighbourhood. Horace ranked it with Tibur and Baiae, though as a fact it never became so fashionable a residence as Tibur or the Alban Hills. Still, Augustus resorted thither; here Tiberius recovered from a dangerous illness, and here Hadrian probably built himself a villa. Marcus Aurelius also had a villa here. Amongst private persons who owned villas at Praeneste were Pliny the younger and Symmachus. Inscriptions show that the inhabitants of Praeneste were especially fond of gladiatorial shows.

But Praeneste was chiefly famed for its great temple of Fortune and for its oracle, in connexion with the temple, known as the "Praenestine lots" (*sortes praenestinae*). The oldest portion of the sanctuary was, however, that situated on the lowest terrace but one. Here is a grotto in the natural rock, containing a beautiful coloured mosaic pavement, representing a sea-scene—a temple of Poseidon on the shore, with various fish swimming in the sea. To the east of this is a large space, now open, but once very possibly roofed, and forming a basilica in two storeys, built against the rock on the north side, and there decorated with pilasters also; and to the east again is an apsidal hall, often identified with the temple itself, in which the famous mosaic with scenes from the Nile, now in the Palazzo Barberini on the uppermost terrace, was found. Under this hall is a chamber, which, as an inscription on its walls shows, served as a treasury in the 2nd century B.C. In front of this temple an obelisk was erected in the reign of Claudius, fragments of which still exist. The modern cathedral, just below the level of this temple, occupies the civil basilica of the town, upon the façade of which was a sun-dial, described by Varro (traces of which may still be seen). In the modern piazza the steps leading up to this latter basilica and the base of a large monument were found in 1907; so that only a part of the piazza represents the ancient forum. As extended by Sulla the sanctuary of Fortune occupied a series of five vast terraces, which, resting on gigantic

² Thus the Praenestines shortened some words: they said *conia* for *ciconia*, *tammodo* for *tantummodo* (Plaut. *Truc.* iii. 2, 23; Id. *Trinum.* iii. 1, 8; cf. Comment. on Festus, p. 731, ed. Lindemann), and inscriptions exhibit the forms *Acmemeno* and *Tondrus* for *Agamemno* and *Tyndarus*. They said *nefrones* for *nefrendes* in the sense of *testiculi* and *tongilio* for *notio* (Festus, s.v. "nefrendes" and "tongere"). Cf. Quintilian, *Instit.* i. 5, 56.

¹ Sir T. E. Tomlins says that there is only one instance of a prosecution on a praemunire to be found in the state trials, in which case the penalties were inflicted upon some persons for refusing to take the oath of allegiance to Charles II.

substructions of masonry and connected with each other by grand staircases, rose one above the other on the hill in the form of the side of a pyramid, crowned on the highest terrace by the round temple of Fortune. This immense edifice, probably by far the largest sanctuary in Italy, must have presented a most imposing aspect, visible as it was from a great part of Latium, from Rome, and even from the sea. The ground at the foot of the lowest terrace is 1476 ft. above sea-level; here is a cistern, divided into ten large chambers, in brick-faced concrete. The goddess Fortuna here went by the name of Primigenia (First-Born, but perhaps in an active sense First-Bearer); she was represented suckling two babes, said to be Jupiter and Juno, and she was especially worshipped by matrons. The oracle continued to be consulted down to Christian times, until Constantine, and again later Theodosius, forbade the practice and closed the temple. A bishop of Praeneste is first mentioned in A.D. 313. In 1297 the Colonna family, who then owned Praeneste (Palestrina), revolted from the pope, but in the following year the town was taken and razed to the ground. In 1437 the city, which had been rebuilt, was captured by the papal general Cardinal Vitelleschi and once more utterly destroyed. It was rebuilt and fortified by Stefano Colonna in 1448. In 1630 it passed by purchase into the Barberini family. Praeneste was the native town of Aelian, and in modern times of the great composer (Giovanni) Pierluigi da Palestrina.

The modern town of Palestrina, a collection of narrow and filthy alleys, stands on the terraces once occupied by the temple of Fortune. On the summit of the hill (2471 ft.), nearly a mile from the town, stood the ancient citadel, the site of which is now occupied by a few poor houses (Castel San Pietro) and a ruined medieval castle of the Colonna. The magnificent view embraces Soracte, Rome, the Alban Hills and the Campagna as far as the sea. Considerable portions of the southern wall of the ancient citadel, built in very massive Cyclopean masonry of blocks of limestone, are still to be seen; and the two walls, also polygonal, which formerly united the citadel with the town, can still be traced. The ruins of the villa attributed to Hadrian stand in the plain near the church of S. Maria della Villa, about three-quarters of a mile from the town. Here was discovered the Braschi Antinoüs, now in the Vatican. The calendar, which, as Suetonius tells us, was set up by the grammarian, M. Verrius Flaccus in the forum of Praeneste (the reference being to the forum of the imperial period, at the Madonna dell' Aquila), was discovered in the ruins of the church of S. Agapitus in 1771, where it has been used as building material (C. Hülsen in *Corp. inscr. lat.* 2nd ed. i. 230). Excavations made, especially since 1855, in the ancient necropolis, which lay on a plateau surrounded by valleys at the foot of the hill, and of the town, have yielded important results for the history of the art and manufactures of Praeneste. Of the objects found in the oldest graves, and supposed to date from about the 7th century B.C., the cups of silver and silver-gilt and most of the gold and amber jewelry are Phoenician (possibly Carthaginian), or at least made on Phoenician models; but the bronzes and some of the ivory articles seem to be Etruscan. No objects have been discovered belonging to the period intermediate between the 7th and 3rd centuries B.C.; but "from about 250 B.C. onwards we have a series of Praenestine graves surmounted by the characteristic 'pine-apple' of local stone, containing stone coffins with rich bronze, ivory and gold ornaments beside the skeleton. From these come the bronze *cistae* and *specula* with partly (but far from wholly) Etruscan inscriptions, for which Praeneste is renowned" (Conway, *Ital. Dial.*). Among these is the famous Ficoroni casket, engraved with pictures of the arrival of the Argonauts in Bithynia and the victory of Pollux over Amycus. It was found in 1738. "The caskets are unique in Italy, but a large number of mirrors of precisely similar style have been discovered in Etruria and are published in full by the German Archaeological School at Rome; *Etruskische Spiegel*, vol. v. sqq. (Berlin, 1884). Hence, although a priori it would be reasonable to conjecture that objects with Etruscan characteristics came from Etruria, the evidence, positive and negative, points decisively to an Etruscan factory in or near Praeneste itself" (Conway, *ibid.*). Most of the objects discovered in the necropolis are preserved in the Roman collections, especially in the Kircherian Museum (which possesses the Ficoroni casket) and the Barberini library.

See E. Fernique, *Prêneste* (Bibliothèque des Écoles Françaises, fasc. 17, Paris, 1880); H. Dessau in *Corp. inscr. lat.* xiv. 288 sqq.; *Corp. inscr. etrusc.* vol. ii.; O. Marucchi, *Guida archeologica dell' antica Prêneste* (Rome, 1885), and in *Bullettino comunale* (1904), 233 sqq.; R. S. Conway, *Italic Dialects*, i. 311 sqq. (Cambridge, 1897); T. Ashby in *Papers of the British School at Rome*, i. 132 sqq.; R. Delbrück, *Hellenistische Bauten in Latium*, p. 47 sqq. (Berlin, 1907); *Notizie degli Scavi, passim*; and especially D. Vaglieri (1907), p. 132, &c.; R. van Deman Magoffin, *Topography and Municipal History of*

Praeneste (Johns Hopkins University Studies, xxvi. 9, 10); (Baltimore, 1908). (J. G. Fr.; R. S. C.; T. As.)

PRAENESTINA, VIA. an ancient road of Italy, leading from Rome E. by S. to Praeneste, a distance of 23 m., Gabii being situated almost exactly half-way. At the ninth mile the road crosses a ravine by the well-preserved and lofty Ponte di Nona, with seven arches, the finest ancient bridge in the neighbourhood of Rome. The line of the road is, considering the difficulty of the country beyond Gabii, very straight. In the stretch beyond Gabii it is only used as a track, and well preserved. Half-way between Gabii and Praeneste is the well-preserved single-arched bridge, known as Ponte Amato.

See T. Ashby in *Papers of the British School at Rome*, i. 149 sqq. (T. As.)

PRAETOR (Lat. *prae-itor*, "he who goes before," "a leader"), originally a military title, was in classical times the designation of the highest magistrates in the Latin towns. The Roman consuls were at first called praetors; in the early code of the Twelve Tables (450 B.C.) they appear to have had no other title. By the Licinian law of 367, which abolished the military tribunes with consular power and enacted that the supreme executive should henceforward be in the hands of the two consuls, a new magistrate was at the same time created who was to be a colleague of the consuls, though with lower rank and lesser powers. This new magistrate was entrusted with the exclusive jurisdiction in civil cases; in other respects his powers resembled those of the consuls. His distinctive title was the city praetor (*praetor urbanus*), and in aftertime, when the number of praetors was increased, the city praetor always ranked first. To this new magistrate the title of "praetor" was thenceforward properly restricted.¹ About 242 the increase of a foreign population in Rome necessitated the creation of a second praetor for the decision of suits between foreigners (*peregrini*) or between citizens and foreigners. This praetor was known at a later time as the "foreign praetor" (*praetor peregrinus*).² About 227 two more praetors were added to administer the recently acquired provinces of Sicily and Sardinia. The conquest of Spain occasioned the appointment of two more in 197, of whom one governed Hither and the other Further Spain. The number of praetors, thus augmented to six, remained stationary till Sulla's time (82). But in the interval their duties vastly multiplied. On the one hand, five new provinces were added to the Roman dominions—Macedonia and Achaia in 146, Africa in the same year, Asia in 134, Gallia Narbonensis in 118, Cilicia probably in 102. On the other hand, new and permanent jury courts (*quaestiones perpetuae*) were instituted at Rome, over which the praetors were called on to preside. To meet this increase of business the tenure of office of the praetors and also of the consuls was practically prolonged from one to two years, with the distinction that in their second year of office they bore the titles of propraetor and proconsul instead of praetor and consul. The prolongation of office, together with the participation of the proconsuls in duties which properly fell to the praetors, formed the basis of Sulla's arrangements. He increased the number of the praetors from six to eight, and ordained that henceforward all the eight should in their first year administer justice at Rome and in their second should as propraetors undertake the government of provinces. The courts over which the praetors presided, in addition to those of the city praetor and the foreign praetor, dealt with the following offences: oppression of the provincials by governors (*repetundarum*), bribery (*ambitus*), embezzlement (*peculatus*), treason (*majestatis*), murder (*de sicariis et veneficis*), and probably forgery (*falsi*). A tenth province

¹ Some writers, following Livy vi. 42, assert that at first the praetorship was open to patricians only, but Mommsen (*Röm. Staatsrecht* ii. 195 [204]) shows that this is probably a mistake. The election of a plebeian to the office for the first time in 337 was certainly opposed by the consul who presided at the election, but there appears to have been no legal obstacle to it.

² [His official title in republican times was *Praetor qui inter peregrinos jus dicit*, under the empire *Praetor qui inter cives peregrinos jus dicit*, until the time of Vespasian, when the abbreviated title *praetor peregrinus* came into use.]

(Gallia cisalpina) was added to the previous nine, and thus the number of judicial and provincial departments corresponded to the annual number of praetors, propraetors and proconsuls. The proportion, however, was not long maintained: new provinces were added to the empire—Bithynia in 74, Cyrene about the same time, Crete in 67, Syria in 64—and one or more new law courts were instituted. To keep pace with the increase of duties Julius Caesar increased the number of praetors successively to ten, fourteen and sixteen; after his time the number varied from eight to eighteen.

The praetors were elected, like the consuls, by the people assembled in the *comitia centuriata* and with the same formalities.¹ They regularly held office for a year; only in the transition period between the republic and the empire was their tenure of office sometimes limited to a few months.² The insignia of the praetor were those common to the higher Roman magistrates—the purple-edged robe (*toga praelecta*) and the ivory chair (*sella curulis*); in Rome he was attended by two lictors, in the provinces by six. The praetors elect cast lots to determine the department which each of them should administer. A praetor was essentially a civil judge, and as such he was accustomed at or before his entry on office to publish an edict setting forth the rules of law and procedure by which he intended to be guided in his decisions. As these rules were often accepted by his successors, the praetor thus acquired an almost legislative power, and his edicts, thus continued, corrected and amplified from year to year, became, under the title of the “perpetual” edicts, one of the most important factors in moulding Roman law. Their tendency was to smooth away the occasional harshness and anomalies of the civil law by substituting rules of equity for the letter of the law, and in this respect the Roman praetor has been compared to the English chancellor. His functions were considerably modified by the introduction of the standing jury courts (*quaestiones perpetuae*). Hitherto the praetor had conducted the preliminary inquiry as to whether an action would lie, and had appointed for the actual trial of the case a deputy, whom he instructed in the law applicable to the case and whose decisions he enforced. The proceedings before the praetor were technically known as *ius* in distinction from *iudicium*, which was the actual trial before the deputy judge. But in the standing jury courts (of which the first—that for *repetundae*—was instituted in 149), or rather in the most important of them, the praetors themselves presided and tried the cases. These new courts, though formally civil, were substantially criminal courts; and thus a criminal jurisdiction was added to the original civil jurisdiction of the praetors. Under the empire various special functions were assigned to certain praetors, such as the two treasury praetors (*praetores aerarum*),³ appointed by Augustus in 23; the spear praetor (*praetor hastarius*), who presided over the court of the Hundred Men, which dealt especially with cases of inheritance; the two trust praetors (*praetores fideicommissarii*), appointed by Claudius to look after cases of trust estates, but reduced by Titus to one; the ward praetor (*praetor tutelaris*), appointed by Marcus Aurelius to deal with the affairs of minors; and the liberation praetor (*praetor de liberalibus causis*), who tried cases turning on the liberation of slaves.⁴ There is no evidence that the praetors continued to preside over the standing courts after the beginning of the 3rd century A.D., and the foreign praetorship disappears about this time.⁵ Even the jurisdiction of the city praetor seems not to have survived the reforms of Diocletian, though the office itself continued to exist. But of the praetorships with special jurisdiction (especially the ward praetorship and the liberation

¹ [Until the time of Tiberius, when their election was transferred to the Senate.]

² [The age for the office was forty under the republic, thirty under the empire.]

³ [They took the place of the quaestors; this arrangement continued till the time of Claudius.]

⁴ [The fiscal praetor (*praetor fiscalis*) was appointed by Nerva to hear claims preferred against the imperial fiscus.]

⁵ Marquardt conjectures with much probability that when Caracalla extended the Roman franchise to the whole empire he at the same time abolished the foreign praetorship.

praetorship) some lasted into the 4th century and were copied in the constitution of Constantinople.

Besides their judicial functions, the praetors, as colleagues of the consuls, possessed, though in a less degree, all the consular powers, which they regularly exercised in the absence of the consuls; but in the presence of a consul they exercised them only at the special command either of the consul or, more usually, of the senate. Thus the praetor possessed military power (*imperium*); even the city praetor, though attached by his office to Rome, could not only levy troops but also in certain circumstances take the command in person. As provincial governors the praetors had frequent occasion to exercise their military powers, and they were often accorded a triumph. The city praetor presided over popular assemblies for the election of certain inferior magistrates, but all the praetors officiating in Rome had the right to summon assemblies for the purpose of legislation. In the absence of the consuls the city praetor, and in default of him the other praetors, were empowered to call meetings of the senate. Public religious duties, such as the fulfilment of state vows, the celebration of sacrifices and games, and the fixing of the dates of movable feasts, probably only fell to the praetors in the absence of the consuls. But since in the early times the consuls as a rule spent only the first months of their year of office in Rome, it is probable that a considerable share of religious business devolved on the city praetor; this was certainly the case with the Festival of the Cross-roads (*compitalia*), and he directed the games in honour of Apollo from their institution in 212. Augustus in 22 placed the direction of all the popular festivals in the hands of the praetors, and it is not without significance that the praetors continued thus to minister to the pleasures of the Roman mob for centuries after they had ceased almost entirely to transact the business of the state. (For the praetor as provincial governor see PROVINCE.) (J. G. FR.; X.)

A full account of the praetorship will be found in Mommsen, *Römisches Staatsrecht* (1887), vol. ii. and P. Willems, *Le Droit public romain* (1883); T. M. Taylor's *Constitutional and Political History of Rome* (1899) will also be found useful. There is a monograph by E. Labatut, *Histoire de la préture* (1868).

PRAETORIANS. In the early Roman republic, *praetor* (*q.v.*) meant commander of the army: in the later republic *praetor* and *propraetor* were the usual titles for provincial governors with military powers. Accordingly, the general's quarters in a camp came to be called *praetorium*,⁶ and one of the gates *porta praetoria*, and the general's bodyguard *cohors praetoria*, or, if large enough to include several cohorts, *cohortes praetoriae*. Under the empire the nomenclature continued with some changes. In particular *cohortes praetoriae* now designated the imperial bodyguard. This, as founded by Augustus, consisted of nine cohorts, each 1000 strong, some part of which was always with the emperor, whether in Rome or elsewhere. In A.D. 23 his successor Tiberius concentrated this force on the eastern edge of Rome in fortified barracks: hence one cohort in turn, clad in civilian garb, was sent to the emperor's house on the Palatine, and large detachments could be despatched to foreign wars. The men were recruited voluntarily, in Italy or in Italianized districts, and enjoyed better pay and shorter service than the regular army: they were under *praefecti praetorio* (usually two; later, sometimes three, rarely only one), who during most of the empire might not be senators. This force was the only body of troops in Rome (save a few *cohortes urbanae*, a fire brigade, and some non-Roman personal guards of the emperor), or, indeed, anywhere near the capital. Accordingly it could make or unmake emperors in crises—at the accession of Claudius in A.D. 41, in 68–69, and again late in the second century. But its normal influence was less than is often asserted. Moreover, its prefects, since they were two and liable to be disunited, and since they could not be senators, neither combined with the

⁶ In permanent forts and fortresses, *praetorium* probably denoted strictly a residence: the official headquarters building (though commonly styled *praetorium* by moderns) was the *principia*. On the other hand *praetorium* could denote any lord's residence, even on a civilian's estate.

senators to restore an oligarchy nor themselves aspired as pretenders to the throne. These praefects were at first soldiers, but later mostly lawyers who relieved the emperors of various civil and criminal jurisdiction. In the second century the praetorian cohorts became ten in number, and at the end of it Septimius Severus reorganized them so that they consisted practically of barbarian soldiers and held constant conflict with the people of Rome. At the end of the third century the *praefecti praetorio* were reconstituted as four officers, each ruling one quarter of the now divided empire. In 312 the Praetorian Guard was suppressed by Constantine. Their barracks at Rome covering a rectangle of 39 acres (1210 by 1410 ft.), were included by Aurelian in the walls of Rome, and three sides of the enceinte can still be seen near the Porta Pia, with brickwork as old as Tiberius: the interior (now barracks for the Italian army) is archaeologically less interesting.

PRAETORIUS, MICHAEL (1571-1621), German musical historian, theorist and composer, was born at Kreuzberg, in Thuringia, on the 15th of February 1571. His father's name was Michael Schultheis.¹ While he was still quite young he visited the university of Frankfurt on the Oder for three years. Here he studied philosophy, and on the death of his brother, on whose support he relied, he was given a post as organist in the town. He acted as kapellmeister at Lüneburg early in life, was engaged first as organist and later as kapellmeister and secretary to the duke of Brunswick-Wolfenbüttel, and was eventually rewarded for his long services with the priory of Ringelheim, near Goslar. He died at Wolfenbüttel on the 15th of February 1621. Of his very numerous compositions copies are now very scarce. The most important are: *Polyhymnia* (15 vols.), *Musae Sioniae* (16 vols.), and *Musa Aonia* (9 vols.), all written partly to Latin and partly to German words. But more precious than all these is the *Synagma musicum* (3 vols. and a *cahier* of plates, 4to, Wittenberg and Wolfenbüttel, 1615-1620). In the original prospectus of the work four volumes were promised, but it is certain that no more than three were ever published. The fourth volume mentioned in Forkel's catalogue is clearly nothing but the *cahier* of plates attached to vol. ii.

The chief value of this very remarkable work lies in the information it gives concerning the condition of instrumental music in the early years of the 17th century. The plates include excellent representations of all the musical instruments in use at the time they were published, together with many forms even then treated only as antique curiosities. The work thus throws a light upon the earlier forms of instrumental music which to the historian is invaluable. In fact, without the information bequeathed to us by Praetorius it would be impossible to reconstruct in theory the orchestra of the earlier half of the 17th century, during which the opera and the oratorio both sprang into existence, or even to understand the descriptions left us by other less careful writers.

PRAETUTTI (also called *Præuterriol*), a tribe of ancient Italy inhabiting the south of Picenum. Their territory lay between the rivers Vomanum and Tessinnus (Pliny iii. § 110), and therefore included Castrum Novum, Interamnia and the Truentis, as well as probably the original of Hadria. From this name was derived the medieval form *Aprulium* (quoted by Kiepert in his *Alte Geographie*), and hence the modern Abruzzo (more commonly in the plural *gli Abruzzi*), denoting the whole central mountain land of Italy. We have no evidence, except their name, and that throws no light on their language, for separating them from the other inhabitants of Picenum (*q.v.*).

(R. S. C.)

PRAGMATIC SANCTION (Lat. *pragmatica sanctio*, from the Gr. *πράγμα*, business), originally a term of the later Roman law. It is found in the Theodosian and Justinian codes, together with such variants as a *pragmaticum*, *pragmatica jussio*, command; *annotatio*, an imperial rescript; *constitutio*, a regulation;

¹ German *Schults* or *Schultze* (*Schultheiss*), meaning the head-man of a township, latinized into praetor or praetorius. Many other members of the family of Praetorius were eminent as musicians.

and *pragmaticum rescriptum*. It was a decision of the state dealing with some interest greater than a question in dispute between private persons, and was given for some community (*universitas hominum*) and for a public cause. In more recent times it was adopted by those countries which followed the Roman law, and in particular by despotically governed countries where the rulers had a natural tendency to approve of the maxims and to adopt the language of the imperial Roman lawyers. A pragmatic sanction, as the term was used by them, was an expression of the will of the sovereign or "the prince," defining the limits of his own power, or regulating the succession. Justinian regulated the government of Italy after it had been reconquered from the Ostrogoths by pragmatic sanctions. In after ages the king of France, Charles VII., imposed limits on the claims of the popes to exercise jurisdiction in his dominions by the pragmatic sanction of Bourges in 1438. The emperor Charles VI. settled the law of succession for the dominions of the house of Habsburg by pragmatic sanction first published on the 19th of April 1713, and thereby prepared the way for the great war which ensued upon his death. Philip V., the first of the Bourbon kings of Spain, introduced the Salic law by a pragmatic sanction, and his descendant, Ferdinand VII., revoked it by another. The term was not used in England even for such things as the will by which Henry VIII. regulated the succession to the throne, which would have been a pragmatic sanction in a country of the Roman law. The term and the thing signified by it have become obsolete owing to the spread of constitutional government in modern Europe.

PRAGMATISM, in philosophy, etymologically a theory or method of dealing with real things (Gr. *πράγματα*: cf. *πραγματικός*, versed in affairs). "Pragmatic," as here employed is not used in the common colloquial sense of "pragmatical," i.e. "fussy and positive," nor in the historical sense, as in "Pragmatic Sanction," of "relating to affairs of state," but in the sense of practical or efficient.² Pragmatism, as a general philosophic doctrine or mental attitude, can only be understood as part of a reaction against the intellectualistic speculation which has characterized most of modern metaphysics. It arises from a general awakening to the fact that the growth of our psychological and biological knowledge must profoundly transform the traditional epistemology. It follows that "pragmatic" lines of thought may originate from a multiplicity of considerations and in a variety of contexts. These, however, may be conveniently classified under four main heads—psychological, logical, ethical and religious—and the history of the subject shows that all these have contributed to the development of pragmatism.

1. Psychologically, pragmatism starts from the efficacy and all-pervasiveness of mental activity, and points out that interest, attention, selection, purpose, bias, desire, emotion, satisfaction, &c., colour and control all our cognitive processes. It insists that all thought is personal and purposive and that "pure" thought is a figment. A judgment which is not prompted by motives and inspired by interest, which has not for its aim the satisfaction of a cognitive purpose, is psychologically impossible, and it is, therefore, mistaken to construct a logic which abstracts from all these facts. Nor is the presence of such non-intellectual factors in thinking necessarily deleterious: at any rate they are ineradicable. Truths are always on one side matters of belief, and beliefs are ultimately rules for action. The whole functioning of our mental apparatus is directed upon yielding the right response to the stimulations of the environment, and is valuable if and in so far as it does this. The "psychologism" thus introduced into logic amounts to a systematic protest against the notion of a dehumanized thought and the study of logic in abstraction from actual psychic process.

2. In its logical aspect pragmatism originates in a criticism of fundamental conceptions like "truth," "error," "fact"

² *The New English Dictionary* quotes for nine distinct senses of the word, of which the philosophic is the eighth. The seven earlier ones are all more or less obsolescent, and their very number shows that the meaning of the word was very vague.

and "reality," the current accounts of which it finds untenable or unmeaning. "Truth," for example, cannot be defined as the agreement or correspondence of thought with "reality," for how can thought determine whether it correctly "copies" what transcends it? Nor can our truth be a copy of a transcendent and absolute truth (Dewey). If it be asked, therefore, what such phrases mean, it is found that their meaning is really defined by their use. The real difference between two conceptions lies in their application, in the different consequences for the purposes of life which their acceptance carries. When no such "practical" difference can be found, conceptions are identical; when they will not "work," *i.e.* when they thwart the purpose which demanded them, they are false; when they are inapplicable they are unmeaning (A. Sidgwick). Hence the "principle of Peirce" may be formulated as being that "every truth has practical consequences, and these are the test of its truth." It is clear that this (1) implicitly considers truth as a value, and so connects it with the conception of good, and (2) openly raises the question—What is truth, and how is it to be distinguished from error? This accordingly becomes the central problem of pragmatism. This same issue also arises independently out of the breakdown or rationalistic theories of knowledge (F. H. Bradley, H. H. Joachim). Logical analysis, after assuming that truth is independent and not of our making, has to confess that all logical operations involve an apparently arbitrary interference with their data (Bradley). Again, it assumes an ideal of truth which turns out to be humanly unattainable and incompatible with the existence of error, and an ideal of science which no human science can be conceived as attaining. The obvious way of avoiding the scepticism into which rationalism is thus driven is to revise the assumptions about the nature and postulates of truth which lead to it.

3. The ethical affinities of pragmatism spring from the perception that all knowing is referred to a purpose. This at once renders it "useful," *i.e.* a means to an end or "good." Completely "useless" knowledge becomes impossible, though the uses of knowledge may still vary greatly in character, in directness, and in the extent and force of their appeal to different minds. This relation to a "good" must not, however, be construed as a doctrine of ethics in the narrower sense; nor is its "utilitarianism" to be confused with the hedonism of the British associationists. "Useful" means "good for an (any) end," and the "good" which the "true" claims must be understood as cognitive. But cognitive "good" and moral "good" are brought into close connexion, as species of teleological "good" and contributory to "the Good." Thus only the generic, not the specific, difference between them is abolished. The "true" becomes a sort of *value*, like the beautiful and the (moral) good. Moreover, since the "real" is the object of the "true," and can be distinguished from the "unreal" only by developing superior value in the process of cognition which arrives at it, the notions of "reality" and "fact" also turn out to be disguised forms of value. Thus the dualism between judgments of fact and judgments of value disappears: whatever "facts" we recognize are seen to be relative to the complex of human purposes to which they are revealed. It should further be noted that pragmatism conceives "practice" very widely: it includes everything related to the control of experience. The dualism, therefore, between "practice" and "theory" also vanishes; a "theory" unrelated to practice (however indirectly) is simply an illusion. Lastly it may be pointed out that, as asserting the efficacy of thought and the reality of choice, pragmatism involves a real, though determinable, indetermination in the course of events.

4. Pragmatism has very distinctly a connexion with religion, because it explains, and to some extent justifies, the faith-attitude or will to believe, and those who study the psychology of religion cannot but be impressed with the pragmatic nature of this attitude. If the whole of a man's personality goes to the making of the truth he accepts, it is clear that his beliefs are not matters of "pure reason," and that his passional and volitional nature must contribute to them and cannot validly

be excluded. His religion also is ultimately a vital attitude which rests on his interests and on his choices between alternatives which are real for him. It is not however asserted that his mere willing to believe is a proof of the truth of what he wishes to believe, any more than a will to disbelieve justifies disbelief. His will to believe merely recognizes that choice is necessary and implies risk, and puts him in a position to obtain verification (or disproof). The pragmatic claim for religion, therefore, is that to those who will take the first step and will to believe an encouraging amount of the appropriate verifications accrues. It is further pointed out that this procedure is quite consonant with the practice of science with regard to its axioms. Originally these are always postulates which have to be assumed before they can be proved, and thus in a way "make" the evidence which confirms them. Scientific and religious verification therefore, though superficially distinct, are alike in kind.

The *pragmatic doctrine of truth*, which it is now possible to outline, results from a convergence of the above lines of argument. Because truth is a value and vitally valuable, and all meaning depends on its context and its relation to us, there cannot be any abstract "absolute" truth disconnected from all human purposes. Because all truth is primarily a claim which may turn out to be false, it has to be tested. To test it is to try to distinguish between truth and falsity, and to answer the question—What renders the claim of a judgment to be true, really true? Now such testing, though it varies greatly in different departments of knowledge, is always effected by the consequences to which the claim leads when acted on. Only if they are "good" is the claim validated and the reasoning judged to be "right": only if they are tested does the theory of truth become intelligible and that of error explicable. If, therefore, a logic fails to employ the pragmatic test, it is doomed to remain purely formal, and the possibility of applying its doctrines to actual knowing, and their real validity, remain in doubt. By applying the pragmatic test on the other hand, it is possible to describe how truths are developed and errors corrected, and how in general old truths are adjusted to new situations. This "making of truth" is conceived as making for greater satisfaction and greater control of experience. It renders the truth of any time relative to the knowledge of the time, and precludes the notion of any rigid, static or incorrigible truth. Thus truth is continually being made and re-made. If the new truth seems to be such that our cognitive purposes would have been better served by it than they were by the truth we had at the time, it is antedated and said to have been "true all along." If an old truth is improved upon, it is revalued as "false." To this double process there is no actual end, but ideally an "absolute" truth (or system of truths) would be a truth which would be adequate to every purpose.

Extensions of pragmatism in a variety of directions readily suggest themselves, and indeed only the doctrine of truth in the above sketch can be treated as strictly indispensable. If however the logical method of pragmatism is critically applied to all the sciences, many doctrines will be cut out which have little or no "pragmatic value." This all-round application of the pragmatic method has received the name of "humanism." It expressly refers itself to the maxim of Protagoras that "man is the measure of all things," and is best conceived as a protest against the assumption that logic can treat thought in abstraction from its psychological context and the personality of the knower, *i.e.* that knowledge can be dehumanized. To arbitrary and unverifiable metaphysical speculation, and to forms of "absolutism" which have lost touch with human interests, this humanism is particularly destructive. It emphasizes still more than pragmatism the personal aspect of all knowing and its contribution to the "making of reality" which necessarily accompanies the making of truth. But it also goes on to raise the question whether the making of reality for our knowledge does not, in view of the essentially practical nature of knowledge, imply also a real making of reality by us, and so throw light upon the whole genesis of reality. In this direction pragmatism may ultimately lead to a number of metaphysics.

each of which will represent a personal guess at a final synthesis of experience, while remaining essentially undogmatic and improvable. The great variety and impermanence of meta-physical systems in the past thus find their explanation: they were all along what they are now recognized as being, viz. personal efflorescences provoked by a totality of experiences which differed in each case.

As regards the history and bibliography of pragmatism, the term was first invented by C. S. Peirce in discussions with William James at Harvard University, and its meaning was expounded by him in an article on "How to make our Ideas clear" in the *Popular Science Monthly* for January 1878. The pragmatic test of truth was referred to by James in his *Will to Believe* (1896, p. 124, in a paper first published in 1881). The validity of the argument from consequences and the connexion of truth with what "works" was asserted à propos of A. J. Balfour's *Foundations of Belief* by A. Seth Pringle-Pattison in his *Man's Place in Cosmos* (1897, p. 307). But the word "pragmatism" itself first occurs in print in 1898, in James's pamphlet on *Theoretical Conceptions and Practical Results*, and again in his *Varieties of Religious Experience* (1902, p. 444). It was rapidly taken up, first by W. Caldwell in *Mind* (1900, new series, No. 36), and by F. C. S. Schiller in *Personal Idealism* (1902). James himself at first developed chiefly the psychological and ethical aspects of the doctrine in his epoch-making *Principles of Psychology* (1890) and his *Will to Believe*. The application to logic, therefore, was mainly made by his followers, John Dewey and his pupils, in the *Chicago Decennial Publications* and especially in their *Studies in Logical Theory* (1903), where, however, the term used is "instrumentalism," and by F. C. S. Schiller, in "Axioms as Postulates" (in *Personal Idealism*, ed. H. Sturt, 1902), in *Humanism* (1903), in which that term was proposed for the extensions of pragmatism, in *Studies in Humanism* (1907), and in *Plato or Protagoras* (1908). All these logical and philosophic developments were popularly expounded by James in his *Pragmatism* (1907), followed by *A Pluralistic Universe* (1908) and *The Meaning of Truth* (1909). H. H. Bawden's *The Principles of Pragmatism* (1910) is a popular sketch. Alfred Sidgwick's logical writings, especially his *Distinction* (1892) and *The Use of Words in Argument* (1901), represent an independent development. For the religious applications see G. Tyrrell (*Lex orandi*, 1903, *Lex credendi*, 1906). Among critical writers on the pragmatic side may be mentioned H. Sturt (*Idola theatri*, 1906), and H. V. Knox (*Mind*, new series, No. 54). There is already a large controversial literature in the philosophic journals, and two critical works appeared in 1909: J. B. Pratt, *What is Pragmatism?* (1909), and A. Schinz, *Anti-Pragmatism* (1909). Outside the English-writing world, identical or kindred tendencies are represented in France by Leroy, Poincaré, Bergson, Milhaud, Blondel, Duhem, Wilbois, Pradines; in Germany by Mach, Ostwald, Simmel, Jerusalem, Goldscheid, Jacoby; in Italy by Papini, Prezzolini, Vailati, Troiano. In addition there are numbers of partial pragmatists, e.g. G. Santayana (*The Life of Reason*, 1905). Various anticipations of pragmatism in the history of philosophy are noted in Schiller's *Plato or Protagoras?* (1908). (F. C. S. S.)

PRAGUE (Ger. *Prag*; Bohemian *Praha*), the ancient capital of the Bohemian kingdom, residence of an archbishop and an Imperial governor, and the meeting-place of the Bohemian Diet. The population of the town, including the suburbs that have not yet been incorporated with it, was 460,849 in 1906. Somewhat under a fifth of the population are Germans, the rest belong to the Bohemian (Czech) nationality. Prague is situated on both banks of the river Vltava (Ger. Moldau) in 50°5' N., 14°25' E., 150 m. N.W. of Vienna and 75 S.S.E. of Dresden. The city is divided into eight districts, which are numbered thus: I. Staré město (the old town), II. Nové město (the new town); III. Malá strana (the small side "quarter"); IV. Hradčany; V. Josefské město (Joseph's, formerly the Jewish, town); VI. Vyšehrad; VII. Holesovic-Bubna; VIII. the suburbs Karlín (Ger. Karolinenthal), Vinohrady and Smichov are not yet incorporated with the city. Prague was by its geographical situation naturally destined to become the capital of Bohemia, as it lies in the centre of the country. The origin of Prague goes back to a very early date, though, as is the case with most very ancient cities, the tales connected with its origin are no doubt legendary. The earliest inhabited spot within the precincts of the present city was the hill named Vyšehrad (higher castle, acropolis) on the right bank of the Vltava. Here the semi-mythical prince Krok, his daughter Libusa, and her husband the peasant Přemysl are stated to have resided. To Libusa is attributed also the foundation of a settlement on the opposite bank of the Vltava on the Hradčany hill. The ancient

Bohemian chronicler Cosmas of Prague gives a very picturesque account of this semi-mythical occurrence.

It is probable that at an early period buildings sprang up in those parts of the present Staré město and Malá strana that are situated nearest to the banks of the river. These banks were from a very remote period connected by a bridge. This bridge was probably situated very near the spot where Charles IV. afterwards built the famed "bridge of Prague." It is probable that independently of the Hradčany and Vyšehrad settlements a certain number of buildings existed as early as 993 on the site of the present Pořič Street (near the station of the state railway). The city continued to increase, and during the reign of King Vratislav (1061-1092) many Germans were attracted to Prague.

In 1235 King Wenceslaus I. surrounded the old town—that is to say, the buildings on the right bank of the Vltava—with a wall and ditch. These fortifications, starting from the river, followed the line of the present Elisabeth Street, the Přikopy or Graben—which therefrom derives its name, signifying ditch or 'trench'—and then that of the Ovocna and Ferdinandova Streets. The Jewish quarter was included in the fortifications, but it was divided by gates and a wall from the old town. King Ottakar II. also contributed greatly to the enlargement of Prague. The still extant fortified towers of the Hradčany belong to his reign. The sovereign, however, to whom Prague is most indebted is the emperor Charles IV. (Charles I., as king of Bohemia). He has rightly been called the second founder of Prague. He founded the university, one of the oldest on the Continent. It immediately became famous all over Europe and students flocked to it from all countries. The town soon became too small, and it is probably in consequence of this that Charles determined to found the "new town." This, which includes the greater part of the modern city, was surrounded by walls, which starting from the foot of the Vyšehrad included the small already-existing settlement of Pořič and then adjoined the borders of the old town from the beginning of the present Přikopy Street up to the river. During the Hussite wars Prague suffered greatly. Two of the greatest battles of the Hussite wars, that of the Žižkov and that of the Vyšehrad (both 1420), were fought on the outskirts of Prague, and after the last-named battle the ancient Vyšehrad castle was entirely destroyed. The Bohemian nobles in alliance with the citizens of the old town attacked and conquered the new town, which for a time lost its privileges and became subject to the old town. Prague gradually recovered during the reign of King George of Poděbrad, and became yet more prosperous during that of King Vladislav.

During the reign of Ferdinand I. of Habsburg (1526-1564) Prague played a considerable part in the opposition to that prince caused in Bohemia by his endeavour to reduce both the political and religious liberty of the country. When the antagonism between the Romanist dynasty and the Bohemian Protestants culminated in the troubles of 1546 and 1547 and the Bohemians, after a weak and unsuccessful attempt to assert their liberties, were obliged to submit unconditionally to the house of Habsburg, Prague was deprived of many of its liberties and privileges. The burgomaster of the old town was one of those who were decapitated in the Hradčany Square (Aug. 20, 1547). Ferdinand had summoned a meeting of the estates on that day at the adjoining Hradčany palace, and it became known as the "bloody diet" (*Krvavý sněm*).

The importance of the city of Prague greatly increased during the reign of Rudolph II. That sovereign chose Prague as his permanent residence and it thus became—as Rudolph, besides being king of Bohemia, was also German emperor, king of Hungary and ruler of the hereditary Habsburg lands—the centre of his vast domains. It was in Prague that the Thirty Years' War broke out. On the 23rd of May 1618 the Protestant nobles of Bohemia threw from the windows of the council chamber of the Hradčany palace two of the Imperial councillors who were accused of having influenced in a manner unfavourable to the Bohemians the emperor Matthias, who was also king of Bohemia. War broke out and continued when in 1619 Matthias was succeeded by Ferdinand. In the same year the Bohemians

ected as their king Frederick of the Palatinate, and both he and his wife Elizabeth of England were crowned in St Vitus's Cathedral. On the 8th of November 1520 the Bohemian forces were decisively defeated by the Imperialists on the White Mountain at the outskirts of Prague. The town submitted on the following day and the whole country was quickly subdued by the Imperialist armies. On the 21st of June 1621 the principal leaders of the rising against the house of Habsburg were beheaded in the market of the old town near the town hall. In 1631 Prague was occupied for a short time by the Saxon allies of Gustavus Adolphus, king of Sweden, but the Imperial army led by Wallenstein soon obliged them to retire. In 1648 a Swedish army stormed the Malá strana and Hradčany. The citizens, now entirely Romanists, bravely defended the bridge, and the Swedes were unable to obtain possession of the part of Prague situated on the right bank of the Vltava. In November the news of the conclusion of the peace of Westphalia reached Prague and put a stop to hostilities.

Henceforth the history of Prague continues uneventful for a considerable period. During the Austrian War of Succession it again became the scene of important events. On the 26th of November 1741 Prague was stormed by an army consisting of Bavarians, French and Saxons which upheld the cause of Charles, elector of Bavaria, who claimed the succession to the Bohemian throne and to the other domains of the house of Habsburg. A large part of the Bohemian nobility did homage to Charles, and he was crowned king of Bohemia in St Vitus's Cathedral on the 17th of December 1741. The rule of the Bavarian prince lasted, however, but a very short time. On the 27th of June 1742 the armies of the empress Maria Theresa began to besiege the French army of Marshal Belle-Isle in Prague, and the French commander was obliged to evacuate the city in December 1742. In the spring of the following year Maria Theresa arrived at Prague and was crowned there, but in 1744 the city was again the scene of warfare. In that year Frederick the Great of Prussia invaded Bohemia and obtained possession of Prague after a severe and prolonged bombardment, in the course of which a large part of the town was destroyed. The Prussian occupation was, however, of short duration. At the beginning of the Seven Years' War Prague was—in 1757—again besieged by Frederick the Great after he had defeated the Austrians in a battle between the Žižkov and Počernic (commonly called the battle of Prague, see SEVEN YEARS' WAR). In June of the same year the Austrian victory at Kolin obliged the Prussians to raise the siege. Prague, which had suffered even more during the second bombardment, now enjoyed a long period of quiet.

In the beginning of the 19th century Prague, which had become almost a German city, became the centre of a movement that endeavoured to revive the almost extinct Bohemian nationality. This movement was greatly aided by the foundation of the "Society of the Bohemian Museum" in 1822. Several patriotic Bohemian noblemen founded this association. The collections belonging to it and its library were at first housed in the Malá strana, then in a somewhat larger building in the Přikopy. They are now in a large handsome building at the top of the Václavské Náměstí. In connexion with the Bohemian museum a society named *Malice* (treasury) was founded, which published editions of the ancient Bohemian works, as well as writings of modern Bohemian authors.

This movement was at first purely literary, and only in 1848 assumed a political character. It was determined to hold at Prague a "Slavic congress" at which all Slavic countries were to be represented. During the sittings of the congress troubles broke out which originated in an insignificant conflict between students and soldiers of the garrison. Barricades were erected and the town finally surrendered unconditionally after a severe bombardment (June 1848). In 1866 the Prussians, who had invaded Bohemia, occupied Prague (July 8) without encountering any resistance. At the "Blue Star" hotel in Prague also was signed the treaty which ended the war between Austria and Prussia (Aug. 23).

In the years of peace that followed, the development of Prague was constant and vast. The removal of the fortifications greatly assisted this development. The communities of Vyšehrad (1883), Holesovic-Bubna (1884) and Libeň (1901) were consecutively included in the city. Occasional riots, such as in 1897, when the Bohemians were exasperated by the action of the Vienna government which restricted the use of the national language in the law courts; and in 1905, when the people demanded an extension of the suffrage, have not interfered with the increasing prosperity of the city, and their importance has been greatly exaggerated.

Though numerous ancient monuments at Prague have been destroyed in consequence of intestine strife and foreign warfare, the city still contains many of great value and may be considered one of the most interesting cities of central Europe. The natural situation of the town has also at all periods been greatly admired. The centre of the old town and indeed of the entire community of Prague is the town hall (*staroměstská radnice*), which is surrounded by the market-place, the scene of the execution of the Bohemian patriots in 1621. The buildings of the town hall date from various periods. Its oldest parts are the tower and the chapel of St Lawrence, built in 1381. The adjoining ancient council chamber dates from the reign of King Vladislav (1471-1516). The modern hall that is now used for the meetings of the town council is decorated by two paintings of the Bohemian artist Wenceslaus Brozik, which represent Hus before the council of Constance, and the election of George of Poděbrad as king of Bohemia. In the market-place opposite the town hall is situated the ancient Týn church, memorable as having been the religious centre of the Hussite movement. A chapel connected with the so-called Týn or market-place of the German traders stood here from the earliest times, but the present building was begun in the 14th century, and completed in the 15th during the reign of George of Poděbrad. The fine façade built by that king was formerly adorned with a statue of King George, who was represented as holding a sword pointing upward to a representation of the chalice, the emblem of the Hussite Church. Both statue and chalice were removed by the Jesuits in 1623. In the interior of the church the tomb of the astronomer Tycho Brahe is notable, as is the very ancient pulpit from which the Hussite archbishop John of Rokycan preached. In earlier days the Church reformers Milič and Hus also preached here. Close to the town hall is the Joseph-Stadt, the ancient ghetto of Prague. The synagogue is one of the oldest in Europe, and the adjoining cemetery—part of which has unfortunately been destroyed in the course of the modern sanitary improvement of this part of Prague—has great historical interest. The university founded by Charles IV. in 1348 played a great part in the history of Bohemia during the Hussite wars. The lecture-rooms and other institutions connected with the two universities—in 1881 and 1882 a Bohemian university was founded though the German one continued to exist—are now housed in two vast buildings known as the Carolinum and the Clementinum. The Carolinum, first built about the year 1383 but frequently altered, has a closer connexion with Hus and the Hussite movement than any other building at Prague. It was the scene of many religious discussions, and it was here also that the Bohemian nobles met before the uprising of 1618. The large part of the lecture-rooms, the observatory and the very valuable library are in the Clementinum. This building was formerly a college of the Jesuits, who established themselves in Prague in 1556 and erected these extensive buildings at various periods between 1578 and 1715. The Celetná ulice, which leads from the town hall to the limits of the old town contains at its extremity the so-called powder tower (*prašná brána*). It occupies the spot where one of the old town gates was situated, and was built by King Vladislav in that elaborate style of architecture which is known as the style of Vladislav. The building was very skilfully restored in 1880-1883. The powder tower stands at the corner of the Přikopy (in Ger. *Graben*) which with its continuations, the Ovocná ulice and the Ferdinandová ulice, is the most animated part of modern Prague. At the extreme end of the Ferdinandová ulice is the modern Bohemian national theatre.

The "new town" of Prague, though not equal in interest to the "old town," is also well worth notice. At the extremity of the place of Wenceslaus (Václavské Náměstí) is situated the handsome building that contains the collections and library of the Bohemian museum. The museum was opened by the Archduke Charles Louis of Austria on the 18th of May 1891. Of the many interesting churches in the "new town" the Karlov deserves special mention. It was built by Charles IV. in 1350 in the Gothic style, but was restored in the 18th century. The monastery that formerly adjoined this church has been suppressed and its buildings are now used as a hospital. Near the Karlov church is the Karlovo Náměstí (place of Charles), in which is situated the former town hall of the "new town," from the windows of which the councillors were thrown at the beginning of the Hussite wars. The Vyšehrad, now a part of Prague, adjoins the "new town." It has preserved but slight traces of its ancient splendour. It contains, however, the

Romanesque chapel of S Martin, the Church of SS Peter and Paul, and the adjoining cemetery where many of the leaders of the Bohemian national movement are buried.

The districts of Prague situated on the left bank of the Vltava are connected with the other parts of the city by bridges, of which the oldest is the *Karlovo most* (bridge of Charles). The present structure was begun by Charles IV. in 1357, but in consequence of frequent storms and inundations it was only completed in 1503. The statues on the bridge are of an even later date. Not far from the bridge in the centre of the Malá strana is the monument to Radetzky, erected in 1858 out of captured Piedmontese cannon. Near here are the palaces of the governor of Bohemia and that in which the Bohemian diet (*sněm*) now meets. At the extreme end of the Malá strana is the extensive Strahov monastery, from the terraces of which the finest view of the city of Prague can be obtained. The monastery possesses one of the most valuable libraries in Prague and a small picture gallery. The church of the monastery contains the tomb of the famous General Pappenheim. In the Malá strana and the adjoining Hradčany are situated the winter residences of the wealthy Bohemian nobility. Of the many palaces, the Waldstein, Schwarzenberg—formerly Rosenberg—palaces, the two palaces of the counts Thun and that of Prince Lobkowitz are the most interesting. On the summit of the Hradčany is the vast palace of the ancient kings of Bohemia, which also contains the hall where the estates of Bohemia formerly met. During the Hussite wars most of the buildings on the Hradčany hill were destroyed, and a large part of the castle still known as the halls of Vladislav was rebuilt by the kings of that name. The handsome halls known as the Spanish and German halls were erected by Ferdinand I., and additions were made by other sovereigns also. The Hradčany was for a time the residence of Rudolph, crown prince of Austria, and it is also occupied by the emperor of Austria during his visits to Prague. Adjoining the Hradčany palace is the famed Cathedral of St Vitus, where the kings of Bohemia were crowned. The earliest church on this spot was built by St Wenceslaus, and the present building was begun by Charles IV. and has as yet remained unfinished. The cathedral contains the chapel of St Wenceslaus, where the insignia of the Bohemian kings are preserved, the tomb of St John of Nepomuk, and a monument to the Bohemian sovereigns who are buried here, the work of Colin of Malines. On the slope of the Hradčany hill are the ancient towers named Mikulka, Daliborka, the white tower and the black tower, which formed part of the fortified works erected by Ottakar II. (1253-1278).

The suburbs of Prague contain few objects of interest, but they are centres of the rapidly increasing trade and industry of Prague.

See Count Lützow, *Prague*, in "Mediaeval Towns" Series (London, 1902); Tomek, *Dějepis Města Prahy* (History of the town of Prague), the standard work on Prague, which the author only continued up to the year 1608. (L.)

PRAGUERIE, THE, a revolt of the French nobility against King Charles VII. in 1440. It was so named because a similar rising had recently taken place in Prague, Bohemia, at that time closely associated with France through the house of Luxemburg, kings of Bohemia, and it was caused by the reforms of Charles VII. at the close of the Hundred Years' War, by which he sought to lessen the anarchy in France. The attempt to reduce the brigand-soldiery, and especially the ordinances passed by the estates of Languedoc at Orleans in 1430, which not only gave the king an aid of 100,000 francs (an act which was later used by the king as though it were a perpetual grant and so freed him from that parliamentary control of the purse so important in England), but demanded as well royal nominations to officerships in the army, marked a gain in the royal prerogative which the nobility resolved to challenge. The main instigator was Charles I., duke of Bourbon, who three years before had attempted a similar rising, and had been forced to ask pardon of the king. He and his bastard brother, Alexander, were joined by the former favourite, Georges de la Trémoille, John V., duke of Brittany, who allied himself with the English, the duke of Alençon, the count of Vendôme, and captains of mercenaries like Antoine de Chabannes, or Jean de la Roche. The duke of Bourbon gained over to their side the dauphin Louis—afterwards Louis XI.—then sixteen years old, and proposed to set aside the king in his favour, making him regent. Louis was readily induced to rebel; but the country was saved from a serious civil war by the energy of the king's officers and the solid loyalty of his "good cities." The constable de Richemont marched with the king's troops into Poitou, his old battleground with Georges de la Trémoille, and in two months he had subdued the country. The royal artillery battered down

the feudal strongholds. The dauphin and the duke of Alençon failed to bring about any sympathetic rising in Auvergne, and the Praguerie was over, except for some final pillaging and plundering in Saintonge and Poitou, which the royal army failed to prevent. Charles VII. then attempted to ensure the loyalty of the duke of Bourbon by the gift of a large pension, forgave all the rebellious gentry, and installed his son in Dauphiné (see LOUIS XI.). The ordinance of Orleans was enforced.

PRAHRAN, a city of Bourke county, Victoria, Australia, $3\frac{1}{2}$ m. by rail S.E. of Melbourne and suburban to it. Pop. (1901), 41,161. It is connected with Melbourne by cable tram over a fine iron girder bridge across the Yarra. Many of its streets are planted with trees and it has numerous handsome shops and villas. Prahran was proclaimed a city in 1879.

PRAIRIE (adopted from the Fr. *prairie*, a meadow-tract. Late Lat. *prataria*, Lat. *pratium*, meadow), a level tract of grassy and treeless country, generally restricted to tracts so characterized in the central parts of North America. In the United States the prairies may be taken to extend from southern Michigan and western Ohio over Illinois (especially designated the Prairie State), Indiana, Missouri, Iowa, Wisconsin and Minnesota, and west of the Missouri to the foothills of the Rocky Mountains (see articles on the several states, and UNITED STATES). In Canada they extend from the same mountains to a line somewhat to the east of Winnipeg. The word prairie is used in a large number of compounds referring to natural and other features, flora, fauna, &c., characteristic of the prairies. Examples are: *prairie-chicken* or *prairie-hen*, a name for the pinnated grouse (*Cupidonia* or *Tympanucus cupido*), also applied to *Pedioecetes phasianellus*, the sharp-tailed grouse; *prairie-dog*, a rodent of the squirrel family, genus *Cynomys*, a gregarious burrowing animal, and other animals noticed below; *prairie-schooner*, a name for the covered wagons in which emigrants used to cross the plains; *prairie-grass*, &c.

PRAIRIE DU CHIEN, a city and the county-seat of Crawford county, Wisconsin, U.S.A., on the east bank of the Mississippi river about 3 m. above the mouth of the Wisconsin, about 98 m. W. of Madison. Pop. (1800) 3131; (1900) 3232; (1905) 3179; (1910) 3149. It is served by the Chicago, Milwaukee & St Paul, and the Chicago, Burlington & Quincy railways. The city has a fine location, its natural attractiveness and mineral springs in the vicinity combining to make it a summer and health resort. It has an excellent artesian water-supply. Among its buildings are the Crawford county court-house, the city hospital and a sanatorium. It is the seat of St Mary's Academy (1872; R.C.) for young women, and the College of the Sacred Heart (1880; R.C.) for men. Among the manufactures are beer, wagons, wool, and pearl buttons, and the city is a centre of the fresh-water pearl fisheries along the Mississippi. Prairie du Chien is one of the most interesting places, historically, in Wisconsin. The first white man known to have visited the site was Father Hennepin in 1680; later in the same year the trader Du Lhut (or Duluth) was here. In 1685 Nicholas Perrot, the French commandant in the West, built Fort St Nicholas near the site of the present city. After the close of the French and Indian War, British authorities assumed possession, but no garrison was regularly maintained. In 1779-1780 Prairie du Chien was the scene of plots and counterplots of American and British sympathizers and of the activities of Godefrey Linctot, the agent of George Rogers Clark. About 1780-1781 a permanent settlement began to grow up around the post. Prairie du Chien was formally surrendered in 1796 to the United States authorities under the Jay treaty, and by them Fort Shelby was erected. On the 17th of July 1814 a force of British, Canadians and Indians under Major William McKay captured the fort, and renamed it Fort McKay, but abandoned it in May 1815. In 1816 Fort Crawford was erected—it was rebuilt on a different site in 1820—and in 1820 one of the principal dépôts of the American Fur Company was established here. Here in 1823 Judge James Duane Doty (1799-1865) opened the first United States court in what is now the state of Wisconsin. At the time of the Red Bird rising in 1827, Governor Lewis Cass of Michigan

Territory made Prairie du Chien his temporary headquarters. During the Black Hawk War (1832) Zachary Taylor, then a lieutenant-colonel, was in command of Fort Crawford, and to him Black Hawk was entrusted after his capture. The Chicago, Milwaukee & St Paul railroad was completed to Prairie du Chien in 1857. The city was chartered in 1872.

PRAIRIE-MARMOT, a zoological emendation for the American name "prairie-dog," applied to a small North American rodent allied to the squirrels and marmots, and technically known as *Cynomys ludovicianus* (see MARMOT). In a great degree prairie-marmots, of which there are several species in North America, ranging as far south as Mexico, are intermediate between marmots and sousliks (see SOUSLIK), having the cheek-pouches much smaller than in the latter, and the first front-toe, which is rudimentary in marmots and sousliks, well developed. The cheek-teeth are more complex than those of marmots, and the two series converge behind. In their slender build and small size, prairie-marmots are much more like sousliks than marmots. In habits these rodents are very like marmots, the typical species inhabiting the open prairies, while the others are found in mountains. The prairie species (*C. ludovicianus*) makes a raised, funnel-shaped entrance to its burrow. All feed on the roots of grass; and when disturbed, like marmots, utter a whistling cry. Rattlesnakes, owls and weasels are commonly found in the burrows; but their presence is no indication of the existence of a kind of "happy family" arrangement, the snakes, at any rate, preying on the young marmots. The hibernation of these rodents is only partial, and confined to seasons of intense cold. (See RODENTIA.)

PRAKRIT (*prākṛta*, natural), a term applied to the vernacular languages of India as opposed to the literary Sanskrit (*samskṛta*, purified). The place which the Prakrits occupy in regard to the Indo-European languages (*q.v.*), ancient and modern, is treated under that head. There were two main groups of ancient Indo-Aryan dialects, or Primary Prakrits, viz. the language of the Midland or *Āryāvarta*, and that of what is called the Outer Band. The language of the Midland became the language of literature, and was crystallized in the shape of literary Sanskrit about 300 B.C. Beside it all the Primary Prakrits continued to develop under the usual laws of phonetics, and, as vernaculars, reached a secondary stage marked by a tendency to simplify harsh combinations of consonants and the broader diphthongs, the synthetic processes of declension and conjugation remaining as a whole unaltered. The process of development closely resembles that of old Italian from the Italic dialects of Latin times. It should be noted that although the literary dialect of the Midland became fixed, the vernacular of the same tract continued to develop along with the other Primary Prakrits, but owing to the existence of a literary standard by its side its development was to a certain extent retarded, so that it was left somewhat behind by its fellows in the race.

The Secondary Prakrits, in their turn, received literary culture. In their earliest stage one of them became the sacred language of Buddhism, and under the name of Pali (*q.v.*) has been widely studied. In a still later stage several Secondary Prakrits became generally employed for a new literature, both sacred and profane. Not only were three of them used for the propagation of the Jaina religion (see JAINS), but they were also dealt with as vehicles for independent secular works, besides being largely employed in the Indian drama. In the last-named Brahmins, heroes and people of high rank spoke in Sanskrit, while the other characters expressed themselves in some Secondary Prakrit according to nationality or profession. This later stage of the Secondary Prakrits is known as the Prakrit *par excellence*, and forms the main subject of the present article. A still further stage of development will also be discussed, that of the *Apabhraṃśa*, or "corrupt language." The Prakrit *par excellence*, which will throughout the rest of this article be called simply "Prakrit," underwent the common fate of all Indian literary languages. In its turn it was fixed by grammarians, and as a literary language ceased to grow, while

as a vernacular it went on in its own course. From the point of view of grammarians this further development was looked upon as corruption, and its result hence received the name of *Apabhraṃśa*. Again in their turn the *Apabhraṃśas* received literary cultivation and a stereotyped form, while as vernaculars they went on into the stage of the Tertiary Prakrits and become the modern Indo-Aryan languages.

In the Prakrit stage of the Secondary Prakrits we see the same grouping as before—a Midland language, and the dialects of the Outer Band. The Prakrit of the Midland was known as Śaurasēnī, from Śūrasēna, the name of the country round Mathurā (Muttra). It was the language of the territories having the Gangetic Doab for their centre. To the west it probably extended as far as the modern Lahore and to the east as far as the confluence of the Jumna and the Ganges. Conquests carried the language much further afield, so that it occupied not only Rajputana, but also Gujarat. As stated above, the development of Śaurasēnī was retarded by the influence of its great neighbour Sanskrit. Moreover, both being sprung from the same original—the Primary Prakrit of the Midland—its vocabulary, making allowances for phonetic changes, is the same as in that language.

The Prakrits of the Outer Band, all more closely connected with each other than any one of them was to Śaurasēnī, were Māgadhi, Ardhamāgadhi, Māhārāṣṭri, and an unknown Prakrit of the North-west. Māgadhi was spoken in the eastern half of the Gangetic plain. Its proper home was Māgadha, the modern South Bihar, but it extended far beyond these limits at very early times. Judging from the modern vernaculars, its western limit must have been about the longitude of the city of Benares. Between it and Śaurasēnī (*i.e.* in the modern Oudh and the country to its south) lay Ardhamāgadhi or "half-Māgadhi." Māhārāṣṭri was the language of Māhārāṣṭra, the great kingdom extending southwards from the river Nerubudda to the Kistna and sometimes including the southern part of the modern Bombay Presidency and Hyderabad. Its language therefore lay south of Śaurasēnī. West of Śaurasēnī, in the Western Punjab, there must have been another Prakrit of which we have no record, although we know a little about its later *Apabhraṃśa* form. Here there were also speakers of Paisāci (see INDO-ARYAN LANGUAGES), and the local Prakrit, if we are to judge from the modern Tertiary vernacular, was a mixed form of speech. We have a detailed description of only one *Apabhraṃśa*—the Nāgara—the *Apabhraṃśa* of the Śaurasēnī spoken in the neighbourhood of Gujarat, and therefore somewhat mixed with Māhārāṣṭri. We may, however, conclude that there was an *Apabhraṃśa* corresponding to each Prakrit, so that we have, in addition to Śaurasēna, a Māgadha, an Ardhamāgadha and a Māhārāṣṭra *Apabhraṃśa*. Native writers describe more than one local *Apabhraṃśa*, of which we may mention Vṛacaḍa, the ancient dialect of Sind. There were numerous Prakrit subdialects to which it is not necessary to refer.

Of all these Prakrits, Māhārāṣṭri is that which is best known to us. It early obtained literary pre-eminence, and not only was the subject of long treatises by native grammarians, but became the language of lyric poetry and of the formal epic (*kāvya*). Dramatic works have been written in it, and it was also the vehicle of many later scriptures of the Jaina religion. We also know a good deal about Ardhamāgadhi, in which the older Jaina writings were composed. With Māgadhi we have, unfortunately, only a partial acquaintance, derived from brief accounts by native grammarians and from short sentences scattered through the plays. We know something more about Śaurasēnī, for it is the usual prose dialect of the plays, and is also employed for the sacred writings of one of the Jaina sects.

The materials extant for the study of the Prakrit are either native grammars or else literary works written in accord with the rules laid down therein. Originally real vernaculars with tendencies towards certain phonetic changes, the dialects were taken in hand by grammatical systematizers, who pruned down what they thought was over-luxuriant growth, trained errant shoots in the way they thought

they ought to have gone, and too often generalized tendencies into universal rules. Subsequent writers followed these rules and not the living speech, even though they were writing in what was meant to be a vernacular. Moreover, at an early date, the Prakrits, *qua* literary languages, began to lose their characteristics as local forms of speech. A writer composed in Māhārāṣṭrī, not because it was his native language, but because it was the particular Prakrit employed for lyrics and in formal epics. In the same way, in dramatic literature, Saurasēnī and Māgadhī were put into the mouths of characters in particular walks in life, whatever the nationality of the dramatist might have been. There was thus a tendency for these literary Prakrits to adopt forms from the vernacular dialects of those who wrote them, and, *en revanche*, for the very popular lyric poetry of Māhārāṣṭrī to influence the local dialects of the most distant parts of India. On the other hand, although to a certain extent artificial, the literary Prakrits are all based on local vernaculars, a fact entirely borne out by a comparison with the modern Indian languages, which closely agree with them in their mutual points of difference. We now proceed to consider the general points in which the Prakrits differ from Sanskrit and from each other. The reader is throughout assumed to be familiar with the general outline of the article SANSKRIT.

[Contractions: Skr. = Sanskrit. Pr. = Prakrit. S. = Saurasēnī. Mg. = Māgadhī. AMg. = Ardhamāgadhī. M. = Māhārāṣṭrī. Ap. = Nāgara Apabhraṃśa.]

Vocabulary.—The vocabulary of Ś. is to all intents and purposes the same as that of Skr. In the languages of the Outer Band there are numerous provincial words (*dēśī* or *dēśya*), the originals of which belonged to Primary Prakrits other than those of the Midland. In the Outer Band there is also a rich variety of grammatical forms, many of which are found in the Veda and not in classical Sanskrit, and some (e.g. Pr. *-hi*, Pali *-dhi*, Greek *-θi*) which cannot be traced to any known Primary Prakrit form, but which must have existed in that stage and beyond it, back into Indo-European times.

Phonetics.—The Skr. diphthongs *ē* and *ō* are treated in Pr. as pure vowels, and may each be either long or short. *Āi* and *āu* become either *ē* and *ō* or *āi* and *āu* respectively. The vowel *r* becomes *a*, *i*, or, under the influence of a neighbouring labial, *u*. Before two consonants an original long vowel becomes short, and *i* and *u* are (according to the grammarians) changed to *e* and *o* respectively. The last rule is an instance of grammarians' over-generalization, and is not universally true. Examples, Skr. *mārga*, Pr. *magga*; Skr. *sindura*, Pr. *sendura*; Skr. *pustaka*, Pr. *pothaa*. Conversely, a short vowel before two consonants is lengthened on one of them being elided. Thus, Skr. *īvara*, Pr. *issara*- or *īsara*; Skr. *jihvā*, Pr. *jihā*. In Ap. the quantity of vowels is very loosely observed.

In all dialects *n* becomes *ṇ* unless it is followed by a dental mute, but in Jaina works *nn* and initial *n* remain unchanged. Judging from modern vernaculars, the latter seems to have been the real state of affairs. In Mg. *j* becomes *y* and *r* becomes *l*. Here also *s* and *ś* become *ṣ*, a peculiarity still preserved by the modern Bengali. Elsewhere *ṣ* and *ś* usually become *s*, but the change of a sibilant to *h* is not uncommon in the Outer Prakrits (even in Mg.), though rare in the more archaic Ś.

Initial *y* becomes *j* except in Mg., in which, on the contrary, *j* becomes *y*. Subject to the foregoing general rules, all other initial consonants usually remain unchanged. As regards medial single consonants:—

1. *K*, *g*, *c*, *j*, *l*, *d* and *y* are usually elided. As a hiatus is caused by the elision, a faintly sounded *y* (or in some cases *v*) is substituted for the elided consonant, though only written in Jaina MSS. Examples: Skr. *lōka*-, Pr. *lō(y)a*-; Pr. *maa* = Skr. *mata*-, *mada*-, *maya*-, *mrga* or *mṛta*-. The latter example illustrates the extraordinary confusion which results from the strict application of this rule of elision of medial consonants. Such a Prakrit would have failed in the main object of a language—the connotation of distinct ideas by distinct sounds. To the present writer it seems impossible that such a language could ever have existed, and he is persuaded that the rule just given is merely another instance of grammarians' over-generalization. A rule has been made out of a tendency, and this tendency was evidently, first, to soften a hard letter, and then (but not necessarily) to elide it. We see this well illustrated by *Apabhraṃśa*, in which *k*, *l* and *p* are usually preserved under the forms *g*, *d* and *b*. In the Outer Prakrits also *k* often becomes *g*, as in Skr. *śrāvaka*-, Jaina M. and AMg. *sāvaga*-, Mg. *sāvaga*-. Ś. and Mg. always preserve a medial *l*, changing it to *d*; thus, Skr. *gata*-, S. Mg. *gada*-, elsewhere *ga(y)a*-.

2. *Kh*, *gh*, *th*, *dh*, *ph* and *bh* similarly become *h*. Also, as above, Ś. and Mg. change *th* to *dh*. *Ṭh* becomes *ḍh*, and *ph* may become *bh*. The other aspirates (*ch*, *jh*, *ḍh*), and also sometimes *bh*, remain

unchanged. In Ap., as before, *kh*, *th* and *ph* are usually preserved in *gh*, *dh* and *bh* respectively.

3. *T* becomes *ḍ*, *ḍ* becomes *ḷ* (often written *l*), which when doubled becomes dentalized to *ll*, as in the case of the Jaina *mn*. *P* and *b* usually become *v*. The Outer languages often cerebralize dental sounds and change *ḷ* to *l*.

4. *N*, *m*, *l* and *h* remain unchanged. *V* disappears before *u*, but otherwise generally remains unchanged. In Ap. *m* may become a *v* nasalized by *anunāsika*; thus, Skr. *bhramara*-, Ap. *bhaṭvara*-.

Final consonants usually disappear altogether, except nasals, which become *anusvāra*. Thus, Skr. *samanīti*, *phalam*, Pr. *samanīti*, *phalam*.

The following rules will be found to include the great majority of possible cases of compound consonants. They show clearly the character of all changes from Primary to Secondary Prakrit, viz. the substitution, mainly by a process of assimilation, of a slurred for a distinct pronunciation:—

1. In Pr. a conjunct consonant cannot consist of more than two elements, and, except in Mg. and Ap., can only be a double consonant or a consonant preceded by a nasal, a consonant followed by *r*, or one of the following: *ṅh*, *nh*, *mh*, *lh*. The consonants *r* and *h* cannot be doubled.

2. In Pr. the only conjuncts which can begin a word are *ṅh*, *nh*, *mh*, and *lh*. If any other conjunct consonant be initial, the first member of the Pr. form of it is dropped. Thus, in Pr. *kr* becomes *kk*, and the Skr. *ākramati* becomes Pr. *akkamaī*. If we omit the initial preposition *ā*- (Pr. *a*-), the *kk* becomes initial, and we have *kamaī*, not **kkamaī*. Similarly, Skr. *sthira*- becomes Pr. *thira*- for **thira*-.

3. *L* and *v* are elided when they stand first or last in a compound, and the remaining letter is doubled, if it admits of doubling. Thus, Skr. *ulkā*, Pr. *ukkā*; Skr. *pakva*, Pr. *pakka*-. The same rule is followed regarding *r*, but when it follows a consonant it is sometimes, especially in Ap., retained even when initial. Thus, Skr. *arka*-, Pr. *akka*; Skr. *priya*-, Pr. *pia*- or (Ap.) *pria*-.

4. *M*, *n* and *y* are elided when standing last in a compound, and the remaining letter is doubled; thus, Skr. *raśmi*-, Pr. *raśsi*-.

5. *K*, *g*, *t*, *ḍ*, *l*, *d*, *p*, *ṣ*, *ś* and *s* are elided when standing first in a compound, and the remaining letter is doubled as before; thus, Skr. *bhaktā*-, Pr. *bhatta*-; Skr. *skhalita*-, Pr. *khalīa*- for **khalīa*- (see rule 2).

6. The above rules hold in the order given above; that is to say, rule 3 holds in preference to rules 4 and 5, and rule 4 in preference to rule 5. Thus, in the Skr. compound *kr*, the *r* is elided under rule 3, and not the *k* under rule 5, so that the Pr. form is *kk*.

7. **Special Rules for Mg.**—In this form of Pr. there are several peculiar changes. *Dy*, *rj*, *ry*, all become *yy*; *ny*, *ry*, *ḷi*, *ḷj* become *ṇi*; medial *ch* becomes *śc*; *ḥ*, *ṣ*, *ṣh* become *ṣ*; and *rth*, *sth* become *st*. Other changes also occur, besides dialectic variations of those given above.

Declension.—Pr. has preserved the three genders of Skr., but has lost the dual number. As a rule, the gender of a noun follows that of the Skr. original, though in AMg. there is already a tendency to substitute the masculine for the neuter, and in Ap. these two genders are frequently confused, if the distinction is not altogether neglected. In the formation of cases, the phonetic rules just given are fully applied, but there are also other deviations from the Skr. original. The consonantal stems which form an important part of Skr. declension are frequently given vocalic endings, and there is a general tendency to assimilate their declension to that of *a*-bases, corresponding to the first and second declensions in Latin. This tendency is strongly helped by the free use of pleonastic suffixes ending in *a*, which are added to the base without affecting its meaning. Of these the most common are *-ka*-, *-ḍa*-, and *-alla*-, *-illa*- or *-ulla*-. The first of these was also very common in Skr., but its use became much extended in Pr. In accordance with the general rule, the *k* is liable to elision; thus, Skr. *ghōṣa-ka*-, Pr. *ghōḍa-a*-. It may even be doubled, as in Skr. *bahu*-, much, Pr. *bahu-a-a*-, for *bahu-ka-ka*-. *-ḍa*- is confined to Ap., and may be used alone or together with the other two, as in Skr. *bāhubala*-, strength of arm, Ap. *bāhubal-ulla-ḍa-(k)a*-. *-illa*- is most common in the Outer languages, and especially so in AMg. and M.; thus, Skr. *pura*-, M. *pur-illa*-.

All the Skr. cases are preserved except the dative, which has altogether disappeared in the Midland, but has survived in the singular number in the Outer languages. Everywhere the genitive can be employed in its place. Most of the case-forms are derived from Sanskrit according to the phonetic rules, but Ap. has a number of dialectic forms which cannot be referred to that language (cf. the remarks above about *-hi*=*θi*). It also rarely distinguishes between the nominative and the accusative. As an example, we may give the commoner forms of the declension of the Skr. *putra*, Pr. *putta*-, a son (see next page). It should be understood that numerous other forms were also in use, but the ones given here are selected because they are both common and typical.

The declension of neuter *a*-bases closely resembles the above, differing only in the nominative and accusative singular and plural. Ap. has almost lost the neuter termination in the singular. Feminine *a*-stems are declined on the same lines, but the cases have run more into each other, the instrumental, genitive and locative singular

being identical in form. Very similarly are declined the bases ending in other vowels. The few still ending in consonants and which have not become merged in the a-declension, present numerous apparent irregularities, due to the inevitable phonetic changes, which must be learned from the textbooks.

past participle passive has survived under the form *-ia-*. Many direct representatives of Skr. participles in *-ta-* (without the *i*) and *-na-* also appear. Thus, Skr. *dr̥ṣṭa-*, Pr. *diṣṭa-*, seen; Skr. *lagna-*, Pr. *lagga-*, attached. As usual there is a tendency to simplification, and the termination *ia* is commonly added to the Pr. present base, instead of following Skr. analogy.

	Skr.	Ś.	Ap.	M.	AMg.	Mg.
Singular:						
Nom.	<i>putras</i>	<i>puttō</i>	<i>puttu</i>	<i>puttē</i>	<i>puttē</i>	<i>puttē</i>
Acc.	<i>putram</i>	<i>puttam</i>	<i>puttu</i>	<i>puttam</i>	<i>puttam</i>	<i>puttam</i>
Instr.	<i>putrēṇa</i>	<i>puttēṇa</i>	<i>puttē</i>	<i>puttēṇa(m)</i>	<i>puttēṇa(m)</i>	<i>puttēṇa</i>
Dat.	<i>putrāya</i>	—	—	<i>puttāa</i>	<i>puttāa</i>	<i>puttāa</i>
Abl.	<i>putrāt</i>	<i>puttādō</i>	<i>puttahu</i>	<i>puttādō</i>	<i>puttādō</i>	<i>puttādō</i>
Gen.	<i>putrasya</i>	<i>puttassa</i>	<i>puttaha,</i> <i>puttaha</i> <i>putti,</i>	<i>puttassa</i>	<i>puttassa,</i>	<i>puttāssa</i> <i>puttāha</i> <i>puttē,</i> <i>puttammi,</i> <i>puttāhim</i>
Loc.	<i>putrē</i> <i>*putrasmin</i>	<i>puttē</i>	<i>puttahī</i>	<i>puttē,</i> <i>puttammi</i>	<i>puttē,</i> <i>puttammi</i>	<i>puttē,</i> <i>puttammi,</i> <i>puttāhim</i>
Plural:						
Nom.	<i>putrās</i>	<i>puttā</i>	<i>putta</i>	<i>putta</i>	<i>puttā</i>	<i>puttā</i>
Acc.	<i>putrān</i>	<i>puttē</i>	<i>puttē</i>	<i>puttē</i>	<i>puttē</i>	<i>puttē</i>
Instr.	<i>*putrēbhis</i>	<i>puttēhim</i>	<i>putta</i>	<i>puttā</i>	<i>puttā</i>	<i>puttā</i>
Abl.	<i>putrēbhyas</i>	<i>puttēhim-tō</i>	<i>puttahī</i>	<i>puttēhim'</i>	<i>puttēhim</i>	<i>puttēhim</i>
Gen.	<i>putrāṇām</i>	<i>puttāhim-tō</i>	<i>puttahū</i>	<i>puttēhim-tō</i>	<i>puttēhim-tō</i>	<i>puttāṇām-tō</i>
Loc.	<i>putrēsu</i>	<i>puttāṇām</i>	<i>puttahā</i>	<i>puttāṇām</i>	<i>puttāṇām</i>	<i>puttāṇām,</i> <i>puttāhā</i> <i>puttēsu(m)</i>

All the Skr. pronouns appear in Pr., but often in extremely abraded shapes. It would, for instance, be difficult to recognize the Skr. *tvām* in the Ap. *paī*. There is also a most luxuriant growth of by-forms, the genitive plural of the pronoun of the second person being, e.g., represented by no less than twenty-five different words in M. alone. We also find forms which have no original in classical Skr. Thus, in that language, the pronoun *sa-*, he, is only used in the nominative singular of two genders, but occurs also in other cases in Pr.

Conjugation.—The Pr. verb shows even more decay than does the noun. With a few isolated exceptions, all trace of the second, or consonantal, conjugation of Skr. has disappeared, and (much as has happened in the case of nouns) all verbs are now conjugated after the analogy of the *a*-conjugation. This *a*-conjugation, on the other hand, falls into two classes, the first being the *a*-conjugation proper, and the second the *ē*-conjugation, in which the *ē* represents the *aya* of the Skr. 10th class and of causal and denominative verbs. The *āmanēpada* voice of Skr. has practically disappeared in the Midland, and even in the Outer languages it is not common. The present participle is the only form which has everywhere survived. The other forms are supplied by the *parasmaipada*. All the past tenses (imperfect, perfect and aorists) have fallen into disuse, leaving only a few sporadic remains, their place being supplied, as in the case of the tertiary vernaculars, by the participles, with or without auxiliary verbs. The present tense of the verb substantive has survived from Skr., but it is usual to employ *althi* (=Skr. *asti*) for both numbers and all persons of the present, and *āsī* (=Skr. *āsī*) for both numbers and all persons of the past. It is interesting to note that the latter has survived in the modern Panjabi *sī*, was, in which language it is universally, but wrongly, described as a feminine. Another verb substantive (Skr. *√ bhū*) has also survived, generally in the form *hōi* or *huvaī* for *bhavaī*. In AMg. and M. we also have *bhavaī* pretty frequently, and the same form also occurs, but less often, in Ś. and Mg. Its usual past participle is *hūa-* or Mg. *hūda-*, Ś. *bhūda-*. The forms are given here as they are important when the history of the Tertiary Prakrits comes under consideration. These two verbs substantive make periphrastic tenses with other participles, and, in the case of the past participles and gerundives of transitive verbs (both of which are passive in signification), the agent or subject is put into the instrumental case, the participle being used either personally or impersonally, as in the tertiary languages. Thus, *tēna girivarō diṣṭhō*, by him a mountain was seen, i.e. he saw a mountain; *tēna paḍivannam*, it was acknowledged by him, he acknowledged. The gerundive, or future passive participle, is also used impersonally in the case of intransitive verbs, as in *dūram gantavām*, it is to be gone far, we must go far.

Besides the participles, the infinitive and the indeclinable participle (gerund) have also survived. So also the passive voice, conjugated in the same tenses as the active, and generally with *parasmaipada* terminations. The causal has been already mentioned. There are also numerous denominative verbs (many of them onomatopoeic), and a good supply of examples of frequentative and desiderative bases, mostly formed, with the necessary phonetic modifications, as in Skr. The present participle in the *parasmaipada* ends in *-anta-* (*-enta-*), declined according to the *a*-declension, and in the *āmanēpada* in *-māna-*. The termination *-(i)ta-* of the Skr.

Thus, M. *puccijjāi* or Ś. *puccihādī*, he is being asked. The following are therefore the only tenses which are fully conjugated in Pr.: the present, the imperative, the future and the optative. Except in Ap., the personal terminations in general correspond to the Skr. ones, but in Ap. there are some forms which probably go back to unrecorded Primary Prakrits and have not as yet been explained. As an example we take the conjugation of the base *pucca-*, ask (Skr. *ṛcchati*), in the present tense.

	Skr.	Ś.	Ap.	M.	AMg.	Mg.
Sing.						
1.	<i>ṛcchāmi</i>	<i>puccāmi</i>	<i>puccah</i>	<i>puccāmi</i>	<i>puccāmi</i>	<i>puccāmi</i>
2.	<i>ṛcchasi</i>	<i>puccasi</i>	<i>puccasi or-hi</i>	<i>puccasi</i>	<i>puccasi</i>	<i>puccasi</i>
3.	<i>ṛcchati</i>	<i>puccadi</i>	<i>puccai</i>	<i>puccai</i>	<i>puccai</i>	<i>puccadi</i>
Plur.						
1.	<i>ṛcchāmas</i>	<i>puccāmō</i>	<i>puccahū</i>	<i>puccāmō</i>	<i>puccāmō</i>	<i>puccāmō</i>
2.	<i>ṛcchatha</i>	<i>puccadha</i>	<i>puccahu</i>	<i>puccaha</i>	<i>puccaha</i>	<i>puccadha</i>
3.	<i>ṛcchanti</i>	<i>puccanti</i>	<i>puccahī</i>	<i>puccanti</i>	<i>puccanti</i>	<i>puccanti</i>

The imperative similarly follows the Skr. imperative. The Ś. second person singular is generally *pucca*, while the Outer languages often have a form corresponding to *puccēhi*. The base of the optative is generally formed by adding *-ejja-* in the Outer languages and *-ēa-* in Ś.; thus, Ś. *puccēam*, others *puccējāmī*, &c., may I ask. The Skr. future termination *-isyā-* is represented by *-issa-* or *-ihī-*; thus, *puccissāmi* or *puccihīmi*, I shall ask.

Prakrit Literature.—The great mass of Prakrit literature is devoted to the Jaina religion, and, so far as it is known, is described under the head of JAINS. Here it is sufficient to state that the oldest Jaina *sūtras* were in Ardhamāgadhī, while the non-canonical books of the Śvētāmbara sect were in a form of Mahārāṣṭri, and the canon of the Digambaras appears to have been in a form of Śaurasēnī. Besides these religious works, Prakrit also appears in secular literature. In artificial lyric poetry it is pre-eminent. The most admired work is the *Sattasāi* (*Saptasaptikā*), compiled at some time between the 3rd and 7th centuries A.D. by Hāla. The grace and poetry of this collection, in which art most happily succeeds in concealing art, has rarely been exceeded in literature of its kind. It has had numerous imitators, both in Sanskrit and in the modern vernaculars, the most famous of which is the *Sattasāi* of Bihārī Lāl (17th century A.D.). Hāla's work is important, not only on its own account, but also as showing the existence of a large Prakrit literature at the time when it was compiled. Most of this is now lost. There are some scholars (including the present writer) who believe that Sanskrit literature owes more than is generally admitted to works in the vernacular, and that even the Mahābhārata first took its form as a folk-epic in an early Prakrit, and was subsequently translated into Sanskrit, in which language it was further manipulated, added to, and received its final shape. In literary Prakrit we have two important specimens of formal

epic poetry—the *Rāvaṇavaha* or *Sētubandha* (attributed to Pravarasēna, before A.D. 700), dealing with the subject of the *Rāmāyaṇa*, and the *Gauḍavaha* of Vākpati (7th–8th century A.D.), celebrating the conquest of Bengal by Yaśovarman, king of Kanauj. Reference must also be made to the *Kumārapāla-charita*, the title of the last eight cantos of the huge *Dvyāstraya Mahākāvya* of Hēmacandra (A.D. 1150). The whole work was written to serve as a series of illustrations to the author's Sanskrit and Prakrit grammar, the *Siddha-hēmacandra*. The last eight cantos are in Prakrit, and illustrate the rules of the corresponding portion of his work. Its hero is Kumāra-pāla of Aṅghilvādā. Dramatic literature has also an admired example in the *Karpūramahījari* ("Camphor-cluster," the name of the heroine) by Rāja-śekhara (A.D. 900), an amusing comedy of intrigue. An important source of our knowledge of Prakrit, and especially of dialectic Prakrit, is the Sanskrit drama. It has already been pointed out that in works of this class many of the characters speak in Prakrit, different dialects being employed for different purposes. Generally speaking, Śaurasēnī is employed for prose and Māhārāṣṭri (the language of lyric poetry) for the songs, but special characters also speak special dialects according to their supposed nationality or profession. In India there is nothing extraordinary in such a polyglot medley. It is paralleled by the conditions of any large house in Bengal at the present day, in which there are people from every part of India, each of whom speaks his own language and is understood by the others, though none of them attempts to speak what is not his mother tongue. The result is that in the Sanskrit drama we have a valuable reflection of the local dialects. It is somewhat distorted, for the authors wrote according to the rules laid down by technical handbooks, and the dialects which they employed were, in the case of the later writers, as dead as Sanskrit. But nevertheless, if not an absolutely true representation, it is founded on the truth, and it is almost our only source of information as to the condition of the Indian vernaculars in the first five centuries A.D. The drama which gives the best examples of these dialects is the *Mṛcchakaṭikā*. For further particulars regarding the Sanskrit drama, reference should be made to the article **SANSKRIT**.

AUTHORITIES.—The father of Prakrit philology was Ch. Lassen, the author of the *Institutiones linguae prākriticae* (Bonn, 1837). This famous work, a wonderful product of the learning of the time, is now out of date, and has been definitely superseded by R. Pischel's *Grammatik der Prākritisprachen* (Strasbourg, 1900). As an introduction to the study of the language, the best work is H. Jacobi's *Ausgewählte Erzählungen in Māhārāṣṭri zur Einführung in das Studium des Prākrit, Grammatik, Text, Wörterbuch* (Leipzig, 1886). The best editions of the native grammars are E. B. Cowell's of Vararuci's *Prākṛita-prakāśa* (London, 1868), R. Pischel's of Hēmacandra (Halle, 1877, 1889) [see above], and E. Hultzsch's of Śiṃharāja's *Prākṛitarīpavatāra* (London, 1909). For *Dēśya* words, see Pischel's *The Deśināmamāṭā of Hēmacandra* (Bombay, 1880). For *Apabhraṃsa*, in addition to his edition of Hēmacandra's grammar, see the same author's *Materialien zur Kenntnis des Apabhraṃsā* (Berlin, 1902). For the mutual relationship of the various Prakrits, see S. Konow, "Māhārāṣṭri and Mārāṭhī," in the *Indian Antiquary*, (1903), xxxii., 180 sqq. For Jaina Prakrit, see under **JAINS**. As regards the secular texts mentioned above the following are the best editions: A. Weber, *Das Saptataṭakam des Hāla* (Leipzig, 1881); another edition by Durgāprasād and Kāśināth Pāṇḍurang Parab under the title of *The Gāthasapataṭi of Śālvāhana* (Bombay, 1889) [a good commentary]; S. Goldschmidt, *Rāvaṇavaha oder Setubandha* (Strasbourg, 1880–1883) [text and translation]; Śivadatta and Parab, *The Setubandha of Pravarasena* (Bombay, 1895); Shāhkar Pāṇḍurang Paṇḍit, *The Gauḍavaha, a Historical Poem in Prākṛit, by Vākpati* (Bombay, 1887); the same editor, *The Kumārapāla-charita* (Bombay, 1900); *Rājasekhara's Karpūramahījari*, edited by S. Konow, translated by C. R. Lanman (Cambridge, Mass., 1901).

The literature of the Sanskrit drama is given under **SANSKRIT**.
(G. A. GR.)

PRAM (Du. *praam*), the name of a flat-bottomed boat or barge used as a "lighter" for discharging and loading cargo in the ports of the Baltic and North Sea. The word, which is common in various forms to all the languages bordering on those seas, is originally Slavonic; its ultimate etymology connects it with the words found in all Indo-European languages which are to be traced to the root *par-*, to go through, travel; cf. "fare," "ferry," "far," Gr. *πόρος*, way, Lat. *portare*, carry, &c.

PRANTL, KARL VON (1820–1888), German philosopher, was born at Landsberg on the Lech on the 28th of January 1820, and died on the 14th of September 1888 at Oberstdorf. In 1843 he became doctor of philosophy at Munich Observatory, where he was made professor in 1859. He was also a member of the Academies of Berlin and Munich. Strongly in agreement with the Hegelian tradition, he defended and amplified it in *Die gegenwärtige Aufgabe der Philosophie* (1852) and *Verstehen und Beurteilen* (1877). In these works he emphasized the identity of the subjective and the objective for consciousness, and the fact that the perception of this unity is peculiar to man. He is more important, however, as a commentator and scholar, and made valuable contributions to the study of Aristotle. He published *Aristoteles über die Farben* (1849), *Aristoteles' acht Bücher der Physik* (1857), and numerous minor articles on smaller points, such as the authenticity of the thirty-eight books of the *Problems*. The work by which he is best known is the *Geschichte der Logik im Abendland* (Leipzig, 1855–1870). Chr. Sigwart, in the preface to the first edition of his *Logic*, makes "special mention" of the assistance he obtained from this book.

PRATI, GIOVANNI (1815–1884), Italian poet, was born at Dasindo and educated in law at Padua. Adopting a literary career, he was inspired by anti-Austrian feeling and devotion to the royal house of Savoy, and in early life his combination of a sympathy for national independence with monarchical sentiments brought him into trouble in both quarters, Guerrazzi expelling him from Tuscany in 1849 for his praise of Carlo Alberto. In 1862 he was elected a deputy to the Italian parliament, and in 1876 a senator. He died at Rome on the 9th of May 1884. Prati was a prolific poet, his volumes of verse ranging from his romantic narrative *Ermenegarda* (1841) to the lyrics collected in *Psiche* (1875) and *Iside* (1878). His *Opere varie* were published in five volumes in 1875, and a selection in one volume in 1892.

PRATINAS (the quantity of the second vowel is doubtful), one of the oldest tragic poets of Athens, was a native of Phlius in Peloponnesus. About 500 B.C. he competed with Choerilus and Aeschylus, when the latter made his first appearance as a writer for the stage. Pratinas was also the introducer of satyric dramas as a species of entertainment distinct from tragedy, in which the rustic merry-makings and the extravagant dances of the satyrs were retained. The associations of his home, not far from Corinth, where Arion was said to have established the cyclic choruses of satyrs, may account for his preference for this kind of drama. Pratinas was also a writer of dithyrambs and the choral odes called *hyporchemata* (a considerable fragment of one of these is preserved in Athenaeus xiv. 617). It is related that, during the performance of one of his plays, the scaffolding of the wooden stage gave way, in consequence of which the Athenians built a theatre of stone; but recent excavations make it doubtful whether a stone theatre existed in Athens at so early a date. A monument was erected by the inhabitants of Phlius in honour of Pratinas's son Aristias, who, with his father, enjoyed the reputation of excelling all, with the exception of Aeschylus, in the composition of satyric dramas, one of which was called *Cyclops*.

See Pausanias ii. 13; Suidas *g.v.*; fragments in T. Bergk, *Poetae lyrici graeci*, vol. iii.

PRATINCOLE, a word apparently invented by J. Latham (*Synopsis*, v. 222), being the English rendering of *Pratincola*, applied in 1756 by P. Kramer (*Elenchus*, p. 381) to a bird which had hitherto received no definite name, though it had long before been described and even recognizably figured by Aldrovandus (*Ornithologia*, xvii. 9) under the vague designation of "*hirundo marina*." It is the *Glareola pratincola* of modern ornithologists, forming the type of a genus *Glareola*, founded by M. J. Brisson in 1760, belonging to the group *Limicolae*, and constituting together with the coursers (*Cursorius*) a separate family, *Glareolidae*. The pratincoles, of which some eight or nine species have been described, are all small birds, slenderly built and mostly delicately coloured, with a short stout bill, a wide gape, long pointed wings,

and a tail more or less forked. In some of their habits they are thoroughly plover-like, running very swiftly and breeding on the ground, but on the wing they have much the appearance of swallows, and, like them, feed, at least partly, while flying.¹ The ordinary pratincole of Europe, *G. pratincola*, breeds abundantly in many parts of Spain, Barbary and Sicily, along the valley of the Danube, and in southern Russia, while owing to its great powers of flight it frequently wanders far from its home, and more than a score of examples have been recorded as occurring in the British Islands. In the south-east of Europe a second and closely-allied species, *G. nordmanni* or *G. melanoptera*, which has black instead of chestnut inner wing-coverts, accompanies or, farther to the eastward, replaces it; and in its turn it is replaced in India, China and Australia by *G. orientalis*. Australia also possesses another species, *G. grallaria*, remarkable for the great length of its wings and much longer legs, while its tail is scarcely forked—peculiarities that have led to its being considered the type of a distinct genus or sub-genus *Stiltia*. Two species, *G. lactea* and *G. cinerea*, from India and Africa respectively, seem by their pale coloration to be desert forms, and they are the smallest of this curious little group. The species whose mode of nidification is known lay either two or three eggs, stone-coloured, blotched, spotted, and streaked with black or brownish-grey. The young when hatched are clothed in down and are able to run at once—just as are young plovers. (A. N.)

PRATO, a town and episcopal see of Tuscany, Italy, in the province of Florence, 11 m. by rail N.W. of Florence, 207 ft. above sea-level. Pop. (1906), 20,197 (town); 55,298 (commune). It is situated on the Bisenzio, and is dominated by a medieval castle and surrounded by walls of the 11th and 14th centuries. The cathedral of St Stephen was begun in the 12th century in the Tuscan Romanesque style; to this period belongs the narrow nave with its wide arches; the raised transepts and the chapels were added by Giovanni Pisano in 1317-1320; the campanile dates from 1340 (it is a much smaller and less elaborate version of Giotto's campanile at Florence), while the façade, also of alternate white sandstone and green serpentine, belongs to 1413. It has a fine doorway with a bas-relief by Andrea della Robbia over it; but the most striking external feature is the lovely open-air pulpit at an angle of the building, erected by Donatello and Michelozzo for displaying to the people without risk the Virgin's girdle, brought from the Holy Land by a knight of Prato in 1130. The pulpit itself has beautiful reliefs of dancing children; beneath it is a splendid bronze capital. The contract was given out in 1428, but the work was seriously begun only in 1434 and finished in 1438. The Chapel of the Girdle has good frescoes by Agnolo Gaddi (1365), a statue of the Virgin by Giovanni Pisano, and a handsome bronze open-work screen. The frescoes in the choir, with scenes from the life of St John the Baptist and St Stephen, are by Fra Filippo Lippi (1456-1466) and are his best work; the dance of Salome and the lying in state of St Stephen are the finest of the series. Among other works of art may be mentioned the clay statue of the Madonna dell'Ulivo by Benedetto da Maiano. The massive old Palazzo Pretorio (13th century) has been somewhat modified in details; the adjacent Palazzo Comunale contains a small picture gallery

¹ This combination of characters for many years led systematizers astray, though some of them were from the first correct in their notions as to the Pratincole's position. Linnaeus, even in his latest publication, placed it in the genus *Hirundo*; but the interleaved and annotated copies of his *Systema naturae* in the Linnean Society's library show the species marked for separation and insertion in the Order *Grallae*—*Pratincola trachelia* being the name by which he had meant to designate it in any future edition. He seems to have been induced to this change of view mainly through a specimen of the bird sent to him by John White, the brother of Gilbert White; but the opinion published in 1769 by Scopoli (*Ann. I. hist. naturalis*, p. 110) had doubtless contributed thereto, though the earlier judgment to the same effect of Brisson, as mentioned above, had been disregarded. Different erroneous assignments of the form have been made even by recent authors, who neglected the clear evidence afforded by the internal structure of the Pratincole. For instance, Sundevall in 1873 (*Tentamen*, p. 86) placed *Glareola* among the *Caprimulgidae*, a position which osteology shows cannot be maintained for a moment.

with works by Filippo and Filippino Lippi. A beautiful Madonna by the latter (1497) is in a small street shrine at the corner of the Via S. Margherita. The Church of S. Domenico is a Gothic edifice of 1281; that of S. Francesco has an almost Renaissance façade, fine cloisters with a good 15th-century tomb, and a chapter-house with Giottesque frescoes. The Madonna del Buon Consiglio has some good reliefs by Andrea della Robbia, by whom is also the beautiful frieze in the Madonna delle Carceri. This church, by Giuliano da Sangallo (1485-1491), is a Greek cross, with barrel vaults over the arms, and a dome; it is a fine work, and the decoration of the exterior in marble of different colours (unfinished) is of a noble simplicity. Some remains exist of the 13th-century fortress, and the large Piazza Mercatale is picturesque. The works of art visible in Prato are due, as will be seen, entirely to Florentine artists. As a whole the town has a somewhat modern aspect. The industries of Prato embrace the manufacture of woollens (the most important), straw-plaiting, biscuits, hats, macaroni, candles, silk, olive oil, clothing and furniture, also copper and iron works, and printing.

Prato is said to be first mentioned by name in 1107, but the cathedral appears as early as 1048 as the parish church of Borgo Cornio or Santo Stefano. It was subject to the Alberti until 1180, and was then under the Imperial supremacy. It appears to have freed itself from this at the end of the 13th century. In 1313 the town acknowledged the authority of Robert, king of Naples, and in 1350 Niccola Acciajoli, seneschal of Joanna, sold it to the Florentines for 17,500 florins of gold. In 1512 it was sacked by the Spaniards under General Cardona. In 1653 it obtained the rank of city.

See E. Corradini, *Prato* (Bergamo, 1905).

PRATT, ORSON (1811-1881), Mormon apostle, was born of humble parents at Hartford, New York. In 1830 he joined the Mormon Church, becoming a member of its council of twelve in 1834 and one of its twelve apostles in 1835. Pratt was also a mathematician of some note. He was professor of mathematics in the university of Deseret and wrote several books on this subject, these including *Cubic and Biquadratic Equations* (1866). He was a member, and several times speaker, of the Utah House of Representatives. Among his writings may be mentioned *Key to the Universe* (1866), and *The Bible and Polygamy* (1870).

PRAWN, the name of an edible large shrimp-like crustacean in Great Britain usually applied to *Leander serratus* (see SHRIMP). The word is in M. Eng. *prayne* or *prane*, and no cognate forms are found in any other languages. It has been often referred to the Lat. *perna*, a ham-shaped shellfish, but this is due to Florio, who by a mistake glosses *parnocchie*, prawn-fishes or shrimps. The O. Ital. *perna* and *pernocchia* meant a shellfish which yielded "nacre" or mother-of-pearl.

PRAXIAS and **ANDROSTHENES**, Greek sculptors, who are said by Pausanias (x. 19. 4) to have executed the pediments of the temple of Apollo at Delphi. Both were Athenians; Praxias a pupil of Calamis. The statement raises historic difficulties, as, according to the leaders of the recent French excavations at Delphi, the temple of Apollo was destroyed about 373 B.C. and rebuilt by 339 B.C., a date which seems too late for the lifetime of a pupil of Calamis. In any case no fragments of the pediments of this later temple have been found, and it has been suggested that they were removed bodily to Rome.

PRAXILLA, of Sicyon, Greek lyric poetess, one of the so-called nine "lyric" Muses, flourished about 450 B.C. According to Athenaeus (xv. 694), she was famous as a composer of scolia (short lyrical poems sung after dinner), which were considered equal to those of Alcaeus and Anacreon. She also wrote dithyrambs and hymns, chiefly on mystic and mythological subjects, genealogies, and the love-stories of the gods and heroes. A dactylic metre was also called by her name.

Fragments in T. Bergk, *Poetae lyriici graeci*, vol. iii.; see also C. F. Neue, *De Praxillae Sicyoniae reliquiis* (progr. Dorpat, 1844).

PRAXITELES, of Athens, the son of Cephissodotus, the greatest of the Attic sculptors of the 4th century B.C., who has left an imperishable mark on the history of art. It has been maintained by some writers that there were two sculptors of the name, one a contemporary of Pheidias, the other, more

celebrated, of two generations later. This duplication is defended in Furtwängler's *Masterpieces of Greek Sculpture* (pp. 99, 102, seq.) but on insufficient grounds. There is, however, no reason why the great Praxiteles should not have had a grandfather of the same name: all that we can say is that at present we have no certain evidence that this was the case.

Though Praxiteles may be considered as in some ways well known to us, yet we have no means for fixing his date accurately. It seems clear that he was no longer working in the time of Alexander the Great, or that king would have employed him. Pliny's date, 364 B.C., is probably that of one of his most noted works.

Our knowledge of Praxiteles has received a great addition, and has been placed on a satisfactory basis, by the discovery at Olympia in 1877 of his statue of Hermes bearing the infant Dionysus, a statue which has become famous throughout the world (GREEK ART, fig. 43 and Plate VI. fig. 82). Hermes is represented as in the act of carrying the child Dionysus to the nymphs who were charged with his rearing. He pauses on the way, and holds out to the child a bunch of grapes to excite his desire. The young child can hardly be regarded as a success; he is not really childlike. But the figure of the Hermes, full and solid without being fleshy, at once strong and active, is a masterpiece, and the play of surface is astonishing. In the head we have a remarkably rounded and intelligent shape, and the face expresses the perfection of health and enjoyment.

This statue must for the future be our best evidence for the style of Praxiteles. It altogether confirms and interprets the statements as to Praxiteles made by Pliny and other ancient critics. Gracefulness in repose, and an indefinable charm are also the attributes of works in our museums which appear to be copies of statues by Praxiteles. Perhaps the most notable of these are the Apollo Sauroctonus, or the lizard-slayer, a youth leaning against a tree and idly striking with an arrow at a lizard, and the Aphrodite at the bath (GREEK ART, Plate V., fig. 71) of the Vatican, which is a copy of the statue made by Praxiteles for the people of Cnidus, and by them valued so highly that they refused to sell it to King Nicomedes, who was willing in return to discharge the whole debt of the city, which, says Pliny, was enormous.

The Satyr of the Capitol at Rome has commonly been regarded as a copy of one of the Satyrs of Praxiteles; but we cannot identify it in the list of his works. Moreover, the style is hard and poor; a far superior replica exists in a torso in the Louvre. The attitude and character of the work are certainly of Praxitelean school.

Excavations at Mantinea in Arcadia have brought to light the basis of a group of Leto Apollo and Artemis by Praxiteles. This basis was doubtless not the work of the great sculptor himself, but of one of his assistants. Nevertheless it is pleasing and historically valuable. Pausanias (viii. 9, 1) thus describes the base, "on the base which supports the statues there are sculptured the Muses and Marsyas playing the flutes." Three slabs which have survived represent Apollo, Marsyas, a slave, and six of the Muses, the slab which held the other three having disappeared.

A head of Aphrodite at Petworth in England, and a head of Hermes in the British Museum (Aberdeen Hermes), have lately been claimed by competent authorities as actual works of Praxiteles. Both are charming works, but rather by the successors of Praxiteles than by himself.

Besides these works, connected with Praxiteles on definite evidence, there are in our museums works without number of the Roman age, statues of Hermes, of Dionysus, of Aphrodite, of Satyrs and Nymphs and the like, in which a varied amount of Praxitelean style may be discerned. Four points of composition may be mentioned, which appear to be in origin Praxitelean: (1) a very flexible line divides the figures if drawn down the midst from top to bottom; they all tend to lounging; (2) they are adapted to front and back view rather than to being seen from one side or the other; (3) trees, drapery and the like are used for supports to the marble figures, and included in the

design, instead of being extraneous to it; (4) the faces are presented in three-quarter view.

The subjects chosen by Praxiteles were either human beings or the less elderly and dignified deities. It is Apollo, Hermes and Aphrodite who attract him rather than Zeus, Poseidon or Athena. And in his hands the deities sink to the human level, or, indeed, sometimes almost below it. They have grace and charm in a supreme degree, but the element of awe and reverence is wanting.

Praxiteles and his school worked almost entirely in marble. At the time the marble quarries of Paros were at their best; nor could any marble be finer for the purposes of the sculptor than that of which the Hermes is made. Some of the statues of Praxiteles were coloured by the painter Nicias, and in the opinion of the sculptor they gained greatly by this treatment.

(P. G.)

PRAYER (from Lat. *precari*, entreat; Ital. *pregaria*, Fr. *prière*), a term used generally for any humble petition, but more technically, in religion, for that mode of addressing a divine or sacred power in which there predominates the mood and intention of reverent entreaty.

Prayer and its Congeners.—Prayer in the latter sense is a characteristic feature of the higher religions, and we might even say that Christianity or Mahommedanism, ritually viewed, is in its inmost essence a service of prayer. At all stages of religious development, however, and more especially in the case of the more primitive types of cult, prayer as thus understood occurs together with, and shades off into, other varieties of observance that bear obvious marks of belonging to the same family.

Confining ourselves for the moment to forms of explicit address, we may group these under three categories according as the power addressed is conceived by the applicant to be on a higher, or on much the same, or on a lower plane of dignity and authority as compared with himself. (1) Only if the deity be regarded as altogether superior is there room for prayer proper, that is, reverent entreaty. Of this we may perhaps roughly distinguish a higher and a lower type, according as there is either complete confidence in the divine benevolence and justice, or a disposition to suppose a certain arbitrariness or at any rate conditionality to attach to the granting of requests. In the first case prayer will be accompanied with disinterested homage, praise and thanksgiving, and will in fact tend to lose its distinctive character of entreaty or petition, passing into a mystic communing or converse with God. In the second case it will be supported by pleading, involving on the one hand self-abasement, with confession of sins and promises of repentance and reform, or on the other hand self-justification, in the shape of the expression of faith and recitation of past services, together with reminders of previous favour shown. (2) If, however, the worshipper place his god on a level with himself, so far at any rate as to make him to some extent dependent on the service man contracts to render him, then genuine prayer tends to be replaced by a mere bargaining, often conjoined with flattery and with insincere promises. This spirit of *do ut des* will be found to go closely with the gift-theory of sacrifice, and to be especially characteristic of those religions of middle grade that are given over to sacrificial worship as conducted in temples and by means of organized priesthoods. Not but what, when the high gods are kind for a consideration, the lower deities will likewise be found addicted to such commerce; thus in India the hedge-priest and his familiar will bandy conditions in spirited dialogue audible to the multitude (cf. W. Crooke, *Things Indian*, s.v. "Demonology," pp. 132, 134). (3) Lastly, the degree of dependency on human goodwill attributed to the power addressed may be so great that, instead of diplomatic politeness, there is positive hectoring, with dictation, threats and abuse. Even the Italian peasant is said occasionally to offer both abuse and physical violence to the image of a recalcitrant saint; and antiquity wondered at the bullying manner of the Egyptians towards their gods (cf. Iamblichus, *De mysteriis*, vi. 5-7). This frame of mind, however, is mainly symptomatic of the lower levels

of cult. Thus the Zulu says to the ancestral ghost, "Help me or you will feed on nettles"; whilst the still more primitive Australian exclaims to the "dead hand" that he carries about with him as a kind of divining-rod, "Guide me aright, or I throw you to the dogs."

So far we have dealt with forms of address explicitly directed towards a power that, one might naturally conclude, has personality, since it is apparently expected to hear and answer. At the primitive stage, however, the degree of personification is, probably, often far slighter than the words used would seem to suggest. The verbal employment of vocatives and of the second person may have little or no personifying force, serving primarily but to make the speaker's wish and idea intelligible to himself. When the rustic talks in the vernacular to his horse he is not much concerned to know whether he is heard and understood; still less when he mutters threats against an absent rival, or kicks the stool that has tripped him up with a vicious "Take that!"

These considerations may help towards the understanding of a second class of cases, namely forms of implicit address shading off into unaddressed formulas. Wishes, blessings, cursings, oaths, vows, exorcisms, and so on, are uttered aloud, doubtless partly that they may be heard by the human parties to the rite, but likewise in many cases that they may be heard, or at least overheard, by a sentient deity, perhaps represented visibly by an idol or other cult-object. The ease with which explicit invocations attach themselves to many of these apparently self-contained forms proves that there is not necessarily any perceived difference of kind, and that implicit address as towards a "something not-ourselves" is often the true designation of the latter. On the other hand, there is reason to believe that the magical spell proper is a self-contained and self-sufficient form of utterance, and that it lies at the root of much that has become address, and even prayer in the fullest sense.

From Spell to Prayer.—Of course to address and entreat a fellow-being is a faculty as old as that of speech, and, as soon as it occurred to man to treat sacred powers as fellow-beings, assuredly there was a beginning of prayer. We do not know, and are not likely to know, how religion first arose, and the probability is that many springs went to feed that immense river. Thus care for the dead may well have been one amongst such separate sources. It is natural for sorrow to cry to the newly dead "Come back!" and for bereavement to add "Come back and help!" Another source is mythologic fancy, which, in answer to childlike questions; "Who made the world?" "Who made our laws?" and so on, creates "magnified non-natural men," who presently made their appearance in ritual (for to think a thing the savage must dance it); whereupon personal intercourse becomes possible between such a being and the tribesmen, the more so because the supporters of law and order, the elders, will wish to associate themselves as closely as possible with the supreme law-giver. From Australia, where we have the best chance of studying rudimentary religion in some bulk, comes a certain amount of evidence showing that in the two ways just mentioned some inchoate prayer is being evolved. On the other hand, it is remarkable how conspicuous, on the whole, is the absence of prayer from the magico-religious ritual of the Australians. Uttered formulas abound; yet they are not forms of address, but rather the self-sufficient pronouncements of the magician's *fiat*. Viewed analytically in its developed nature, magic is a wonder-working recognized as such, the core of the mystery consisting in the supposed transformation of suggested idea into accomplished fact by means of that suggestion itself. To the magician, endowed in the opinion of his fellows (and doubtless of himself) with this wonderful power of effective suggestion, the output of such power naturally represents itself as a kind of unconditional willing. When he cries "Rain, rain," or otherwise makes vivid to himself and his hearers the idea of rain, expecting that the rain will thereby be forced to come, it is as if he had said "Rain, now you must come," or simply "Rain, come!" and we find as a fact that

magical formulas mostly assume the tone of an actual or virtual imperative, "As I do this, so let the like happen," "I do this in order that the like may happen," and so on. Now it is easy to "call spirits from the vasty deep," but disappointed experience shows that they will not always come. Hence such imperatives have a tendency to dwindle into optatives. "Let the demon of small-pox depart!" is replaced by the more humble "Grandfather Smallpox, go away!" where the affectionate appellative (employed, however, in all likelihood merely to cajole) signalizes an approach to the genuine spirit of prayer. Again, the magician conscious of his limitations will seek to supplement his influence—his *mana*, as it is termed in the Pacific—by tapping, so to speak, whatever sources of similar power lie round about him; and these the "magomorphism" of primitive society perceives on every hand. A notable method of borrowing power from another magic-wielding agency is simply to breathe its name in connexion with the spell that stands in need of reinforcement; as the name suggests its owner, so it comes to stand for his real presence. It is noticeable that even the more highly developed forms of liturgical prayer tend, in the recitation of divine titles, attributes and the like, to present a survival of this magical use of potent names.

Prayer as a Part of Ritual.—An exactly converse process must now be glanced at, whereby, instead of growing out of it, prayer actually generates spell. In advanced religion, indeed, prayer is the chosen vehicle of the free spirit of worship. Its mechanism is not unduly rigid, and it is largely autonomous, being rid of subservience to other ritual factors. In more primitive ritual, however, set forms of prayer are the rule, and their function is mainly to accompany and support a ceremony the nerve of which consists in action rather than speech. Hence, suppose genuine prayer to have come into being, it is exceedingly apt to degenerate into a mere piece of formalism; and yet, whereas its intrinsic meaning is dulled by repetition according to a well-known psychological law, its virtue is thereby hardly lessened for the undeveloped religious consciousness, which holds the saving grace to lie mainly in the repetition itself. But a formula that depends for its efficacy on being uttered rather than on being heard is virtually indistinguishable from the self-sufficient spell of the magician, though its origin is different. A good example of a degenerated prayer-ritual comes from the Todas (see W. H. R. Rivers, *The Todas*, ch. x.). The prayer itself tends to be slurred over, or even omitted. On the other hand, great stress is laid on a preliminary citation of names of power followed by the word *idith*. This at one time seems to have meant "for the sake of," carrying with it some idea of supplication; but it has now lost this connotation, seeing that it can be used not merely after the name of a god, but after that of any sacred object or incident held capable of imparting magic efficacy to the formula. Even the higher religions have to fight against the tendency to "vain repetitions" (often embodying a certain sacred number, e.g. three), as well as to the use of prayers as amulets, medicinal charms, and so on. Thus, Buddhism offers the striking case of the praying-wheel. It remains to add that throughout we must carefully distinguish in theory, however hard this may be to do in practice, between legitimate ritual understood as such, whether integral to prayer, such as its verbal forms, or accessory, such as gestures, postures, incense, oil or what not, and the formalism of religious decay, such as generally betrays itself by its meaninglessness, by its gibberish phrases, sing-song intonation and so forth.

Silent Prayer.—A small point in the history of prayer, but one that has an interesting bearing on the subject of its relation to magic, is concerned with the custom of praying silently. Charms and words of power being supposed to possess efficacy in themselves are guarded with great secrecy by their owners, and hence, in so far as prayer verges on spell, there will be a disposition to mutter or otherwise conceal the sacred formula. Thus the prayers of the Todas already alluded to are in all cases uttered "in the throat," although these are public prayers, each village having a form of its own. At a later stage, when the distinction between magic and religion is more clearly recognized

and an anti-social character assigned to the former on the ground that it subserves the sinister interests of individuals, the overt and as it were congregational nature of the praying comes to be insisted on as a guarantee that no magic is being employed (cf. Apuleius, *Apol.* 54, "tacitas preces in templo dis allegasti: igitur magus es"), a notion that suffers easy translation into the view that there are more or less disreputable gods with whom private trafficking may be done on the sly (cf. Horace, *Ep.* I. xvi. 60, "labra movet metuens audiri, Pulchra Laverna, da mihi fallere"). Thus it is quite in accordance with the outlook of the classical period that Plato in his *Laws* (900-910) should prohibit all possession of private shrines or performance of private rites; "let a man go to a temple to pray, and let any one who pleases join with him in the prayer." Nevertheless, instances are not wanting amongst the Greeks of private prayers of the loftiest and most disinterested tone (cf. L. R. Farnell, *The Evolution of Religion*, p. 202 seq.). Finally we may note in this connexion that in advanced religion, at the point at which prayer is coming to be conceived as communion, silent adoration is sometimes thought to bring man nearest to God.

The Moralization of Prayer.—When we come to consider the moral quality of the act of prayer, this contrast between the spirit of public and private religion is fundamental for all but the most advanced forms of cult. In its public rites the community becomes conscious of common ends and a common edification. We may observe how even a very primitive people such as the Arunta of Australia behaves with the greatest solemnity at its ceremonies, and professes to be made "glad" and "strong" thereby; whilst of his countrymen, whom he would not trust to pray in private, Plato testifies that in the temples during the sacrificial prayers "they show an intense earnestness and with eager interest talk to the Gods and beseech them" (*Laws*, 887). We may therefore assume that, in acts of public worship at any rate, prayer and its magico-religious congeners are at all stages resorted to as a "means of grace," even though such grace do not constitute the expressed object of petition. Poverty of expression is apt to cloak the real spirit of primitive prayer, and the formula under which its aspirations may be summed up, namely, "Blessings come, evils go," covers all sorts of confused notions about a grace to be acquired and an impurity to be wiped away, which, as far back as our clues take us, invite interpretations of a decidedly spiritualistic and ethical order. To explicate, however, and purge the meaning of that "strong heart" and "clean" which the savage after his fashion can wish and ask for, remained the task of the higher and more self-conscious types of religion. A favourite contrast for which there is more to be said is that drawn between the magico-religious spell-ritual, that says in effect, "My will be done," and the spirit of "Thy will be done" that breathes through the highest forms of worship. Such resignation in the face of the divine will and providence is, however, not altogether beyond the horizon of primitive faith, as witness the following prayer of the Khonds of Orissa: "We are ignorant of what it is good to ask for. You know what is good for us. Give it to us." (Tylor, *Prim. Culture*, 4. 369.) At this point prayer by a supreme paradox virtually extinguishes itself, since in becoming an end in itself, a means of contemplative devotion and of mystic communing with God, it ceases to have logical need for the petitionary form. Thus on the face of it there is something like a return to the self-sufficient utterance of antique religion; but, in reality, there is all the difference in the world between a suggestion directed outwardly in the fruitless attempt to conjure nature without first obeying her, and one directed towards the inner man so as to establish the peace of God within the heart.

BIBLIOGRAPHY.—The following works deal generally with the subject of prayer from the comparative standpoint: E. B. Tylor, *Primitive Culture*, ch. 18 (1903); C. Tiele, *Elements of the Science of Religion* (Gifford lectures, lect. 6) (1897); F. Max Müller, "On Ancient Prayers," in *Semitic Studies in Memory of Rev. Dr Alexander Kohut* (1897); L. R. Farnell, *The Evolution of Religion*, lect. 4 (1905). For special points the following may be consulted: Prayer in relation to magic: R. R. Marett, "From Spell to Prayer," in *Folk-Lore*

(June, 1904); W. W. Skeat, *Malay Magic* (1900). Degeneration of prayer: W. H. R. Rivers, *The Todas*, ch. 10 (1906). Use of the name of power: F. Giesebrecht, *Die alttestamentliche Schätzung des Gottesnamens* (1901); W. Heitmüller, *Im Namen Jesu* (1903). Silent prayer: S. Sudhaus, "Lautes und leises Beten" in *Archiv für Religionswissenschaft*, 185 seq. (1906). Beginnings of Prayer in Australia: A. W. Howitt, *The Native Tribes of South-East Australia*, 394, cf. 546 (1904); K. Langloh Parker, *The Euahlayi Tribe*, 79 seq. (1905); the evidence discussed in *Man*, 2, 42, 72 (1907). Prayer and spell in North American religion: W. Matthews, "The Prayer of a Navajo Shaman," in *American Anthropologist*, i.; idem, "The Mountain Chant; a Navajo Ceremony," in *Fifth Report of Bureau of American Ethnology*; J. Mooney, "The Sacred Formulas of the Cherokees," (7th Repl. 1891). Greek prayer: C. Ausfeld, *De graecorum precationibus quaestiones* (1903). Christian prayer: E. von der Goltz, *Das Gebet in der ältesten Christenheit* (1901); id., *Tischgebete und Abendmahlsgebete* (1905); O. Dibelius, *Das Vaterunser: Umriss zu einer Geschichte des Gebets in der alten und mittleren Kirche* (1903); T. K. Cheyne, article "Prayer," in *Ency. Bib.* (1902). (R. R. M.)

PRAYER, BOOK OF COMMON, the title of the official service book of the Church of England. One of the most important steps taken at the Reformation was the compilation and provision of a comprehensive service book for general and compulsory use in public worship in all cathedral and parish churches throughout the Church of England.

Apart from alterations in detail, both as to doctrine and ritual, which will be referred to later, the following main advantages were achieved from the very first and apply to all editions of the Prayer Book equally.

1. The substitution of the English language for the Latin language, which had hitherto been in universal and almost complete use, and in which all the old service books were written.

2. Unification and simplification. The number of books required for the performance of divine service in pre-Reformation days was very large; the most important being the Missal for the service of Holy Communion or the Mass; the Breviary for the daily service or performance of the divine office; the Manual for the minor sacramental offices usually performed by the parish priest; and the Pontifical, containing such services as were exclusively reserved for performance by the bishop. Many of the contents of these larger volumes were published in separate volumes known by a great variety—over one hundred—different names. The Prayer Book represents in a much condensed and abbreviated form the four chief ancient service books, viz.: the Missal, Breviary, Manual and Pontifical.

In addition to a multiplicity of books there was much variety of use. Although the Sarum Use prevailed far the most widely, yet there were separate Uses of York and Hereford, and also to a less degree of Lincoln, Bangor, Exeter, Wells, St Paul's, and probably of other dioceses and cathedral churches as well. Cranmer's preface "Concerning the Service of the Church" expressly mentions the abolition of this variety as one of the things to be achieved by a Book of Common Prayer. It says: "And whereas heretofore there hath been great diversity in saying and singing in Churches within this Realm; some following Salisbury Use, some Hereford Use, and some the Use of Bangor, some of York, some of Lincoln; now from henceforth all the whole Realm shall have but one Use."

We will next enumerate the sources from which the Prayer Book was compiled. 1. It has been already indicated that the older pre-Reformation service books formed the main quarry, especially those according to the Use of Sarum. Morning and Evening Prayer, including the psalter and the lessons, were taken from the Breviary, Matins being compiled out of Nocturns (or Matins), Lauds and Prime; and Evensong out of Vespers and Compline. The Order of Holy Communion, including the collects, epistles and gospels, was taken from the Missal. The sacramental and other offices which occupy a position in the Prayer Book between the Order of Holy Communion and the Psalms were taken from the Manual; and the services for consecration or ordering of bishops, priests and deacons were taken from the Pontifical; but in all cases not only with a change of Latin into English, but with numerous alterations, omissions and additions.

2. The reformed Latin Breviary of Cardinal Quignon, Francis de Quiñones, a Spaniard, a Franciscan and cardinal of the Holy Cross, brought out a reformed Latin breviary with papal sanction in 1535. A second and revised edition appeared in 1537. It met with considerable favour, and was adopted into use in many places, without, however, winning universal acceptance, and in 1558 papal

sanction was withdrawn and it ceased to be printed. From this reformed breviary the compilers of the Prayer Book borrowed the following. (a) Many passages—almost verbatim—in the preface "Concerning the Service of the Church." It would occupy too much space to print them in parallel columns here. (b) Making the Sunday and Holy-day services identical in structure with the week-day services. (c) The removal of all antiphons and responds. This refers to Quignon's first edition only. (d) The increased amount of Holy Scripture read. Quignon provided a first lesson from the Old Testament; a second lesson from the New Testament; and on Saints' Days a third lesson from the Lives of the Saints, though this lesson was also occasionally taken from Holy Scripture. (e) The prefixing to every service a form of confession and absolution. The idea, not the actual language, is borrowed by the Prayer Book. (f) The substitution of the Athanasian Creed for the Apostles' Creed on certain days instead of the former being an addition to the latter. So in the Prayer Book, when used, the Athanasian Creed is substituted for, not added to, the shorter creed. (g) The uniform assignment of three Psalms to each hour suggests the average number and arrangement of the Psalms in the Prayer Book at Matins and Evensong.

3. The Mozarabic Missal. (a) The four short prayers preceding the prayer for the consecration of the water in the office for the public baptism of infants are adapted from the benediction of the font in the Mozarabic Liturgy (Migne, *Pat. Lat.* tom. lxxxv. col. 465). The evidence for this borrowing is still plainer in the larger form of prayer for this purpose provided in the first book of Edward VI. The Mozarabic Liturgy was printed and published under Cardinal Ximenes in 1500, and may well have been in Cranmer's hands; whereas the *Missale gallicanum*, a Gallican Sacramentary, containing the same prayers with slight variations, was first published by Cardinal Thomesius in 1680 and must have been unknown to Cranmer. (b) According to F. Procter and W. H. Frere (*A New History of the Book of Common Prayer*, p. 375; London, 1902), the use of the plural number instead of the singular in the form of the opening versicles of Morning and Evening prayer is a following of Mozarabic usage. But we have been unable to verify this statement. (c) Many of the new collects introduced into the Prayer Book, though not transferred bodily from any Mozarabic service book, are modelled upon a Mozarabic pattern, and preserve some Mozarabic ideas and phrases, e.g. the references to the Second Advent in the collects for the first and third Sundays in Advent take their tone from the Mozarabic Advent services. The collect for Christmas Day is based on a collect for Christmas Day Lauds in the Mozarabic Breviary (Migne, *Pat. Lat.* tom. lxxxvii. col. 122). The collect for the first Sunday in Lent is based on a preface (Inlatio) in the Mass for the Wednesday after the fifth Sunday in Lent (*ibid.*, tom. lxxxv. col. 382). The collect for the first Sunday after Easter is based upon an "Alia Oratio" (*ibid.*, col. 517), and an "Oratio ad pacem" (col. 518) for the Saturday in Easter week. The collect for St. Andrew's Day is based on a Missa in the Mozarabic Mass for the same festival (*ibid.*, col. 159). Other examples might be given, but this is hardly the place for complete details. (d) The many addresses, beginning with "Dearly beloved brethren" ("the Scripture moveth us," &c.), introduced into most of the services in the Prayer Book, correspond to the addresses which, under the title of "Missa," and generally addressed to "fratres dilectissimi" or "carissimi," form part of every Mozarabic Mass. (e) The prayer of consecration in the Order of Holy Communion, especially as regards the recital of the words of institution commencing "Who in the same night," &c., follows a Mozarabic rather than the Sarum or Roman model in several respects, but the same features are found in the consecration prayer in the Brandenburg-Nürnberg agenda of 1533, and it is doubtful whether the Anglican borrowing is from a Mozarabic or a Lutheran source. Possibly both the Anglican and Lutheran formulae are derived independently from the Mozarabic; because, as we have seen, a Mozarabic missal was certainly in Cranmer's hands and studied by him.

4. Eastern Liturgies. These were certainly known to Cranmer, but it is remarkable how little he borrowed from them. (a) The prayer which was placed at the end of the Litany in 1549, and now stands as the last prayer but one at the end of Matins and Evensong, as well as of the Litany, was undoubtedly borrowed from the Liturgy of St. Chrysostom, where, as likewise in the Liturgy of St. Basil, it forms the prayer of the third antiphon after the Deacon's Litany in the Mass of the Catechumens. (b) The concluding prayer of Matins and Evensong, "The Grace of our Lord," &c., which was added in 1662, may have been taken from Greek liturgies. It is the opening salutation in the Mass of the Catechumens in the Clementine Liturgy, where it occurs again, as it does in the Greek Liturgies before the "Sursum corda"; though there is no evidence to prove that it was not taken directly from Holy Scripture (2 Cor. xiii. 14). (c) The Epiklesis or invocation of the Holy Spirit upon the elements, must have been copied from an Eastern Liturgy. It occurs in the 1549 Prayer Book, but has been omitted in all subsequent editions. It runs thus: "Hear us, O merciful Father, we beseech Thee, and with Thy holy Spirit and word vouchsafe to bless and sanctify these Thy gifts and creatures of bread and wine, that they may be unto us the body and blood of Thy most dearly beloved Son Jesus Christ."

This is not an exact translation of any known *epiklesis*, and Cranmer altered its position from after to immediately before the words of institution. (d) Four petitions in the Litany. "That it may please Thee to illuminate all Bishops, Priests and Deacons," &c. (altered in 1661 from all Bishops, pastors and ministers) and "That it may please Thee to give to all nations unity, peace and concord," and "That it may please Thee to succour, help and comfort all that are in danger, necessity and tribulation," and "That it may please Thee to preserve all that travel by land or by water, all women labouring of child, all sick persons, and young children, and to show Thy pity upon all prisoners and captives!" are almost certainly modelled on corresponding petitions in the Deacon's Litany in the Liturgy of St. Chrysostom (ed. F. E. Brightman, p. 362, l. 35, and p. 363, lines 4, 17, 15). At least, they resemble far more closely the Greek petitions than they do any corresponding Latin petitions in the Old Sarum Litany.

5. Lutheran and other continental Protestant service books. The most considerable quantity of the new material which was imported into the Prayer Book was drawn from Lutheran and Genevan service books. The Litany, for example, in the Prayer Book is based upon the medieval Latin Litany, but great variation both in substance and language and by way of addition and omission, are made in it. These variations are largely borrowed from and closely follow the language of various Lutheran litanies, especially that given in the consultation of Archbishop Hermann of Cologne issued in 1543. Lutheran influence can likewise be traced in way of variation introduced into the baptismal and other sacramental or occasional offices. So in the Communion service the most striking departures from ancient precedent have a Protestant origin. The introduction of the Ten Commandments in 1553 seems to be derived from the order of service published by Valerandus Pollanus (Pullain) in 1551; and that of the Comfortable Words in 1549 is borrowed, though all the texts chosen are not identical, from the Consultation of Hermann. It is impossible to pursue this subject here further in detail.

6. Original compositions of the compilers of the Prayer Book, not traceable to ancient or 16th-century originals. These are not numerous. They include most of the collects on Saints' Days, for which, though no direct evidence of authorship is as yet forthcoming, Cranmer is probably responsible, and certain other collects, such as that for the Royal Family (Archbishop Whitgift); that for the high court of parliament (Archbishop Laud); that for all conditions of men (Bishop Gunning), &c.

We proceed to describe next the various stages through which the Book of Common Prayer has passed and the leading features of each revision. Of changes preceding the first Prayer Book it will only be necessary to mention here: (a) The compiling and publishing of the Litany in English by Cranmer in 1544. (b) Royal injunctions in August 1547 ordering the Epistle and Gospel to be read in English at High Mass. (c) A royal proclamation, dated the 8th of March 1548, imposing for use at the coming Easter *The Order of the Communion*. This was an order or form of service in English for the communion of the people in both kinds. It was to be inserted into the service after the communion of the priest, without making any other alteration in the Latin Mass. It comprised the long exhortation or notice to be given on Sunday, or on some other day, previous to the Communion, the longer exhortation, and the shorter invitation, the confession, absolution, comfortable words, prayer of humble access, formulae of administration and the concluding peace, all as they exist at present, though with variations of some importance.

The first complete vernacular Book of Common Prayer was issued in 1549. It was carried through both houses of parliament by the 21st of January 1549, by an Act of Uniformity which made its use compulsory on and after the following Whit-Sunday. The exact date of the giving of the royal assent, and the question whether this Book received the assent of Convocation, are historical points of difficulty and uncertainty which cannot be treated at length here.

Some of the chief points of difference between this and subsequent Prayer Books were the following: Matins and Evensong began with the Lord's Prayer, and ended with the third collect; there were no alternative Psalm-canticles for Benedictus, Magnificat and Nunc Dimittis; the Athanasian Creed was introduced after the Benedictus on six festivals only, and in addition to the Apostles' Creed; the Litany was placed after the Communion service, for which an alternative title was given, viz.: "commonly called the Mass." Introits were provided for use on every Sunday and Holy-Day; after the offertory

intending communicants were directed to "tarry still in the quire or in some convenient place nigh the quire"; in the prayer "for the whole state of Christ's church," the blessed Virgin Mary was commemorated by name among departed saints; prayer for the departed was explicitly retained; also an invocation of the Holy Spirit before the words of institution, the prayer of oblation immediately following them. The mixed chalice was ordered to be used, and the Agnus Dei to be sung during the Communion of the people. A large selection of short scriptural post-Communions was provided. Unleavened bread was to be used and placed not in the hand but in the mouth of the communicant. The sign of the cross was to be made not only in the eucharistic consecration prayer, but also in Baptism, Confirmation, Holy Matrimony and the Visitation of the Sick. Reservation for the sick and unction of the sick were retained; and exorcism, unction, trine immersion and the chrisom were included in the baptismal service. The prayer in the burial service, as in the Communion service, contained distinct intercessions for the departed; and a form of Holy Communion was provided for use at funerals with proper introit, collect, epistle and gospel.

As to vestments, in the choir offices, the surplice only was to be used; the hood being added in cathedrals and colleges; and by all graduates when preaching, everywhere.

At Holy Communion the officiating priest was to wear "a white Albe plain with a vestment or Cope," and the assistant clergy were to wear "Albes with tunicles." Whenever a bishop was celebrant he was to wear, "beside his rochette, a surplice or albe, and a cope or vestment," and also to carry "his pastoral staff in his hand, or else borne or holden by his chaplain." The mitre was not mentioned.

The ordinal was not attached to this Prayer Book at its first appearance, but it was added under another act of parliament in the following year, 1550. It was very similar to the present ordinal except that the words "for the office and work of a Priest in the Church of God, now committed unto thee by the Imposition of our hands" were wanting, and the chalice or cup with the bread were delivered, as well as a Bible, to each newly-ordained priest.

We pass on to 1552 when a new and revised edition of the Prayer Book was introduced by an act of parliament which ordered that it should come into use on All Saints' Day (Nov. 1). The alterations made in it were many and important, and as they represent the furthest point ever reached by the Prayer Book in a Protestant direction, they deserve special mention and attention.

1. The introductory sentences, exhortation, confession and absolution were prefixed to the Order for Morning Prayer daily throughout the year and ordered to be read before Evening Prayer as well. Alternative Psalms were provided for Benedictus, Magnificat and Nunc Dimittis.

2. Numerous and most important alterations were made in the Order for Holy Communion, in the title of which the words "commonly called the Mass" were left out. (a) The Introits were omitted. (b) Gloria in excelsis was transferred from near the beginning to near the end of the service. (c) The ten commandments with an expanded tenfold Kyrie eleison were introduced. (d) The long new English canon of 1549 was split up into three parts: the first part becoming the prayer for the church militant; the second part becoming the prayer of consecration, the third part, or prayer of oblation, becoming the first post-Communion collect; the epiklesis or invocation of the Holy Ghost upon the elements was entirely omitted. (e) The mixed chalice, the use of the sign of the cross in the consecration prayer; the commemoration of the blessed Virgin Mary and of various classes of saints were omitted. (f) The Agnus Dei and the post-Communion anthems were omitted. (g) The words of administration in the 1549 hook were abolished, viz.: "The body of our Lord Jesus Christ which was given for thee, preserve thy body and soul unto everlasting life," and "The blood of our Lord Jesus Christ which was shed for thee preserve thy body and soul unto everlasting life," and the following words were

substituted: "Take and eat this in remembrance that Christ died for thee, and feed on him in thy heart by faith, with thanksgiving," and "Drink this in remembrance that Christ's blood was shed for thee, and be thankful." (h) A long rubric was added at the end of the service explanatory of the attitude of kneeling at the reception of Holy Communion, in which it was stated that "it is not meant hereby that any adoration is done, or ought to be done, either unto the sacramental bread and wine there bodily received, or to any real and essential presence there being of Christ's natural flesh and blood," &c. (i) Exorcism, unction, trine immersion and the chrisom were omitted from the baptismal service. (k) Unction and communion with the reserved sacrament were removed from the services for the visitation and the communion of the sick. (l) Prayers for the dead and provision for a celebration of Holy Communion at a funeral were removed from the burial service. (m) The vestments retained and ordered under the Prayer Book of 1549 were abolished by a new rubric which directed that both at the time of Communion and at all other times of ministration a bishop should wear a rochet and that a priest or deacon should have and wear a surplice only; (n) on the other hand, the directions as to daily service were extended to all clergy and made much stricter, (o) and the number of days on which the Athanasian Creed was to be used was raised from six to thirteen.

The main objects of these drastic alterations have been thought to have been two-fold.

1. To abolish all ritual for which there was not scriptural warrant. If this was their object it was not consistently or completely carried out. No scriptural warrant can be found for the use of the surplice, or for the use of the sign of the cross in baptism, both of which were retained.

2. To make the services as unlike the pre-Reformation services as possible. This object too was not fully attained; no liturgical precedent can be found for the violent dislocation of certain parts of the Order for Holy Communion, especially in the case of the prayer of oblation and of the Gloria in Excelsis; but the orders for Morning and Evening Prayer and the Holy Communion retained features of the Breviary and Missal services, the bulk of their component material being still drawn from them. While the alterations, therefore, were violent enough to alarm and offend the Catholic party, they were not violent enough to satisfy the extreme Puritan party, who would no doubt have agitated for and would probably have obtained still further reformation and revision. But this Prayer Book only lived for eight months. It came into use on All Saints' Day (Nov. 1) 1552, and on the 6th of July 1553 Edward VI. died and was succeeded by his sister Mary, under whom the Prayer Book was abolished and the old Latin services and service books resumed their place.

On the death of Queen Mary and the accession of her sister Elizabeth (Nov. 17, 1558) all was reversed, and the Book of Common Prayer was restored into use again.

The Act of Uniformity, which obtained final parliamentary authority on the 28th of April 1559, ordered that the Prayer Book should come again into use on St John the Baptist's Day (June 24, 1559). This was the second Prayer Book of King Edward VI., with the following few but important alterations, which, like all the alterations introduced at subsequent dates into the Prayer Book, were in a Catholic rather than in a Protestant direction.

1. Morning and Evening Prayer were directed to be "used in the accustomed place of the church, chapel or chancel, instead of "in such place as the people may best hear."

2. The rubric ordering the use of the rochet only by the bishop and of surplice only by a priest or deacon was abolished. The eucharistic vestments ordered in the first Prayer Book of Edward VI. were brought back by a new rubric which directed that "the minister at the time of the communion and at all other times in his ministration, shall use such vestments in the church as were in use by authority of parliament in the second year of the reign of King Edward the VI. according to the act of parliament set in the beginning of this book.

3. In the Litany the following petition found in both the

Edwardian Prayer Books was omitted "from the tyranny of the bishop of Rome and all his detestable enormities, good Lord deliver us."

4. In the Communion service the two clauses of administration found in the first and second Prayer Books of King Edward's reign were combined.

5. The rubric explanatory of "kneeling for reception," commonly known as "the Black Rubric" was omitted.

6. In the Ordinal in the rubric before the oath of the queen's sovereignty the words "against the power and authority of all foreign potentates" were substituted for "against the usurped power and authority of the Bishop of Rome," and in the oath itself four references to the bishop of Rome, by name, were omitted.

There were a few more minor alterations, without doctrinal or political significance which need not be described in detail here.

The only further addition or alteration made in Queen Elizabeth's reign was in 1561, when all the present black letter Holy Days were added to the Kalendar except St George (April 23) Lammas (Aug. 1), St Laurence (Aug. 10) and St Clement (Nov. 22), which already existed, and except St Enurchus (Sept. 7), added in 1604, and the Venerable Bede (May 27) and St Alban (June 17) added in 1662.

A smouldering and growing Puritan discontent with the Prayer Book, suppressed with a firm hand under Queen Elizabeth, burst out into a flame on the accession of King James I. in 1603. A petition called the millenary petition, because signed by no less than one thousand ministers, was soon presented to him, asking, among other things, for various alterations in the Prayer Book and specifying the alterations desired. As a result the king summoned a conference of leading Puritan divines, and of bishops and other leading Anglican divines, which met under his presidency at Hampton Court in January 1604. After both sides had been heard, certain alterations were determined upon and were ordered by royal authority, with the general assent of Convocation. These alterations were not very numerous nor of great importance, but such as they were they all went in the direction of catholicizing rather than of puritanizing the Prayer Book; the one exception being the substitution of some chapters of the canonical scriptures for some chapters of the Apocrypha, especially of the book of Tobit. Other changes were:—

1. The addition of one more black letter Saint's Day, viz.: Enurchus (by error for Evurtius) on the 7th of September. This was a small but a very extraordinary and an inexplicable change to make. The only explanation offered, which is a pure guess and seems barely possible, is that it was desired to place some mark of dignity upon a day which during the late reign had been kept with great festivity as the birthday of Queen Elizabeth.

2. The words, "The absolution to be pronounced by the minister alone" at Morning and Evening Prayer, were altered to "The Absolution, or Remission of Sins, to be pronounced by the priest alone, standing; the people still kneeling."

3. A prayer for the royal family was added after the prayer for the king, and a petition was added in the Litany to the same effect, both exhibiting slight verbal differences from the prayer and petition as used to-day.

4. Thanksgiving prayers were added for rain, for fair weather, for plenty, for peace and victory.

5. Important alterations were introduced into the service for the private baptism of children in houses, with the object of doing away with lay baptism and securing the administration by the minister of the parish, or some other lawful minister.

6. The confirmation service was entitled and explained thus: "The Order of Confirmation, or Laying on of Hands upon Children Baptized, and able to render an account of their faith according to the Catechism following."

7. The concluding portion of the Catechism, consisting of eleven questions on the sacraments, was now added.

There were other slight changes of a verbal kind, involving no doctrinal or political significance and which therefore need not be described here.

The next important stage in the history of the Prayer Book was its total suppression in 1645 for a period of fifteen years. "the Directory for the Public Worship of God in the Three Kingdoms" being established in its place. The restoration of King Charles II. in 1660 brought with it toleration at once, and soon afterwards complete restoration of the Prayer Book, but not exactly in the same form which it had before. Non-conformists pressed upon the king, either that the Prayer Book should not be re-introduced, or that if it were re-introduced, features which they objected to might be removed. The result was that a conference was held in 1661, known from its place of meeting as the Savoy Conference, the church being represented by twelve bishops and the Nonconformists by twelve eminent Presbyterian divines, each side accompanied by nine coadjutors.

The objections raised from the Nonconformist point of view were numerous and varied, but they were thoroughly discussed between the first meeting on the 15th of April and the last on the 24th of July 1661; the bishops agreeing to meet the Puritan wishes on a few minor points but on none of fundamental importance. Later in the year, between the 20th of November and the 20th of December, Convocation assembled and undertook the revision of the Prayer Book. In the earlier part of the following year the book so revised came before parliament. No amendment was made in it in either house and it finally received the royal assent on the 19th of May 1662, being annexed to an Act of Uniformity which provided for its coming into general and compulsory use on St Bartholomew's Day (Aug. 24).

The alterations thus introduced were very numerous, amounting to many hundreds, and many of them were more important than any which had been introduced into the Prayer Book since 1552. Their general tendency was distinctly in a Catholic as opposed to a Puritan direction, and the two thousand Puritan incumbents who vacated their benefices on St Bartholomew's Day rather than accept the altered Prayer Book bear eloquent testimony to that fact.

It is impossible to give here an exhaustive list of the alterations: but the following were some of the principal changes made in 1662. (a) The preface "It hath been the wisdom of the Church of England," &c., composed by Sanderson, bishop of Lincoln, was prefixed to the Prayer Book. (b) The authorized version of the Bible of 1611 was taken into use, except in the case of the Psalms, where the great Bible of 1539-1540 was retained as much smoother for singing, and in parts of the Communion service. (c) The rubric preceding the absolution in Morning and Evening Prayer, viz.: "The absolution to be pronounced by the minister alone," was altered into "The Absolution, or Remission of Sins, to be pronounced by the priest alone, standing; the people still kneeling." (d) In the Litany the phrase "Bishops, Pastors and Ministers of the Church," was altered into "Bishops, Priests and Deacons," and in the clause commencing "From all sedition and privy conspiracy," &c., the words "rebellion" and "schism" were added. (e) Among the "Prayers and Thanksgivings upon several occasions," were added the two Ember week prayers, the prayer for the high court of parliament, the collect or prayer for all conditions of men, the general thanksgiving, and that "For restoring Public Peace at Home." (f) In the Communion service two rubrics were prefixed to the prayer "for the whole state of Christ's Church militant here in earth" ordering the humble presentation and placing of the alms upon the Holy Table, and the placing thereon then of so much Bread and Wine as the priest shall think sufficient; and (g) the commemoration of the departed was added to the prayer itself. (h) The rubric explanatory of the posture of kneeling for reception, known as the Black Rubric, which had been added in 1562, but omitted in 1559 and 1604, was re-introduced: but the words "to any real and essential presence there being of Christ's natural flesh and blood" were altered to "unto any Corporal Presence of Christ's natural Flesh and Blood"—a very important and significant alteration which affected the meaning of the whole rubric. (i) Rubrics were also added ordering the manual acts by the priest in the prayer of consecration, and the covering of the remainder of the consecrated elements after Communion with a fair linen cloth. (k) A new office was added for the Ministration of Baptism to such as are of riper years. (l) A rubric was prefixed to the Order for the Burial of the Dead, forbidding that order to be used "for any that die unbaptized, or excommunicate, or have laid violent hands upon themselves." (m) In the "Ordering of Priests," and "the Consecration of Bishops," in the formula for ordination, after the words, "Receive the Holy Ghost," these words were added "for the Office and Work of a Priest (or Bishop) in the Church of God, now committed unto thee by the Imposition of our hands." (n) The ornaments rubric, regulating the vesture of the

clergy was thrown into its present shape, referring back not to 1604 or 1559 or 1552, but to the first Prayer Book of Edward VI. in 1549 for the rule to be followed.

The above are the important alterations, among numerous others of minor significance, introduced into the Prayer Book in 1662. Their general trend is obvious. It is not in the Puritan direction, but intended to emphasize and to make more clear church doctrine and discipline, which in recent years had become obscured or decayed. No substantial alteration has been made in the Prayer Book since 1662, but two alterations must be chronicled as having obtained the sanction of the Convocations of Canterbury and York, and also legal force by act of parliament. In 1871 a new Lectionary was substituted for the previously existing one, into the merits and demerits of which it is not possible to enter here; and in 1872, by the Act of Uniformity Amendment Act, a shortened form of service was provided instead of the present form of Morning and Evening Prayer for optional use in other than cathedral churches on all days except Sunday, Christmas Day, Ash Wednesday, Good Friday and Ascension Day; provision was also statutorily made for the separation of services, and for additional services, to be taken, however, except so far as anthems and hymns are concerned, entirely out of the Bible and the Book of Common Prayer.

In the year 1907 letters of business were issued by the Crown to the Convocations inviting and enabling them to make alterations in the Prayer Book (afterwards to be embodied in an act of parliament). These letters were issued in compliance with the second recommendation (1906) of the Royal Commission on Ecclesiastical Discipline, viz.: that "Letters of business should be issued to the Convocations with instructions: (a) to consider the preparation of a new rubric regulating the ornaments (that is to say, the vesture) of the ministers of the church, at the times of their ministrations, with a view to its enactment by parliament; and (b) to frame, with a view to their enactment of parliament, such modifications in the existing law relating to the conduct of Divine Service, and to the ornaments and fittings of churches as may tend to secure the greater elasticity which a reasonable recognition of the comprehensiveness of the Church of England and of its present needs seems to demand."

A few words are added in conclusion about the state services. Until the year 1859 they were four in number.

1. A Form of Prayer with Thanksgiving to be used yearly upon the Fifth Day of November, to commemorate the happy deliverance of King James I. and the Three Estates of England from the Gunpowder Plot in 1604.

2. A Form of Prayer with Fasting to be used yearly on the Thirtieth Day of January, to commemorate the Martyrdom of the Blessed King Charles the First in 1649.

3. A Form of Prayer with Thanksgiving to be used yearly on the Twenty-ninth Day of May, to commemorate the Restoration to the throne of King Charles the Second in 1660.

4. A Form of Prayer with Thanksgiving to be used yearly on the Day of the Accession of the reigning Monarch.

The first three of these services were abolished in 1859 by royal warrant—that is to say by the exercise of the same authority which had instituted them. The fourth form of service was retained in its old shape till 1901, when a new form, or rather new forms of service, having been prepared by Convocation, were authorized by royal warrant on the 9th of November. (F. E. W.)

PRAYERS FOR THE DEAD. Wherever there is a belief in the continued existence of man's personality through and after death, religion naturally concerns itself with the relations between the living and the dead. And where the idea of a future judgment obtains, prayers are often offered on their behalf to the Higher Powers. Prayers for the dead are mentioned in 2 Maccabees xii. 43-45, where the writer is uncertain whether to regard the sacrifice offered by Judas as a propitiatory sin-offering or as a memorial thank-offering, a distinction of great importance in the later history of the practice. Prayers for the dead form part of the authorized Jewish services. The form in use in England contains the following passage: "Have mercy upon him; pardon all his transgressions . . . Shelter his soul in the shadow of Thy wings. Make known to him the path of life." The only passage in the New Testament which is held to bear

directly on the subject is 2 Tim. i. 18, where, however, it is not certain that Onesiphorus, for whom St Paul prayed, was dead. Outside the Bible the proof of the early use of prayers for the dead has been carried a step farther by Professor Ramsay's discoveries, for it is now impossible to doubt the genuineness of the copy (contained in the spurious acts of the saint) of the inscription on the tomb of Abercius of Hieropolis in Phrygia (see Lightfoot, *Apostolic Fathers*, pt. ii. vol. i. p. 492 sqq.). The 19th line of the inscription runs thus: "Let every friend who observeth this pray for me," i.e. Abercius, who throughout speaks in the first person: he died in the latter part of the 2nd century. The inscriptions in the Roman catacombs bear similar witness to the practice, by the occurrence of such phrases as "Mayst thou live among the saints" (3rd century); "May God refresh the soul of . . ."; "Peace be with them." Among Church writers Tertullian is the first to mention prayers for the dead, and that not as a concession to natural sentiment, but as a duty: "The widow who does not pray for her dead husband has as good as divorced him." This passage occurs in one of his later Montanistic writings, dating from the beginning of the 3rd century. Subsequent writers similarly make incidental mention of the practice as prevalent, but not as unlawful or even disputed (until Aetius challenged it towards the end of the 4th century). The most famous instance is St Augustine's prayer for his mother, Monica, at the end of the 9th book of his *Confessions*.

An important element in the liturgies of the various Churches consisted of the diptychs or lists of names of living and dead who were to be commemorated at the Eucharist. To be inserted in these lists was an honour, and out of the practice grew the canonization of saints; on the other hand, to be excluded was a condemnation. In the middle of the 3rd century we find Cyprian enjoining that there should be no oblation or public prayer made for a deceased layman who had broken a Church rule by appointing a cleric trustee under his will: "He ought not to be named in the priests' prayer who has done his best to detain the clergy from the altar." Although it is not possible, as a rule, to name dates for the exact words used in the ancient liturgies, yet the universal occurrence of these diptychs and of definite prayers for the dead in all parts of the Church in the 4th and 5th centuries tends to show how primitive such prayers were. The language used in the prayers for the departed is very reserved, and contains no suggestion of a place or state of pain. We may cite the following from the so-called liturgy of St James:—

"Remember, O Lord, the God of Spirits and of all Flesh, those whom we have remembered and those whom we have not remembered, men of the true faith, from righteous Abel unto to-day; do thou thyself give them rest there in the land of the living, in thy kingdom, in the delight of Paradise, in the bosom of Abraham, Isaac and Jacob, our holy fathers, from whence pain and sorrow and sighing have fled away, where the light of thy countenance visiteth them and always shineth upon them."

Public prayers were only offered for those who were believed to have died as faithful members of Christ. But Perpetua, who was martyred in 202, believed herself to have been encouraged by a vision to pray for her brother, who had died in his eighth year, almost certainly unbaptized; and a later vision assured her that her prayer had been answered and he translated from punishment. St Augustine thought it needful to point out that the narrative was not canonical Scripture, and contended that the child had perhaps been baptized. Similarly, a medieval legend relates that Gregory the Great was so struck with the justice of the emperor Trajan, that he prayed for him, and in consequence he was admitted to Paradise (cf. Dante, *Purg.* x., *Parad.* xx.).

As time went on, further developments took place. Petitions to God that he would hear the intercessions of the departed became direct requests to them to pray (*Ora pro nobis*); and, finally, the saints were asked themselves to grant grace and help. Again, men felt difficulty in supposing that one who repented at the close of a wicked life could at once enjoy the fellowship of the saints in Paradise (St Luke xxiii. 43), and it seemed unfair that they should be made equal with those who had borne the

burden and heat of the day (St Matt. xx. 12). And so the simple severance between good and bad indicated in St Luke vi. 26, became the threefold division made familiar by Dante. These speculations were further fixed by the growth of the theory of satisfaction and of Indulgences: each forgiven soul was supposed to have to endure an amount of suffering in proportion to the guilt of its sins, and the prayers and pious acts of the living availed to shorten this penance time in Purgatory (see INDULGENCES). It thus came about that prayers for the dead were regarded only as aiming at the deliverance of souls from purgatorial fires; and that application of the Eucharist seems to have overshadowed all others. The Council of Trent attempted certain reforms in the matter, with more or less success; but, broadly speaking, the system still remains in the Roman Catholic Church, and masses for the dead are a very important part of its acts of worship.

The Reformation took its rise in a righteous protest against the sale of Indulgences; and by a natural reaction the Protestants, in rejecting the Roman doctrine of Purgatory, were inclined to disuse all prayers for the dead. Important changes have been made, in the successive revisions of the Prayer Book, in the commemorations of the dead at the Eucharist and in the Burial Service.

In the Communion Service of 1549, after praise and thanks were offered for all the saints, chiefly the Blessed Virgin, came the following: "We commend into thy mercy all other thy servants, which are departed hence from us with the sign of faith and now do rest in the sleep of peace: grant unto them, we beseech thee, thy mercy and everlasting peace." The Burial Service of the same date contained explicit prayers for the deceased, and introit, collect, epistle and gospel were provided for "the Celebration of the Holy Communion when there is a Burial of the Dead." In 1552, under the influence of Bucer, all mention of the dead, whether commemorative or intercessory, was cut out of the Eucharist; the prayers in the Burial Service were brought into their present form; and the provision for Holy Communion at a Burial was omitted. The thankful commemoration of the dead in the Eucharist was restored in 1661, but prayers for them remained, if they remained at all, veiled in ambiguous phrases.

The Church of England has never forbidden prayers for the dead, however little she has used them in her public services. It was proposed in 1552 to condemn the scholastic doctrine *De precatone pro defunctis* in what is now the 22nd of the Thirty-Nine Articles, but the proposal was rejected. And these intercessions have been used in private by a long list of English divines, among whom Andrewes, Cosin, Ken, Wesley and Keble form an almost complete chain down to the present day. On the tomb of Bishop Barrow (1680) stands a request to passers-by to pray for their fellow-servant. And in a suit (1838) as to the lawfulness of an inscription, "Pray for the soul of . . .," the Court decided that "no authority or canon has been pointed out by which the practice of praying for the dead has been expressly prohibited." As Jeremy Taylor put it (*Dissuasive from Popery*, I. i. iv.), "General prayers for the dead the Church of England never did condemn by any express articles, but left it in the middle."

H. M. Luckcock, *After Death* (1st ed., London, 1879); E. H. Plumptre, *The Spirits in Prison* (London, 1884). (W. O. B.)

PRAYING WHEEL, a mechanical apparatus used by the Lamaist Buddhists in Tibet and elsewhere for offering prayers. Strips of paper bearing a manifold repetition of the words "The Jewel in the Lotus, Amen," are wrapped round cylinders of all sizes—from hand-mills to wind- or water-mills. As the wheel revolves these uncoil and the prayer is considered to be offered.

PREACHING (Fr. *prêcher*, from Lat. *praedicare*, to proclaim), the proclamation of a Divine message both to those who have not heard it, and to those who, having heard it, have not accepted it, and the regular instruction of the converted in the doctrines and duties of the faith, is a distinctive though not a peculiar feature of the Christian religion. The Mahomedans exercise

it freely, and it is not unknown among the Buddhists. The history of Christian preaching with which alone this article is concerned has its roots (1) in the activity of the Hebrew prophets and scribes, the former representing the broader appeal, the latter the edification of the faithful, (2) in the ministry of Jesus Christ and His apostles, where again we have both the evangelical invitation and the teaching of truth and duty. Which-ever element is emphasized in preaching, the preacher is one who believes himself to be the ambassador of God, charged with a message which it is his duty to deliver.

1. *The Patristic Age, to the Death of St Augustine, A.D. 430.*—Of the first two centuries we have very little information. From the Acts of the Apostles we gather something as to the methods adopted by St Peter and St Paul, and these we may believe were more or less general. The Apostles who had known the Lord would naturally recall the facts of His life, and the story of His words and works would form a great deal of their preaching. After they had passed away and before the Christian Scriptures were canonically sifted and collected there was a gap which for us is only slenderly filled by such productions as the so-called *2nd Epistle of Clement*, really a rambling homily on repentance and confession (see CLEMENTINE LITERATURE), and by what we can imagine was the practice of men like Ignatius and, on the other hand, the Apologists. Most of these were primarily writers, but Justin Martyr has left a reputation for speaking, especially in debate, as well. Some of the writings of Tertullian (c. 200), e.g. those on *Patience* and *Penitence*, read as though they had been spoken, and it is hard to believe that this brilliant rhetorician did not consecrate his powers of address to his new faith. Cyprian (d. 258), too, was a finished speaker; his *Epistle to Donatus* emphasizes the need of a simple and undecorated style in the proclamation of the gospel. None of his sermons, however, unless we regard his book on the Lord's Prayer as a homily, has come down to us.

By this time the canon of New Testament Scripture was fairly settled, and with Origen (d. 254) we find the beginning of preaching as an explanation and application of definite texts. Origen was pre-eminently a teacher, and the didactic side of preaching is thus more conspicuous in his work. When we allow for his excessive use of the allegorical method, there is still left a great deal of power and suggestiveness. In his hands, as may be seen from the 19 homilies on Jeremiah that have been preserved in the Greek (and others in the Latin of Rufinus), the crude homily of his predecessors began to take a more dignified, orderly and impressive form. Alongside Origen we may rank Hippolytus of Rome on the strength of the one sermon of his which is extant, a panegyric on baptism based on the theophany which marked the baptism of Jesus.

The 4th century marks the culmination of early Christian preaching. The imperial patronage had made education and social distinctions a greater possibility for the preacher, and the decline of political eloquence furnished an opening for pulpit oratory. The didactic element was no longer in sole possession of the field, for the inrush of multitudes to the Christian faith and the huilding of large churches necessitated a return to the evangelical or proclamatory type of sermon. It was the age of doctrinal controversy, and the intellectual presentation of the Christian position was thus sharpened and developed. The Antiochene school had set a worthy example of careful exegesis of scripture. It was in the East especially that preaching flourished: Eusebius of Caesarea, Eusebius of Emesa, Athanasius, Macarius, Cyril of Jerusalem, Ephraem Syrus among the orthodox; and of the Arians, Arius himself and Ulfilas the great Gothic missionary, are all of high quality; but above even these stand out the three Cappadocians, Basil (q.v.) of Caesarea, cultured, devout and practical; his brother Gregory (q.v.) of Nyssa, more inclined to the speculative and metaphysical, and Gregory (q.v.) of Nazianzus, richly endowed with poetic and oratorical gifts, the finest preacher of the three. At the apex of the pyramid stands John of Antioch, Chrysostom (q.v.), who in 387, at the age of 40, began his 12 years' ministry in his native city and in 399, the six memorable years in Constantinople, where he loved

the poor, withstood tyranny and preached with amazing power. His sermons, says Dr E. C. Dargan, "show the native oratorical instinct highly trained by study and practice, a careful and sensible (not greatly allegorical) interpretation of Scripture, a deep concern for the spiritual welfare of his charge, and a thorough consecration to his work. His style is impetuous, rich, torrential at times; his thought is practical and imaginative rather than deeply philosophical. His knowledge of human nature is keen and ample, and his sermons are a remarkable reflection of the manners and customs of his age. His ethical appeal is constant and stimulating."

In the West the allegorical method of Alexander had more influence than the historical exegesis of Antioch. This is seen in Ambrose of Milan, with whom may be named Hilary of Poitiers and Gaudentius of Brescia, the friend of Chrysostom, and a link between him and Ambrose. But the only name of first rank in preaching is that of Augustine, and even he is curiously unequal. His fondness for the allegorical and his manifest carelessness of preparation disappoint as often as his profundity, his devout mysticisms, his practical application attract and satisfy. Augustine's *De doctrina Christiana*, bk. iv., is the first attempt to formulate the principles of homiletics.

2. *The Early Middle Ages, 430-1100.*—After the days of Chrysostom and Augustine there was a great decline of preaching. With the poor exceptions of one or two names like those of Theodore of Mopsuestia and John of Damascus, the Eastern Church produced no preachers of distinction. The causes of the ebb were both internal and external. Within the Church there was a departure from the great experimental truths of the Gospel, their place being taken by the preaching of nature and morality on a theistic basis. To this we may add a fantastic and absurd allegorization, the indiscriminate laudation of saints and martyrs, polemical strife, the hardening of the doctrine into dogma, the development of a narrow ecclesiasticism, and the failure of the missionary spirit in the orthodox section of the Eastern Church (as contrasted with the marvellous evangelistic activity of the Nestorians (*q.v.*)). Outside the Church the break-up of old civilizations, the confused beginnings of medieval kingdoms, with the attendant war and rapine, the inroads of the Saracens and the rise of Islam, were all effective silencers of the pulpit. Yet the night was not without its stars; at Rome Leo the Great and Gregory the Great could preach, and the missionaries Patrick, Columba, Columbanus, Augustine, Wilfrid, Willibrord, Gall and Boniface are known by their fruits. The homilies of Bede are marked by a tender devoutness, and here and there rise to glowing eloquence. In the 8th century Charlemagne, through the *Capitularies*, tried in vain to galvanize preaching; such specimens as we have show the sermons of the times to be marked by superstition, ignorance, formality and plagiarism. It was the age when the papacy was growing out of the ruins of the old Roman Empire, and the best talents were devoted to the organization of ecclesiasticism rather than to the preaching of the Word. Liturgies were taking shape, penance was deemed of more importance than repentance, and there was more insistence on discipline than on Christian morality. Towards the end of the period we note the beginnings of the triple division of medieval preaching into cloistral, parochial and missionary or popular preaching, a division based at first on audiences rather than on subject-matter, the general character of which—legends and popular stories rather than exposition of Scripture—was much the same everywhere. About this time, no doubt, some preachers began to use the vernacular, though no examples of such a practice have been preserved. There are few great names in the 9th, 10th and 11th centuries: Anselm was a great Churchman, but no great preacher; perhaps the most worthy of mention is Anskar, the missionary to the Scandinavians. Rabanus Maurus published an adaptation of Augustine's *De doctrina Christiana*, bk. iv. But certain forces were at work which were destined to bring about a great revival, viz. the rise of the scholastic theology, the reforms of Pope Hildebrand, and the preaching of the First Crusade by Pope Urban II. (d. 1099) and Peter the Hermit.

3. *The Later Medieval Age, 1100-1500.*—In the 12th century the significant feature is the growing use of the various national languages in competition with the hitherto universal Latin. The most eminent preacher of the century was Bernard of Clairvaux (1091-1153), esteemed alike by gentle and simple, and summing up the popular scholastic and mystical types of preaching. His homilies, though tediously minute, still breathe a charm and power (see BERNARD, St).

Alongside Bernard may be placed the two mystics of St Victor, Hugo and Richard, and a little later Peter Waldo of Lyons, who, like Henry of Lausanne, preached a plain message to the poor and lowly. The 13th century saw the culmination of medieval preaching, especially in the rise of the two great mendicant orders of Francis and Dominic. Representative Franciscan names are Antony of Padua (d. 1231), who travelled and preached through southern Europe; Berthold of Regensburg (d. 1272), who, with his wit and pathos, imagination and insight, drew huge crowds all over Germany, as in homeliest vernacular he denounced sin with all the severity of a John the Baptist; and Francis Bonaventura, the schoolman and mystic, who wrote a little book on *The Art of Preaching*. Of the Dominicans Thomas Aquinas (d. 1274), the theologian, was perhaps also the greatest preacher. With the 14th century a new note, that of reformation, is struck; but on the whole there was a drop from the high level of the 13th. In Italy Bernardino of Siena on the scholastic side, Robert of Lecce and Gabriel Barletta on the popular, are the chief names; in Germany these phases are represented by John Gritsch and John Geiler of Kaiserburg respectively. Among the popular preachers vigour was often blended with coarseness and vulgarity. Mysticism is represented by Suso, Meister Eckhart, above all Johann Tauler (*q.v.*) of Strassburg (d. 1461), a true prophet in an age of degeneration. Towards the close of the century comes John Wycliffe (*q.v.*) and his English travelling preachers, who passed the torch to Hus and the Bohemians, and in the next age Savonarola, who was to Florence what Jeremiah had been to Jerusalem.

4. *The Reformation Period, 1500-1700.*—It is here that the story of modern preaching may be said to begin. The Reformers gave the sermon a higher place in the ordinary service than it had previously held, and they laid special stress upon the interpretation and application of Scripture. The controversy with Rome, and the appeal to the reason and conscience of the individual, together with the spread of the New Learning, gave preaching a new force and influence which reacted upon the old faith, as John Wild (d. 1554), one of the best Roman Catholic preachers of the day, a man noted for his "emphasis on Scripture, his grasp of evangelical truth, his earnest piety, amiable character and sustained power in the pulpit," fully admitted. Other famous preachers on the same side were the Spaniards Luiz of Granada and Thomas of Villanova, the Italians Cornelio Musso, Egidio of Viterbo and Carlo Borromeo, and the German Peter Canisius. Among the Reformers were, of course, Martin Luther and most of his German collaborators; the Swiss Zwingli, Bullinger, Farel and Calvin; the English Latimer, John Bradford, John Jewel; the Scot John Knox. Nor can even so cursory a sketch omit to mention Bernardino Ochino and the Anabaptist Hübmaier. In all these cases fuller details will be found in the articles bearing their names. Most of the Reformation preachers read their sermons, in contrast to the practice of earlier ages. The English Book of Homilies was compiled because competent preachers were comparatively rare.

The 17th-century preaching was, generally speaking, a continuation of that of the 16th century, the pattern having been set by the Council of Trent and by the principles and practice of the Reformers. In Spain and Germany, however, there was a decline of power, in marked contrast to the vigour manifested in France and England. In France, indeed, the Catholic pulpit now came to its perfection, stimulated, no doubt, by the toleration accorded to the Huguenots up to 1685 and by the patronage of Louis XIV. The names of Bossuet, Fléchier, Bourdaloue, Fénelon and Massillon, all supreme preachers, despite a certain artificial pompousness, belong here, and on the reformed side

are Jean Claude (d. 1687), author of the *Essay on the Sermon*, and Jacques Saurin (d. 1730). In England the rivalry was not between Catholic and Reformer, but between Anglican and Nonconformist, or, if we may use the wide but less correct term, Puritan. On the one hand are Andrewes, Hall, Chillingworth, Jeremy Taylor, Barrow and South; on the other Baxter, Calamy, the Goodwins, Howe, Owen, Bunyan, in each case but a few names out of many. The sermons of these men were largely scriptural, the cardinal evangelical truths being emphasized with reality and vigour, but with a tendency to abstract theology rather than concrete religion. The danger was felt by the university of Cambridge, which in 1674 passed a statute forbidding its preachers to read their sermons.

Germany, harassed by the Thirty Years' War and deadened by a rigid Lutheranism, can show little besides Andrea and Johann Arndt until the coming of the Pietists (see PIETISM), A. H. Francke and Philipp Spencer, with Paul Gerhardt and his cousin Johann. The early years of the 18th century were a time of deadness as regards preaching. The Illumination in Germany and Deism in England were largely responsible for this, though the names of J. A. Bengel (better known as a commentator), Zinzendorf, Butler and the Erskines helped to redeem the time from the reproach of being the dark age of Protestantism. In the Roman Catholic Church the greatest force was Bridaine in France, a popular preacher of high worth. But, generally speaking, there was no heart in preaching, sermons were unimpassioned, stilted and formal presentations of ethics and apologetics, seldom delivered extempore.

5. *The Modern Period* may be said to begin in 1738, the year in which John Wesley began his memorable work. Preaching once more was based on the Bible, which was expounded with force and earnestness, and though throughout the century there remained a good many pulpiteers who produced nothing but solemn fudge, the example and stimulus given by Wesley and Whitefield were almost immeasurably productive. Whitefield was the greater orator, Wesley the better thinker; but, diverse in temperament as they were, they alike laid emphasis on open-air preaching. In their train came the great field preachers of Wales, like John Elias and Christmas Evans, and later the Primitive Methodists, who by their camp meetings and itinerancies kept religious enthusiasm alive when Wesleyan Methodism was in peril of hardening. Meanwhile, in America the Puritan tradition, adapted to the new conditions, is represented by Cotton Mather, and later by Jonathan Edwards, the greatest preacher of his time and country. Whitefield's visits raised a band of pioneer preachers, cultured and uncultured, men who knew their Bibles but often interpreted them awry.

In the early 19th century the pulpit had a great power, especially in Wales, where it was the vehicle of almost every kind of knowledge. And it may be doubted whether, all in all, preaching has ever reached so uniformly high a level or been so powerful a force as during the 19th century, and this in spite of other forces similarly making for enlightenment and morality. It shared to the full in all the quickening that transformed so many departments of civilization during that epoch, and has been specially influenced by the missionary enterprise, the discoveries of science, the fuller knowledge of the Bible, the awakened zeal for social service. Modern preaching, like ancient preaching, has been so varied, depending, as it so largely does, on the personality of the preacher, that it is not possible to speak of its characteristics. Nor can one do more than enumerate a few outstanding modern names, exclusive of living preachers. In the Roman Catholic Church are the Italians Ventura and Curci, the Germans Diepenbrock and Foerster, the French Lacordaire, Dupanloup, Loyson (Père Hyacinthe) and Henri Didon. Of Protestants, Germany produced Schleiermacher, Claus Harms, Tholuck and F. W. Krummacher; France, Vinet and the Monods. In England representative Anglican preachers were Newman (whose best preaching preceded his obedience to Rome), T. Arnold, F. W. Robertson, Liddon, Farrar, Magee; of Free Churchmen, T. Binney, Thomas Jones, R. W. Dale and Joseph Parker (Congregationalist); Robert Hall, C. H. Spurgeon and Alexander

Maclaren (Baptists); W. M. Punshon, Hugh Price Hughes and Peter Mackenzie (Wesleyan); James Martineau (Unitarian). The Scottish Churches gave Edward Irving, Thos. Chalmers, R. S. Candlish, R. M. McCheyne and John Caird. In America, honoured names are those of W. E. Channing, Henry Ward Beecher, Horace Bushnell, Phillips Brooks, to mention only a few.

See J. M. Neale, *Medieval Preachers and Preaching* (1857); R. Rothe, *Geschichte der Predigt vom Anfang bis auf Schleiermacher* (1881); J. P. Mahaffy, *Decay of Modern Preaching* (1882); E. C. Durgan, *A History of Preaching* (1906), and preface to *The Pulpit Encyclopaedia*, vol. i. (1909); and the various volumes of the Yale Lectures on Preaching. Also SERMON. (A. J. G.)

PREAMBLE (Med. Lat. *praecambulum*, from *praecambulare*, to walk before), an introductory statement, a preliminary explanation. The term is particularly applied to the opening paragraph of a statute which summarizes the intention of the legislature in passing the measure; thus the preamble of the statute, of which the title is the Children Act 1908, is as follows: "An Act to consolidate and amend the Law relating to the Protection of Children and Young Persons, Reformatory and Industrial Schools and Juvenile Offenders, and otherwise to amend the Law with respect to Children and Young Persons." The procedure in the British parliament differs in regard to the preambles of public and private bills. The second reading of a public bill affirms the principle, and therefore in committee the preamble stands postponed till after the consideration of the clauses, when it is considered in reference to those clauses as amended and altered if need be (Standing Order 35). On the other hand, the preamble of a private bill, if opposed, is considered first in committee, and counsel for the bill deals with the expediency of the bill, calls witnesses for the allegation in the preamble, and petitions against the bill are then heard; if the preamble is negatived the bill is dropped, if affirmed it is gone through clause by clause. On unopposed private bills the preamble has also to be proved, more especially with regard to whether the clauses required by the standing orders are inserted (see May, *Parliamentary Practice*, 1906, pp. 483, 808 seq.).

PREANGER, a residency of the island of Java, Dutch East Indies, bounded S. by the Indian Ocean, W. by Bantam, N. by Batavia and Krawang, and N.E. and E. by Cheribon and Banyumas. It is officially termed the Preanger Regencies, of which there are five, covering the several administrative divisions. It also includes the small island of Nusa Wera. The natives are Sudaese. The whole residency is mountainous, but there are two main parallel ranges of peaks along the northern boundary and through the middle. Among these are to be found a singularly large number of both active and inactive volcanoes, including the well-known Salak and Gede in the north, and bunched together at the eastern end the Chikorai, Papandayan, Wayang, Malabar, Guntur, &c., ranging from 6000 to 10,000 ft. in height. The rivers of the province belong to the basins of the Indian Ocean and the Java Sea respectively, the water-parting being formed by the western and eastern ends respectively of the northern and southern lines of mountain peaks. The two which drain the largest basin are the Chi Manuk and the Chi Tarum, both rising in the eastern end of the province and flowing north-east and north-west respectively to the Java Sea. The Chi Tandui, also rising here, flows south-east to the Indian Ocean, and alone of all the rivers in this province is navigable. Large stretches of marsh occur on each side of this river, as well as here and there among the hills where inland lakes formerly existed, as, for instance, near Bandung. Crater lakes are Telaga (lake) Budas, in the crater of the volcano of the same name in the south-east, and Telaga Warna, on the slopes of the Gede, famous for its beautiful tinting. On the same side of the Gede is the health resort of Sindanglaya (founded 1850-1860), with a mineral spring containing salt, and close by is the country residence of Chipanas, belonging to the governor-general.

Numerous warm springs are scattered about this volcanic region. Petroleum and coal have been worked, and there is a rich yield of chalk, while a good quality of bricks is made from the

red clay. The soil is in general very fertile, the principal products being rice, maize and pulse (*kachang*) in the lower grounds, and cinchona, coffee and tea, as well as cocoa, tobacco and fibrous plants in the hills. The coffee cultivation has, however, considerably diminished. Forest culture, mat-making, weaving and fish-breeding are also practised, the last-named in the marshes after the rice harvest. The plantations are almost entirely owned by the government and Europeans, but the rice mills are in the hands of Chinese. Irrigation works have been carried out in various parts. The principal towns are Bandung, the capital of the residency, Sukabumi, Chianjar, Sumedang, Chichalengka, Garut, Tasik Malaya and Manon Jaya, all with the exception of Sumedang connected by railway.

PREBENDARY (Lat. *praebendo*=give or grant, through Low Lat. *praebenda*), one who holds a prebend, namely an endowment in land, or pension in money, given to a cathedral or conventual church in *praebendam*—that is, for the maintenance of a secular priest or regular canon. In the early Church the title had a more general signification. The word *praebenda* originally signified the daily rations given to soldiers, whence it passed to indicate daily distributions of food and drink to monks, canons, &c. It became a frequent custom to grant such a prebend from the resources of a monastery to certain poor people or to the founder. Such persons were, literally, *praebendaries*. At a later date, when the custom in collegiate churches of living in common had become less general, a certain amount of the church revenue was divided among the clergy serving such a church, and each portion (no longer of meat or drink only) was called a *prebend*. The clergy of such churches were generally canons, and the titles *canon* and *prebendary* were, and are, sometimes used as synonymous. A member of such a college is a canon in virtue of the spiritual duties which he has to perform, and the assignation to him of a stall in choir and a place in chapter; he is a prebendary in virtue of his benefice. In the Roman Catholic Church the duties of a prebendary as such generally consist in his attendance at choral office in his church. In the Anglican Church he usually bears his part in the conducting of the ordinary church services, except when he has a vicar, as in the old cathedral foundations (see CATHEDRAL). A prebendary may be either simple or a dignitary. In the former case he has no cure and no more than his revenue for his support; in the latter he has always a jurisdiction annexed. In the Anglican Church the bishop is of common right patron of all prebends, and if a prebend is in the gift of a lay patron he must present his candidate to the bishop who institutes as to other benefices. No person may hold more than one prebend in the same church; therefore, if a prebendary accepts a deanery in his church his prebend becomes void by cession. A prebend is practically a sinecure, and the holder has no cure of souls as such. He may, and often does, accept a parochial office or chaplaincy in addition.

In the middle ages there were many less regular kinds of prebends: e.g. *praebenda doctoralis*, with which teaching duties were connected, *praebenda lectoralis*, *praebenda missae*, to which the duty of saying a certain number of masses was attached, *praebenda mortuaria*, founded for the saying of masses for the dead. Chantry offices belonged to this class. All these prebends were generally assigned to special holders, but there were also *praebendae currentes*, which were not held by any persons in particular. Sometimes prebends were held by boys who sang in choir, *praebendae pueriles*. Occasionally the name of prebendary was applied to those servants in a monastery who attended to the food. In England the word *prebendary* was sometimes used as synonymous with *prebend*, as *prebend* was occasionally used for *prebendary*.

Du Cange, *Glossarium mediae et infimae latinitatis*, ed. L. Favre (Niort, 1883, &c.); Migne, *Encyclopédie théologique*, 1st series, vol. x. (s. Droit Canon); Sir R. J. Phillimore, *Ecclesiastical Law of the Church of England* (2nd ed., 1895). (E. O'N.)

PRE-CAMBRIAN, in geology, the enormously long and indistinctly defined period of time anterior to the Cambrian period. In the restricted sense in which it is now often employed it embraces a period or group of periods subsequent to the Archean (*q.v.*) and anterior to the Cambrian, although some writers still prefer to include the former. The superior limit of pre-Cambrian rocks is fixed by the *Olenellus* fauna at the base

of the Cambrian (some geologists speak of certain pre-*Olenellus* beds as *co-Cambrian*); the lower limit has not yet been generally established, though it is sufficiently clear in certain regions. The rocks of this period are much more obviously of sedimentary origin than those of the Archean; they include conglomerates, sandstones, greywackes, quartzites, slates, limestones and dolomites, which appear to have been formed under conditions similar to those which obtained in later epochs. Although the sediments prevail, they are often very highly metamorphosed and distorted by crustal movements; igneous rocks occur in great bulk in some regions. Fossils are usually extremely rare and very ill-preserved; but indications of protozoa, coelenterates, echinoderms, molluscoids, mollusca, worms and arthropods have been distinguished. The name pre-Cambrian is the equivalent of the "Algonkian" of the United States Geological Survey, and of the "Proterozoic" of other American authorities; the terms eozoic, archaeozoic, agnotozoic, cryptozoic, eparchaic and others have also been applied to the same period.

Three or more great stratigraphical breaks have been recognized within the system of pre-Cambrian rocks; but how far these breaks synchronize in widely separated regions where they are found is difficult to determine in the absence of good palaeontological evidence.

The most striking development of pre-Cambrian rocks in Great Britain is the Torridonian (*q.v.*) group of the north-west highlands of Scotland, which lies with strong unconformability between the Lewisian gneiss and the basal quartzite of the Cambrian. The Eastern or Dalradian (*q.v.*) schists of Scotland and their equivalents in Ireland and Anglesey may be, in part at least, of the same age. In Shropshire, in the neighbourhood of the Welsh border, is the remnant of an ancient ridge now forming the Longmynd and the smaller hills to the west, Caer Caradoc, the Wrekin, and the Cardington Hills. The latter are built mainly of much altered porphyries and tuffs which C. Callaway named the Uriconian series; this series is clearly of pre-Cambrian age. The great mass of grits, flags and slates forming the Longmynd cannot yet be definitely assigned to this period, though they may be provisionally retained here under Callaway's name, Londmyndian. Probably contemporaneous with the Uriconian are the volcanic series of Barnt Green, Licky Hill and Caldecote. The micaceous schists of Rushton (Salop) may be placed here. In the Charnwood Forest a group of crystalline rocks, named Charnian by W. W. Watts, rises up in the form of small hills amid the surrounding Trias; they are classed as follows in descending order: The Brand series, including the slates of Swithland and Groby, quartzite and conglomerate and purple and green beds; the Maplewell series, including the olive hornstones of Bradgate, the Woodhouse beds, the slate-agglomerate of Roccliffe, the Beacon Hill hornstones and a felspathic agglomerate; and the Blackbrook series of grits and hornstones. The ancient volcanic rocks of St Davids, Pembrokehire, were formerly regarded by H. Hicks as of pre-Cambrian age, in which he recognized a lower, "Dimetian," a middle, "Arvonian," and an upper, "Pebidian," series. The pre-Cambrian age of these rocks was for a long time disputed, but J. F. N. Green (*Q. J. Geol. Soc.*, 1908, 64, p. 363) made it clear that there is an Upper Pebidian (Rhyolitic group), and a Lower Pebidian (Trachytic group), and that Hicks's "Dimetian," the St Davids granophyre, is a laccolitic mass intrusive in the Pebidian. Both the Pebidian volcanic rocks and the intruded granophyre are separated from the Cambrian by an unconformity.

In Finno-Scandinavia pre-Cambrian rocks are well developed. In the Scandinavian mountain ranges are the Seve and Sparagmite formations; the latter, a coarse-grained felspathic sandstone, is very similar to the Torridonian of Scotland; it occurs also in Enontekis in Finland. Next in descending order come the Jotnian sandstones (2000 metres), which retain ripple-marks; they are associated with conglomerates and slates and intrusive diabase and the Rapakivi granite. The Jotnian group rests unconformably upon the Jatulian quartzites and schists, with slates, dolomite and carbonaceous beds (north of Lake Onega is a bed of anthracite 2 metres thick). Outflows of diabase and gabbro occur in this series, which is from 1600 to 2000 metres in thickness. Below the Jatulian is another group of schistose sediments, the Kalevian, more strongly folded than the former and separated from the groups above and below by unconformable junctions. These rocks are regarded by J. J. Sederholm as older than the Huronian of North America (possibly analogous to the Keewatin formation), and yet several groups of sediments in this region (Botnian schists, &c.) lie between the Kalevian series and the granitic (Archean) complex.

Pre-Cambrian rocks occupy large areas and attain an enormous thickness in North America; all types of sediment are represented in various stages of metamorphism, and with these are igneous rocks, often developed upon a vast scale. They have been subdivided into the following groups or formations: an upper Keweenawan

and a lower Huronian group; the latter is subdivided into an upper Animikean (north-east Minnesota) or Penokean (north-west Wisconsin); a middle and a lower division. Each of these four groups is separated by marked unconformity from the rocks above and below. Huronian rocks are well developed in the following districts: the Marquette region of northern Michigan, comprising quartzites, slates and conglomerates, with important iron-bearing slates and schists and ferruginous cherts; in the Menominee district of Michigan and Wisconsin similar rocks occur; the Penokee-Gogebic district of Wisconsin and Michigan comprises quartzites, shales and limestones, with beds and dikes of diabase and olivine-gabbro; the same rocks occur in the Crystal Falls, north Michigan; the Mesabi and Vermilion districts, Minnesota, and north of Lake Michigan rock groups of this age take an important place. The valuable iron ores of Mesabi, Penokee-Gogebic and Menominee belong mainly to the Animikean group; in the Penokee rocks of this age vast thicknesses of igneous rocks constitute the greater part of the formation. The Keweenaw rocks are said to attain the enormous thickness of 50,000 ft.; the higher beds are mainly sandy sediments and conglomerates; in the lower portions are great igneous masses, gabbros, diabase and porphyries; thus in the St Croix valley, north-west Wisconsin and Minnesota, no fewer than 65 lava flows and 5 conglomeratic beds have been counted, which together aggregate some 20,000 ft. in thickness. Some of these lava flows appear to have been due to fissure eruptions. The native copper deposits of this age in north Michigan are the most extensive known.

Pre-Cambrian rocks occupy large areas and reach great thicknesses in the eastern provinces of Canada; in Newfoundland 10,000 ft. of strata lie between the Archean and Cambrian (the Terranovian series of South Hunt; Avalon group of others); similar rocks occur also north of the Great Lakes and in the Hudson Bay region. They are found also in great force in the Colorado Canyon, in the Adirondack Mountains, and Black Hills of S. Dakota and elsewhere.

Turning to Europe, we find pre-Cambrian rocks in Brittany, the "phyllades de Saint Lô," or Briovérian of Chas. Barrois; and along the western border of France and south-west of the central *massif*. In the Fichtelgebirge, the Silesian mountains and east Thuringia similar rocks occur; the Przibramer Schiefer of Lipold and rocks in J. Barrande's stage A are of this age. Probably the metamorphosed eruptive rocks on the southern border of the Hunsrück and Taunus are pre-Cambrian. Large tracts of metamorphic sedimentary rocks that may be classed here are found in Shantung and north China, and probably also in Brazil, India and Australia. In South Africa the gold-bearing Witwatersrand beds of the Transvaal and the overlying Ventersdorp and Potchefstroom systems; the Griqualand system and Congo and Ibeques systems of Cape Colony, all occur above Archean rocks and below those of Devonian age; they cannot as yet, therefore, be classed as pre-Cambrian and their age is still uncertain.

Little can be said of the climatic conditions of this remote period, the fossil evidence being so poor; but it is of interest to note that in certain regions, viz. in the Lake Huron region, in the Gaisa series of Varanger Fjord, Norway, and in the Yangtse district in China, conglomerate beds are found in which many of the boulders are scratched like those of the Dwyka beds of South Africa, and thus suggest the possibility of glacial conditions at some stages of the period.

For literature see *Geological Literature added to the Geological Society's Library* (annual). (J. A. H.)

PRECARIOUS, literally, held on the good-will of another, or on entreaty (Lat. *precax, precis*, prayer) to another. The word is used, in law, of a tenure of land, office, &c., held at the pleasure of another. In general usage it has the significance of something uncertain, dangerous or risky.

PRECEDENCE (from Lat. *præcedere*, to go before, precede). This word in the sense in which it is here employed means priority of place, or superiority of rank, in the conventional system of arrangement under which the more eminent and dignified orders of the community are classified on occasions of public ceremony and in the intercourse of private life. In the United Kingdom there is no complete and comprehensive code whereby the scheme of social gradation has been defined and settled, once and for all, on a sure and lasting foundation. The principles and rules at present controlling it have been formulated at different periods and have been derived from various sources. The Crown is the fountain of honour, and it is its undoubted prerogative to confer on any of its subjects, in any part of its dominions, such titles and distinctions and such rank and place as to it may seem meet and convenient. Its discretion in this respect is altogether unbounded at common law, and is limited in those cases only wherein it has been submitted to restraint

by act of parliament. In the old time all questions of precedence came in the ordinary course of things within the jurisdiction of the court of chivalry, in which the lord high constable and earl marshal presided as judges, and of which the kings of arms, heralds and pursuivants were the assessors and executive officers. When, however, points of unusual moment and magnitude happened to be brought into controversy, they were occasionally considered and decided by the sovereign in person, or by a special commission, or by the privy council, or even by the parliament itself. But it was not until towards the middle of the 16th century that precedence was made the subject of any legislation in the proper meaning of the term.¹

In 1539 an act "for the placing of the Lords in Parliament" (31 Hen. VIII. c. 10) was passed at the instance of the king, and by it the relative rank of the members of the royal family, of the great officers of state and the household, and of the hierarchy and the peerage was definitely and definitively ascertained. In 1563 an act "for declaring the authority of the Lord Keeper of the Great Seal and the Lord Chancellor to be the same" (5 Eliz. c. 18) also declared their precedence to be the same. Questions concerning the precedence of peers are mentioned in the Lords Journals 4 & 5 Ph. and M. and 39 Eliz., but in the reign of James I. such questions were often referred to the commissioners for executing the office of earl marshal. In the reign of Charles I. the House of Lords considered several questions of precedence and objected in the earl of Banbury's case to warrants overruling the statute of 31 Hen. VIII. In 1689 an act "for enabling Lords Commissioners of the Great Seal to execute the office of Lord Chancellor or Lord Keeper" (1 Will. and Mary c. 21) gave to the commissioners not being peers of the realm place next to the speaker of the House of Commons and to the speaker place next to the peers of the realm. In 1707 the Act of Union with Scotland (6 Anne c. 11) provided that all peers of Scotland should be peers of Great Britain² and should have rank immediately after the peers of the like degrees in England at the time of the union and before all peers of Great Britain of the like degrees created after the union. In 1800 the Act of Union with Ireland (39 & 40 Geo. III. c. 67) provided that the lords spiritual of Ireland should have rank immediately after the lords spiritual of the same degree in Great Britain, and that the lords temporal of Ireland should have rank immediately after the lords temporal of the same degree in Great Britain at the time of the union, and further that "peerages of Ireland created after the union should have precedence with peerages of the United Kingdom created after the union according to the dates of their creation." At different times too during the current century several statutes have been passed for the reform and extension of the judicial organization which have very materially affected the precedence of the judges, more especially the Judicature Act of 1873 (36 & 37 Vict. c. 66), under which the lords justices of appeal and the justices of the High Court now receive their appointments. But the statute of Henry VIII. "for the placing of the Lords" still remains the only legislative measure in which it has been attempted to deal directly and systematically with any large and important section of the scale of general precedence; and the law, so far as it relates to the ranking of the sovereign's immediate kindred whether lineal or collateral, the principal ministers of the Crown and court, and both the spiritual and temporal members of the House of Lords, is to all practical intents and purposes what it was made by that statute nearly 350 years ago. Where no act of parliament applies precedence is determined either by the will and pleasure of the sovereign or by what is accepted as "ancient usage and established

¹ Ample materials for the satisfaction of the curiosity of those who are desirous of investigating the history of precedence under its wider and more remote aspects will be found in such writers as Selden or Mackenzie, together with the authorities quoted or referred to by them: Selden, *Titles of Honor*, pt. ii. p. 740 seq. (London, 1672); Mackenzie, *Observations upon The Laws and Customs of Nations as to Precedency* (Edinburgh, 1680; and also reprinted in Guillim, *Display of Heraldry*, 6th ed., London, 1724).

² For the parliamentary rights of Scottish peers see article PEERAGE.

custom." Of the sovereign's will and pleasure the appropriate method of announcement is by warrant under the sign-manual, or letters patent under the great seal. But, although the Crown has at all periods very frequently conceded special privileges of rank and place to particular persons, its interference with the scale of general precedence has been rare and exceptional. In 1540 it was provided by warrant from Henry VIII. that certain officers of the household therein named should precede the secretaries of state when and if they were under the degree of barons.¹ In 1612 James I. directed by letters patent, not without long and elaborate argument in the Star Chamber, that baronets, then newly created, should be ranked after the younger sons of viscounts and barons, and that a number of political and judicial functionaries should be ranked between knights of the Garter and such knights bannerets as should be made by the sovereign in person "under his standard displayed in an army royal in open war."² Four years later he further directed, also by letters patent, that the sons of baronets and their wives and the daughters of baronets should be placed before the sons of knights and their wives and the daughters of knights "of what degree or order soever."³ And again in 1620 the same king commanded by warrant "after solemn argument before his majesty" that the younger sons of earls should precede knights of the privy council and knights of the Garter not being "barons or of a higher degree."⁴ If we add to these ordinances the provisions relating to precedence contained in the statutes of several of the orders of knighthood which since then have been instituted or reconstructed, we shall nearly, if not quite, exhaust the catalogue of the interpositions of the sovereign with regard to the rank and place of classes as distinguished from individuals. Of "ancient usage and established custom" the records of the College of Arms furnish the fullest and most trustworthy evidence. Among them in particular there is a collection of early tables of precedence which were published by authority at intervals from the end of the 14th to the end of the 15th century, and to which peculiar weight has been attached by many successive generations of heralds. On them, indeed, as illustrative of and supplementary to the action of parliament and the Crown, all subsequent tables of precedence have been in great measure founded. The oldest is the "Order of All Estates of Nobles and Gentry," prepared apparently for the coronation of Henry IV. in 1399, under the supervision of Ralph Nevill, earl of Westmorland and earl marshal; and the next is the "Order of All States of Worship and Gentry," prepared, as announced in the heading, for the coronation of Henry VI. in 1429, under the supervision of the lord protector Humphrey, duke of Gloucester, and the earl marshal, John Mowbray, duke of Norfolk. Two more are of the reign of Edward IV., and were severally issued by John Tiptoft, earl of Worcester and lord high constable, in 1467, and by Anthony Widvile, Earl Rivers and lord high constable, in 1479. The latest is commonly and shortly known as the "Series Ordinum," and was drawn up by a special commission presided over by Jasper Tudor, duke of Bedford, it is presumed for observance at the marriage of Henry VII. and Elizabeth of York in 1486. To these may be added the "Order for the Placing of Lords and Ladies," taken at a grand entertainment given by command of Henry VIII. at the king's manor-house of Richmond in 1520 by Charles Somerset, earl of Worcester, lord chamberlain of the household, to the French ambassador, Olivier de la Vernade, seigneur de la Bâtie; the "Precedency of All Estates," arranged in 1594 by the commissioners for

executing the office of earl marshal; and the "Roll of the King's Majesty's most Royal Proceeding through London" from the Tower to Whitehall on the eve of the coronation of James I., also arranged by the commissioners for executing the office of earl marshal. On many isolated points, too, of more or less importance, special declaratory decisions have been from time to time propounded by the earls marshal, their substitutes and deputies; for example, in 1594, when the younger sons of dukes were placed before viscounts; in 1625, when the rank of knights of the Bath and their wives was fixed; and in 1615 and 1677, when the eldest sons of the younger sons of peers were placed before the eldest sons of knights and of baronets. It is from these miscellaneous sources that the precedence among others of all peeresses, the eldest sons and their wives and the daughters of all peers, and the younger sons and their wives of all dukes, marquesses and earls is ascertained and established. And further, for the purpose of proving continuity of practice and disposing of minor questions not otherwise and more conclusively set at rest, the official programmes and accounts preserved by the heralds of different public solemnities and processions, such as coronations, royal marriages, state funerals, national thanksgivings and so on, have always been considered to be of great historical and technical value.⁵

1.—General Precedence of Men.

The sovereign; (1) prince of Wales; (2) younger sons of the sovereign; (3) grandsons of the sovereign; (4) brothers of the sovereign; (5) uncles of the sovereign; (6) nephews of the sovereign;⁶ (7) ambassadors; (8) archbishop of Canterbury, primate of all England; (9) lord high chancellor of Great Britain or lord keeper of the great seal; (10) archbishop of York, primate of England;⁷ (11) prime minister; (12) lord high treasurer of Great

⁵ Selden, *Titles of Honor*, pt. ii. p. 753.

⁶ The precedence of the members of the royal family depends on their relationship to the reigning sovereign and not on their relationship to any of the predecessors of the reigning sovereign. It is provided by 31 Hen. VIII. c. 10 that no person, "except only the King's children," shall have place "at the side of the Cloth of Estate in the Parliament Chamber," and that "the King's Son, the King's Brother, the King's Nephew, or the King's Brother's or Sister's Sons," shall have place before all prelates, great officers of state and peers. Lord Chief Justice Coke was of opinion that the king's nephew meant the king's grandson or *nepos* (*Institutes*, vol. iv. ch. 77). But, as Mr Justice Blackstone says, "under the description of the King's children his grandsons are held to be included without having recourse to Sir Edward Coke's interpretation of nephew" (*Commentaries*, vol. i. ch. 4). Besides, if grandson is to be understood by nephew, the king's grandson would be placed after the king's brother. The prince of Wales is not specifically mentioned in the statute "for the placing of the Lords"; but, as he is always, whether the son or the grandson of the sovereign, the heir-apparent to the Crown, he is ranked next to the sovereign or the queen-consort. With the exception of the prince of Wales, all the male relations of the sovereign are ranked first in the order of their degrees of consanguinity with him or her, and secondly, in the order of their proximity to the succession to the Crown; thus the members of the several groups into which the royal family is divided take precedence according to their own seniority and the seniority of their fathers or mothers, the sons of the sons or brothers of the sovereign being preferred to the sons of the daughters or sisters of the sovereign among the sovereign's grandsons and nephews.

⁷ By 31 Hen. VIII. c. 10, the king's vicegerent "for good and due ministration of justice in all causes and cases touching the ecclesiastical jurisdiction" is placed immediately before the archbishop of Canterbury. The office of vicegerent or vicar-general was then held by Thomas, Lord Cromwell, afterwards earl of Essex, together with that of lord privy seal, and it was never conferred on any other person. By the Act of Union with Ireland the archbishops of Ireland had place next to the archbishops of England, and if consecrated before and not after the disestablishment of the Church in Ireland they retain this position under the Irish Church Act of 1869. At the coronation of William IV. the lord chancellor of Ireland walked next after the lord chancellor of Great Britain and before the lord president of the council and lord privy seal. In Ireland, if he is a peer he has precedence between the archbishops of Armagh and Dublin, and if he is not a peer after the archbishop of Dublin. But, except in the House of Lords, the precedence of the lord chancellor of Great Britain or the lord keeper of the great seal is the same whether he is a peer or a commoner. The lord keeper has the same precedence as the lord chancellor under 5 Eliz. c. 18. But the last appointment to the lord keepership was that of Sir Robert Henley, afterwards Lord Henley, lord chancellor, and earl of Northampton, in 1757, and the office is not likely to be revived.

¹ Quoted by Sir Charles Young from *State Papers: published by Authority* (4to, 1830), p. 623, in *Privy Councillors and their Precedence* (1850), p. 15.

² *Patent Rolls*, 10th Jac., pt. x. mem. 8. It is commonly stated that the bannerets here referred to could be made by the prince of Wales as well as by the king. But the privilege was conferred by James I. on Henry, the then prince of Wales, only (Selden, *Titles of Honor*, pt. ii. p. 750).

³ *Ibid.*, 14th Jac., part ii. mem. 24; Selden, *Titles of Honor*, part ii. p. 752.

⁴ Cited by Sir Charles Young, *Order of Precedence, with Authorities and Remarks*, p. 27 (London, 1851).

Britain; (13) lord president of the privy council; (14) lord keeper of the privy seal; (15) lord great chamberlain of England; (16) lord high constable of England; (17) earl marshal; (18) lord high admiral; (19) lord steward of the household; (20) lord chamberlain of the household; (21) above peers of their own degree; (22) dukes; (23) marquesses; (24) dukes' eldest sons; (25) earls; (26) marquesses' eldest sons; (27) dukes' younger sons; (28) earls' eldest sons; (29) marquesses' younger

¹ The lord president of the council and the lord privy seal, if they are peers, are placed by 31 Hen. VIII. c. 10 before all dukes except dukes related to the sovereign in one or other of the degrees of consanguinity specified in the act. And, since the holders of these offices have been and are always peers, their proper precedence if they are commoners has never been determined.

² It is provided by 31 Hen. VIII. c. 10 that "the Great Chamberlain, the Constable, the Marshal, the Lord Admiral, the Grand Master or Lord Steward, and the King's Chamberlain shall sit and be placed after the Lord Privy Seal in manner and form following: that is to say, every one of them shall sit and be placed above all other personages being of the same estates or degrees that they shall happen to be of, that is to say the Great Chamberlain first, the Constable next, the Marshal third, the Lord Admiral the fourth, the Grand Master or Lord Steward the fifth, and the King's Chamberlain the sixth." The office of lord high steward of England, then under attainder, is not mentioned in the act for the placing of the Lords, "because it was intended," Lord Chief Justice Coke says, "that when the use of him should be necessary he should not endure longer than *hac vice*" (*Inst.* iv. 77). But it may be noted that, when his office is called out of abeyance for coronations or trials by the House of Lords, the lord high steward is the greatest of all the great officers of state in England. The office of lord great chamberlain of England is hereditary in the coheirs of the last duke of Ancaster, who inherited it from the De Veres, earls of Oxford, in whose line it had descended from the reign of Henry I. The office of lord high constable of England, also under attainder, is called out of abeyance for and pending coronations only. The office of earl marshal is hereditary in the Howards, dukes of Norfolk, premier dukes and, as earls of Arundel, premier earls of England, under a grant in special tail male from Charles II. in 1672. The office of lord high admiral, like the office of lord high treasurer, is practically extinct as a dignity. Since the reign of Queen Anne there has been only one lord high admiral, namely, William, duke of Clarence, afterwards William IV., for a few months in the Canning administration of 1827. The lord steward and the lord chamberlain of the household are always peers, and have seldom been under the degree of earls. We may here remark that both the Scottish and Irish Acts of Union make no reference to the precedence of the great officers of state of Scotland and Ireland. Not to mention the prince of Wales, who is by birth steward of Scotland, the earl of Shrewsbury is hereditary great seneschal of Ireland; the duke of Argyll is hereditary master of the household; the earl of Errol is hereditary lord high constable of Scotland; but what places they are entitled to in the scale of general precedence is altogether doubtful and uncertain. In Ireland the great seneschal ranks after the lord chancellor if he is a commoner, and after the archbishop of Dublin if the lord chancellor is a peer, and in both cases before dukes ("Order of precedence," *Dublin Gazette*, June 3, 1843). Again, on George IV.'s visit to Edinburgh in 1821, the lord high constable had place as the first subject in Scotland immediately after the members of the royal family. At every coronation from that of George III. to that of Queen Victoria, the lord high constable of Scotland has been placed next to the earl marshal of England, and, although no rank has been assigned on these occasions to the hereditary great seneschal of Ireland, the lord high constable of Ireland appointed for the ceremony has been at all or most of them placed next to the lord high constable of Scotland. It is worthy of notice, however, that Sir George Mackenzie, writing when lord advocate of Scotland in the reign of Charles II., says that "the Constable and Marischal take not place as Officers of the Crown but according to their creation as Earls," and he moreover expresses the opinion that "it seems very strange that these who ride upon the King's right and left hand when he returns from his Parliaments and who guard the Parliament itself, and the Honours, should have no precedence by their offices" (*Observations, &c.*, p. 25, in Guillim's *Display of Heraldry*, p. 461 seq.; but see also Wood-Douglas, *Peerage of Scotland*, i. 557).

³ Both Sir Charles Young and Sir Bernard Burke place "Dukes of the Blood Royal" before dukes, their eldest sons before marquesses, and their younger sons before marquesses' eldest sons. In the "Ancient Tables of Precedence," which we have already cited, dukes of the blood royal are always ranked before other dukes, and in most of them their eldest sons and in some of them their younger sons are placed in a corresponding order of precedence. But in this connexion the words of the act for the placing of the Lords are perfectly plain and unambiguous: "All Dukes not aforementioned," i.e. all except only such as shall happen to be the king's son, the king's brother, the king's uncle, the king's nephew, or the king's brother's or sister's son, "Marquesses, Earls, Viscounts and Barons, not having any of the offices aforesaid, shall sit and be placed after their ancients as

sons; (30) bishops; (31) barons; (32) speaker of the House of Commons; (33) commissioners of the great seal; (34) treasurer of the household; (35) comptroller of the household; (36) master of the horse; (37) vice-chamberlain of the household; (38) secretaries of state; (39) viscounts' eldest sons; (40) earls' younger sons; (41) barons' eldest sons; (42) knights of the Garter; (43) privy councillors; (44) chancellor of the exchequer; (45) chancellor of the duchy of Lancaster; (46) lord chief it hath been accustomed." As Lord Chief Justice Coke and Mr Justice Blackstone observe, the degrees of consanguinity with the sovereign to which precedence is given by 31 Hen. VIII. c. 10 are the same as those within which it was made high treason by 28 Hen. VIII. c. 18 for any man to contract marriage without the consent of the king. Queen Victoria, by letters patent under the great seal in 1865, ordained that, "besides the children of Sovereigns of these realms, the children of the sons of any of the Sovereigns of Great Britain and Ireland shall have and at all times hold and enjoy the style or attribute of 'Royal Highness' with their titular dignity of Prince or Princess prefixed to their respective Christian names, or with their other titles of honour." But, notwithstanding this, their rank and place are still governed by the act for the placing of the Lords. The duke of Cumberland has no precedence as a cousin of the king, being the grandson of a son of George III. and would not be a "Royal Highness" at all if his father had not been, like his grandfather, king of Hanover. In *Garter's Roll of the Lords Spiritual and Temporal*, the official list of the House of Lords, the duke of Cumberland is entered in the precedence of his dukedom after the duke of Northumberland. Under the combined operation of the act for the placing of the Lords and the Acts of Union with Scotland (art. 23) and with Ireland (art. 4), peers of the same degrees, as dukes, marquesses, earls, viscounts and barons, severally, have precedence according to priority in the creation of their respective peerages. But peerages of England created before 1707 precede peerages of Scotland created before 1707, peerages of Great Britain created between 1707 and 1801 precede peerages of Ireland created before 1801, and peerages of Ireland created before 1801 precede peerages of the United Kingdom and of Ireland created after 1801, which take precedence in common. The relative precedence of the members of the House of Lords, including the representative peers of Scotland and Ireland, is officially set forth in *Garter's roll*, which is prepared by the Garter king of arms at the commencement of each session of parliament, that of the Scottish peers generally in the *Union Roll*, and that of the Irish peers generally in *Ulster's Roll*, a record which is under the charge of and is periodically corrected by the Ulster king of arms. The *Union Roll* is founded on the "Decree of Ranking" pronounced and promulgated by a royal commission in 1606, which, in the words of an eminent authority in such matters, "was adopted at once as the roll of the peers in Parliament, convention and all public meetings, and continued to be called uninterruptedly with such alterations upon it as judgments of the Court of Session upon appeal in modification of the precedence of certain peers rendered necessary, with the omission of such dignities as became extinct and with the addition from time to time of newly created peerages—down to the last sitting of the Scottish Parliament on the 1st of May 1707" (*The Earldom of Mar, &c.*, by the earl of Crawford (25th) and Balcarres (8th), ii. 16).

⁴ Eldest sons of peers of any given degree are of the same rank as, but are to be placed immediately after, peers of the first degree under that of their fathers; and the younger sons of peers of any given degree are of the same rank, but are to be placed after peers of the second degree and the eldest sons of peers of the first degree under that of their fathers.

⁵ Secretaries of state, if they are barons, precede all other barons under 31 Hen. VIII. c. 10. But if they are of any higher degree their rank is not influenced by their official position.

⁶ Under 1 Will. and Mary, c. 21, being the only commissioners for the execution of any office who have precedence assigned to them.

⁷ The officers of the household who, under Henry VIII.'s warrant of 1540, precede the secretaries of state have been for a long time always peers or the sons of peers, with personal rank higher, and usually far higher, than their official rank. The practical result is, seeing also that the great seal is only very rarely indeed in commission, that the secretaries of state, when they are commoners whose personal precedence is below a baron's, have official precedence immediately after the speaker of the House of Commons. The principal secretaries, for so they are all designated, are officially equal to one another in dignity, and are placed among themselves according to seniority of appointment.

⁸ During more than two centuries only one commoner has been indebted for his precedence to his election into the order, and that was Sir Robert Walpole, the minister, who at the coronation of George II. in 1727 was placed as a knight of the Garter immediately before privy councillors. The proper precedence of both knights of the Thistle and knights of St Patrick is undecided.

⁹ Privy councillors of Great Britain and of Ireland take precedence in common according to priority of admission. The chancellors of the exchequer and of the duchy of Lancaster, the lord chief justice

justice of England; (47) master of the rolls; (48) lords justices of appeal;¹ (49) judges of the High Court of Justice;² (50) knights bannerets made by the sovereign in person; (51) viscounts' younger sons; (52) barons' younger sons; (53) sons of lords of appeal;³ (54) baronets;⁴ (55) knights bannerets not made by the sovereign in person; (56) knights of the first class of the Bath, the Star of India, St Michael and St George;⁵ (57) the Indian Empire, the Royal Victorian Order; (58) knights of the second class of the Bath, the Star of India, and St Michael and St George;⁶ other orders K.C.I.E., &c.; (59) knights bachelors;⁷ (60) sons of commanders of the Royal Victorian Order; (61) judges of county courts;⁸ (62) eldest sons of the younger sons of peers; (63) baronets' eldest sons; (64) knights' eldest sons; (65) baronets' younger sons; (66) knights' younger sons;⁹

of England, the master of the rolls, and the lords justices of appeal are always members of the privy council, and have rank and place as privy councillors, if they are not also peers.

¹The lords justices of appeal have precedence among themselves according to seniority of appointment. Until recently they were preceded by the lord chief justice of the common pleas and the lord chief baron of the exchequer (divisions of the High Court of Justice). But under existing arrangements these offices have fallen into abeyance, although they have not been formally abolished. The vice-chancellors used to follow the lords justices of appeal; but, in spite of the fact that there is still one vice-chancellor remaining, the office of vice-chancellor is extinct and will altogether disappear on his decease. In Ireland all these offices are in existence, but they have no precedence allotted to them in England; as the judges holding them are invariably privy councillors, however, they are ranked accordingly. And it is the same with regard to the lord justice-general and the lord justice-clerk in Scotland.

²The judges of all the divisions of the High Court of Justice are ranked together according to seniority of appointment. Neither the senators of the College of Justice in Scotland nor the judges of the various divisions of the High Court in Ireland have any precedence in England. The precedence of the Scottish judges among themselves is settled by a royal warrant of Nisbet in his *System of Heraldry*. The precedence of the Irish judges among themselves is the same as the precedence of the English judges among themselves used to be before the offices of chief justice of the common pleas and chief baron of the exchequer were suspended.

³By warrants of the 30th of March 1898, although lords of appeal rank with hereditary barons in order of creation, their sons stand in a class by themselves.

⁴It is a question whether baronets ought or ought not to have precedence, like peers, according as they are of England, Scotland, Great Britain, Ireland or the United Kingdom. Baronets are not referred to in either the Scottish or the Irish Act of Union; and Sir Bernard Burke contends that, since the Acts of Union are silent with regard to them, they are still entitled to whatever precedence was originally conferred on them. He therefore places the whole body of the baronets together in the order merely of the dates of their several creations, and in this he appears to us to have both law and reason on his side.

⁵These knights consist of grand crosses of the first, grand commanders of the second, and grand crosses of the third order, and have precedence in their respective orders according to seniority of creation. By the statutes of the order of the Bath, as revised in 1847, it is ordained that the knights grand crosses are to be placed "next to and immediately after baronets," thus superseding knights bannerets not created by the sovereign in person.

⁶Knights commanders of all three orders are placed in each order according to seniority of creation.

⁷Knights bachelors are ranked together according to seniority of creation, whether they are made by the sovereign or the lord lieutenant of Ireland.

⁸Royal x. Warrant of 1884.

⁹The sons of all persons, when any specified rank is assigned to them, are placed in the precedence of their fathers. Eldest sons of the younger sons of peers were ranked before the eldest sons of knights by order of the earl marshal, the 18th of March 1615, and before the eldest sons of baronets by order of the earl marshal, the 6th of April 1677. But no precedence has been given to the younger sons of the younger sons of peers, although precedence is given to the younger as well as the eldest sons of baronets and knights by James I.'s decree of 1616. Moreover, no precedence has been given to either the eldest or the younger sons of the eldest sons of peers. But in practice this omission is generally disregarded, and the children of the eldest sons of dukes, marquesses and earls, at all events, are accorded the same rank and titles which they would have if their fathers were actual instead of *quasi* peers of the degree next under that of their grandfathers. Sir Charles Young says that "by decision (Chap. Coll. Arms of 1680) if the eldest son of an earl died in his father's lifetime leaving a son and heir, such son and heir during the life of the earl his grandfather is

(67) companions of the Bath, the Star of India, St Michael and St George and the Indian Empire;¹⁰ (68) members of the 4th class of the Royal Victorian Order; (69) companions of the Distinguished Service Order; (70) members of the 5th class of the Royal Victorian Order; (71) esquires;¹¹ (72) gentlemen.¹²

2.—General Precedence of Women

The Queen;¹³ (1) queen dowager; (2) princess of Wales; (3) daughters of the sovereign; (4) wives of the sovereign's younger sons; (5) granddaughters of the sovereign; (6) wives of the sovereign's grandsons; (7) sisters of the sovereign; (8) wives of the sovereign's brothers; (9) aunts of the sovereign; (10) wives of the sovereign's uncles; (11) nieces of the sovereign;

entitled to the same place and precedence as was due to his father: so had the father been summoned to parliament as the eldest son of a peer the grandson would succeed to the dignity even during the grandfather's lifetime" (*Order of Precedence*, p. 27). And, of course, what applies to the grandson and heir of an earl applies equally to the grandsons and heirs of dukes and marquesses. But the grandsons and heirs of viscounts and barons are differently situated, and have neither honorary additions to their names nor any ascertained place and precedence even by the etiquette of society.

¹⁰Companions are members of the third class of the first three orders and the only members of the fourth order, except the sovereign and the grand master. Sir Charles Young and Sir Bernard Burke concur in placing the companions of these orders before the eldest sons of the younger sons of peers, on the ground that under their statutes they are entitled to precede "all Esquires of the Realm." But the sons of peers themselves—the eldest as well as the younger—are merely esquires, and are ranked before, and not among, other esquires because they have a particular precedence of their own assigned to them. Similarly the eldest sons of the younger sons of peers and the eldest sons of baronets and of knights who are also esquires, and likewise the younger sons of baronets and of knights who are not esquires, have a particular precedence of their own assigned to them. All of them are placed before esquires as a specific grade in the scale of general precedence, and it seems clear enough that it is before esquires, considered as a specific grade, that the companions of the orders ought to be placed and not before any other persons who, whether they are or are not esquires, have a definite and settled rank which is superior to that specific grade in the scale of general precedence.

¹¹It appears to be admitted on all hands that the following persons are esquires and ought to be so described in all legal documents and processes: first, the eldest sons of peers in the lifetime of their fathers, and the younger sons of peers both in and after the lifetime of their fathers; secondly, the eldest sons of the younger sons of peers and their eldest sons in perpetual succession, and the eldest sons of baronets and knights; thirdly, esquires created with or without the grant of armorial bearings by the sovereign; fourthly, justices of the peace, barristers-at-law and mayors of corporations; and fifthly, those who are styled esquires in patents, commissions or appointments to offices under the Crown in the state, the household, the army or navy and elsewhere. Sir Bernard Burke accords precedence to serjeants-at-law and masters in lunacy, not only before esquires as such, but also before the companions of the orders of knighthood. It is, however, enough to observe with regard to the first, since no more of them are to be created, that, in spite of the extravagant pretensions which have been frequently urged by them and on their behalf, "they have not in the general scale," as Sir Charles Young says, "any precedence, and when under the degree of a Knight rank only as Esquires"; and with regard to the second, that the statute 8 & 9 Vict. c. 100, on which the Ulster king of arms bases their claims, simply provides that they "shall take the same rank and precedence as the masters in ordinary of the High Court of Chancery," who are now extinct, "apparently," to recur to Sir Charles Young, "assuming the rank of the masters without defining it." "The masters, however," he adds, "as such have not a settled place in the order of general precedence emanating from any authority by statute or otherwise" (*Order of Precedence*, p. 71). Sir William Blackstone says that before esquires "the Herald's rank all Colonels, Serjeants-at-Law and Doctors in the three learned professions" (*Commentaries*, vol. i. ch. 12). But the only foundation for this statement seems to be a passage in Guillim, which is obviously without any authority.

¹²The heralds and lawyers are agreed that gentlemen are those who, by inheritance or grant from the Crown, are entitled to bear coat armour (see Coke, *Inst.* iv. ch. 77; Blackstone, *Comm.* i. ch. 12; Selden, *Titles of Honor*, pt. ii. ch. 8; Guillim, *Display of Heraldry*, pt. ii. ch. 26).

¹³The queen-consort is the second personage in the realm, and has precedence of the queen-dowager. But the husband of a reigning queen has no rank or place except such as is specially accorded to him by the sovereign.

(12) wives of the sovereign's nephews;¹ (13) wives of dukes of the blood royal; (14) duchesses;² (15) wives of eldest sons of dukes of the blood royal; (16) marchionesses; (17) wives of the eldest sons of dukes; (18) dukes' daughters;³ (19) countesses; (20) wives of younger sons of dukes of the blood royal; (21) wives of the eldest sons of marquesses; (22) marquesses' daughters; (23) wives of the younger sons of dukes; (24) viscountesses; (25) wives of the eldest sons of earls; (26) earls' daughters, (27) wives of the younger sons of marquesses; (28) baronesses; (29) wives of the eldest sons of viscounts; (30) viscounts' daughters; (31) wives of the younger sons of earls; (32) wives of the eldest sons of barons; (33) barons' daughters; (34) maids of honour to the queen;⁴ (35) wives of knights of the Garter; (36) wives of knights bannerets made by the sovereign in person; (37) wives of the younger sons of viscounts; (38) wives of the younger sons of barons; (39) baronets' wives; (40) wives of knights bannerets not made by the sovereign in person; (41) wives of knights of the Thistle; (42) wives of knights of St Patrick; (43) wives of knights grand crosses of the Bath, grand commanders of the Star of India, and grand crosses of St Michael and St George; (44) wives of knights commanders of the Bath, the Star of India, and St Michael and St George; (45) knights bachelors' wives; (46) wives of the eldest sons of the younger sons of peers; (47) daughters of the younger sons of peers; (48) wives of the eldest sons of baronets; (49) baronets' daughters; (50) wives of the eldest sons of knights; (51) knights' daughters; (52) wives of the younger sons of baronets; (53) wives of the younger sons of knights;⁵ (54) wives of commanders of the Royal Victorian Order, companions of the Bath, the Star of India, St Michael and St George, and the Indian Empire; (55) wives of members of the 4th class Royal Victorian Order; (56) wives of esquires;⁶ (57) gentlewomen;⁷

A special table of precedence in Scotland is regulated by a royal warrant dated the 16th of March 1905, and a special table of precedence in Ireland was set forth by authority of the Lord Lieutenant (Jan. 2, 1895). Both contain errors and will probably be revised.

Attention to the foregoing tables will show that general precedence is of different kinds as well as of several degrees. It is first either personal or official, and secondly either substantive or derivative. Personal precedence belongs to the royal

¹ There is no act of parliament or ordinance of the Crown regulating the precedence of the female members of the royal family. But the above is the gradation which appears to have become established among them, and follows the analogy supplied by the act for the placing of the lords in the case of their husbands and brothers.

² Peeresses in their own right and peeresses by marriage are ranked together, the first in their own precedence and the second in the precedence of their husbands.

³ Among the daughters of peers there is no distinction between the eldest and the younger as there is among the sons of peers. Their precedence is immediately after the wives of their eldest brothers, and several degrees above the wives of their younger brothers. They are placed among themselves in the precedence of their fathers. But the daughter of the premier duke or baron ranks after the wife of the eldest son of the junior duke or baron.

⁴ Maids of honour to the queen are the only women who have any official precedence. They have the style or title of honourable, and are placed immediately after barons' daughters by Sir Bernard Burke, the rank which is accorded to them by the etiquette of society. But Sir Charles Young does not assign any precedence to them, and we do not know on what authority the Ulster king of arms does so, although he is by no means singular in the course he has taken.

⁵ The wives of baronets and knights, the wives of the eldest sons and the daughters of the younger sons of peers, and the wives of the sons and the daughters of baronets and knights are all placed severally in the precedence of their respective husbands, husbands' fathers and fathers.

⁶ "Esquire" and "gentleman" are not names of "dignity" but names of "worship," and esquires and gentlemen do not, in strictness, convey or transmit any precedence to their wives or children (see Coke, *Inst.* ii., "Of Additions," p. 667).

⁷ "And *generosus* and *generosa* are good additions: and if a gentlewoman be named Spinster in any original writ, *i.e.* appeal or indictment, she may abate and quash the same, for she hath as good right to that addition as Baroness, Viscountess, Marchioness or Duchess have to theirs" (Coke, *Inst.* ii., "Of Additions," p. 668).

family, the peerage and certain specified classes of the commonalty. Official precedence belongs to such of the dignitaries of the Church and such of the ministers of state and the household as have had rank and place accorded to them by parliament or the Crown, to the speaker of the House of Commons and to the members of the privy council and the judicature. Substantive precedence, which may be either personal or official, belongs to all those whose rank and place are enjoyed by them independently of their connexion with anybody else, as by the archbishop of Canterbury, the lord high chancellor or the lord great chamberlain, peers and peeresses, baronets, knights and some esquires. Derivative precedence, which can only be personal, belongs to all those whose rank and place are determined by their consanguinity with or affinity to somebody else, as the lineal and collateral relations of the sovereign, the sons, daughters and daughters-in-law of peers and peeresses in their own right, and the wives, sons, daughters and daughters-in-law of baronets, knights and some esquires. It is to be observed, however, that the precedence of the sovereign is at once official and personal, and that the precedence of peeresses by marriage is at once derivative and substantive. In the case of the sovereign it is his or her actual tenure of the office of king or queen which regulates the rank and place of the various members of the royal family, and in the case of peeresses by marriage, although their rank and place are derivative in origin, yet they are substantive in continuance, since during coverture and widowhood peeresses by marriage are as much peeresses as peeresses in their own right, and their legal and political status is precisely the same as if they had acquired it by creation or inheritance.

Bearing the above definitions and explanations in mind, the following canons or rules may be found practically useful:—

1. Anybody who is entitled to both personal and official precedence is to be placed according to that which implies the higher rank. If, for example, a baron and a baronet are both privy councillors, the precedence of the first is that of a baron and the precedence of the second is that of a privy councillor. And similarly, except as hereafter stated, with respect to the holders of two or more personal or two or more official dignities.

2. Save in the case of the sovereign, official rank can never supply the foundation for derivative rank. Hence the official precedence of a husband or father affords no indication of the personal precedence of his wife or children. The wives and children, for example, of the archbishop of Canterbury, the lord high chancellor or the speaker of the House of Commons do not participate in their official rank but only in their personal rank, whatever it may be.

3. Among subjects men alone can convey derivative rank, except in the case of the daughters and sisters of the sovereign, or of peeresses in their own right. But no man can acquire any rank or place by marriage. The sons-in-law or brothers-in-law of the sovereign and the husbands of peeresses in their own right have as such no precedence whatever. And the daughter and heiress of the premier duke of England, unless she happens to be also a peeress in her own right, does not transmit any rank or place to her children.

4. Within the limits of the peerage derivative rank is as a rule always merged in personal, as distinguished from official, substantive rank. If, for example, the younger son of a duke is created a baron or inherits a barony, his precedence ceases to be that of a duke's younger son and becomes that of a baron. But where the eldest son of a duke, a marquess or an earl is summoned to the House of Lords in a barony of his father's, or succeeds as or is created a baron, he is still, as before, "commonly called" by some superior title of peerage, as marquess, earl or viscount, and retains his derivative precedence on all occasions, except in parliament or at ceremonies which he attends in his character as a peer. The younger sons of all peers, however, who are created or who inherit peerages—which they often do under special limitations—are everywhere placed according to their substantive rank, no matter how inferior it may be to their derivative rank. But if the son of a duke or a

marquess, whether eldest or younger, or the eldest son of an earl is consecrated a bishop his derivative rank is not merged in his substantive rank, because it is official, and his derivative and personal rank implies the higher precedence. Again, the daughters of dukes, marquesses and earls who become peeresses by marriage or creation, or who inherit as peeresses, are placed according to their substantive and not according to their derivative rank, although they may thereby be assigned a far lower precedence than that to which their birth entitles them.

5. The widows of peers and baronets have precedence immediately before the wives or widows of the next successors in their husbands' dignities. But the sons and daughters of peers and baronets have precedence immediately before the sons and daughters of the holders of the dignities to whom their fathers succeeded. The reason of this is that the first are senior in the dignities and the second are nearer in the line of succession to them.

6. The widows of peers who marry again either share the precedence of their second husbands or resume the precedence belonging to them independently of their marriage with their first husbands. Thus, if the daughter of a duke or an esquire marries first an earl and secondly a baron, although she remains a peeress, she is placed as a baroness instead of a countess. But if either of them should marry a commoner as her second husband, whatever may be his rank or degree, she ceases to be a peeress. While, however, the duke's daughter, if her second husband were not the eldest son of a duke, would resume her precedence as the daughter of a duke, the esquire's daughter would share the precedence of her second husband, whether he were a peer's son, a baronet, a knight or an esquire. The widows of peers have long kept their former rank in society, but they have no such right unless by permission of the sovereign, which permission has on several recent occasions been refused.

7. The widows of the eldest and younger sons of dukes and marquesses and of the eldest sons of earls, and also the widows of baronets and knights who marry again, are permitted by the etiquette of society to keep the titles and rank acquired by their first marriage if their second marriage is with a commoner whose precedence is considerably lower. But the widows of the younger sons of earls and of the eldest and younger sons of viscounts and barons, although their precedence is higher than that of the widows of baronets and knights, are not allowed to retain it, under any circumstances, after a second marriage.

8. Marriage does not affect the precedence of peeresses in their own right unless their husbands are peers whose peerages are of a higher degree, or, being of the same degree, are of more ancient creation than their own. If, for example, a baroness in her own right marries a viscount she is placed and described as a viscountess, or if she marries a baron whose barony is older than hers she is placed in his precedence and described by his title. But if she marries a baron whose barony is junior to hers she keeps her own precedence and title.

9. The daughters of peers, of sons of peers, baronets and knights retain after marriage the precedence they derive from their fathers, unless they marry peers of any rank or commoners of higher rank than their own. Hence, for example, the daughter of a duke who marries the eldest son of a marquess is placed as a duke's daughter, not as the wife of a marquess's eldest son, and the daughter of a baronet who marries the younger son of a knight is placed as a baronet's daughter and not as the wife of a knight's younger son.

10. What are termed "titles of courtesy" are borne by all the sons and daughters of peers and peeresses in their own right, who in this connexion stand on exactly the same footing. The eldest sons of dukes, marquesses and earls are designated by the names of one or other of the inferior peerages of their fathers, usually a marquessate or an earldom in the first, an earldom or a viscounty in the second and a viscounty or barony in the third case. The rule applicable in former times, still adhered to by the older English dignities, was that a duke's eldest son was styled earl, the son of a marquess, viscount, the son of an earl,

baron. No such rule obtained in Scotland. But, whatever it may be, it is altogether without effect on the rank and place of the bearer, which are those belonging to him as the eldest son of his father. The younger sons of dukes and marquesses are styled "lords," followed by both their Christian names and surnames. The younger sons of earls and both the eldest and the younger sons of viscounts and barons are described as "honourable" before both their Christian names and surnames. The daughters of dukes, marquesses and earls are styled "ladies" before both their Christian names and surnames. The daughters of viscounts and barons are described as "honourable" before both their Christian names and surnames. If the eldest son of a marquess or an earl marries a woman of rank equal or inferior to his own, she takes his title and precedence; but if she is of superior rank she retains, with her own precedence, the prefix "lady" before her Christian name followed by the name of her husband's title of courtesy. Again, if the younger son of a duke or a marquess marries a woman of rank equal or inferior to his own, she is called "lady," with his Christian and surname following, and is placed in his precedence, but, if she is of superior rank, she retains, with her own precedence, the prefix "lady" before her Christian name and his surname. If the daughter of a duke, a marquess or an earl marries the younger son of an earl, the eldest or younger son of a viscount or baron, a baronet, a knight or an esquire, &c., she retains, with her own precedence, the prefix "lady" before her Christian name and her husband's surname. If the daughter of a viscount marries the younger son of an earl or anybody of inferior rank to him, or the daughter of a baron marries the younger son of a viscount or anybody of inferior rank to him, she retains her own precedence with the prefix "honourable" before the addition "Mrs" and his surname or Christian name and surname. But, if her husband is a baronet or a knight, she is called the Honourable Lady Smith or the Honourable Lady Jones, as the case may be. The wives of the younger sons of earls and of the eldest and younger sons of viscounts and barons, if they are of inferior rank to their husbands, take their precedence and are described as the Honourable Mrs, with the surnames or Christian names and surnames of their husbands following. The judges were placed by James I. before the younger sons of viscounts and barons and accorded the title of "honourable" (*q.v.*). But in this addition their wives do not participate, since it is merely an official distinction.

It is manifest on even a cursory examination of the tables we have given that, although they embody the only scheme of general precedence, whether for men or for women, which is authoritatively sanctioned or recognized, they are in many respects very imperfectly fitted to meet the circumstances and requirements of the present day.¹ In both of them the limits prescribed to the royal family are pedantically and inconveniently narrow, and stand out in striking contrast to the wide and ample bounds through which the operation of the Royal Marriage Act (12 Geo. III. c. 11) extends the disabilities but not the privileges of the sovereign's kindred. Otherwise the scale of general precedence for women compares favourably enough with

¹ "There are no doubt certain public ceremonials of State, such as Coronations, Royal Public Funerals and Processions of the Sovereign to Parliament, &c., wherein various public functionaries walk and have for the occasion certain places assigned to them, but which they may not at all times find the same, as it by no means follows that they are always entitled to the same place for having been there once: there is to a certain extent a precedent furnished thereby, and in some cases the uniformity of precedence in regard to one class over another has in such cases become established. This applies, for instance, to the places of the Gentlemen of the Privy Chamber, Law Officers of the Crown and Masters and Six Clerks in Chancery, who have no definite or fixed place in the tables of precedence regulating the general orders of society, though in reference to State ceremonials they have certain places assigned in the order of procession in right of their offices, which, however, give them no general rank. Upon such occasions, nevertheless, the legal rank and precedence which they hold in the Courts of Law is observed, and so far establishes among themselves, and in respect to their several classes, their precedence" (Sir Charles Young, *Order of Precedence*, &c., pp. 59-61).

the scale of general precedence for men. If, indeed, it includes the queen's maids of honour and the wives of the companions of the knightly orders, there certainly does not seem to be any good reason why it should omit the mistress of the robes and the ladies of the bedchamber, or the ladies of the royal order of Victoria and Albert and the imperial order of the Crown of India. But these are trifling matters in themselves, and concern only a minute fraction of the community. The scale of general precedence for men is now in substantially the same condition as that in which it has been for between two and three centuries, and the political, to say nothing of the social, arrangements to which it was framed to apply have in the interval undergone an almost complete transformation. The consequence is that a good deal of it has come down to us in the shape of a survival, and has ceased to be of any practical use for the purpose it was originally designed to effect. While it comprises several official and personal dignities which are virtually obsolete and extinguished, it entirely omits the great majority of the members of Government in its existing form, and whole sections of society on a less exalted level, to whom it is universally felt that some rank and place at all events are both in public and in private justly due. And, when it does confess the presence of any of the sovereign's principal ministers, it commonly places them in positions which are out of all keeping with their actual eminence and importance. It ranks the lord president of the council and the lord privy seal before dukes, while it places the chancellor of the exchequer after the younger sons of earls and the eldest sons of barons, and the secretaries of state after the master of the horse and the vice-chamberlain of the household. The lord chancellor still has precedence as the first of the great officers of state, which was allotted to him not as what he is, the head of the judicature, but as what he once was, the prime minister of the sovereign; and the lord chief justice, who is next to him in regular judicial rank, as presiding over the common law courts, as he presides over the courts of equity, is placed after the chancellors of the exchequer and of the duchy of Lancaster, who still have the precedence which was allotted to them not as ministers, which they are, but as judges, which they are no longer. Neither the lord-lieutenant of Ireland, the viceroy of India, nor the governor-general of Canada has any rank or place at St James's, where, as well as at Westminster, the lord steward or the lord chamberlain of the household is a much greater and more splendid personage. Again, in the scale of general precedence there are no clergymen except bishops, no lawyers except judges, and no officers of either the army or the navy from field marshals and admirals of the fleet downwards. Nor, of course, are any colonial governors or lieutenant-governors entered on it. It contains no mention of under-secretaries of state, chairmen or commissioners of administrative boards, comptrollers or secretaries of government departments, lord-lieutenants or sheriffs of counties, deputy lieutenants or justices of the peace, members of the House of Commons or graduates of the universities. It is true that among some of these classes definite systems of subordination are established by either authority or usage, which are carefully observed and enforced in the particular areas and spheres to which they have reference. But we have seldom any means of determining the relative value of a given term in one series as compared with a given term in another series, or of connecting the different steps in the scales of local, professional or academical precedence with the different steps in the scale of general precedence, to which such scales of special precedence ought to be contributory and supplementary. We know, for example, that major-generals and rear-admirals are of equal rank, that with them are placed commissaries-general and inspectors-general of hospitals and fleets, that in India along with civilians of thirty-one years' standing they immediately follow the vice-chancellors of the Indian universities, and that in relation to the consular service they immediately precede agents-general and consuls-general. But there is nothing to aid us in determining whether in England they should be ranked with, before or after deans, king's counsel or doctors in divinity, who are as destitute as they are themselves of any recognized

general precedence, and who, as matters now stand, would certainly have to give place to the younger sons of baronets and knights and the companions of the knightly orders.

No foreigner has any legal precedence in Great Britain,¹ but it is suggested that it being proper courtesy to accord to guests the precedence due to the rank they bear in their own countries, they should rank in society with and immediately before those of the relative rank in England. It should, however, be remembered that the younger sons of counts and other nobles bear the title of count with the addition of the Christian name, and they should be ranked with younger sons of British earls, &c., whatever title they bear. The eldest son of a duke for example is sometimes called prince, but the place accorded to him by the above rule would be next after a British marquess. Some persons of authority consider, however, that a foreigner should be given precedence over every native whatever the rank may be.

It has now become usual to recognize ecclesiastical rank derived from the pope, even when held by subjects of the king. Cardinals, therefore, rank by international usage above archbishops, as princes of the blood royal, and in Ireland, Roman Catholic and Protestant bishops rank as such by authority of the warrants there in force.

An order respecting precedence was sent by the secretary of state for the colonies to the governor-general of Canada (July 24, 1868). Precedence in India is regulated by a Royal Warrant dated the 6th of May 1871, a copy of which is subjoined.

VICTORIA, by the Grace of God, of the United Kingdom of Great Britain and Ireland, Queen, Defender of the Faith.

To all to whom these presents shall come, greeting.

Whereas it hath been represented unto Us that it is advisable to regulate the Rank and Precedence of persons holding appointments in the East Indies. In order to fix the same, and prevent all disputes, We do hereby declare that it is Our will and pleasure that the following Table be observed with respect to the Rank and Precedence of the persons hereinafter named, viz. :—

Governor-General and Viceroy of India. Governor of Madras. Governor of Bombay. President of the Council of the Governor-General. Lieutenant-Governor of Bengal. Lieutenant-Governor of North-West Provinces. Lieutenant-Governor of the Punjab. Commander-in-Chief in India, when a Member of Council. Chief Justice of Bengal. Bishop of Calcutta, Metropolitan of India. Chief Justices of Madras, Bombay and North-Western Provinces. Commanders-in-Chief in Madras and Bombay, when also Members of Council. Ordinary Members of the Council of the Governor-General. Bishops of Madras and Bombay. Ordinary Members of Council in Madras and Bombay.

Commander-in-Chief in India, when not a Member of Council. Puisne Judges of the High Courts of Calcutta, Madras, Bombay and North-Western Provinces. Commanders-in-Chief, Madras and Bombay, when not Members of Council. Chief Commissioners and Resident at Hyderabad. Military Officers above rank of Major-General. Additional Members of the Council of the Governor-General when assembled to make laws, &c. Commodore commanding Her Majesty's Naval Forces in India. Judge Advocate General of India. Secretaries to the Government of India. Additional Members of the Councils of the Governors of Madras and Bombay when assembled to make laws, &c. Members of the Legislative Council of the Lieutenant-Governor of Bengal. Agents to the Governor-General in Rajpootana and Central India. Commissioner in Sind. Judges of the Chief Court, Punjab. Chief Secretaries to the Governments of Madras and Bombay.

FIRST CLASS

Civilians of 28 years' standing to rank with Major-Generals.

Advocate General, Calcutta. Residents at Foreign Courts and Residents at Aden, the Persian Gulf and Bagdad. Recorders of Moulmein and Rangoon. Advocates-General, Madras and Bombay. Members of the Boards of Revenue, Bengal, Madras, North-West Provinces. Secretaries to Local Governments. Chief Engineer, 1st Class. Comptroller-General of Accounts in India. Directors-General, Post Office, Telegraphs and Irrigation. Judicial Commissioners, Oude, Central Provinces, Mysore and Sind. Financial Commissioners in the Punjab, Oude and Central Provinces. Archdeacon of Calcutta. Secretary to Council of Governor-General for making Laws, &c. Officers Commanding Brigades.

¹ This subject was considered by the House of Lords in February 1628, on the proposition of a committee that no foreign nobility had right of precedence within this realm before any peer of this kingdom.

SECOND CLASS

Civilians of 20 years' standing ranking with Colonels. Commissioners of Divisions. Directors of Public Instruction under Governments. Private Secretary to Viceroy. Military Secretary to Viceroy. Archdeacons of Madras and Bombay. Surveyor-General of India. Superintendent, Great Trigonometrical Survey. Sanitary Commissioner with Government of India. Superintendent of the Geological Survey in India. Inspector-General of Forests in India.

Inspector-General of Police. } Under Local Governments.
Registrars-General. }

Standing Counsel to Government of India. Remembrancers of Legal Affairs, and Legal Advisers to the Government in the North-West Provinces and the Punjab. Commissioners of Revenue Survey and Settlement. Chief Engineers, 2nd and 3rd Class, and Superintendents of Irrigation.

THIRD CLASS

Civilians of 12 years' standing ranking with Lieutenant-Colonels. Political Agents. Under-Secretaries to Government of India. Inspector-General of Education, Central Provinces, and Directors-General of Education, Oude, British Burmah, Berar and Mysore. Officers, 1st Grade, Education Department. Officers, 1st Grade, Financial Department. Private Secretaries to Governors. Military Secretaries to Governors. First Judges of Presidency Courts of Small Causes. Chief Magistrates of Presidency Towns. Administrator-General, Calcutta. Administrators-General, Madras and Bombay.

Inspectors-General of Jails. } Under Local Governments.
Sanitary Commissioners. }
Conservators of Forests. }

Superintending Engineers, 1st Class. Deputy Directors of Post Office and Telegraphs and Directors of Traffic and Construction. Postmasters-General. Senior Chaplains. Officers, 1st Grade, Geological Survey. Officers, 2nd Grade, Education Department. Officers, 2nd Grade, Financial Department. Superintendents, 1st Grade, Telegraph Department.

FOURTH CLASS

Civilians of 8 years' standing ranking with Majors. Assistant Political Agents. Officers, 2nd Grade, Geological Survey. Officers, 3rd Grade, Education Department. Officers, 3rd Grade, Financial Department. Superintendents, 2nd Grade, Telegraph Department. Government Solicitors.

FIFTH CLASS

Civilians of 4 years' standing ranking with Captains. Junior Chaplains. Officers, 4th Grade, Education Department.

SIXTH CLASS

Civilians of less than 4 years' standing to rank with Subalterns.

Note 1.—Commissioners of Divisions within their own Divisions, and Residents and Political Agents within the limits of their respective charges, to take precedence immediately before Civilians of the 1st Class.

Note 2.—Collectors and Magistrates of Districts, and Deputy Commissioners of Districts, and the Chief Officer of each Presidency Municipality, to take precedence within their respective charges before the 3rd Class and Lieutenant-Colonels in the Army.

Sheriffs to rank within their charges immediately after Lieutenant-Colonels in the Army.

All Officers not mentioned in the above table, whose rank is regulated by comparison with rank in the Army, to have the same rank with reference to Civil Servants as is enjoyed by Military Officers of equal grades.

All other persons who may not be mentioned in this table to take rank according to general usage, which is to be explained and determined by the Governor-General in Council in case any question shall arise.

Nothing in the foregoing rules to disturb the existing practice relating to precedence at Native Courts, or on occasions of intercourse with Natives, and the Governor-General in Council to be empowered to make rules for such occasions in case any dispute shall arise.

All ladies to take place according to the rank herein assigned to their respective husbands, with the exception of wives of Peers, and of ladies having precedence in England, independently of their husbands, and who are not in rank below the daughters of Barons; such ladies to take place according to their several ranks, with reference to such precedence in England, immediately after the wives of Members of Council at the Presidencies in India.

Given at Our Court at Windsor, this sixth day of May, in the year of our Lord one thousand eight hundred and seventy-one, and in the thirty-fourth year of our Reign.

By Her Majesty's Command.

(Signed) ARGYLL.

(F. DR.; W. A. L.)

PRECENTOR (Late Lat. *praecentor*, from *praecinere*, to sing before, lead in singing), the title of the principal director of the singing or musical portions of the service in a cathedral or cathedral church. In the English Church in cathedrals of the "Old Foundation" the precentor is a member of the cathedral chapter and officially ranks next to the dean. His musical duties are usually performed by the "succentor," one of the vicars choral. In cathedrals of the "New Foundation" the "precentor" is not a member of the chapter, but is one of the minor canons.

PRECEPT (Lat. *praecceptum*, a rule, from *praecipere*, literally to take beforehand, to give rules, instructions or orders), a command or rule, especially one with regard to conduct or action, a moral rule or injunction, a maxim. Apart from this general use, the word was used, in law, of many orders in writing issuing from a court or other legal authority; it is now chiefly used of an order demanding the payment of money under a rate by poor law or other local authorities (see **RATE**). The Latin form *praeci-pe*, *i.e.* enjoin, command, is used of the note of instructions delivered by a plaintiff or his solicitor to be filed by the officer of the court, giving the names of the plaintiff and defendant, the nature of the writ, &c. For the obsolete writ of *praeci-pe quod reddat* see **WRIT**.

PRECEPTOR, a teacher or instructor, the classical meaning of the Latin *praecceptor*, from *praecipere*, literally to take in advance, hence to give rules or "precepts," advise, teach. As an educational term in English the word is familiar through the College of Preceptors, a chartered society chiefly composed of private teachers; it was incorporated in 1849 and was one of the first professional bodies to institute regular courses of pedagogic lectures and to award after examination the titles of licentiate and associate to teachers. It also holds examinations for pupils. In post-classical Latin *praecceptor* meant a commander, *praecipere*, to order, enjoin, and the term was adopted by the Knights Templars for the heads of the provincial communities of knights established on their estates. These communities and the estates themselves were known as "preceptories," and answered to the "commanderies" of the Hospitaliers.

PRECESSION OF THE EQUINOXES, in astronomy, the term assigned to the progressive motion of the equinox, because it takes place in a direction from east towards west, opposite to that in which planets move, and in which longitudes are measured. The equinox being defined as the point of intersection of the equator and ecliptic, its motion arises from the fact that both of these great circles are in continuous though slow motion. The motion of the ecliptic is due to the action of the planets on the earth, which produces a slow progressive change in the position of the plane of the earth's orbit, and therefore of the ecliptic. This motion takes place round a diameter of the celestial sphere as an axis or nodal line, which intersects the sphere in two points, which are at present in longitudes about 173° and 353°. The direction of the motion around this axis is such that from the limits 353° through 0° to 173°, which includes the vernal equinox, the motion is towards the south, while, in the remainder of the circle, it is towards the north. At the present time the rate of the motion is 46.7" per century. In consequence of the smallness of the angle, 7°, which the axis of motion makes with the line of the equinoxes, its effect on the precession is quite small, now amounting to only 0.14" per annum. Owing to its cause this small part of the precession is called "planetary."

The motion of the equator is due to the combined action of the sun and moon on the equatorial protuberance of the earth (see **ASTRONOMY**). Owing to its cause this largest part of the precession is called "luni-solar." Its fundamental law is that the mean celestial pole at each instant (see **NUTATION**) moves at right angles to the circle joining it to the pole of the ecliptic as that instant. Hence if the pole of the ecliptic were fixed, the celestial pole would revolve around it in a circle at a constant distance equal to the obliquity of the ecliptic. Owing, however, to the slow change in the position of the pole of the ecliptic, the motion is only approximately in a circle, and the obliquity

varies slowly from century to century. At the present time the rate of motion measured on a great circle is about 20" per year; that is to say both the pole and the plane of the equator move through this angle annually. But when measured around the pole of the ecliptic as a centre the motion is about 2.5 times this or, at present, 50.37" annually. This is the present amount of the luni-solar precession which, if it remained constant, would carry the pole completely round in a period of 25,730 years. But the exact period varies slightly, owing to the motion of the pole of the ecliptic. The combined effect of the luni-solar and planetary precession or the total motion of the equinox is called the general precession. Its annual amount during our time is $50.2564 + 0.02220''$ T, T being the time reckoned from 1900 in centuries.

PRECINCT (from Lat. *praecingere*, to encircle, enclose, surround, *prae* and *cingere*, to gird), an enclosure, a space within the boundaries, marked by walls or fences or by an imaginary line, of a building or group of buildings, especially used of such a space belonging to a cathedral or other religious building. The word is frequently used, indefinitely, of the neighbourhood or environs of a place or building. In the United States of America it is applied to various minor territorial divisions or districts, for electoral or judicial purposes. In some of the states they correspond to the "township" as the principal subdivision of the "county."

PRECIOUS (O. Fr. *precios*, mod. *précieux*, Lat. *pretiosus*, of high value or price, *pretium*), costly or of high value, particularly used in political economy of those metals which are "valuable enough to be used as a standard of value and abundant enough for coinage" (*The Century Dictionary*). The term is thus practically confined to gold and silver. Platinum in theory may be included as it was used for coinage in Russia in 1828; the fluctuations in the value of the metal caused its discontinuance in 1845 (see GOLD, SILVER and MONEY). "Precious stones" include those gems which are valued for ornament and jewelry. "Strictly speaking the only precious stones are the diamond, ruby, sapphire and emerald, though the term is often extended to the opal, notwithstanding its lack of hardness, and to the pearl . . . strictly an animal product," G. F. Kunz, *Gems and Precious Stones of North America* (1890) (see GEM, and LAPIDARY AND GEM-CUTTING). A particular use of "precious" as meaning fastidious, over-refined, is taken from the French *précieux*, familiar in the appellation of *Les Précieuses*, given to the social and literary circle of ladies which centred round the Hôtel de Rambouillet in the 17th century (see RAMBOUILLET; CATHERINE DE VIVONNE, MARQUISE DE).

PRECONIZATION (Late Lat. *praeconizatio*, from *praeconizare*, to proclaim, Lat. *praeco*, a public crier), a public proclamation or announcement. In this sense it is practically obsolete; but the word is still technically used of the solemn proclamation of new bishops, and of the sees to which they are appointed, made by the pope in the consistory of cardinals (see BISHOP). In the English ecclesiastical courts "praeconize" is also still used in the sense of "to summon by name."

PREDELLA, the Italian word for a footstool or kneeling-stool, hence applied to the step or platform on which an altar rests, and to a shelf raised above the altar at the back, a super-altar or *gradino*. The face both of the step and shelf are frequently decorated with sculpture or painting, and the term "predella" is frequently given to the sculpture or painting so used, and, further, to any painting that is a pendant to a larger work.

PREDESTINATION (from Late Lat. *praedestinare*, to determine beforehand; from the root *sta*, as in *stare*, stand), a theological term used in three senses: (1) God's unchangeable decision from eternity of all that is to be; (2) God's destination of men to everlasting happiness or misery; (3) God's appointment unto life or "election" (the appointment unto death being called "reprobation," and the term "foreordination" being preferred to "predestination" in regard to it). In the first sense the conception is similar to that of fate; this assumes a moral character as *nemesis*, or the inevitable penalty of transgression.

Sophocles represents man's life as woven with a "shuttle of adamant" (*Antigone*, 622-624). Stoicism formulated a doctrine of providence or necessity. Epicurus denies a divine superintendence of human affairs. A powerful influence in Scandinavian religion was exercised by the belief in "the *nornir*, or Fates, usually thought of as three sisters." In Brahminic thought *Karma*, the consequences of action, necessitates rebirth in a lower or higher mode of existence, according to guilt or merit. With some modifications this conception is taken over by Buddhism. The Chinese *tao*, the order of heaven, which should be the order for earth as well, may also be compared. According to Josephus (*Antiq.* xviii. 1, 3, 4; xiii. 5, 9) the Sadducees denied fate altogether, and placed good and evil wholly in man's choice; the Pharisees, while recognizing man's freedom, laid emphasis on fate; the Essenes insisted on an absolute fate. This statement is exposed to the suspicion of attempting to assimilate the Jewish sects to the Greek schools. In Islam the orthodox theology teaches an absolute predestination, and yet some teachers hold men responsible for the moral character of their acts. The freethinking school of the Mo'tazilites insisted that the righteousness of God in rewarding or punishing men for their actions could be vindicated only by the recognition of human freedom.

The question of the relation of divine and human will has been the subject of two controversies in the Christian church, the Augustinian-Pelagian and the Calvinistic-Arminian. Pelagius maintained the free-will of man, and held that man's conduct, character, destiny are in his own hand. Grace, by enlightening, forgiving sin and strengthening his moral powers, helps man to fulfil this purpose. While grace is meant for all, men make themselves worthy of it by striving after virtue. This doctrine as minimizing grace was repugnant to Augustine. He regarded mankind as sinful, guilty, ruined, incapable of any good. God alone can save. His grace is effectual and irresistible. As what God has done He has eternally willed to do, grace involves predestination. God has from eternity chosen those whom He wills to save ("election"), and consequently He has also passed over those whom He leaves to perish ("praeterition"). As all deserve damnation, there is no injustice in leaving them to their deserts. The "reprobation" of the wicked is not the cause of their sin; God's foreknowledge does not make the sin necessary; how reprobation and foreknowledge are related is not made plain.

The doctrine of Augustine was revived in the 9th century by Gottschalk, who taught that God's passing over the lost meant their predestination to punishment. Hinemar of Reims persecuted him for not distinguishing the two positions. This dispute would have little interest now, had not Hinemar appealed to John Scotus Erigena, who attempted to solve the theological problem by philosophical conceptions. He denied that foreknowledge or predestination as temporal relations could be properly predicated of God as eternal; he described sin and its consequences as negations, neither caused by nor known to God; he maintained that as evil is only a stage in the development of good, there will ultimately be a universal return to God. Thus the doctrine of reprobation was emptied of meaning. This defence of orthodoxy was condemned as heretical. The controversy was kept up during the scholastic period. Thomas Aquinas followed Augustine. Duns Scotus leaned toward Semi-Pelagianism, which rejected the doctrine of predestination, and maintained a co-operation of freedom and grace. While Aquinas affirmed the positions of Augustine, he deduced them from his Aristotelian conception of God as "first mover, itself unmoved." His original contribution to the subject was his theory of divine concurrence. He distinguishes secondary causes as natural and necessary, and as voluntary and contingent; though both are set in motion by God, yet as the natural remain natural, so do the voluntary remain voluntary. But this is clearly only a verbal solution.

At the Reformation the Augustinian position was accepted by both Luther and Calvin. Melancthon modified his earlier view in the direction of synergism, the theory of a co-operation of divine grace and human freedom. The later Lutheran doctrine is "that man, unable as he is to will any good thing, can yet use the means of grace, and that these means of grace, carrying in themselves a divine power, produce a saving effect on all who do not voluntarily oppose their influence. Baptism, e.g. confers grace, which if not resisted is saving. And God, foreseeing who will and who will not, resist the grace offered, predestinates to life all who are foreseen as believers." Calvin's view is the same as Augustine's. He held the *sublapsarian* view that the fall was decreed, but not the *supralapsarian* view that it "was decreed as a means towards carrying out a previous decree to save some and leave others to perish." The latter view was held by Beza and other Calvinists, and, it is said, repelled Arminius from

Calvinism, and led him to formulate the doctrine that as repentance and faith are the divinely decreed conditions of eternal life, God has determined to give that life to all whom He foresees as fulfilling these conditions. According to Calvinism God's election unto salvation is absolute, determined by His own inscrutable will; according to Arminianism it is conditional, dependent on man's use of grace. The Synod of Dort (1618-1619) which affirmed the sublapsarian without excluding the supralapsarian form of Calvinism, condemned the views of Arminius and his followers, who were known as Remonstrants from the remonstrance "which in four articles repudiates supralapsarianism and infralapsarianism (which regarded the Fall as foreseen, but not decreed), and the doctrines of irresistibility of grace, and of the impossibility of the elect finally falling away from it, and boldly asserts the universality of grace."

In the Church of Rome the Dominicans favoured Augustinianism, the Jesuits Semi-Pelagianism; the work of Molina on the agreement of free-will with the gifts of grace provoked a controversy, which the pope silenced without deciding; but which broke out again a generation later when Jansen tried to revive the decaying Augustinianism. The church of England has passed through several disputes regarding the question whether the Thirty-Nine Articles are Calvinistic or not; while there is some ambiguity in the language, it seems to favour Calvinism. At the Evangelical Revival the old questions came up, as Wesley favoured Arminianism and George Whitefield Calvinism. In Scotland Calvinism was repudiated by James Morison, the founder of the Evangelical Union, who declared the three universalities, God's love for all, Christ's death for all, the Holy Spirit's working for all.

While retained in the creeds of several denominations, in the public teaching of the churches the doctrine of predestination has lost its place and power. While the doctrine of election magnified God's grace, and so encouraged humility in man, it minimized man's freedom, and so produced either an over-confidence in those who believed themselves elect, or despair in those who could not reach the assurance. Now it is recognized that God's sovereignty must be conceived as consistent with man's liberty. While God fulfils His all-embracing purpose, that fulfilment leaves room for the exercise of individual freedom; the freedom God has bestowed on man He can so restrain and direct as to overrule even its abuse for His own gracious ends. That God desires that all should be saved, and that the salvation of each depends on his own choice—these are the general convictions of modern theology. The problem now is the reconciliation of human freedom with divine foreknowledge. Martineau accepts Dugald Stewart's solution. "There is no absurdity in supposing that the deity may, for wise purposes, have chosen to open a source of contingency in the voluntary actions of his creatures, to which no prescience can possibly extend." Others hold the problem to be insoluble, and not needing to be solved. (A. E. G.*)

PREDICABLES (Lat. *praedicabilis*, that which may be stated or affirmed), in scholastic logic, a term applied to a classification of the possible relations in which a predicate may stand to its subject. The list given by the schoolmen and generally adopted by modern logicians is based on the original fivefold classification given by Aristotle (*Topics*, a iv. 101 b. 17-25): definition (*ὄρος*), genus (*γένος*), differentia (*διαφορά*), property (*ἴδιον*), accident (*συμβεβηκός*).¹ The scholastic classification, obtained from Bœtius's Latin version of Porphyry's *Eisagoge*, modified Aristotle's by substituting species (*εἶδος*) for definition. Both classifications are of universals, concepts or general terms, proper names of course being excluded. There is, however, a radical difference between the two systems. The standpoint of the Aristotelian classification is the predication of one universal concerning another. The Porphyrian, by introducing species, deals with the predication of universals concerning individuals (for species is necessarily predicated of the individual), and thus created difficulties from which the Aristotelian is free (see below).

The Aristotelian classification may be briefly explained: (1) The *Definition* of anything is the statement of its essence (Arist. *τὸ τί ἦν εἶναι*), i.e. that which makes it what it is: e.g. "a triangle is a three-sided rectilinear figure." (2) *Genus* is that part of the essence which is also predicable of other things different from them in kind. A triangle is a rectilinear figure; i.e. in fixing the genus of a thing, we subsume it under a higher universal, of which

it is a species. (3) *Differentia* is that part of the essence which distinguishes one species from another. As compared with quadrilaterals, hexagons, &c., all of which are rectilinear figures, a triangle is "differentiated" as having three sides. (4) A *Property* is an attribute which is common to all the members of a class, but is not part of its essence (i.e. need not be given in its definition). The fact that the interior angles of all triangles are equal to two right angles is not part of the definition, but is universally true. (5) An *Accident* is an attribute which may or may not belong to a subject. The colour of the human hair is an accident, for it belongs in no way to the *essence* of humanity.

This classification, though it is of high value in the clearing up of our conceptions of the essential contrasted with the accidental, the relation of genus, differentia and definition and so forth, is of more significance in connexion with abstract sciences, especially mathematics, than for the physical sciences. It is superior on the whole to the Porphyrian scheme, which has grave defects. As has been said it classifies universals as predicates of individuals and thus involves the difficulties which gave rise to the controversy between realism and nominalism (*q.v.*). How are we to distinguish species from genus? Napoleon was a Frenchman, a man, an animal. In the second place how do we distinguish property and accident? Many so-called accidents are predicable *necessarily* of any *particular* persons. This difficulty gave rise to the distinction of separable and inseparable accidents, which is one of considerable difficulty.

See the modern logic textbooks.

PREDICAMENT, now used only in the sense of a dangerous or unpleasant position or situation. It meant properly that which is "predicated" or affirmed (Lat. *praedicare*) of anything, in logic, one of the ten Aristotelian categories (see **CATEGORY**), and so any definite state or condition. The use of "predicament" in the sense of "bad predicament," without the limiting adjective, is paralleled by "plight," for "bad plight," "success" for "good success."

PREDICATION (from Lat. *praedicare*, to state, assert), in logic, the term which denotes the joining of a predicate to a subject in a judgment or proposition. The statement "all men are mortal" is to predicate mortality of all men. In other words a judgment is made up of a subject and a predicate joined by a copula. Since the true unit of thought is the judgment, since all concepts or universals exist only in continuous thinking (judging), the theory of predication is a fundamental part of logic. The true relation of subject and predicate has not been determined with unanimity, various logicians emphasizing different aspects of the process (see **LOGIC**). The logical use of "predicate" is to be distinguished from the grammatical, which includes the verb, whether it be the verb "to be" in its various forms, or another verb. The simple grammatical sentence "he strokes the dog" the first word is the subject, while "strokes the dog" is the predicate, including verb and object. In logic every proposition is reducible to the form "A is B," "B" being the predicate. Thus the logical form of "he strokes the dog" would be "he is stroking the dog" or some other periphrasis which liberates and determines the logical predicate. The true significance of the logical copula is difficult. It cannot be described simply as a third (i.e. separate part) of the judgment, because until two terms are enjoined by it they are not subject and predicate. Much discussion has raged round the question whether the use of the verb "to be" as the copula implies that *existence* is predicated by the subject. It may be taken as generally agreed that this is not the case (see further **LOGIC**, and the textbooks).

PRE-EXISTENCE, DOCTRINE OF, in theology, the doctrine that Jesus Christ had a human soul which existed before the creation of the world—the first and most perfect of created things—and subsisted, prior to His human birth, in union with the Second Person of the Godhead. It was this human soul which suffered the pain and sorrow described in the Gospels. The chief exposition of this doctrine is that of Dr Watts (*Works*, v. 274, &c.); it has received little support. In a wider form the doctrine has been applied to men in general—namely, that in the beginning of Creation God created the souls of all men, which were subsequently as a punishment for ill-doing incarnated in physical bodies till discipline should render them fit for spiritual existence. Supporters of this doctrine, the Pre-existants or Pre-existiani, are found as early as the 2nd century, among

¹ Strictly Aristotle's classification is into four as *διαφορά* really belongs to *γένος*.

them being Justin Martyr and Origen (*q.v.*), and the idea not only belongs to metempsychosis and mysticism generally, but is widely prevalent in Oriental thought. It was condemned by the Council of Constantinople in 540, but has frequently reappeared in modern thought (cf. Wordsworth's *Intimations of Immortality*) being in fact the natural correlative of a belief in immortality.

PREFACE (Med. Lat. *prefatio*, for classical *praefatio*, *praefari*, to speak beforehand), an introduction to a book, also any preliminary or introductory statement. In liturgical use the term is applied to that portion of the Eucharistic service which immediately precedes the canon or central portion; the preface, which begins at the words *Vere dignum*, "It is very meet, right, &c." is ushered in, in all liturgies, with the *Sursum Corda*, "Lift up your hearts," and ends with the *Sanctus*, "Holy, Holy, Holy, &c." In the Western liturgies proper prefaces are appointed for particular occasions (see LITURGY).

PREFECT (*préfet*), in France, the title of a high official. The prefects of the department were created by a law of the 28th Pluviose in the year VIII. (Feb. 17, 1800). They were intended to be the chief organs of internal administration, and have, in fact, discharged this function, especially under the First and Second Empire, surviving, though with diminished importance, under the other forms of government which modern France has seen. In comparison with other French officials, they are well paid (the salary nowadays ranges from 30,000 to 18,000 francs according to the class).

In the administration of the *ancien régime* the term "prefect" was not employed; practically the only case in which it occurs was in the organization of the establishment of institutions opened by the religious orders, in which there was generally a "prefect of the studies" (*préfet des études*). In the year VIII., in the discussion of the law of the 28th Pluviose, no reason was stated for the choice of this term. But like the "Tribunes" and "Consuls" of the constitution of the year VIII., it was taken from the Roman institutions which were then so fashionable (see PRAEFECT); it may also be recalled that Voltaire had used the term "prefecture" in speaking of the authority of Louis XIV. over the free towns of Alsace.

The prefect has to a certain extent a double character and two series of functions. Firstly he is the general representative of the government, whose duty it is to ensure execution of the government's decisions, the exercise of the law, and the regular working of all branches of the public service in the department. In so far the rôle of the prefect is essentially political; he guarantees the direct and legal action of the government in his department. He has the supervision of all the state services in his department, which procures the necessary uniformity in the working of the services, each of which is specialized within a narrow sphere. He serves as a local source of information to the government, and transmits to it complaints or representations from those under his administration. In the name of the state he exercises a certain administrative control over the local authorities, such as the *conseil général*, the mayors and the municipal councils. This control, though considerably restricted by the law of the 10th of August 1871, on the *conseils généraux*, and that of the 5th of April 1884, on municipal organization, still holds good in some important respects. The prefect can still annul certain decisions of the *conseil général*. He can suspend for a month a municipal council, mayor or deputy-mayor; certain decisions of the municipal councils require his approval; and he may annul such of their regulations as are *extra vires*. He can annul or suspend the *maire's* decrees and he has also considerable control over public institutions, charitable and otherwise. He may make regulations (*règlements*) both on special points, in virtue of various laws, and for the general administration of the police.

When the prefects were created in the year VIII. the intendants of provinces of the *ancien régime* were taken as a model, and there is a great resemblance between their respective functions. The prefect, however, is no more than an intendant in miniature, being only at the head of a department, whereas the intendant was over a *généralité*, which was a much larger district. In the same way the *sous-préfets* correspond to the *subdélégués* of the intendants, with the difference that they are actual officials subordinate to the prefects, while the *subdélégués* were merely the representatives with whom the intendants provided themselves, and to whom they gave powers.

Secondly, the prefect is not only the general representative of the government, but the representative of the department in the management of its local interests. But his unfettered powers in

this respect have been reduced under the third Republic. This has chiefly been the effect of the law of the 10th of August 1871, which has led to decentralization, by increasing the powers of the *conseils généraux*. The law created a departmental committee (*commission départementale*), elected by the *conseil général* which, in the interval of the sessions of the latter, takes part in matters concerning the administration of the departmental interests, either in virtue of the law, or by a delegation of powers from the *conseil général*.

The *sous-préfets*, having very limited powers of deciding questions, serve above all as intermediaries between the prefect and the persons under his administration. This function was most useful in the year VIII., when communications were difficult, even within a department, but nowadays it only leads to complications. As a matter of fact their chief service to the administration lies in keeping up good relations with the *maires* of the communes in their *arrondissement*, and thus acquiring a certain amount of influence over them. The National Assembly, which passed the law of the 10th of August 1871, had also decided to suppress the *sous-préfets*, but M. Thiers, who was then president of the Republic, persuaded them to reconsider this decision. Since then the Chamber of Deputies has on several occasions taken advantage of the budget to attempt the suppression of the *sous-préfets* by refusing to vote the amount necessary for the payment of their salaries. But the government has always opposed this unconstitutional measure, holding that the suppression could only be effected by an organic law, and that it would necessarily involve a remodelling of the administrative organization. So far their view has prevailed in the Chambers. (J. P. E.)

PREHNITE, a mineral consisting of calcium hydrogen orthosilicate, $H_2Ca_2Al_2(SiO_4)_2$. It crystallizes in the hemimorphic class of the orthorhombic system, but the hemimorphic character is usually obscured by twinning. Crystals are generally platy in habit, but they rarely occur singly and distinctly shaped; almost invariably they are closely aggregated together to form barrel-shaped or globular groups with a crystalline surface. This form, together with the pale oil-green colour, gives the mineral a very characteristic appearance. It is translucent and has a vitreous lustre. The hardness is rather over 6 and the spec. grav. 2.80-2.95. Crystals are pyro-electric. Prehnite is sometimes classed with the zeolites, since it occurs under the same conditions as these minerals and often in association with them: the small amount of water (4.4%) is, however, expelled only at a red heat and is therefore not water of crystallization.

Prehnite occurs as a mineral of secondary origin in the amygdaloidal cavities of basic igneous rocks, such as basalt and diabase, and less often, in veins in granite and gneiss. Fine specimens are found with zeolites in the volcanic rocks of several places in the south of Scotland, e.g. Old Kilpatrick in Dumbartonshire, Bishopston in Renfrewshire, Campsie Hills in Stirlingshire and in the neighbourhood of Edinburgh; also at Paterson and Bergen Hill in New Jersey, and with native copper in the trap-rocks of the Lake Superior region. In the French (at Le Bourg d'Oisans) and Tyrolean Alps it occurs with axinite, epidote, felspar, &c., lining crevices in gneiss. Large masses have been found at Cradock in Cape Colony, from which locality it was brought in the 18th century by Colonel Prehn, the governor of the colony; hence the names "Cape chrysolite" and prehnite (of A. G. Werner, 1789). Prehnite is sometimes cut and polished for small ornaments; it then somewhat resembles chrysope in appearance.

PREJUDICE (Lat. *praepudicium*), literally judgment or decision beforehand, which in classical usage meant a precedent, a preceding judgment, also a special form of judicial examination precedent to a trial, especially in matters relating to *status*. The transferred sense, of injury or damage inflicted by decisions or judgments disregarding interests affected, does not appear till post-classical times in Latin. This last use of damage appears in English in relation to legal matters, especially in the phrase "without prejudice," i.e. without detriment to rights or claims. When two parties are negotiating for the settlement of a dispute, statements or admissions made by or on behalf of either, with a stipulation, expressed or implied, that the statements are made "without prejudice" to the party's claims in the dispute, cannot be put in evidence in litigation to settle the dispute (see EVIDENCE). The general meaning of the word is that of opinion, favourable or hostile, based on prepossessions, and therefore biased or unreasonable.

PREL, KARL, FREIHERR VON (1839-1899), German philosopher, was born at Landshut on the 3rd of April 1839. After studying at the university of Munich he served in the Bavarian

army from 1859 to 1872, when he retired with the rank of captain. He then gave himself up to philosophical work, especially in connexion with the phenomena of hypnotism and occultism from the modern psychological standpoint. He attempted to deduce the existence of spirit, apart from, and yet entering from time to time into connexion with, the phenomena of the senses, by an examination of the relation between the ego of thought and the age of sensible experience as understood by Kant. In 1868 he received the degree of doctor from the university of Tübingen in recognition of a treatise on the psychology of Dreams (*Oneirokritikon. Der Traum vom Standpunkt des transcendentalen Idealismus*).

Subsequently, he published numerous works on various psychological and scientific subjects, of which the more important are: *Der gesunde Menschenverstand vor den Problemen der Wissenschaft* (1872); *Der Kampf ums Dasein am Himmel* (1874), republished in 1882 under the title *Entwicklungsgeschichte des Weltalls*; *Die Planetenbewohner und die Nebularhypothese* (1880); *Die Philosophie der Mystik* (1885); *Justinus Kerner und die Seherin von Prevorst* (1886); *Die monistische Seelenlehre* (1888); *Die Mystik der alten Griechen* (1888); *Kants mystische Weltanschauung* (1889); *Studien aus dem Gebiete der Geheimplissenschaften* (1890); *Der Spiritismus* (1893); *Die Entdeckung der Seele durch die Geheimplissenschaften* (1894-1895). In *Der Kampf ums Dasein am Himmel* von Prel endeavoured to apply the Darwinian doctrine of organic evolution not only to the sphere of consciousness but also even more widely as the philosophical principle of the world. He was one of a large number of German thinkers who during the latter half of the 19th century endeavoured to treat the mind as a mechanism. He died on the 4th of August 1899.

See EVOLUTION; in *Philosophy*.

PRELATE (Lat. *praelatus*, set above, from *praefero*, prefer), an ecclesiastical dignitary of high rank. In the early middle ages the title *prelate* was applied to secular persons in high positions and thence it passed to persons having ecclesiastical authority. The *De prelatibus* of Valerian is concerned with secular princes, and even as late as the 14th century the title was occasionally applied to secular magistrates. In medieval ecclesiastical usage the term might be applied to almost any person having ecclesiastical authority; it was very commonly given to the more dignified clergy of a cathedral church, but often also to ordinary priests charged with the cure of souls and, in the early days of monasticism, to monastic superiors, even to superiors of convents of women. The term occurs very frequently in the Rule of St Benedict and other early monastic rules.

In more modern usage in the Roman Catholic Church prelates, properly so-called, are those who have jurisdiction *in foro externo*, but a liberal interpretation has given the title a more general significance. Prelacy is defined by the canonists as "pre-eminence with jurisdiction" (*praeeminentia cum jurisdictione*), and the idea supposes an episcopal or quasi-episcopal jurisdiction. But gradually the title was extended to ecclesiastical persons having a prominent office even without jurisdiction, and later still it has come to be applied to ecclesiastical persons marked by some special honour though without any definite office or jurisdiction.

We may therefore distinguish "true" from "titular" prelates. The true prelacy is composed of the persons who constitute the ecclesiastical hierarchy; jurisdiction is inherent in their office and gives pre-eminence, as with patriarchs, archbishops and bishops. A good example of the dependence of prelacy on jurisdiction is found in those religious orders, such as the Dominicans, where authority is strictly elective and temporary. Thus a Dominican prior ranks *ipso facto* as a prelate during his three years of office, but, if not re-elected, loses this dignity with his jurisdiction.

The true, no less than the titular, prelates have their various ranks, differing as regards title, precedence, clothing and other insignia. The distinguishing colour of a prelate's clothing is violet; the form, like the greater or less use of violet, depends on the rank of the prelate. Four classes may be distinguished: (1) Great prelates, e.g. cardinals, archbishops and bishops. (2) Exempt prelates (*praelati nullius dioeceseos, praelati nullius*), i.e. abbots and religious superiors, who are withdrawn from the ordinary diocesan jurisdiction and themselves possess episcopal

jurisdiction (*jurisdictio quasi episcopalis*). (3) Roman prelates, (a) active and (b) honorary. The title is applied to numerous ecclesiastics attached by some dignity, active or honorary, to the Roman court (see CURIA ROMANA). In the list of these prelates are protonotaries apostolic, domestic prelates, private chamberlains, *participanti* and supernumerary. Of these last there are two kinds, honorary and honorary *extra urbem*. Only protonotaries and domestic prelates are for life; the others lose their dignity at the death of the pope who appointed them. A special class of Roman prelatures exist at Rome, endowed as a kind of ecclesiastical majority to which those members of certain families who are destined for the clerical life naturally succeed.

In the reformed churches the title was retained in England, Sweden, Denmark and Germany. The cathedral chapter of Brandenburg consists of two prelates, the dean and the senior, besides eight other members. The chapter of Merseburg contains five prelates, viz. the dean, senior, provost, custos and scholasticus. In Baden the general synod is presided over by the prelate (*prelat*), i.e. the principal "superintendent." In the Church of England the term prelate has been since the Reformation applied only to archbishops and bishops. The word "prelacy," meaning no more originally than the office and dignity of a prelate, came to be applied in Presbyterian Scotland and Puritan England—especially during the 17th century—to the episcopal form of church government, being used in a derogatory sense.

See Du Cange, *Glossarium mediae et infimae latinitatis* (new ed., by L. Favre, Niort, 1883); Paul Hinschius, *Kirchenrecht* (Berlin, 1869); F. H. Vering, professor of law at Prague, *Lehrbuch des katholischen, orientalischen und protestantischen Kirchenrechts* (1893). (E. O'N.)

PRELLER, FRIEDRICH (1804-1878), German landscape painter, was born at Eisenach on the 25th of April 1804. After studying drawing at Weimar, he went in 1821, on Goethe's advice, to Dresden, where in 1824 he was invited to accompany the grand duke of Weimar to Belgium. He became a pupil in the academy at Antwerp. From 1827 to 1831 he studied in Italy, and in 1831 received an appointment in the Weimar school of art. In 1834-1836 he executed in tempera six pictures on subjects taken from the *Odyssey* in the "Roman House" at Leipzig, in 1836-1837 the landscapes with scenes from *Oberon* in the Wieland room in the grand-ducal palace at Weimar, and in 1836-1848 six frescoes on Thuringian subjects commissioned by the grand duchess. In 1840 he visited Norway and produced a number of easel works, some of which are preserved at Weimar. In 1859 he revisited Italy, and on his return in 1861 he completed for the grand-ducal museum the frescoes illustrative of the *Odyssey*, which are held to constitute his chief claim to fame. Preller, who was also a successful etcher, died at Weimar on the 23rd of April 1878.

PRELLER, LUDWIG (1809-1861), German philologist and antiquarian, was born at Hamburg on the 15th of September 1809. After having studied at Leipzig, Berlin and Göttingen, in 1838 he was appointed to the professorship of philology at Dorpat, which, however, he resigned in 1843. He afterwards spent some time in Italy, but settled in Jena in 1844, where he became professor in 1846. In the same year he removed as head librarian to Weimar, where he died on the 21st of June 1861. His chief works are: *Demeter u. Persephone* (1837); *Griechische Mythologie* (1854-1855; 4th ed., by C. Robert, 1887 seq.); and *Römische Mythologie* (1858; 3rd ed. by H. Jordan, 1881-1883). He also co-operated with H. Ritter in the preparation of the most useful *Historia philosophiae graecae et romanae ex fontium locis contexta* (1838; ed. E. Wellmann, 1898). He contributed extensively to Ersch and Gruber's *Allgemeine Encyclopädie* and Pauly's *Realencyclopädie der classischen Altertumswissenschaft*. A complete list of his works will be found in *Ausgewählte Aufsätze aus dem Gebiete der klassischen Altertumswissenschaft* (ed. R. Köhler, 1864).

See G. T. Stiehling, *Ludwig Preller. Eine Gedächtnissrede* (Weimar, 1863); C. Bursian, *Geschichte der classischen Philologie in Deutschland* (1883).

PREMIUM (Lat. *praemium*, profit, reward, *prae+emere*, to buy), in general, a reward or prize; a consideration. In the law of insurance, the sum of money or consideration (either annual or in a lump sum) which the insured pays the insurers in order to gain a certain amount in the event of some specific loss happening is termed a premium. The word is applied to the fee paid in consideration of being taught a trade or profession. It is also used in the sense of "bonus," as something beyond or additional, as in the phrases, "premium bonus system," "premium system," where a bonus or sum is given in addition to wages in proportion to the value of the work done. On the stock exchange, when a security has not yet been fully paid up, it is customary to quote its price at par, or so much *premium* or discount. Par represents the amount actually paid up on it, while if it is above the level it is said to be at a premium of so much, or if below at a discount.

PREMONITION (from Lat. *prae*, before, *monere*, to advise or warn), an impression relating to a future event. Strictly the word should mean a warning proceeding from an external source. Its modern extension to all forms of impression supposed to convey information as to the future is justified on the assumption that such intimations commonly originate in the subliminal consciousness of the percipient and are thence transferred to the ordinary consciousness. In modern times the best attested premonitions are those relating to events about to occur in the subject's own organism. It was observed by the animal magnetists at the beginning of the 19th century in France and Germany, that certain of their subjects, when in the "magnetic" trance, could foretell accurately the course of their diseases, the date of the occurrence of a crisis and the length of time needed to effect a cure. Similar observations were subsequently recorded in Great Britain and in America (see, for instance, the case of Anna Winsor, 1860-1863, reported by Dr Ira Barrows). The power of prediction possessed by the subject in such cases may be explained in two ways: (1) As due to an abnormal power of perception possessed by certain persons, when in the hypnotic trance, of the working of their own pathological processes; or (2) more probably, as the result of self-suggestion; the organism is "set" to explode at a given date in a crisis, or to develop the fore-ordained symptoms.

Apart from these cases there are two types of alleged premonitions. (1) The future event may be foreshadowed by a symbol. Amongst the best known of these symbolic impressions are banshees, corpse lights, phantom funeral processions, ominous animals or sounds and symbolic dreams (e.g. of teeth falling out). Of all such cases it is enough to say that it is impossible for the serious inquirer to establish any causal connexion between the omen and the event which it is presumed to foreshadow. (2) There are many instances, recorded by educated witnesses, of dreams, visions, warning voices, &c., giving precise information as to coming events. In some of these cases, where the dream, &c., has been put on record before its "fulfilment" is known, chance is sufficient to explain the coincidence, as in the recorded cases of dreams foretelling the winner of the Derby or the death of a crowned head. In cases where such an explanation is precluded by the nature of the details foreshadowed, the evidence is found to be defective, generally from the absence of contemporary documents. The persistent belief on the part of the narrators in the genuineness of their previsions indicates that in some cases there may be a hallucination of memory, analogous to the well known feeling of "false recognition." Prof. Josiah Royce has suggested for this supposed form of hallucination the term "pseudo-presentiment."

BIBLIOGRAPHY.—See Puységur, *Du Magnétisme animal* (1807); Alexandre Bertrand, *Traité du somnambulisme* (1823); Mrs H. Sidgwick, *Proceedings S.P.R.*, vol. v.; F. W. H. Myers, *Proceedings S.P.R.*, vol. xi.; F. W. H. Myers, *Human Personality* (1903); F. Podmore, *Studies in Psychical Research* (1897); *Proceedings American Society for Psychical Research* (1889, Report on Phantasms and Presentiments); *Annales des sciences psychiques* (Jan.-Feb., 1889, Article on Premonitions by G. B. Ermacora). (F. P.)

PREMONSTRATIENSIS, also called Norbertines, and in England White Canons, from the colour of the habit: an order

of Augustinian Canons founded in 1120 by St Norbert, afterwards archbishop of Magdeburg. He had made various efforts to introduce a strict form of canonical life in various communities of canons in Germany; in 1120 he was working in the diocese of Laon, and there in a desert place, called Prémontré, in Aisne, he and thirteen companions established a monastery to be the cradle of a new order. They were canons regular and followed the so-called Rule of St Augustine (see AUGUSTINIANS), but with supplementary statutes that made the life one of great austerity. St Norbert was a friend of St Bernard of Clairvaux—and he was largely influenced by the Cistercian ideals as to both the manner of life and the government of his order. But as the Premonstratensians were not monks but canons regular, their work was preaching and the exercise of the pastoral office, and they served a large number of parishes incorporated in their monasteries. The order was founded in 1120; in 1126, when it received papal approbation, there were nine houses; and others were established in quick succession throughout western Europe, so that at the middle of the 14th century there are said to have been over 1300 monasteries of men and 400 of women. The Premonstratensians played a predominant part in the conversion of the Wends and the Christianizing and civilizing of the territories about the Elbe and the Oder. In time mitigations and relaxations crept in, and these gave rise to reforms and semi-independent congregations within the order. The Premonstratensians came into England (c. 1143) first at Newhouse in Lincoln, and before the dissolution under Henry VIII. there were 35 houses. At the beginning of the 19th century the order had been almost exterminated, only eight houses surviving, all in the Austrian dominions. There are now some 20 monasteries and 1000 canons, who serve numerous parishes; and there are two or three small houses in England. The strength of the order now lies in Belgium, where at Tongerlo is a great Premonstratensian abbey that still maintains a semblance of its medieval state.

Helyot, *Histoire des ordres religieux* (1714), ii. chs. 23-26; Max Heimbucher, *Orden u. Kongregationen* (1907), ii. § 56; articles in Wetzer u. Welte *Kirchenlexicon* (2nd ed.) and Herzog *Realencyklopädie* (3rd ed.). The best special study is F. Winter, *Die Prämonstratenser des 12. Jahrh. und ihre Bedeutung für das nordöstliche Deutschland* (1865). (E. C. B.)

PREMYSL, the reputed ancestor of the line of dukes and kings which ruled in Bohemia from 873 or earlier until the murder of Wenceslaus III. in 1306, and which was known as the Přemyslide dynasty. According to legend Přemysl was a peasant of Staditz who attracted the notice of Libussa, daughter of a certain Krok, who ruled over a large part of Bohemia, and is said to have been descended from Samo. Přemysl married Libussa, the traditional foundress of Prague, and during the 8th century became prince of the Bohemian Čechs. His family became extinct when Wenceslaus III. died, but through females the title to Bohemia passed from the Přemyslides to the house of Luxemburg and later to the house of Habsburg.

See F. Palacky, *Geschichte von Böhmen*, Bd. I. (Prague, 1844).

PRENZLAW, or PRENZLOW, a town of Germany, in the Prussian province of Brandenburg. It lies on the lower Ucker See, 30 m. W. by S. of Stettin by rail. Pop. (1905), 20,920. The Gothic church of St Mary (Evangelical), dating from 1340, is one of the finest churches in the district, and the remains of the town gates, walls and towers are also interesting. The industries include wool-spinning, iron-founding, brewing and sugar-refining. Tobacco is grown in the neighbourhood, and cigars are manufactured in the town.

Prenzlau is first mentioned in a document of the close of the 12th century, and received its municipal charter in 1235. As the capital of the old Uckermark it was a frequent object of dispute between Pomerania and Brandenburg until incorporated with the latter about 1480. At Prenzlau Prince Hohenlohe, with his corps of 12,000 men, surrendered to Murat on the retreat after the battle of Jena in October 1806.

See I. Ziegler, *Prenzlau, die ehemalige Hauptstadt der Uckermark* (Prenzlau, 1886).

PRERAU (Czech, *Přerov*), a town of Austria, in Moravia, 56 m. E.N.E. of Brünn by rail. Pop. (1900), 16,738, chiefly

Czech. It is one of the oldest towns in Moravia, and possesses a Gothic town-hall and an old castle, once occupied by Matthias Corvinus. It has an important cloth industry, and manufactures of sugar, ropes, machinery and agricultural implements. Prerau was at one time the chief seat of the Moravian Brethren.

PREROGATIVE, in law, an exclusive privilege of the Crown. The word, originally an adjective, is derived from the *centuria praerogativa*, or century which voted first on a proposed law (*rogatio*) in the Roman *comitia centuriata*. In English law, Blackstone says, "by the word prerogative we are to understand the character and power which the sovereign hath over and above all other persons, in right of his regal dignity; and which, though part of the common law of the country, is out of its ordinary course. This is expressed in its very name, for it signifies, in its etymology, something that is required or demanded *before*, or in preference to, all others" (Stephen's *Comm.* vol. ii. bk. iv. pt. i. ch. vi.). The prerogative is sometimes called *jura regalia* or *regalia*, the *regalia* being either *majora*, the regal dignity and power, or *minora*, the revenue of the Crown.

The theory of English law as to the prerogative of the king seems to be not quite consistent. On the one hand, he is a perfect and irresponsible being, holding his office by divine right; George V., "by the Grace of God of Great Britain and Ireland King,"¹ is still the heading of every writ. On the other hand, his powers are defined and limited by law. This is laid down as early as the 13th century (Bracton, 5b). A consequence of this position is that the prerogative may be confined or extended by the supreme legislative authority, and that the courts have jurisdiction to decide whether or not any alleged right falls within the prerogative. The prerogative of the Crown, still of great extent, has been gradually limited by a long series of enactments, the most worthy of notice being *Magna carta*, *Confirmatio cartarum*, *Prerogativa regis*, the Petition of Right, the Habeas Corpus Act, the Bill of Rights and the Act of Settlement. The most important of the obsolete prerogatives which have been at one time claimed and exercised are the following: (1) the right to impose a tax upon the subject without the consent of parliament. (2) The right to dispense with the obligation of statutes, by the insertion in a grant of the clause *non obstante statuto* (see DISPENSATION). (3) The right of purveyance and pre-emption—that is, of buying up provisions at a valuation without the consent of the owner—and the right of impressing carriages and horses (see PURVEYANCE). (4) The authority to erect tribunals not proceeding according to the ordinary course of justice was declared illegal by 16 Car. I. c. 10 (the act dissolving the Star Chamber, the court of the marches of Wales, and the court of the president and council of the north). (5) The revenue from first-fruits and tenths (see ANNATES). (6) The right of corody—that is, of sending one of the royal chaplains to be maintained by a bishop until the bishop promotes him to a benefice—has become obsolete by disuse. (7) The right by forfeiture to the property of a convict upon his conviction for treason or felony was abolished by the Felony Act 1870. (8) The immunity of the Crown from payment of costs has been taken away in almost all cases. (9) The right to alienate crown lands by grant at pleasure was taken away by 1 Anne c. 8. In very few cases has the prerogative been extended by statute; the Regulation of the Forces Act was an example of such extension. By that act the jurisdiction of lords-lieutenant of counties over the auxiliary forces was vested in the Crown.

The prerogative may be exercised in person or by delegation. The prerogative of conferring honours is generally (though not necessarily) exercised by the king in person, as in the case of investment with knighthood and military or civil decorations. The delegation of the prerogative often takes place by commission, issued with or without a joint address from both houses of parliament. Parts of the prerogative—generally in the nature of profit, and so in derogation of the revenue of the Crown—may be

¹ There is no difference in the prerogative as exercised by a king or a queen regnant, so that the word "king" in its constitutional sense includes queen. That the queen regnant has the same rights as a king was declared by 1 Mary sess. 3, c. 1.

conferred upon subjects by grant in letters patent, which will be presumed after enjoyment by the subject for a certain time. What in the king is a prerogative becomes a franchise in the subject, e.g. chases, warrens, wrecks, treasure-trove, courts-leet.

The existing prerogatives may be divided, with Blackstone, into such as are direct and such as are by way of exception; or perhaps better, with Chief Baron Comyns, into those affecting external relations and those affecting internal relations. Under the first class would fall the power of making war and concluding peace. As incidents to this power the king has the right of sending and receiving ambassadors, of concluding treaties, and of granting passports, safe-conducts, letters of marque and reprisals. These rights may be limited by international agreement; thus the Declaration of Paris, 1856, abolished privateering as far as the assenting nations (of whom Great Britain was one) were concerned.

The prerogatives affecting internal relations may be conveniently, if not scientifically, classified as personal, political, judicial, ecclesiastical and fiscal.

Personal.—In order that there may always be an existing head of the state the king is regarded as a corporation. He cannot die; there can only be a demise of the Crown—that is, a transfer of the royal authority to a different person. On the same principle the king cannot be under age, though in cases where the king has been of tender years a protector or regent has usually been appointed for administrative purposes. The king is personally irresponsible for crime or tort, it being an ancient common law maxim that the king can do no wrong, and that any injury suffered by a subject at the hands of the king is to be attributed to the mistake of his advisers. A curious consequence of this irresponsibility is that the king is apparently the only person in the realm who cannot under any circumstances arrest a suspected felon, for no action for false imprisonment would lie against him, and in the event of the arrest of an innocent person there would be a wrong without a remedy. He cannot be guilty of laches, or negligence. The maxim of the common law is "Nullum tempus occurrit regi." This is still the law in criminal matters. With a very few exceptions, such as prosecutions for treason and offences against the customs, no lapse of time will in England (though it is otherwise in Scotland) bar the right of the Crown to prosecute. The king is exempt from taxation on the ground that, as the revenue of the realm is his prerogative, it is useless for him to tax himself. But lands purchased by the privy purse are liable to taxation (39 & 40 Geo. III. c. 88, s. 6). He is also exempt from tolls (which can only exist as a franchise granted by him), and from the poor-rate, as he is not mentioned in the Poor Law Acts. His person cannot be arrested or his goods distrained or taken in execution. The privilege of exemption from taxation applies to his palaces and to the public buildings of the state. No kind of judicial process can be executed in a palace as long as it continues to be a royal residence. The privilege does not attach to palaces which the king has ceased to use as a dwelling, such as Hampton Court. The king has also several personal privileges of minor importance, such as the title of "majesty," the right to a royal salute, to the use of the royal standard and of special liveries, &c.

Political.—The king is the supreme executive and co-ordinate legislative authority. As such authority he has the attribute of sovereignty² or pre-eminence, and the right to the allegiance of his subjects. All land is mediately or immediately held of him. Land derelict suddenly by the sea, land newly discovered by subjects and islands arising in the sea are his. As paramount authority in parliament he can dissolve or prorogue it at pleasure, but cannot prolong it beyond seven years. In theory parliament only exists at his will, for it is summoned by his writ, and the vote for a member of parliament is only a franchise, not a right existing independently of his grant. He can refuse his assent to a bill passed by the houses of parliament. This right has, however, not been exercised since 1707, when Queen Anne refused the royal assent to a Scottish Militia Bill. The king has power to issue proclamations and (with the assent of the privy council) orders in council, in some cases as part of the ancient prerogative, in others under the provisions of an act of parliament. Proclamations are only binding so far as they are founded upon and enforce the laws of the realm. They cannot alter the common law or create a new offence. The king is the fountain of honour; as such he has the valuable power of granting peerages at will, so far as he is not restrained by any act of parliament, and so far as he keeps within certain constitutional limits, e.g. he cannot insert a shifting clause in a patent of peerage. He also confers all other titles of honour, whether hereditary or not, and grants precedence and armorial bearings. The great officers of state are appointed by the king. The only restriction upon the creation of offices is that he cannot create new offices with new fees attached to them, or annex new fees to old offices, for this would be to impose a tax upon the subject without an act

² The word "sovereign" is frequently applied to the king in legal works. It should be borne in mind at the same time that the king is not a sovereign in the strict sense in which the term is used by Austin.

of parliament. The king, as head of the state, is in supreme command of the army and navy for the defence of the realm. This right, contested by the Long Parliament, was finally declared by 13 Car. II. c. 6 to be in the king alone. The right of command carries with it as an incident the right to build forts and defences, to impress seamen in case of necessity, and to prohibit the importation of munitions of war (39 & 40 Vict. c. 36, s. 43), also the right to the soil of the foreshore and of estuaries of rivers, and the jurisdiction over territorial waters. Other rights which fall under the political branch of the prerogative may be called the commercial rights, including the coining of money, the regulating of weights and measures, the establishing of markets and fairs, and the erecting of beacons, lighthouses and sea-marks. As *parens patriae* he is *ex officio* guardian of infants, idiots and lunatics. It is scarcely necessary to point out that all these prerogatives (except the conferring of honours and such prerogatives as are purely personal) are exercised through responsible ministers, practically in these days members of the party to which the majority of the House of Commons belongs. Thus the jurisdiction over infants, &c., is exercised in England by the lord chancellor, and over beacons, &c., by the Trinity House, under the general superintendence of the Board of Trade.

Judicial.—The king is the fountain of justice, and the supreme conservator of the peace of the realm. As supreme judge the king has the appointment of all judicial officers (other than those in certain local courts), who act as his deputies. He may constitute legal courts for the administration of the general law of the land, but he cannot erect tribunals not proceeding according to the known and established law of the realm, such as the Star Chamber or the commissions of martial law forbidden by the Petition of Right. Nor can he add to the jurisdiction of courts; thus he cannot give a spiritual court temporal powers. The king was in theory supposed to be present in court. Actions in the king's bench were until modern times said to be *coram rege ipso*, and the king could not be non-suited, for a non-suit implied the non-appearance of the plaintiff in court. The king enforces judgment by means of the sheriff, who represents the executive authority. As supreme conservator of the peace, the king, through the lord- lieutenant in counties, and through the lord chancellor in cities and boroughs, appoints justices of the peace. In the same capacity he is the prosecutor of crimes. All indictments still conclude with the words "against the peace of our lord the king, his crown and dignity." As it is the king's peace that is broken by the commission of a crime, the king has, as the offended party, the power of remission. The king cannot be sued by ordinary action. He may sue by ordinary action, but he has the advantage of being able to use prerogative process (see below). He has the right of intervention in all litigation where his rights are concerned, or in the interests of public justice, as where collusion is alleged between the decree nisi and the decree absolute in divorce. Crown debts have priority in administration and bankruptcy.

Ecclesiastical.—The king is recognized as "supreme governor" of the Church by 26 Hen. VIII. c. 1, and 1 Eliz. c. 1. By this prerogative he convenes and dissolves convocation and nominates to vacant bishoprics and other ecclesiastical preferments. The dean and chapter of a cathedral cannot proceed to the election of a bishop without the king's permission to elect (see *CONGÉ D'ÉLIRE*). When any benefice is vacant by the promotion of the incumbent to a bishopric other than a colonial bishopric the king has the patronage *pro hac vice*. The king cannot create new ecclesiastical jurisdiction in England or in colonies other than crown colonies. Where a new bishopric is created it is under the powers of an act of parliament.

Fiscal.—The theory of the constitution is that the king, being entrusted with the defence of the realm and the administration of justice, must have sufficient means given him for the purpose. The bulk of the revenue of the Norman and Plantagenet kings was derived from crown lands and feudal dues. At the present day the rents of crown lands form a very small part of the revenue, and the feudal dues do not exist except in the peculiarly unimportant cases of escheat, royal fish, wrecks, treasure trove, waifs and strays, &c. Of the revenue a comparatively small part (the civil list) is paid to the king in person, the rest (the consolidated fund) is applied to public purposes.

Prerogative Process.—This is the name given to certain methods of procedure which the Crown alone has the right of using; such are inquest of office (an inquiry by jury concerning the right of the Crown to land or goods), extent (a mode of execution), *scire facias* (for the resumption of a grant), and information (by which proceedings are commenced in the name of the attorney-general for a public wrong or for injury to crown property).

Prerogative Writs.—Certain writs are called "prerogative writs," as distinguished from writs of right, because it is within the prerogative to issue or reissue them (see *WRIT*).

Besides the authorities cited, see Allen, *Inquiry into the Rise and Growth of the Royal Prerogative in England*; Chitty, *The Prerogative of the Crown*; Staunforde, *Exposition of the King's Prerogative*; Comyns, *Digest*, art. "Prerogative"; Broom, *Constitutional Law*; and the works of W. Bagehot, S. Low, A. V. Dicey and Sir W. Anson, on the Constitution.

PREROGATIVE COURTS. the name given to the English provincial courts of Canterbury and York, as far as regarded their jurisdiction over the estates of deceased persons.

They had jurisdiction to grant probate or administration where the diocesan courts could not entertain the case owing to the deceased having died possessed of goods above the value of £5 (*bona notabilia*) in each of two or more dioceses. The jurisdiction of the prerogative courts was transferred to the Court of Probate in 1857 by the Probate Court Act, and is now vested in the Probate, Divorce and Admiralty Division of the High Court of Justice by the Judicature Act 1875. In the state of New Jersey, United States, the court having jurisdiction over probate matters is called the Prerogative Court.

PRESBYTER (Gr. *πρεσβύτερος*, elder, the comparative of *πρέσβυς*, an old man), the title borne from very early times by certain officers or ministers of the Christian Church intermediate between "bishops" and "deacons." The specialized use of the word as implying not only age, but consequently wisdom and authority, is analogous to that of "senate" (from senior), of "gerousia" (from *γέρων*), and of "elder." It is the original form of priest (*q.v.*). The word is not found in pre-Christian writings except in the Septuagint, though as Deissmann has shown it is found on the Papyri as an official title for the village magistrates of Egypt and the members of the *γερονσία*, or senate, of many towns in Asia Minor. The office is, however, closely analogous to, and perhaps founded on, a similar office in the Jewish synagogue organization among the officials of which were the *zekenim*, or elders, sometimes identified with the archi-synagogues. In the New Testament the Greek word is used both for the ancient Jewish official and for the Christian elder. On Jewish tombstones of the Hellenistic period the title is frequently found, sometimes applied to women. The head official of the English Jews prior to their expulsion bore the title of *Presbyter judaeorum*; opinions differ as to whether this officer was ecclesiastical or had merely the secular duty of supervising the exchequer of the Jews (see further *The Jewish Encyclopedia*, 1905, x. 190, 191).

The history of presbyteral government as opposed to episcopacy and pure congregationalism is not known in detail. After the Reformation, however, it was adopted by Calvin and his followers, who created that system which has ever since been known as Presbyterianism (*q.v.*). There are many theories as to the origin of the office of presbyter in the Christian Church. (1) Some connect it with the appointment of the seven recorded in Acts vi. This is the view taken by Boehmer,¹ Ritschl² and Lindsay.³ It is urged that the traditional view which regards the seven as deacons is untenable because the term "deacon" is never used in the narrative, and there is no reference to the office in the Acts. On the other hand the officials of the Jerusalem church are always called "elders" and when they are first introduced (Acts xi. 30) appear to be discharging the functions for which "the seven" were specially set apart. (2) The view adopted by the majority of English scholars is, while refusing to accept the connexion between the presbyters and the seven, to regard the office as distinctly primitive and say that it was taken over by the earliest Christian community at Jerusalem from the Jewish synagogue.⁴ (3) Harnack and a few other modern scholars⁵ maintain that the office of presbyter did not come into existence till the 2nd century. During the last quarter of the 1st century, a three-fold organization is found in the Church: (a) a spiritual organization composed of "apostles, prophets and teachers who had been awakened by the spirit and by the spirit endowed"; (b) an administrative organization, "For the care of the poor, for worship, for correspondence, the congregation needed controlling officials. These were the bishop and the deacons, the former for higher, the latter for inferior services"; (c) a patriarchal organization based upon the natural deference of the younger to the older members of the Church. The senior members of the community, by virtue of their age and experience, watched over the conduct and guided the action of the younger and less experienced portion of the Church, though they held no official position and were not appointed for any particular work like the bishops and deacons. In the 2nd century the patriarchal element in the organization was merged in the administrative, and the presbyters

¹ *Diss. jur. eccl.* p. 373.

² *Entstehung der altkatholischen Kirche*, 2nd ed. p. 355.

³ *The Church and the Ministry*, p. 116; cf. also Brown, *Apostolical Succession*, p. 144.

⁴ Lightfoot, *Ep. to the Philippians*, p. 192.

⁵ E.g. Sohm, *Kirchenrecht*, 92; Weizsäcker, *Apostolic Age* (Eng. trans. ii. 330); Allen, *Christian Institutions*, p. 38; A. C. McGiffert, *Apostolic Age*, p. 663 (1897).

became a definite order in the ministry. The time at which the change occurred cannot be definitely fixed. "In some congregations," as Harnack says, "it may have been long before the elders were chosen, in others this may have come very soon; in some the sphere of the competency of the presbyters and patrons may have been quite indefinite and in others more precise." Harnack's theory is based upon the following arguments: (a) The silence of the genuine Epistles of St Paul and the Epistle to the Hebrews. In 1 Cor. xii. 28 Paul says that God has given to the Church apostles, prophets, teachers, miracles, gifts of healing, helps, governments; but of presbyters he has not a word to say. Even from passages where he is speaking of the jurisdiction of the congregation, as for example in 1 Cor. v., vi., the presbyters are absent, while in Phil. i. 1 it is the bishops and deacons that he mentions. (b) The documents in which presbyters are mentioned in an official sense, viz. the Epistle of James, the first Epistle of Peter, the Acts of the Apostles and the Pastoral Epistles belong to a later age and reflect the customs of their own day rather than those of the primitive Church. (c) Even Clement of Rome does not say that the apostles had appointed presbyters in the congregation, he speaks only of bishops and deacons. For this reason the statement in Acts xiv. 23 is to be looked upon with suspicion. These arguments, however, are not absolutely decisive. It is true that presbyters are not mentioned in the genuine Epistles of St Paul, but there are hints that similar officers existed in some of the churches founded by the apostle. There is a reference in 1 Thess. v. 12 to "those who rule over you" (προϊστάμενοι), and the same word occurs in Rom. xii. 8.¹ The term "governments" (κυβερνήσεις) in 1 Cor. xiv. 28 obviously refers to men who discharged the same functions as presbyters. If too, as seems most probable, bishops and presbyters were practically identical, there is of course a specific reference to them in Phil. i. 1. The "leaders" who are mentioned three times in Hebrews xiii. were also probably "presbyters" under another name. Harnack's second argument depends for its validity upon certain conclusions with regard to the date of James and 1 Peter, which are not universally accepted. Few English scholars, for instance, would accept as late a date as 120-140 for James, and 1 Peter may be as early as 65, as Harnack himself admits, though he prefers a date in the reign of Domitian. If this possibility in regard to 1 Peter is granted, it is fatal to the theory, because at the time when the epistle was written official presbyters were so well established that abuse and degeneration had already begun to creep in and some of the elders were already guilty of "lording it over their heritage" and making a profit out of their office (1 Pet. v. 1-4). With regard to the testimony of Acts, the only question, since Harnack admits the Lucan authorship,² is whether Luke is describing the organization of the Church as it existed at the time of the events recorded or reflecting the arrangements which prevailed at the time when the book was written. It is difficult to see how Luke can have been wrong with regard to the "Ephesian elders" who came to meet Paul at Miletus since he was present on the occasion (xx. 15-17). The only mistake that seems possible is that he may have conferred a later title upon the emissaries of the Church of Ephesus. This is not likely, but, at all events, it would only prove that the office under another name existed at Ephesus, for otherwise Luke could not possibly have put into the mouth of Paul the address which follows. Neither is there prima facie ground for objecting to the statements with regard to the presbyters of Jerusalem. If the Church at Jerusalem had any officials, it is highly probable that those officials bore the name and took over the functions of the elders of the synagogue. The statement in Acts xiv. 23, that Paul and Barnabas appointed elders in the churches of South Galatia, is more open to objection perhaps, owing to the silence of the Epistle to the Galatians. With regard to the evidence of the Epistle of Clement, Harnack seems to be incorrect in his conclusions. Scholars of such opposite schools of thought as Schmiedel³ and Lindsay⁴ maintain that the epistle contains the most explicit references to presbyters of the official type. The crucial passage (xliv. 4-6) seems to bear out their contention. "It will be no light sin for us if we thrust out of the oversight (ἐπισκοπή) those who have offered the gifts unblameably and holily. Blessed are those presbyters who have gone before . . . for they have no fear lest any one should remove them from their appointed place" (ἀπὸ τοῦ ἰδρυμένου τόπου). There is an equally specific reference in liv. 2: "Only let the flock of Christ keep peace with its duly-appointed presbyters" (μετὰ τῶν καθισταμένων πρεσβυτέρων).

The conclusions which we seem to reach are as follows: (1) In the earliest stage (between 30 and 60) there is no uniform organization

¹ Hort translates προϊστάμενοι "those who care for you," but 1 Tim. iii. 12 and v. 17 seem to be against this. In Justin Martyr, *Apol.* i. 67, προεστώς evidently refers to "the president of the church," and in a recently discovered papyrus which Ramsay dates 303 a certain bishop is described as λαοῦ προϊστάμενος, *Studies in Roman Provinces*, pp. 125-126.

² *Lukas der Arzt* (1906), cap. 1.

³ *Ency. Bib.* p. 3134 sqq.

⁴ *The Church and the Ministry*, p. 160. Cf. also Loening, *Die Gemeindeverfassung des Urchristentums*, p. 58.

in the Christian Church. Presbyters are found in Jerusalem from primitive times. In the Pauline churches the name is not found except at Ephesus and possibly in south Galatia, though there are traces of the office, at any rate in germ, under different titles in other churches. (2) In the second stage (between 60 and 100) there is an increasing tendency towards uniformity. The office is found definitely mentioned in connexion with the churches of Asia Minor (1 Pet. i. 1), Corinth (Epistle of Clement) and Crete (Titus). The officials were called by two names, "elders" and "bishops," the former denoting the office, the latter the function (exercising the oversight). The substantial identity of the two titles cannot be doubted in the light of such passages as Acts xx. 17, 28.; 1 Pet. v. 1, 2; 1 Tim. iii. 1-7, v. 17-19 and Titus i. 5-7.

There is far less controversy with regard to the later history of the presbyters. The third stage of the development of the office is marked by the rise of the single *episcopos* as the head of the individual church (see BISHOP; EPISCOPACY). The first trace of this is to be found in the Epistles of Ignatius which prove that by the year 115 "the three orders" as they were afterwards called—bishop, presbyters and deacons—already existed, not indeed universally, but in a large proportion of the churches. The presbyters occupied an intermediate position between the bishop and the deacons. They constituted "the council of the bishop." It was some time before the threefold ministry became universal. The *Didache* knows nothing of the presbyters; bishops and deacons are mentioned, but there is no reference to the second order. The *Shepherd of Hermas* knows nothing of the single bishop; the churches are under the control of a body of presbyter-bishops. Before the close of the 2nd century however the three orders were established almost everywhere. The sources of the Apostolic Canons (which date between 140-180) lay down the rule that even the smallest community of Christians, though it contain only twelve members, must have its bishop and its presbyters. The original equality of bishops and presbyters was still however theoretically maintained. The Canons of Hippolytus which belong to the end of the 2nd century distinctly lay it down that "at the ordination of a presbyter everything is to be done as in the case of a bishop, save that he does not seat himself upon the throne. The same prayer shall also be said as for a bishop, the name of the bishop only being left out. The presbyter shall in all things be equal with the bishop, save in the matter of presiding and ordaining, for the power to ordain is not given him." The presbyters formed the governing body of the church. It was their duty to maintain order, exercise discipline, and superintend the affairs of the Church. At the beginning of the 3rd century, if we are to believe Tertullian, they had no spiritual authority of their own, at any rate as far as the sacraments are concerned. The right to baptize and celebrate the communion was delegated to them by the bishop.⁵

In the fourth stage we find the presbyters, like the bishops, becoming endowed with special sacerdotal powers and functions. Up to the end of the 2nd century the universal priesthood of all believers was the accepted doctrine of the Church. It was not till the middle of the 3rd century that the priesthood was restricted to the clergy. Cyprian is largely responsible for the change, though traces of it are found during the previous half century. Cyprian bestows the highest sacerdotal terms upon the bishops of course, but his references to the priestly character of the office of presbyter are also most definite.⁶ Henceforth presbyters are recognized as the *secundum sacerdotium* in the Church.

With the rise of the diocesan bishops the position of the presbyters became more important. The charge of the individual church was entrusted to them and gradually they took the place of the local bishops of earlier days, so that in the 5th and 6th centuries an organization was reached which approximated in general outline to the system which prevails in the Anglican Church to-day.

See Hatch, *Organization of the Early Christian Churches* (2nd ed., 1882), and Harnack's "excursus" in the German edition of this

⁵ Tertull. *De bapt.* 17: "Baptismi dandi habet jus summus sacerdos qui est episcopus; dehinc presbyteri . . . non tamen sine episcopi auctoritate."

⁶ Cf. Ep. 58: "Presbyteri cum episcopo sacerdotali honore conjuncti."

work (1883); Harnack, *Die Lehre der zwölf Apostel* (1884); Loening, *Die Gemeindeverfassung des Urchristentums* (1889); Sohn, *Kirchenrecht* (1892); an article by Looft, in *Studien und Kritiken*, for 1890 (pp. 619-658); Lindsay, *The Church and the Ministry in the Early Centuries* (1902); Schmiedel, article "Ministry," in *Enc. Bib.*

(H. T. A.)

PRESBYTERIANISM, a highly organized form of church government in which presbyters or elders occupy a prominent place. As one of the three principal systems of ecclesiastical polity known to the Christian Church, Presbyterianism occupies an intermediate position between episcopacy and congregationalism. A brief comparison with these will indicate its salient features. In episcopacy the supreme authority is a diocesan bishop; in congregationalism it is the members of the congregation assembled in church meeting; in Presbyterianism it is a church council composed of representative presbyters. In episcopacy the control of church affairs is almost entirely withdrawn from the people; in congregationalism it is almost entirely exercised by the people; in Presbyterianism it rests with a council composed of duly appointed office-bearers chosen by the people. The ecclesiastical unit in episcopacy is a diocese, comprising many churches and ruled by a prelate; in congregationalism it is a single church, self-governed and entirely independent of all others; in Presbyterianism it is a presbytery or council composed of ministers and elders representing all the churches within a specified district. It may be said broadly, therefore, that in episcopacy the government is monarchical; in congregationalism, democratic; and in Presbyterianism, aristocratic or representative.

I.—THE SYSTEM DESCRIBED

As compared with the Church of England (Episcopal) in which there are three orders of clergy—bishops, priests and deacons, the Presbyterian Church recognizes but one spiritual **One Order.** order, viz. presbyters. These are ecclesiastically of equal rank, though differentiated, according to their duties, as ministers who preach and administer the sacraments, and as elders who are associated with the ministers in the oversight of the people. There are deacons in Presbyterianism inferior in rank to presbyters, their duties being regarded as non-spiritual.

The membership of a Presbyterian Church consists of all who are enrolled as communicants, together with their children. **Members-** Others who worship regularly without becoming **ship.** communicants are called adherents. Only communicants exercise the rights of membership. They elect the minister and other office-bearers. But, in contrast with Congregationalism, when they elect and "call" a minister their action has to be sustained by the presbytery, which judges of his fitness for that particular sphere, of the measure of the congregation's unanimity, and of the adequacy of financial support. When satisfied, the presbytery proceeds with the ordination and induction. The ordination and induction of ministers is always the act of a presbytery. The ordination and induction of elders in some branches of the Church is the act of the kirk-session; in others it is the act of the presbytery.

The kirk-session is the first of a series of councils or church courts which are an essential feature of Presbyterianism. It consists of the ministers and ruling elders. The minister is **Kirk-** *ex officio* president or moderator. Without his **Session.** presence or the presence of his duly-appointed deputy the meeting would not be in order nor its proceedings valid. The moderator has not a deliberative, but only a casting vote. (This is true of the moderator in all the church courts.) Neither the session nor the congregation has jurisdiction over the minister. He holds his office *ad vitam aut culpam*; he cannot demit it or be deprived of it without consent of the presbytery. In this way his independence among the people to whom he ministers is to a large extent secured. The kirk-session has oversight of the congregation in regard to such matters as the hours of public worship, the arrangements for administration of the sacraments, the admission of new members and the exercise of church discipline. New members are either catechumens or members transferred from other churches. The former are received after special instruction and profession of faith; the latter on presenting a certificate of church membership from the church which they have left. Though the admission of new members is, strictly speaking, the act of the session, this duty usually devolves upon the minister, who reports his procedure to

the session for approval and confirmation. Matters about which there is any doubt or difficulty, or division of opinion in the session, may be carried for settlement to the next higher court, the presbytery.

The presbytery consists of all the ministers and a selection of the ruling elders from the congregations within a prescribed area. The presbytery chooses its moderator periodically from among its ministerial members. His duty is to see **The** **Presbytery.** that business is transacted according to Presbyterian principle and procedure. The moderator has no special power or supremacy over his brethren, but is honoured and obeyed as *primus inter pares*. The work of the presbytery is episcopal. It has oversight of all the congregations within its bounds; hears references from kirk-sessions or appeals from individual members; sanctions the formation of new congregations; superintends the education of students for the ministry; stimulates and guides pastoral and evangelistic work; and exercises discipline over all within its bounds, including the ministers. Three members, two of whom must be ministers, form a quorum; a small number compared with the important business they may have to transact, but the right of appeal to a higher court is perhaps sufficient safeguard against abuse. Presbytery meetings are either ordinary or occasional. The former are held at prearranged intervals. Occasional meetings are either *in hunc effectum* or *pro re nata*. The presbytery fixes the former for specific business; the latter is summoned by the moderator, either on his own initiative or on the requisition of two or more members of presbytery, for the transaction of business which has suddenly emerged. The first question considered at a *pro re nata* meeting is the action of the moderator in calling the meeting. If this is approved the meeting proceeds; if not, the meeting is dissolved. Appeals and complaints may be taken from the presbytery to the synod.

The synod is a provincial council which consists of the ministers and representative elders from all the congregations within a specified number of presbyteries, in the same way as **The Synod.** the presbytery is representative of a specified number of congregations. Though higher in rank and larger than most presbyteries it is practically of less importance, not being, like the presbytery, a court of first instance, nor yet, like the general assembly, a court of final appeal. The synod at its first meeting chooses a minister as its moderator whose duties, though somewhat more restricted, are similar to those of presbyterial moderators. The synod hears appeals and references from presbyteries; and by its discussions and decisions business of various kinds, if not settled, is ripened for consideration and final settlement by the general assembly, the supreme court of the Church.

The general assembly is representative of the whole Church, either, as in the Irish General Assembly, by a minister and elder sent direct to it from every congregation, or, as in the **The General** **Assembly.** Scottish General Assemblies, by a proportion of delegates, ministers and elders from every presbytery. The general assembly annually at its first meeting chooses one of its ministerial members as moderator. He takes precedence, *primus inter pares*, of all the members, and is recognized as the official head of the Church during his term of office. His position is one of great honour and influence, but he remains a simple presbyter, without any special rule or jurisdiction. The general assembly reviews all the work of the Church; settles controversies; makes administrative laws; directs and stimulates missionary and other spiritual work; appoints professors of theology; admits to the ministry applicants from other churches; hears and decides complaints, references and appeals which have come up through the inferior courts; and takes cognizance of all matters connected with the Church's interests or with the general welfare of the people. As a judicatory it is the final court of appeal; and by it alone can the graver censures of church discipline be reviewed and removed. The general assembly meets once a year at the time and place agreed upon and appointed by its predecessor.

By means of this series of conciliar courts the unity of the Church is secured and made manifest; the combined, simultaneous effort of the whole is made possible; and disputes, instead of being fought out where they arise, are carried for settlement to a larger and higher judicatory, free from local **Conciliar** **Courts.** feeling and prejudice. As access to the church courts is the right of all, and involves but slight expense, the liberty of even the humblest member of the Church is safeguarded, and local oppression or injustice is rendered difficult.

The weak point in the system is that episcopal superintendence being exercised in every case by a plurality of individuals there is no one, moderator or senior member, whose special duty it is to take initial action when the unpleasant work of judicial investigation or ecclesiastical discipline becomes necessary. This has led in some quarters to a desire that the moderator should be clothed with greater responsibility and have his period of office prolonged; should be made, in fact, more of a bishop in the Anglican sense of the word.

Though the *jus divinum* of presbytery is not now insisted upon as in some former times, Presbyterians claim that it is the church polity set forth in the New Testament. The case is usually stated somewhat as follows. With the sanction and under the

guidance of the Apostles, officers called elders and deacons were appointed in every newly-formed church.¹ They were elected by the people, and ordained or set apart for their sacred work by the Apostles.² The elders were appointed to teach and rule;³ the deacons to minister to the poor.⁴ There were elders in the church at Jerusalem,⁵ and in the church at Ephesus;⁶ Paul and Barnabas appointed elders in the cities of Lycaonia and Pisidia;⁷ Paul left Titus in Crete to appoint elders in every city;⁸ the elders amongst the strangers scattered throughout Pontus, Galatia, Cappadocia, Asia and Bithynia received a special exhortation by Peter.⁹ These elders were rulers, and the only rulers in the New Testament Church. Just as in the synagogue there was a plurality of rulers called elders, so there was in every Christian church a plurality of elders. The elders were different from the deacons, but there is no indication that any one elder was of higher rank than the others. The elder was not an officer inferior and subordinate to the bishop. The elder was a bishop. The two titles are applied to the same persons. See Acts xx. 17, 28; "he sent and called for the elders of the church. . . . Take heed to all the flock over which the Holy Ghost hath made you bishops." See also Titus i. 5, 6: "ordain elders . . . for a bishop must be blameless." This is now admitted by modern expositors.¹⁰ The elders were chosen by the people. This is not expressly stated in the New Testament but is regarded as a necessary inference. When an apostle was about to be chosen as successor to Judas, the people were invited to take part in the election;¹¹ and when deacons were about to be appointed the Apostles asked the people to make the choice.¹² It is inferred that elders were similarly chosen. It is worthy of notice that there is no account at all of the first appointment of elders as there is of deacons. Probably the recognition and appointment of elders was simply the transfer from the synagogue to the Church of a usage which was regarded as essential among Jews; and the Gentile churches naturally followed the example of the Jewish Christians.¹³ The elders thus chosen by the people and inducted to their office by the Apostles acted as a church court. Only thus could a plurality of rulers of equal rank act in an efficient and orderly way. They would discharge their pastoral duties as individuals, but when a solemn ecclesiastical act, like ordination, was performed, it would be done, as in the case of Timothy, by "the laying on of the hands of the presbytery";¹⁴ and when an authoritative decision had to be reached, as in regard to circumcision, a synod or court was called together for the purpose.¹⁵ The action of Paul and Barnabas at Antioch¹⁶ seems to accord with Presbyterian rather than Congregational polity. The latter would have required that the question should have been settled by the church at Antioch instead of being referred to Jerusalem. And the decision of the council at Jerusalem was evidently more than advisory; it was authoritative and meant to be binding on all the churches.¹⁷ The principle of ministerial parity which is fundamental in Presbyterianism is founded not merely on apostolic example but on the words of Christ Himself: "Ye know that the princes of the Gentiles exercise dominion over them, and they that are great exercise authority upon them. But it shall not be so among you."¹⁸

From the foregoing outline it will be seen that Presbyterianism may be said to consist in the government of the Church by representative assemblies composed of the two classes of presbyters, ministers and elders, and so arranged as to manifest and realize the visible unity of the whole Church. Or it may be described as denying (1) that the apostolic office is perpetual and should still exist in the Christian Church; (2) that all church power should be vested in the clergy; (3) that each congregation should be independent of all the rest; and as asserting (1) that the people ought to have a substantial part in the government of the Church; (2) that presbyters, *i.e.* elders or bishops, are the highest permanent officers in the Church and are of equal rank; (3) that an outward and visible Church is one in the sense that a smaller part is controlled by a larger and all the parts by the whole.¹⁹

Though Presbyterians are unanimous in adopting the general system of church polity as here outlined, and in claiming New

¹ Phil. i. 1.

² Acts vi. 2-6.

³ 1 Tim. v. 17; Titus i. 9.

⁴ Acts vi. 1, 2.

⁵ Acts xi. 29, xv. 2, 4, 6, xvi. 4.

⁶ See Bishop Lightfoot's exhaustive essay in his volume on the Epistle to the Philippians.

⁷ Acts i. 15-26.

⁸ Acts vi. 2-6.

⁹ Acts xiv. 23.

¹⁰ 1 Timothy iv. 14.

¹¹ Proceedings of Seventh General Council of the Alliance of Reformed Churches holding the Presbyterian System (Washington, 1899).

⁶ Acts xx. 17.

⁷ Acts xiv. 23.

⁸ Titus i. 5.

⁹ 1 Peter v. 1.

¹⁵ Acts xv. 6-20.

¹⁶ Acts xv. 2.

¹⁷ Acts xvi. 4.

¹⁸ Matt. xx. 25, 26; Luke xxiii. 25, 26.

Testament authority for it, there are certain differences of view in regard to details which may be noticed. There is no doubt that considerable indefiniteness in regard to the precise *status* and rank of the ruling elder is commonly prevalent. When ministers and elders are associated in the membership of a church court their equality is admitted; no such idea as voting by orders is ever entertained. Yet even in a church court inequality, generally speaking, is visible to the extent that an elder is not usually eligible for the moderator's chair. In some other respects also a certain disparity is apparent between a minister and his elders. Practically the minister is regarded as of higher standing. The duty of teaching and of administering the sacraments and of always presiding in church courts being strictly reserved to him invests his office with a dignity and influence greater than that of the elder. It was inevitable, therefore, that this question as to the exact *status* of the ruling elder should claim attention in the discussions of the Pan-Presbyterian Alliance. At its meeting in Belfast in 1884 a report was submitted by a "committee on the eldership" which had been previously appointed. According to this committee there are prevalent three distinct theories in regard to the office and function of ruling elders:—

I. That while the New Testament recognizes but one order of presbyters there are in this order two degrees or classes, known as teaching elders and ruling elders. In teaching, in dispensing the sacraments, in presiding over public worship, and in the private functions by which he ministers to the comfort, the instruction and the improvement of the people committed to his care, a pastor acts within his parish (or congregation) according to his own discretion; and for the discharge of all the duties of the pastoral office he is accountable only to the presbytery from whom he received the charge of the parish (or congregation). But in everything which concerns what is called discipline—the exercise of that jurisdiction over the people with which the office-bearers of the church are conceived to be invested, he is assisted by lay-elders. They are laymen in that they have no right to teach or to dispense the sacraments, and on this account they fill an office in the Presbyterian Church inferior in rank and power to that of the pastors. Their peculiar business is expressed by the term "ruling elders."²⁰

II. A second theory is contended for by Principal Campbell in his treatise on the eldership, and by others also, that there is no warrant in Scripture for the eldership as it exists in the Presbyterian Church; that the ruling elder is not, and is not designed to be, a counterpart of the New Testament elder; in other words, that he is not a presbyter, but only a layman chosen to represent the laity in the church courts and permitted to assist in the government of the church.

III. A third theory, advanced by Professor Witherow and others, is that the modern elder is intended to be, and should be, recognized as a copy of the scriptural presbyter. Those who take this view hold that "in everything except training and the consequences of training the elder is the very same as the minister," and they base their opinion on the fact that the terms "overseer" or "bishop," "presbyter" and "elder," are used interchangeably throughout the New Testament. It is consistent with this view to argue the absolute parity of ministers and elders, conceding to all presbyters "equal right to teach, to rule, to administer the sacraments, to take part in the ordination of ministers, and to preside in church courts."

The practice of the Presbyterian churches of the present day is in accord with the first-named theory. Where attempts are made to reduce the third theory to practice the result is not satisfactory. Nor is the first-named theory less in harmony with Scripture teaching than the third. In the initial stages of the Apostolic Church it was no doubt sufficient to have a plurality of presbyters with absolutely similar duties and powers. At first, indeed, this may have been the only possible course. But apparently it soon became desirable and perhaps necessary to specialize the work of teaching by setting apart for that duty one presbyter who should withdraw from secular occupation and devote his whole time to the work of the ministry. There seems to be evidence of this in the later writings of the New Testament.²¹ It is now held by all Presbyterian churches that one presbyter in every congregation should have specially committed to him the work

²⁰ Hill's *View of the Constitution of the Church of Scotland*, pp. 37, 38.

²¹ 1 Tim. iv. 15, v. 17; Col. iv. 17.

Divergent Views.

Theories of the Ruling Elder.

Present-day Practice.

of teaching, administering the sacraments, visiting the flock pastorally, and taking oversight, with his fellow elders, of all the interests of the church. To share with the minister such general oversight is not regarded by intelligent and influential laymen as an incongruous or unworthy office; but to identify the duties of the eldership, even in theory, with those of the minister is a sure way of deterring from accepting office many whose counsel and influence in the eldership would be invaluable.¹

Another subject upon which there is a difference of opinion in the Presbyterian churches is the question of Church Establishments. The view, originally held by all Presbyterian churches in Great Britain and on the Continent, that union with and support by the civil government are not only lawful but also desirable, is now held only by a minority, and is practically exemplified among English-speaking Presbyterians only in the Church of Scotland (see SCOTLAND, CHURCH OF). The lawfulness of Church Establishments with due qualifications is perhaps generally recognized in theory, but there is a growing tendency to regard connexion with the state as inexpedient, if not actually contrary to sound Presbyterian principle. That this tendency exists cannot be doubted, and there is reason to fear that its influence, by identifying Presbyterianism with dissent in England and Scotland, is unfavourable to the general tone and character of the Presbyterian Church.

Those who favour state connexion and those who oppose it agree in claiming spiritual independence as a fundamental principle of Presbyterianism. That principle is equally opposed to Erastianism and to Papacy, to the civil power dominating the Church, and to the ecclesiastical power dominating the state. All Presbyterians admit the supremacy of the state in things secular, and they claim supremacy for the Church in things spiritual. Those who favour a Church Establishment hold that Church and state should each be supreme in its own sphere, and that on these terms a union between them is not only lawful but is the highest exemplification of Christian statesmanship. So long as these two spheres are at all points clearly distinct, and so long as there is a desire on the part of each to recognize the supremacy of the other, there is little danger of friction or collision. But when spiritual and secular interests come into unfriendly contact and entanglement; when controversy in regard to them becomes inevitable; from which sphere, the spiritual or the civil, is the final decision to come? Before the Reformation the Church would have had the last word; since that event the right and the duty of the civil power have been generally recognized.

The origin of Presbyterianism is a question of historical interest. By some it is said to have begun at the Reformation; by some it is traced back to the days of Israel in Egypt;² by most, however, it is regarded as of later Jewish origin, and as having come into existence in its present form simultaneously with the formation of the Christian Church. The last is Bishop Lightfoot's view. He connects the Christian ministry, not with the worship of the Temple, in which were priests and sacrificial ritual, but with that of the synagogue, which was a local institution providing spiritual edification by the reading and exposition of Scripture.³ The first Christians were regarded, even by themselves, as a Jewish sect. They were spoken of as "the way."⁴ They took with them, into the new communities which they formed, the Jewish polity or rule and oversight by elders. The appointment of these would be regarded as a matter of course, and would not seem to call for any special notice in such a narrative as the Acts of the Apostles.

But Presbyterianism was associated in the 2nd century with a kind of episcopacy. This episcopacy was at first rather congregational than diocesan; but the tendency of its growth was undoubtedly towards the latter. Hence for proof that their

church polity is apostolic Presbyterians are accustomed to appeal to the New Testament and to the time when the apostles were still living; and for proof of the apostolicity of prelacy Episcopalians appeal rather to the early Church fathers and to a time when the last of the Apostles had just passed away.⁵ It is generally admitted that distinct traces of Presbyterian polity are to be found in unexpected quarters (e.g. Ireland, Iona, the Culdees, &c.) from the early centuries of church history and throughout the medieval ages down to the Reformation of the 16th century. Only in a very modified sense, therefore, can it be correctly said to date from the Reformation.

At the Reformation the Bible was for the great mass of both priests and people a new discovery. The study of it shed floods of light upon all church questions. The leaders of the Reformation searched the New Testament not only for doctrinal truth but also to ascertain the polity of the primitive Church. This was specially true of the Reformers in Switzerland, France, Scotland, Holland and in some parts of Germany. Luther gave little attention to New Testament polity, though he believed in and clung passionately to the universal priesthood of all true Christians, and rejected the idea of a sacerdotal caste. He had no dream or vision of the Church's spiritual independence and prerogative. He was content that ecclesiastical supremacy should be with the civil power, and he believed that the work of the Reformation would in that way be best preserved and furthered. In no sense can his "consistorial" system of church government be regarded as Presbyterian.

It was different with the Reformers outside Germany. While Luther studied the Scriptures in search of true doctrine and Christian life and was indifferent to forms of church polity, they studied the New Testament not only in search of primitive church doctrine but also of primitive church polity. One is struck by the unanimity with which, working individually and often in lands far apart, they reached the same conclusions. They did not get their ideas of church polity from one another, but drew it directly from the New Testament. For example, John Row, one of the five commissioners appointed by the Scottish Privy Council to draw up what is now known as the *First Book of Discipline*, distinctly says that "they took not their example from any kirk in the world; no, not from Geneva"; but they drew their plan from the sacred Scriptures.⁶ This was true of them all. They were unanimous in rejecting the episcopacy of the Church of Rome, the sanctity of celibacy, the sacerdotal character of the ministry, the confessional, the propitiatory nature of the mass. They were unanimous in adopting the idea of a church in which all the members were priests under the Lord Jesus, the One High Priest and Ruler; the officers of which were not mediators between men and God, but preachers of One Mediator, Christ Jesus; not lords over God's heritage, but ensamples to the flock and ministers to render service. They were unanimous in regarding ministerial service as mainly pastoral; preaching, administering the sacraments and visiting from house to house; and, further, in perceiving that Christian ministers must be also spiritual rulers, not in virtue of any magical influence transmitted from the Apostles, but in virtue of their election by the Church and of their appointment in the name of the Lord Jesus. When the conclusions thus reached by many independent investigators were at length reduced to a system by Calvin, in his famous *Institutio*, it became the definite ideal of church government for all the Reformed, in contradistinction to the Lutheran churches.

Yet we do not find that the leaders of the Reformed Church succeeded in establishing at once a fully-developed Presbyterian polity. Powerful influences hindered them from realizing their ideal. We notice two. In the first place, the people generally dreaded the recurrence of ecclesiastical tyranny. So dreadful had been the yoke of Rome, which they had shaken off, that they feared to submit to anything similar even under Protestant auspices. When their ministers, moved by an intense desire to keep the Church pure by means of the exercise of scriptural discipline, claimed special spiritual rule over the people, it was not wonderful that the latter should have been reluctant to submit to a new spiritual despotism. So strong was this feeling in some places that it was contended that the discipline of excommunication, if exercised at all, should be exercised only by the secular power. A second powerful influence was of a different kind, viz. municipal jealousy of church power. The municipal authority in those times claimed the right to exercise a censorship over the citizens' private life. Any attempt on the part of the Church to exercise discipline was resented as an intrusion. It has been a common mistake to think of Calvin and contemporary Reformers

¹ Report of Proceedings, Third General Council of the Alliance of Reformed Churches, &c. (1884), pp. 373 seq. and App. p. 131.

² Exodus iii. 16; iv. 29.

³ St Luke iv. 16 seq.

⁴ Acts ix. 2.

⁵ See Lightfoot's *Essay in Commentary on the Epistle to the Philippians*.

⁶ Knox, Winran, Spotswood and Douglas—all of them John—were the other commissioners.

as introducing a discipline of stern repression which made the innocent gaieties of life impossible, and produced a dull uniformity of straitlaced manners and hypocritical morals. The discipline was there before the Reformers. There were civil laws which regulated clothing, food and social festivity. Hence friction, at times, between the Reformers and civic authorities friendly to the Reformation; not as to whether there should be "discipline" (that was never doubted) but as to whether it should be ecclesiastical or municipal. Even, therefore, where people desired the Reformation there were powerful influences opposed to the setting up of church government and to the exercise of church discipline after the manner of the apostolic Church; and one ceases to wonder at the absence of complete Presbyterianism in the countries which were forward to embrace and adopt the Reformation. Indeed the more favourable the secular authorities were to the Reformation the less need was there to discriminate between civil and ecclesiastical power, and to define strictly how the latter should be exercised. We look in vain, therefore, for much more than the germs and principles of Presbyterianism in the churches of the first Reformers. Its evolution and the thorough application of its principles to actual church life came later, not in Saxony or Switzerland, but in France and Scotland; and through Scotland it has passed to all English-speaking lands.

The doctrines of Presbyterianism are those generally known as evangelical and Calvinistic. The supreme standard of belief is the Word of God in the original languages.

Theology. The subordinate standards have been numerous, though marked by striking agreement in the main body of Christian doctrine which they set forth. Much has been done of late years to make these subordinate standards of reformed doctrine more generally known. The following list is fairly complete:—

Switzerland.—*First Helvetic Confession* (1536). *Geneva Confession* (1536). *Geneva Catechism* (1545).

England.—*Forty-two Articles* (1553). *Thirty-eight Articles* (1563). *Thirty-nine Articles* (1571). *Lambeth Articles* (1595). *Irish Articles* (1615). *Westminster Confession* (1644-1647). *Larger and Shorter Catechisms* (1647).

France.—*Confessio gallicana* (1559).

Scotland.—*Scottish Confession* (1560). *Westminster Confession* (1647). *Larger and Shorter Catechisms* (1647).

Netherlands.—*Frisian Confession* (1528). *Confessio belgica* (1561). *Netherlands Confession* (1566).

Hungary.—*Hungarian Confession* (1562).

Bohemia.—*Bohemian Confession* (1609).

The form of worship associated with Presbyterianism has been marked by extreme simplicity. It consists of reading of

Presbyterian Holy Scripture, psalmody, non-liturgical prayer and preaching. There is nothing in the standards of the Presbyterian Church against liturgical worship.

Worship. In some of the early books of order a few forms of prayer were given, but their use was not compulsory. On the whole, the preponderating preference has always been in favour of so-called extemporaneous, or free prayer; and the Westminster *Directory of Public Worship* has to a large extent stereotyped the form and order of the service in most Presbyterian churches. Within certain broad outlines much, perhaps too much, is left to the choice of individual congregations. It used to be customary among Presbyterians to stand during public prayer, and to remain seated during the acts of praise, but this peculiarity is no longer maintained. The psalms rendered into metre were formerly the only vehicle of the Church's public praise, but hymns are now also used in most Presbyterian churches.¹ Organs used to be regarded as contrary to New Testament example, but their use is now all but universal. The public praise used to be led by an individual called the "precentor," who occupied a box in front of, and a little lower than, the pulpit. Choirs of male and female voices now lead the church praise.

Presbyterianism has two sacraments, baptism and the Lord's Supper. Baptism is administered both to infants and adults by **Sacraments** pouring or sprinkling, but the mode is considered immaterial. The Lord's Supper, as generally observed throughout the various Presbyterian churches, is a close

imitation of the New Testament practice; and where it is not marred by undue prolixity commends itself to most Christian people as a solemn and impressive service. The old plan of coming out and taking one's place at the communion table in the body of the church is unhappily seen no more; communicants now receive the sacred elements seated in their pews. The dispensing of this rite is strictly reserved to an ordained minister, who is assisted by elders in handing the bread and the cup to the people. The administration of private communion to the sick and dying is extremely rare in Presbyterian churches, but there is less objection to it than formerly, and in some churches it is even encouraged.

Presbyterian discipline is now entirely confined to exclusion from membership or from office. Though it is the duty of a minister to warn against irreverent or profane participation in the Lord's Supper, he himself has no right to exclude **Discipline.** any one from communion; that can only be done as the act of himself and the elders duly assembled in session. A code of instructions for the guidance of church courts when engaged in cases of discipline is in general use, and bears witness to the extreme care taken not only to have things done decently and in order, but also to prevent hasty, impulsive and illogical procedure in the investigation of charges of heresy or immorality. Cases of discipline are now comparatively rare, and, when they do occur, are not characterized by the bigoted severity which prevailed in former times and was rightly denounced as unchristian.

The extent to which the Presbyterian form of church government prevails throughout the world has been made more manifest in recent years by the formation of a "General Council of the Alliance of Reformed Churches **General** holding the Presbyterian System." At a representative conference in London in 1875 the constitution of the council was agreed upon. The first council met in Edinburgh in 1877. Since then it has met in Philadelphia, Belfast, London, Toronto, Glasgow, Washington and Liverpool. Churches which are organized on Presbyterian principles and hold doctrines in harmony with the reformed confessions are eligible for admission to the alliance. The object is not to form one great Presbyterian organization, but to promote unity and fellowship among the numerous branches of Presbyterianism throughout the world. On the roll of the general council held at Washington in 1899 there were sixty-four churches. The statistics of these and of sixteen others not formally in the alliance were 29,476 congregations, 26,251 ministers, 126,607 elders and 4,852,096 communicants. Of these eighty churches, twelve were in the United Kingdom, twenty on the continent of Europe, sixteen in North America, three in South America, ten in Asia, nine in Africa, six in Australia, two in New Zealand, one in Jamaica and one in Melanesia. The desire for union which led to the formation of the alliance has, since 1875, borne remarkable fruit. In England in 1876 two churches united to form the Presbyterian Church of England; in the Netherlands two churches became one in 1892; in South Africa a union of the different branches of the Presbyterian Church took place in 1897; in Scotland the Free Church and the United Presbyterian became one in 1900 under the designation of the United Free Church; in Australia and Tasmania six churches united in 1901 to form the Presbyterian Church of Australia; and a few months later the two churches in New Zealand which represented respectively the North and South Islands united to form the Presbyterian Church of New Zealand. "In no portion of the empire," it has been said, "does the British flag now fly over a divided Presbyterianism, except in the British Isles themselves."

II.—HISTORY IN DIFFERENT COUNTRIES

From this general outline of Presbyterianism we now turn to consider its evolution and history in some of the countries with which it is or has been specially associated. We omit, however, one of the most important, viz. Scotland, as the history is fully covered under the separate headings of SCOTLAND, CHURCH OF, and allied articles.

Switzerland.

The Swiss, owing to their peculiar geographical position and to certain political circumstances, early manifested independence in ecclesiastical matters, and became accustomed to the

¹ Principal Rous's version is the best known and most widely used. It is an English work. Somewhat reluctantly it was accepted by Scottish Presbyterianism as a substitute for an older version with a greater variety of metre and music. "Old Hundred" and "Old 124th" mean the 100th and 124th Psalms in that old book.

management of their church affairs. The work of Zwingli as a Reformer, important and thorough though it was, did not concern itself mainly with church polity. Ecclesiastical affairs were, as a matter of course, wholly under the management of the cantonal and municipal authorities, and Zwingli was content that it should be so. The work of Farel, previous to his coming to Geneva, was almost entirely evangelistic, and his first work in Geneva was of a similar character. It was the town council which made arrangements for religious disputations, and provided for the housing and maintenance of the preachers. When

Calvin. Calvin, at Farel's invitation, settled in Geneva (1536) the work of reformation became more constructive.

"The need of the hour was organization and familiar instruction, and Calvin set himself to work at once." The first reforms he wished to see introduced concerned the Lord's Supper, church praise, religious instruction of youth and the regulation of marriage. In connexion with the first he desired that the discipline of excommunication should be exercised. His plan was partly Presbyterian and partly consistorial. Owing to certain circumstances in its past history, Geneva was notoriously immoral. "The rule of dissolute bishops, and the example of a turbulent and immoral clergy, had poisoned the morals of the city. Even the nuns of Geneva were notorious for their conduct."¹ Calvin suggested that men of known worth should be appointed in different quarters of the city to report to the ministers those persons in their district who lived in open sin; that the ministers should then warn such persons not to come to the communion; and that, if their warnings were unheeded, discipline should be enforced. It was on this subject of keeping pure the Lord's Table that the controversy arose between the ministers and the town councillors which ended in the banishment of Calvin, Farel and Conrad from Geneva. In 1538 the ministers took upon themselves to refuse to administer the Lord's Supper in Geneva because the city, as represented by its council, declined to submit to church discipline. The storm then broke out, and the ministers were banished (1538).

It may be convenient at this point to consider Calvin's ideal church polity, as set forth in his famous *Christianae religionis institutio*, the first edition of which was published in 1536. Briefly it was as follows:—

A separate ministry is an ordinance of God (*Inst.* iv. 3, i. 3).

Ministers duly called and ordained may alone preach and administer the sacraments (iv. 3, 10).

A legitimate ministry is one appointed with the consent and approbation of the people under the presidency of other pastors by whom the final act of ordination (with laying on of hands) shall be performed (iv. 3, 15).

Governors or persons of advanced years selected from the people and associated with the ministers in admonishing and exercising discipline (iv. 3, 8). This discipline is all-important, and is the special business of the governors.

His system, while preserving the democratic theory by recognizing the congregation as holding the church power, was in practice strictly aristocratic inasmuch as the congregation is never allowed any direct use of power, which is invested in the whole body of elders. His great object was discipline. With regard to the relations between the Church and the civil power, Calvin was opposed to the Zwinglian theory whereby all ecclesiastical power was handed over to the state. Calvin's refusal to administer the sacrament, for which he was banished from Geneva, is important as a matter of ecclesiastical history, because it is the essence of the whole system which he subsequently introduced. It rests on the principles that the Church has the right to exclude those who are unworthy, and that she is in no way subject to the civil power in spiritual matters. During the three years of his banishment Calvin was at Strassburg, where he had been carrying out his ideas. His recall was greatly to his honour. The town had become a prey to anarchy. One party threatened to return to Romanism; another threatened to sacrifice the independence of Geneva and submit to Berne. It was felt to be a political necessity that he should return, and in 1541, somewhat reluctantly, he returned on his own terms. These were the recognition of the Church's spiritual independence, the division of the town into parishes, and the appointment (by the municipal authority) of a consistory or council of elders in each parish for the exercise of discipline.

These terms were embodied in the famous *Ordonnances ecclésiastiques de l'église de Genève* (1541). The four orders mentioned

in the *Institutio* are recognized; pastors, doctors, elders and deacons. The pastors were to preach, administer the sacraments, and in conjunction with the elders to exercise discipline. In their totality they form the *vénérable compagnie*. A newly-made pastor was to be settled in a fixed charge by the magistrate with the consent of the congregation, after having been approved as to knowledge and manner of life by the pastors already in office. By them he was to be ordained, after vowing to be true in office, faithful to the church system, obedient to the laws and to the civil government, and ready to exercise discipline without fear or favour. The doctors were to teach the faithful in sound learning, to guard purity of doctrine, and to be amenable to discipline. The elders (*Anciens, commis, ou deputez par la seigneurie ou consistoire*) were regarded as the essential part of the system. They were the bond of union between Church and state. Their business was to supervise daily life, to warn the disorderly, and to give notice to the consistory of cases requiring discipline. To form the consistory all the elders with the ministers were to meet every Sunday under the presidency of one of the syndics or magistrates. This court could award censures up to exclusion from the sacrament.

Manifestly the arrangement was a compromise. The state retained control of the ecclesiastical organization, and Calvin secured his much-needed system of discipline. Fourteen years of friction and struggle followed, and if there came after them a period of comparative triumph and repose for the great reformer it must still be remembered that he was never able to have his ideal ecclesiastical organization fully realized in the city of his adoption.

The early Presbyterianism of Switzerland was defective in the following respects: (1) It started from a wrong definition of the Church, which, instead of being conceived as an organized community of believers in the Lord Jesus Christ, was made to depend upon the preaching of the gospel and the administration of the sacraments. As these implied a duly appointed minister, the existence of the Church was made to depend upon an organized ministry rather than an organized membership. It calls to mind the Romish formula: "*Ubi episcopus ibi ecclesia.*" (2) It did not maintain the scriptural right of the people to choose their minister and other office-bearers. (3) Its independence of civil control was very imperfect. (4) And it did not by means of church courts provide for the manifestation of the Church's unity and for the concentration of the Church's influence.

"Calvin," says Principal Lindsay, "did three things for Geneva all of which went far beyond its walls. He gave its Church a trained ministry, its homes an educated people who could give a reason for their faith, and the whole city an heroic soul which enabled the little town to stand forth as the citadel and city of refuge for the oppressed Protestants of Europe."²

France.

It is pathetic and yet inspiring to study the development of Presbyterianism in France; pathetic because it was in a time of fierce persecution that the French Protestants organized themselves into churches, and inspiring, because it showed the power which scriptural organization gave them to withstand incessant, unrelenting hostility. It would be difficult to exaggerate the influence of Calvin upon French Protestantism. His *Christianae religionis institutio* became *Calvin's Influence*, a standard round which his countrymen rallied in the work and battle of the Reformation. Though under thirty years of age, he became all over Europe, and in an exceptional degree in France, the leader, organizer and consolidator of the Reformation. The work which the young Frenchman did for his countrymen was immense.³

The year 1555 may be taken as the date when French Protestantism began to be organized. A few churches had been organized earlier, at Meaux in 1546 and at Nîmes in 1547, but their members had been dispersed by persecution. *French Protestantism.* Prior to 1555 the Protestants of France had been for the most part solitary Bible students or little companies meeting together for worship without any organization. But in that year the following incident was the beginning of a great movement. A small company had been accustomed to meet in the lodging of the sieur de la Ferrière in Paris near the Pré-aux-Clercs. At one of the meetings the father of a newly-born child explained that he could not go outside France to seek a pure baptism and that his conscience would not permit his child to be baptized according to the rites of the Romish Church. After prayer the company constituted themselves into a church: chose Jean le Maçon to be their minister, and others of their number to be elders and deacons. It seemed as if all France had been waiting for this event as a signal, for organized churches began to spring up every-

¹ Lindsay, *Hist. of the Reform.* ii. 90.

² *Hist. of the Reform.* ii. 31. ³ *Ibid.* ii. 158.

where immediately afterwards. Within two years Meaux, Poitiers, Angers, les Îles de Saintonge, Agen, Bourges, Issoudun, Aubigny, Blois, Tours, Lyon, Orléans and Rouen were organized. Thirty-six more were completely organized by 1560.¹ According to Beza there were about this time 2150 organized churches. A few years later Cardinal St Croix reckoned that the Huguenots were one half of the population. One hundred and twenty-seven pastors had been sent to France from Geneva before 1567.

In 1558 a further stage in the development of Presbyterian church polity was reached. Some doctrinal differences having

First General Synod. arisen in the church at Poitiers, Antoine de Chandieu, minister at Paris, went to compose them, and, as the result of a conference, a synod was convened to meet in Paris the following year (1559). It was the first general synod of the French Protestant Church, and consisted of representatives from, some say sixty-six, others, twelve churches. It adopted a confession of faith and a book of order or discipline. The confession consisted of forty articles. It was based on a short confession drafted by Calvin in 1557, and may still be regarded, though once or twice revised, as the confession of the French Protestant Church. The book of order, *Discipline ecclésiastique des églises réformées de France*, regulated the organization and procedure of the churches. It contains this fundamental statement of Presbyterian parity, "Aucune église ne pourra prétendre primauté ni domination sur l'autre; ni pareillement, les ministres d'une église les uns sur les autres; ni les anciens ou diacres, les uns sur les autres." The various church courts, familiar to us now as Presbyterian, are explained. The *consistoire* or session consisted of the minister, elders and deacons (the latter without a vote), and was over the congregation. The *colloque* or presbytery was composed of representative ministers and elders (*anciens*) from a group of congregations. Next in order was the provincial synod which consisted of a minister and an elder or deacon from each church in the province. Over all was the general or national synod. Some of the arrangements are worthy of notice. When a church was first formed the office bearers were elected by the people, but there the power of the congregation ceased. Future vacancies in the eldership were filled up by the office-bearers. The eldership was not for life, but there was always a tendency to make it so. When the ministry of a church became vacant the choice of a successor rested with the *colloque* or with the provincial synod. The people, however, might object, and if their objection was considered valid redress was given. Later the synod of Nîmes (1572) decreed that no minister might be imposed upon an unwilling people. Deacons, in addition to having charge of the poor and sick, might catechize, and occasionally offer public prayer or read a written sermon. The president or moderator of each church court was *primus inter pares*. The remarkable feature of French church polity was its aristocratic nature, which it owed to the system of co-optation; and the exclusion of the congregation from direct and frequent interference in spiritual matters prevented many evils which result from too much intermeddling on the part of the laity. Up to 1565 the national synod consisted of a minister with one or two elders or deacons from every church; after that date, to avoid overcrowding, its numbers were restricted to representatives from each provincial synod. On questions of discipline elders and deacons might vote; on doctrinal questions only as many of these as there were ministers.

"It is interesting to see how in a country whose civil rule was becoming gradually more absolutist, this 'Church under the cross' framed for itself a government which reconciled, more thoroughly perhaps than has ever been done since, the two principles of popular rights and supreme control. Its constitution has spread to Holland, Scotland (Ireland, England), and to the great American (and Colonial) churches. Their ecclesiastical polity came much more from Paris than from Geneva."²

To trace the history of Presbyterianism in France for the next thirty years would be to write the history of France itself during that period. We should have to tell of the great and rapid increase of the Church; of its powerful influence among the nobles and the *bourgeoisie*; of its direful persecutions; of its St Bartholomew massacre with 70,000 victims; of its regrettable though perhaps inevitable entanglements in politics and war; and finally of its attaining not only tolerance but also honourable recognition and protection when Henry IV. in 1598 signed the famous edict of Nantes. This secured complete liberty of conscience everywhere within the realm and the free right of public worship in all places in which it existed during the years 1596 and 1597, or where it had been granted by the edict of Poitiers (1577) interpreted by the convention of Nérac (1578) and the treaty of Fleix (1580)—in all some two hundred towns; in two places in every *bailliage* and *sénéchaussée*; in the castles of Protestant *seigneurs hauts justiciers* (some three thousand); and in the houses of lesser nobles, provided the audience did not consist of more than thirty persons over and above relations of the family. Protestants were granted full civil rights and protection, and were permitted to hold their ecclesiastical assemblies—consistories, colloquies and synods,

national and provincial. Under the protection of the edict the Huguenot Church of France flourished. Theological colleges were established at Sedan, Montauban and Saumur, and French theology became a counterpoise to the narrow Reformed scholastic of Switzerland and Holland.³

The history of the Church from the passing of the edict of Nantes till its revocation in 1685 cannot be given here. That event was the climax of a long series of horrors. Under the persecution, a large number were killed, and between four and five millions of Protestants left the country. Early in the 18th century Antoine Court made marvellous efforts to restore Presbyterianism. In momentary peril of death for fifteen years, he restored in the Vivarais and the Cévennes Presbyterian church polity in all its integrity. In 1715 he assembled his first *colloque*. Synods were held in 1718, 1723, 1726 and 1727; and in a remote spot in Bas Languedoc in 1744 a national synod assembled—the first since 1660—which consisted of representatives from every province formerly Protestant.

From 1760 owing to the gradual spread of the sceptical spirit and the teaching of Voltaire more tolerant views prevailed. In 1787 the Edict of Tolerance was published. In 1789 all citizens were made equal before the law, and the position of Presbyterianism improved till 1791. In 1801 and 1802 Napoleon took into his own hands the independence of both Catholic and Protestant Churches, the national synod was abolished, and all active religious propaganda was rigorously forbidden. In 1848 an assembly representative of the *églises consistoriales* met at Paris. When it refused to discuss points of doctrine a secession took place under the name of the *Union des églises évangéliques de France*. This society held a synod at which a confession of faith and a book of order were drawn up. Meanwhile the national Protestant Church set itself to the work of reconstruction on the basis of universal suffrage, with restrictions, but no result was arrived at. In 1852 a change took place in its constitution. The *églises consistoriales* were abolished, and in each parish a presbyterial council was appointed, the minister being president, with four to seven elders chosen by the people. In the large towns there were consistories composed of all the ministers and of delegates from the various parishes. Over all was the central provincial council consisting of the two senior ministers and fifteen members nominated by the state in the first instance. In 1858 there were 617 pastors and the *Union des églises évangéliques* numbered 27 churches.

The Netherlands.

From the geographical position of the Netherlands, Presbyterianism there took its tone from France. In 1562 the *Confessio belgica* was publicly acknowledged, and in 1563 the church order was arranged. In 1574 the first provincial synod of Holland and Zealand was held, but William of Orange would not allow any action to be taken independently of the state. The Reformed churches had established themselves in independence of the state when that state was Catholic; when the government became Protestant the Church had protection and at the same time became dependent. It was a state church. By the union of Utrecht the communes and provinces had each the regulation of its own religion; hence constant conflict. In most cases it was insisted on as necessary that church discipline should remain with the civil authority. In 1576 William, with the support of Holland, Zealand and their allies, put forth forty articles, by which doctors, elders and deacons were recognized, and church discipline given to the elders, subject to appeal to the magistrate and by which the Church was placed in absolute dependence on the state. These articles, however, never came into operation; and the decisions of the synod of Dort in 1578, which made the Church independent were equally fruitless. In 1581 the Middelburg Synod divided the Church, created provincial synods and presbyteries, but could not shake off the civil power in connexion with the choice of church officers. Thus, although the congregations were Presbyterian, the civil government retained overwhelming influence. The Leiden magistrates said in 1581: "If we accept everything determined upon in the synod, we shall end by being vassals of the synod. We will not open to churchmen a door for a new mastership over government and subjects, wife and child." From 1618 a modified Presbyterian polity predominated. As a rule elders held office for only two years. The "kerk-raad" (kirk-session) met weekly, the magistrate being a member *ex officio*. The *colloque* consisted of one minister and one elder from each congregation. At the annual provincial synod, held by consent of the states, two ministers and one

¹ Lindsay, *Hist. of the Reform.* ii. 166. ² *Ibid.* ii. 169.

³ *Ibid.* ii. 222, 223.

elder attended from each *colloque*. Every congregation was visited by ministers appointed by the provincial synod. In 1795, of course, everything was upset, and it was not until after the restoration of the Netherland States that a new organization was formed in 1816. Its main features were strictly Presbyterian, but the minister was greatly superior to the elder, and the state had wide powers especially in the nomination of higher officers. In 1851 the system now in force was adopted. The congregation chooses all the officers, and these form a church council.

England.

Presbyterian principles and ideas were entertained by many of the leading ecclesiastics in England during the reign of Edward VI. Even the archbishop of Canterbury favoured a modification of episcopacy, and an approach to Presbyterian polity and discipline; but attention was mainly directed to the settlement of doctrine and worship. Cranmer wrote that bishops and priests were not different but the same in the beginning of Christ's religion. Thirteen bishops subscribed this proposition: that in the New Testament there is no mention made of any distinctions or degrees in orders but only deacons and priests or bishops. Cranmer held that the consecration of a bishop was an unnecessary rite, and not required by Scripture; that election and appointment to office were sufficient. The bishop of St Davids was of the same opinion. Latimer and Hooper maintained that Bishops and presbyters were identical; and Pilkington, bishop of Durham, and Bishop Jewel were of the same mind. The latter, about the time of Elizabeth's succession, expressed his hope that the bishops would become pastors, labourers and watchmen; and that the great riches of bishoprics would be diminished and reduced to mediocrity; that, being delivered from courtly and regal pomp, the bishops might take care of the flock of Christ. During the reign of Edward, the title of superintendent was often adopted instead of bishop, and it will be recollected that John Knox was an honoured worker in England with the title of superintendent during this reign. As an indication of sympathy with Presbyterianism, it may be noted that Cranmer favoured a proposal for the formation of a council of presbyters in each diocese, and for provincial synods.

During 1567 and 1568 the persecutions in France and Holland drove thousands of Protestants, mostly Presbyterians, to England. In 1570 Presbyterian views found a distinguished exponent in Dr Thomas Cartwright at Cambridge; and the temper of parliament was shown by the act of 1571, for the reform of disorders in the Church, in which, while all mention of doctrine is omitted, the doctrinal articles alone being sanctioned, ordination without a bishop is implicitly recognized. In 1572 a formal manifesto was published, entitled an *Admonition to Parliament*, the leading ideas in which were: parity of ministers, appointment of elders and deacons; election of ministers by the congregation; objection to prescribed prayer and antiphonal chanting; preaching, the chief duty of a minister; and the power of the magistrates to root out superstition and idolatry. On the 20th of November 1572 the authors of the "Admonition" set up at Wandsworth what has been called the first presbytery in England. They adopted a purely Presbyterian system which was published as the *Orders of Wandsworth*. Similar associations or presbyteries were formed in London and in the midland and eastern counties; but the privy council was hostile. Only in Jersey and Guernsey, whither large numbers of Huguenots had fled after the St Bartholomew massacre, was Presbyterianism fully permitted. Cartwright and Edmund Snape were ministers there; and from 1576 to 1625 a completely appointed Presbyterian Church existed, under the rule of synods, and authorized by the governor. The action of the Commons in 1584, stimulated by the opposition of the Lords, showed that the principles of Presbyterianism were strongly held. Bills were introduced to reduce the position of a bishop to well-nigh that of *primus inter pares*; to place the power of veto in the congregation; to abolish the canon law and to establish a presbytery in every parish. These proposals were rendered abortive by the unflinching use of the queen's prerogative.

In 1640 Henderson, Baillie, Blair and Gillespie came to London as commissioners from the General Assembly in Scotland, in response to a request from ministers in London who desired to see the Church of England more closely modelled after the Reformed type. They were able men, whose preaching drew great crowds, and increased the desire for the establishment of

Presbyterianism. In 1642 the Long Parliament abolished Episcopacy (the act to come into force on the 5th of November 1643); and summoned an assembly of divines to meet at Westminster in June 1643 to advise parliament as to the new form of Church government. The Westminster Assembly, through its *Confession, Directory and Catechisms*, has become so associated with the Presbyterian Church that it is difficult to realize that it was not a church court at all, much less a creation of Presbyterianism.

It was a council created by parliament to give advice in church matters at a great crisis in the nation's history; but its acts, though from the high character and great learning of its members worthy of deepest respect, did not *per se* bind parliament or indeed anyone. It was, in a very real sense, representative of the whole country, as two members were chosen by parliament from each county. The number summoned was 151, viz. ten lords, twenty members of the House of Commons, and one hundred and twenty-one ministers. The ministers were mostly Puritans; by their ordination, &c., Episcopalian; and for the most part strongly impressed with the desirability of nearer agreement with the Church of Scotland, and other branches of the Reformed Church on the Continent. About one-half of the members attended regularly. Those who were out-and-out Episcopalian did not attend at all. Apart from these, there were three well-defined parties: (1) those with Presbyterian ideas and sympathies, a great majority; (2) Erastians, ably represented and led by Selden, Lightfoot and Coleman; (3) Independents, ten or eleven in number, led by Philip Nye, and assured of Cromwell's support. Then there were the Scottish commissioners who, though without votes, took a leading part in the proceedings. Judged by the objects for which it was summoned the Westminster Assembly was a failure, a remarkable failure. Episcopacy, Erastianism and Independency, though of little account in the assembly, were to bulk largely in England's future; while the church polity which the assembly favoured and recommended was to be almost unknown. Judged in other ways, however, the influence of the assembly's labours has been very great. *The Confession of Faith* and the *Larger and Shorter Catechisms* are recognized and venerated standards in all the lands where British Presbyterianism, with its sturdy characteristics, has taken root. And the *Directory of Public Worship* has shaped and coloured, perhaps too thoroughly, the ritual and atmosphere of every group of Protestant Anglo-Saxon worshippers throughout the world, except Episcopalian.

In June 1646 the ordinance establishing presbyteries was ratified by both houses of parliament, and a few days afterwards it was ordered to be put into execution. Twelve presbyteries were erected in London; Shropshire and Lancashire were organized; and Bolton was so vigorous in the cause as to gain the name of the Geneva of Lancashire. But the system never took root. Not only were there well-known adverse influences, but the soil seems to have been uncongenial. As compared with Scotland, English Presbyterianism had more of the lay element. In every classis or presbytery there were two elders to each minister. The Synod of London met half-yearly from 1647 till 1655. Synods also were held in the north. But during the Commonwealth Independency gained ground. Then with the Restoration came Episcopacy, and the persecution of all who were not Episcopalian; and the dream and vision of a truly Reformed English Church practically passed away.

After the Revolution and during the reign of William and Mary the hatred of the Church of England to the Presbyterians and other dissenters had been obliged to lie dormant. With the accession of Anne, however, began an attempt apparently to make up for lost time. From the beginning of the 18th century the greater number of the Presbyterian congregations became practically independent in polity and Unitarian in doctrine. Indigenous Presbyterianism became almost unknown. The Presbyterianism now visible in England is of Scottish origin and Scottish type, and beyond the fact of embracing a few congregations which date from, or before, the Act of Uniformity and the Five Mile Act, has little in common with the Presbyterianism which was for a brief period by law established.

In 1876 the union of the Presbyterian Church in England with the English congregations of the United Presbyterian Church of Scotland gathered all English Presbyterians (with some exceptions) into one church, "The Presbyterian Church of England." "What kept these bodies apart was their separate historic origin and development, but especially the alienation caused by the 'Voluntary Controversy' which had its roots in the difficult problems of civil law in its relation to religion, and the stumbling-block of the civil magistrate's authority in relation to the Christian conscience."¹ Since the union the growth of the Church has been considerable. Presbyterianism is comparatively strong in three districts of England, namely Northumberland, Lancashire and London. Elsewhere it is either weak or non-existent. Even where it is comparatively strong it is largely exotic. The membership is mainly Scottish, and the ministers

¹ Drysdale, *History of the Presbyterians in England*, p. 625.

have been imported principally from Scotland. To English people, therefore, the Presbyterian is still the "Scotch Church," and they are as a whole slow to connect themselves with it. Efforts have been made to counteract this feeling by making the Church more distinctly English. The danger in this direction is that when Presbyterianism has been modified far enough to suit the English taste it may be found less acceptable to its more stalwart supporters from beyond the Tweed. Following the lead of the Independents, who set up Mansfield College at Oxford, the Presbyterian Church has founded Westminster College at Cambridge as a substitute for its Theological Hall in London. It was opened in 1899 with the view of securing a home-bred ministry more conversant with English academic life and thought.

In common with the general Presbyterianism of the British Isles, the Presbyterian Church of England has in recent years been readjusting its relation to the Westminster Confession of Faith. Without setting aside the Confession as the church's standard, twenty-four "Articles of the Faith" have been adopted. In these no change, it is alleged, has been made in regard to the substance of the Westminster doctrine, but there is an alteration of emphasis and proportion.

There are in England fourteen congregations in connexion with the Church of Scotland, six of them in London and the remainder in Berwick, Northumberland, Carlisle and Lancashire.

Many Unitarians in England still call themselves Presbyterians. This, except historically, is a misnomer, for, though descended from the old English Presbyterians, they retain nothing of their distinctive doctrine or polity—nothing of Presbyterianism, indeed, but the name.

Ireland.

Presbyterianism in Ireland, in modern times at least, dates from the plantation of Ulster in the reign of James I. The infusion of a considerable Scottish element into the population necessitated the formation of a congenial church. The immigrants from England took with them, in like manner, their attachment to the Episcopal Church. But these two sections of Protestantism, in their common exile and in presence of the preponderating Roman Catholicism of the country, seemed at first inclined to draw closer together than had been thought possible in Great Britain. A confession of faith, drawn up by Archbishop Usher at the convocation of 1615, implicitly admitted the validity of Presbyterian ordination, and denied the distinction between bishop and presbyter. Within the Episcopal Church and supported by its endowments, Robert Blair, John Livingstone and other ministers maintained a Scottish Presbyterian communion.

From 1625 to 1638 the history of Irish Presbyterians is one of bare existence. Their ministers, silenced by Wentworth, after an ineffectual attempt to reach New England, fled to Scotland, and there took a leading part in the great movement of 1638. After the Irish rebellion of 1641 the Protestant interest for a time was ruined. A majority of the Ulster Protestants were Presbyterians, and in a great religious revival which took place the ministers of the Scottish regiments stationed in Ireland took a leading part. Kirk-sessions were formed in four regiments, and the first regular presbytery was held at Carrickfergus on the 10th of June 1642, attended by five ministers and by ruling elders from the regimental sessions. This presbytery supplied ministers to as many congregations as possible; and for the remainder ministers were sent from Scotland. By the end of 1643 the Ulster Church was fairly established. Notwithstanding intervening reverses there were by 1647 nearly thirty ordained ministers in fixed charges in Ulster besides the chaplains of the Scottish regiments.

At the Restoration, in which they heartily co-operated, there were in Ulster seventy ministers in fixed charges, with nearly eighty parishes or congregations containing one hundred thousand persons. There were five presbyteries holding monthly meetings and annual visitations of all the congregations within their bounds, and coming together in general synod four times a year. Entire conformity with the Scottish Church was maintained, and strict discipline was enforced by pastoral visitations, kirk-sessions and presbyteries.

After the Restoration the determination of the government to put down Presbyterianism was speedily felt in Ireland. In 1661 the lords justices forbade all unlawful assemblies, and in these they included meetings of presbytery as exercising ecclesiastical jurisdiction not warranted by the law. Bishop Jeremy Taylor was forward in this work of persecution. The ministers refused to take the Oath of Supremacy without the qualification suggested by Usher. Their parishes were declared vacant, and episcopal clergy appointed to them. The ejected ministers were forbidden to preach or administer the sacraments. In Ulster sixty-one ministers were ejected. Of seventy only seven conformed. Under Ormonde, in 1665, ministers were again permitted to revive

Presbyterian worship and discipline, and for several years the Church prospered not only in Ulster but also in the south and west. In 1672 she received a yearly grant from Charles II. of £600 (*regium donum*), and under William III. the amount was considerably increased. It was continued till 1869.

In 1679 the rising in Scotland which ended in the battle of Bothwell Bridge brought trouble on the Irish Presbyterians in spite of their loyal addresses disowning it. It was not, however, till 1682 that they again lost the privilege of public ministry, and suffered severe oppression. They were opposed to James II., though they had benefited by his Declaration of Indulgence, and they were the first to congratulate the Prince of Orange on his arrival in England. The heroic defence of Londonderry owed much to them, as they were a majority of the population, and some of their ministers rendered conspicuous service. There were then in Ireland about a hundred congregations, seventy-five with settled ministers, under five presbyteries. Their preponderance in Ulster and their consciousness of their great service to England led them first of all to hope that Presbyterianism might be substituted for Episcopacy in Ulster, and afterwards, that it might be placed on an equal footing with the latter.

During the 18th century Irish Presbyterianism became infected with Arianism. Under the leadership of Dr Henry Cooke, a minister of rare ability and eloquence, the evangelical party triumphed in the church courts, and the Unitarians seceded and became a separate denomination. In 1840 the Synod of Ulster and the Secession Synod united to form the General Assembly of the Presbyterian Church in Ireland.

The Presbyterian Church in Ireland is the most conservative of the great Presbyterian churches in the United Kingdom. Her attitude is one of sturdy adherence to the old paths of evangelical doctrine and Presbyterian polity. She has been a zealous supporter of Irish national education, which is theoretically "united secular and separate religious instruction." The Church Act of 1869 which disestablished and disendowed the Irish Episcopal Church took away the Presbyterian *regium donum*. The ministers with all but absolute unanimity decided to commute their life-interest and form therewith a great fund for the support of the Church. The commutation fund thus formed is a permanent memorial of a generous and disinterested act on the part of her ministry. It amounted in 1902 to £588,028. The interest accruing from it is added to the yearly sustentation contributions, and forms a central fund for ministerial support. Since the state endowment ceased the average income of ministers from their congregations has considerably increased.

The Irish Presbyterian Church has set an example to all her sister churches by her forwardness to care for the poor. Her "Presbyterian Orphan Society" undertakes the support of every poor orphan child throughout the Church. No Presbyterian orphan child now needs to seek workhouse relief. The orphans are boarded in the homes of respectable poor people, who thus also benefit by the society. A scheme of pensions for her aged poor has been instituted.

Three small communities of Presbyterians maintain a separate autonomy in Ireland, viz. the Reformed Presbyterian Church, with thirty-six; the Eastern Reformed, with six; and the Secession Church, with ten congregations.

Wales.

The Presbyterian Church of Wales, commonly known as the "Calvinistic Methodist," had its origin in the great evangelical revival of the 18th century. Its polity has been of gradual growth, and still retains some features peculiar to itself. In 1811 its preachers were first presbyterially ordained and authorized to administer the sacraments. In 1823 a Confession of Faith was adopted. In 1864 the two associations or synods of North and South Wales were united in a general assembly. Great attention is given to the education of the ministry, a considerable number of whom, in recent years, have taken arts degrees at Oxford and Cambridge. As far as the difference in language will permit, there is cordial fellowship and co-operation with the Presbyterian Church of England. The appetite of the Welsh people for sermons is enormous, and the preachers are characterized by an exceptionally high order of pulpit power.

(W. Y.)

United States.

Presbyterianism in the United States is a reproduction and further development of Presbyterianism in Europe. The history of the American Presbyterian churches, excluding the two "Reformed" Churches (see REFORMED CHURCH IN THE UNITED STATES for the German body, and REFORMED CHURCH IN AMERICA for the Dutch body), may be divided into three periods.

1. *The Colonial Period.*—The earliest Presbyterian emigration consisted of French Huguenots under the auspices of Admiral Coligny, led to Port Royal, South Carolina, by Jean Ribaut in 1562, and to Florida (near the present St Augustine) by René de Laudonnière in 1564, and by Ribaut in 1565. The former enterprise was soon abandoned, and the colonists of the latter were massacred by the Spaniards. Under Pierre de Guast, sieur de Monts, Huguenots settled in Nova Scotia in 1604 but did not remain after 1607. Huguenot churches were formed on Staten Island, New York, in 1665; in New York City in 1683; at Charleston, South Carolina, in 1686; at Boston, Massachusetts, in 1687; at New Rochelle, New York, in 1688; and at other places. The Charleston church alone of these early churches maintains its independence of any American denomination.

English Puritans emigrated under the auspices of the Virginia Company to the Bermudas in 1612; and in 1617 a Presbyterian Church, governed by ministers and four elders, was established there by Lewis Hughes, who used the liturgy of the isles of Guernsey and Jersey. Beginning with 1620, New England was colonized by English Presbyterians of the two types which developed from the discussions of the Westminster Assembly (1643-1648) into Presbyterianism and Congregationalism. The Plymouth colony was rather of the Congregational type, and the Massachusetts Bay colony rather of the Presbyterian. These types co-operated as in Old England in the county associations; and a mixed system was produced, called by Henry M. Dexter "a Congregationalized Presbyterianism or a Presbyterianized Congregationalism." Presbyterianism was stronger in Connecticut than in Massachusetts. Thence it crossed into the Dutch settlements on the Hudson and the Delaware, and mingled with other elements in Virginia, Maryland and the Carolinas. Nine of these Puritan Presbyterian churches were established on Long Island between 1640 and 1670—one at Southampton and one at Southold (originally of the Congregational type) in 1640, one at Hempstead about 1644, one at Jamaica in 1662, and churches at Newtown and Setauket in the next half century; and three Puritan Presbyterian churches were established in Westchester county, New York, between 1677 and 1685. In New York City, Francis Doughty preached to Puritan Presbyterians in 1643; in 1650 he was succeeded by Richard Denton (1586-1662). Doughty preached in Virginia and Maryland in 1650-1659, and was the father of British Presbyterianism in the Middle Colonies. His work in Virginia and Maryland was carried on twenty-five years later by Francis Makemie (d. 1708).

Irish Presbyterianism was carried to America by an unknown Irish minister in 1668. Its foremost representative was Francis Makemie, already mentioned, who, in 1683, as an ordained minister of the presbytery of Laggan, was invited to minister to the Maryland and Virginia Presbyterians. In 1684 he acted as pastor of an Irish church at Elizabeth River, Virginia; in 1699 received permission from the colonial authorities to preach at Pocomoke and Onancock on the eastern shore of Virginia, and about 1700 organized a church at Snow Hill in Worcester county, Maryland; in 1704 he returned to America from a trip to Great Britain in which he had interested the Presbyterians of London, Dublin and Glasgow in the American churches, and brought back with him two ordained missionaries, John Hampton (d. c. 1721) and George McNish (1660-1723); in 1707 was imprisoned in New York City for preaching without licence, but was acquitted in 1708.

To the banks of the Delaware the clergy of New England sent missionaries: Benjamin Woodbridge went to Philadelphia in 1698 and was followed almost immediately by Jedediah Andrews (1674-1746), who was ordained in 1701, and under whom the first Presbyterian church in Philadelphia was organized; in 1698 John Wilson (d. 1712) became pastor of a Presbyterian Church at New Castle, Delaware; Samuel Davis (d. 1725) seems to have preached as early as 1692 at Lewes, Delaware, and Nathaniel Taylor (d. 1710) was another of the New England missionaries along the Delaware river and bay. About 1695 Thomas Bridge, with Presbyterians from Fairfield county, Connecticut, settled at Cohansey, in West Jersey. These New England ministers in the Delaware valley, with Francis Makemie as moderator, organized in 1706 the first American presbytery, the presbytery of Philadelphia. In 1716 this presbytery became a synod by dividing itself into four "subordinate meetings or presbyteries," after the Irish model. The synod increased the number of its churches by a large accession, from New York and from New Jersey, where there had been large Presbyterian settlements. The synod seems to have remained without a constitution and without subscription until 1729, when it adopted the Westminster standards. In 1732 the presbytery of "Dunagall" (Donegal) was established in Lancaster county, Pennsylvania.

Two parties had developed with the growth of the Church. The stricter party urged the adoption of the Westminster standards and conformity thereto; the broader party were unwilling to sacrifice their liberty. The former followed the model of the Church of Scotland; the liberal party sympathized with the London and Dublin Presbyterians. The two parties united under the act of 1729, which adopted the Westminster symbols "as being, in all the essential and necessary articles, good forms of sound words

and systems of Christian doctrine." This adopting act allowed scruples as to "articles not essential and necessary in doctrine, worship or government"—the presbytery being judge in the case and not the subscriber. In 1730-1732 the stricter party in the presbyteries of New Castle and Donegal insisted on full subscription, and in 1736, in a minority synod, interpreted the adopting act according to their own views. The liberals put themselves on guard against the plotting of the other side. Friction was increased by a contest between Gilbert Tennent and his friends, who favoured Whitefield and his revival measures, and Robert Cross (1689-1766), pastor at Jamaica in 1723-1758, and his friends. The Tennents erected the Log College (on the Neshaminy, about 20 m. north of Philadelphia) to educate candidates for the ministry; and the synod in 1738 passed an act, aimed at the Log College, providing that all students not educated in the colleges of New England or Great Britain should be examined by a committee of synod, thus depriving the presbyteries of the right of determining in the case. The presbytery of New Brunswick declined to yield (1739). The Cross party charged the Tennents with heresy and disorder; the Tennents charged their opponents with ungodliness and tyranny. When the synod met in 1741 the moderate men remained away; and thus the synod broke in two. The New York presbytery declined at first to unite with either party, worked in vain for reconciliation, and finally joined with the Tennents in establishing the synod of New York (1745) which was called the New Side, in contradistinction to the synod of Philadelphia, the Old Side.

During the separation the New Side established the college of New Jersey at Elizabethtown (now Elizabeth) in 1747, and the Log College of the Tennents was merged into it. It was removed to Princeton in 1755, funds for its aid being received from England, Ireland and Scotland. The Old Side adopted the academy at New London, Chester county, Pennsylvania, which had been organized by Francis Alison in 1741, as their own; but the New London school broke up when Alison became a professor in the Philadelphia Academy (afterwards the university of Pennsylvania). During the separation the synod of Philadelphia decreased from twenty-six to twenty-two ministers, but the synod of New York grew from twenty to seventy-two ministers, and the New Side reaped all the fruits of the Great Awakening under Whitefield and his successors. Different views on subscription and discipline, and the arbitrary act of excision were the barriers to union, but these were removed; in 1758 the adopting act was re-established in its original breadth, the "Synod of New York and Philadelphia" was formed, and the reunion was signaled by the formation of the presbytery of Hanover in Virginia. Under John Witherspoon the college of New Jersey was the favoured school of the reunited church. The union was not perfect; the presbytery of Donegal was for three years in revolt against the synod; and in 1762 a second presbytery of Philadelphia was formed; but the strength of the synod increased rapidly and at the outbreak of the War of Independence it had 11 presbyteries and 132 ministers.

Presbyterianism had an independent development in the Carolinas, whither there was a considerable Scotch migration in 1684-1687. William Dunlop (c. 1650-1700) ministered to them until 1688, when he became principal of the university of Glasgow. At Charleston a mixed congregation of Scotch Presbyterians and English Puritans was organized in 1690. What is now Dorchester county, South Carolina, was settled in 1695 by members of a church established in Dorchester, Massachusetts. In 1710 there were five churches in the Carolinas; in 1722-1723 they formed the presbytery of James Island, which (after 1727) went through the same struggle as the synod of Philadelphia in reference to subscription; and in 1731 the parties separated into subscribers and non-subscribers.

From New England, as has been seen, Puritan settlers established Presbyterian churches (or churches which immediately became Presbyterian) in Long Island, on New Jersey, and in South Carolina; but the Puritans who remained in New England usually established Congregational churches. But there were exceptions: Irish Presbyterians from Ulster formed a church at Londonderry, New Hampshire, which, about 1729, grew into a presbytery; the Boston presbytery, organized in 1745, became in 1774 the synod of New England with three presbyteries and sixteen ministers; and there were two independent presbyteries, that of "the Eastward" organized at Boothbay, Maine, in 1771, and that of Grafton, in New Hampshire, founded by Eleazar Wheelock and other ministers interested in Dartmouth College.

The Presbyterians from the Scotch Established Church combined with the American Presbyterian Church, but the separating churches of Scotland organized independent bodies. The Reformed Presbyterian Church (Covenanters) sent John Cuthbertson in 1751; he was joined in 1773 by Matthew Lind and Alexander Dobbin from the Reformed Presbytery of Ireland, and they organized in March 1774 the Reformed Presbytery of America. The Anti-Burgher Synod sent Alexander Gellatly and Andrew Arnot in 1752, and two years later they organized the Associate Presbytery of Pennsylvania; they were joined in 1757 by the Scotch Church in New York City, which had split off because of objections to the growing use of Watts's Psalms; they had grown to two presbyteries and thirteen

ministers in 1776. The Burgher Synod in 1764 sent Thomas Clarke of Ballybay, Ireland, who settled at Salem, Washington county, New York, and in 1776 sent David Telfair, of Monteth, Scotland, who preached in Philadelphia; they united with the Associate Presbytery of Pennsylvania; in 1771 the Scotch Synod ordered the presbytery to annul its union with the Burghers, and although Dr Clarke of Salem remained in the Associate Presbytery, the Burgher ministers who immigrated later joined the Associate Reformed Church. In 1769-1774 there was a futile attempt to secure the union of the Associate Presbytery with the main American Church.

2. *From the War of Independence to the Civil War.*—During the War of Independence the Presbyterian churches suffered severely. Ministers and people with few exceptions—the most notable being the Scotch Highlanders who had settled in the valley of the Mohawk in New York and on Cape Fear river in North Carolina—sided with the patriot or Whig party: John Witherspoon was the only clergyman in the Continental Congress of 1776, and was otherwise a prominent leader; John Murray of the Presbytery of the Eastward was an eloquent leader in New England; and in the South the Scotch-Irish were the backbone of the American partisan forces, two of whose leaders, Daniel Morgan and Andrew Pickens, were Presbyterian elders.

At the close of the War the Presbyterian bodies began at once to reconstruct themselves. In 1782 the presbyteries of the Associate and Reformed churches united, forming the Associate and Reformed Synod of North America; but as there were a few dissenters in both bodies the older Associate and Reformed Presbyteries remained as separate units—the Associate Presbytery continued to exist under the same name until 1801, when it became the Associate Synod of North America; in 1818 it ceased to be subordinate to the Scotch General Synod. The Associate Reformed Synod added in 1794 a fourth presbytery, that of Londonderry, containing most of the New England churches, but in 1801 “disclaimed” this presbytery because it did not take a sufficiently strict view of the question of psalm-singing. The Reformed Presbytery of North America was reconstituted by two ministers from Ireland in 1798; it became a synod of three presbyteries in 1809 and a general synod in 1823; in the first decade of the century the presbytery required all members to free their slaves. The synod of New York and Philadelphia, which in 1781 had organized the presbytery of Redstone, the first of western Pennsylvania, in 1788 resolved itself into a General Assembly, which first met in Philadelphia in 1789, and after revising the chapters on Church and state, adopted the Westminster symbols as to their constitution, “as containing the system of doctrine taught in the Holy Scriptures,” and they made them unalterable without the consent of two-thirds of the presbyteries and the General Assembly. In 1801 a “plan of union” proposed by the General Association (Congregational) of Connecticut was accepted by the General Assembly, and the work of home missions in the western section of the country was prosecuted jointly. The result was mixed churches in western New York and the new states west of the Alleghany Mountains, which grew into presbyteries and synods having peculiar features midway between Presbyterianism and Congregationalism.

The general strictness of the church in its requirements for ministerial education occasioned it great loss in this period when the territory beyond the Appalachians was being settled so largely by Scotch-Irish and Presbyterians. The revivals in Kentucky brought about differences which resulted in the high-handed exclusion of the revivalists. These formed themselves into the presbytery of Cumberland, on the 4th of February 1810, which grew in three years into a synod of three presbyteries and became the “Cumberland Presbyterian Church.” In 1813 they revised the Westminster Confession and excluded, as they claimed, fatalism and infant damnation. If they had appealed to the General Assembly they might have received justice, or possibly the separation might have been on a larger scale. In 1822, under the influence of John Mitchell Mason (1770-1829), the Associate Reformed Synod combined with the General Assembly of the Presbyterian Church, but the majority was too slender to make the union thorough. The greater part of the ministers decided to remain separate, and accordingly organized three independent synods—New York, Scioto and the Carolinas. In 1858 the associate synods of the north and west united with the Associate Synod as the United

Presbyterian Church. In 1833 the Reformed Presbyterian Church divided into New Lights and Old Lights in a dispute as to the propriety of Covenanters exercising the rights of citizenship under the constitution of the United States.

A great and widespread revival marked the opening years of the century, resulting in marvellous increase of zeal and numbers. New measures were adopted, doctrines were adapted to the times, and ancient disputes were revived between the conservative and progressive forces. Theological seminaries had been organized: the Theological Seminary of the Presbyterian Church at Princeton, N.J., founded in 1812 by the General Assembly; the Auburn Theological Seminary at Auburn, N.Y., founded in 1819 by the synod of Geneva, and afterwards associated with the New School; a school at Hampden Sidney, Virginia, founded by the synod of Virginia in 1824, named Union Theological Seminary in Virginia after 1826, supported after 1828 by the synods of Virginia and North Carolina, and in 1898 removed to Richmond, Va.; the Western Theological Seminary, founded at Allegheny (Pittsburg), Pa., in 1827 by the General Assembly; the Presbyterian Theological Seminary at Columbia, South Carolina, founded in 1828 by the synod of South Carolina; Lane Theological Seminary, founded independently in 1829 by the New School at Cincinnati, Ohio; and Union Theological Seminary, founded in 1836 by independent action of New School men, in New York City. Differences in doctrine as well as polity and discipline became more and more prominent. The doctrinal differences came to a head in the trials of George Duffield (1832), Lyman Beecher (1835) and Albert Barnes (1836) which, however, resulted in the acquittal of the accused, but which increased friction and ill feeling. The differences developed were chiefly between general atonement and atonement for the elect only and between mediate imputation and immediate imputation.

The agitation with reference to African slavery threw the bulk of the Southern Presbyterians on the Old Side, which was further strengthened by the accession of the Associate Reformed. The ancient differences between Old and New Side were revived, and once more it was urged that there should be (1) strict subscription, (2) exclusion of the Congregationalized churches, and strict Presbyterian polity and discipline, and (3) the condemnation and exclusion of the new divinity and the maintenance of scholastic orthodoxy. In 1834 a convention of the Old Side was held in Philadelphia, and the “Act and Testimony” was adopted charging doctrinal unsoundness and neglect of discipline upon the New Side, and urging that these should be excluded from the Church. The moderate men on both sides opposed this action and strove for peace or an amicable separation, but in vain. In 1837 the Old Side obtained the majority in the General Assembly for the second time only in seven years; they seized their opportunity and abrogated the “Plan of Union of 1801 with the Connecticut Congregationalists,” cut off the synod of Western Reserve and then the synods of Utica, Geneva and Genesee, without a trial, and dissolved the third presbytery of Philadelphia without providing for the standing of its ministers. The New Side men met in convention at Auburn, N.Y., in August 1837, and adopted measures for resisting the wrong, but in the General Assembly of 1838 the moderator refused to recognize their commissioners. On an appeal to the assembly the moderator’s decision was reversed, a new moderator was chosen, and the assembly adjourned to another place of meeting. The Old Side remained after the adjournment and organized themselves, claiming the historic succession. Having the moderator and clerks from the assembly of 1837, they retained the books and papers. Thus two General Assemblies were organized, the Old and the New School. An appeal was made to the civil courts, which decided (1839) in favour of the New School; but this decision was overruled and a new trial ordered. It was deemed best, however, to cease litigation and to leave matters as they were.

Several years of confusion followed. In 1840 we have the first safe basis for comparison of strength.

	Ministers.	Churches.	Communicants.
Old School . .	1308	1898	126,583
New School . .	1234	1375	102,060

The “sides” remained separate throughout the remainder of this period. The North was especially agitated by the slavery question.¹ In 1847 the synod of the Free Presbyterian Church was formed by the anti-slavery secession of the presbytery of Ripley, O. (New School), and a part of the presbytery of Mahoning, Pa., (Old School); this synod, then numbering five presbyteries with 43 ministers, joined the New School Assembly during the Civil War. In 1850 the New School Assembly declared slave-holding, unless excusable for some special reason, a cause for discipline; in 1853 it asked the Southern presbyteries to report what action they had taken to put themselves in accord with the resolution of 1850;

¹ The separation of the southern part of the Associate Reformed Church from the northern in 1821, and the establishment of the Associate Reformed Synod of the South had not been due to slavery, but was for convenience in administration.

in 1858, 6 synods, 21 presbyteries and about 15,000 communicants withdrew and organized the United Synod. Just before the outbreak of the Civil War in 1861 these churches numbered:—

	Synods.	Presbyteries.	Ministers.	Churches.	Communicants.
Old School .	33	171	2656	3531	292,927 (1860)
New School.	22	104	1523	1482	134,933 (1860)
United Synod	4	15	113	197	10,205 (1858)
Cumberland Presbyterian	23	96	890	1189	82,008 (1859)

3. *Since the beginning of the Civil War.*—The Southern presbyteries of the Old School Assembly withdrew in 1861, and delegates from ten southern synods (47 presbyteries) met in Augusta, Georgia, in December, and organized as the General Assembly of the Presbyterian Church in the Confederate States of America, which included 700 ministers, 1000 churches and 75,000 communicants. Its strength was increased by the addition: in 1863 of the small Independent Presbyterian Church of South Carolina; in 1865 of the United Synod (New School), which at that time had 120 ministers, 190 churches, and 12,000 communicants; in 1867 of the presbytery of Patapsco; in 1869 of the synod of Kentucky; and in 1874 of the synod of Missouri. At the close of the Civil War this Southern Church adopted the name of the General Assembly of the Presbyterian Church in the United States.

In 1867 there was an unsuccessful attempt to combine all the Presbyterian bodies of the North. In 1869 the Old and New Schools in the North combined on the basis of the common standards; to commemorate the union a memorial fund was raised which amounted in 1871 to \$7,607,492. Between 1870 and 1881 three presbyteries of the Reformed Presbyterian General Synod (New School) joined the northern General Assembly. In 1906 the greater part of the Cumberland Presbyterian Church (then having 195,770 members) united with the northern General Assembly. Although the differences between the Old School and the New School were much less in 1869 than in 1837—during the separation the New School was conservative, the Old School liberal, in tendency—there were serious dissensions in the northern church after the union. The first of these was due to the adoption by certain teachers in theological seminaries of the methods and results of the "higher criticism," and two famous heresy cases followed. Charles Augustus Briggs, tried for heresy for his inaugural address in 1891 as professor of biblical theology at Union Seminary (in which he attacked the inerrancy of the Bible, held the composite character of the Hexateuch and of the Book of Isaiah and taught that sanctification is not complete at death), was acquitted by the presbytery of New York, but was declared guilty and was suspended from its ministry by the General Assembly of 1893. Henry Preserved Smith, professor of Hebrew and Old Testament exegesis in Lane Seminary, for a pamphlet published in 1891 denying the inerrancy but affirming the inspiration of the Scriptures, was suspended in 1892 by the presbytery of Cincinnati, and was unsuccessful in his appeal to the synod and to the General Assembly. Dr Briggs remained a member of the Union Seminary faculty but left the Presbyterian Church to enter the Protestant Episcopal. Dr Smith resigned his chair at Lane Seminary, and entered the Congregational ministry. In 1892-1893 there was an open break between the General Assembly and Union Seminary, which repudiated the agreement of 1870¹ between the seminaries and the assembly; the assembly disclaimed responsibility for the Seminary's teachings and withheld financial aid from its students. In 1896 McCormick Theological Seminary (which in 1858 as New Albany Theological Seminary had come under the control of the assembly) and Auburn Seminary refused to make the changes desired by the General Assembly; a satisfactory arrangement with McCormick was made. Lane and Auburn remained practically independent.

But although the conservative party was successful in inducing successive general assemblies to lay repeatedly stronger stress on the verbal inerrancy of Holy Scripture and to make belief in such inerrancy a requisite of teachers in theological seminaries and of candidates for the ministry, there was in other matters an increasing liberal tendency. In 1902 the General Assembly adopted a Brief Statement of the Reformed Faith, not as a legal standard but as an interpretation of the confession; it repudiated the doctrine of infant damnation, insisted on the consistency of predestination with God's universal love, and incorporated new chapters on the Holy Spirit, the love of God, and missions. The Assembly of 1906 authorized (but did not make mandatory) the use of a book of common worship; the question of a liturgy had been opened in

1855 by C. W. Baird's *Eutaxia*; in 1864 Charles W. Shields (1825-1904), who afterwards entered the Protestant Episcopal Church, republished and urged the adoption of the Book of Common Prayer as amended by the Westminster Divines in the royal commission of 1661; and Henry Van Dyke was prominent in the latter stage of the movement for a liturgy.

The northern General Assembly and the Cumberland Church, which united with it in 1906, are the only Presbyterian bodies in America that have done anything tangible for Christian union in the last fifty years: the southern Assembly is much more conservative than the northern—in 1866 it suspended James Woodrow (1828-1907), professor of natural science in connexion with revealed religion, for holding evolutionary views, and it declared that Adam's body was "directly fashioned by Almighty God, without any natural animal parentage of any kind, out of matter previously created out of nothing"; and in 1897 it ordered that women were not to speak in promiscuous meetings—and its attitude toward the negro, insisting in separate church organizations for blacks and whites, makes union with the northern bodies difficult; the United Presbyterian Church in North America in 1890 refused to join the union of Presbyterian and Reformed missions in India, and its opposition to instrumental music and to the use of any songs but the psalms of the Old Testament, although this is decreasing in strength, are bars to union; the synod of the Reformed Presbyterian Church of North America in 1888 refused to unite with the United Presbyterian Church because the latter did not object to the secular character of the constitution of the United States; and with the general synod of the Reformed Presbyterian Church the synod could not unite in 1890 because the general synod allowed and the synod did not allow its members to "incorporate" themselves with the political system of the United States. A loose union, called the "Federal Council of the Reformed Churches in America," was formed in 1894 by the churches mentioned (excepting the Southern Assembly) and the Dutch and German Reformed churches.

More or less closely connected with the Northern Church are the theological seminaries at Princeton, Auburn, Pittsburg (formerly Allegheny—the Western Seminary), Cincinnati (Lanc), New York (Union) and Chicago (McCormick), already named, and San Francisco Seminary (1871) since 1892 at San Anselmo, Cal., a theological seminary (1891) at Omaha, Nebraska, a German theological seminary (1869) at Bloomfield, New Jersey, the German Presbyterian Theological School of the North-west (1852) at Dubuque, Iowa, and the Presbyterian Theological Seminary of Kentucky, which is under the control and supervision of the northern and southern churches. Seminaries of the Southern Church are the Union Theological Seminary at Richmond, Virginia, and the Columbia Theological Seminary at Columbia, South Carolina, already mentioned, the Austin Presbyterian Theological Seminary (1902) at Austin, Texas, the theological department in the South-western Presbyterian University at Clarksville, Tennessee, and, for negroes, Stillman Institute (1877), at Tuscaloosa, Alabama. The United Presbyterian Church has two seminaries, one at Xenia, Ohio, and one at Allegheny (Pittsburg). Of the Covenant bodies the synod of the Reformed Presbyterian Church has a theological seminary in Allegheny (Pittsburg), established in 1856, and the general synod in 1887 organized a college at Cedarville, Ohio. The Associate Reformed Synod of the South has the Erskine Theological Seminary (1837) in Due West, South Carolina.

The foreign missionary work of the General Assembly had been carried on after 1812 through the (Congregational) American Board of Commissioners for Foreign Missions (organized in 1810) until the separation of 1837, when the Old School Assembly established its own board of foreign missions; the New School continued to work through the American board; after the union of 1869 the separate board was perpetuated and the American board transferred to it, with the contributions made to the American board by the New School churches, the missions in Africa (1833), in Syria (1822), and in Persia (1835). The Church now has, besides these missions, others in India (1834), Siam (1840), China (1846), Colombia (1856), Brazil (1859), Japan (1859), Laos (1867), Mexico (transferred in 1872 by the American and Foreign Christian Union), Chile (transferred in 1873 by the same Union; first established in 1845), Guatemala (1882), Korea (1884) and the Philippine Islands (1899). A board of home missions was organized in 1816; a board of education in 1819; a woman's board of foreign missions in 1869; a women's executive committee for home mission work (which takes particular interest in the work for the freedmen) in 1878; a board of publication in 1838 (after 1887 called the board of Publication and Sunday School Work); a board of aid for colleges

¹ This agreement, proposed to the General Assembly in 1870 by the directors of Princeton and of Union, gave the Assembly a veto on the election and removal of professors.

(1883); a board of church erection in 1844; a board of work for freedmen; and a board of ministerial relief; after the union of 1869 the Board of Home Missions was removed from Philadelphia to New York City.

The Southern Church, unlike the Northern, is not working through "boards," but through executive committees, which were formerly more loosely organized, and which left to the presbyteries the more direct control of their activities, but which now differ little from the boards of the northern Church. It has: an executive committee on foreign missions (first definitely organized by the Assembly in 1877), which has missions in China (1867), Brazil (1869), Mexico (1874), Japan (1885), Congo Free State (1891), Korea (1896) and Cuba (1899); and executive committees of home missions (1865), of publication and sabbath school work, of ministerial education and relief, of schools and colleges and of colored evangelization (formed in 1891). Permanent committees on the "sabbath and family religion," the "Bible cause" and "evangelistic work" report to the General Assembly annually.

The United Presbyterian Church has a board of foreign missions (reorganized in 1859) with missions in Egypt (1853), now a synod with four presbyteries (in 1909, 71 congregations, 70 ministers and 10,341 members), in the Punjab (1854), now a synod with four presbyteries (in 1909, 35 congregations, 51 ministers and 17,321 members), and in the Sudan (1901); and boards of home missions (reorganized, 1859), church extension (1859), publication (1859), education (1859), ministerial relief (1862), and missions to the freedmen (1863).

Presbyterians of different churches in the United States in 1906 numbered 1,830,555; of this total 322,542 were in Pennsylvania, where there were 248,335 members of the Presbyterian Church in the United States of America (the Northern Church), being more than one-fifth of its total membership; 56,587 members of the United Presbyterian Church of North America, being more than two-fifths of its total membership; 2709 members of the Synod of the Reformed Presbyterian Church of North America, three-tenths of its total membership; the entire membership of the Reformed Presbyterian Church in the United States and Canada (440), 3150 members of the Welsh Calvinistic Methodist Church, nearly one-fourth of its total membership; and 2065 members of the Reformed Presbyterian Church in North America, general synod, about five-ninths of its total membership. The strength of the Church in Pennsylvania is largely due to the Scotch-Irish settlements in that state. Philadelphia is the home of the boards of publication and of Sunday schools of the Northern Church; and in Allegheny (Pittsburg) are the principal theological seminary of the United Presbyterian body and its publishing house. In New York state there were 199,923 Presbyterians, of whom 186,278 were members of the Northern Church and 10,115 of the United Presbyterian Church of North America. In Ohio there were 138,768 Presbyterians, 114,772 being of the Northern and 18,336 of the United Presbyterian Church. The other states with a large Presbyterian population were Illinois (115,602; 86,251 of the Northern Church; 17,208 of the Cumberland Church; 9555 of the United Presbyterian Church); New Jersey (79,912; 78,490 of the Northern Church); Tennessee (79,337; 42,464 being Cumberland Presbyterians, more than one-fifth of the total membership; 6640 of the Colored Cumberland Church, more than one-third of its membership; 21,390 of the Southern Church; and 6786 of the Northern Church); Missouri (71,599; 28,637 of the Cumberland Church; 25,991 of the Northern Church; 14,713 of the Southern Church); Texas (62,090; 31,598 of the Cumberland Church; 23,934 of the Southern Church; 4118 of the Northern Church; and 2091 of the Colored Cumberland Church); Iowa (60,081; 48,326 of the Northern Church; 8890 of the United Presbyterian Church); and North Carolina (55,837; 41,322 of the Southern and 10,696 of the Northern Church). The Northern Church had a total membership of 1,179,566. The Southern Church had a total membership of 266,345. The Cumberland Presbyterian Church had (in 1906, when it became a part of the Northern Church) 195,770 members. The Colored Cumberland Church had a membership of 18,066. The United Presbyterian Church of North America had a total membership of 130,342. The Welsh Calvinistic Methodist Church had a total membership of 13,280. The Associate Reformed Synod of the South had a membership of 13,201. The Synod of the Reformed Presbyterian Church in North America had in 1906 a membership of

9122. The "Reformed Presbyterian Church in North America, General Synod," had a membership of 3620. The Associate Presbyterian Church, or Associated Synod of North America had a membership of 786. The Reformed Presbyterian Church in the United States and Canada had a membership in the United States of 440.

On American Presbyterianism, see Charles Hodge, *Constitutional History of the Presbyterian Church in the United States of America, 1706-1788* (2 vols., Philadelphia, 1839-1840); *Records of the Presbyterian Church in the United States of America from 1706 to 1788* (ibid., 1841); Richard Webster, *History of the Presbyterian Church in America* (ibid., 1858); E. H. Gillett, *History of the Presbyterian Church in the United States of America* (2nd ed., ibid., 1873); C. A. Briggs, *American Presbyterianism* (New York, 1885). There is a good bibliography on pp. xi-xxi of R. E. Thompson's *History of the Presbyterian Churches in the United States* (ibid., 1895), vol. vi. of the American Church History Series; in the same series in vol. xi. are sketches of "The United Presbyterians," by J. B. Scouller, "The Cumberland Presbyterians," by R. N. Foster, and "The Southern Presbyterians," by Thomas C. Johnson. Other works on the separate churches are: E. B. Crisman, *Origin and Doctrines of the Cumberland Presbyterian Church* (St Louis, 1877) and W. M. Glasgow, *History of the Reformed Presbyterian Church in America* (Baltimore, 1888).

PRESBYTERY, in architecture, that portion of the choir of a church in which the high altar is placed, and which is generally raised by a few steps above the rest of the church. It is reserved for the priests, and in that respect differs from the choir, the stalls in which are occasionally occupied by the laity. In Westminster Abbey the space east of the transept is the presbytery, and the same arrangement is found in Canterbury Cathedral. In San Clemente at Rome the presbytery is enclosed with a marble balustrade or screen. For the use of the word in Church government see **PRESBYTER** and **PRESBYTERIANISM**.

PRESCOT, a market town and urban district in the Ormskirk parliamentary division of Lancashire, England, 8 m. E. of Liverpool by the London & North Western railway. Pop. (1901), 7855. It is of considerable antiquity, and received a grant for a market and fair in the 7th year of Edward III. A church existed in the 13th century. The present church of St Mary is in various styles, with a lofty tower and spire and carved timber roof. The chief industry is the making of watches, and the town has long been celebrated for the production of watch movements and tools. The industry was first introduced in 1730 by John Miller from Yorkshire. There is also a manufacture of electric cables. John Philip Kemble, the actor, was born at Prescot in 1757. To the north of the town is Knowsley Park, the demesne of the earls of Derby, with a mansion of various dates from the 15th century onward, containing a fine collection of pictures. Prescot was formerly of greater importance in relation to the now populous district of south-west Lancashire; it was also a postal centre, and it is curious to notice that such addresses as "Liverpool, near Prescot" were necessary.

PRESCOTT, WILLIAM HICKLING (1796-1859), American historian, was born in Salem, Massachusetts, on the 4th of May 1796. His grandfather was Colonel William Prescott (1726-1795), who commanded at the battle of Bunker Hill; and his father was a well-known lawyer. He received his earlier education in his native city, until the removal of his family in 1808 to Boston. He entered Harvard College in the autumn of 1811, but almost at the outset his career was interrupted by an accident which affected the subsequent course of his life. A hard piece of bread, flung at random in the Commons Hall, struck his left eye and destroyed the sight. After graduating honourably in 1814 he entered his father's office as a student of law; but in January 1815 the uninjured eye showed dangerous symptoms of inflammation. When at last in the autumn he was in condition to travel, it was determined that he should pass the winter at St Michael's and in the spring obtain medical advice in Europe. His visit to the Azores, which was constantly broken by confinement to a darkened room, is chiefly noteworthy from the fact that he there began the mental discipline which enabled him to compose and retain in memory long passages for subsequent dictation; and, apart from the gain in culture, his journey

to England, France, and Italy (April 1816 to July 1817) was scarcely satisfactory. The verdict of the physicians was that the injured eye was hopelessly paralysed, and that the preservation of the sight of the other depended upon the maintenance of his general health. His further pursuit of the legal profession seemed to be out of the question, and on his return to Boston he remained quietly at home. On 4th May 1820 he was married to Miss Susan Amory. Prior to his marriage he had made a few experiments in composition, but he now finally decided to devote his life to literature. A review of Byron's *Letters on Pope* in 1821 constituted his first contribution to the *North American Review*, to which he continued for many years to send the results of his slighter researches. He next turned to French literature, and to the early English drama and ballad literature. Of the direction and quality of his thought at this time he has left indications in his papers on *Essay-Writing* (1822) and on *French and English Tragedy* (1823). In pursuance of his method of successive studies he began in 1823 the study of Italian literature, passing over German as demanding more labour than he could afford. In the following year he made his first acquaintance with the literature of Spain under the influence of his friend and biographer, Ticknor; and, while its attractiveness proved greater than he had at the outset anticipated, the comparative novelty of the subject as a field for research served as an additional stimulus.

In the meantime his aims had been gradually concentrating. History had always been a favourite study with him, and Mably's *Observations sur l'histoire* appears to have had considerable influence in determining him to the choice of some special period for historic research. The selection, however, was not finally made without prolonged hesitation. It was not till the 19th of January 1826 that he recorded in the private memoranda begun by him in 1820 his decision "to embrace the gift of the Spanish subject." The choice was certainly a bold one. He could only use the eye which remained to him for brief and intermittent periods, and as travelling affected his sight prejudicially he could not anticipate any personal research amongst unpublished records and historic scenes. He was happy, however, in the possession of ample means and admirable friends; and he sketched with no undue restriction or hesitancy the plan of the *History of the reign of Ferdinand and Isabella*—his first great work. Mr English, one of his secretaries, has furnished a picture of him at this period seated in a study lined on two sides with books and darkened by green screens and curtains of blue muslin, which required readjustment with almost every cloud that passed across the sky. His writing apparatus—a noctograph—lay before him, and he kept his ivory style in his hand to jot down notes as the reading progressed. In accordance with his general method these notes were in turn read over to him until he had completely mastered them, when they were worked up in his memory to their final shape. So proficient did he become that he was able to retain the equivalent of sixty pages of printed matter in his memory, turning and returning them as he walked or drove. The rate of progress was necessarily slow, apart from any liability to interruption by other undertakings and failures in bodily health. He still continued his yearly experimental contributions to the *North American Review*, elaborating them with a view as much to ultimate historical proficiency as to immediate literary effect, the essays on *Scottish Song* (1826), *Novel-Writing* (1827), *Molière* (1828), and Irving's *Granada* (1829) belonging to this preparatory period. On the 6th of October 1829 he began the actual work of composition, which was continued without more serious interruptions than those occasioned by the essays on *Asylums for the Blind* (1830), *Poetry and Romance of the Italians* (1831), and *English Literature of the 19th Century* (1832), until the 25th of June 1836, when the concluding note was written. Another year, during which his essay on *Cervantes* appeared, was spent in the final revision of the *History* for the press. Its success upon its publication in Boston was immediate. Arrangements were speedily made for its publication in England, and there its success was not less marked. From the position of an obscure reviewer Prescott

suddenly found himself elevated to the first rank of contemporary historians.

After coquetting for a short time with the project of a life of Molière he decided to follow in the track of his first work with a *History of the Conquest of Mexico*. Washington Irving, who had already made preparations to occupy the same field, generously withdrew in his favour. The work was completed in August 1843, the five years' labour having been broken by the composition of reviews of Lockhart's *Life of Scott* (1838), Kenyon's *Poems* (1839), *Chateaubriand* (1839), Bancroft's *United States* (1841), Mariotti's *Italy* (1842), and Madame Calderon's *Life in Mexico* (1843), and by the preparation of an abridgment of his *Ferdinand and Isabella* in anticipation of its threatened abridgment by another hand. On the 6th of December 1843 the *Conquest of Mexico* was published with a success proportionate to a wide reputation won by his previous work. The careful methods of work which he had adopted from the outset had borne admirable fruit. While the consultation of authorities had been no less thorough, his style had become more free and less self-conscious; and the epic qualities of the theme were such as to call forth in the highest degree his powers of picturesque narration.

It was only a step from the conquest of Mexico to that of Peru, and scarcely three months elapsed before he began to break ground on the latter subject. In February 1845 he received the announcement of his election as corresponding member of the French Institute in place of the Spanish historian Navarrete, and also of the Royal Society of Berlin. The winter found him arranging for the publication in England of the selection from his articles and reviews which appeared in 1845, under the title of *Critical and Historical Essays*, and was issued almost contemporaneously at New York under the title of *Biographical and Critical Miscellanies*. The *Conquest of Peru* was completed in November 1846 and published in March following. His misgivings as to its reception were at once set at rest, and it was speedily issued in translations into French, Spanish, German and Dutch, in addition to the English editions of New York, London and Paris.

He was now over fifty and his sight showed serious symptoms of enfeeblement. Although during the composition of the *Ferdinand and Isabella* it had been of very intermittent service to him, it had so far improved that he could read with a certain amount of regularity during the writing of the *Conquest of Mexico*, and also, though in a less degree, during the years devoted to the *Conquest of Peru*. Now, however, the use of his remaining eye had been reduced to an hour a day, divided into portions at wide intervals, and he was driven to the conclusion that whatever plans he made must be formed on the same calculations as those of a blind man. He had been for many years collecting materials for a history of Philip II., but he hesitated for some time to attempt a work of such magnitude, occupying himself in the meantime with the slighter labours of a memoir of John Pickering for the Massachusetts Historical Society and the revision of Ticknor's *History of Spanish Literature*. But in March 1848 he set himself with characteristic courage to the accomplishment of the larger project. He had been fortunate in obtaining the aid of Don Pascual de Gayangos, then professor of Arabic literature at Madrid, by whose offices he was enabled to obtain material not only from the public archives of Spain but from the muniment rooms of the great Spanish families. With an exceptional range of information thus afforded him, he wrote the opening of his history in July 1849; but, finding himself still unsettled in his work, he decided in the spring of the following year to carry out a long projected visit to England. The idea of writing memoirs was dismissed in favour of the more elaborate form, and in November 1855 the first two volumes of his uncompleted *History of Philip II.* were issued from the press, their sale eclipsing that of any of his earlier books. This was his last great undertaking; but as Robertson's *Charles V.*, in the light of new sources of information, was inadequate to take its place as a link in the series, he republished it in an improved and extended form in December 1856. A slight attack of

apoplexy on the 4th of February 1858 foretold the end, though he persevered with the preparation of the third volume of *Philip II.* for the press, and with the emendation and annotation of his *Conquest of Mexico*. On the morning of the 27th of January 1859 a second attack occurred, and he died in the afternoon of the same day in his sixty-third year.

As an historian Prescott stands in the direct line of literary descent from Robertson, whose influence is clearly discernible both in his method and style. But, while Robertson was in some measure the initiator of a movement, Prescott came to his task when the range of information was incomparably wider and when progress in sociologic theory had thrown innumerable convergent lights upon the progress of events. He worked, therefore, upon more assured ground; his sifting of authorities was more thorough and his method less restricted. At the same time he cannot be classed as in the highest sense a philosophic historian. His power lies chiefly in the clear grasp of fact, in selection and synthesis, in the vivid narration of incident. For extended analysis he had small liking and faculty; his critical insight is limited in range, and he confines himself almost wholly to the concrete elements of history. When he does venture upon more abstract criticism his standards are often commonplace and superficial, and the world scheme to which he relates events is less profound than the thought of his time altogether warranted. Moreover, the authorities on whom he relied have had to be corrected since in many points of detail in the light of later archaeological research. If these things, however, indicate Prescott's deficiencies from the point of view of ideal history, few historians have had in a higher degree that artistic feeling in the broad arrangement of materials which ensures popular interest. The course of his narrative is unperplexed by doubtful or insoluble problems. The painting is filled in with primary colours and with a free hand; and any sense of crudity which may be awakened by close inspection is compensated by the vigour and massive effectiveness of the whole.

Prescott's works in 16 vols. were edited by J. F. Kirk in 1870-1874. His *Life* was written by George Ticknor (1864; revised 1875). There are later lives by R. Ogden (1904), and H. T. Peck (1905).

PRESCRIPTION, in the broadest sense, the acquisition or extinction of rights by lapse of time. The term is derived from the *praescriptio* of Roman law, originally a matter of procedure, a clause inserted before the *formula* on behalf of either the plaintiff or, in early times, the defendant, limiting the question at issue. It was so called from its preceding the *formula*.¹ One of the defendant's *praescriptiones* was *longi temporis* or *longae possessionis praescriptio* (afterwards superseded by the *exceptio*), limiting the question to the fact of possession without interruption by the defendant for a certain time. It seems to have been introduced by the praetor to meet cases affecting aliens or lands out of Italy where the *usucapio* of the civil law (the original means of curing a defect of title by lapse of time) could not apply. The time of acquisition by *usucapio* was fixed by the Twelve Tables at one year for movables and two years for immovables. *Praescriptio* thus constituted a kind of praetorian *usucapio*. In the time of Justinian *usucapio* and *praescriptio* (called also *longi temporis possessio*), as far as they affected the acquisition of ownership, differed only in name, *usucapio* being looked at from the point of view of property, *praescriptio* from the point of view of pleading. By the legislation of Justinian movables were acquired by three years' possession, immovables by ten years' possession where the parties had their domicile in the same province (*inter praesentes*), twenty years' possession where they were domiciled in different provinces (*inter absentes*). Servitudes could not be acquired by *usucapio* proper, but were said to be acquired by *quasi usucapio*, probably in the same time as sufficed to give a title to immovables. There was also a *longissimi temporis possessio* of thirty years, applicable to both movables and immovables, and requiring nothing but *bona fides* on the part of the possessor. Where the right sought to be established was claimed against the Church, a still longer period of forty years (at one time a hundred) was necessary. Immemorial prescription was required in a few cases of a public character, as roads.² *Praescriptio* was also the term applied to lapse of time as barring actions upon contracts or torts under various provisions corresponding to the English Statutes of Limitation. The prescription of Roman law (and of modern systems based upon it) is thus both acquisitive and extinctive. It looks either

to the length of time during which the defendant has been in possession, or to the length of time during which the plaintiff has been out of possession. In English law the latter kind of prescription is called limitation. The tendency of law is to substitute a definite for an indefinite period of prescription.

In English law prescription is used in a comparatively narrow sense. It is acquisitive only, and is very limited in its application. A title by prescription can be made only to incorporeal hereditaments—that is, in legal language, hereditaments that are or have been appendant or appurtenant to corporeal hereditaments—and to certain exemptions and privileges.³ The rights claimable by prescription for the most part consist of rights *in alieno solo*. The most important are advowsons, tithes, commons, ways, watercourses, lights, offices, dignities, franchises, pensions, annuities and rents. Land or movables cannot be claimed by prescription. The foundation of prescription is the presumption of law that a person found in undisturbed enjoyment of a right did not come into possession by an unlawful act (see Williams, *Rights of Common*, 3). In the English courts this presumption was, perhaps still is, based upon the fiction of a lost grant, viz. that there had been a grant of the hereditament by a person capable of granting it to a person capable of taking it, and that the grant had been lost. The jury were instructed to find the loss of a once existing grant in whose existence no one really believed. The enjoyment of the right must have been from a time whereof the memory of man runneth not to the contrary. The period of legal memory was after a time necessarily fixed for purposes of convenience at a certain date. The date adopted varied at first with the time during which the demandant in a writ of right must have proved seisin in himself or his ancestors. After one or two previous enactments the date was finally fixed by the Statute of Westminster the First (3 Edw. I. c. 39) at the reign of Richard I., which was interpreted to mean the first year of the reign of Richard I. (1189). The inconvenience of this remote date, as time went on, led to the gradual growth of a rule of evidence that proof of enjoyment for twenty years was *prima facie* evidence of enjoyment from time immemorial. But evidence of the beginning of the enjoyment at however remote a date, if subsequent to 1 Richard I., was sufficient to destroy the claim. This is still the law with respect to claims not falling within the Prescription Act, mostly rights in gross—that is, where there is no dominant or servient tenement, e.g. a right to a pew or to a several fishery in gross. The twenty years' rule was of comparatively late introduction; it does not seem to have been known in the time of Elizabeth, and was perhaps introduced in analogy to the Statute of Limitations, 21 Jac. I. c. 16. With respect to claims of profits *à prendre* and easements a change was made by the Prescription Act 1832 (extended to Ireland by an act of 1858, but not to Scotland). By that act claims to rights of common and other profits *à prendre* are not to be defeated after thirty years' enjoyment by any person claiming right thereto without interruption for thirty years by showing only the commencement of the right, and after sixty years' enjoyment the right is absolute and indefeasible unless had by consent or agreement by deed or writing (§ 1). In claims of rights of way or other easements the periods are twenty years and forty years respectively (§ 2). The before-mentioned periods are to be deemed those next before suits, and nothing is to be deemed to be an interruption unless acquiesced in for one year (§ 4). In pleading, the enjoyment as of right may be alleged during the period mentioned in the act, and without claiming in the name or right of the owner of the fee (§ 5). No presumption is to be made in favour of a right exercised for a less period (§ 6). The time during which a person otherwise capable of resisting a claim is an infant, idiot, *non compos mentis*, *feme covert*, or tenant for life, or during which an action or suit has been pending until abated by the death of a party, is to be excluded in the computation of the periods unless where the right or claim is declared to be absolute and indefeasible (§ 7). An act to define the period of prescription for a *modus decimandi*, or an exemption from tithes by composition, was passed the same year. The Prescription Act is only supplemented to the common law, so that a claim may be based upon the act or, in the alternative, upon the common law. Nor does the act alter the conditions necessary at common law for a good claim by prescription. The claim under the statute must be one which may be lawfully made at common law. The principal rules upon the subject are these. (1) The title is founded upon actual usage. The amount of actual usage and the evidence necessary to prove it vary according to the kind of claim. (2) The enjoyment must (except in the case of light) be as of right—that is to say, peaceable, openly used, and not by licence. (3) The prescription must be certain and reasonable. Inhabitants cannot, however, claim by prescription, as they are an uncertain and fluctuating body, unless under a grant from the Crown, which constitutes them a corporation for the purposes of the grant. (4) The prescription must be alleged in a *que estate* or in a man and his ancestors. Prescription in a

³ Prescription seems at one time to have borne a wider meaning. A claim by prescription to land is mentioned in 32 Hen. VIII. c. 2. And it seems that tenants in common may still make title to land by prescription (Littleton's *Tenures*, § 310).

¹ "Praescriptiones autem appellatas esse ab eo quod ante formula praescribuntur" (Gaius iv. § 132).

² "Viac vicinales, quarum memoria non extat" (Dig. xliii. 7, 3).

que estate lies at common law by reason of continuous and immemorial enjoyment by the claimant, a person seised in fee, and all those whose estate he had (*loux ceux que estate il ad*). The Prescription Act fixes a definite period and does away with the necessity which existed at common law of prescribing in the name of the person seised in fee. Prescription in a man and his ancestors is not of ordinary occurrence in practice. Corporations, however, occasionally claim by a prescription analogous to this, viz. in the corporation and its predecessors. Such claims by either a person or a corporation are not within the Prescription Act, which applies only where there are dominant and servient tenements. By 32 Hen. VIII. c. 2 (1540) no person can make any prescription by the seisin or possession of his ancestor unless such seisin or possession had been within threescore years next before such prescription made. (5) A prescription cannot lie for a thing which cannot be granted, as it rests upon the presumption of a lost grant. Thus a lord of a manor cannot prescribe to raise a tax or toll upon strangers, for such a claim could never have been good by any grant.

Prescription and Custom.—Prescription must be carefully distinguished from custom. Prescription, as has been said, is either in a *que estate* or in a man and his ancestors—that is to say, it is a personal claim; custom is purely local—that is to say, it is a usage obtaining the force of law within a particular district. In the time of Littleton the difference between prescription and custom was not fully recognized (see Littleton's *Tenures*, § 170), but the law as it exists at present had become established by the time of Sir Edward Coke. A custom must be certain, reasonable and exercised as of right. Like prescription at common law, it must have existed from time immemorial. On this ground a custom to erect stalls at statute sessions for hiring servants was held to be bad, because such sessions were introduced by the Statute of Labourers, 23 Edw. III. st. 1 (*Simpson v. Wells*, L.R., 7 Q.B., 214). Some rights may be claimed by custom which cannot be claimed by prescription, e.g. a right of inhabitants to dance on a village green, for such a right is not connected with the enjoyment of land. On the other hand, profits *à prendre* can be claimed by prescription but not by custom, unless in two or three exceptional cases, such as rights of copyholders to common in the lord's demesne, or to dig sand within their tenements, rights to estovers in royal forests, and rights of tinbounders in Cornwall.

United States.—The Law of the United States (except in Louisiana) is based upon that of England, but the period of enjoyment necessary to found a title by prescription varies in the different states. An easement or profit *à prendre* is acquired by twenty years' enjoyment in most states, following the English common law rule. In Louisiana the period varies according to the subject from three to thirty years, and property other than incorporeal hereditaments may be claimed by prescription as in Roman law (see *Ken's Comm.* iii. 442).

International Law uses the term "prescription" in its wider or Roman sense. "The general consent of mankind has established the principle that long and uninterrupted possession by one nation excludes the claim of every other" (*Wheaton, Int. Law*, § 165). Historic instances of rights which were at one time claimed and exercised by prescription as against other nations are the sovereignty of Venice over the Adriatic and of Great Britain over the Narrow Seas, and the right to the Sound dues long exacted by Denmark. But such claims were rejected by the highest authorities on international law (e.g. Grotius), on the ground that they were defective both in *justus titulus* and in *de facto* possession. There is no special period fixed, as in municipal law, for the acquirement of international rights by lapse of time. In private international law prescription is treated as part of the *lex fori* or law of procedure. (J. W.)

Scotland.—In the law of Scotland "prescription" is a term of wider meaning than in England, being used as including both *prescription* and *limitation* of English law. In its most general sense it may be described as the effect which the law attaches to the lapse of time, and it involves the idea of possession held by one person adverse to the rights of another. Though having its basis in the common law, its operation was early defined by statute, and it is now in all respects statutory. Prescription in Scots law may be regarded (1) as a mode of acquiring rights—the positive prescription; (2) as a mode of extinguishing rights—the negative prescription; (3) as a mode of limiting rights of action—the shorter prescriptions. It must, however, be observed with reference to this division that the distinction between (1) and (2) is rather an accidental (due to a loose interpretation of the language of the act of 1617, c. 12) than a logically accurate one. It is, moreover, strictly confined to heritable rights, having no application in the case of movable property. But, though the distinction has been complained of by the highest authority as tending to create embarrassment in the law (see opinion of Lord Chancellor St Leonards in *Dougall v. Dundee Harbour Trustees*, 1852, 24 *Jurist*, 385), it is now too well settled to be departed from.

1. **Positive Prescription.**—The positive prescription was introduced by the act of 1617, c. 12. After setting forth in the preamble the inconvenience resulting from the loss of titles and the danger of forgery after the means of improbation are lost by the lapse of time, it enacts that whatever heritages the lieges, their predecessors or authors have possessed by themselves or others in their names peaceably, in virtue of infeftments for the space of forty years,

continually and together, from the date of their said infeftments, and without any lawful interruption during the said space, they shall not be disturbed therein, provided they produce a written title on which their possession has proceeded. Such written title must be either a charter and sasine preceding the forty years, or, when no charter is extant, instruments of sasine proceeding upon retours or precepts of *clare constat*. Though the statute in its literal construction only applied to such heritable subjects as had been conveyed by charter and sasine, it was at an early date interpreted so as to include other heritable rights, as servitudes, tacks, public rights of way, &c., where no charter could be supposed to exist. The act of 1617 was so well framed that it continued to regulate the prescription of land rights till 1874. By the Conveyancing Act of that year (37 & 38 Vict. c. 94, § 34) the period of prescription was shortened from forty years to twenty. It was provided that possessions for twenty years upon "an *ex facie* valid irredeemable title recorded in the appropriate register of sasines" should in future give the same right as forty years' possessions upon charter and sasine under the earlier law. The act of 1874 does not, however, apply to all the cases which fell under the act of 1617. Thus it has been decided that twenty years' possession on a charter of adjudication followed by sasine and a declarator of expiry of the legal is insufficient to give an unchallengeable right, an adjudication not being an "*ex facie* irredeemable title" (*Hinton v. Connel's Trustees*, 1883, 10 *Rettie's Reports*, p. 1110). It is further specially provided by the act of 1874 that the twenty years' prescription is not to apply to servitudes, rights of way, and public rights generally. The following rules apply to the positive prescription. (a) The possession which is required for it must be peaceable, continuous ("continually and together," as the act of 1617 has it), and uninterrupted. (b) The prescription runs *de momento in momentum*. (c) The person against whom the prescription runs must be major and *sui juris*—a rule which, as regards minority, was specially provided for by the act of 1617, and as regards other cases of incapacity by the application of the principles of the common law. Under the Conveyancing Act, however, it is provided that in all cases where the twenty years' prescription applies, the lapse of thirty years is to exclude any plea on the ground of minority or want of capacity.

2. **Negative Prescription.**—This prescription was introduced by the act of 1469, c. 28, and substantially re-enacted by the act of 1474, c. 55. At first restricted to personal claims of debt, it was gradually extended in practice and ultimately made applicable to heritable bonds and other heritable rights by the above-mentioned act of 1617. By the act of 1469 it is declared that the person having interest in an obligation must follow the same within the space of forty years and take document thereupon, otherwise it shall be prescribed. The negative prescription accordingly extinguishes *in toto* the right to demand performance of an obligation after forty years, the years being reckoned from the day on which fulfilment of the obligation can be first demanded. The lapse of this period of time creates a conclusive presumption—one incapable of being redargued—that the debt or obligation has been paid or fulfilled. But it must be kept in view that the negative prescription does not *per se*—without the operation of the positive—establish a right to heritable property (*Erskine, Inst. b. iii. tit. 7, § 8*). As regards the character of the prescription, it is requisite, in the same way as in the case of the positive, that the years shall have run continuously and without interruption, *i.e.* without any act done on the part of the creditor which indicates his intention to keep alive the right. Such interruption may, for instance, take place by the payment of interest on the debt, or citation of the debtor in an action for the debt, or by a claim being lodged in the debtor's sequestration. In the same way as in the positive, the currency of the negative prescription is suspended by the debtor being minor or *non valens agere*.

3. **Shorter Prescriptions.**—There are certain short prescriptions recognized by Scots law—corresponding to the limitations of English law—which operate not as extinguishing rights but as excluding the ordinary means of proving them. The following require to be noticed. (a) Vicennial prescription protecting a person who has been served as heir for twenty years against action by any other person claiming to be heir. (b) Decennial prescription requiring all actions by minors against their tutors and curators, and vice versa, to be prosecuted within ten years from the expiration of the guardianship. (c) Septennial prescription providing that no person bind himself, under certain exceptions, for and with another, conjunctly and severally, in any bond or contract for sums of money shall be bound for more than seven years after the date of the obligation. There are also other shorter prescriptions limiting rights of action in different matters as the sexennial, quinquennial and triennial.

PRESENT, an adjective, adverb and substantive meaning that which is at hand or before one in place or in time. Also another substantive meaning a gift, and a verb meaning to bring into the presence of, to offer, to deliver. The verb is pronounced *présent*; the others *présent*. The first group is due to the Latin *praesens*, the present participle of *praesesse*, to be before one or at hand; from this participle was formed the verb *praesentare*, to bring before one, exhibit, show. The sense of "gift" is due to

the O. Fr. phrase *mettre en présent à quelqu'un*, to bring something into the presence of a person, to offer, give. The legal formal phrase "these presents" is common, especially in the form "know all men by these presents," as an opening to a deed, more particularly to a deed-poll which cannot be referred to as an "indenture." The phrase "these present words, documents, writings," &c. is an adaptation of a similar phrase in O. Fr. *ces presentes (sc. lettres)*. As ecclesiastical terms "to present" or "presentation" are used of the "presenting" or nomination by the patron to the bishop of the person chosen by him to fill a vacant benefice. When the bishop is patron he does not "present," but "collates." "Presentiment," foreboding, the feeling of something impending, must be distinguished in etymology; it is derived from the Lat. *praesentire*, to perceive beforehand.

PRESENTATIONISM (from Lat. *prae-esse, praesens*, present), a philosophical term used in various senses deriving from the general sense of the term "presentation." According to G. F. Stout (cf. *Manual of Psychology*, i. 57), presentations are "whatever constituents or our total experience at any moment directly determine the nature of the object as it is perceived or thought of at that moment." In Baldwin's *Dictionary of Philosophy*, vol. ii., a presentation is "an object in the special form under which it is cognized at any given moment of perceptual or ideational process." This, the widest definition of the term, due largely to Professor James Ward, thus includes both perceptual and ideational processes. The term has, indeed, been narrowed so as to include ideation, the correlative "representation" being utilized for ideal presentation, but in general the wider use is preferred. When the mind is cognizing an object, the object "presents" itself to the senses or to thought in one of a number of different forms (e.g. a picture is a work of art, a saleable commodity, a representation of a house, &c.). Presentation is thus essentially a cognitive process. Hence the most important use of the term "presentationism," which is defined by Ward, in *Mind*, N.S. (1893), ii. 58, as "a doctrine the gist of which is that all the elements of psychical life are primarily and ultimately cognitive elements." This use takes precedence of two others: (1) that of Hamilton, for presentative as opposed to representative theories of knowledge, and (2) that of some later writers who took it as equivalent to phenomenon (*q.v.*). Ward traces the doctrine in his sense to Hume, to whom the mind is a "kind of theatre" in which perceptions appear and vanish continually (see Green and Grose edition of the *Treatise*, i. 534). The main problem is as to whether psychic activity is "presented" or not. Ward holds that it is not presented or presentable save indirectly.

For the problems connected with Presentation and Presentationism see especially the article **PSYCHOLOGY** and authorities there quoted.

PRESIDENCY, an administrative unit of the Indian empire. The word is derived from the title of president or chief of the council of a principal factory under the early East India Company—a title which lasted until governors were appointed under act of parliament in 1784. It thence came to be applied to the three original provinces of Bengal, Madras, and Bombay. It is now restricted to Madras and Bombay, in distinction to the lieutenant-governorships. In Anglo-Indian usage, "presidency" was also applied to the capital city as opposed to the country beyond, termed the "mofussil"; and this usage lingers in such phrases as "presidency town," "presidency magistrate," and "presidency college."

PRESIDENT (Fr. *président*, from Lat. *praesidens*, post-Augustan Lat. for *praeses*, director, ruler, from *praesidere*, to sit in front of, preside), a style or title of various connotation, but always conveying the sense of one who presides. In classical Latin the title *praeses*, or president, was given to all governors of provinces, but was confined in the time of Diocletian to the procurators who, as lieutenants of the emperor, governed the smaller provinces. In this sense it survived in the middle ages. Du Cange gives instances from the capitularies of Charlemagne of the style *praeses provinciae* as applied to the count; and later

examples of *praeses*, or *praesidens*, as used of royal seneschals and other officials having jurisdiction under the Crown.

In England the word survived late in this sense of royal lieutenant. Thus, John Cowell, in his *Interpreter of Words* (1607) defines "President" as "used in Common Law for the King's lieutenant in any province or function; as President of Wales, of York, of Berwick. President of the King's Council." In some of the British North American colonies (New Hampshire, Pennsylvania, South Carolina) there was a president of the council, usually elected by the council; and when Pennsylvania and New Hampshire became states, one member of the Executive Council was called president. The chief (and single) executive head in Delaware, South Carolina and New Hampshire (1784–1792) was called president.

During the revolutionary struggle in America from 1774 onwards, the presiding officer of the Continental Congress was styled "President" and when the present constitution of the United States was framed in 1787 (in effect 1789) the title of President was transferred to the head of the Federal government. "President" thus became the accepted style for the elected chief of a modern republic, the example of the United States being followed by the South American republics, by France in 1849, and by Switzerland.

In the simple sense of "one who presides" the word "president" preserved its meaning alongside the technical use implying royal delegation. In this sense the *New English Dictionary* quotes its use by Chaucer (*Troilus*, iv. 185) in 1374. In ecclesiastical terminology *praesidens* was sometimes used for the head of cathedral chapters, instead of dean or provost; and it was sometimes the title given to the principal visitor of monasteries, notably in the reformed congregation of Cluny (Du Cange). In the United Kingdom the heads of many colleges are styled "president," the title being of considerable antiquity in the case of one college at Cambridge (Queens', founded in 1448) and four at Oxford (St John's, Magdalen, Corpus Christi, Trinity). At five Cambridge colleges (Pembroke, Gonville and Caius, St Catherine's, St John's, Magdalene) the title "president" is borne by the *second* in authority, being the equivalent of "vice-master." In the United States "president" is the usual style of the head of a college and also of a university wherever this has developed out of a single college. "President" is also the style of persons elected to preside over the meetings of learned, scientific, literary and artistic academies and societies, e.g. the president of the Royal Academy (P.R.A.) in London; the title of the president of the Royal Society (P.R.S.) dates from its foundation in 1660. In the United States the style "president" is also given to the person who presides over the proceedings of financial, commercial and industrial corporations (banks, railways, &c.), in Great Britain usually styled "chairman," but in the case of the Bank of England and certain other banks "governor."

In Great Britain the title "president" is also borne by certain ministers of the Crown and certain judges, and preserves some of the ancient connotation of a royal lieutenancy explained above. Thus the style of "president" applied to the heads of the board of agriculture, local government board, board of education, board of trade, &c., which are all committees of the privy council, is derived from that of the lord president of the council, the representative of the king. The presidents of the court of session in Scotland, and of the probate and divorce division, &c. in England, also bear this style ultimately as representatives of the Crown.

In France, besides the president of the republic, there are presidents of the senate and of the chamber of deputies. In Germany the word *Präsident* is used in most of the English senses of "president," e.g. of a corporation, society, assembly or political body. As a judicial title *Präsident* is confined to the head of any one of the corporations (*Kollegien*) on the basis of which the judicial system of the empire is organized (*Landgericht, Oberlandesgericht, Reichsgericht*), and must be distinguished from that of *Vorsitzender* (literally also *praesidens*), i.e. the judge (who may or may not be the *Präsident*) selected to preside over a division of the court appointed to try particular cases.

In Prussia *Präsident* also retains its old sense of "governor," *Oberpräsident* being the title of the chief of the administration of a province, *Präsident* that of the head of a government district (*Regierungsbezirk*). The consistories of the established Protestant Church are also presided over by a *Präsident*, who is a royal official.

PRESS (through Fr. *presse* from Lat. *pressare*, frequentative of *premere*, to crush, squeeze, press), a word which appears in English in the 13th and 14th centuries with three particular

¹The style "president" was in every case exchanged for that of "governor" within a few years of the proclamation of the independence of the United States. The title "president" is no longer used for any governor under the British Crown, but relics of past usage survive in the "presidencies" of Madras and Bombay.

meanings, viz. (1) crowd or throng, often used of the *mêlée* in a battle, (2) a shelved cupboard for books or clothes, and (3) an apparatus for exerting pressure on various substances, and for various purposes. The first meaning is still current, though usually it has a literary air; a specific use is the nautical one of "press of sail," i.e. as much sail as the wind will allow; cf. the similar use of "crowd." The second use has given way to other words, but is still the technical term in use in libraries, where the books bear "press-marks" specifying the case or shelf where they may be found. As a term for a machine or apparatus for exerting pressure, there are innumerable examples, usually with a qualifying word giving the purpose for which the pressure is applied, either for attaining compression into a small space, or a required shape, or for extracting juices or liquids, or the methods adopted for exerting the pressure. The printing-press has given rise to obvious transferred uses of the word "press": thus it is applied to an establishment for printing, e.g. the Clarendon Press, at Oxford, or the Pitt Press, at Cambridge, to a printing-house and to the staff which conduct the business, to the issue of printed matter and especially to its daily or periodical issue, hence newspapers and periodicals generally. According to the *New English Dictionary* this use originated in phrases such as "the liberty of the press," "to write for the press," &c. The earliest quotation given is from the first number of the *Dublin Press*, 1797. For the history of the liberty or freedom of the press see PRESS LAWS; also NEWSPAPERS and PERIODICALS. For the punishment of "pressing" see PEINE FORTE ET DURE. It is now recognized that "press" in "press gang," "to press," i.e. to force or compulsorily enlist men for naval or military service, is a word distinct from the above. It stands for the earlier "prest," and is ultimately due to French *prêter*, to lend (see IMPRESSMENT).

PRESSBURG (Hung. *Pozsony*, Lat. *Posonium*), a town of Hungary, capital of the county of the same name, 133 m. N.W. of Budapest by rail. Pop. (1900), 61,537, about half of whom are Germans. Pressburg is picturesquely situated on the left bank of the Danube, at the base of the outlying spurs of the Little Carpathians, in a position of strategic importance near the *Porta Hungarica*. Pressburg was the capital of Hungary from 1541 until 1784, while the Hungarian parliament held its sittings here till 1848. One of the most conspicuous buildings of the town is the royal palace, situated on the Schlossberg, a plateau 270 ft. above the Danube, which was destroyed by fire in 1811 and has since been in ruins. Other noteworthy buildings are the cathedral, a Gothic edifice of the 13th century, restored in 1861-1880, in which many of the Hungarian kings were crowned; the town hall, also a 13th-century building, several times restored, and containing an interesting museum; the Franciscan church, dating from 1272; and the law-courts, erected in 1783, where the sittings of parliament were held from 1802 to 1848. The Grassalkowitch palace is now the residence of an archduke, and there is an archiepiscopal palace. Educational establishments include an academy of jurisprudence, a military academy, a Roman Catholic and a Protestant seminary, a training school for female teachers, and several secondary and technical schools. A large business is carried on in wooden furniture, tobacco and cigars, paper, ribbons, leather wares, chemicals, liqueurs, confectionery and biscuits. There is, besides, a dynamite factory, which produces over 2,000,000 lb of explosives annually, a large cloth factory and several flour-mills. Trade in grain and wine is active. Besides the extensive traffic on the Danube, the town is also an important railway junction. The first railway line in Hungary was that from Pressburg to Tyrnau through the valley of the Waag. The town has many points of interest in its environs. About twenty-five minutes by steamer down the Danube, the extensive ruins of the castle of Theben (Hung. *Dévény*), the former gate of Hungary, are situated at the point where the March, which forms the boundary between Austria and Hungary, falls into the Danube. Opposite on the left bank is Hainburg, the gateway of Hungary from the Austrian side. Eastward and southward of Pressburg stretches a long and fertile plain,

known as the Upper or Little Hungarian plain. It has an area of 2825 sq. m., of which two-thirds lay on the right bank of the Danube, and the whole is bounded by the rivers Neutra and Raab. In the extreme south-west of this plain is situated the lake of Fertő-Tava (Ger. *Neusiedler See*), which has an area of about 100 sq. m., but it is of varying size, and sometimes dries up in part. Eastward it is united with the extensive marsh called the Hanság, through which it is in communication with the river Raab and with the Danube. In the Roman period it was known as *Peiso* or *Pelso*. In several places of the dry bed traces of prehistoric lake-dwellings have been discovered. In conjunction with the regulation of the river Raab, and the drainage of the Hanság marsh, plans for the drainage of the lake have been proposed.

Little is known of the early history of Pressburg, which was founded about 1000. It was soon strongly fortified, though it was captured by the king of Bohemia, Ottakar II., in 1271. It received many privileges from the Hungarian kings, especially from the emperor Sigismund, and its strategic situation made it an important fortress. Sigismund held Imperial diets in the town. After the battle of Mohacs in 1526 and the capture of Buda by the Turks, Pressburg became the capital of Hungary. Here in 1608 the Austrian and Hungarian malcontents concluded a treaty with the archduke Matthias, afterwards emperor, against their lawful sovereign, the emperor Rudolf II. In 1610 the town was taken by Bethlen Gabor, but it was recovered by the Imperialists in 1621. In 1687 it was the scene of the session of the estates of Hungary during which the Hungarians renounced their right of choosing their own king and accepted the hereditary succession of the Habsburgs. Here also was held the diet of 1741 when the members swore to assist their sovereign, Maria Theresa, against Frederick the Great. In 1784 Buda took the place of Pressburg as the capital of Hungary, but the latter town continued to be the seat of the parliament until 1848. On the 26th of December 1805 peace was signed here between Napoleon and the emperor Francis I., and in 1809 the town was bombarded by the French.

See J. Kiraly, *Geschichte des Donau-Mauth- und Urfahr-Rechts der Freistadt Pressburg* (Pressburg, 1890); T. Ortway, *Geschichte der Stadt Pressburg* (Pressburg, 1892), and *Pressburgs Strassen und Plätze* (Pressburg, 1905).

PRESSENSÉ, EDMOND DEHAULT DE (1824-1891), French Protestant divine, was born at Paris on the 7th of January 1824. He studied at Lausanne under Alexander Vinet, and at Halle and Berlin under F. A. G. Tholuck and J. A. W. Neander, and in 1847 became pastor in the Evangelical Free Church at the chapel of Taitbout in Paris. He was a powerful preacher and a good political speaker; from 1871 he was a member of the National Assembly, and from 1883 a senator. In 1890 he was elected a member of the Academy of Sciences. Pressensé laboured for the revival of biblical studies. He contended that the Evangelical Church ought to be independent of the power of the state. He died on the 8th of April 1891.

He founded in 1854 the *Revue chrétienne*, and in 1866 the *Bulletin théologique*. His works include: *Histoire des trois premiers siècles de l'église chrétienne* (6 vols. 1856-1877; new ed. 1887-1889), *L'Église et la révolution française* (1864; 3rd ed., 1889), *Jésus-Christ, son temps, sa vie, son œuvre* (against E. Renan, 1866; 7th ed. 1884), *Les Origines, le problème de la connaissance; le problème cosmologique* (1883; 2nd ed. 1887). See T. Roussel, *Notice sur la vie et les œuvres de Pressensé* (1894).

PRESS GANG, the popular name for the companies of officers and men who were commissioned to execute the warrants for the impressment of seamen in Great Britain (see IMPRESSMENT). These bodies consisted of a captain, one or more lieutenants, and a band of trustworthy men. They were sent to seaports, or occasionally to inland towns where sailors were likely to be met when going from one coast to another. A "rendezvous" was opened, volunteers were enlisted, deserters arrested, and such "able bodied persons" as were liable to be pressed for service in the fleet were seized, and sent to the *guard ships* (q.v.).

PRESS LAWS, the laws concerning the licensing of books and the liberty of expression in all products of the printing-press,

especially newspapers. The liberty of the press has always been regarded by modern political writers as of supreme importance. "Give me liberty to know, to utter, and to argue freely according to conscience, above all other liberties," says Milton in the *Areopagitica*.

At the present day the liberty of the press in English-speaking countries is a matter of merely historical importance. But this liberty was a plant of slow growth. Before the invention of printing the Church assumed the right to control the expression of all opinion distasteful to her. When the printing-press was invented German printers established themselves at various important centres of western Europe, where already numbers of copyists were employed in multiplying manuscripts. In 1473 Louis XI. granted letters patent (giving the right of printing and selling books) to "Uldaric Quéring" (Ulrich Gering), who three years earlier had set up a press in the Sorbonne (the theological faculty of the university at Paris), and before long Paris had more than fifty presses at work. The Church and universities soon found the output of books beyond their control. In 1496 Pope Alexander VI. began to be restive, and in 1501 he issued a bull against unlicensed printing, which introduced the principle of censorship.¹ Between 1524 and 1548 the Imperial Diet in Germany drew up various stringent regulations; and in 1535 Francis I., in France, prohibited by edict, under penalty of death, the printing of books. This was too severe, however, and shortly afterwards the Sorbonne was given the right of deciding, a system which lasted to the Revolution.

In England the authority of parliament was invoked to aid the ecclesiastical authority. There is an ordinance as early as 1382, 5 Ric. II. st. 2, c. 5 (not assented to by the Commons, but appearing upon the parliament roll), directed against unlicensed preachers. After the invention of printing the ecclesiastical censorship was still asserted, but only as collateral with the censorial rights of the Crown, claimed by virtue of its general prerogative. After the Reformation the greater part of the rights of censorship passed to the Crown, which at the same time assumed the power of granting by letters patent the right of printing or selling books as a monopoly. The grant, if made to the author himself, was an equivalent of copyright; if made to a person other than the author, it seems to have always been subject to the author's copyright as it existed at common law.

Censorship was either restrictive or corrective, *i.e.* it interfered to restrict or prevent publication, or it enforced penalties after publication. Repression of free discussion was regarded as so necessary a part of government that Sir Thomas More in his *Utopia* makes it punishable with death for a private individual to criticize the conduct of the ruling power. Under Mary printing was confined to members of the Stationers' Company, founded by royal charter in 1556. Under Elizabeth the Star Chamber assumed the right to confine printing to London, Oxford and Cambridge, to limit the number of printers and presses, to prohibit all publications issued without proper licence, and to enter houses to search for unlicensed presses and publications (Order of 1585, Strype's *Whitgift*, app. 94). The search for unlicensed presses or publications was entrusted to an officer called the "messenger of the press." In 1637 was issued an order of the Star Chamber forbidding the importation of books printed abroad to the scandal of religion or the

¹ The principle of the censorship is still uncompromisingly maintained by the Roman Catholic Church; and this, though in general binding only in *foro conscientiae*, has necessarily had considerable importance in states which recognize the papacy as an independent power relations with which are established by concordat. Thus in Italy, under the Sardinian constitution of 1848, Bibles, catechisms and liturgical words had to be licensed by the bishop. The principle of the censorship, consecrated anew in Pope Pius IX.'s *Syllabus* of 1864, was reaffirmed in the apostolic constitution *Officiorum* of Leo XIII. and in 1907 in the encyclical *Pascendi* of Pius X. This last expresses "the highest esteem for this institution of censors" and orders censors to be appointed in all episcopal curias for the revision of books intended for publication, at the same time directing that their names shall not be made known to the authors of the books condemned. (See also INDEX LIBRORUM PROHIBITORUM.)

Church or the government, and the printing of any book not first lawfully licensed. Law books were to be licensed by one of the chief justices or the chief baron, books of history and state affairs by one of the secretaries of state, of heraldry by the earl marshal, of divinity, philosophy, poetry and other subjects by the archbishop of Canterbury or the bishop of London, or the chancellors or vice-chancellors of the universities. There were to be only twenty master printers and four letter-founders. The punishment was at the discretion of the court (Rushworth, *Historical Collections*, vol. iii. app. 306). The same principle of press restriction was carried out by the Long Parliament after the abolition of the Star Chamber, and it was an ordinance of that body issued in 1643 that called forth Milton's *Areopagitica*, a *Speech for the Liberty of Unlicensed Printing*, itself an unlicensed book. The parliament appointed committees for printing, who appointed licensers, but the licensing was really left in a great measure to the wardens of the Stationers' Company. At the Restoration Sir John Birkenhead acted as licenser, appointed apparently under the general prerogative. It was, no doubt, too, under the general prerogative that Charles II., by a proclamation in 1660, called in and suppressed Milton's *Defensio pro populo anglicano*. Then followed the Licensing Act of 1662 (13 & 14 Car. II. c. 33), limited to two years. The provisions as to importation of books, the appointment of licensers, and the number of printers and founders were practically re-enactments of the similar provisions in the Star Chamber order of 1637. Printing presses were not to be set up without notice to the Stationers' Company. A king's messenger had power by warrant of the king or a secretary of state to enter and search for unlicensed presses and printing. Severe penalties by fine and imprisonment were denounced against offenders. The act was successively renewed up to 1679. Under the powers of the act Sir Roger L'Estrange was appointed licenser, and the effect of the supervision was that practically the newspaper press was reduced to the *London Gazette*. The objections made to lines 594-599 of the first book of *Paradise Lost* by the archbishop of Canterbury's chaplain, acting as licenser, are well known. The act expired in 1679, and for the remainder of the reign of Charles II., as in the reign of George III., the restrictions on the press took the form of prosecutions for libel. In 1685 the Licensing Act was renewed for seven years (1 Jac. II. c. 8, § 15). No mention of the liberty of the press was made in the Bill of Rights. On the expiration of the Licensing Act in 1692 it was continued till the end of the existing session of parliament (4 & 5 Will. and Mary, c. 24, § 14). In 1695 the Commons refused to renew it. The immediate effect of this was to lay authors open to the attacks of literary piracy, and in 1709 the first Copyright Act (8 Anne, c. 19) was enacted for their protection. The power of a secretary of state to issue a warrant, whether general or special, for the purpose of searching for and seizing the author of a libel or the libellous papers themselves—a power exercised by the Star Chamber and confirmed by the Licensing Act—was still asserted, and was not finally declared illegal until the case of *Entick v. Carrington* in 1765 (*St. Tr.* xix. 1030). In 1776 the House of Commons came to a resolution in accordance with this decision. The compulsory stamp duty on newspapers was abandoned in 1855 (18 Vict. c. 27), the duty on paper in 1861 (24 Vict. c. 20), the optional duty on newspapers in 1870 (33 & 34 Vict. c. 38). From that time the English press may be said to date its complete freedom, which rests rather upon a constitutional than a legal foundation. It is not confirmed by any provision of the supreme legislative authority, as is the case in many countries. A declaration in favour of the liberty of the press is usually a prominent feature in the written constitutions of foreign states.

The few existing restrictions on the liberty of the press are presumed to be imposed for the public benefit. They are in some cases of great historical interest. The rights of private persons are in general sufficiently protected in one direction by the law of Libel (*q.v.*), in another by the law of Copyright (*q.v.*), while the criminal law provides for the cases of press offences against morality, public justice, &c. Thus the courts have power to punish summarily as a contempt the publication of comments upon proceedings *sub judice*

or reflections upon the conduct of judicial officers. (See CONTEMPT OF COURT.) The last relic of the censorship before publication is to be found in the licensing of stage plays. By 6 & 7 Vict. c. 68 no new plays or additions to old plays can be acted for hire at any theatre in Great Britain until they have been submitted to the lord chamberlain, who may forbid any play or any part of a play. The penalty for acting a play before it has been allowed or after it has been disallowed is a sum not exceeding £50 for every offence and the forfeiture of the licence of the theatre in which the offence occurred. This jurisdiction is exercised by an official of the lord chamberlain's department called the "examiner of stage plays." The last relic of the monopoly of printing formerly granted to licensees of the Crown is found in the exclusive right of the king's printer and the universities of Oxford and Cambridge to print the Bible¹ and the Book of Common Prayer, and of the king's printer to print acts of parliament and other state documents. The privileges of the universities are confirmed by 13 Eliz. c. 29. The rights of the king's printer are protected by severe penalties. A maximum term of seven years' penal servitude is incurred by any person who prints any act of parliament or other government document, falsely purporting to be printed by the king's printer or under the authority of His Majesty's stationery office (8 & 9 Vict. c. 113; 45 Vict. c. 9). The rights of the printers of the journals of either house of parliament are protected by 8 & 9 Vict. c. 113. The publication of parliamentary debates in any form by any other persons than the printers of the journals of the two houses is still in theory a breach of privilege, but in practice they have been fully reported since 1771. The other restrictions upon the press are to a great extent those imposed for police purposes. By 32 & 33 Vict. c. 24 (confirming in part previous enactments applying to Great Britain) the printer of any paper or book for profit is required under penalties to print thereon his name and address or the name of a university press, and is to keep a copy of everything printed, with a few exceptions. Penalties must be sued for within three months, and no proceeding for penalties can be begun unless in the name of the attorney-general or solicitor-general of England or the lord advocate of Scotland. By the Newspaper Libel and Registration Act 1881 (44 & 45 Vict. c. 60), which applies to England and Ireland, but not to Scotland, newspaper proprietors are, except in the case of joint-stock companies, to be registered and to make annual returns of the title of the newspaper and the names of all the proprietors, with their occupations, places of business and places of residence. By the Corrupt Practices Prevention Acts 1883 and 1884 (46 & 47 Vict. c. 51, § 18, and 47 & 48 Vict. c. 70, § 14), the name and address of the printer must be printed on all bills, placards, &c., referring to a parliamentary or municipal election. By 6 & 7 Vict. c. 68, § 7, the name and place of abode of a manager of a theatre are to be printed on every play-bill announcing a representation at such theatre. Offences against decency by the press are provided for by 20 & 21 Vict. c. 83; 25 & 26 Vict. c. 101, § 251 (for Scotland), and 2 & 3 Vict. c. 47, § 54 (for the metropolis). The importation of obscene literature into the United Kingdom is forbidden by 39 & 40 Vict. c. 36, § 42. By the Larceny Act 1861, any person who prints or publishes an advertisement offering a reward for the return of stolen goods without questions asked is subject to a penalty (24 & 25 Vict. c. 96, § 102). This penalty cannot, however, be sued for without the sanction of the attorney-general or solicitor-general of England or Ireland (33 & 34 Vict. c. 65). The advertisement in the United Kingdom of foreign or illegal lotteries is prohibited by 6 & 7 Will. IV. c. 66, betting advertisements by 16 & 17 Vict. c. 119, § 7, and 37 Vict. c. 15.

The right of an author or publisher to the full profits of his undertaking was at one time restricted by the Copyright Act of Anne (8 Anne, c. 19, § 4), by which the archbishop of Canterbury and other authorities were empowered to lower the price of a book upon complaint that the price was unreasonable. The only restriction of the kind now existing is the obligation of delivering (without request) to the British Museum a copy of any work published within the United Kingdom, and of delivering (on request) copies for the use of the university libraries at Oxford and Cambridge, the library of the faculty of advocates at Edinburgh, and the library of Trinity College, Dublin (5 & 6 Vict. c. 45, §§ 6-10).

Scotland.—Printing became, as in England, a royal monopoly. The exclusive right of printing was granted by James IV. to Walter Chepman, who printed the first book in Scotland. The monopoly of printing acts of the Scottish parliament was granted by James V. to the printer chosen by the clerk register and specially licensed by the king (1540, c. 127). Printers are forbidden by 1551, c. 27, to print, whether in Latin or English, without licence from ordinaries deputed in that behalf by the Crown. No book treating of religion or of the kirk was to be printed without a licence from the general assembly (1646, c. 164), or of the kingdom without a licence from one of the judges or the secretary (c. 165). The council were empowered to prohibit presses at their discretion by the order of the 30th of March 1655. The importation of "famous" books and libels in defence of the pope was prohibited by 1581, c. 106. Press

offences were treated with the utmost severity. By 1585, c. 1, the author of a libellous writing against the king was punishable with death. It is scarcely necessary to say that since the union the press of Scotland has enjoyed no less liberty than that of England.

In the case of Bibles, Old and New Testaments, Psalm Books, the Book of Common Prayer, the Confession of Faith, and the Larger and Shorter Catechisms a licence for printing is still required. The licensing authority is the lord advocate, but all proposed publications are submitted for approval to the body officially known as "His Majesty's sole and only Master Printers in Scotland," consisting of the lord advocate, the solicitor-general, the moderator of the general assembly, and four other members. A licence is also required for printing acts of parliament; but a general licence granted in 1848 to a firm of printers in Edinburgh is still operative, and their publications are not submitted for approval. As its work is practically confined to Bibles and the other religious publications enumerated, the above-mentioned body commonly receives the name of the Bible Board.

Ireland.—By the Prevention of Crime Act 1882 (45 & 46 Vict. c. 25), the lord-lieutenant was empowered to order the seizure of any newspaper appearing to contain matter inciting to the commission of treason or of any act of violence or intimidation (§ 13). He may also by warrant direct the search for and seizure of any papers or documents suspected to be used or to be intended to be used for the purpose of or in connexion with any secret society existing for criminal purposes (§ 14).

The British Dominions.—In the British colonies the press is as free as it is in England. Each colony has its special legislation on the subject for police and revenue purposes. Where there is a government printer, his monopoly is protected by the Documentary Evidence Act 1868 (31 & 32 Vict. c. 37), which imposes a maximum penalty of five years' penal servitude upon any person printing a copy of any proclamation, order, or regulation which falsely purports to have been printed by the government printer, or to be printed under the authority of the legislature of any British colony or possession. The act is, however, subject to any law made by the colonial legislature.

India.—During the governor-generalship of Lord Lytton was passed the "Act for the better control of publications in Oriental languages," Act ix. of 1878. (1) By this act copies of newspapers published out of British India were liable to forfeiture and seizure by warrant throughout the whole of British India if the papers contained any words, signs or visible representations likely to excite disaffection to the government established by law in British India, or antipathy between any persons of different races, castes, religions or sects in British India. The governor-general might by notification in the *Gazette of India*, exclude newspapers, books, &c., from British India. (2) In places to which the act was extended by order of the governor-general in council a magistrate might require the printer and publisher of a newspaper to enter into a bond, with a deposit, not to publish a newspaper containing "any words, signs," &c. (as in 1), or to use or attempt to use it for the purpose of extortion or threat. The consequences of offending were forfeiture of the deposit, papers, press, &c. Books used for the illegal purposes above mentioned were subject to forfeiture, but no bond or deposit was required previous to publication of books, as in the case of newspapers.

This act, which remained in force until 1910, was found, owing principally to the restriction of its operation to newspapers published in the vernacular, to be ineffective in coping with the spread of news sheets exciting disaffection amongst the natives towards the government of India. It was consequently repealed and replaced by an act of February 1910, which applies to all newspapers published after the act. The deposit requiring to be made is now obligatory on all new printing-presses, whether issuing a newspaper or not, and independently of the deposit on the newspaper. The requirement of a formal bond has been abolished. There are provisions for forfeiture of the deposit and confiscation of the press on repetition of the offence. The 1910 act gives power to the authorities to open postal packets, other than letters, suspected of containing seditious matter, and requires the printer of a newspaper to deposit with the government two copies of each issue at the time of publication. It includes a long list of offences incitement to which is punishable under the act, and in giving power to stop a seditious newspaper after conviction, and in fixing responsibility on the actual printers of seditious matter, has considerably strengthened the power of the law.

Egypt.—The press is subject to a special law (The Press Law of 1881) and to certain articles of the penal code which define press offences and prescribe penalties (both fine and imprisonment) for them. Owing to the capitulations, which are in force in Egypt as part of the Ottoman Empire, the penal code cannot be applied to foreign subjects, and its application had not (up to 1910) been found sufficient to repress abuses. The probable result of strengthening the law would be that conductors of native papers desirous of indulging in violent language or sedition would engage a foreign subject as nominal proprietor or editor and thereby escape local jurisdiction. The Press Law of 1881 is a more powerful instrument than the penal code, inasmuch as there are decisions of the mixed

¹ The monopoly of the king's printer does not extend to any translation other than the Authorized Version, and not to that if it be accompanied by new notes or marginal readings.

tribunals that that law is, in principle, applicable to foreigners. By this law registration of newspapers is obligatory, and the government has power of control, defined in art. 13 as follows: "In the interests of public order, of religion or of morality, every newspaper or periodical can be suspended or suppressed by order of the minister of the interior after two warnings, or, without previous warning, by a decision of the council of ministers. Each warning may be accompanied by a fine of from £5 to £20." If a newspaper or periodical which has been suppressed continues to appear, the responsible parties can be fined, and the printing-press which issues the suppressed publication can be closed by order of the minister of the interior. The closure or seizure of the printing-press would, however, in the case of a foreigner require the co-operation of his consul.

This law was from about 1900 allowed to fall into disuse. Owing to the excesses of the Arabic newspapers the law was revived in the early part of 1909, but was applied with great moderation. During the year two native papers were warned and one was suppressed. The tribunals remained alone competent to inflict any penalty (apart from suppression and seizure of the printing-press) more severe than a fine of £20, and in 1909 under the penal code the editor of one native paper was sentenced to a year's imprisonment and the editor of another to three months' imprisonment. (See Sir Eldon Gorst's reports on Egypt for 1908 and 1909, specially *Egypt No. 1, 1909*, pp. 3-5.)

The United States.—The first constitutions of Pennsylvania, Delaware, Maryland and North Carolina, enacted in 1776, are interesting as containing the earliest declarations of any legislative authority in favour of the liberty of the press. The same principle was afterwards adopted in the constitution of the United States. The acts of Congress dealing with the press are not numerous, as each state has for the most part its own legislation on the subject, dealing generally with, among other matters, the registration of newspapers, the monopoly of the state printer, and the right of giving the truth in evidence in defence to proceedings for libel. The act of the 18th of August 1856 forbids diplomatic or consular officers of the United States to correspond with any foreign newspaper in regard to the affairs of a foreign state. The act of the 3rd of March 1873 prohibits the printing and circulation of obscene literature. Legislation by Congress has provided that all printing (unless otherwise ordered by law) for the Senate and House of Representatives and the executive and judicial departments, shall be done by the government printer.

Austria-Hungary.—In the Austrian Empire, which from 1804 to 1867 embraced Hungary also, the press laws under Metternich's régime were extremely severe. By the penal code of 1808 all printing had to be licensed, under heavy penalties, and in 1810 two censors were appointed. In short, the press had no shadow of liberty. During the revolution of 1848-1849 the principle of the freedom of the press was established, but the censorship was restored in 1852 and not abolished until 1863. The actual press laws of Austria are based on the press law of the 17th of December 1862 as modified by later supplementary enactments. In principle the freedom of the press was secured by art. 13 of the constitution of the 21st of December 1867. In practice, however, it was still restricted by the obligation on newspaper proprietors to deposit "caution money" (*Kautionszwang*) with the authorities, and the retention of the government stamp on newspapers. The caution money was abolished by a press law of the 9th of July 1894, and the stamp by that of the 27th of December 1899. The police, however, still have the right, either on their own initiative or under the instructions of the public prosecutor (*Staatsanwalt*), "provisionally" to confiscate printed matter which in their opinion offends against the terms of the press law or is contrary to the public interest. The public prosecutor has, within eight days, to justify this action in court, either by proceeding against those responsible for the publication, or by proving the published matter is offensive and ought to be suppressed. This latter "objective" procedure (*objektives Verfahren*) is peculiar to Austria and obviously places vast powers of control in the hands of the authorities. In 1902 the government introduced a bill greatly modifying these and other provisions of the press law in a liberal sense, but the bill was postponed to more urgent matters.

In Hungary the liberty of the press was secured by art. 18 of the constitution of 1848, which was restored in 1867. Under this the censorship was abolished; but, in addition to provision for the cases of libel, incitement to violence and crime, &c., the law also provided penalties for certain political press offences (§§ 6-8), *i.e.* attacks on the king or members of his family, incitements to (a) the dissolution of the territorial unity of the state or of the dynastic link with Austria; (b) the forcible alteration of the constitution; (c) disobedience to lawful authorities; (d) commission of crime. Press offences are tried by special jury courts. Under the Criminal Code of 1878 (§§ 170-174) further offences were made subject to penalty, including "direct incitement of one class of the population, one nationality or religious denomination to hatred of another," instigation against the constitution and parliament, and glorification of any one who has suffered punishment for such offences. "Direct incitement" (§ 172), was subsequently interpreted by the curia to mean "any spoken or written word . . .

which is capable of producing in another hatred against a nationality, &c."

The result of these provisions has been that liberty of the press has existed in practice only for the Magyars, constant prosecutions having been directed against the editors and proprietors of publications giving voice to the grievances of the other Hungarian races, conviction being all but inevitable owing to the special juries (due to the high property qualification) being almost exclusively composed of members of the dominant race.

In Transylvania, where the old stringent Austrian press law of 1852 is still in force, the public prosecutor has discretionary powers to confiscate obnoxious literature, powers freely used against the Rumanian press. (See R. W. Seton Watson, *Racial Problems in Hungary*, London, 1908, pp. 293 sqq.)

Belgium.—It was the prosecution of political writers by the Dutch government that directly led to the independence of Belgium in 1830. By the Belgian constitution of the 7th of February 1831, art. 18, it is declared that the press is free, that censorship shall never again be established, that sureties cannot be exacted from writers, editors or printers, and that when the author is known and domiciled in Belgium the printer or bookseller cannot be prosecuted. By art. 98 press offences are to be tried by jury. The penal law of the press is contained in the decree of the 20th of July 1831, made perpetual in 1833. By this law it is made an offence, apart from the penal code, (1) to incite to the commission of a crime by placards or printed writings in a public meeting; (2) to attack the obligatory force of the laws, or to incite to disobedience of them; (3) to attack the constitutional authority or inviolability of the king, the constitutional authority of the dynasty, or the authority and rights of the chambers. Every copy of a journal must bear the name of the printer and the indication of his domicile in Belgium. Proceedings for offences against the law must be taken in some cases within three months, in others within a year.

Denmark.—Press offences were at one time punished with great severity. By the code of Christian V. (1683) libel was punished with infamy and hard labour for life, and, if against a magistrate, with death. Censorship was abolished and the press declared free by art. 86 of the constitution granted by Frederick VII. on the 5th of June 1849 and confirmed by Christian IX. in 1866. Art. 81 forbids the search for or seizure of printed matter in a dwelling-house, unless after judicial proceedings.

France.—The government began early to impose stringent restrictions upon printing. An edict of Henry II. in 1559 made it punishable with death to print without authority. The university of Paris originally claimed the right of licensing new theological works, a jurisdiction vested in the Crown by an ordinance of 1566. Offences against religion were severely punished by the secular authorities. Thus the parliament of Toulouse sent Vanini to the stake in 1619 for the crime of publishing a heretical work. A few years later, in 1626, Cardinal Richelieu declared it a capital offence to publish a work against religion or the state. In 1723 appeared a regulation forbidding any but licensed booksellers to deal in books. Many later regulations were directed against unlicensed presses, the employment of more than a certain number of workmen, &c. At the Revolution all these restrictions were abolished, and the Assembly declared it to be the right of every citizen to print and publish his opinions. This new liberty quickly needed a check, which was attempted as early as 1791, but no effectual restraint was imposed until the law of the 5th of February 1810 established a direction of the press. The charter of Louis XVIII. in 1814 gave liberty to the press in express terms, but restrictions soon followed. In 1819 a system of sureties (*cautionnements*) replaced the censorship. The Revolution of 1830 was caused by, *inter alia*, one of the ordinances of St Cloud (July 25, 1830) for suspension of the liberty of the press. Restrictions on the liberty were removed for the time in 1830 and 1852, only to be succeeded as usual by the press laws of 1835 and 1852. During the Second Empire government prosecutions for libel were used as a powerful engine against the press. The proceedings against Montalembert in 1858 are a well-known instance. Between 1858 and 1866 many newspapers were suppressed by proclamation. With the republic liberty of the press was completely re-established. A decree of the 27th of October 1870 submitted press offences to trial by jury.¹ The law of the 29th of July 1881, by which the French press is now regulated, begins by asserting the liberty of the press and of bookselling. The principal limitations of this liberty are the prohibition to publish criminal proceedings before hearing in public, or lists of subscriptions for indemnifying an accused person, and the power of forbidding the entrance of foreign newspapers under certain circumstances. The order of responsibility for printed matter is (1) the manager or editor, (2) the author, (3) the printer, (4) the vender or distributor. The printer and the vender, however, can only be punished for acts not falling within their proper functions. Proceedings for breaches of the law must be taken within three months. As to taxation, the decree of the 5th of September 1870 abolished the stamp duty upon newspapers, but it is still imposed

¹ See Dalloz, *Jurisprudence générale, s.v. "Presse"*; *ibid. Titres alphabétiques (1845-1877), s.v. "Presse."*

upon public notices (*affiches*) other than those of public authorities. None but the notices of public authorities may be printed on white paper.

Germany.—Censorship was introduced by the diet of Spire in 1529. From that time till 1848 there were numerous restrictions on the liberty of the press. One of the most important was a resolution of the diet of the German confederation, passed on the 20th of September 1819 as a sequel to the Carlsbad decrees (*q.v.*), by which newspapers were subject to licence and police supervision in each state. Liberty dates, as in Austria and Italy, from 1848. Soon after that year, however, it became necessary to establish press laws in most of the German states, as in Bavaria in 1850, Prussia and Baden in 1851. Since the establishment of the new empire censorship has disappeared. By art. 74 of the constitution of the empire (1871) every one attacking the empire or its officers through the press is liable to punishment in his own state. By art. 4 the laws relating to the press are under imperial and not local control. The press law of the 7th of May 1874 is therefore in force throughout the whole empire. At its beginning it affirms the liberty of the press. Its main provisions are these: The name and address of the printer must appear on all printed matter. Newspapers and periodicals must in addition bear the name of some one person, domiciled in the empire, as responsible editor, and a copy of every number must be deposited with the police authorities of the district in which it is published. Foreign periodicals may be excluded by proclamation of the Imperial chancellor for two years, if twice within the year they have been guilty of certain offences against the penal code. Criminal proceedings are not to be reported while still *sub judice*. The order of responsibility for offences is the same as in France. Proceedings must be taken within six months. In certain cases printed matter may be seized without the order of a court. This may take place where (1) the publication does not bear the name of printer or editor, (2) military secrets are revealed in time of war, (3) justice would be defeated by the publication not being immediately seized. A judicial tribunal is to decide at once upon the legality of the seizure. The press law is not to affect regulations made in time of war or internal disturbance. A temporary law passed in 1878 gave the police large powers in the case of socialistic publications. Only offences involving heavy penalties are tried by jury. The proposal of the Reichstag that all press offences should be so tried was rejected by the governments, except as regards those states (Bavaria, Württemberg, Baden, Oldenburg) where this principle was already in force.

Greece.—Under King Otto censorship was exercised up to 1844. By the constitution of the 18th of March 1844 every one may publish his thoughts by means of the press, observing the laws of the state. The press is free, and censorship (*λογοκρισία*) is not permitted. Responsible editors, publishers and printers of newspapers are not required to deposit money on the ground of surety. Publishers of newspapers must be Greek citizens (art. 10). The legislature may exclude reporters from its sittings in certain cases (art. 48). Press offences are to be tried by jury, except when they deal only with private life (art. 93).

Holland.—The press has been free since the existence of the present kingdom of the Netherlands, which dates from 1815. Liberty of the press is expressly secured by art. 8 of the constitution of 1848. By art. 286 of the penal code seditious books and newspapers may be seized. By art. 283 of the same code and by a royal decree of the 25th of January 1814 the name of the printer must appear upon newspapers. Press offences are not tried by jury.

Italy.—By art. 27 of the political code of Sardinia, granted by Charles Albert on the 4th of March 1848, and still in force, the press is free, but abuses of the liberty are restrained by law. The present press law of Italy is contained in the law of the 26th of March 1848, as altered by later enactments. Everything printed in typographical characters, or by lithography or any similar means, must indicate the place and the date of printing and the name of the printer. A copy of everything printed must be deposited with certain officials and at certain libraries. Before the publication of any newspaper or periodical, notice of the intended publication must be given at the office of the secretary of state for internal affairs. The notice must contain (1) a declaration of the legal qualification of the person intending to publish, whether as proprietor or editor, (2) the nature of the publication, and (3) the name and residence of the responsible editor. Every newspaper is bound to insert gratuitously a contradiction or explanation of any charge made against a person in its columns. For contravention of these and other regulations there is a statutory penalty not exceeding 1000 lire (£40). The publication of a newspaper may be suspended until the payment of a fine. The publication of parliamentary debates is permitted. Press offences are tried by a jury of twelve. By a law of the 11th of May 1877 it is forbidden to publish any indication of the way in which individual judges or jurors voted in their deliberations.

Norway.—The liberty of the press is secured by art. 100 of the constitution of 1814. No one can be punished for any writing unless he, or some one by his instigation, offend against the state, law, religion or decency, or make infamous accusations against any one. Criticism of the government is expressly permitted.

Ottoman Empire.—By art. 12 of the constitution of the 23rd of December 1876 the press was recognized as free, subject to the limits imposed by law. The constitution was, however, "suspended," and a rigorous censorship was enforced, under the direction of Sultan Abd-ul-Hamid II., until the revolution of 1908.

Portugal.—It is stated by Braga and others that a free press existed up to the establishment of the Inquisition, and that Gil Vicente (d. 1536) was the last writer who dared to express his thoughts freely. At a later period Bocage was imprisoned for writings displeasing to the authorities. Boards of censorship under the names of the "Real mesa censoria," or the "Mesa do desembargo do paço," assumed to license publications. Liberty of the press was, however, finally secured, and censorship limited, by art. 7 of the constitution granted by John VI. in 1821. By art. 8 a special tribunal was constituted in both Portugal and Brazil to protect the liberty of printing. The censorship was confined to that exercised by the bishops over theological or dogmatic works. The debates in the legislature and proceedings in the courts of justice are not generally reported.

Rumania.—By the constitution of the 30th of June 1866, art. 5. Rumanians enjoy liberty of the press. By art. 24 the constitution guarantees to all the liberty of communicating and publishing ideas through the press, every one being liable for abuse in cases determined by the penal code. Press offences are to be tried by jury. Censorship is abolished, and is never to be re-established. No previous authorization is necessary for the publication of newspapers. No sureties are to be demanded from journalists, writers, editors or printers. The press is not to be subjected to regulation of advertisements. No newspaper or publication is to be suspended or suppressed. Every author is responsible for his writings; in default of the author, the manager or editor is responsible. Every newspaper must have a responsible manager in the possession of civil and political rights.

Russia.—The position of the Russian press generally was, previously to the revolution of 1905, regulated by a law of the 6th of April 1865. The effect of that law was to exempt from preventive censorship (if published in St Petersburg or Moscow) all newspapers, periodicals and original works and translations not exceeding a certain number of pages, and (wherever published) all government publications, matter printed by academies, universities and scientific bodies, and maps, plans, and charts. Everything printed and published that did not fall within any of these categories had, before issue to the public, to be submitted for the approval of government censors stationed in different parts of the empire. The minister of the interior had power to dispense with the preventive censorship in the case of provincial newspapers and periodicals. In St Petersburg and Moscow the periodical press was subject to corrective censorship for infringement of the numerous restrictive regulations contained in the code, and supplemented at times by secret instructions from the minister of the interior to editors and publishers. Apart from the code, the sustained display of a spirit hostile to the government rendered the publisher of a periodical liable to punishment. The penalties established by the law of 1865 for offences against the press regulations consisted in the infliction of a series of warnings published in the *Official Gazette*. A first warning merely enjoined more care for the future; a second was followed by suspension for a certain period, sometimes by a prohibition to insert advertisements; a third by suppression, and perhaps prosecution of the offending conductor. By Imperial ukaz of the 2nd of June 1872 the jurisdiction of the judicial tribunals over press offences was practically transferred to the minister of the interior, except in the case of violation of private rights, as by libel. The law of 1865 was modified in 1874 by a regulation to the effect that all publications appearing at longer intervals than one week should be submitted to the central board of censors. This applied to all periodicals that had been formerly published without preventive censorship. By a ukaz issued in 1881 a committee of four members was entrusted with the decision of all matters relating to the press submitted to it by the minister of the interior. The strictest supervision was exercised over the foreign press, periodical and otherwise. None but a few privileged individuals, such as members of the royal family, foreign diplomatists, and editors of newspapers in the capital, might receive foreign publications free of censorship. The censorship consisted in blackening out, and sometimes in the excision, of whole columns and sheets of publications that might be deemed pernicious. Only such periodicals as were placed on a list approved by the board of censors were allowed to be received through the post office by non-privileged persons. Telegraphic messages to newspapers were subject to strict censorship. The Russian telegraphic press agency is under official management.

Full liberty of the press was guaranteed by the Imperial ukaz of the 17th of October 1905, and though no special legislation followed the censorship was for a time *de facto* abolished. With the progress of the reaction, however, the old conditions were to a certain extent re-established. In St Petersburg, for instance, the newspapers were in 1909 again under the absolute jurisdiction of chief of police and were forbidden to publish any reference to members of the Imperial family or to the affairs of Poland (except official notices). In 1908 as many as 73 newspapers and periodicals were suppressed, of which 28 were in St Petersburg alone.

Spain.—There was probably no country where restrictions on the liberty of the press were at one time more stringent than in Spain. From the first use of printing up to 1521 censorship was exercised by the Crown; after that date the Inquisition began to assume the right, and continued to do so up to its suppression in 1808. In 1558 Philip II. denounced the penalty of death against even the possessor of a book upon the *Index expurgatorius* of the Inquisition. Some of the greatest names in Spanish literature were sufferers: Castillejo, Mendoza, Mariana and Quevedo incurred the displeasure of the Inquisition; Luis Ponce de Leon was imprisoned for his translation of the Song of Solomon. The last *Index* appeared in 1790.¹ In 1812 the constitution promulgated by the regency in the name of Ferdinand VII. provided by art. 371 that all Spaniards should have liberty to write, print and publish their political ideas without any necessity for licence, examination or approbation previous to publication, subject to the restrictions imposed by law. Art. 13 of the constitution of the 30th of June 1876, promulgated on the accession of Alphonso XII., practically re-enacts this provision.

Sweden.—The press law of the 16th of July 1812 is one of the fundamental laws of Sweden. It is an expansion of art. 86 of the constitution of the 6th of June 1809. Liberty of the press is declared to be the privilege of every Swede, subject to prosecution for libellous writing. Privileges of individuals as to publication are abolished. The title and place of publication of every newspaper or periodical must be registered, and every publication must bear the name of the printer and the place of printing. Press offences are tried by a jury of nine, chosen respectively by the prosecutor, the prisoner, and the court. The verdict of two-thirds of the jury is final.

Switzerland.—Liberty of the press is secured by art. 45 of the constitution of 1848, re-enacted by art. 55 of the constitution of the 29th of May 1874. Each canton has its own laws for the repression of abuse of the liberty, subject to the approbation of the federal council. The confederation can impose penalties on libels directed against itself or its officers.

PRESTEIGN, a market town, urban district, and assize and county town of Radnorshire, Wales, situated on the Lug amidst beautiful scenery. Pop. (1901), 1245. Presteign is the terminus of a branch of the Great Western railway running north from Titley Junction in Herefordshire. The old-fashioned town contains the fine parish church of St Andrew, dating chiefly from the 15th century, and an interesting old inn, the "Radnorshire Arms," once the residence of the Bradshaw family in the 17th century. To the west rises the Wardon, a wooded hill laid out as a public park. Presteign is the most easterly spot on the Welsh border, a circumstance that is noted in the Cymric expression to mark the extreme breadth of the Principality—*o Tyddewi i Llanandras* ("from St Davids to Presteign").

Although the Welsh name of Llanandras is said to denote a foundation by St Andras ap Rhun ap Brychan in the 5th century, the place seems to have been an obscure hamlet in the lordship of Moelnaidd until the 14th century, when Bishop David Martyn of St Davids (1290–1328) conferred valuable market privileges upon this his native place, which on doubtful authority is said to derive its English name from this priest. In 1542 Presteign was named as the meeting-place of the county sessions for Radnorshire in conjunction with New Radnor, and it has ever since ranked as the county town. Although an ancient borough by prescription, Presteign was not included in the Radnor parliamentary district until the 19th century, and of this privilege it was deprived by the Redistribution Act of 1885.

PRESTER JOHN, a fabulous medieval Christian monarch of Asia. The history of Prester John no doubt originally gathered round some nucleus of fact, though what that was is extremely difficult to determine. But the name and the figure which it suggested occupied so prominent a place in the mind of Europe for two or three centuries that a real history could hardly have a stronger claim to exposition. Before Prester John appears upon the scene we find the way prepared for his appearance by a kindred fable, which entwined itself with the legends about him. This is the story of the appearance at Rome (1122), in the pontificate of Calixtus II., of a certain Oriental ecclesiastic, whom one account styles "John, the patriarch of the Indians," and another "an archbishop of India." This ecclesiastic related wonderful stories of the shrine of St Thomas in India, and of the miracles wrought there by the body of the apostle, including

the distribution of the sacramental wafer by his hand. We cannot regard the appearance at Rome of the personage who related these marvels in presence of the pope as a mere popular fiction: it rests on two authorities apparently independent (one of them a letter from Odo of Reims, abbot of St Remy from 1118 to 1151), for their discrepancies show that one was not copied from the other, though in the principal facts they agree.

Nearly a quarter of a century later Prester John appears upon the scene, in the character of a Christian conqueror and potentate who combined the characters of priest and king, and ruled over vast dominions in the Far East. This idea was universal in Europe from about the middle of the 12th century to the end of the 13th or beginning of the 14th. The Asiatic story then died away, but the name remained, and the royal presbyter was now assigned a locus in Ethiopia. Indeed, it is not improbable that from a very early date the title was assigned to the Abyssinian king, though for a time this identification was overshadowed by the prevalence of the Asiatic legend. At the bottom of the double allocation there was, no doubt, that confusion of Ethiopia with India which is as old as Virgil and perhaps older.

The first mention of Prester John occurs in the chronicle of Otto, bishop of Freisingen. This writer states that when at the papal court in 1145 he met with the bishop of Gabala (Jihal in Syria), who related how "not many years before one John, king and priest (*rex et sacerdos*), who dwelt in the extreme Orient beyond Persia and Armenia, and was, with his people, a Christian but a Nestorian, had made war against the brother kings of the Persians and Medes, who were called Samiards (or Sanjards), and captured Echatana their capital. After this victory *Presbyter John*—for so he was wont to be styled—advanced to fight for the Church at Jerusalem; but when he arrived at the Tigris and found no means of transport for his army, he turned northward, as he had heard that the river in that quarter was frozen over in winter-time. After halting on its banks for some years in expectation of a frost he was obliged to return home. This personage was said to be of the ancient race of the Magi mentioned in the Gospel, to rule the same nations that they ruled, and to have such wealth that he used a sceptre of solid emerald. Whatever impression was made by this report, or by other rumours of the event on which it was founded, was far exceeded, about 1165, by the circulation of a letter purporting to be addressed by Prester John to the emperor Manuel. This letter, professing to come from "Presbyter Joannes, by the power and virtue of God and of the Lord Jesus Christ, Lord of Lords," claimed that he was the greatest monarch under heaven, as well as a devout Christian. The letter dealt at length with the wonders of his empire. It was his desire to visit the Holy Sepulchre with a great host, and to subdue the enemies of the Cross. Seventy-two kings, reigning over as many kingdoms, were his tributaries. His empire extended over the three Indies, including that Farther India, where lay the body of St Thomas, to the sun-rising, and back again down the slope to the ruins of Babylon and the tower of Babel. All the wild beasts and monstrous creatures commemorated in current legend were to be found in his dominions, as well as all the wild and eccentric races of men of whom strange stories were told, including those unclean nations whom Alexander Magnus walled up among the mountains of the north, and who were to come forth at the latter day—and so were the Amazons and the Bragmans. His dominions contained the monstrous ants that dug gold and the fish that gave the purple; they produced all manner of precious stones and all the famous aromatics. Within them was found the Fountain of Youth; the pebbles which give light, restore sight, and render the possessor invisible; the Sea of Sand was there, stored with fish of wondrous savour; and the River of Stones was there also; besides a subterranean stream whose sands were of gems. His territory produced the worm called "salamander," which lived in fire, and which wrought itself an incombustible envelope from which were manufactured robes for the presbyter, which were washed in flaming fire. When the king went forth to war thirteen

¹ See Ticknor, *Hist. of Span. Lit.* i. 422 seq., iii. 366

great crosses made of gold and jewels were carried in wagons before him as his standards, and each was followed by 10,000 knights and 100,000 footmen. There were no poor in his dominions, no thief or robber, no flatterer or miser, no dissensions, no lies, and no vices. His palace was built after the plan of that which St Thomas erected for the Indian king Gondopharus. Of the splendour of this details are given. Before it was a marvellous mirror erected on a many-storeyed pedestal (described in detail); in this speculum he could discern everything that went on throughout his dominions, and detect conspiracies. He was waited on by 7 kings at a time, by 60 dukes and 365 counts; 12 archbishops sat on his right hand, and 20 bishops on his left, besides the patriarch of St Thomas's, the protopope of the Sarmagantians (Samarkand?), and the archprotopope of Susa, where the royal residence was. There was another palace of still more wonderful character, built by the presbyter's father in obedience to a heavenly command, in the city of Bribric. Should it be asked why, with all this power and splendour, he calls himself merely "presbyter," this is because of his humility, and because it was not fitting for one whose sewer was a primate and king, whose butler an archbishop and king, whose chamberlain a bishop and king, whose master of the horse an archimandrite and king, whose chief cook an abbot and king, to be called by such titles as these.

How great was the popularity and diffusion of this letter may be judged in some degree from the fact that Zarncke in his treatise on Prester John gives a list of close on 100 MSS. of it. Of these there are 8 in the British Museum, 10 at Vienna, 13 in the great Paris library, 15 at Munich. There are also several renderings in old German verse. Many circumstances of the time tended to render such a letter acceptable. Christendom would welcome gladly the intelligence of a counterpoise arising so unexpectedly to the Mahomedan power; while the statements of the letter itself combined a reference to and corroboration of all the romantic figments concerning Asia which already fed the curiosity of Europe, which figured in the world-maps, and filled that fabulous history of Alexander which for nearly a thousand years supplanted the real history of the Macedonian throughout Europe and western Asia.

The only other surviving document of the 12th century bearing on this subject is a letter of which MS. copies are preserved in the Cambridge and Paris libraries, and which is also embedded in the chronicles of several English annalists, including Benedict of Peterborough, Roger Hovedon and Matthew Paris. It purports to have been indited from the Rialto at Venice by Pope Alexander III. on the 5th day before the calends of October (Sept. 27), data which fix the year as 1177. The pope addresses it, *carissimo in Christo filio Johanni, illustro et magnifico indorum regi* [Hovedon's copy here inserts *sacerdoti sanctissimo*]. He recites how he had heard of the monarch's Christian profession, diligence in good works and piety, by manifold narrators and common report, but also more particularly from his (the pope's) physician and confidant (*medicus et familiaris noster*), Master Philip, who had received information from honourable persons of the monarch's kingdom, with whom he had intercourse in those (Eastern) parts. Philip had also reported the king's anxiety for instruction in Catholic discipline and for reconciliation with the apostolic see in regard to all discrepancies, and his desire to have a church in Rome and an altar at Jerusalem. The pope goes on to say that he found it too difficult, on account of the length and obstructions of the way, to send any one (of ecclesiastical position?) *a latere*, but he would despatch Philip to communicate instruction to him. And on accepting Philip's communications the king should send back honourable persons bearing letters sealed with his seal, in which his wishes should be fully set forth. "The more nobly and magnanimously thou conductest thyself, and the less thou vauntest of thy wealth and power, the more readily shall we regard thy wishes both as to the concession of a church in the city and of altars in the church of SS. Peter and Paul, and in the church of the Lord's Sepulchre at Jerusalem, and as to other reasonable requests."

There is no express mention of the title "Prester John" in what seem the more genuine copies of this letter. But the address and the expression in the italicized passage just quoted (which evidently alludes to the vaunting epistle of 1165) hardly leave room for doubt that the pope supposed himself to be addressing the author of that letter. We do not know how far the imaginations about Prester John retained their vitality in 1221, forty-four years after the letter of Pope Alexander, for we know of no mention of Prester John in the interval. But in that year again a rumour came out of the East that a great Christian conqueror was taking the hated Moslems in

reverse and sweeping away their power. Prophecies current among the Christians in Syria of the destruction of Mahomet's sect after six centuries of duration added to the excitement attending these rumours. The name ascribed to the conqueror was David, and some called him the son or the grandson of Prester John of India. He whose conquests and slaughters now revived the legend was in fact no Christian or King David but the famous Jenghiz Khan. The delusion was dissipated slowly, and even after the great Tatar invasion and devastation of eastern Europe its effects still influenced the mind of Christendom and caused popes and kings to send missions to the Tatar hordes with a lingering feeling that their khans, if not already Christians, were at least always on the verge of conversion.

Before proceeding further we must go back to the bishop of Gabala's story. M. d'Arzac first showed to whom the story must apply. The only conqueror whose career suits in time and approximates in circumstances is the founder of Kara-Khitai, which existed as a great empire in Central Asia during the latter two-thirds of the 13th century. This personage was a prince of the Khitai or Khitaian dynasty of Liao, which had reigned over northern China and the regions beyond the Wall during a great part of the 10th and 11th centuries, and from which came the name Khitai (Cathay), by which China was once known in Europe and still is known in Russia. On the overthrow of the dynasty about 1125 this prince, who is called by the Chinese Yelü Tashi, and had gone through a complete Chinese education, escaped westward with a body of followers. Being well received by the Uighurs and other tribes west of the desert, subjects of his family, he gathered an army and commenced a course of conquest which eventually extended over eastern and western Turkestan. He took the title of Gur Khan or Kor Khan, said to mean "universal" or "supreme" khan, and fixed at Balasaghun, north of the T'ian Shan range, the capital of his empire, which became known as that of Kara-Khitai (Black Cathay). In 1141 the assistance of this Khitaian prince was invoked by the shah of Kharezm against Sanjar, the Seljuk sovereign of Persia, who had expelled the shah from his kingdom and killed his son. The Gur Khan came with a vast army of Turks, Khitaians, and others, and defeated Sanjar near Samarkand (Sept. 1141) in a battle which the historian Ibn al-Athir calls the greatest defeat that Islam had ever undergone in those regions. Though the Gur Khan himself is not described as having extended his conquests into Persia, the shah of Kharezm followed up the victory by invading Khorasan and plundering the cities and treasuries of Sanjar. In this event—the defeat of Sanjar, whose brother's son, Mas'ud, reigned over western Persia—occurring four years before the story of the Eastern conqueror was told at Rome to Bishop Otto, we seem to have the destruction of the *Samiardi fratres* or Sanjar brothers, which was the germ of the story of Prester John.

There is no evidence of any profession of Christianity on the part of the Gur Khan, though the daughter of the last of his race is recorded to have been a Christian. The hosts of the Gur Khan are called by Moslem historians *Al-Turk-al-Kuffar*, the kafir or infidel Turks; and in later days the use of this term "kafir" led to misapprehensions, as when Vasco da Gama's people were led to take for Christians the Banyan traders on the African coast, and to describe as Christian sovereigns so many princes of the Farther East of whom they heard at Calicut. How the name John arose is one of the obscure points. Oppert supposes the title "Gur Khan" to have been confounded with Yukhanan or Johannes; and it is probable that even in the Levant the stories of "John the patriarch of the Indies," repeated in the early part of this article, may have already mingled with the rumours from the East.

The failure in the history of the Gur Khan to meet all points in the story of the bishop of Gabala led Professor Bruun of Odessa to bring forward another candidate for identity with the original Prester John, in the person of the Georgian prince John Orbelian, the "sbasalar," or generalissimo under several kings of Georgia in that age. He shows instances, in documents of the 15th century, of the association of Prester John with the Caucasus. In one at least of these the title is applied to the king of Abassia, i.e. of the Abhassians of Caucasus. Some confusion between Abash (Abyssinia) and Abbas seems to be possibly at the bottom of the imbroglia. An abstract of Professor Bruun's argument will be found in the 2nd edition of Sir H. Yule's *Marco Polo*, ii. 539-542. As regards any real foundation for the title of "Presbyter" we may observe that nothing worth mentioning has been alleged on behalf of any candidate.

When the Mongol conquests threw Asia open to Frank travellers in the middle of the 13th century their minds were full of Prester John; they sought in vain for an adequate representative, nor was it in the nature of things that they should not find some representative. In fact they found several. Apparently no real tradition existed among the Eastern Christians of such a personage; the myth had taken shape from the clouds of rumour as they rolled westward from Asia. But the persistent demand produced a supply; and the honour of identification with Prester John, after hovering over one head and another, settled for a long time upon that of the king of the Nestorian tribe of Kerait, famous in the histories of Jenghiz under the name of Ung or Awang Khan.

In Carpini's (1248) single mention of Prester John as the king

of the Christians of India the Greater, who defeats the Tatars by an elaborate stratagem, Oppert recognizes Jalaluddin of Kharezm and his brief success over the Mongols in Afghanistan. In the Armenian prince Sempad's account (1248), on the other hand, this Christian king of India is aided by the Tatars to defeat and harass the Saracens, and becomes the vassal of the Mongols. In the narrative of William Rubruquis (1253), though distinct reference is made to the conquering Gur Khan under the name of Coir Cham of Caracatay, the title of "King John" is assigned to Kushluk, king of the Naimans, who had married the daughter of the last lineal representative of the gur khans.¹ And from the remarks which Rubruquis makes in connexion with this King John, on the habit of the Nestorians to spin wonderful stories out of nothing, and of the great tales that went forth about King John, it is evident that the intelligent traveller supposed this king of the Naimans to be the original of the widely spread legend. He mentions, however, a brother of this John called Unc who ruled over the Crit and Merkit (or Kerait and Mekrit, two of the great tribes of Mongolia), whose history he associates with that of Jenghiz Khan. Unc Khan reappears in Marco Polo, who tells much about him as "a great prince, the same that we call Prester John, him in fact about whose great dominion all the world talks." This Unc was in fact the prince of the Kerait, called by the Chinese Tuli, and by the Persian historians of the Mongols Toghrul, on whom the Kin emperor of north China had conferred the title of "wang" or king, whence his coming to be known as Awang or Ung Khan. He was long the ally of Jenghiz, but a breach occurred between them, and they were mortal enemies till the death of Ung Khan in 1203. In the narrative of Marco Polo "Unc Can," alias Prester John, is the liege lord of the Tatars, to whom they paid tribute until Jenghiz arose. And this is substantially the story repeated by other European writers of the end of the 13th century, such as Ricold of Montecroce and the sieur de Joinville, as well as by one Asiatic, the famous Christian writer, Gregory Abulfaraj. We can find no Oriental corroboration of the claims of Ung Khan to supremacy over the Mongols. But that his power and dignity were considerable appears from the term "Padshah," which is applied to him by the historian Rashiduddin.

We find Prester John in one more phase before he vanishes from Asiatic history, real or mythical. Marco Polo in the latter part of the 13th century, and Friar John of Montecorvino, afterwards archbishop of Cambaluc, in the beginning of the 14th, speak of the descendants of Prester John as holding territory under the great khan in a locality which can be identified with the plain of Kuku-Khotan, north of the great bend of the Yellow river and about 280 m. north-west of Peking. The prince reigning in the time of these two writers was named King George, and was the "6th in descent from Prester John," i.e. no doubt from Awang Khan. Friar Odoric, about 1326, visited the country still ruled by the prince whom he calls Prester John; "but," he says, "as regards him, not one-hundredth part is true that is told of him." With this mention Prester John ceases to have any pretension to historical existence in Asia (for we need not turn aside to Mandeville's fabulous revival of old stories or to the barefaced fictions of his contemporary, John of Hese, which bring in the old tales of the miraculous body of St Thomas), and his connexion with that quarter of the world gradually died out of the memory of Europe.²

When next we begin to hear his name it is as an African, not as an Asiatic prince; and the personage so styled is in fact the Christian king of Abyssinia. Ludolf has asserted that this application was an invention of the Portuguese and arose only in the 15th century. But this is a mistake; for in fact the application had begun much earlier, and probably long before the name had ceased to be attached by writers on Asia to the descendants of the king of the Kerait. It is true that the Florentine Simone Sigoli, who visited Cairo in 1384, in his *Viaggio al Monte Sinai* still speaks of "Presto Giovanni" as a monarch dwelling in India; but it is the India which is contemurinous with the dominions of the sultan of Egypt, and whose lord is master of the Nile, to close or open its discharge upon Egypt. Thirty years earlier (c. 1352) the Franciscan Giovanni de' Marignolli, apostolic legate in Asia, speaks in his *Chronica* of Ethiopia where the Negroes are, and which is called the land of Prester John.³ Going back still further, Friar Jordanus

¹ It has been pointed out by Alexander Wylie that Kushluk was son of a powerful king of the Naimans, whose name Ta-Yang-Khan is precisely "Great King John" as nearly as that could be expressed in Chinese.

² The stories of Khitai as a Christian empire, which led the Jesuits at the court of Akbar to despatch Benedict Goes in search of it (1601), did, however, suggest to Jerome Xavier, their chief, that the country in question "was the Cathay of Marco Polo, and its Christian king the representative of the famous Prester John"—a jumble of inaccuracy.

³ In a Spanish work of about the same date, by an anonymous Franciscan, we are told that the emperor called "Abdeselib, which means 'servant of the Cross,' is a protector of *Preste Juan*, who is the patriarch of Nubia and Ethiopia, and is lord of many great lands, and many cities of Christians, though they be black as

"Catalani," who returned from the East before 1328, speaks of the emperor of the Ethiopians "quem vos vocatis *Prestre Johan*."

But, indeed, we shall have strong probability on our side if we go back much further still, and say that, however vague may have been the ideas of Pope Alexander III. respecting the geographical position of the potentate whom he addressed from Venice in 1177, the only real person to whom the letter can have been sent was the king of Abyssinia. Let it be observed that the "honourable persons of the monarch's kingdom" whom the leech Philip had met with in the East must have been the representatives of some real power, and not of a phantom. It must have been a real king who professed to desire reconciliation with the Catholic Church and the assignation of a church at Rome and of an altar at Jerusalem. Moreover, we know that the Ethiopic Church did long possess a chapel and altar in the Church of the Holy Sepulchre, and, though we have been unable to find travellers' testimony to this older than about 1497, it is quite possible that the appropriation may have originated much earlier.⁴ We know from Marco Polo that about a century after the date of Pope Alexander's epistle a mission was sent by the king of Abyssinia to Jerusalem to make offerings on his part at the Church of the Sepulchre. It must be remembered that at the time of the pope's letter Jerusalem, which had been taken from the Moslem in 1099, was still in Christian possession. Abyssinia had been going through a long period of vicissitude and distraction. In the 10th century the royal line had been superseded by a dynasty of Falasha Jews, followed by other Christian families; but weakness and disorder continued till the restoration of the "House of Solomon" (c. 1268). Nothing is more likely than that the princes of the "Christian families" who had got possession of the throne of northern Abyssinia should have wished to strengthen themselves by a connexion with European Christendom, and to establish relations with Jerusalem, then in Christian hands. We do not know whether the leech Philip ever reached his destination, or whether a reply ever came back to the Lateran.⁵

Baronius, who takes the view for which we have been arguing, supposes it possible that the church in Rome possessed in his own time by the Abyssinians (St Stephen's in the Vatican) might have been granted on this occasion. But we may be sure that this was a modern concession during the attempts to master the Ethiopian Church early in the 16th century. Ludolf intimates that its occupancy had been taken from them in his own time after it had been held "for more than a century."

In the legendary history of the *Translation of the three Blessed Kings* by John of Hildesheim (c. 1370), of which an account and extracts are given by Zarncke (*Abhandl.* ii. 154 seq.), we have an evident jumble in the writer's mind between the Asiatic and the African location of Prester John; among other matters it is stated that Prester John and the Nubians dug a chapel out of the rock under Calvary in honour of the three kings: "et vocatur illa capella in partibus illis capella Nubianorum ad reges in praesentem diem, sed Sarracini . . . ob invidiam obstruxerunt" (p. 158).

From the 14th century onwards Prester John had found his seat in Abyssinia. It is there that Fra Mauro's great map (1459) presents a fine city with the rubric, "Qui il Preste Janni fa residentia principal." When, nearer the end of the century (1481-1495), King

pitch, and brand themselves with the sign of the cross in token of their baptism" (*Libro del conocimiento de todos Reynos, &c.*, printed at Madrid, 1877).

⁴ Indeed, we can carry the date back half a century further by the evidence of a letter translated in Ludolf (*Comment.* p. 303). This is addressed from Shoa by the king Zara Jacob in the eighth year of his reign (1442) to the Abyssinian monks, dwellers at Jerusalem. The king desires them to light certain lamps in the Church of the Sepulchre, including "three in our chapel." In the *Pilgerfahrt des Ritters Arnold von Harff* (1496-1499: Cologne, 1860, p. 175), we find it stated that the Abyssinians had their chapel, &c., to the left of the Holy Sepulchre, between two pillars of the Temple, whilst the Armenian chapel was over theirs, reached by a stone staircase alongside of the Indians (or Abyssinians). This exactly corresponds with the plan and reference given in Sandys's *Travels* (1615), p. 162, which show the different chapels. The first on the south, i.e. the left looking from the body of the church, is "No. 35.—The chappell of the Absines, over which the chappell of the Armenians." A reference to Jerusalem, which we procured through the kindness of Mr Walter Besant, shows that the Abyssinians no longer have a chapel or privileges in the Church of the Sepulchre. Between the Armenians and the Copts they have been deprived of these, and even of the keys of their convent. The resentment of King Theodore at the loss of these privileges was one of the indirect causes which led to the war between him and England in 1867-68.

⁵ Matthew Paris gives a letter from Philip, prior of the Dominicans in Palestine, which reached the pope in 1237, and which speaks of a prelate from whom he had received several letters, "qui praest omnibus quos Nestoriana haeresis ab ecclesia separavit (cujus praelatio per Indiam Majorem, et per regnum sacerdotis Johannis, et per regna magis proxima Orienti dilatatur)." We have little doubt that Abyssinia was the "regnum" here indicated, though it was a mistake to identify the Abyssinian Church with the Nestorians.

John II. of Portugal was prosecuting inquiries regarding access to India his first object was to open communication with "Prester John of the Indies," who was understood to be a Christian potentate in Africa. And when Vasco da Gama went on his voyage from Mozambique northwards he began to hear of "Preste Joham" as reigning in the interior—or rather, probably, by the light of his preconceptions of the existence of that personage in East Africa he thus interpreted what was told him. More than twenty years later, when the first book on Abyssinia was composed—that of Alvarez—the title designating the king of Abyssinia is "Prester John," or simply "the Preste."

On the whole subject in its older aspects, see Ludolf's *Historia Aethiopia* and its *Commentary*, passim. The excellent remarks of M. d'Avezac, comprising a conspectus of almost the whole essence of the subject, are in the *Recueil de voyages et de mémoires* published by the Société de Géographie, iv. 547-564 (Paris, 1839). Two German works of importance which have been used in this article are the interesting and suggestive *Der Presbyter Johannes in Sage und Geschichte*, by Dr Gustav Oppert (2nd ed., Berlin, 1870), and, most important of all in its learned, careful and critical collection and discussion of all the passages bearing on the subject, *Der Priester Johannes*, by Friedrich Zaracke of Leipzig (1876-1879). See also Sir H. Yule's *Cathay and the Way Thither*, p. 173 seq., and in *Marco Polo* (2nd ed.), i. 229-233, ii. 539-543. (H. Y.)

PRESTIDIGITATION (from Lat. *praesto*, ready, and *digitus*, finger), the art of conjuring by nimble-fingered dexterity, particularly as opposed to the use of mechanical devices (see **CONJURING**). The Latin *praestigium*, illusion, *praestigiae* tricks, and *praestigiator*, juggler (from *prac*, before, and *stingere*, to prick), cover the same meaning though differently derived.

PRESTIGE, influence and authority exercised by reason of high reputation. It is one of the few words which have gained a meaning superior to that of original usage. The word in French, from which it has been borrowed by English, as in Latin *praestigium* or *praestigiae*, meant jugglers' tricks, deceit, imposture, and so is found in the 16th century. The Latin stands for *praestrigium*, from *praestringere*, to bind or fasten tight, hence to blindfold; others derive from *praestinguere*, to darken, obscure, deceive. The word was at first generally used as foreign and italicized; thus the *New English Dictionary* quotes Sir Walter Scott (*Paul's Letters to his Kinsfolk*, 1815) for the earliest example in English of the modern usage, "Napoleon needed the dazzling blaze of decisive victory to renew the charm or *prestige* . . . once attached to his name and fortunes." Other words derived from *praestigium* through the French retain the original meaning of juggling or conjuring (see **PRESTIDIGITATION**).

PRESTON, JOHN (1587-1628), English Puritan divine, was born at Heyford in Northamptonshire and was educated at Queens' College, Cambridge (fellow 1609). He took orders, and on becoming dean of his college drew large crowds to hear his preaching. On the duke of Buckingham's advice he was appointed chaplain to Prince Charles in 1620; in 1622 he became preacher at Lincoln's Inn and master of Emmanuel College, Cambridge. After the accession of Charles I. he worked hard on behalf of the Puritan cause, but could accomplish little or nothing against Archbishop Laud. In theology he was a stanch Calvinist and his writings had considerable popularity.

PRESTON, a municipal, county, and parliamentary borough and port, of Lancashire, England, on the river Ribble, 209 m. N.W. by N. from London by the London & North-Western railway, served also by the Lancashire & Yorkshire railway. Pop. (1891), 107,573; (1901), 112,989; at the beginning of the 19th century it was about 17,000. The nucleus of its site consists of a ridge rising sharply from the north bank of the river, while the surrounding country, especially to the west about the estuary, is flat. Among the numerous parish churches that of St John, built in Decorated style in 1855, occupies a site which has carried a church from early times. Among several Roman Catholic churches, that of St Walpurgis (1854) is a handsome building of Early Decorated character. Of public buildings the most noteworthy is the large town hall, with lofty tower and spire, in Early English style, built in 1867 from designs by Sir Gilbert Scott.

The free public library and museum were established in 1879 by the trustees of E. R. Harris, a prominent citizen. A new

building was opened in 1893. Here is placed Dr Shepherd's library, founded in 1761, of nearly 9000 volumes, as well as a collection of pictures, &c., valued at £40,000, bequeathed by the late R. Newsham. The Harris Institute, endowed by the above-named trustees with £40,000, is established in a building of classical style erected in 1849, wherein are held science and art classes, and a chemical laboratory is maintained. For the grammar school, founded in 1550, a building in the Tudor style was erected in 1841 by private shareholders, but in 1860 they sold it to the corporation, who now have the management of the school. The blue-coat school, founded in 1701, was in 1817 amalgamated with the national schools. A Victoria Jubilee technical school was established under a grant from the Harris trustees in 1897. There is also a deaf and dumb school. Preston is well supplied with public recreation grounds, including Avenham Park, the Miller Park, with a statue of the 14th earl of Derby (d. 1869), the Moor Park, the Marsh, and the Deepdale grounds, with an observatory. Preston is one of the principal seats of the cotton manufacture in Lancashire. There are also iron and brass foundries, engineering works, cotton machinery works, and boiler works, and some shipbuilding is carried on. In 1826 Preston became a creek of Lancaster, in 1839 it was included in the new port of Fleetwood, and in 1843 it was created an independent port. The trade of the port was insignificant until the construction of spacious docks, in conjunction with the deepening of the river from the quays of Preston to its outfall in the Irish Sea, a distance of 16 m., was begun in 1884, and was carried out at a cost of over one million sterling. The main wet dock, opened in 1892, is 3240 ft. long and 600 ft. wide. The total quaysage is over 8500 lineal feet. The channel of the river has been made straighter, and from docks to sea deepened, so that the dock is accessible for vessels of 17 ft. draught on ordinary spring tides. A canal connects Preston with Lancaster.

The parliamentary borough, which returns two members, falls between the Blackpool and Darwen divisions of the county. The corporation consists of a mayor, 12 aldermen and 36 councillors. Area of municipal borough, 3971 acres.

Preston, otherwise Prestunc, was near the minor Roman station at Walton-le-Dale and the great Roman road running from Warrington passed through it. It is mentioned in Domesday Book as one of Earl Tostig's possessions which had fallen to Roger of Poitou, and on his defection it was forfeited to the Crown.¹ Henry II. about the year 1179 granted the burgesses a charter by which he confirmed to them the privileges he had granted to Newcastle-under-Lyme, the chief of which were a free borough and a gild merchant. This is the first of fourteen royal charters which have been granted to Preston, the chief of which are as follows: John in 1109 confirmed to Preston all the rights granted by Henry II.'s charter and also "their fair of eight days" from the Assumption (Aug. 15) and a three days' fair from the eve of Saints Simon and Jude (Oct. 28). Henry III. in 1217 confirmed the summer fair, but for five days only, and granted a weekly market on Wednesday. Edward III. (1328), Richard II. (1379), Henry IV. (1401), Henry V. (1414), Henry VI. (1425) and Philip and Mary (1557) confirmed the previous charters. The weekly market, though granted for Wednesday, was held as early as 1292 on Saturday. Elizabeth in 1566 granted the town its great charter which ratified and extended all previous grants, including the gild merchant, the weekly market on Saturday and the two annual fairs, in August for eight days and in October for seven days. Charles II. in 1662 and 1685 granted charters, by the latter of which an additional weekly market on Wednesday was conceded and a three days' fair beginning on the 16th of March. The most important industry used to be woollen weaving. Elizabeth's charter granted to the corporation all fees received from the sealing of cloth within the borough, and in 1571 the mayor reported that the cloths usually made near Preston were "narrow white kearses." Other early industries were glove-making and linen cloth. The first cotton-spinning mill was built in 1777 in Moor Lane, and in 1791 John Horrocks built the Yellow Factory. In 1835 there were forty factories, chiefly spinning, yielding 70,000 lb of cotton yarn weekly. A gild existed perhaps in Saxon times, but the grant of a gild merchant dates from Henry II.'s charter, about 1170. The first gild of which there was any record was celebrated in 1528, at which it was decided to hold a gild every twenty years. Up to 1542, however, they do not appear to have been very regularly celebrated, but

¹ The Court leet was held twice a year up to 1835.

since that year they have been and still are held at intervals of twenty years. A special gild mayor is appointed on each occasion. The first mention of a procession at the gild is in 1500. One of the most important items of business was the enrolling of freemen, and the gild rolls are records of the population. In 1397 the gild roll contained the names of over 200 in-burgesses and 100 foreign burgesses; in 1415 the number of in-burgesses was 188, which in 1459 had declined to 72. In 1582 there were over 500 in-burgesses and 340 out-burgesses. There is no evidence for, but rather against, the common statement that Preston was burnt or razed to the ground during the Scottish invasion of 1322. The town suffered severely from the Black Death in 1349-1350, when as many as 3000 persons are said to have died, and again in the year November 1630 to November 1631, 1100 died of pestilence. During the Civil War Preston sided with the king and became the headquarters of the Royalists in Lancashire. In February 1643 Sir John Seaton with a Parliamentary force marched from Manchester and successfully assaulted it. A strong Parliamentary garrison was established here and its fortifications repaired, but in March the earl of Derby recaptured the town. The Royalists did not garrison it, but after demolishing the greater part of the works left it unfortified. After the battle of Marston Moor Prince Rupert marched through Preston in September 1644 and carried the mayor and bailiffs prisoners to Skipton Castle, where they were confined for twelve months. On the 17th of August 1648 the Royalist forces under the duke of Hamilton and General Langdale were defeated at Preston by Cromwell with a loss of 1000 killed and 4000 taken prisoners. During the Rebellion of 1715 the rebel forces entered Preston on the 9th of November, and after proclaiming the Chevalier de St George king at the cross in the market-place, remained here for some days, during which the government forces advanced. The town was assaulted, and on the 14th of November General Forster surrendered his army of about 1400 men to the king's forces. In 1745 Prince Charles Edward marched through on the way south and north, but the town took no part in the rebellion. The borough returned two members from 1295 to 1331, then ceased to exercise the privilege on account of poverty till 1529, but since that date (except in 1653) it has always sent two representatives to parliament. The curious institution of the mock mayor and corporation of Walton, which was at its foundation in 1701 a Jacobite association, ceased after 1766 to be of any political significance and lapsed in 1800. There was probably a church here in Saxon times and it is believed to be one of the three churches in Amounderness mentioned in Domesday Book. In 1094 it is named in a charter of Roger de Poitou. The early dedication was to St Wilfrid, but probably about 1531, when it was rebuilt, it was re-dedicated to St John. At the time of the Reformation, many, especially among the neighbouring gentry, clung to the old faith, and there is still a large Roman Catholic population. There were two monastic foundations here: a hospital dedicated to St Mary Magdalene, which stood on the Maudlands, and a Franciscan convent of Grey Friars situated to the west of Friargate. In the 18th century Preston had a high reputation as a centre of fashionable society, and earned the epithet still familiarly associated with it, "proud."

See H. Fishwick, *History of the Parish of Preston* (1900).

PRESTONPANS, a police burgh and watering-place of Haddingtonshire, Scotland, on the Firth of Forth, 9½ m. E. of Edinburgh by the North British railway. Pop. (1901), 2614. A mile to the east of the village is the site of the battle of the 21st of September 1745, in which Prince Charles Edward and his highlanders gained a complete victory over the royal forces under Sir John Cope. Colonel James Gardiner was mortally wounded after an heroic stand, and an obelisk in the grounds of his house at Bankton, close to the battlefield, commemorates his valour, while the ballad of Adam Skirving (1719-1803), "Hey, Johnnie Cope!" has immortalized the rout of Cope.

Until the beginning of the 19th century, the salt trade was prosecuted with great success, the pans having been laid down as long ago as 1185, but the industry has declined. There are manu-

factures of fire-bricks, tiles and pottery, besides brewing and soap-making. In the vicinity there is an extensive coal-field. Fisheries are still of importance, although the bed of Pandore oysters (an esteemed variety) has lost something of its former fertility. There are harbours at Morrison's Haven to the west and at Cockenzie and Port Seton to the north-east, which practically form one village, with a population of 1687. The cross of the barony of Preston dates from 1617. Schaw's Hospital Trust, at one time intended for the education and maintenance of the children of poor parents, has been modified, and the bequest is used to provide free education and bursaries, while the building has been leased by the trustees of Miss Mary Murray, who bequeathed £20,000 (afterwards increased to £30,000) for the training of poor children as domestic servants.

PRESTWICH, SIR JOSEPH (1812-1896), English geologist, was born at Clapham, Surrey, on the 12th of March, 1812. He was educated in Paris, Reading and at University College, London, where under Dr D. Lardner and Edward Turner, he paid special attention to natural philosophy and chemistry, and gained some knowledge of mineralogy and geology. Circumstances compelled him to enter into commercial life, and until he was sixty years of age he was busily engaged in the City as a wine merchant. He devoted all his leisure to geology. His business journeys enabled him to see and learn much of the general geology of England, Scotland and France, and this so effectively that at the time of his death he ranked as the most eminent of British geologists. As early as 1831 he commenced, during holiday visits, to make a study of the coal-field of Coalbrookdale in Shropshire, and the results of his observations were communicated to the Geological Society of London in 1834 and 1836, and embodied in a memoir published in 1838. His name is, however, especially known in connexion with his researches on the Eocene strata of the London and Hampshire Basins (1846-1857): he defined the Thanet Sands and the Woolwich and Reading Beds, and studied the sequence of deposits and of organic remains and the method of formation of these and the succeeding strata of London clay and Bagshot Beds. So highly appreciated were his essays on the subject that in 1849 he was awarded the Wollaston Medal by the Geological Society of London; and in 1853 he was elected F.R.S. In the course of his observations he was led to study questions of water supply and published in 1851 *A Geological Inquiry respecting the Water-bearing Strata of the Country around London*, a work that at once became a standard authority; and his extensive knowledge in that respect procured him a seat on the Royal Commission on Water Supply, appointed in 1866. From 1858 the question of the antiquity of man engaged his attention. On various occasions statements had been made as to the association of flint implements formed by man with the bones of extinct mammals which belonged to more remote periods than those generally assigned for the appearance of the human race on this earth, but the evidence adduced had usually been disregarded by geologists as not affording sufficient proof of the point. Prestwich, together with Dr Hugh Falconer and Sir John Evans, saw the desirability of a closer examination of the facts, particularly in regard to the implements discovered by Boucher de Perthes in the gravels of the Somme valley; and their investigations in France and England yielded evidence which proved that man existed contemporaneously with the Pleistocene mammalia (*Phil. Trans.* 1861 and 1864). In 1865 a Royal Medal was awarded to Prestwich by the Royal Society. In 1866 he was chosen one of the commissioners appointed to inquire into the several matters relating to coal in the United Kingdom; and he subsequently contributed an important *Report on the Quantities of Coal, wrought and unwrought, in the Coalfields of Somersetshire and part of Gloucestershire*, and another *Report on the Probabilities of finding Coal in the South of England* (1871). His researches on the Crag Beds of Suffolk and Norfolk, his report on Brixham Cave, his papers on the Channel Tunnel and the Chesil Bank, among others published during the years 1868-1875, may be mentioned.

In 1870 he married Grace Anne McCall (née Milne), niece of Dr H. Falconer, and author of the *Harbour Bar* and other works (see *Essays Descriptive and Biographical*, by Grace, Lady

Prestwich; edited by L. E. Milne, 1901). Prestwich retired from business in 1872, and two years later he was invited to take the chair of geology at Oxford, vacant through the death of John Phillips. This post he occupied until 1887. During his professorship he wrote his great work entitled *Geology: Chemical, Physical and Stratigraphical* (vol. i., 1886; vol. ii., 1888).

On leaving Oxford Prestwich spent his remaining years in his country house, Darent-Hulme, Shoreham, Kent, erected by him in 1869. There, although seventy-six years of age, he maintained marvellous activity in geological research, devoting his attention to the superficial deposits of the Darent valley, to the occurrence of palaeolithic flint implements in the valleys and of an earlier type since called eolithic, on the chalk plateau of Kent; he likewise dealt generally with the raised beaches and rubble-drift of the south of England and their relation to recent changes of level. His latest publications were *Collected Papers on some Controverted Questions of Geology*, and *On Certain Phenomena belonging to the Close of the Last Geological Period and on their Bearing upon the Tradition of the Flood* (1895). He was knighted in 1896, and died on the 23rd of June in the same year, at Shoreham in Kent.

See *Life and Letters of Sir Joseph Prestwich*, edited by his wife (1899).

PRESTWICH, an urban district in the Prestwich parliamentary division of Lancashire, England, 5 m. N.N.W. of Manchester on the Lancashire & Yorkshire railway. Pop. (1901), 12,839. It possesses cotton manufactures, but consists chiefly of handsome mansions and villas inhabited by Manchester merchants.

PRETORIA, the administrative capital of the Union of South Africa and of the province of the Transvaal, 46 m. by rail N. by E. of Johannesburg. Pop. (1904) 36,839, of whom 21,114 were whites. Pretoria is situated on the banken veld or northern slopes of the high veld, on both banks of the Aapies tributary of the Limpopo, and is 4470 ft. above the sea, being 1300 ft. lower than Johannesburg. Built in a hollow surrounded by hills, the aspect of the town with the river flowing through it and its broad streets lined with willows is picturesque. In summer the heat and moisture are excessive, and the Aapies (which is spanned by four bridges) is liable to floods.

The town is regularly laid out in rectangular blocks of uniform width. The older part lies on the west side of the Aapies River and between it and a smaller stream known as the Spruit. In the centre of this part of Pretoria is Church Square, so named from the Dutch Reformed Church which stood in it, but was demolished in 1905. Government buildings on the south side of the square contain the chambers of the Provincial Council and other public offices. They were erected in 1892 and are a handsome block in Renaissance style, three-storied, with a central tower surmounted by a statue of Liberty. On the north side of the square are the law courts, on the west side the Post Office. The chief banking offices are also in the square.

Running east and west from Church Square is Church Street, the chief business thoroughfare. A little east of Church Square this street opens on to Market Square, with commodious market buildings. The former Presidency, the residence of Paul Kruger, is at the western end of the street near the Spruit. Opposite it is the Doppe Church, in which Kruger used occasionally to preach. Other churches in the heart of the town include the Anglican cathedral, dedicated to St Alban, and the Presbyterian Church, both in Schoemans Street, the Roman Catholic Church in Koch Street with schools, convent buildings and extensive grounds, and the new Dutch Reformed Church in Vermeulen Street. In the north of the town is the National Museum and adjacent are the Zoological Gardens. Other public buildings are the government library, the University College and the opera house. East of the Aapies and on the slopes of the hills are the residential districts of Arcadia, Sunnyside and Muckleneuk. Bryntirion, a suburb on the northern slopes of the hills, contains the residences of the chief officials, including Government House. Here is McIntjes Kop, with a broad natural shelf midway below the summit. This shelf was chosen in 1909 as the site of the public offices of the Union. The designs of Mr Herbert Baker were accepted for two large blocks of identical design connected by a semicircular colonnade (passing behind the narrow kloof which bisects the shelf). Besides other open spaces

there is Burger's park, originally planned, during the first British occupation, as a botanical garden. It is beautifully wooded and through it runs the Spruit. A park and sports ground at the western end of the town contains the pedestal for a statue of President Kruger. The statue itself remained for years at Lourenço Marques and appears to have been lost. Adjoining this park on the north is the cemetery. Among those buried there are Kruger and many of the British who fell during the war of 1899-1902. Signal Hill, which rises 400 ft. above the plain, is west of the park. The plateau at its foot was the site of the English laager during the war of 1880-81, and is now occupied by the central railway station and workshops. North of the cemetery is the prison, a building which replaces a notoriously insanitary gaol used during the republican régime.

The water supply of Pretoria is drawn from the source of the Aapies River, where rise magnificent springs. The Fountains, as they are called, are 3 m. west of Pretoria. Some 3 m. north of the town is the *Wonderboom*, an enormous wild fig-tree, the only one of its kind in the district. At West Fort, 7 m. from the town, is a leper asylum; at Waterval, 15 m. north, the British prisoners captured by the Boers up to the fall of Pretoria were confined. Thirty miles east by north of Pretoria is the Premier Diamond mine. Bronkhorst Spruit, where in December 1880 a detachment of British soldiers was ambushed by the Boers, lies about 30 m. east by south of the town.

History.—Pretoria was founded in 1855, the ground on which it stands being purchased by the Boer government from Marthinus Pretorius. It was made the centre of a new district created at the same time, both town and district being named in honour of Andries Pretorius. By treaty between the South African Republic (then comprising the districts of Potchefstroom, Rustenburg, Pretoria and Zoutpansberg) and the republic of Lydenburg, concluded at Pretoria in 1860, the two republics were united and Pretoria chosen as the capital of the whole state, and in September of that year the Volksraad held its first meeting in the new capital. Until 1864, however, when the civil war in the Transvaal ended, Potchefstroom remained the virtual capital of the country. From that year the seat of government has always been at Pretoria. There in 1877 Sir Theophilus Shepstone proclaimed the annexation of the Transvaal to Great Britain. In December 1880 it was invested by the Boers, but held out until the conclusion of peace. In 1881 the convention restoring self-government to the Transvaal was signed at Pretoria. From that time until 1900 the dominating figure in the town was that of the president—Paul Kruger. As revenue flowed in from the gold-mines on the Rand many fine buildings were erected in the capital, which was placed in railway communication with Cape Town in 1893 and with Lourenço Marques and Durban in 1895. To Pretoria Dr Jameson and his troopers were brought prisoners (January 1896) after the fight at Doornkop (to be handed over in a few days to the British government), and thither also were brought the Reform Committee prisoners from Johannesburg. In May 1900 Kruger fled from the town, which on the 5th of June surrendered without resistance to Lord Roberts, despite its formidable encircling forts, which however were never effectively armed. On the 31st of May 1902 the articles of peace whereby the Boer leaders recognized British sovereignty were signed at Pretoria, and five years later there assembled in the capital the first parliament of the Transvaal as a self-governing state of the British Empire. On the establishment of the Union of South Africa in 1910 Pretoria became its administrative capital, the seat of the legislature being however at Cape Town. The Transvaal parliament was replaced by a Provincial Council (see *TRANSVAAL: § History*).

The town is governed by a municipality, which since 1903 has acquired control of the sanitary service, water supply, electric lighting and tramways. In 1909 the proportional representation system was adopted for the election of town councillors.

PRETORIUS, the family name of two of the early leaders of the "Trek" Boers—Andries Wilhelmus Jacobus Pretorius and Marthinus Wessels Pretorius, father and son.

1. **ANDRIES PRETORIUS** (1799-1853), a Dutch farmer of Graaff-Reinet, Cape Colony, and a descendant from one of the earliest Dutch settlers in South Africa, left his home in the Great

Trek, and by way of what is now the Orange Free State crossed the Drakensberg into Natal, where he arrived in November 1838, at a time when the emigrants there were without a recognized leader. Pretorius was at once chosen commandant-general and speedily collected a force to avenge the massacre of Piet Retief and his party, who had been treacherously killed by the Zulu king Dingaan the previous February. Pretorius's force was attacked on the 16th of December ("Dingaan's Day") by over 20,000 Zulus, who were beaten off with a loss of 3000 men. In January 1840 Pretorius with a commando of 400 burghers helped Mpande in his revolt against his brother Dingaan and was the leader of the Natal Boers in their opposition to the British. In 1842 he besieged the small British garrison at Durban, but retreated to Maritzburg on the arrival of reinforcements under Colonel (subsequently Sir) Josias Cloete and afterwards exerted his influence with the Boers in favour of coming to terms with the British. He remained in Natal as a British subject, and in 1847 was chosen by the Dutch farmers there to lay before the governor of Cape Colony the grievances under which they laboured owing to the constant immigration of natives, to whom locations were assigned to the detriment of Boer claims. Pretorius went to Grahams Town, where Sir Henry Pottinger (the governor) then was; but Sir Henry refused to see him or receive any communication from him. Pretorius returned to Natal determined to abandon his farm and once more trek beyond the British dominions. With a considerable following he was preparing to cross the Drakensberg when Sir Harry Smith, newly appointed governor of the Cape, reached the emigrants' camp on the Tugela (Jan. 1848). Sir Harry promised the farmers protection from the natives and persuaded many of the party to remain, but Pretorius departed, and on the proclamation of British sovereignty up to the Vaal fixed his residence in the Magalisberg, north of that river. He was chosen by the burghers living on both banks of the Vaal as their commandant-general. At the request of the Boers at Winburg Pretorius crossed the Vaal in July and led the anti-British party in their "war of freedom," occupying Bloemfontein on the 20th of the same month. In August he was defeated at Boomplaats by Sir Harry Smith and thereupon retreated north of the Vaal, where he became leader of one of the largest of the parties into which the trans-Vaal Boers were divided, and commandant-general of Potchefstroom and Rustenburg, his principal rival being Commandant-General A. H. Potgieter. In 1851 he was asked by the Boer malcontents in the Orange River Sovereignty and by the Basuto chief Moshesh to come to their aid, and he announced his intention of crossing the Vaal to "restore order" in the Sovereignty. His object, however, was rather to obtain from the British an acknowledgment of the independence of the Transvaal Boers. The British cabinet having decided on a policy of abandonment, the proposal of Pretorius was entertained. A reward of £2000 which had been offered for his apprehension after the Boomplaats fight, was withdrawn, Pretorius met the British commissioners at a farm near the Sand River, and with them concluded the convention (Jan. 17, 1852) by which the independence of the Transvaal Boers was recognized by Great Britain. Pretorius recrossed the Vaal and at Rustenburg on the 16th of March was reconciled to Potgieter, the followers of both leaders approving the convention, though the Potgieter party was not represented at the Sand River. In the same year Pretorius paid a visit to Durban with the object of opening up trade between Natal and the new republic. He also in 1852 attempted to close the road to the interior through Bechuanaland and sent a commando to the western border against Sechele. During this expedition David Livingstone's house at Kolobeng was looted. Pretorius died at his home at Magalisberg on the 23rd of July 1853. He is described by Theal as "the ablest leader and most perfect representative of the Emigrant Farmers." In 1855 a new district and a new town were formed out of the Potchefstroom and Rustenburg districts and named Pretoria in honour of the late commandant-general.

2. MARTINIUS PRETORIUS (1819-1901), the eldest son of

Andries, was appointed in August 1853 to succeed his father as commandant-general of Potchefstroom and Rustenburg, two of the districts into which the Transvaal was then divided. In 1854 he led his burghers against a chief named Makapan, who had murdered a party of twenty-three Boers, including ten women and children. The natives were blockaded in a great cave in the Zoutpansberg and about 3000 were starved to death or shot as they attempted to escape. Having thus chastised Makapan's clan, Pretorius turned his energies to the creation of a strong central government, and from 1856 onward his dominating idea appears to have been the formation of one Boer state to include the Orange River burghers. In December 1856 representatives of the districts of Potchefstroom, Rustenburg and Pretoria met and drew up a constitution and on the 6th of January the "South African Republic" was formally constituted. Pretorius having been elected president on the previous day. Though the Boers of the Lydenburg, Utrecht and Zoutpansberg districts refused to acknowledge the new republic, Pretorius, with the active co-operation of Commandant Paul Kruger (afterwards President Kruger), endeavoured (1857) to bring about the union of the Orange Free State and the Transvaal, and a commando crossed the Vaal to support Pretorius. The attempt at coercion failed, but in December 1859 the partisans of Pretorius in the Free State secured his election as president of that republic. Pretorius had just effected a reconciliation of the Lydenburg Boers with those of the other districts of the Transvaal, and hoping to complete his work of unification he accepted the presidency of the Free State, assuming office at Bloemfontein in February 1860. But the condition of anarchy into which the Transvaal fell shortly afterwards effectually weaned the Free State burghers from any thought of immediate amalgamation with their northern neighbours. Pretorius however continued to intervene in the affairs of the Transvaal and at length (April 15, 1863) resigned his Free State presidency. Acting as mediator between the various Transvaal parties Pretorius in January 1864 succeeded in putting an end to the civil strife and in May following once more became president of the South African Republic—now for the first time a united community. Conciliation was a marked feature of his character and to Pretorius more than any other man was due the welding of the Transvaal Boers into one nation. Pretorius shared the ideas of his father and the Emigrant Farmers generally concerning the title of the state to indefinite expansion north, east and west. Although he had much difficulty in maintaining the authority of the republic over the natives within its recognized borders, yet in April 1868, on the report of gold discoveries at Tati, he issued a proclamation annexing to the Transvaal on the west the whole of Bechuanaland and on the east territory up to and including part of Delagoa Bay. As to Delagoa Bay Portugal at once protested and in 1869 its right to the bay was acknowledged by Pretorius, who in the same year was re-elected president. The right of the Boers to the whole of Bechuanaland was not pressed by Pretorius in the face of British opposition, but in 1870, when the discovery of diamonds along the lower Vaal had led to the establishment of many diggers' camps, an attempt was made to enforce the claims of the Transvaal to that district. Pretorius aroused the hostility of the diggers by granting an exclusive concession to one firm. Realizing his mistake, the concession was cancelled and in September 1870 he issued a proclamation notable as offering to the diggers very large powers of self-government. Pretorius went to the western frontier and in repeated conferences with the Bechuana chiefs attempted to get them to acknowledge the Boer contention and by joining the Transvaal to "save" their territory from the British. His diplomacy failed, and finally, without consulting his colleagues, he agreed to refer the question of the boundary to the arbitration of Mr R. W. Keate, then lieutenant-governor of Natal. The award, given on the 17th of October 1871, was against the Boer claims. Pretorius loyally accepted the decision, but it aroused a storm of indignation in the Transvaal. The Volksraad refused to ratify the award and Pretorius resigned the presidency (November 1871).

From this time Pretorius took little further part in public affairs until after the first annexation of the state by Great Britain. In 1878 he acted as chairman of the committee of Boer leaders who were seeking the restoration of the independence of their country, and for his action in that capacity he was arrested in January 1880 by order of Sir Garnet Wolseley on a charge of treason. (See the BLUE BOOK [C. 2584] of 1880 for details of this charge.) He was admitted to bail and shortly afterwards urged by Wolseley to accept a seat on the executive council. This offer Pretorius declined, but he consented to tour the country with a proclamation by Wolseley counselling the Boers to submit, and promising them self-government. In December of the same year he was appointed, with Paul Kruger and P. Joubert, to carry on the government on the part of the insurgent Boers. He was one of the signatories to the Pretoria Convention and continued to act as a member of the Triumvirate until the election of Kruger as president in May 1883. He then withdrew from public life; but lived to see the country re-annexed to Great Britain, dying at Potchefstroom on the 19th of May 1901. He is stated to have disapproved the later developments of Krugerism, and within four months of his death visited Louis Botha and Schalk Burger, on behalf of Lord Kitchener, with the object of bringing the war to an end.

For the elder Pretorius see G. M. Theal, *Compendium of the History and Geography of South Africa*, 3rd ed. (London, 1878), and *History of South Africa*, vol. iv. [1834-1854] (London, 1893). For the younger Pretorius see vol. v. of the same series.

PRETTY, a word usually applied in the sense of pleasing in appearance, without connoting those qualities which are described as beautiful or handsome. In Old English *praetlig* meant tricky, cunning or wily, and is thus used to translate the Latin *sagax, astutus, callidus*, in a vocabulary of about 1000. *Praetl* meant a trick, and this word is seen in many forms in Dutch, cf. the words *prettig*, sportive, *part*, trick. A connexion has been suggested with the Greek *πρακτικός, πράττειν*, to do, make, through Latin *practica*, practice, performance; but the *New English Dictionary* rejects these, as also Celtic sources, as unfounded. From "cunning" to skilful, and thence to its use as a term of general appreciation as is so often used by Pepys, the development is easy.

PREVARICATION, a divergence from the truth, equivocation, quibbling, a want of plain-dealing or straightforwardness, especially a deliberate misrepresentation by evasive answers, often used as a less offensive synonym for a lie. The Latin *praevericatio* was specifically applied to the conduct in an action at law in which an advocate (*praevericator*) in collusion with his opponent put up a bad case of defence. *Praevericare* meant literally to walk with the legs very wide apart, to straddle, hence to walk crookedly, to stray from the direct road, *varicus*, straddling, being derived from *varus*, bow-legged, a word which has been connected etymologically with German *quer*, transverse, across, and English "queer."

PREVEZA, or PREVES, a seaport of Albania, European Turkey, in the vilayet of Iannina; at the entrance to the Gulf of Arta, an inlet of the Ionian Sea. Pop. (1905), 6500, of whom about four-fifths are Christian Albanians or Greeks, and one-fifth Moslems. The town is surrounded by dense olive groves, and most of its houses stand in their own gardens. The harbour is small, and closed to large vessels by a bar of sand; but it is a port of call for the Austrian Lloyd steamers, and annually accommodates about 1500 small vessels, the majority of which are engaged in the coasting trade. Preveza exports dairy produce, valonia, hides and wool, olives and olive oil. The yearly value of its trade varies from about £70,000 to £80,000. About 3 m. north are the ruins of Nicopolis (*q.v.*).

PRÉVOST, ANTOINE FRANÇOIS (1697-1763), French author and novelist, was born at Hesdin, Artois, on the 1st of April 1697. He first appears with the full name of Prévost d'Exiles in a letter to the booksellers of Amsterdam in 1731. His father, Liévin Prévost, was a lawyer, and several members of the family had embraced the ecclesiastical estate. Prévost was educated at the Jesuit school of Hesdin, and in 1713 became a novice of

the order in Paris, pursuing his studies at the same time at the college of La Flèche. At the end of 1716 he left the Jesuits to join the army, but he soon tired of life in barracks, and returned to Paris in 1719 with the idea, apparently, of resuming his novitiate. He is said to have travelled in Holland about this time; in any case he returned to the army, this time with a commission. Some of his biographers have assumed that he suffered some of the misfortunes assigned to his hero Des Grieux. However that may be, he joined in 1719-1720 the learned community of the Benedictines of St Maur, with whom he found refuge, he himself says, after the unlucky termination of a love affair. He took the vows at Jumièges in 1721 after a year's novitiate, and received in 1726 priest's orders at St Germer de Flaix. He resided for seven years in various houses of the order, teaching, preaching and studying. In 1728 he was at the abbey of St Germain-des-Prés, Paris, where he was engaged on the *Gallia christiana*, the learned work undertaken by the monks in continuation of the works of Denys de Sainte-Marthe, who had been a member of their order. His restless spirit made him seek from the Pope a transfer to the easier rule of Cluny; but without waiting for the brief, he left the abbey without leave (1728), and, learning that his superiors had obtained a *lettre de cachet* against him, fled to England.

In London he acquired considerable knowledge of English history and literature, traceable throughout his writings. Before leaving the Benedictines Prévost had begun his most famous romance, *Mémoires et aventures d'un homme de qualité qui s'est retiré du monde*, the first four volumes of which were published in Paris in 1728, and two years later at Amsterdam. In 1729 he left England for Holland, where he began to publish (Utrecht, 1730) a romance, the material of which, at least, had been gathered in London—*Le Philosophe anglois, ou Histoire de Monsieur Cleveland, fils naturel de Cromwell, écrite par lui-même, et traduite de l'anglois* (Paris 1731-1739, 8 vols., but most of the existing sets are partly Paris and partly Utrecht). A spurious fifth volume (Utrecht, 1734) contained attacks on the Jesuits, and an English translation of the whole appeared in 1734. Meanwhile, during his residence at the Hague, he engaged on a translation of the *Historia* of De Thou, and, relying on the popularity of his first book, published at Amsterdam a *Suite* in three volumes, forming volumes v., vi., and vii. of the original *Mémoires et aventures d'un homme de qualité*. The seventh volume contained the famous *Manon Lescaut*, separately published in Paris in 1731 as *Les Aventures du chevalier des Grieux et de Manon Lescaut, par Monsieur D...* The book was eagerly read, chiefly in pirated copies, as it was forbidden in France. In 1733 he left the Hague for London in company with a lady whose character, as given by Prévost's enemies, was far from desirable. In London he edited a weekly gazette on the model of Addison's *Spectator*, *Le Pour et contre*, which he continued to produce, with short intervals, until 1740.

In the autumn of 1734 Prévost was reconciled with the Benedictines, and, returning to France, was received in the Benedictine monastery of La Croix-Saint-Leufroy in the diocese of Evreux to pass through a new, though brief, novitiate. In 1735 he was dispensed from residence in a monastery by becoming almoner to the prince de Conti, and in 1754 obtained the priory of St Georges de Gesnes. He continued to produce novels and translations from the English, and, with the exception of a brief exile (1741-1742) spent in Brussels and Frankfort, he resided for the most part at Chantilly until his death, which took place suddenly while he was walking in the neighbouring woods on the 23rd of December 1763. Hideous particulars have been added, but the cause of his death, the rupture of an aneurism, has been definitely established. Stories of crime and disaster were related of Prévost by his enemies, and diligently repeated, but they have proved to be as apocryphal as the details given of his death.

Manon Lescaut, one of the greatest novels of the century, is very short; it is entirely free from improbable incident, it is penetrated by the truest and most cunningly managed feeling; and almost every one of its characters is a triumph of that analytic portraiture which is the secret of the modern novel. The chevalier des Grieux, the hero, is probably the most perfect example of the carrying out of the sentiment "All for love and the world well lost" that exists in fiction, at least where the circumstances are those of ordinary and probable life. Tiberge, his friend, is hardly inferior in the difficult part of mentor and reasonable man. Lescaut, the heroine's brother, has vigorous touches as a bully and Bohemian; but the triumph of the book is Manon herself. Animated by a real affection

for her lover, and false to him only because her love of splendour, comfort and luxury prevents her from welcoming privation with him or for him, though in effect she prefers him to all others, perfectly natural and even amiable in her degradation, and yet showing the moral of that degradation most vividly, Manon is one of the most remarkable heroines in all fiction. She had no literary ancestress; she seems to have sprung entirely from the imagination, or perhaps the sympathetic observation, of the wandering scholar who drew her. Only the *Princesse de Clèves* can challenge comparison with her before or near to her own date, and in *Manon Lescaut* the plot is much more complete and interesting, the sentiments less artificial, and the whole story nearer to actual life than in *Madame de la Fayette's* masterpiece. Prevost's other works include: *Le Doyen de Killérine, histoire morale, composée sur les mémoires d'une illustre famille d'Irlande* (Paris, 1735; 2nd part, the Hague, 1739, 3rd, 4th and 5th parts, 1740); *Tout pour l'amour* (1735), a translation of Dryden's tragedy; *Histoire d'une Grecque moderne* (Amsterdam [Paris] 2 vols., 1740); *Histoire de Marguerite d'Anjou* (Amsterdam [Paris] 2 vols., 1740); *Mémoires pour servir à l'histoire de Malle* (Amsterdam, 1741); *Campagnes philosophiques, ou mémoires... contenant l'histoire de la guerre d'Irlande* (Amsterdam, 1741); *Histoire de Guillaume le Conquérant* (Paris, 1742); *Histoire générale des voyages* (15 vols., Paris, 1746-1759), continued by other writers; translations from Samuel Richardson, *Pomela* (4 vols., 1742), *Lettres anglaises ou Histoire de Miss Clarisse Harlowe* (6 vols., London, 1741); *Nouvelles lettres anglaises, ou Histoire du chevalier Grandisson* (Amsterdam, 3 vols., 1755); *Mémoires pour servir à l'histoire de la vertu* (Cologne, 4 vols., 1762), from Mrs Sheridan's *Mémoires of Miss Sidney Bidulph*; *Histoire de la maison de Stuart* (3 vols., 1740) from Hume's *History of England to 1688*; *Le Monde morale, ou Mémoires pour servir à l'histoire du cœur humain* (2 vols., Geneva, 1760), &c.

For the bibliography of Prevost's works, which presents many complications, and for documentary evidence of the facts of his life see H. HARRISSE, *L'Abbé Prevost* (1896); also a thesis (1898) by V. Schroeder.

PRÉVOST, CONSTANT (1787-1856), French geologist, was born in Paris on the 4th of June 1787, and was son of Louis Prévost, receiver of the rentes of that city. He was educated at the Central Schools, where, inspired by the lectures of G. Cuvier, Alexandre Brongniart and A. Duméril, he determined to devote himself to natural science. He took his degree in Letters and Sciences in 1811, and for a time pursued the study of medicine and anatomy. Mainly through the influence of Brongniart he turned his attention to geology, and during the years 1816-1819 made a special study of the Vienna Basin where he pointed out for the first time the presence of Tertiary strata like those of the Paris Basin, but including a series of later date. His next work (1821) was an essay on the geology of parts of Normandy, with special reference to the Secondary strata, which he compared with those of England. From 1821-1829 he was professor of geology at the Athenaeum at Paris, and he took a leading part with Ami Boué, G. P. Deshayes and Jules Desnoyers in the founding of the Geological Society of France (1830). In 1831 he became assistant professor and afterwards honorary professor of geology to the faculty of sciences. Having studied the volcanoes of Italy and Auvergne, he opposed the views of von Buch regarding craters of elevation, maintaining that the cones were due to the material successively erupted. Like Lyell he advocated a study of the causes or forces now in action in order to illustrate the past. One of his more important memoirs was *De la Chronologie des terrains et du synchronisme des formations* (1845). He died in Paris on the 17th of August 1856.

Memoir with portrait, by J. Gosselet, *Ann. soc. géol. du nord*, tome xxv. 1896.

PRÉVOST, EUGÈNE MARCEL (1862-), French novelist, was born in Paris on the 1st of May 1862. He was educated at Jesuit schools in Bordeaux and Paris, entering the École Polytechnique in 1882. He published a story in the *Clairon* as early as 1881, but for some years after the completion of his studies he applied his technical knowledge to the manufacture of tobacco. He published in succession, *Le Scorpion* (1887), *Chonchette* (1888), *Mademoiselle Jauffre* (1889), *Cousine Laura* (1890), *La Confession d'un amant* (1891), *Lettres de femmes* (1892), *L'Automne d'une femme* (1893), and in 1894 he made a great sensation by an exaggerated and revolting study of the results of Parisian education and Parisian society on young

girls, *Les Demi-vierges*, which was dramatized and produced with great success at the Gymnase on the 21st of May 1895. *Le Jardin secret* appeared in 1897; and in 1900 *Les Vierges fortes*, and a study of the question of women's education and independence in two novels *Frédérique* and *Léa*. *L'Heureux ménage* (1901), *Les Lettres à Françoise* (1902), *La Princesse d'Erminge* (1904), and *L'Accordeur aveugle* (1905) are among his later novels. An amusing picture of modern German manners is given in his *Monsieur et Madame Moloch* (1906). He had a great success in 1904 with a four act play *La Plus faible*, produced at the Comédie Française. In 1909 he was elected to the Academy.

PRÉVOST, PIERRE (1751-1839), Swiss philosopher and physicist, son of a Protestant clergyman in Geneva, was born in that city on the 3rd of March 1751, and was educated for a clerical career. But he forsook it for law, and this too he quickly deserted to devote himself to education and to travelling. He became intimate with J. J. Rousseau, and, a little later, with Dugald Stewart, having previously distinguished himself as a translator of and commentator on Euripides. Frederick II. of Prussia secured him in 1780 as professor of philosophy, and made him member of the Akademie der Wissenschaften in Berlin. He there became acquainted with Lagrange, and was thus led to turn his attention to physical science. After some years spent on political economy and on the principles of the fine arts (in connexion with which he wrote, for the *Berlin Memoirs*, a remarkable dissertation, on poetry) he returned to Geneva and began his work on magnetism and on heat. Interrupted occasionally in his studies by political duties, in which he was often called to the front, he remained professor of philosophy at Geneva till he was called in 1810 to the chair of physics. He died at Geneva on the 8th of April 1839.

Prevost published much on philology, philosophy, and political economy; but he will be remembered mainly for having published, with additions of his own, the *Traité de physique* of G. L. Le Sage, and for his enunciation of the law of exchange in radiation. His scientific publications included *De l'Origine des forces magnétiques* (1788), *Recherches physico-mécaniques sur la chaleur* (1792), and *Essai sur le calbrique rayonnant* (1809).

PRÉVOST-PARADOL, LUCIEN ANATOLE (1829-1870), French man of letters, was born in Paris on the 8th of August 1829. He was educated at the Collège Bourbon and entered the École Normale. In 1855 he was appointed professor of French literature at Aix. He held the post, however, barely a year, resigning it to become a leader-writer on the *Journal des débats*. He also wrote in the *Courrier du dimanche*, and for a very short time in the *Presse*. His chief works are *Essais de politique et de littérature* (three series, 1859-1866), and *Essais sur les moralistes français* (1864). He was, however, rather a journalist than a writer of books, and was one of the chief opponents of the empire on the side of moderate liberalism. He underwent the usual difficulties of a journalist under that régime, and was once imprisoned. In 1865 he was elected an Academician. The accession of Émile Ollivier to power was fatal to Prévost-Paradol, who apparently believed in the possibility of a liberal empire, and consequently accepted the appointment of envoy to the United States. This was the signal for the most unmeasured attacks on him from the republican party. He had scarcely installed himself in his post before the outbreak of war between France and Prussia occurred. He shot himself at Washington on the 11th of July 1870, and died on the 20th.

PREY (O. Fr. *preie*, mod. *proie*, Lat. *praeda*, booty, from *prae* and the root *hed*—seen in *prehendere*, *prendre*, to grasp), booty, spoil, plunder taken in war, by robbery, or other violent means; particularly the quarry, the animal killed for food by a carnivorous animal; a beast or bird of prey. A particular usage for that which is saved from any trial of strength or battle is familiar from the Bible (Jer. xxi. 9) "his life shall be unto him for a prey."

PRIAM (Gr. *Ἰπλάμος*), in Greek legend, the last king of Troy, son of Laomedon and brother of Tithonus. Little is known of him before the Trojan War, which broke out when he was advanced in years. According to Homer (*Iliad*, iii. 184) in his

youth he fought on the side of the Phrygians against the Amazons. He had fifty sons and fifty daughters, and possessed immense wealth. He appears only twice on the scene of action during the war—to make arrangements for the duel between Paris and Menelaus, and to beg the body of Hector for burial from Achilles, whom he visits in his tent by night. He was said to have been slain by Neoptolemus, son of Achilles, during the sack of Troy (Virgil, *Aeneid*, ii. 512). See under ΤΡΟΥ, on the legends.

PRIAPEIA, a collection of poems (about eighty in number) in various metres on the subject of Priāpus. It was compiled from literary works and inscriptions on images of the god by an unknown editor, who composed the introductory epigram. From their style and versification it is evident that the poems belong to the best period of Latin literature. Some, however, may be interpolations of a later period. They will be found in F. Bücheler's *Petronius* (1904), L. Müller's *Catullus* (1870), and E. Bährens, *Poetae latini minores*, i. (1879).

PRIAPULOIDEA, a small group of vermiform marine creatures; they have been usually placed in the neighbourhood of the Gephyrea, but their position is uncertain and it is doubtful if they are to be regarded as coelomate animals. They are cylindrical worm-like animals, with a median anterior mouth quite devoid of any armature or tentacles. The body is ringed, and often has circles of spines, which are continued into the slightly protrusible pharynx. The alimentary canal is straight, the anus terminal, though in *Priapulus* one or two hollow ventral diverticula of the body-wall stretch out behind it. The nervous system, composed of a ring and a ventral cord, retains its primitive connexion with the ectoderm. There are no specialized sense-organs or vascular or respiratory systems. There is a wide body-cavity, but as this has no connexion with the renal or reproductive organs it cannot be regarded as a coelom, but probably is a blood-space or haemocoel.

The Priapuloidea are dioecious, and their male and female organs, which are one with the excretory organs, consist of a pair of branching tufts, each of which opens to the exterior on one side of the anus. The tips of these tufts enclose a flame-cell similar to those found in Platyhelminths, &c., and these probably function as excretory organs. As the animals become adult, diverticula arise on the tubes of these organs, which develop either spermatozoa or ova. These pass out through the ducts. Nothing is known of the development. There are three genera: (i.) *Priapulus*, with the species *P. caudatus*, Lam., of the Arctic and Antarctic and neighbouring cold seas, and *P. bicaudatus*, Dan., of the north Atlantic and Arctic seas; (ii.) *Priapuloides australis*, de Guerne, of the southern circumpolar waters; and (iii.) *Halicryptus*, with the species *H. spinulosus*, v. Sieb., of northern seas. They live in the mud, which they eat, in comparatively shallow waters up to 50 fathoms.

AUTHORITIES.—Apel, *Zeitschr. wiss. Zool.* (1885), vol. xlii.; Scharff, *Quart. Journ. Mic. Sci.* (1885), vol. xxv.; Ehlers, *Zeitschr. wiss. Zool.* (1861), vol. xi.; Schauinsland, *Zool. Anz.* (1886), vol. ix.; De Guerne, *Mission scientifique du Cap Horn* (1891), vol. vi.; Michaelsen, *Jahrb. Hamburg-Aust.* (1888), vol. vi. (A. E. S.)

PRIĀPUS, in Greek mythology, son of Dionysus (or Adonis or Hermes) and Aphrodite (or Chione). He is unknown to Homer and Hesiod. The chief seat of his worship was the coast of the Hellespont, especially at Lampsacus, which claimed to be his birthplace. Thence his cult extended to Lydia, and by way of the islands of Lesbos and Thasos to the whole of Greece (especially Argolis), whence it made its way to Italy, together with that of Aphrodite. Priapus is the personification of the fruit-

fulness of nature. Sailors invoked him in distress and fishermen prayed to him for success. He gradually came to be regarded as the god of sensuality. His symbol was the phallus, an emblem of productivity and a protection against the evil eye. The first fruits of the gardens and fields, goats, milk and honey, and occasionally asses, were offered to him. He was sometimes represented as an old man, with a long beard and large genitals, wearing a long Oriental robe and a turban or garland of vine-leaves, with fruit and bunches of grapes in his lap. Amongst the Romans, rough wooden images, after the manner of the hermae, with phallus stained with vermilion, were set up in gardens. His image was placed on tombs, as symbolizing the doctrine of regeneration and a future life, and his name occurs on sepulchral inscriptions. In his hand he carried a bill-hook or club, while a reed on his head, shaking backwards and forwards in the wind, acted as a scarecrow.

PRIBILOF ISLANDS (often called the Fur Seal Islands, Russian equivalent, "Kotovi"), a group of four islands, part of Alaska, lying in Bering Sea in about 56° 50' N. and 170° W., about 200 m. N. of Unalaska and 200 m. S. of Cape Newenham, the nearest point on the mainland. The principal islands are St Paul (about 35 sq. m.; 13 m. long, from N.E. to S.W.; maximum width about 6 m.; named from St Peter and St Paul's Day, on which it was discovered) and St George (about 27 sq. m.; 10 m. long, maximum width, 4 m.; probably named after Pribilof's ship) about 30 m. S.E.; Otter and Walrus islets, the former covering about 4 sq. m., and the latter merely a reef covering about 64 acres, are near St Paul. In 1907 the native population was 263—170 on St Paul and 93 on St George. Only agents of the United States or employés of the lessees are permitted as residents on the islands. The islands are hilly and volcanic—Bogoslof, a crater on St Paul, is 600 ft. high—without harbours, and have a mean annual temperature of about 35-7° F., and a rainfall of about 35 in. There are only two seasons—rainy summers lasting from May to October, and dry winters from November to April. The flora is restricted to ferns, mosses and grasses, though there are some creeping willows and small shrubs. The largest seal rookery, containing about 80 % of the seals in the Pribilofs, is on St Paul. The seals found here are a distinct variety (*Callorhinus alascanus*) with much better fur than that of any other variety. Besides the fur seal there are blue and grey foxes (more on St George than on St Paul), and on St George Island and on the Walrus reef there are great bird rookeries—the breeding places of immense numbers of gulls, sea-parrots, auks, cormorants and arries (*Lomvia arra*).

The islands were first sighted in 1767 by Joan Synd, and were visited in 1786 by Gerasim Pribilof, who discovered the fur seal rookeries for which they became famous. From Russia the islands passed with Alaska to the United States in 1867. From 1870 to 1890 the United States government leased the islands to the Alaska Commercial Company. In 1890-1910 the North American Commercial Company held the monopoly. But the industry shrank considerably owing to pelagic sealing. The season during which land hunting is allowed on the islands includes June, July, September and October. (See also SEAL and BERING SEA ARBITRATION.)

PRIBRAM, a town of Bohemia, Austria, 39 m. S.W. of Prague by rail. Pop. (1900), 13,576, together with the adjoining township of Birkenberg, 19,119, almost exclusively Czech. It lies in a valley between the hills of Birkenberg and Heiliger Berg, and in its neighbourhood are the lead and silver mines which belong to the Austrian government and are worked in nine shafts, two of which, the Adalbert shaft (3637 ft.) and the Maria shaft, (3575 ft.) are the deepest in the world. The mines have been worked for several centuries, but their actual prosperity dates from 1770, when the sinking of the Adalbert shaft began. They yield yearly an average of 80,000 lb of silver and 1000 tons of lead. At the top of the Heiliger Berg (1889 ft.) is a church with a wonder-working image of the Virgin, which is the chief place of pilgrimage in Bohemia.

PRICE, BARTHOLOMEW (1818-1898), English mathematician and educationist, was born at Coln St Denis, Gloucestershire,

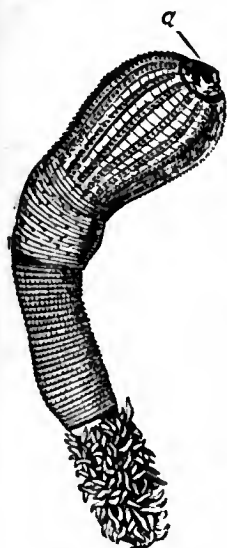

Priapulus caudatus
Lam. (Nat. size.) a,
Mouth, surrounded by
spines.

in 1818. He was educated at Pembroke College, Oxford, of which college (after taking a first class in mathematics in 1840 and gaining the university mathematical scholarship in 1842) he became fellow in 1844 and tutor and mathematical lecturer in 1845. He at once took a leading position in the mathematical teaching of the university, and published treatises on the *Differential calculus* (in 1848) and the *Infinitesimal calculus* (4 vols., 1852-1860), which for long were the recognized textbooks there. This latter work included the differential and integral calculus, the calculus of variations, the theory of attractions, and analytical mechanics. In 1853 he was appointed Sedleian professor of natural philosophy, resigning it in June 1898. His chief public activity at Oxford was in connexion with the hebdomadal council, and with the Clarendon Press, of which he was for many years secretary. He was also a curator of the Bodleian Library, an honorary fellow of Queen's College, a governor of Winchester College and a visitor of Greenwich Observatory. In 1891 he was elected Master of Pembroke College, which dignity carried with it a canonry of Gloucester Cathedral. He died on the 29th of December 1898. See *Monthly Notices of the Royal Astronomical Society* (1899).

PRICE, BONAMY (1807-1888), English political economist, was born at St Peter Port, Guernsey, on the 22nd of May 1807. He entered at Worcester College, Oxford, in 1825, where he took a double first in 1829. From 1830 to 1850 he was an assistant master at Rugby school. He then lived for some years in London, being engaged in business and literary work, and was appointed to serve on various royal commissions. He married in 1864. In 1868 he was elected Drummond professor of political economy at Oxford, and was thrice re-elected to the post, which he held till his death. In 1883 he was elected an honorary fellow of his college. In addition to his professorial work, he was in much request as a popular lecturer on political economy. He died in London on the 8th of January 1888. His principal publications, exclusive of pamphlets, were: *The Principles of Currency* (1869), *Currency and Banking* (1876), *Chapters on Practical Political Economy* (1878).

PRICE, RICHARD (1723-1791), English moral and political philosopher, son of a dissenting minister, was born on the 23rd of February 1723, at Tynton, Glamorganshire. He was educated privately and at a dissenting academy in London, and became chaplain and companion to a Mr Streatfield at Stoke Newington. By the death of Mr Streatfield and of an uncle in 1756 his circumstances were considerably improved, and in 1757 he married a Miss Sarah Blundell, originally of Belgrave in Leicestershire.

In 1767 he published a volume of sermons, which gained him the acquaintance of Lord Shelburne, an event which had much influence in raising his reputation and determining the character of his subsequent pursuits. It was, however, as a writer on financial and political questions that Price became widely known. In 1769, in a letter to Dr Franklin, he wrote some observations on the expectation of lives, the increase of mankind, and the population of London, which were published in the *Philosophical Transactions* of that year; in May 1770 he communicated to the Royal Society a paper on the proper method of calculating the values of contingent reversions. The publication of these papers is said to have exercised a beneficial influence in drawing attention to the inadequate calculations on which many insurance and benefit societies had recently been formed. In 1769 Price received the degree of D.D. from the university of Glasgow. In 1771 he published his *Appeal to the Public on the Subject of the National Debt* (ed. 1772 and 1774). This pamphlet excited considerable controversy, and is supposed to have influenced Pitt in re-establishing the sinking fund for the extinction of the national debt, which had been created by Walpole in 1716 and abolished in 1733. The means, however, which Price proposed for the extinction of the debt are described by Lord Overstone¹ as "a sort of hocus-pocus machinery," supposed to work "without loss to any one," and consequently unsound.

¹ Lord Overstone reprinted in 1857, for private circulation, Price's and other rare tracts on the national debt and the sinking fund.

Price then turned his attention to the question of the American colonies. He had from the first been strongly opposed to the war, and in 1776 he published a pamphlet entitled *Observations on Civil Liberty and the Justice and Policy of the War with America*. Several thousand copies of this work were sold within a few days; a cheap edition was soon issued; the pamphlet was extolled by one set of politicians and abused by another; amongst its critics were Dr Markham, archbishop of York, John Wesley, and Edmund Burke; and Price rapidly became one of the best-known men in England. He was presented with the freedom of the city of London, and it is said that his pamphlet had no inconsiderable share in determining the Americans to declare their independence. A second pamphlet on the war with America, the debts of Great Britain, and kindred topics followed in the spring of 1777. His name thus became identified with the cause of American independence. He was the intimate friend of Franklin; he corresponded with Turgot; and in the winter of 1778 he was invited by Congress to go to America and assist in the financial administration of the states. This offer he refused from unwillingness to quit his own country and his family connexions. In 1781 he received the degree of D.D. from Yale College.

One of Price's most intimate friends was Dr Priestley, in spite of the fact that they took the most opposite views on morals and metaphysics. In 1778 appeared a published correspondence between these two liberal theologians on the subjects of materialism and necessity, wherein Price maintains, in opposition to Priestley, the free agency of man and the unity and immateriality of the human soul. Both Price and Priestley were what would now vaguely be called "Unitarians," though they occupied respectively the extreme right and the extreme left position of that school. Indeed, Price's opinions would seem to have been rather Arian than Socinian.

The pamphlets on the American War made Price famous. He preached to crowded congregations, and, when Lord Shelburne acceded to power, not only was he offered the post of private secretary to the premier, but it is said that one of the paragraphs in the king's speech was suggested by him and even inserted in his words. In 1786 Mrs Price died. There were no children by the marriage, his own health was failing, and the remainder of his life appears to have been clouded by solitude and dejection. The progress of the French Revolution alone cheered him. On the 19th of April 1791 he died, worn out with suffering and disease.

The philosophical importance of Price is entirely in the region of ethics. The *Review of the Principal Questions in Morals* (1757, 3rd ed. revised 1787) contains his whole theory. It is divided into ten chapters, the first of which, though a small part of the whole, completes his demonstration of ethical theory. The remaining chapters investigate details of minor importance, and are especially interesting as showing his relation to Butler and Kant (ch. iii. and ch. vii.). The work is professedly a refutation of Hutcheson, but is rather constructive than polemical. The theory he propounds is closely allied to that of Cudworth, but is interesting mainly in comparison with the subsequent theories of Kant.

I. Right and wrong belong to actions *in themselves*. By this he means, not that the ethical value of actions is independent of their motive and end (see ch. vi), but rather that it is unaffected by consequences, and that it is more or less invariable for intelligent beings. II. This ethical value is perceived by reason or understanding (which, unlike Kant, he does not distinguish), which intuitively recognizes fitness or congruity between actions, agents and total circumstances. Arguing that ethical judgment is an act of discrimination, he endeavours to invalidate the doctrine of the moral sense (see SHAFESBURY and HUTCHESON). Yet, in denying the importance of the emotions in moral judgment, he is driven back to the admission that right actions must be "grateful" to us; that, in fact, moral approbation includes both an act of the understanding and an emotion of the heart. Still it remains true that reason alone, in its highest development, would be a sufficient guide. In this conclusion he is in close agreement with Kant; reason is the arbiter, and right is (1) not a matter of the emotions and (2) not relative to imperfect human nature. Price's main point of difference with Cudworth is that while Cudworth regards the moral criterion as a *visus* or modification of the mind, existing in germ and developed by circumstances, Price regards it as acquired from the contemplation of actions, but acquired necessarily, immediately, intuitively. In his view of disinterested action (ch. iii.) he adds

nothing to Butler. III. Happiness he regards as the *only* end, conceivable by us,¹ of divine Providence, but it is a happiness wholly dependent upon rectitude. Virtue tends always to happiness, and in the end must produce it in its perfect form.

Works.—Besides the above-mentioned, Price wrote an *Essay on the Population of England* (2nd ed., 1780); two Fast-day Sermons, published respectively in 1779 and 1781; and *Observations on the importance of the American Revolution and the means of rendering it a benefit to the World* (1784). A complete list of his works is given as an appendix to Dr Priestley's *Funeral Sermon*. His views on the French Revolution are denounced by Burke in his *Reflections on the Revolution in France*. Notices of Price's ethical system occur in Mackintosh's *Progress of Ethical Philosophy*, Jouffroy's *Introduction to Ethics*, Whewell's *History of Moral Philosophy in England*; Bain's *Mental and Moral Sciences*. See also ETHICS, and T. Fowler's monograph on Shaftesbury and Hutcheson. For Price's life see memoir by his nephew, William Morgan. (J. M. M.)

PRICE, the equivalent in money for which a commodity is sold or purchased, the value of anything expressed in terms of a medium of exchange (see VALUE and WEALTH). The word is a doublet of "praise," commendation, eulogy, Lat. *laus*, and "prize," a reward of victory, the ultimate source of which is the Lat. *pretium*; the Aryan root *par-*, to buy, is seen in Skr. *pana*, wages, reward, Gr. *πράσκειν*, to sell, &c. The O. Fr. *pris*, mod. *prix*, was taken from a Late Latin form *precium*, and had the various meanings of the English, "price," "prize," and "praise"; it was adapted in English as *pris* or *prise* and was gradually differentiated in form for the different meanings; thus "praise" was developed from an earlier verbal form *preise* or *preyse* in the 15th century; the original meaning survives in "appraise," to set a value to anything, cf. the current meaning of "to prize," to value highly. "Prize," reward, does not appear as a separate form till the 16th century. In "prize-fight," a boxing contest for money, the idea of reward seems clear, but the word appears earlier than the form "prize" in this sense and means a contest or match, and may be a different word altogether; the *New English Dictionary* compares the Greek use of *ἀθλον*, literally reward, hence contest. "Prize" in the sense of that which is captured in war, especially at sea, is a distinct word. It comes through the Fr. *prise*, early Romanic *presa* for *prensa*, from Lat. *præhendere*, to seize, capture. For the international law on the subject see PRIZE.

PRICHARD, JAMES COWLES (1786-1848), English physician and ethnologist, was born on the 11th of February 1786 at Ross in Herefordshire. His parents were of the Society of Friends, and he was educated at home, especially in modern languages and general literature. He adopted medicine as a profession mainly because of the facilities it offered for anthropological investigations. He took his M.D. at Edinburgh, afterwards reading for a year at Trinity College, Cambridge, whence, joining the Church of England, he migrated to St John's College, Oxford, afterwards entering as a gentleman commoner at Trinity College, Oxford, but taking no degree in either university. In 1810 he settled at Bristol as a physician, and in 1813 published his *Researches into the Physical History of Man*, in 2 vols., afterwards extended to 5 vols. The central principle of the book is the primitive unity of the human species, acted upon by causes which have since divided it into permanent varieties or races. The work is dedicated to Blumenbach, whose five races of man are adopted. But where Prichard excelled Blumenbach and all his other predecessors was in his grasp of the principle that people should be studied by combining all available characters. One investigation begun in this work requires special mention, the bringing into view of the fact, neglected or contradicted by philologists, that the Celtic nations are allied by language with the Slavonian, German and Pelagian (Greek and Latin), thus forming a fourth European branch of the Asiatic stock (which would now be called Indo-European or Aryan). His special treatise containing Celtic compared with Sanskrit words appeared in 1831 under the title *Eastern Origin of the Celtic nations*. It is remarkable that the essay by Adolphe Pictet, *De l'Affinité des langues celtiques avec le sanscrit*, which was crowned by the French Academy and made its author's reputation, should have been published in 1837 in evident

ignorance of the earlier and in some respects stricter investigations of Prichard.

In 1843 Prichard published his *Natural History of Man*, in which he reiterated his belief in the specific unity of man, pointing out that "the same inward and mental nature is to be recognized in all the races." Prichard may fairly be honoured with the title of the founder of the English branch of the sciences of anthropology and ethnology. In 1811 he was appointed physician to St Peter's hospital, Bristol, and in 1814 to the Bristol infirmary. In 1822 he published *Treatise on Diseases of the Nervous System* (pt. i.), and in 1835 a *Treatise on Insanity and other Disorders affecting the Mind*, in which he advanced the theory of the existence of a distinct mental disease, "moral insanity." In 1842, following up this suggestion, he published *On the different forms of Insanity in relation to Jurisprudence designed for the use of Persons concerned in Legal Questions regarding Unsoundness of Mind*. In 1845 he was made a commissioner in lunacy, and removed to London. He died there three years later, on the 23rd of December, of rheumatic fever. At the time of his death he was president of the Ethnological Society and a fellow of the Royal Society. Among his less important works were: *A Review of the Doctrine of a Vital Principle* (1829); *On the Treatment of Hemiplegia* (1831); *On the Extinction of some Varieties of the Human Race* (1839); *Analysis of Egyptian Mythology* (1819).

See Memoir by Dr Thomas Hodgkin (1798-1866) in the *Journal of the Ethnological Society* (Feb. 1849); Memoir read before the Bath and Bristol branch of the Provincial Medical and Surgical Association (March 1849) by Dr J. A. Symonds (*Journ. Eth. Soc.*, 1850); *Prichard and Symonds in Special Relation to Mental Science*, by Dr Hack Tuke (1891).

PRICK POSTS, an old architectural name given sometimes to the queen posts of a roof, and sometimes to the filling in quarters in framing. (See POST and PANE.)

PRIDE, THOMAS (d. 1658), parliamentarian general in the English Civil War, is stated to have been brought up by the parish of St Bride's, London. Subsequently he was a drayman and a brewer. At the beginning of the Civil War he served as a captain under the earl of Essex, and was gradually promoted to the rank of colonel. He distinguished himself at the battle of Preston, and with his regiment took part in the military occupation of London in December 1648, which was the first step towards bringing the king to trial. The second was the expulsion of the Presbyterian and Royalist elements in the House of Commons, for which Pride is chiefly remembered. This, resolved by the army council and ordered by the lord general, Fairfax, was carried out by Colonel Pride's regiment. Taking his stand at the entrance of the House of Commons with a written list in his hand, he caused the arrest or exclusion of the obnoxious members, who were pointed out to him. After about a hundred members had been thus dealt with ("Pride's Purge"), the mutilated House of Commons proceeded to bring the king to trial. Pride was one of the judges of the king and signed his death-warrant, appending to his signature a seal showing a coat of arms. He commanded an infantry brigade under Cromwell at Dunbar and Worcester. He took no conspicuous part in Commonwealth politics, except in opposing the proposal to confer the kingly dignity on Cromwell. He was knighted by the Protector in 1656, and was also chosen a member of the new House of Lords. He died at Nonsuch House, an estate which he had bought in Surrey, on the 23rd of October 1658. After the Restoration his body was ordered to be dug up and suspended on the gallows at Tyburn along with those of Cromwell, Ireton and Bradshaw, though it is said that the execution of this sentence was evaded.

Noble, *Lives of the Regicides*; Bate, *Lives of the Prime Actors and Principal Contrivers of the Murder of Charles I.*; Carlyle, *Cromwell's Letters and Speeches*.

PRIDEAUX, HUMPHREY (1648-1724), English divine and Oriental scholar, was born of good family at Place, in Cornwall, on the 3rd of May 1648, and received his early education at the grammar schools of Liskeard and Bodmin. In 1665 he was placed at Westminster under Busby, and in 1668 went on to

Christ Church, Oxford, where he took his degrees in the following order: B.A., 1672; M.A., 1675; B.D., 1682; and D.D., 1686. His account of the famous Arundel marbles just given to the university appeared in 1676. In 1679 he was appointed to the rectory of St Clement's, Oxford, and Hebrew lecturer at Christ Church, where he continued until February 1686, holding for the last three years the rectory of Bladon with Woodstock. In 1686 he exchanged for the benefice of Saham in Norfolk. The sympathies of Prideaux inclined to Low Churchism in religion and to Whiggism in politics, and he took an active part in the controversies of the day, publishing the following pamphlets: "The Validity of the Orders of the Church of England" (1688), "Letter to a Friend on the Present Convocation" (1690), "The Case of Clandestine Marriages stated" (1691). Prideaux was promoted to the archdeaconry of Suffolk in December 1688, and to the deanery of Norwich (he had long been one of the canons) in June 1702. In 1694 he was obliged, through ill health, to resign the rectory of Saham, and after having held the vicarage of Trowse for fourteen years (1696-1710) he found himself incapacitated from further parochial duty. He died at Norwich on the 1st of November 1724.

Many of the dean's writings were of considerable value. His *Life of Mahomet* (1697) was really a polemical tract against the deists and has now no biographical value. Both it and his *Directions to Churchwardens* (1701) passed through several editions. Even greater success attended *The Old and New Testament connected in the History of the Jews* (1716), a work which not only displayed but stimulated research. Biographical details of his numerous publications and of his manuscripts are given in the *Bibliotheca Cornubiensis*, ii. 527-533, and iii. 1319. A volume of his letters to John Ellis, some time under-secretary of state, was edited by E. M. Thompson for the Camden Society in 1875; they contain a vivid picture of Oxford life after the Restoration. An anonymous life (probably by Thomas Birch) appeared in 1748; it was mainly compiled from information furnished by Prideaux's son Edmund.

PRIE, JEANNE AGNES BERTHELOT DE PLÉNEUF, MARQUISE DE (1698-1727), French adventuress, was the daughter of a rich but unscrupulous father and an immoral mother. At the age of fifteen she was married to Louis, marquis de Prie, and went with him to the court of Savoy at Turin, where he was ambassador. She was twenty-one when she returned to France, and was soon the declared mistress of Louis Henri, duc de Bourbon. During his ministry (1723-1725) she was in several respects the real ruler of France, her most notable triumph being the marriage of Louis XV. to Marie Leszczyńska instead of to Mlle de Vermandois. But when, in 1725, she sought to have Bourbon's rival Fleury exiled, her ascendancy came to an end. After Fleury's recall and the banishment of Bourbon to Chantilly Mme de Prie was exiled to Courbépine, where she committed suicide the next year.

See M. H. Thirion, *Madame de Prie* (Paris, 1905).

PRIE-DIEU, literally "pray God," strictly a prayer desk, primarily intended for private use, but often found in churches of the European continent. It is a small ornamental wooden desk furnished with a sloping shelf for books, and a cushioned kneeling piece. It appears not to have received its present name until the early part of the 17th century. At that period in France a small room or oratory was sometimes known by the same name. A similar form of chair, in domestic furniture, is called prie-dieu by analogy.

PRIEGO DE CORDOBA, a town of southern Spain in the extreme S.E. of the province of Cordova, near the headwaters of the river Guadajoz, and on the northern slope of the Sierra de Priego. Pop. (1900), 16,902. The district abounds in cattle and mules and agricultural products, especially wine and oil. The local industries also include tanning and manufactures of esparto fabrics, rugs and cotton goods. The oldest church was built in the 13th century and subsequently restored; it has a fine chapel. There are ruins of an old castle—Priego having been a fortified city of the Moors which was captured by the Christians in 1226, lost again, and finally retaken in 1407.

PRIENE (mod. *Samsun kale*), an ancient city of Ionia on the foot-hills of Mycale, about 6 m. N. of the Maeander. It was

formerly on the sea coast, but now lies some miles inland. It is said to have been founded by Ionians under Aegyptus, a son of Neleus. Sacked by Ardyss of Lydia, it revived and attained great prosperity under its "sage," Bias, in the middle of the 6th century. Cyrus captured it in 545; but it was able to send twelve ships to join the Ionian revolt (500-494). Disputes with Samos, and the troubles after Alexander's death, brought Priene low, and Rome had to save it from the kings of Pergamum and Cappadocia in 155. Orophernes, the rebellious brother of the Cappadocian king, who had deposited a treasure there and recovered it by Roman intervention, restored the temple of Athena as a thankoffering. Under Roman and Byzantine dominion Priene had a prosperous history. It passed into Moslem hands late in the 13th century. The ruins, which lie on successive terraces, were the object of missions sent out by the English Society of Dilettanti in 1765 and 1868, and have been thoroughly laid open by Dr Th. Wiegand (1895-1899) for the Berlin Museum. The city, as rebuilt in the 4th and 3rd centuries, was laid out on a rectangular scheme. It faced south, its acropolis rising nearly 700 ft. behind it. The whole area was enclosed by a wall 7 ft. thick with towers at intervals and three principal gates. On the lower slopes of the acropolis was a shrine of Demeter. The town had six main streets, about 20 ft. wide, running east and west and fifteen streets about 10 ft. wide crossing at right angles, all being evenly spaced; and it was thus divided into about 80 *insulae*. Private houses were apportioned four to an *insula*. The systems of water-supply and drainage can easily be discerned. The houses present many analogies with the earliest Pompeian. In the western half of the city, on a high terrace north of the main street and approached by a fine stairway, was the temple of Athena Polias, a hexastyle peripteral Ionic structure built by Pythias, the architect of the Mausoleum. Under the basis of the statue of Athena were found in 1870 silver tetradrachms of Orophernes, and some jewelry, probably deposited at the time of the Cappadocian restoration. Fronting the main street is a series of halls, and on the other side is the fine market place. The municipal buildings, Roman gymnasium, and well preserved theatre lie to the north, but, like all the other public structures, in the centre of the plan. Temples of Isis and Asclepius have been laid bare. At the lowest point on the south, within the walls, was the large stadium, connected with a gymnasium of Hellenistic times.

See Society of Dilettanti, *Ionian Antiquities* (1821), vol. ii.; Th. Wiegand and H. Schrader, *Priene* (1904); on inscriptions (360) see Hiller von Gärtringen, *Inschriften von Priene* (Berlin, 1907), with collection of ancient references to the city. (D. G. H.)

PRIEST (Ger. *Priester*, Fr. *prêtre*), the contracted form of "presbyter" (*πρεσβύτερος*, "elder"; see **PRESBYTER**), a name of office in the early Christian Church, already mentioned in the New Testament. But in the English Bible the presbyters of the New Testament are called "elders," not "priests"; the latter name is reserved for ministers of pre-Christian religions, the Semitic *כֹּהֲנִים* (*kōhānim*, sing. *kōhēn*) and *כֹּמָרִים* (*kemārīm*), or the Greek *ιερείς*. The reason of this will appear more clearly in the sequel; it is enough to observe at present that, before our English word was formed, the original idea of a presbyter had been overlaid with others derived from pre-Christian priest-hoods, so that it is from these and not from the etymological force of the word that we must start in considering historically what a priest is. The theologians of the Greek and Latin churches expressly found the conception of a Christian priesthood on the hierarchy of the Jewish temple, while the names by which the sacerdotal character is expressed—*ιερείς*, *sacerdos*—originally designated the ministers of sacred things in Greek and Roman heathenism, and then came to be used as translations into Greek and Latin of the Hebrew *kōhēn*. *Kōhēn*, *ιερείς*, *sacerdos*, are, in fact, fair translations of one another; they all denote a minister whose stated business was to perform, on behalf of the community, certain public ritual acts, particularly sacrifices, directed godwards. Such ministers or priests existed in all the great religions of ancient civilization. The term

"priest" is sometimes taken to include "sorcerer," but this use is open to criticism and may produce confusion.

The close inter-relation which existed in primitive society between magic, priesthood and kingship has been indicated by Frazer in his *Early History of the Kingship*. His remarks throw some light on the early character of priesthood as well as kingship. "When once a special class of sorcerers has been segregated from the community and entrusted by it with the discharge of duties on which the public safety and welfare are believed to depend, these men gradually rise to wealth and power till their leaders blossom out into sacred kings." According to Frazer's view, "as time goes on the fallacy of magic becomes more and more apparent and is slowly displaced by religion; in other words the magician gives way to the priest. Hence the king starting as a magician tends gradually to exchange the practice of magic for the functions of prayer and sacrifice." We are not concerned here with the debatable question whether magic preceded religion. Probably magic was always accompanied by some primitive form of animism whether the Melanesian *mana* or fetishism (see Dr Haddon's *Magic and Fetishism*, pp. 58-62, 64-90).

The investigations which have been carried on in recent years by King, Tallquist and Zimmern, as well as by Brünnow and Craig, on the magic and ritual of Babylonia and Assyria have been fruitful of results. The question, however, remains to be settled how far the officials and their functions, which in the much more highly developed civilization of Babylonia came to be differentiated and specialized, can be strictly included under the functions of priesthood. The answer to this question will be in many cases negative or affirmative according to our strict adherence or the reverse to the definition of the priest set forth above as "a minister whose stated business it was to perform on behalf of the community certain ritual acts, in some cases sacrifices (or the recitation of prayers), directed Godwards." On the other hand the seer, diviner and prophet is a minister whose function it is to communicate God's will or word to man. This is not a distinction which governs Zimmern and other writers. Our chief source of information is Zimmern's *Beiträge zur Kenntniss der Babylon: Religion*, pp. 81-95, from which Lagrange in his *Études sur les religions sémitiques*² has chiefly derived his materials (ch. vi. p. 222 sqq.) respecting Babylonia and Assyria. Zimmern's results are summarized in *K.A.T.*³ p. 589 sqq. Here we find magic and soothsaying closely intertwined with priestly functions as, we shall see, was the case in early Hebrew pre-exilian days with the Kōhēn. It must be borne in mind that primitive humanity is not governed by logical distinctions. Among the Babylonians and Assyrians the *barû* (from *barû* to see, inspect) was a soothsaying priest who was consulted whenever any important undertaking was proposed, and addressed his inquiries to Samaš the sun god (or Adad) as *bēl biri* or lord of the oracle (accompanied by the sacrifice of lambs). The signs were usually obtained from the inspection of the liver (according to Johns, that of the lamb that was sacrificed); or it took place through birds; hence the name in this case given to the *barû* of *dagil iššurē* "bird inspector." Johns, however, is disposed to regard him as a distinct functionary. Sometimes divination took place through vessels filled with water and oil (see OMEN and DIVINATION).

As contrasted with the *barû* or soothsaying priest, as he is called by Zimmern, we have the *ašipu*, who was the priest-magician who dealt in conjurations (*šiptu*), whereby diseases were removed, spells broken, or in expiations whereby sins were expiated. Tallquist's edition of the *Maklû* series of incantations and his explanations of the ritual, and also the publications by Zimmern of the *Surpu* series of tablets in his *Beiträge* have rendered us familiar with the functions of the *ašipu*. See article "Magic" in Hastings's *Dict. Bible*, where examples are given of incantations with magical by-play. Also compare Jastrow's *Religion of Babylonia* (1898), ch. xvi., "The Magical Texts," where a fuller treatment will be found. Now, as the conjurations were addressed to the deity, *ašipu*, according to the definition given above, comes more reasonably under the category

of priest. But the priest belongs to the realm of religion proper, which involves a relation of dependence on the superior power, whereas the *ašipu* belongs to the realm of magic, which is coercive and seeks "to constrain the hostile power to give way" (Lagrange).

There was also a third kind of priest called the *zammaru*, whose function it was to sing hymns.

In the earlier period of the Assyrian monarchy we find the king holding the office of *pa-le-si* or *išakku* or (more definitely) the *šangu*, i.e. priest of Ašur, the patron-deity of Assyria. This high-priestly office towards the tutelary deity of the nation appears to have belonged to the king by virtue of his royal rank. In Babylonia under the last empire (except in the case of Nebuchadrezzar, who calls himself *palesi šri*, "exalted priest," *K.I.B.* iii. p. 60) no such high-priestly function attached to the king, for in Babylonia the priesthoods were endowed with great wealth and power, and even the king stood in awe of them (see Johns, *Babylonian and Assyrian Laws, Contracts and Letters*, p. 212 sqq). These powerfully-organized priesthoods, as well as the elaborate nature of their ritual and apparatus of worship, must have deeply and permanently impressed the exiled Jewish community. Thus arose the more developed system of Ezekiel's scheme (xl.-xlviii.) and of the Priestercode and the high dignity which became attached to the person of the High Priest (reflected in the narrative of Uzziah's leprosy in 2 Chron. xxvi. 16-20). Other parallels to the sacerdotal system of the Priestercode may here be noted. (1) According to Zimmern the *barû* and the *ašipu* formed close guilds and the office passed from father to son. This is certainly true of the *šangûtu* or priesthood, which was connected with a special family attached to a particular temple and its worship. (2) Johns also points out the existence of the *rab-barû*, chief soothsayer, and the *rab-mašmašu* or chief magician. (3) Bodily defects (as squinting, lack of teeth, maimed finger) was disqualifications for priesthood (cf. Lev. xxi. 17 sqq.). (4) In the ritual tablets for the *ašipu* published in Zimmern's *Beiträge*, No. 26, col. iii. 19 sqq., we read "that the *mašmašu* (priest's magician) is to pass forth to the gateway, sacrifice a sheep in the palace portal, and to smear the threshold and posts of the palace gateway right and left with the blood of the lamb." We are reminded of Exod. xii. 7 (P). (5) The Babylonian term *kuppuru* (infin. Pael) is used of the magician-priest or *ašipu* and means "wipe out." This confirms the view that the Hebrew *kipper*, which appears to be a late word (specially employed in Ezek. and P.), originally had the meaning which belongs to the Aramaic viz. "wipe off" and not "cover" as in Arabic. Zimmern thinks that the meaning "atone" "expiate," which belongs to the Pael form of the root k-p-r in both Aramaic and Arabic was borrowed from the Babylonian (cf. Driver's note in "Deuteronomy," *Int. Commentary*, p. 425 sqq., and especially his article "Propitiation" in Hastings's *Dict. Bible*).

The Rev. C. H. W. Johns, to whom reference has already been made, demurs (in a communication to the writer) to the fusion of the priest and the magician, and to the custom of "calling every unknown official a priest or a eunuch." "If a Babylonian said *šangu* he meant one thing, by *iššipu* another, and by *ramku* another. I do not deny that the same man might unite all three functions in one person. Thus a *šangu* had a definite share in the offerings, a *mašmašu* a different share. It seems to me that the priests belonged to the old families who were descended from the original tribe or clan, &c., that founded the city, and they could not admit outsiders save by adoption into the family. If a new god had a temple set up he had a new set of priests, but this priesthood descended in its line, e.g. a Samaš priest did not beget a man who became a priest of Nabû. Further 'priest' implied a peculiar relation to the god. A soothsayer was a general practitioner in his art, not attached to any one god or temple. Anyone could be a *ramku* who actually poured out libations; that a priest usually did it was no exception to that rule. The priest was only a sort of specialist in the practice. The priest also offered prayer, interceded, &c. I cannot see that he taught. An oracle of the god came through him. If the *modus operandi* was akin to soothsaying it was only because that special form of soothsaying was peculiar to the particular cult of that god, and even this as a secondary development. I do not think that early priests received oracles save in dreams, &c. That magic early invaded religion is possible, but there are many traces of its being a foreign element. This is not usually pointed out."

Among the *ancient Egyptians* the local god was the protector and lord of the district. Consequently it was the interest and duty of the inhabitants to maintain the cultus of the patron-deity of their city who dwelt in their midst. Moreover, in the earlier times we find the prince of the nome acting as the High Priest of the local god, but in course of time the state, represented by the king, began to an ever-increasing degree to take oversight over the more important local cults. Thus we find that the Egyptian monarch was empowered to exercise priestly functions before all the gods. We constantly see him in the wall-paintings portrayed as a priest in the conventional attitudes before the images of the gods. In the chief sanctuaries the chief priests possessed special privileges, and it is probable that those in the immediate entourage of the king were elected to these positions. The highest nobility in the nome sought the honour of priesthood in the service of the local deity. One special class called *kher heb* were charged with reciting the divine formulae, which were popularly held to possess magical virtue. In the middle empire (VIIth to XIIth Dynasties) the lay element maintains its position in religious cultus despite its complexity. But under the new empire (Dynasties XVIIIth and following) the professional priest had attained to ominous power. The temples possessed larger estates and became more wealthy. Priests increased in number and were divided into ranks, and we find them occupying state offices, just as in Babylonia the priest acts as judge or inspector of canals (Johns, *Babyl. and Assyr. Laws*, &c., p. 213).

We now turn to the priesthood as we find it in ancient Greece and Italy. Homer knows special priests who preside over ritual acts in the temples to which they are attached; but his kings also do sacrifice on behalf of their people. The king, in fact, both in Greece and in Rome, was the acting head of the state religion, and when the regal power came to an end his sacred functions were not transferred to the ordinary priests, but either they were distributed among high officers of state, as archons and prytanes, or the title of "king" was still preserved as that of a religious functionary, as in the case of the *rex sacrorum* at Rome and the *archon basileus* at Athens. In the domestic circle the union of priesthood and natural headship was never disturbed; the Roman paterfamilias sacrificed for the whole family. On the other hand, *gentes* and *phratræ*, which had no natural head, had special priests chosen from their members; for every circle of ancient society, from the family up to the state, was a religious as well as a civil unity, and had its own gods and sacred rites. The lines of religious and civil society were identical, and, so long as they remained so, no antagonism could arise between the spiritual and the temporal power. In point of fact, in Greece and Rome the priest never attained to any considerable independent importance; we cannot speak of priestly power and hardly even of a distinct priestly class. In Greece the priest, so far as he is an independent functionary and not one of the magistrates, is simply the elected or hereditary minister of a temple charged with "those things which are ordained to be done towards the gods" (see Aristotle, *Pol.* vi. 8), and remunerated from the revenues of the temple, or by the gifts of worshippers and sacrificial dues. The position was often lucrative and always honourable, and the priests were under the special protection of the gods they served. But their purely ritual functions gave them no means of establishing a considerable influence on the minds of men, and the technical knowledge which they possessed as to the way in which the gods could be acceptably approached was neither so intricate nor so mysterious as to give the class a special importance. The funds of the temples were not in their control, but were treated as public moneys. Above all, where, as at Athens, the decision of questions of sacred law fell not to the priests but to the college of *ἐξηγηταί*, one great source of priestly power was wholly lacking. There remains, indeed, one other sacred function of great importance in the ancient world in which the Greek priests had a share. As man approached the gods in sacrifice and prayers, so too the gods declared themselves to men by divers signs and tokens, which it was possible to read by the

art of Divination (*q.v.*). In many nations divination and priesthood have always gone hand in hand; at Rome, for example, the augurs and the *XV viri sacrorum*, who interpreted the Sibylline books, were priestly colleges. In Greece, on the other hand, divination was not generally a priestly function, but it did belong to the priests of the Oracles (see ORACLE). The great oracles, however, were of Panhellenic celebrity and did not serve each a particular state, and so in this direction also the risk of an independent priestly power within the state was avoided.¹

In Rome, again, where the functions of the priesthood were politically much more weighty, where the technicalities of religion were more complicated, where priests interpreted the will of the gods, and where the pontiffs had a most important jurisdiction in sacred things, the state was much too strong to suffer these powers to escape from its own immediate control: the old monarchy of the king in sacred things descended to the inheritors of his temporal power; the highest civil and religious functions met in the same persons (cf. Cic. *De dom.* i. 1); and every priest was subject to the state exactly as the magistrates were, referring all weighty matters to state decision and then executing what the one supreme power decreed. And it is instructive to observe that when the plebeians extorted their full share of political power they also demanded and obtained admission to every priestly college of political importance, to those, namely, of the pontiffs, the augurs, and the *XV viri sacrorum*. The Romans, it need hardly be said, had no hereditary priests.²

We can only glance briefly at the ancient religions of India (Aryan). "In historical times the priesthood is rigidly confined to members of the Brahman caste, who are regarded as the representatives of God on earth. But there are indications that at an earlier date the Kshatriya or warrior caste often became priests. The power of the priesthood began with the delegation by the king of his sacrificial duties to a 'president' (*purohita*). This power grew with the growing importance of the sacrifice and the complication of its ceremonial. In the post-Vedic period 'right' or 'wrong' simply means the exact performance or the neglect, whether intentional or unintentional—of all the details of a prescribed ritual, the centre of which was the sacrifice. At this period the priestly caste gained its unbounded power over the minds of men" (Professor Rapson). For further details as to the development of the priestly caste and wisdom in India the reader must refer to BRAHMINISM; here it is enough to observe that among a religious people a priesthood which forms a close and still more an hereditary corporation, and the assistance of which is indispensable in all religious acts, must rise to practical supremacy in society except under the strongest form of despotism, where the sovereign is head of the Church as well as of the state.

Among the Zoroastrian Iranians, as among the Indian Aryans, the aid of a priest to recite the sacrificial liturgy was necessary at every offering (Herod. i. 132), and the Iranian priests (*âthravans*, later *Magi*) claimed, like the Brahmans, to be the highest order of society; but a variety of conditions were lacking to give them the full place of their Indian brethren. Zoroastrianism is not a nature religion, but the result of a reform which never, under the old empire, thoroughly penetrated the masses; and the priesthood, as it was not based on family tradition, did not form a strict hereditary caste. It was open to any one to obtain entrance into the priesthood, while on the other hand it was only as a priest that he could exercise sacerdotal functions, for these were strictly reserved to priests. Accordingly the clergy formed a compact hierarchy not inferior in influence to the clergy of the Christian middle ages, had great power in the state, and were often irksome even to the great king.

¹ For the Greek priests, see, besides Schömann and other works on Greek antiquities, Newton, *Essays on Art and Archaeology*, p. 136 seq. (from epigraphic material). See also for Greek as well as Roman priest, art. "Sacerdos" (*Sacerdotium*) in Warre Cornish's *Concise Dict. of Greek and Roman Antiquities*.

² On the Roman priests, see in general Marquardt, *Römische Staatsverwaltung*, vol. iii., and for the pontiffs in particular the art. "Sacerdos" in Warre Cornish's *Concise Dict.* also *Pontifex*.

But the best established hierarchy is not so powerful as a caste, and the monarchs had one strong hold on the clergy by retaining the patronage of great ecclesiastical places, and another in the fact that the Semitic provinces on the Tigris, where the capital lay, were mainly inhabited by men of other faith.¹

The duties of the priests were not restricted to the services of the temple, but they also took part in the household cults. The ritual had a mechanical character and was by no means attractive. It is impossible to enter into the manifold details of the fire cultus which forms the main part of the worship in the Avesta. They belong to an earlier period than the Zoroastrian, nor was this fire cultus restricted to the temples. Portable fire altars were carried about and the worship could be celebrated in any spot. It may be noted that in all the ceremonies in the religion of the Avesta, incantations, prayers and confessions play a very large part. The prevailing element in the incantations consists in the exorcism of devils. In fact, the Persian religion throughout all its multitude of purifications, observances and expiations was a constant warfare against impurity, death and the devil. Amid all the ceremonialism of its priesthood there were also high ideals set forth in Zoroastrian religion of what a priest should be. Thus we read in Vendidad xviii., "Many there be, noble Zarathustra, who bear the mouth bandage, who have yet not girded their loins with the law. If such a one says 'I am an Athravan' he lies, call him not Athravan, noble Zarathustra, said Ahura Mazda, but thou shouldst call him priest, noble Zarathustra, who sits awake the whole night through and yearns for holy wisdom that enables man to stand on death's bridge fearless and with happy heart, the wisdom whereby he attains the holy and glorious world of paradise."

In this rapid glance at some of the chief priesthoods of antiquity we have hitherto passed over the pure Semites, whose priesthoods call for closer examination because of the profound influence which one of them—that of the Jews—has exercised on Christianity, and so on the whole history of the modern world. But before we proceed to this it may be well to note one or two things that come out by comparison of the systems already before us. Priestly acts—that is, acts done by one and accepted by the gods on behalf of many—are common to all antique religions, and cannot be lacking where the primary subject of religion is not the individual but the natural community. But the origin of a separate priestly class, distinct from the natural heads of the community, cannot be explained by any such broad general principle; in some cases, as in Greece, it is little more than a matter of convenience that part of the religious duties of the state should be confided to special ministers charged with the care of particular temples, while in others the intervention of a special priesthood is indispensable to the validity of every religious act, so that the priest ultimately becomes a mediator and the vehicle of all divine grace. This position, we see, can be reached by various paths: the priest may become indispensable through the growth of ritual observances and precautions too complicated for a layman to master, or he may lay claim to special nearness to the gods on the ground, it may be, of his race, or, it may be, of habitual practices of purity and asceticism which cannot be combined with the duties of ordinary life, as, for example, celibacy was required of priestesses of Vesta at Rome. But the highest developments of priestly influence are hardly separable from something of magical superstition, the *opus operatum* of the priest has the power of a sorcerer's spell. The strength of the priesthood in Chaldaea and in Egypt stands plainly in the closest connexion with the survival of a magical element in the state religion, and Rome, in like manner, is more priestly than Greece, because it is more superstitious. In most cases, however, where an ancient civilization shows us a strong priestly system we are unable to make out in any detail the steps by which that system was elaborated; the clearest case perhaps is the priesthood of the Jews, which is not less interesting from its origin and growth

than from the influence exerted by the system long after the priests were dispersed and their sanctuary laid in ruins.

Among the nomadic Semites, to whom the Hebrews belonged before they settled in Canaan, there has never been any developed priesthood. The acts of religion partake of the general simplicity of desert life; apart from the private worship of household gods and the oblations and salutations offered at the graves of departed kinsmen, the ritual observances of the ancient Arabs were visits to the tribal sanctuary to salute the god with a gift of milk, first-fruits or the like, the sacrifice of firstlings and vows (see NAZARITE and PASSOVER), and an occasional pilgrimage to discharge a vow at the annual feast and fair of one of the more distant holy places (see MECCA). These acts required no priestly aid; each man slew his own victim and divided the sacrifice in his own circle; the share of the god was the blood which was smeared upon or poured out beside stone (*noṣḥ, ghabghab*) set up as an altar or perhaps as a symbol of the deity. It does not appear that any portion of the sacrifice was burned on the altar, or that any part of the victim was the due of the sanctuary. We find therefore no trace of a sacrificial priesthood, but each temple had one or more doorkeepers (*sādin, ḥājib*), whose office was usually hereditary in a certain family and who had the charge of the temple and its treasures. The sacrifices and offerings were acknowledgments of divine bounty and means used to insure its continuance; the Arab was the "slave" of his god and paid him tribute, as slaves used to do to their masters, or subjects to their lords; and the free Bedouin, trained in the solitude of the desert to habits of absolute self-reliance, knew no master except his god, and acknowledged no other will before which his own should bend. The voice of the god might be uttered in omens which the skilled could read, or conveyed in the inspired rhymes of soothsayers, but frequently it was sought in the oracle of the sanctuary, where the sacred lot was administered for a fee by the *sādin*. The sanctuary thus became a seat of judgment, and here, too, compacts were sealed by oaths and sacrificial ceremonies. These institutions, though known to us only from sources belonging to an age when the old faith was falling to pieces, are certainly very ancient. The fundamental type of the Arabic sanctuary can be traced through all the Semitic lands, and so appears to be older than the Semitic dispersion; even the technical terms are mainly the same, so that we may justly assume that the more developed ritual and priesthoods of the settled Semites sprang from a state of things not very remote from what we find among the heathen Arabs. Now among the Arabs, as we have seen, ritual service is the affair of the individual, or of a mass of individuals gathered in a great feast, but still doing worship each for himself and his own private circle; the only public aspect of religion is found in connexion with divination and the oracle to which the affairs of the community are submitted. In Greece and Rome the public sacrifices were the chief function of religion, and in them the priesthood represented the ancient kings. But in the desert there is no king and no sovereignty save that of the divine oracle, and therefore it is from the soothsayers or ministers of the oracle that a public ministry of religion can most naturally spring. With the beginning of a settled state the sanctuaries must rise in importance and all the functions of revelation will gather round them. A sacrificial priesthood will arise as the worship becomes more complex (especially as sacrifice in antiquity is a common preliminary to the consultation of an oracle), but the public ritual will still remain closely associated with oracle or divination, and the priest will still be, above all things, a revealer. That this was what actually happened may be inferred from the fact that the Canaanite and Phoenician name for a priest (*kōhēn*) is identical with the Arabic *kāhin*, a "soothsayer." Soothsaying was no modern importation in Arabia; its characteristic form—a monotonous croon of short rhyming clauses—is the same as was practised by the Hebrew "wizards who peeped and muttered" in the days of Isaiah, and that this form was native in Arabia is clear from its having a technical name (*saj'*), which in Hebrew survives only in derivative words with modified sense.² The *kāhin*, therefore, is not a degraded priest but such a soothsayer as is found in most primitive societies, and the Canaanite priests grew out of these early revealers. In point of fact some form of revelation or oracle appears to have existed in every great shrine of Canaan and Syria,³ and the importance of this element in the cultus may be measured from the fact that at Hierapolis it was the charge of the chief priest, just as in the Levitical legislation. But the use of "*kāhin*" for "priest" in the Canaanite area points to more than this: it is connected with the orgiastic character of Canaanite religion. The soothsayer differs from the priest of an oracle by giving his revelation under excitement and often in a frenzy allied to madness. In natural soothsaying this frenzy is the necessary physical accompaniment of an afflatus which, though it seems supernatural to a rude people, is really akin to poetic inspiration.

² *Mēshuggā'*, 2 Kings ix. 11, Jer. xxix. 26—a term of contempt applied to prophets. (See HEBREW RELIGION.)

³ For examples, see PALMYRA and PHILISTINES; see further, Lucian, *De dea syria*, 36, for Hierapolis; Zosimus i. 58, for Aphaca; Pliny, *H. N.* xxxvii. 58 (compared with Lucian, *ut supra*, and Movers, *Phoenizier*, i. 655), for the temple of Melkart at Tyre.

¹ Cf. especially Nöldeke's *Tabari*, p. 450 seq.

But it is soon learned that a similar physical state can be produced artificially, and at the Canaanite sanctuaries this was done on a large scale. We see from 1 Kings xviii., 2 Kings x., that great Baal temples had two classes of ministers, *kōhānim* and *nēbhīim*, "priests" and "prophets," and as the former bear a name which primarily denotes a soothsayer, so the latter are also a kind of priests who do sacrificial service with a wild ritual of their own. How deeply the orgiastic character was stamped on the priesthoods of north Semitic nature-worship is clear from Greek and Roman accounts, such as that of Appuleius (*Metam.* bk. viii.).

The Hebrews, who made the language of Canaan their own, took also the Canaanite name for a priest. But the earliest forms of Hebrew priesthood are not Canaanite in character; the priest, as he appears in the older records of the time of the Judges, Eli at Shiloh, Jonathan in the private temple of Micah and at Dan, is much liker the *sādin* than the *kāhin*.¹ The whole structure of Hebrew society at the time of the conquest was almost precisely that of a federation of Arab tribes, and the religious ordinances are scarcely distinguishable from those of Arabia, save only that the great deliverance of the Exodus and the period when Moses, sitting in judgment at the sanctuary of Kadesh, had for a whole generation impressed the sovereignty of Jehovah on all the tribes, had created an idea of unity between the scattered settlements in Canaan such as the Arabs before Mahomet never had. But neither in civil nor in religious life was this ideal unity expressed in fixed institutions, the old individualism of the Semitic nomad still held its ground. Thus the firstlings, first-fruits and vows are still the free gift of the individual which no human authority exacts, and which every householder presents and consumes with his circle in a sacrificial feast without priestly aid.

As in Arabia, the ordinary sanctuary is still a sacred stone (קִדְּוָה = *noyb*) set up under the open heaven, and here the blood of the victim is poured out as an offering to God (see especially 1 Sam. xiv. 34, and cf. 2 Sam. xxxiii. 16, 17). The priest has no place in this ritual; he is not the minister of an altar,² but the guardian of a temple, such as was already found here and there in the land for the custody of sacred images and palladia or other consecrated things (the ark at Shiloh, 1 Sam. iii. 3; images in Micah's temple, Judges xvii. 5; Goliath's sword lying behind the "ephod" or plated image at Nob, 1 Sam. xxi. 9; no doubt also money, a sin the Canaanite temple at Shechem, Judges ix. 4). Such treasures required a guardian; but, above all, wherever there was a temple there was an oracle, a kind of sacred lot, just as in Arabia (1 Sam. xiv. 41, Sept.), which could only be drawn where there was an "ephod" and a priest (1 Sam. xiv. 18, Sept., and xxiii. 6 seq.). The Hebrews had already possessed a tent-temple and oracle of this kind in the wilderness (Exod. xxxiii. 7 seq.), of which Moses was the priest and Joshua the aedituus, and ever since that time the judgment of God through the priest at the sanctuary had a greater weight than the word of a seer, and was the ultimate solution of every controversy and claim (1 Sam. ii. 25; Exod. xxi. 6, xxii. 8, 9, where for "judge," "judges," of A.V. read "God" with R.V.). The temple at Shiloh, where the ark was preserved, was the lineal descendant of the Mosaic sanctuary—for it was not the place but the palladium and its oracle that were the essential thing—and its priests claimed kin with Moses himself. In the divided state of the nation, indeed, this sanctuary was hardly visited from beyond Mt Ephraim; and every man or tribe that cared to provide the necessary apparatus (ephod, teraphim, &c.) and hire a priest might have a temple and oracle of his own at which to consult Jehovah (Judges xvii., xviii.); but there was hardly another sanctuary of equal dignity. The priest of Shiloh is a much greater person than Micah's priest Jonathan; at the great

feasts he sits enthroned by the doorway, preserving decorum among the worshippers; he has certain legal dues, and, if he is disposed to exact more, no one ventures to resist (1 Sam. ii. 12 seq., where the text needs a slight correction). The priestly position of the family survived the fall of Shiloh and the capture of the ark, and it was members of this house who consulted Jehovah for the early kings until Solomon deposed Abiathar. Indeed, though priesthood was not yet tied to one family, so that Micah's son, or Eleazar of Kirjath-jearim (1 Sam. vii. 1), or David's sons (2 Sam. viii. 18) could all be priests, a Levite—that is, a man of Moses' tribe—was already preferred for the office elsewhere than at Shiloh (Judges xvii. 13), and such a priest naturally handed down his place to his posterity (Judges xviii. 30).

Ultimately, indeed, as sanctuaries were multiplied and the priests all over the land came to form one well-marked class, "Levite" and legitimate priest became equivalent expressions, as is explained in the article LEVITES. But between the priesthood of Eli at Shiloh or of Jonathan at Dan and the priesthood of the Levites as described in Deut. xxxiii. 8 seq. there lies a period of the inner history of which we know almost nothing. It is plain that the various priestly colleges regarded themselves as one order, that they had common traditions of law and ritual which were traced back to Moses, and common interests which had not been vindicated without a struggle (Deut., *ut supra*). The kingship had not deprived them of their functions as fountains of divine judgment (cf. Deut. xvii. 8 seq.); on the contrary, the decisions of the sanctuary had grown up into a body of sacred law, which the priests administered according to a traditional precedent. According to Semitic ideas the declaration of law is quite a distinct function from the enforcing of it, and the royal executive came into no collision with the purely declaratory functions of the priests. The latter, on the contrary, must have grown in importance with the unification and progress of the nation, and in all probability the consolidation of the priesthood into one class went hand in hand with a consolidation of legal tradition. And this work must have been well done, for, though the general corruption of society at the beginning of the Assyrian period was nowhere more conspicuous than at the sanctuaries and among the priesthood, the invective of Hos. iv. equally with the eulogium of Deut. xxxiii. proves that the position which the later priests abused had been won by ancestors who earned the respect of the nation as worthy representatives of a divine Torah.

The ritual functions of the priesthood still appear in Deut. xxxiii. as secondary to that of declaring the sentence of God, but they were no longer insignificant. With the prosperity of the nation, and especially through the absorption of the Canaanites and of their holy places, ritual had become much more elaborate, and in royal sanctuaries at least there were regular public offerings maintained by the king and presented by the priests (cf. 2 Kings xvi. 15). Private sacrifices, too, could hardly be offered without some priestly aid now that ritual was more complex; the provision of Deut. xviii. as to the priestly dues is certainly ancient, and shows that besides the tribute of first-fruits and the like the priests had a fee in kind for each sacrifice, as we find to have been the case among the Phoenicians according to the sacrificial tablet of Marseilles. Their judicial functions also brought profit to the priests, fines being exacted for certain offences and paid to them (2 Kings xii. 16; Hos. iv. 8; Amos ii. 8). The greater priestly offices were therefore in every respect very important places, and the priests of the royal sanctuaries were among the grandees of the realm (2 Sam. viii. 18; 2 Kings x. 11, xii. 2); minor offices in the sanctuaries were in the patronage of the great priests and were often miserable enough,³ the petty priest depending largely on what "customers" he could find (2 Kings xii. 7 [8]; Deut. xviii. 8). That at least the greater offices were hereditary—as in the case of the sons of Zadok, who succeeded to the royal priesthood in Jerusalem after the fall of Abiathar—was almost a matter of course as society was then constituted, but there is not the slightest trace of an hereditary hierarchy officiating by divine right, such as existed after the exile. The sons of Zadok, the priests of the royal chapel, were the king's servants as absolutely as any other great officers of state; they owed their place to the fiat of King Solomon, and the royal will was supreme in all matters of cultus (2 Kings xii., xvi. 10 seq.); indeed the monarchs of Judah, like those of other nations, did sacrifice in person when they chose down to the time of the captivity (1 Kings ix. 25; 2 Kings xvi. 12 seq.; Jer. xxx. 21). And as the sons of Zadok had no divine right as against the kings, so too they had no claim to be more legitimate than the priests of the local sanctuaries, who also were reckoned to the tribe which in the 7th century B.C. was recognized as having been divinely set apart as Jehovah's ministers in the days of Moses (Deut. x. 8, xviii. 1 seq.).

The steps which prepared the way for the post-exile hierarchy, the destruction of the northern sanctuaries and priesthoods by the Assyrians, the polemic of the spiritual prophets against the corruptions of popular worship, which issued in the reformation of Josiah, the suppression of the provincial shrines of Judah and the transference of their ministers to Jerusalem, the successful resistance of the sons

¹ This appears even in the words used as synonyms for "priest" שֹׁרֵף הַמִּזְבֵּחַ, which exactly corresponds to *sādin* and *hājib*. That the name of כֹּהֵן was borrowed from the Canaanites appears certain, for that out of the multiplicity of words for soothsayers and the like common to Hebrew and Arabic (either formed from a common root or expressing exactly the same idea—'arrāf; ḥabīr, ḥabīr; זִקְנָה, רִאָה, תְּנֵה, cf. istiḳṣām) the two nations should have chosen the same one independently to mean a priest is, in view of the great difference in character between old Hebrew and Canaanite priesthoods, inconceivable. Besides כֹּהֵן Hebrew has the word כַּהֵן (pl. כַּהֲנִים), which, however, is not applied to priests of the national religion. This, in fact, is the old Aramaic word for a priest (with suffixed article, *kumrā*). Its origin is obscure. In the Aramaic papyri discovered near Assouan (Syene) כַּהֵן is priest of the gods (Cowley and Sayce, Pap. E. line 15), presumably Khnum and Set; and in Sachau's Pap. I. line 5, כַּהֵן definitely mean the priests of the god Hnūb. This coincides with the Hebrew use of the term as *idolatrous* priests, Hos. x. 5; Zeph. i. 4; 2 Kings xxxiii. 5.

² It is not clear from 1 Sam. ii. 15 whether even at Shiloh the priest had anything to do with sacrifice, whether those who burned the fat were the worshippers themselves or some subordinate ministers of the Temple. Certainly it was not the "priest" who did so, for he in this narrative is always in the singular. Hophni and Phinehas are not called priests, though they bore the ark and so were priests in the sense of Josh. iii.

³ See 1 Sam. ii. 36, a passage written after the hereditary dignity of the sons of Zadok at Jerusalem was well established.

of Zadok to the proposal to share the sanctuary on equal terms with these new-comers, and the theoretical justification of the degradation of the latter to the position of mere servants in the Temple supplied by Ezekiel soon after the captivity, need not here be dealt with. Further details respecting priestly offices and hereditary priesthoods and the relation of Aaronids to Zadokids will be found briefly discussed in *Ency. Bib.* vol. iii. cols. 3843-3845. Cf. Hastings's *Dict. Bible*, iv. 72-75; *Camb. Bib. Essays* (1909), pp. 100 seq., 112 seq.

It is instructive to observe how differently the prophets of the 8th century speak of the judicial or "teaching" functions of the priests and of the ritual of the great sanctuaries. For the latter they have nothing but condemnation, but the former they acknowledge as part of the divine order of the state, while they complain that the priests have prostituted their office for lucre. In point of fact the one rested on old Hebrew tradition, the other had taken shape mainly under Canaanite influence, and in most of its features was little more than the crassest nature-worship. In this respect there was no distinction between the Temple of Zion and other shrines, or rather it was just in the greatest sanctuary with the most stately ritual that foreign influences had most play, as we see alike in the original institutions of Solomon and in the innovations of Ahaz (2 Kings xvi. 10 seq., xxiii. 11 seq.). The Canaanite influence on the later organization of the Temple is clearly seen in the association of Temple prophets with the Temple priests under the control of the chief priest, which is often referred to by Jeremiah; even the viler ministers of sensual worship, the male and female prostitutes of the Phoenician temples, had found a place on Mt Zion and were only removed by Josiah's reformation.¹ All this necessarily tended to make the ritual ministry of the priests more important than it had been in old times; but it was in the reign of Manasseh, when the sense of divine wrath lay heavy on the people, when the old ways of seeking Jehovah's favour had failed and new and more powerful means of atonement were eagerly sought for (Micah vi. 6 seq.; 2 Kings xxi.; and cf. MOLOCII), that sacrificial functions reached their full importance. In the time of Josiah altar service and not the function of "teaching" has become the essential thing in priesthood (Deut. x. 8, xviii. 7); the latter, indeed, is not forgotten (Jer. ii. 8, xviii. 18), but by the time of Ezekiel it also has mainly to do with ritual, with the distinction between holy and profane, clean and unclean, with the statutory observances at festivals and the like (Ezek. xlv. 23 seq.). What the priestly Torah was at the time of the exile can be seen from the collection of laws in Lev. xvii.-xxvi., which includes many moral precepts, but regards them equally with ritual precepts from the point of view of the maintenance of national holiness. The holiness of Israel centres in the sanctuary, and round the sanctuary stand the priests, who alone can approach the most holy things without profanation, and who are the guardians of Israel's sanctity, partly by protecting the one meeting-place of God and man from profane contact, and partly as the mediators of the continual atoning rites by which breaches of holiness are expiated.

The bases of priestly power under this system are the unity of the altar, its inaccessibility to laymen and to the inferior ministers of the sanctuary, and the specific atoning functions of the blood of priestly sacrifices. All these things were unknown in old Israel. So fundamental a change as lies between Hosea and the Priestly Code was only possible in the general dissolution of the old life of Israel produced by the Assyrians and by the prophets; and indeed the new order did not take shape as a system till the exile had made a great change in old institutions. It was meant also to give expression to the demands of the prophets for spiritual service and national holiness, but this it did not accomplish so successfully; the ideas of the prophets could not be realized under any ritual system, but only in a new dispensation (Jer. xxxi. 31 seq.), when priestly Torah and priestly atonement should be no longer required. Nevertheless, the concentration of all ritual at a single point, and the practical exclusion of laymen from active participation in it—for the old sacrificial feast had now shrunk into entire insignificance in comparison with the stated priestly holocausts and atoning rites²—lent powerful assistance to the growth of a new and higher type of personal religion, the religion which found its social expression not in material acts of oblation, but in the language of the Psalms. In the best times of the old kingdom the priests had shared the place of the prophets as the religious leaders of the nation; under the second Temple they represented the unprogressive traditional side of religion, and the leaders of thought were the psalmists and the scribes, who spoke much more directly to the piety of the nation.

But, on the other hand, the material influence of the priests was greater than it had ever been before; the Temple was the only visible centre of national life in the ages of servitude to foreign power, and the priests were the only great national functionaries, who drew to themselves all the sacred dues as a matter of right and even appropriated the tithes paid of old to the king. When the High Priest stood at the altar in all his princely state, when he poured

out the libation amidst the blare of trumpets, and the singers lifted up their voice and all the people fell prostrate in prayer till he descended and raised his hands in blessing, the slaves of the Greek or the Persian forgot for a moment their bondage and knew that the day of their redemption was near (Ecclus. i.). The High Priest at such a moment seemed to embody all the glory of the nation, as the kings had done of old, and when the time came to strike a successful blow for freedom it was a priestly house that led the nation to the victory which united in one person the functions of High Priest and prince. From the foundation of the Hasmonean state to the time of Herod the history of the high-priesthood merges in the political history of the nation; from Herod onward the priestly aristocracy of the Sadducees lost its chief hold over the nation and expired in vain controversy with the Pharisees.

The influence of the Hebrew priesthood on the thought and organization of Christendom was the influence not of a living institution, for it hardly began till after the fall of the Temple, but of the theory embodied in the later parts of the Pentateuch. Two points in this theory were laid hold of—the doctrine of priestly mediation and the system of priestly hierarchy. The first forms the text of the principal argument in the Epistle to the Hebrews, in which the author easily demonstrates the inadequacy of the mediation and atoning rites of the Old Testament, and builds upon this demonstration the doctrine of the effectual high-priesthood of Christ, who, in his sacrifice of himself, truly "led His people to God," not leaving them outside as He entered the heavenly sanctuary, but taking them with Him into spiritual nearness to the throne of grace. This argument leaves no room for a special priesthood in the Christian Church, and in fact nothing of the kind is found in the oldest organization of the new communities of faith. The idea that presbyters and bishops are priests and the successors of the Old Testament priesthood first appears in full force in the writings of Cyprian, and here it is not the notion of priestly mediation but that of priestly power which is insisted on. Church office is a copy of the old hierarchy. Now among the Jews, as we have seen, the hierarchy proper has for its necessary condition the destruction of the state and the bondage of Israel to a foreign prince, so that spiritual power is the only basis left for a national aristocracy. The same conditions have produced similar spiritual aristocracies again and again in the East in more modern times, and even in antiquity more than one Oriental priesthood took a line of development similar to that which we have traced in Judaea. Thus the hereditary priests of *Ḳozah* (*Κοζέ*) were the chief dignitaries in Idumaea at the time of the Jewish conquest of the country (Jos. *Ant.* xv. 7, 9), and the High Priest of Hierapolis wore the princely purple and crown like the High Priest of the Jews (*De dea syria*, 42). The kingly insignia of the High Priest of the sun at Emesa are described by Herodian (v. 3, 3), in connexion with the history of Elagabalus, whose elevation to the Roman purple was mainly due to the extraordinary local influence of his sacerdotal place. Other examples of priestly princes are given by Strabo in speaking of Pessinus (p. 567) and Olbe (p. 672). As no such hierarchy existed in the West, it is plain that if the idea of Christian priesthood was influenced by living institutions as well as by the Old Testament that influence must be sought in the East (cf. Lightfoot, *Philippians*, p. 261). The further development of the notion of Christian priesthood was connected with the view that the Eucharist (*q.v.*) is a propitiatory sacrifice which only a consecrated priest can perform. It is sufficient to remark here that the presentation of the sacrifice of the mass came to be viewed as the essential priestly office, so that the Christian presbyter really was a *sacerdos* in the antique sense. Protestants, in rejecting the sacrifice of the mass, deny also that there is a Christian priesthood "like the Levitical," and have either dropped the name of "priest" or use it in a quite emasculated sense. For further details as to the history and doctrine of priesthood in Christendom the reader is referred to the article, "Priestertum: Priesterweihe in der Christlichen Kirche," in *P.R.E.*, 3rd ed., Bd. xvi. p. 47 sqq.

There is probably no nature religion among races above mere savagery which has not had a priesthood; but an examination of other examples would scarcely bring out any important

¹ 2 Kings xxiii. 7; cf. Deut. xxiii. 18, where "dogs" = the later Galli; cf. *Corp. insc. sem.* i. 93 seq.

² Cf. the impression which the ritual produced on the Greeks, Bernays's *Theophrastus*, pp. 85, 111 seq.

feature that has not been already illustrated. Among higher religions orthodox Islam has never had real priests, doing religious acts on behalf of others, though it has, like Protestant churches, leaders of public devotion (imāms) and an important class of privileged religious teachers ('ulemā). But a distinction of grades of holiness gained by ascetic life has never been entirely foreign to the Eastern mind, and in the popular faith of Mahomedan peoples something very like priesthood has crept in by this channel. For where holiness is associated with ascetic practices the masses can never attain to a perfect life, and naturally tend to lean on the professors of special sanctity as the mediators of their religious welfare. The best example, however, of a full-blown priestly system with a monastic hierarchy grafted in this way on a religion originally not priestly is found in Tibetan Buddhism (see LAMAISM), and similar causes undoubtedly had their share in the development of sacerdotalism in the Christian Church. The idea of priestly asceticism expressed in the celibacy of the clergy belongs also to certain types of heathen and especially Semitic priesthood, to those above all in which the priestly service is held to have a magical or theurgic quality.

(W. R. S.; O. C. W.)

PRIESTLEY, JOSEPH (1733-1804), English chemist and Nonconformist minister, was born on the 13th of March 1733 at Fieldhead, a hamlet near Birstal in the West Riding of Yorkshire. He was the eldest of a family of six. His father, Jonas Priestley, a woollen-cloth dresser of moderate means, was the son of a member of the Established Church, but both he and his wife, the only daughter of a farmer named Swift, were Nonconformists. Three years after the death of Mrs Priestley in 1739, Joseph's father's sister, Mrs Keighley, took him to live with her, and sent him at the age of twelve to a neighbouring grammar school. In his holidays he learned Hebrew from Mr Kirkby, a dissenting minister at Heckmondwike, who subsequently took entire charge of his education. From the age of sixteen to nearly twenty his health was so unsatisfactory that he attended neither school nor college, but worked at Chaldee and Syriac, began to read Arabic, and mastered 'S Gravesande's *Natural Philosophy*, together with various textbooks of logic and metaphysics. An uncle having promised him a place in a counting-house at Lisbon, he also learned French, German and Italian to fit himself for the post. But his aunt was anxious for him to be a minister, as he himself desired, and therefore in 1752, when his health had improved, he went to Daventry to attend the Nonconformist academy formerly carried on by Dr P. Doddridge at Northampton. There he stayed three years, exchanging his early Calvinism for a system of "necessarianism" under the influence of D. Hartley's *Observations on Man* and A. Collins's *Philosophical Enquiry concerning Human Liberty*. In 1755 he was appointed to a small congregation at Needham Market, in Suffolk, where he was not very successful. In 1758 he obtained a more congenial congregation at Nantwich, where he opened a school at which the elementary lessons were varied with experiments in natural philosophy. Three years later he removed to Warrington as classical tutor in a new academy, and there he attended lectures on chemistry by Dr Matthew Turner of Liverpool and pursued those studies in electricity which gained him the fellowship of the Royal Society in 1766 and supplied him with material for his *History of Electricity*. In 1762 he had married the daughter of Isaac Wilkinson, a Wrexham ironmaster. In 1767 he was appointed to the charge of Mill Hill Chapel at Leeds, where he again changed his religious opinions from a loose Arianism to definite Socinianism and wrote many political tracts hostile to the attitude of the government towards the American colonies. He also began his researches into "different kinds of airs," getting a plentiful supply of "fixed air" from a brewery next door to his house. By the end of 1771 his scientific reputation was such that he was suggested for the post of "astronomer" to Captain Cook's second expedition to the South Seas, but his unorthodox opinions were objectionable to certain members of the board of longitude and the appointment was not ratified. In 1772, the year in which he was chosen a foreign associate of the French Academy of

Sciences, he accepted the position of librarian and literary companion to Lord Shelburne (afterwards 1st Marquess of Lansdowne) at Calne, with a salary of £250 a year and a house. With that nobleman he travelled on the Continent; the month of October 1774 he spent in Paris, and meeting Lavoisier and his friends, gave them an account of the experiment by which on the previous 1st of August he had prepared "dephlogisticated air" (oxygen). In 1780 he parted company with his patron, who allowed him an annuity of £150 for life, and settling at Birmingham was appointed junior minister of the New Meeting Society. There he continued his literary and scientific labours, enjoying congenial intercourse with such men as Matthew Boulton, James Keir, James Watt and Erasmus Darwin at the periodical dinners of the Lunar Society. On the 14th of July 1791 the Constitutional Society of Birmingham arranged a dinner to celebrate the anniversary of the fall of the Bastille. Priestley, according to his own account, "had little to do with it." But his predilections in favour of the revolutionists were notorious, and the mob seized the occasion to burn his chapel and sack his house at Fairhill. He and his family escaped, but his material possessions were destroyed and the labour of years annihilated. He retreated to London, where he felt safe, though he continued to be an object of "troublesome attention," and even the fellows of the Royal Society shunned him. But he received an invitation to become morning preacher at Gravel Pit Chapel, Hackney. This he accepted, and performed the duties of the charge till 1794, when he determined to follow his three sons, who had emigrated to America in the previous year. On the 7th of April he embarked with his wife at Gravesend and reached New York on the 4th of June. Finally settling at Northumberland, Pennsylvania, he lived there for nearly ten years, until on the 6th of February 1804, after clearly and audibly dictating a few changes he wished made in some of his writings, he quietly expired.

Priestley was a most voluminous writer, and his works (excluding his scientific writings) as collected and edited by his friend J. T. Rutt in 1817-1832 fill 25 octavo volumes. (The first volume, containing his life and correspondence, was issued separately in two parts, 1831-1832.) His first appearance as an author was in 1761, when he published the *Scripture Doctrine of Remission* and the *Rudiments of English Grammar*. His chief theological and philosophical works were *Institutes of Natural and Revealed Religion* (3 vols., 1772-1774); *History of the Corruption of Christianity* (2 vols., 1782); *General History of the Christian Church to the Fall of the Western Empire*, vols. i. and ii. (1790), vols. iii. and iv. (1802-1803); *Disquisitions relating to Matter and Spirit* (1777), and various essays and letters on necessarianism. But his theological writings are forgotten, and he is chiefly remembered as a scientific investigator who contributed especially to the chemistry of gases. Yet judged by modern standards he had an inadequate conception of the meaning of ordered research. In reference to his preparation of oxygen he says, "It provides a striking illustration of a remark I have more than once made in my philosophical writings and which can hardly be too often repeated, viz. that more is owing to what we call chance—that is, philosophically speaking, to the observation of events arising from unknown causes—than to any proper design or preconceived theory in this business." If in this sentence he scarcely does justice to the powers of logical inference and inductive reasoning displayed in much of his work, it remains true that blind experiment—heating a substance, or treating it with some reagent, to see what would happen—was his characteristic method of inquiry. Thus by heating spirits of salt he obtained "marine acid air" (hydrochloric acid gas), and he was able to collect it because he happened to use mercury, instead of water, in his pneumatic trough. Then he treated oil of vitriol in the same way, but got nothing until by accident he dropped some mercury into the liquid, when "vitriolic acid air" (sulphur dioxide) was evolved. Again he heated fluorspar with oil of vitriol, as K. W. Scheele had done, and because he was employing a glass vessel he got "fluor acid air" (silicon fluoride). Heating spirits of hartshorn, he was able to collect "alkaline air" (gaseous ammonia), again because he was using mercury in his pneumatic trough; then, trying what would happen if he passed electric sparks through the gas, he decomposed it into nitrogen and hydrogen, and "having a notion" that mixed with hydrochloric acid gas it would produce a "neutral air," perhaps much the same as common air, he synthesized sal ammoniac. Dephlogisticated air (oxygen) he prepared in August 1774 by heating red oxide of mercury with a burning-glass, and he found that in it a candle burnt with a remarkably vigorous flame and mice lived well. He concluded that it was not common air, but the substance, "in much greater perfection," that rendered common air respirable

and a supporter of combustion. Of the analogy between combustion and respiration—both true phlogistic processes in his view—he had convinced himself three years before, and his paper, "On Different Kinds of Air" (*Phil. Trans.*, 1772) described experiments which showed that growing plants are able to "restore" air which has been vitiated, whether by being breathed or by having candles burnt in it. Priestley displayed much ingenuity in devising apparatus suited to his requirements and in carrying out and varying his experiments; it was in the interpretation of results that he was deficient. Had this not been the case he could scarcely have remained a firm believer in the phlogistic doctrine. At one time, indeed, he found Lavoisier's views so specious that he was much inclined to accept them, but he overcame this wavering, and so late as 1800 he wrote to the Rev. Theophilus Lindsey (1723-1808), "I have well considered all that my opponents have advanced and feel perfectly confident of the ground I stand upon. . . . Though nearly alone I am under no apprehension of defeat."

His chief books on chemistry were six volumes of *Experiments and Observations on different Kinds of Air*, published between 1774 and 1786; *Experiments on the Generation of Air from Water* (1793); *Experiments and Observations relating to the Analysis of Atmospheric Air*, and *Considerations on the Doctrine of Phlogiston established and that of the Composition of Water refuted* (1800). He also published (1767) a treatise on the *History and Present State of Electricity*, which embodies some original work, and (1772) a *History of Discoveries relating to Vision, Light and Colours*, which is a mere compilation.

PRIEUR, PIERRE (c. 1626-c. 1676), French enamel painter. He married Marie (1610-1677), sister of Jean Petitot, as her second husband. In 1669 he was in England, painting a miniature of Charles II. and another of Lady Castlemaine, both after Cooper, for the king of Denmark. In 1670 he was in Poland, painting for the Danish monarch a portrait of King Michael, and in the following year was in Denmark executing a remarkable series of portraits of the children of Frederick III. All these, with some beautiful enamel badges for the Order of the Elephant, are in the Danish royal collection. By Christian V. he is said to have been sent to Spain and Russia, where several examples of his work, dated 1676, are to be seen in the Hermitage. In the following year he died in Denmark. He was a Huguenot, and was said to possess secret colours in enamel, especially a blue, which were not known to his Petitot relations. His work in England is of great rarity, Lord Dartrey possessing the finest example, and there are two remarkable works in the Pierpont Morgan collection and one at Windsor Castle. Two in the Propert collection have been lost sight of. (G. C. W.)

PRIEUR DE LA MARNE [PIERRE LOUIS PRIEUR] (1756-1827), French politician, was born at Sommesous (Marne) on the 1st of August 1756. He practised as a lawyer at Châlons-sur-Marne until 1789, when he was elected to the states-general. He became secretary to the Assembly, and the violence of his attacks on the *ancien régime* won him the nickname of "Crieur de la Marne." In 1791 he became vice-president of the criminal tribunal of Paris. Re-elected to the Convention, he was sent to Normandy, where he directed bitter reprisals against the Federalists. He voted for the death of Louis XVI., and as a member of the committees of national defence and of public safety he was despatched in October 1793 to Brittany, where he established the Terror. In May 1794 he became president of the Convention. The counter-revolutionaries drove him into hiding from May 1795 until the amnesty proclaimed in the autumn of that year. He took no part in public affairs under the directory, the consulate or the empire, and in 1816 was banished as a regicide. He died in Brussels on the 31st of May 1827.

See Pierre Bliard, *Le Conventionnel Prieur de la Marne en mission dans l'ouest 1793-1794 d'après des documents inédits* (1906).

PRIEUR-DUVERNOIS, CLAUDE ANTOINE, COMTE (1763-1832), French politician, was born at Auxonne on the 2nd of December 1763, and was commonly known as Prieur de la Côte d'Or, after his native department. As an officer of engineers he presented to the National Assembly in 1790 a *Mémoire* on the standardization of weights and measures. In 1791 he was returned by the Côte d'Or to the Legislative Assembly, and in 1792 to the Convention. After the revolution of the 10th of August 1792 he was sent on a mission to the army of the Rhine

to announce the deposition of Louis XVI., for whose death he voted in the Convention. In 1793 he was employed in breaking up the Federalist movement in Normandy, but he was arrested by the Federalist authorities of Caen, and only released in July 1793 after the defeat of their forces at Vernon. On the 14th of August 1793 he became a member of the committee of public safety, where he allied himself closely with Lazare Carnot in the organization of national defence, being especially charged with the provision of the munitions of war. Under the Directory he sat in the Council of the Five Hundred, retiring after the *coup d'état* of 18 Brumaire (November 9, 1799). In 1808 he was created a count of the empire, and in 1811 he retired from the army with the grade of *chef de brigade*. He was one of the founders of the *École Polytechnique*, and shared in the establishment of the Institute of France; the adoption of the metric system and the foundation of the bureau of longitude were also due to his efforts. Prieur died at Dijon on the 11th of August 1832.

See J. Gros, *Le Comité de salut public* (1893); and E. Charavay, *Correspondance de Carnot*, vol. i., which includes some documents drawn up by Prieur.

PRIM, JUAN, MARQUIS DE LOS CASTILLEJOS, COUNT DE REUS (1814-1870), Spanish soldier and statesman, was the son of Lieut.-Colonel Pablo Prim, and was born at Reus in Catalonia on the 12th of December 1814. He entered the free corps known as the volunteers of Isabella II. in 1834, and in the course of the Carlist War he rose to the rank of lieutenant-colonel and had two orders of knighthood conferred upon him. After the pacification of 1839, as a progressist opposed to the dictatorship of Espartero, he was sent into exile. However, in 1843 he was elected deputy for Tarragona, and after defeating Espartero at Bruch he entered Madrid in triumph with Serrano. The regent Maria Christina promoted him major-general, and made him count of Reus. Narvaez, the prime minister, failed to understand what constitutional freedom meant, and Prim, on showing signs of opposition, was sentenced to six years' imprisonment in the Philippine Islands. The sentence was not carried out, and Prim remained an exile in England and France until the amnesty of 1847. He then returned to Spain, and was first employed as captain-general of Porto Rico and afterwards as military representative with the sultan during the Crimean War. In 1854 he was elected to the cortes, and gave his support to O'Donnell, who promoted him lieutenant-general in 1856. In the war with Morocco he did such good service at Los Castillejos or Marabout, Cabo Negro, Guad al Gelu and Campamento in 1860 that he was made marquis de los Castillejos and a grande of Spain. He commanded the Spanish army in Mexico when he refused to consent to the ambitious schemes of Napoleon III. On his return to Spain he joined the opposition, heading pronunciamentos in Catalonia against Narvaez and O'Donnell. All his attempts failed until the death of Narvaez in April 1868, after which Queen Isabella fell more and more under the influence of the Jesuits, and became increasingly tyrannical, until at last even Serrano was exiled. In September 1868 Serrano and Prim returned, and Admiral Topete, commanding the fleet, raised the standard of revolt at Cadiz (see SPAIN). In July 1869 Serrano was elected regent, and Prim became president of the council and was made a marshal. On the 16th of November 1870 Amadeo, duke of Aosta, was elected king of Spain, but Prim, on leaving the chamber of the cortes on the 28th of December, was shot by unknown assassins and died two days later. The cortes took his children as wards of the country; three days afterwards King Amadeo I. swore in the presence of the cortes to observe the new Spanish constitution.

Two biographies of Prim down to 1860 were published in that year by Gimenez y Guitied and Gonzalez Llanos. See also L. Blairet, *Le Général Prim et la situation actuelle de l'Espagne* (Paris, 1867); Guillaumot, *Juan Prim et l'Espagne* (Paris, 1870); and *Prim*, by H. Leonardon (in French, 1901), which contains a useful bibliography.

PRIMAGE (adopted from the Fr. *primage*, from *prime*, recompense, Lat. *praemium*, reward), a commercial term

signifying originally a small customary payment over and above the freight made to the master of the ship for his care and trouble. It is now generally included in the freight, as an additional percentage. It varies according to the usages of different ports and particular trades.

PRIMATE (from Low Lat. *primas*=one who held the first place, *primas partes*). During the 4th and 5th centuries A.D. the title was applied to both secular and ecclesiastical officials. The Theodosian Code mentions primates of towns, districts and fortified places (*Primates urbium, vicorum, castellarum*). The Pragmatic Sanction of Justinian also mentions primates governing a district, *primates regionis*; and in this sense the title survived, under Turkish rule, in Greece until the 19th century. An official called "primate of the palace" is mentioned in the laws of the Visigoths. *Primas* also seems to have been used loosely during the middle ages for "head" or "chief." Du Cange cites *primas castris*. The title, however, has been more generally used to denote a bishop with special privileges and powers. It was first employed almost synonymously with *metropolitan* to denote the chief bishop of a province having his see in the capital and certain rights of superintendence over the whole province. At the Council of Nicaea (A.D. 325) the metropolitan constitution was assumed as universal, and after this the terms "metropolitan," and "primate," to denote the chief bishop of a province, came into general use. The title of primate was used more generally in Africa, while elsewhere metropolitan was more generally employed. The primates in Africa differed from those elsewhere in that the title always belonged to the longest ordained bishop in a province, who had not necessarily his see in the capital, except in the case of the bishop of Carthage, who was head also of the other five African provinces. There were also three sorts of honorary primates: (1) *primates aevae*, the oldest bishop in a province next to the primate, on whom power devolved when the primate was disabled or disqualified; (2) titular metropolitans, the bishops of certain cities which had the name and title of civil metropolises bestowed on them by some emperor; (3) the bishops of some mother-churches which were honoured by ancient custom but were subject to the ordinary metropolitan, e.g. the bishop of Jerusalem, who was subject to his metropolitan at Caesarea.

At a later date "primate" became the official title of certain metropolitans who obtained from the pope a position of episcopal authority over several other metropolitans and who were, at the same time, appointed vicars of the Holy See. This was done in the case of the bishops of Arles and Thessalonica as early as the 5th century. Such primates were sometimes also called patriarchs, *primates diocesarum* (political, not episcopal dioceses), *primates provinciae, summi primates, praesules omnium sacerdotum in partibus suis*. In this sense the Western primate was considered the equivalent of the Eastern patriarch. The archbishop of Reims received the title of *primas inter primates*. By the False Decretals an attempt was made to establish such a primacy as a permanent institution, but the attempt was not successful and the dignity of primate became more or less honorary. The overlapping of the title is illustrated by the case of England, where the archbishop of York still bears the title of primate of England and the archbishop of Canterbury that of primate of all England. A less general use of the title is its application in medieval usage to the head of a cathedral school or college (*primas scholarum*) and to the dignitaries of a cathedral church. The abbot of Fulda received from the pope the title of *primas inter abbates*. In the Episcopal Church of Scotland the senior bishop is styled the *primas*.

Du Cange, *Glossarium*; Hinschius, *Kirchenrecht* (Berlin, 1869); Moeller, *History of the Christian Church*, translated from the German by Andrew Rutherford, B.D. (London, 1902); Bingham, *Origines ecclesiasticae* (1840).

PRIMATES (Lat. *primus*, first), the name given by Linnaeus to the highest order of mammals (see MAMMALIA), which was taken by him to include not only man, apes, monkeys and lemurs, but likewise bats. The latter group is now separated as a distinct order (see CHIROPTERA). It has also been proposed

to remove from the Primates the lemurs, constituting the group *Prosimiae*, or *Lemuroidea*, to form an order by themselves; but general opinion is now against this view, and they are accordingly here regarded as representing a sub-order of Primates, all the other members of which are included in a second sub-ordinal group—the *Anthropoidea*, or *Simiae*. Support to the view that lemurs should be included in the order is afforded by the discovery in Madagascar of an extinct species (*Nesopithecus*) presenting certain characters connecting it with monkeys on the one hand and with lemurs on the other.

In this broader sense the Primates may briefly be defined as follows. All the members of the order are plantigrade mammals, normally with five fingers and five toes, which are generally armed with broad flattened nails, although these are rarely replaced on single digits, or on all the digits, by claws or elaw-like nails. The dental formula is $i. \frac{2}{1}, c. \frac{1}{1}, d. \frac{2}{2}, m. \frac{3}{3}$; all the teeth in advance of the molars being normally preceded by milk-teeth. The molars are three-, four- or five-cusped, but the cusps may in some cases coalesce into transverse ridges. The thumb and great toe are, as a rule, opposable to the other digits. The clavicles (collar-bones) are complete; there is nearly always a free centrale bone in the wrist, or carpus, in which the scaphoid and lunar are likewise generally separate. The orbits (and the eyes) are directed more or less forwards, and generally surrounded by bone (fig. 1), while the lower jaw has a vertical movement on the upper. With a few exceptions the stomach is simple; and a duodeno-jejunal flexure of the intestine and a caecum are present. The diet is generally simple; and a duodeno-jejunal flexure of the intestine and a caecum are present. The diet is generally vegetable, but may be mixed, or, rarely, consisting of insects. The uterus may be either bicornuate or simple; and the placenta either discoidal and deciduate, or diffuse and non-deciduate, with a great development of the allantois. The clitoris may or may not be perforate; the penis is pendent; and the testes are extra-abdominal, situate either in a scrotum behind the penis or in a similarly situated fold of the integument. At most the teats are four in number, but generally only two situated on the breast, although occasionally abdominal or even inguinal. As a rule only a single offspring is produced at a birth, such offspring being always born in a completely helpless condition.

With the exception of man, who has adapted himself to exist in all climates, the Primates are essentially a tropical and sub-tropical group, although some of the monkeys inhabit districts where the winter climate is severe. The great majority—in fact nearly all—of the members of the order are arboreal in their habits. In size there is great variation, the extremes in this respect being represented by man and the gorilla on the one side, and the marmosets and tarsiers, which are no larger than squirrels, on the other.

As regards the proper meaning of the popular names "monkey," "baboon" and "ape," it appears that these are in the main general terms which, with the exception of the second,



FIG. 1.—Lateral and lower views of the Skull of a Langur Monkey (*Semnopithecus*), to show the forward direction and complete closure of the orbits, and the characters of the dentition of the Old World Catarrhini.

may be applied indifferently to all the members of the first sub-order. "Baboon" appears to be properly applicable to the dog-faced African species, and may therefore be conveniently restricted to the members of the genus *Papio* and their immediate relatives. "Ape," on the other hand, may be specially used for the tailless man-like representatives of the order; while the term "monkey" may be employed for all the rest, other than lemurs; monkeys being, however, divisible into sub-groups, such as macaques, langurs, guerezas, mangabeys, &c. This usage cannot, however, be universally employed, and the term "monkeys" may be employed for the entire group.

Anthropoidea.—The Primates, as already mentioned, are divisible into two main groups, or sub-orders, of which the first includes man, apes, baboons and monkeys. For this group Professor Max Weber employs the name Simiæ (in contradistinction to Prosimiæ for the lemurs). Since, however, to take as the title for a group which includes man himself the designation of creatures so much lower in the scale is likely to be repugnant, it seems preferable to employ the designation Anthropoidea for the higher division of the order.

As the essential features distinguishing the Anthropoidea from the second sub-order may best be indicated under the heading of the latter, reference may at once be made to some of the more striking characters of the members of the former group. The proportions of the body as regards the relative lengths of the two pairs of limbs to one another and to that of the trunk vary considerably. Both pairs may be much elongated, as in *Ateles* and *Hylobates*, and either sub-equally, as in the first of these, or with the arms greatly in excess, as in the second. The legs may be excessively short, and the arms, at the same time, excessively long, as in the orang-utan. Both pairs may be short and sub-equal, as in many of the baboons (*Papio*). Only in *Nyctipithecus* and the *Hapalidae* does the excess in length of the lower limbs over the upper exceed or equal that which is found in man. The length of the tail presents some noteworthy points. It is found at its greatest absolute length, and also greatly developed relatively, being about twice the length of the trunk, in such monkeys as the Indian langurs; but its greatest relative length is attained in the spider-monkeys (*Ateles*), where it reaches three times the length of the trunk. The constancy of the degree of its development varies much in different groups. In the greater number of genera it is long in all the species, and in some (*Simia*, *Anthropopithecus* and *Hylobates*) it is absent in all. In others it may be long or short, or completely absent, as in macaques (*Macacus*).

The form of the head presents great differences—it may be rounded, as in *Ateles*; produced vertically, as in *Simia*; drawn out posteriorly to an extreme degree, as in *Chrysothrix*; or anteriorly, as in the baboons. A production of the muzzle, necessitated by the presence of large teeth, exists in the chimpanzee (*Anthropopithecus*), but in the baboons, not only is this prolongation carried farther, but the terminal position of the nostrils gives a dog-like aspect to the face.

The eyes may be small compared with the size of the head, as in the baboons; but they may, on the contrary, attain a relatively enormous size, as in *Nyctipithecus*. They are always forwardly directed, and never much more separated one from another than in man; they may, however, be more closely approximated, as in the squirrel-monkeys (*Chrysothrix*) of South America.

The ears are always well developed, and very generally have their postero-superior angle pointed. They may be large and small in the same genus, as in *Anthropopithecus* (chimpanzee and gorilla); but only in the gorilla do we find, even in a rudimentary condition, that soft depending portion of the human ear termed the "lobule." The nose has scarcely ever more than a slight prominence, and yet an enormous development is to be met with in the proboscis-monkey (*Nasalis*); while in the snub-nosed monkeys (*Rhinopithecus*) we find a sharply prominent, though smaller and extremely upturned nose. The hooleck gibbon also possesses a prominent but slightly aquiline nose. The terminal position of the nostrils in the baboons has already been mentioned. These apertures may be closely approximated, as in all the man-like apes (*Simiidae* and *Hylobatidae*), or they may be separated one from the other by a broad septum, as in the *Cebidae*, its breadth, however, varying somewhat in different genera, as in *Ateles* and *Eriodes*, and *Callithrix* and *Nyctipithecus*. The lips are generally thin, but may be very extensible, as in the orang-utan.

The hands are generally provided with thumbs, though these organs (as in the African guerezas, *Colobus*, and the American spider-monkeys, *Ateles*) may be represented only by small nailless tubercles. The thumb is more human in its proportions in the chimpanzee than in any other of the higher apes. As compared with the length of the hand, it is most man-like in the lowest American monkeys, such as *Chrysothrix* and *Hapale*. In spite of greater relative length it may, however, little merit the name of thumb, as it is but slightly opposable to the other digits in any of the American monkeys, and is not at all so in the *Hapalidae*. The "great toe" is never rudimentary and, except in man, in place of being the

longest digit of the foot, is constantly the shortest. As compared with the entire length of the foot, it is most man-like in the chimpanzee and some gibbons, and smallest of all in the orang-utan, and next smallest in *Hapale*. Every digit is provided with a nail, except the great toe of the orang-utan and the rudimentary tubercle representing the thumb in *Ateles* and *Colobus*. The nail of the great toe is flat in every species, but the other nails are never so flat as are the nails of man. The lateral compression of the nails becomes more strongly marked in some *Cebidae*, e.g. *Eriodes*, but attains its extreme in the *Hapalidae*, where every nail, except that of the great toe, assumes the form of a long, curved and sharply pointed claw.

With the single exception of man, the body is almost entirely clothed with copious hair, and never has the back naked. In the gibbons, the langurs, the macaques and the baboons, naked spaces (*ischiatric callosities*) are present on that part of the body which is the main support in the sitting posture. These naked spaces are subject to swelling at the season of sexual excitement. Such naked spaces are never found in any of the American monkeys. No ape or monkey has so exclusive and preponderating a development of hair on the head and face as exists in man. As to the head, long hair is found thereon in *Hapale oedipus* and in some of the langurs and guerezas, whilst certain macaques, like the Chinese bonnet-monkey (*Macacus sinicus*), have the hair of the head long and radiating in all directions from a central point on the crown. A beard is developed in the male orang-utan; and the Diana monkey (*Cercopithecus diana*) has long hair on the cheeks and chin. The wanderer (*Macacus silenus*) has the face encircled by a kind of mane of long hairs; and many of the marmosets have a long tuft of hairs on each side of the head. American monkeys exhibit some extremes respecting hair-development. Thus in some of the howlers (as in some of the guerezas of the Old World) the hair of the flanks is greatly elongated. Some also have an elongated beard, but the latter structure attains its maximum of development in the coucio (*Pithecia satanas*). Some of the species of the American genus *Pithecia* have the hair of the body and tail very long, others have the head of the female furnished with elongated hair; while the allied *Uacaria calva* has the head bald. Long hair may be developed from the shoulders as in *Papio hamadryas* and *Theropithecus gelada*. Very long hair is also developed on the back of the snub-nosed monkeys (*Rhinopithecus*) in winter. The direction of the hair may sometimes vary in nearly allied forms, the hairs on the arm and fore-arm respectively being often so directed that the tips converge towards the elbow. Such is the case in most of the higher apes, yet in *Hylobates agilis* all the hair of both these segments is directed towards the wrist. The hair presents generally no remarkable character as to its structure. It may, however, be silky, as in *Hapale rosalia*, or assume the character of wool, as in the woolly spider-monkeys (*Eriodes*) and *Macacus tibetanus*, which inhabits Tibet.

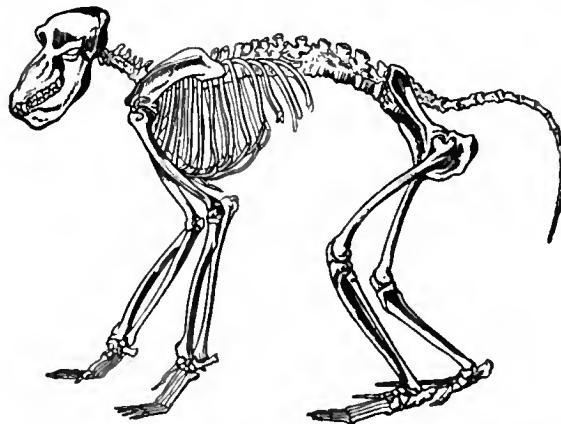

FIG. 2.—Skeleton of Chacma Baboon (*Papio porcarius*), showing the great relative length of the facial part of the Skull.

Great brilliance of colour is sometimes found in the naked parts of the body, particularly in the baboons and some of the other *Cercopithecidae*, and especially in the regions of the face and sexual organs. Among these latter rose, turquoise-blue, green, golden-yellow and vermilion appear, in various combinations, in one or other or both of these regions, and become especially brilliant at the period of sexual excitement.

The skeleton, more especially in the higher forms, is in the main similar to that of man, so that only a brief notice is necessary. In the skull considerable variation in regard to the proportionate length of the face to that of the brain-case (cranial portion) exists in the two sexes, owing to the general development of large tusks in the males (other than in man, who is not now under consideration). Generally speaking, the elongation of the facial portion, as compared to the cranial, increases as we pass from the higher to the lower forms. The increase does not, however, occur regularly, being

greater in the orang-utan and chimpanzee than in some of the langurs (*Sebnopithecus*, fig. 1); the maximum development of this feature occurs in the dog-faced baboons (*Papio*, fig. 2). In American monkeys, with the exception of the howlers (*Alouata*, fig. 3), the facial part is relatively smaller than in Old World monkeys and



FIG. 3.—Skull and Hyoid-bone of a Howler-Monkey (*Alouata*). In nature the hyoid-bone, which is bladder-like, is placed between the two branches of the lower jaw.

apes; while in the squirrel-monkeys (*Chrysotrrix*) it is even smaller than in man himself. In none of the Old World group does the forehead present that rounded and elevated contour characteristic of man, although the height of this region is great in the orang-utan (fig. 4). Curiously enough, American monkeys, especially those included in *Pithecia*, are the most man-like in this respect. The skull of the male gorilla is characterized by the great development of the crests for muscular attachment, one of these (superciliary) overhanging the orbits, a second (sagittal) traversing the middle line of the upper surface, while a third (lambdoid) forms an inverted V on the occiput, and affords attachment for the muscles of the neck.



FIG. 4.—Skull of adult male Orang-utan (*Simia satyrus*).

In the gorilla the orbits are much as in man, but in the orang-utan they are more rounded. They become very large in *Hylobates*, but attain an enormous size in the American *Nyctipithecus*. The extent to which each orbit opens into the adjacent temporal fossa, i.e. the size and shape of the sphenomaxillary fissure, varies considerably; this is narrow and much elongated in the gorilla and the baboons, but short in the langurs and spider-monkeys. It is most closed in the howlers, where it sometimes all but disappears entirely. The mastoid process never attains the large relative size it has in man; but it is prominent in the baboons and larger macaques, as well as in the chimpanzee and gorilla, its development bearing relation to the size and weight of the head. As the mastoid

diminishes, the under surface of the petrosal assumes a swollen or bladder-like condition.

The plane of the foramen magnum, as compared with the basiscranial axis, varies with the projection of the occiput; it generally forms a less open angle with that axis than in man, but in *Chrysotrrix* the angle is yet more open than in the human skull. The cheek, or zygomatic, arches bend outwards and upwards in the gorilla and some baboons, but decrease in relative as well as absolute size in the smaller forms—notably in *Chrysotrrix*. No long slender styloid process is normally attached to the skull, though such may be the case in the baboons. An external bony auditory meatus (or tube) is present in Old World but absent in New World monkeys. In all apes and monkeys the premaxillae have a distinctness of development and a relative size not found in man; the sutures separating them from the maxillae remaining visible, except in the chimpanzee, after the adult dentition has been attained. The maxillae develop great swollen tuberosities in the baboons and the black ape of Celebes. The nasal bones are small, and generally flatter than in man; being in the orang-utan quite flat. They are convex in some langurs and all baboons; but the proboscis-monkey has its nasals no more developed than those of other species. The nasals seem to attain their maximum of relative size in the howlers. The lower jaw, or mandible, is always in one piece in adults; and is most man-like in the siamang, which alone has a slight chin. On the other hand, in other gibbons the angle is produced downwards and backwards, as also in marmosets. Its



FIG. 5.—Skeleton of South American Spider-Monkey (*Ateles*), to illustrate the length of the limbs and tail, and the slenderness of the former.

maximum of relative size is attained in the howlers (fig. 3), where the broad ascending part serves to protect and shelter the enormously developed body of the hyoid. Air-cells may be developed, as in the gorilla, in the parts adjacent to the mastoid. Frontal sinuses are generally absent in the Old World group, being replaced by coarse cellular bone. In old age the sutures of the skull become obliterated, the one between the two nasals disappearing at an early age in Old World monkeys. In the spider-monkeys and howlers the tentorium, or membrane dividing the hemispheres of the brain from the cerebellum, becomes bony.

The spinal column of apes and monkeys always lacks the S-like curvature of that of man, the nearest approach to this occurring in the baboons (fig. 2). The number of dorsal vertebrae varies from eleven in some species of *Cercopithecus* and *Macacus* to fourteen in certain gibbons or fifteen in the American night-apes (*Nyctipithecus*). In the American *Cebidae* the number seldom falls below thirteen; in the orang-utan it is twelve, as in man, but thirteen in the chimpanzee and gorilla. In most cases the dorsal and lumbar regions are about equal in length, but the lumbar region is the shorter in the man-like group, and less than half the length of the dorsal in the gorilla. The lumbar spinous processes are vertical, or project backwards in the man-like apes, gibbons and spider-monkeys; in the others they project forwards, especially in *Cebidae*. The lumbar transverse processes project outwards, more or less at right angles to the axis of the spine, or else forwards. The sacrum attains its greatest absolute length in the gorilla, but is relatively longer than in man in all the man-like group. *Hylobates* has the relatively longest sacrum. The number of vertebrae included in the sacrum varies more or less with age; with the exception of the *Simiidae* and *Hylobatidae*, there are generally only two or three; but in *Ateles*, *Hylobates*, and *Uacaria* there may be four; while in the *Simiidae* there are always five, and sometimes six. In most apes the sacrum and lumbar vertebrae lie in one slightly curved line, the gorilla and chimpanzee presenting in this respect a great contrast to the human structure. In the orang-utan the sacro-vertebral angle is rather more marked; but in some baboons it is so much so as almost to rival that of man.

With the exception of the man-like apes and gibbons and the Barbary ape (*Macacus inuus*), the caudal vertebrae of monkeys exceed four in number; but the mandril, *Papio (Maimon) maimon*, has sometimes only five. The short-tailed macaques and uakaris have from about fifteen to seventeen, the shortness of the tail being occasioned rather by a diminution in the size of the component vertebrae than by a decrease in number. In the other forms the number varies between twenty and thirty-three, the latter being the number attained in the spider-monkeys (fig. 5). The proportion borne by this region of the spine to the more anterior parts is greatest in the spider-monkeys of the genus *Ateles*, almost three to one; in the other longest-tailed genera it is rarely so large as two to one. The absolute length of the tail is greatest in the langurs and gurezas, where also the individual caudal vertebrae attain their greatest length, namely two inches. The caudal vertebrae generally increase in length from the sacrum till about the seventh, eighth or ninth, which, with the tenth and eleventh, are the longest in most long-tailed forms. In *Ateles* the eleventh, twelfth, thirteenth and fourteenth vertebrae are the longest. In most members of the sub-order the breast-bone, or sternum, is narrow, and consists of a more or less enlarged upper portion, or manubrium, followed by a chain of sub-equal elongated bones from three to six in number. In man, man-like apes and gibbons there is, however, a broad sternum; or one consisting of a manubrium, followed by one bone only, as in *Hyllobates*. In the orang-utan the breast-bone long remains made up of ossifications arranged in pairs, side by side, successively. The true ribs are seven in number on each side in the highest forms, but in *Hyllobates* there are sometimes eight; in *Ateles* there are sometimes nine pairs; in *Hapale* the number varies from six to eight, and from seven to eight in the other genera. The "angles" of the ribs are never so marked as in man; most so in *Hyllobates*. *Pithecia* is distinguished by the greater relative breadth of the ribs. In no ape or monkey is the thorax half as broad again as it is deep from back to breast. Nevertheless, in the *Simiidae* and *Hyllobatidae*, its transverse diameter exceeds its depth by from about one-fourth to a little under one-third of the latter. In *Ateles* (and sometimes also in *Alouata*) the thorax is wider than deep, but in the rest it is deeper than wide.

The greatest absolute length of the fore-limb occurs in the gorilla (fig. 6) and the orang-utan. The humerus never has a perforation

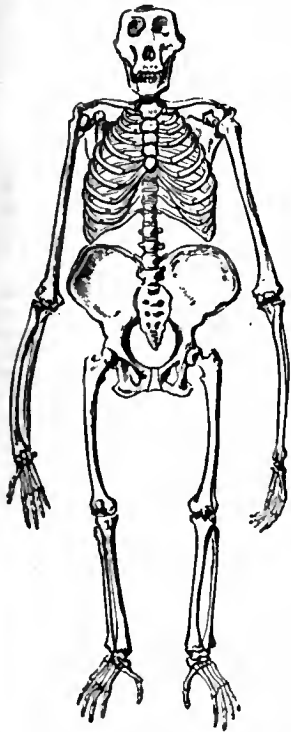

FIG. 6.—Skeleton of the Gorilla (*Anthropopithecus gorilla*), to exhibit the flattened sternum, the broad and shallow thorax, and the great length of the fore-limbs.

do the lower ends of the inner metatarsals form the anterior point of support of the antero-posterior arch, as in man. The calcaneum, except in the gorilla, is shorter compared with the spine than in man. The phalanges of the foot are the same in number as in man, except that the great toe of the orang-utan has often but one. They are very like their representatives in the hand, and are convex above, concave and flattened below. Only

in the *Hapalidae* are the terminal phalanges laterally compressed instead of flattened. The toes are never nearly so short relatively in apes and monkeys as in man; yet the proportion borne by the great toe, with its metatarsal, to the spine closely approximates in the gorilla to the proportion existing in man, and this proportion is exceeded in *Hyllobates* and *Ateles*.

Omitting all reference to the muscles, we find that in apes and monkeys the absolute size of the brain never approaches that of man; the cranial capacity being never less than 55 cub. in. in any normal human subject, while in the orang-utan and chimpanzee it is but 26 and 27½ cub. in. respectively. The relative size of the brain varies inversely with the size of the whole body, as is the case in warm-blooded vertebrates generally. The hemispheres of the brain are almost always so much developed as to cover over the cerebellum, the only exceptions being the howlers and the siamang (*Hyllobates syndactylus*). In the latter the cerebellum is slightly uncovered, but it is considerably so in the former. In *Chrysothrix* the posterior lobes are more largely developed relatively than in man. As in mammals generally, much convoluted hemispheres are correlated with a considerable absolute bulk of body. Thus in *Hapale* (and here only) we find the hemispheres quite smooth, the only groove being that which represents the Sylvian fissure. In *Simia* and *Anthropopithecus*, on the contrary, they are richly convoluted. A *hippocampus minor* is present in all apes and monkeys, and in some *Cebidae* is larger relatively than in man, and absolutely larger than the *hippocampus major*. Of all apes and monkeys the orang-utan has a brain most like that of man; indeed it may be said to be like man's in all respects save that it is much inferior in size and weight, and that the hemispheres are more symmetrically convoluted and less complicated by minor foldings. The human brain, as known by European specimens, has been supposed to differ from that of apes and monkeys by the absence of the so-called simian fold (*Affenplatte*) on the posterior portion of the main hemispheres. On studying a large series of Egyptian and Sudanese brains, Professor G. Elliot Smith finds, however, that this simian fold, or sulcus, can be distinctly recognized. "It is easy," he writes, "to select examples from the series of Egyptian and Sudanese brains in my possession, in which the pattern formed by the occipital sulci on the lateral surface of the hemisphere in individual anthropoid apes is so exactly reproduced that the identity of every sulcus is placed beyond reasonable doubt. . . . And if we take individual examples of gorilla-brains, it becomes still easier to match the occipital pattern of each of them to numerous human brains. . . . It is easy to appreciate the difficulties which have beset investigators of European types of brain, and to understand the reasons for the common belief in the absence of the supposed distinctly simian sulci in the lateral aspect of the occipital region of the human brain."

In no ape or monkey does the series of teeth form so perfect an arch as in man, the opposite series of cheek-teeth tending to become more parallel. None has the teeth placed in one uninterrupted series in each jaw, as is the case in the human species; but there is always a small gap between the upper canine and the adjacent incisor, and between the lower canine and the adjacent premolar. This condition is due to the excessive size of the canines, the interspaces giving passage to the tips of these teeth. This prolongation of the canines into tusk-like weapons of offence and defence (especially developed in the males) makes a great difference between the aspect of the dentition in apes and man. The number of the teeth is the same as in man in all Old World Primates. The New World *Cebidae* have an additional premolar on each side of each jaw, while the *Hapalidae* have a molar the less. The incisors are nearly vertical, save in *Pithecia* and its allies, where their tips project forward. The canines are considerably longer than the incisors, except in *Hapale*, where the lower incisors equal them in length. The premolars differ structurally from the molars much as in man, except that the first lower one may be modified in shape to give passage to the upper canine, as in the baboons. The grinding surface of the molars consists generally of two incomplete transverse ridges, the end of each ridge projecting more than the intermediate part, indicating the position of the four original tubercles. In the man-like apes there is, however, in the upper molars a ridge running obliquely from the front inner tubercle, or cusp, outwards and backwards to the hind outer tubercle. In the *Cercopithecidae* this ridge is wanting, but it reappears in *Ateles* and *Alouata* amongst the *Cebidae*. In the *Hapalidae* the tubercles of the molars are more produced and sharp-pointed, in harmony with the insectivorous habits of the marmosets. The last lower molar may be reduced or much enlarged as compared with the others. Thus in *Cercopithecus talapoin* it has but three tubercles, while in the macaques and baboons it is very large, and has five well-developed cusps. The number of milk-teeth is as in man, except that American monkeys have an additional one. In general the canines are the last teeth to be cut of the permanent dentition, their cutting sometimes causing such constitutional disturbance as to produce convulsions and death. In the gibbons, however, the canines accompany, if they do not precede, the appearance of the hindmost molar, while in the orang-utan they at least sometimes make their appearance before the latter.

The stomach is simple in all apes and monkeys except langurs,

guerezas, and their allies. It is especially human in shape in *Hylobates*, except that the pylorus is somewhat more elongated and distinct. It is of a rounded form in *Pithecia*, and in *Hapale* the cardiac orifice is exceptionally near the pylorus. In the langur group it is sacculated, especially at the cardiac end, being, in fact, very like a colon spirally coiled. The intestine is devoid of *valvulae conniventes*, but provided with a well-developed caecum, which is, however, short and conical in the baboons. Only in the man-like apes is there a vermiform appendix. The colon may be much longer relatively than in man, as in the man-like apes; it may be greatly sacculated, as in *Hylobates*; or devoid of sacculations, as in *Cebus*. The liver may be very like man's, especially in gibbons, the orang-utan, and the chimpanzee; but in the gorilla both the right and left lobes are cleft by a fissure almost as much as in the baboons. In the langur group the liver is much divided, and placed obliquely to accommodate the sacculated stomach. The lateral lobes in *Hapale* are much larger than the central lobe. The caudate lobe is very large in *Cebidae*, especially in *Ateles*, and above all in *Pithecia*. There is always a gall-bladder.

The larynx in many members of the sub-order is furnished with sac-like appendages, varying in different species as regards number, size and situation. They may be dilatations of the laryngeal ventricle (opening into the larynx below the false vocal chords), as in the man-like apes; or they may open above the false vocal chords so as to be extensions of the thyro-hyoid membrane, as in gibbons. There may be but a single median opening in the front part of that membrane at the base of the epiglottis, as in *Cercopithecoidea*, or there may be a single median opening at the back of the trachea, just below the cricoid cartilage, as in spider-monkeys; and while there is in some instances only a single sac, in other instances, as in the howlers, there may be five. These may be enormous, meeting in the middle line in front, and extending down to the axillae, as in the gorilla and orang-utan. Finally a sac may occupy the cavity of the expanded body of the hyoid-bone, as in howlers (fig. 3). The hyoid has its basilar part generally somewhat more convex and enlarged than in man; but in howlers it becomes greatly enlarged and deeply excavated, so as to form a great bony bladder-like structure (fig. 3). The cornua of the hyoid are never entirely absent, but the anterior or lesser cornua may be so, as in the howlers. The anterior cornua never exceed the posterior cornua in length; but they may be (*Cercopithecus*) more developed relatively than in man, and may even be jointed, as in *Lagothrix*.

The lungs are generally similar to those of man, although, as in gibbons, the right one may be four-lobed. In the man-like apes the great arteries are likewise of the human type; but in the *Hylobatidae* and *Cercopithecoidea* the left carotid may arise from the innominate. The discoidal and deciduate placenta is generally two-lobed, although single in the howlers; in the marmosets it is unusually thick. American monkeys differ from their Old World



(From a sketch by Wolf from life.)

FIG. 7.—An Immature Chimpanzee (*Anthropopithecus troglodytes*). Cousins in having two umbilical veins in place of a single one. In the *Cercopithecoidea* gestation lasts about seven months, but in the marmosets is reduced to three. The young, which are generally carried on the breast, are suckled for about six months in most monkeys.

Man-like Apes.—In common with man, the apes and monkeys of the Old World form a section—Catarrhina—of the sub-order Anthropoidea, characterized by the following features: There are only two pairs of premolar teeth, so that the complete dental formula is $i, \frac{2}{2}, c, \frac{1}{1}, p, \frac{2}{2}, m, \frac{3}{3}$. The tympanum has an external bony tube, or meatus; but there is no tympanic bulla. A squamoso-frontal suture causes the frontal and the alisphenoid bones to enter largely into the formation of the orbital plate; and the orbito-temporal foramen is small. Cheek-pouches and callosities on the buttocks are frequently present. The nails are flat or rounded, the descending colon of the intestine has an S-like (sigmoid) flexure;



FIG. 8.—Adult Male Gorilla (*Anthropopithecus gorilla*).

the caecum is simple, and there may be a vermiform appendix. The inter-nasal septum is thin, and the nostrils are directed outwards. The tail, which may be rudimentary, is never prehensile. The ethmoturbinal bones of the nasal chamber are typically united. Laryngeal sacs are commonly developed. In addition to the primary discoidal placenta, a secondary, and sometimes temporary one is developed.

It does not come within the province of this article to treat of man (see ANTHROPOLOGY); but it may be mentioned that the distinctive characteristics of the family *Hominidae* (including the single genus *Homo*), as compared with those of the *Simiidae*, or man-like apes, are chiefly relative. These are shown by the greater size of the brain and brain-case as compared with the facial portion of the skull, smaller development of the canine teeth of the males, more complete adaptation of the structure of the vertebral column to the vertical position, greater length of the lower as compared with the upper extremities, and the greater length of the great toe, with almost complete absence of the power of bringing it in opposition to the other four toes. The last and the small size of the canine teeth are perhaps the most marked and easily defined distinctions that can be drawn between the two groups, so far as purely zoological characters are concerned. The regular arch formed by the series of teeth is, however, as already mentioned, another feature distinguishing man from the man-like apes.

In common with the gibbons (*Hylobatidae*) the man-like apes, or *Simiidae*, are distinguished from the lower representatives of the present sub-order by the following features: The sternum is short and broad, and the thorax wide and shallow (fig. 6), while the pelvis, as shown in the same figure, is more or less laterally expanded, and hollow on its inner-surface; and the number of dorso-lumbar vertebrae ranges from sixteen to eighteen. The arm is longer than the leg; and while the hair on the fore-arm is directed upwards, that of the upper-arm slopes downwards to meet it at the elbow. Cheek-pouches are absent. The cusps of the molars are separate; and five in number above and four below. The caecum has a vermiform appendix; and the secondary placenta merely forms a temporary fold. The *Simiidae* are specially characterized by the absence of callosities on the buttocks; the presence of sixteen or seventeen dorso-lumbar vertebrae, and of twelve or thirteen pairs of ribs; the wrinkling of the enamel of the cheek-teeth; the great expansion and concavity of the iliac bones of the pelvis; and the application of only the edge of the sole of the foot to the ground in walking.

The existing members of the family are referable to at least two genera, the one African and the other Asiatic. The first genus, *Anthropopithecus*,¹ is typified by the West African chimpanzee, *A. troglodytes* (fig. 7), and is characterized by the absence of excessive elevation in the skull, by the fore limb not reaching more than half-way down the shin, the presence of thirteen pairs of ribs, the well-developed great toe, the absence of a centrale in the carpus, and the black or grey hair. There is a well-developed laryngeal sinus, which may extend downwards to the axilla. Chimpanzees are characterized by the large size of the ears, and typically by the small development of the supra-orbital ridges. The latter are, however, more developed in the Central African *A. tchego* (of which the kulu-kamba is a local phase); this form—whether regarded as a species or a race—being thus more gorilla-like (see CHIMPANZEE).

The gorilla (*Anthropopithecus gorilla*, fig. 8), of which there are likewise several local forms, ranging from the West Coast through the forest-tract to East Central Africa, and apparently best regarded as sub-species, is frequently made the type of a second genus—*Gorilla*; but is extremely close to the chimpanzee, from which it is perhaps best distinguished by its much smaller ears. It is the largest of the apes, although the females are greatly inferior in stature and bulk to the males. The gorilla is also a much less completely arboreal ape than the chimpanzee, in consequence of which more of the sole of the foot is applied to the ground in walking. The enormous supra-orbital ridges of the skull of the male, and likewise the large and powerful tusks in that sex are very characteristic. A full-grown gorilla will stand considerably over six feet in height. According to Dr A. Keith, in addition to its smaller and flatter ears, the gorilla may be best distinguished from the chimpanzee by the presence of a nasal fold running to the margin of the upper lip; by the large size and peculiar characters of the tusks and cheek-teeth; by its broad, short, thick hands and feet, of which the fingers and toes are partially webbed; by the long heel; and by the relative length of the upper half of the arm as compared with the fore-arm. An important distinctive feature of the skull of the gorilla is the great length of the nasal bones. Finally, in adult life the gorilla is sharply differentiated from the chimpanzee by its sullen, untameable, ferocious disposition.

As regards the relationship existing between the gorilla and the chimpanzee, Dr Keith observes: "An examination of all the structural systems of the African anthropoids leads to the inference that the gorilla is the more primitive of the two forms, and approaches the common parent stock more nearly than does the chimpanzee. The teeth of the gorilla, individually and collectively, form a complete dentition, a dentition at the very highest point of development; the teeth of the chimpanzee show marked signs of retrogression in development both in size and structure. The muscular development and the consequent bony crests for muscular attachment of the gorilla far surpass those of the chimpanzee. The muscular development of the adult chimpanzee represents that of the adolescent gorilla. Some of the bodily organs of the gorilla belong to a simpler and earlier type than those of the chimpanzee. But in one point the chimpanzee evidently represents more nearly the parent form—its limbs and body are more adapted for arboreal locomotion; of the two, the gorilla shows the nearer approach to the human mode of locomotion. On the whole the evidence at our disposal points to the conclusion that the chimpanzee is a derivative from the gorilla stock, in which, with a progressive brain development, there have been retrograde changes in most of the other parts of the body. The various races of chimpanzee differ according to the degree to which these changes have been carried." (See GORILLA.)

From both the chimpanzee and the gorilla the orang-utan, or mias (*Simia satyrus*), of Borneo and Sumatra is broadly distinguished by the extreme elevation of the skull (fig. 4), the excessive length of the fore limbs, which reach to the ankle, the presence of only twelve pairs of ribs and of a centrale in the carpus, the short and rudimentary great toe, and the bright-red colour of the hair. Adult males are furnished with a longish beard on the chin, and they may also develop a large warty prominence, consisting of fibro-cellular tissue, on each side of the face, which thus assumes an extraordinary wide and flattened form. There is no vestige of a tail. The hands are very long; but the thumb is short, not reaching the end of the metacarpal bone of the index-finger. The feet have exceedingly long toes, except the great toe, which only reaches to the middle of the first joint of the adjacent toe, and is often destitute not only of a nail, but of the second phalanx also. It nevertheless possesses an *opponens* muscle. The brain has the hemispheres greatly convoluted, and is altogether more like the brain of man than is that of any other ape. A prolongation is developed from each ventricle of the larynx, and these processes in the adult become enormous, uniting together in front over the windpipe and forming one great sac which extends down between the muscles to the axilla. The canine teeth of adult males are very large. In Borneo the orang-utan displays great variability, and has accordingly been divided into a number of local races, in some of which the males

apparently lack the lateral expansion of the face. Whether the Sumatran orang-utan should be regarded as a distinct species, with two local races, may be left an open question. (See ORANG-UTAN).

Gibbons.—The comparatively small, long-armed and tailless Asiatic apes known as gibbons have been very generally included in the same family as the man-like apes; but since they differ in several important features—to say nothing of their smaller bodily size—it has recently been proposed to refer them to a family apart, the *Hylobatidae*. The distinctive features of this family include the presence of small naked callosities on the buttocks, the possession of eighteen dorso-lumbar vertebrae and thirteen pairs of ribs, the absence of foldings in the enamel of the molar teeth, the slight lateral expansion and concavity of the iliac bones of the pelvis, and the application of the whole sole of the foot to the ground in walking. The vertebral column presents no trace of the sigmoid flexure which is developed partially in the *Simiidae* and completely in the *Hominidae*. None of the gibbons have any rudiment of a tail; and the canines are elongated and tusk-like. When the body is erect, the arms are so long that they reach the ground. The great toe is well developed, reaching to the middle or end of the first joint of the adjacent toe; but the thumb only attains to, or reaches a little beyond, the upper end of the first joint of the index-finger. There is a centrale in the carpus. The laryngeal sacs are no longer prolongations of the laryngeal ventricles, but open into the larynx above the false vocal chords. The group is distributed throughout the forest-regions of south-eastern Asia, eastwards and southwards from Assam, and is represented by a considerable number of species. Among these, the siamang, *Hylobates syndactylus*, of Sumatra and the Malay Peninsula, differs from all the rest by the union of the index and third fingers up to the base of their terminal joints, in consequence of which this species is regarded as representing a sub-genus (*Symphalangus*) by itself, while all the others belong to *Hylobates* proper. The general colour of gibbons is either pale fawn or black, with or without a white band across the forehead. In a female from Hainan in the menagerie of the Zoological Society of London, the colour of the coat changed from black to fawn about the time full maturity was attained. Apparently no such change takes place in the male. According to Dr W. Volz, the two banks of the Lematang River in the Palembang district of Sumatra are respectively inhabited by two different species of gibbons—on the west bank is found the siamang (*Hylobates syndactylus*), while the country to the east of the river is the home of the agile gibbon, or waw-waw (*H. agilis*). It is not necessary to capture, or even to see, specimens of the two species in order to satisfy oneself as to their limitations, for they may be readily distinguished by their cries: the siamang calling in a single note, whereas the cry of the waw-waw forms two notes. The remarkable thing about their distribution in Palembang is that the two species are found in company throughout the rest of Sumatra; and even in Palembang itself they inhabit the mountain districts, where the river is so narrow that they could easily leap over it, and yet they keep to the opposite banks. Gibbons are perhaps the most agile of all the Old World monkeys, rivalling in this respect the American spider-monkeys, despite their lack of the prehensile tails of the latter (see GIBBON).

Langur Group.—The well-known long-tailed langur monkeys of India and the adjacent regions are the first representatives of the third family of apes and monkeys, which includes all the remaining members of the sub-order now under consideration. In the *Cercopithecidae*, as the family is called, the following features are distinctive: The sternum, or breast-bone, is narrow and elongated, and the thorax compressed and wedge-shaped, while the iliac bones of the pelvis are narrow, with the inner surface flat; the dorso-lumbar vertebrae are nineteen or twenty in number. The front limbs are shorter than the hind pair; the whole sole of the foot is applied to the ground in walking; and the hair on the arm is directed downwards from the shoulder to the hand. There are always bare callosities on the buttocks, and very generally cheek-pouches. The caecum is conical. Transverse ridges connect the cusps of the molars. The secondary placenta is fully developed.

The first group of the family is represented by the langurs and their allies, collectively forming the sub-family *Semnopithecinae*, in which the tail and hind limbs are very long, and the body is slender; there are no cheek-pouches, but, on the other hand, the stomach is complicated by sacculations or pouches, and the last lower molar has a posterior heel, thus carrying five cusps. The thumb is small or absent, the callosities on the buttocks are also small, and the nails are narrow and pointed. The laryngeal sac (or throat-sac) opens in the middle line of the front of the larynx, and is formed by an extension of the thyro-hyoid membrane. The true langurs, of the genus *Semnopithecus*, in which a small thumb is retained, form a large group confined to south-eastern Asia, where it ranges from India and the Himalaya to Borneo and Sumatra by way of Burma, Cochin China and the Malay Peninsula. A well-known representative is the sacred hanuman monkey (*S. entellus*) of India, which, like the larger Himalayan *S. schistaceus*, is slate-coloured; the Bornean *S. hosei*, on the other hand, is wholly maroon-red. Other species, like the Indian *S. johni*, have the head crested. The allied genus *Rhinopithecus*, as typified by the orange

¹ It has been proposed to transfer the name *Simia* to the chimpanzee, on the ground that it was originally given to that animal.

snub-nosed monkey, *R. roxellanae* (fig. 9), of eastern Tibet and Szechuen, is characterized by the curiously short and upturned nose and the long silky hair of the back, especially in the winter coat. In the typical species the predominating colour is orange, tending to yellowish-olive on the back; but in *R. bieti* of the mountains bordering the valley of the Mekon and *R. brelichi* of Central China it is slaty-grey. The third Asiatic genus is represented by the proboscis monkey (*Nasalis larvatus*) of Borneo, in which the nose is extraordinarily elongated. The nose of the adult male is commonly



(From Milne-Edwards.)

FIG. 9.—The Orange Snub-nosed Monkey (*Rhinopithecus roxellanae*).—represented as projecting straight out from the face, but it really bends down to overhang the upper lip; it is much shorter in the female, and quite small and bent upwards in the young. (See LANGUR and PROBOSCIS MONKEY.)

The African guerezas, forming the genus *Colobus*, differ from their Asiatic cousins by the total loss of the thumb. Some of these monkeys, like *Colobus satanas* of West Africa, are wholly black; but in others, such as *C. guereza* (or *abyssinicus*), *C. sharpei* and *C. caudatus* of North-east and East Africa, forming the sub-genus *Guereza*, there is much long white hair, which in the species last-named forms a mantle on the sides of the body and an elongated fringe to the tail, thus assimilating the appearance of the animal to the long lichens hanging from the boughs of the trees in which it dwells. Most or all of the *Semnopithecinae* feed on leaves; a circumstance doubtless correlated with the complex structure of their stomach.

Cercopitheques, Mangabeys, Macaques and Baboons.—The whole of the remaining members of the family *Cercopithecidae* are included in the sub-family *Cercopithecinae*, which presents the following characteristics: The hind limbs are not longer than the front pair; the tail may be either long, short or practically absent; cheek-pouches are present; the stomach is simple; the callosities on the buttocks are often very large; the last lower molar may or may not have a posterior heel; and the thumb is well developed. Whereas all the *Semnopithecinae* are completely arboreal, many of the *Cercopithecinae*, and more especially the baboons, are to a great extent or entirely terrestrial. The typical representatives of the group are the African monkeys, forming the genus *Cercopithecus*, which includes a very large number of species with the following characters in common: the tail, although shorter than in the *Semnopithecinae*, is long, as are the hind limbs, while the general form is slender. The jaw and muzzle are short and the cheek-pouches large; while the nose is not prominent, with the nostrils approximated; whiskers and a beard of variable length are usually developed. The fingers of the long hands are united by webs at the base; the thumb is small in comparison with the great toe. The callosities are of moderate size; and the hairs of the thick and soft fur are in most cases marked by differently-coloured rings. For convenience of description the numerous species of this genus may be arranged in a number of groups or sub-genera. The first of these groups includes the spot-nosed forms (*Rhinostictus*), characterized by the presence of a spot of white, red or blue on the nose; well-known species,

being the lesser white-nosed guenon (*C. pelturista*) of West Africa and the hocheur, *C. nictitans*, which is also West African. In the typical group, as represented by the malbrouck monkey (*C. cynosurus*) of the West Coast, and the Abyssinian grivet (*C. sabaeus*), the fur of the back is of a more or less olive-green hue, while the under surface and whiskers are white and the limbs grey. The large patas monkey (*C. patas*) of West Africa and the red-backed monkey (*C. pyrrhonotus*) of Kordofan typify a third section (*Erythrocebus*), characterized by the red upper and white lower surface of the body. A fourth section (*Mona*) includes the mona (*C. mona*) of Western, and Sykes's monkey (*C. albigularis*) of Eastern Africa, with a number of allied species, characterized by the presence of a black band running from the outer angle of the eye to the ear, and the black or dark-grey limbs. The bearded monkey (*C. pogonias*) of Fernando Po and Guinea, with two sub-species, typifies a small section (*Otopithecus*), characterized by large rufous or yellowish ear-tufts and the presence of three black stripes on the forehead. *Pogonocebus* is another small section, including the well-known Diana monkey (*C. diana*) of Western, and De Brazza's monkey (*C. neglectus*) of Eastern Africa, easily recognized by the long (generally white) beard and frontal crest. Finally, the little talapoin (*C. talapoin*) of the Gaboon alone represents a group (*Miopithecus*) broadly distinguished by having three, in place of four, cusps on the crowns of the lower molars.

The next group is that of the African mangabeys (*Cercocebus*), the more typical species of which are easily recognized by their bare flesh-coloured eyelids, and the absence of rings of different colours on the hair, or at least on that of the back. In these monkeys the general form is intermediate between that of the cercopitheques and the macaques, to be next mentioned, the head being more oval and the muzzle more produced than in the former, but less so than in the latter. The limbs are longer and the body is more slender than in the macaques, and the callosities are also smaller. On the other hand, the thumb is smaller than in the guenons, and the tail is carried curled over the back instead of straight; while these monkeys differ from the former in having a posterior heel to the last lower molar, which is thus five-cusped, as in the macaques. The laryngeal air sacs of the latter are, however, wanting. Well-known representatives of the typical section of the group are the sooty mangabey (*C. fuliginosus*) and the white-collared mangabey (*C. collaris*) of West Africa, the latter easily recognized by the bright red crown of the head. A second group of the genus, *Lophocebus* (or *Semnocebus*) is typified by the white-cheeked mangabey (*C. albigena*) of the equatorial forest-region, in which the head is crested and the eyelids lack bare flesh-coloured rims. The rhesus monkey (*Macacus rhesus*) of India is the typical representative of the macaques, which may be regarded as the Asiatic representatives of the mangabeys. From that group the macaques differ by their heavier and stouter build (fig. 10), thicker limbs, the presence of large laryngeal sacs, the larger size of the callosities, and the more produced muzzle, while many of them have the tail (which may be absent) much shorter. The nostrils are not terminal, and the hairs are generally ringed. In habits the macaques are much more terrestrial than the mangabeys, some of them being completely so. In the typical group, which, in addition to the rhesus, includes the Himalayan macaque (*M. assamensis*), the brown macaque (*M. arctoides*) of Burma and Tibet (fig. 10), the tail may be about

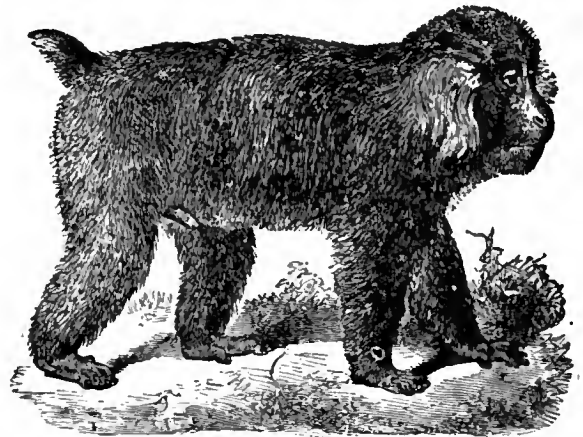

(From Milne-Edwards.)

FIG. 10.—The Tibet Macaque (*Macacus arctoides tibetanus*).

equal to half the length of the body or less; but in the Barbary ape, *M. (Inuus) inuus*, of North Africa and Gibraltar, this appendage is wanting. In a third group (*Nemestrinus*), represented by the pig-tailed macaque (*M. nemestrinus*), ranging from Burma to Borneo, and the lion-macaque (*M. leoninus*) of Siam, the tail, which is carried erect, is about one-third the length of the body. The lion-tailed macaque (*M. silenus*) of southern India, often miscalled the wanderer, represents a group by itself (*Vetulus*) characterized by

the long hair fringing the face and meeting under the chin, and the tufted lion-like tail, which is from one-half to three-quarters the length of the body. The last group (*Cynomolgus*), now often regarded as a distinct genus, is typified by the widely-spread crab-eating macaque (*M. cynomolgus*), characterized by its produced muzzle, short and stout limbs, and basally-swollen tail, which is nearly as long as the body. It also includes the South Indian bonnet-macaque (*M. sinicus*) and the Ceylon toque-macaque (*M. pileatus*), taking their names from the elongated hair on the crown, which are nearly allied, and with the first-named species approach the baboons in their elongated muzzles (see MACAQUE).

A still nearer approach to the baboons is made by the black ape (*Cynopithecus niger*) of Celebes and the neighbouring islands, which is represented by several sub-species, among them the so-called

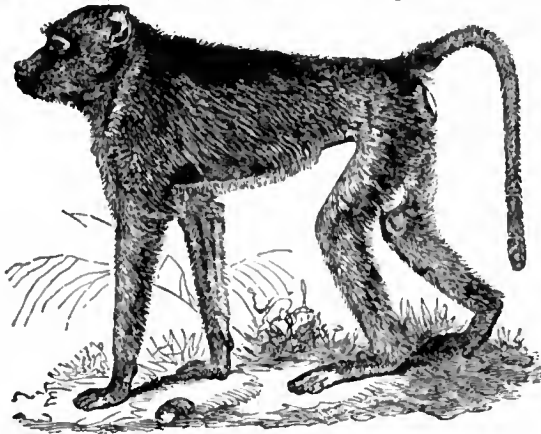

FIG. 11.—The Yellow Baboon (*Papio cynocephalus*).

Moor-macaque (*Macacus maurus*). Some difference of opinion exists as to the proper serial position of this species, which is included in *Macacus* by several zoologists who separate *Cynomolgus* as a genus. It is characterized by the marked elongation of the muzzle, which, like the neck, hands and feet, is naked. The nostrils are, however, directed outwards and downwards, as in the macaques; but, on the other hand, there are baboon-like ridges on the sides of the muzzle and heavy supra-orbital ridges. There are large cheek-pouches; and the tail is a mere stump. The colour is sooty-black. The weird-looking gelada baboon (*Theropithecus gelada*) of southern, and the allied *T. obscurus* of eastern Abyssinia represent a genus which is essentially baboon-like in general characteristics, but has the nostrils of the macaque-type, while the facial portion of the skull is shorter than the cranial. The preorbital portion of the face is concave with the ridges rounded, and the tusks are very long. The long tail is tufted at the tip, and the hair is long and bushy, developing into a mantle-like mane on the fore-quarters of old males, leaving the chest bare. The general colour is dark-brown. The last representatives of the *Cercopithecidae* are the baboons, or dog-faced baboons, of Africa and Arabia, forming the genus *Papio*. These are for the most part large monkeys, associating in herds under the leadership of an old male, and dwelling chiefly among rocks, although they ascend trees in search of gum. They are easily recognized by their long dog-like faces (fig. 11), in which the nostrils open at the extremity of the greatly elongated muzzle. On the sides of the muzzle are prominent longitudinal ridges covered with bare skin which may be brilliantly coloured. The callosities, which are also generally bright-coloured, are large; and the tail is of moderate length or short. The hairs are ringed with different colours, and the general colour is olive-yellow, grey or brownish. The typical, and at the same time the smallest representative of the group is the yellow baboon (*P. cynocephalus* or *P. babuin*) (fig. 11), ranging from Abyssinia to Angola and Mozambique, and distinguished by its rather short and grooved muzzle and longish tail, which is nearly as long as the body. The majority of the species, such as the widely spread *P. anubis* (with several local races), *P. sphinx* of West Africa, and the chaema (*P. porcarius*) of South Africa, are included in the sub-genus *Chaeropithecus*, and have the muzzle longer and undivided and the tail shorter, in most the colour is golden-olive with very distinct rings, but in the chaema it is darker. The hamadryad baboon, *P. hamadryas*, of north-east Africa and Arabia, and the closely allied *P. arabicus* of southern Arabia, represent a sub-genus (*Hamadryas*) characterized by the ashy-grey colour and the profuse mantle-like mane of the adult males; the tail being slightly shorter than the body. Lastly, the West African mandrill (*P. maimon*) and drill (*P. leucophaeus*) form the sub-genus *Maimon*, distinguished by the extremely short tail, and the great development of the facial ridges, which are strongly fluted. In the mandrill, which is the most brilliantly coloured of all mammals, the ridges are vermilion and cobalt, while the callosities on the buttocks are of equal brilliance; but in the drill, which has white ear-tufts, the colouring is more sombre (see BABOON and MANDRILL).

American Monkeys and Marmosets.—The monkeys and marmosets of tropical America constitute the Platyrrhina, or second section of the Anthropoidea, and are characterized as follows: An additional premolar is present in both jaws, bringing up the number of these teeth to three pairs. The tympanum is ring-like, with no external bony-tube, or meatus; and a tympanic bulla exists. A parieto-zygomatic suture causes the jugal bone to be included in the orbital plate; and the orbito-temporal foramen is large. Cheek-pouches and callosities on the buttocks are wanting. The descending colon does not form a sigmoid flexure; and the caecum is generally bent in a hook-like form, with, at most, very slight narrowing of its terminal extremity. The cartilage forming the inter-nasal septum is broad, and the nostrils are directed obliquely outwards. The tail, which never has fewer than fourteen vertebrae, is generally as long as the body, and frequently prehensile. The ethmoturbinals are originally separate; and the laryngeal sac, when present, is of peculiar type. Usually there is only a simple primary discoid placenta, but rudiments of a secondary one have been recently described.

The first family, or *Cebidae*, includes the American monkeys, as distinct from marmosets, which present the following characteristics: The ears are more or less naked externally. The terminal joints of the fingers and toes carry flat or curved nails; and the thumb, when present, is opposable to the other fingers. Except in the uakaris, the tail is long, generally short-haired, and frequently with a terminal bare surface for prehension. Dentition $i. \frac{2}{1}, c. \frac{1}{1}, p. \frac{3}{3}, m. \frac{3}{3}$. Generally a foramen (entepicondylar) in the inner side of the lower end of the humerus. As a rule, only a single offspring is produced at a birth. Ranging over tropical America, the *Cebidae* have their headquarters in the vast Brazilian forests, where so many of the animals are more or less arboreal in their habits. These monkeys are completely arboreal, more so, indeed, than the gibbons among the Catarrhina.

The first sub-family, *Alouatinae*, is represented only by the howlers, *Alouata* (or *Myceles*), characterized by the long prehensile tail with the extremity naked below, the well-developed thumb, and the extension of the hyoid-bone into an enormous bladder-like chamber contained between the two branches of the lower jaw (fig. 3). In this bony cup is received one of the three or five laryngeal sacs. There are about half a dozen species, with several sub-species; three of the best known being *A. seniculus*, *A. belzebul* and *A. ursina*. Several are brilliantly coloured, with bright or golden hair on the flanks; but in the Amazonian *A. nigra* the male is black and the female straw-coloured. The muzzle is longer than in other *Cebidae* (see HOWLER).

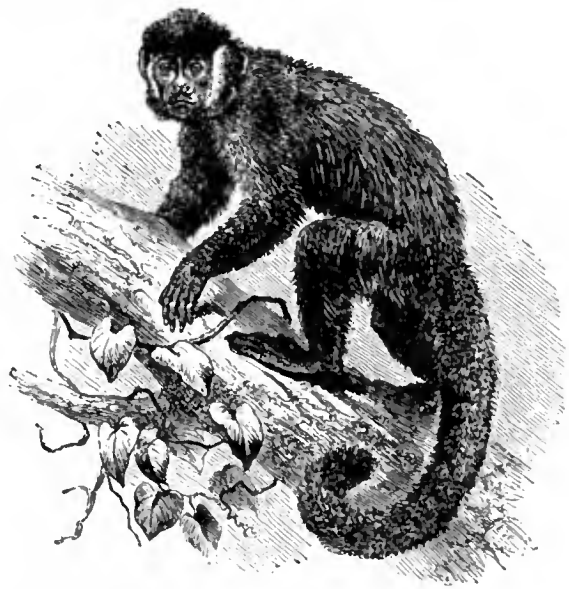

FIG. 12.—The White-cheeked Capuchin (*Cebus lunatus*).

The *Cebinae* include the typical members of the family, characterized by the large brain, of which the elongated hemispheres cover the cerebellum; the brain-case of the skull being, of course, elongated in proportion. The lumbar vertebrae are short, with upright comb-like processes, instead of the rhomboidal ones of the howlers. The lower jaw and hyoid are of normal form. In the first section of the sub-family the tail is evenly haired throughout, the thumb

well developed, the limbs of medium length, with the front not longer than the hind pair, the nails curved, and the humerus with an entepicondylar foramen. The typical genus *Cebus* includes the numerous species of capuchins, many of which are so commonly seen in captivity. They are stouter in build and smaller in size than the spider-monkeys, and their tails are only prehensile to a small extent, but are commonly carried spirally rolled. The conical upper canines project below the upper lip, and the molars have blunt low cusps. Well-known species are the white-cheeked capuchin, *C. lunatus* (fig. 12), of south Brazil; the true capuchin, *C. capucinus*, ranging from Guiana to Brazil; and the brown capuchin, *C. fatuellus*, of Guiana; all of these showing the black crown from which these monkeys take their popular name. The most northern representative of the group is the white-throated *C. hypoleucus*, which ranges to Costa Rica. The squirrel-monkeys, *Chrysothrix* (or *Saimiris*), of which *C. sciureus* is the most familiar representative, are not unfrequently placed in the *Nyctipithecinae*, although their true position seems to be here. They differ from *Cebus* by their smaller size and more delicate build, by the tail being scarcely at all prehensile, by the smaller canines, smaller and more sharply cusped molars, and the large and closely-approximated orbits, whose inner walls are partly membranous (see CAPUCHIN and SQUIRREL-MONKEY).

The second section of the sub-family includes the spider-monkeys (fig. 13), and is characterized by the completely prehensile tail,

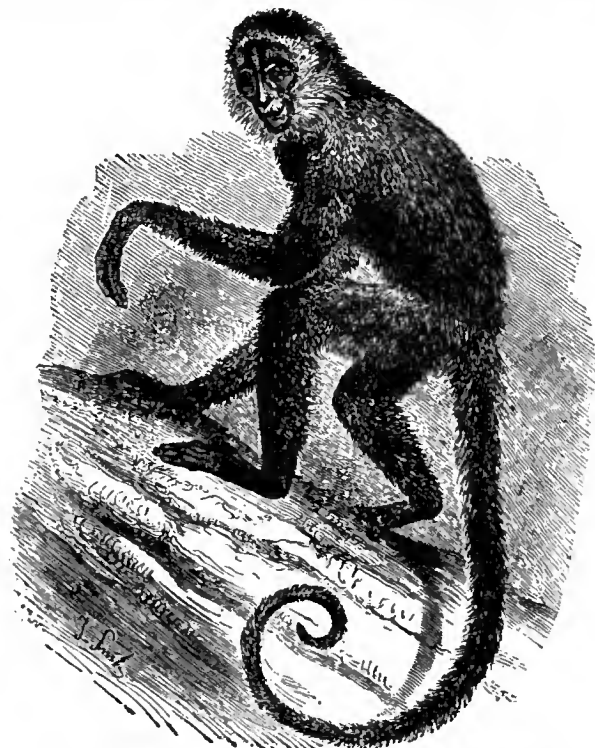

FIG. 13.—Geoffroy's Spider-Monkey (*Ateles geoffroyi*).

with the inner surface of the tip naked, the rudimentary condition or absence of the thumb, the laterally compressed and more or less pointed nails, and the absence of an entepicondylar foramen to the humerus. The limbs, too, are very long and slender, with the front pair of greater length than the hind ones. The caecum approximates to that of the Catarrhina, having its terminal extremity pointed. The true spider-monkeys (*Ateles*) lack the thumb, and have the nails but slightly compressed and pointed, the limbs very long, the nasal septum of ordinary width, and the fur not woolly. Nearly all have the hair on the head, except that of the forehead, directed forwards. There are nearly a dozen species. In these monkeys so powerful is the grasp of the tail that the whole body can be sustained by this organ alone. It even serves as a fifth hand, as detached objects, otherwise out of reach, can be grasped by it, and brought towards the hand or mouth. Their prehension is in other respects exceptionally defective, owing to the loss of the thumb. Spider-monkeys are very gentle in disposition; and, by this and their long limbs and fitness for tree-life, seem to represent the gibbons of the Old World. Nevertheless, in spite of their admirable adaptation for arboreal life, their comparatively slow progression offers a marked contrast to the vigorous agility of the gibbons (see SPIDER-MONKEY). The brown spider-monkey (*Brachyteles arachnoides*) of south Brazil alone represents a genus connecting the preceding in some degree with the next, a rudimentary thumb being present, while the fur is woolly, the nails are much compressed, and the nostrils more approximated

than usual. In the woolly spider-monkeys of the genus *Lagothrix* (fig. 14) not only is the fur woolly, but the thumb is fairly well developed; the nails are like those of *Brachyteles*, but the nostrils are normal. Humboldt's spider-monkey, *L. humboldti* (or *L. lagotrica*) and the dusky spider-monkey, *L. infumata*, both of which occur in Brazil and Amazonia, alone represent this genus.

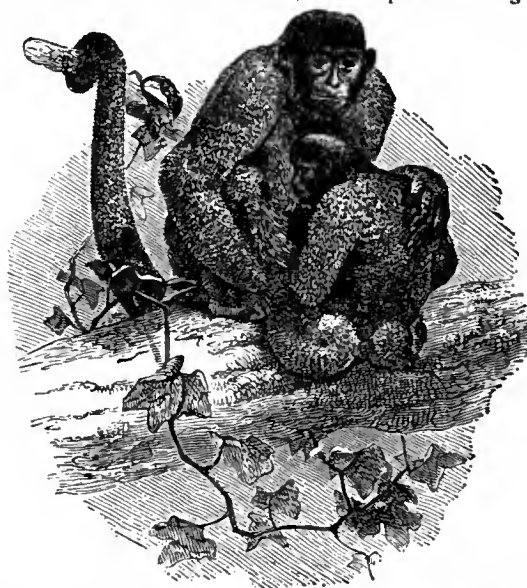

FIG. 14.—Humboldt's Woolly Spider-Monkey (*Lagothrix humboldti*).

Some half-dozen species of the monkeys known as sakis (*Pithecia*) form the typical representatives of the sub-family *Pitheciinae*, in which the tail, even when long, is non-prehensile, while the lower incisors are slender and inclined forwards in a peculiar manner, with a gap on each side separating them from the long canine. The hemispheres of the brain cover the cerebellum, the brain-case is elongated, and, despite the absence of a laryngeal sac, the lower jaw is deep with a large angle, thus recalling that of the howlers. There is no caecum. In all cases the thumb is well developed. The arrangement of the hair is very variable. From the other members of the group the sakis are sufficiently distinguished by the long and bushy tail; while they are further characterized by having a large head. In some cases the hair on the crown of the



FIG. 15.—Lemur-like Douroucouli (*Nyctipithecus felinus*).

head is divided by a transverse parting, so as to overhang the upper part of the face. *P. satanas* of Pará and *P. chiropotes* of Guiana are well-known species. The uakaris (*Uacaria* or *Cothurus*) of Amazonia are broadly distinguished from all other *Cebidae* by their short or rudimentary tails; *Ua. calva* being remarkable for its brilliant red jaw and pale chestnut hair (see UAKARI).

The last and lowest representatives of the *Cebidae* constitute the sub-family *Nyctipithecinae*, the members of which are cat-like monkeys, with woolly or bushy hair, short, conical muzzles, non-prehensile tails and well-developed thumbs. The brain-case of the skull is not elongated, and the hemispheres of the brain do not cover the cerebellum. The lumbar vertebrae are elongated, with long, sharp, backwardly directed spinal processes; the hinder part of the lower jaw is tall; and there is no laryngeal sac. The

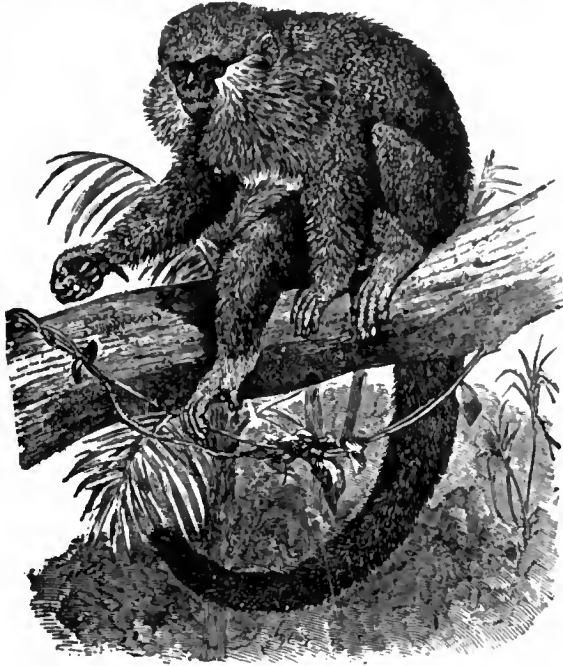

FIG. 16.—The Moloch Titi (*Callithrix moloch*).

long and hooked caecum has its terminal portion constricted. In accordance with their nocturnal habits, the douroucoulis (*Nyctipithecus*) are easily recognized by their large and closely approximated eyes, which are, however, separated by a complete septum, the comparatively narrow nasal septum, small ears buried in the



FIG. 17.—The Golden Marmoset (*Hapale chrysouleuca*).

woolly fur, and long bushy tail. Well-known species are the lemur-like douroucoulis (*N. felinus*, fig. 15) of Amazonia, Peru and Ecuador, and *N. vociferans*, with a nearly similar distribution. The titis, *Callithrix* (or *Callicebus*¹), are smaller monkeys (fig. 16),

¹ Apparently the name *Callithrix* was originally given to the marmosets, and if transferred to that group should be replaced by *Callicebus*.

with more forwardly directed eyes, which are not surrounded by a radiating fringe of hair and a wider nasal septum. The titis are represented by about ten species, of which *C. moloch* is represented in fig. 16. Most of them are confined to Amazonia, but a few among them *C. moloch*, reach the east coast. Like the marmosets, they feed largely upon insects and grubs.

The second and last family of the Platyrrhina is represented by the marmosets or oustitis (*Hapalidae*), all of which are small monkeys, with the ears hairy externally, and the nails, except that of the great toe, claw-like, the thumb non-opposable, the tail long, bushy and non-prehensile, and only two molars in each jaw, the dental formula thus being $i. \frac{2}{1}, c. \frac{1}{1}, p. \frac{2}{2}, m. \frac{2}{2}$. The humerus has no entepicondylar foramen. Three young are produced at a birth. Marmosets are divided into two genera, those in which the lower canines are not markedly larger than the incisors constituting the typical *Hapale*, while such as have the lower canines taller than the teeth between them form the genus *Midas*. These squirrel-like little monkeys, in which the great toe can be opposed to the other toes, range as far north as 15° N., where they are represented by *Midas geoffroyi*, and as far in the opposite direction as the southern tropic, where *M. chrysopygus* and *M. rosalia* occur. The colour and the length of the hair are very variable, some species having long silky pale-chestnut hair (fig. 17) and tufted ears, while in others the hair is comparatively short and black, or black with brown bars, while the ears are not tufted (see MARMOSET).

Lemurs, Prosimiae.—Although the likeness generally takes the form of a more or less grotesque caricature, the faces of all monkeys and apes present, in greater or less degree, some resemblance to the human countenance. In the lower group of Primates, commonly known as lemurs, or lemuroids, this resemblance is wholly lost, and the face assumes an elongated and fox-like form, totally devoid of that "expression" which is so characteristic of man and the higher apes and monkeys.

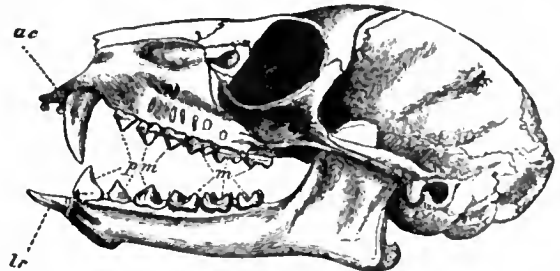

FIG. 18.—Skull of Ring-tailed Lemur (*Lemur catta*) × $\frac{1}{2}$.

uc, Upper canine. pm, Premolars.
lc, Lower canine. m, True molars.

Lemurs, Prosimiae or Lemuroidea, which form a group confined to the tropical regions of the Old World and more numerously represented in Madagascar than elsewhere, are arboreal and for the most part crepuscular or nocturnal Primates, feeding on insects or fruits, or both together and collectively characterized as follows. The tail, which is generally long and thickly haired, is never prehensile. As a rule, there is a single pair of pectoral teats, but an additional abdominal or even inguinal pair may be present. The thumb and great toe are opposable to the other digits, the former being provided with a flat nail, while the second toe is always furnished with a claw; the fourth toe is longer than all the rest, and the second, or index, finger is small or rudimentary. In the skull (fig. 18) the orbital ring is formed by the frontal and jugal bones, and, except in the *Tarsiidae*, there is a free communication between the orbit and the temporal fossa; the lachrymal foramen is situated outside the orbit (fig. 18); the tympanic either forms a free semicircle in the auditory bulla or enters into the formation of the latter; and the foramen rotundum is generally fused into the sphenoidal fissure. Interparietal bones are frequently developed, and the two halves of the lower jaw are generally welded together in front. Except in the genus *Perodicticus*, the humerus is furnished with an entepicondylar foramen at the lower end; the centrale of the carpus is generally free; and the femur is usually provided with a third trochanter. The cerebellum is only partially covered by the hemispheres of the brain, which in the medium-sized and larger species conform to the general type of the same parts in monkeys and apes. The normal dental

formula is $i. \frac{2}{2}, c. \frac{1}{1}, p. \frac{3}{3}, m. \frac{3}{3}$, or the same as in American monkeys; but the upper incisors are small and separated from each other, while the lower ones are large and approximated to the incisor-like canine; the molars have three or four cusps. In all cases the stomach is simple and a caecum present. The testicles are contained in a scrotum, the penis has a bone, the uterus is bicornuate and the urethra perforates the clitoris. The placenta may be either diffuse, with a large allantoic portion, and non-deciduate, or discoidal and deciduate. As a rule, only a single offspring is produced at a birth. Very noteworthy is the occurrence in the females of the Asiatic lorises of what appears to be the vestige of a marsupial apparatus, attached to the front of the pelvis. *Lemur catta* also possesses the rudiment of a marsupial fold; while in both sexes of the aye-aye occurs a skin-muscle corresponding to the *sphincter marsupii* of marsupials.

The distribution of existing lemurs is very peculiar, the majority of the species inhabiting Madagascar, where they for the most part dwell in small patches of forest, and form about one-half the entire mammalian fauna of the island. The remaining species inhabit Africa south of the Sahara and the Indo-Malay countries.

Tarsier.—The tiny little large-eyed Malay lemuroid known as the tarsier, *Tarsius spectrum* (or *T. tarsius*), of the Malay Peninsula and islands, together with its Celebean and Philippine representatives, alone constitutes the section Tarsiina (and the family *Tarsiidae*), which has the following distinctive characteristics: The lower incisor is vertical and the canine of normal form, while the upper incisors are in contact; the orbit is cut off from the temporal fossa by a bony plate, leaving only a small orbital fissure; the tympanum enters into the formation of the auditory meatus, through which passes the canal for the internal carotid artery; the tibia and fibula in the hind-leg are fused together, and the calcaneum and navicular of the tarsus elongated. The tarsier seems to be a primitive form which makes a certain approximation to the Anthropoidea, and differs from other lemuroids in the structure of its placenta. The dental formula is $i. \frac{2}{2}, c. \frac{1}{1}, p. \frac{3}{3}, m. \frac{3}{3}$, total 34. Tarsiers have enormous eyes, occupying the whole front of the orbital region, and are purely nocturnal in their habits, living in trees on the branches of which they move by hopping, a power they possess owing to the elongation of the tarsal bones (see TARSIER).

Malagasy Lemurs.—All the other Prosimiae may be grouped in a second section, the Lemurina, characterized as follows: The lower incisors and the canine are similar in form and inclined forwards (fig. 18); the upper incisors are small and separated by an interval in the middle line; the orbits communicate largely with the temporal fossae; the internal carotid artery enters the skull in advance of the auditory meatus through the foramen lacerum anterius; and the tibia and fibula are separate. The Malagasy lemurs are now all included in the single family *Lemuridae*, which is confined to Madagascar and the Comoro Islands, and characterized by the tympanic ring lying free in the auditory bulla. The typical sub-family *Lemurinae*, which includes the majority of the family group, is characterized by all the fingers except the index having flat nails, the elongation of the facial portion of the skull, the large hemispheres of the brain not covering the cerebellum, the occasional presence of two inguinal in addition to the normal pectoral teats, the dental formula $i. \frac{2}{2}, c. \frac{1}{1}, p. \frac{3}{3}, m. \frac{3}{3}$, with the first upper incisor generally small and sometimes wanting, and the hinder cusps of the upper molars smaller than the front ones. These lemurs are woolly-haired animals, often nearly as large as cats, with the legs longer than the arms, the tail long and bushy, and the spinal processes of the last dorsal and the lumbar vertebrae inclined. In the typical genus *Lemur* (fig. 19), the tarsus is of normal length, the tail at least half as long as the body, the ears are tufted, there are no inguinal teats, the last premolar is not markedly broader than the others, and the upper molars have a conspicuous cingulum. These lemurs have long fox-like faces, and habitually walk on the ground or on the branches of trees on all fours, although they can also jump with marvellous agility. They are gregarious, living in small troops, are diurnal in their habits, but most active towards evening, when they make the woods resound with their loud cries, and feed, not only on fruits and buds, but also on eggs, young birds and insects. When at rest or sleeping, they generally coil their long, bushy tails around their bodies, apparently for the sake of the warmth it affords. They have usually a single young one at a birth, which is at first nearly naked, and is carried about, hanging close to and almost concealed by the hair of the mother's belly. After a while the young lemur changes its position and mounts upon the mother's back, where it is carried about until able to climb and leap by itself. One of the most beautiful species is the ring-tailed lemur (*L. catta*, fig. 19), of a delicate grey colour, and with a long tail marked with alternating rings of black and white. This is said

by G. A. Shaw to be an exception to other lemurs in not being arboreal, but living chiefly among rocks and bushes. Pollen, however, says that it inhabits the forests of the south-west parts of Madagascar, living, like its congeners, in considerable troops, and not differing from them in its habits. He adds that it is extremely gentle, and active and graceful in its movements, and utters at intervals a little plaintive cry like that of a cat. All the others have the tail of uniform colour. The largest is *L. varius*, the ruffed lemur, sometimes black and white, and sometimes reddish-brown, the variation apparently not depending on sex or age, but on the individual. In *L. macaco* the male is black and the female red. *L. mongoz*, *L. fulvus* and *L. rubriventer* are other well-known species.



FIG. 19.—The Ring-tailed Lemur (*Lemur catta*).

In all these lemurs the small upper incisors are not in contact with one another or with the canine, in front of which they are both placed. In the species of *Hapalemur*, on the other hand, the upper incisors are very small, sub-equal and separated widely in the middle line; those of each side in contact with each other and with the canine, the posterior one being placed on the inside, and not in front of the latter. Muzzle very short and truncated. Two inguinal teats, in addition to the normal pectoral pair, are present. The last premolar is broader than those in front, and the upper molars lack a distinct cingulum. The typical *H. griseus* is smaller than any of the true lemurs, of a dark-grey colour, with round face and short ears. It is quite nocturnal, and lives chiefly among bamboos, subsisting on the young shoots. The second species has been named *H. simus*. In *Hapalemur* there is no free centrale to the carpus, and the same is the case with the six or seven species of *Lepidolemur* (*Lepilemur*), in which the first upper incisor is rudimentary or wanting, while the second may also be wanting in the adult. There are small lemurs, with small premaxillae, short snouts, tails shorter than the body, bladder-like mastoid processes, and the upper molars with an inconspicuous cingulum and the hind-cusps of the last two rudimentary; the fourth upper premolar being relatively broad. *Mixocebus caniceps* is an allied generic type (see LEMUR).

The small Malagasy lemurs of the genera *Chirogale*, *Microcebus* and *Opolemur* differ from the preceding in the elongation of the calcaneum and navicular of the tarsus, on which grounds they have been affiliated to the African galagos. The difference in the structure of the tympanum in the two groups indicates, however, that the elongation of the tarsus has been independently developed in each group. These lemurs have short, rounded skulls, large eyes, long hind limbs and tail, large ears, the first upper incisor larger than the second, the last upper premolar much smaller than the first molar and furnished with only one outer cusp, and the mastoid not bladder-like. Some are less than a rat in size, and all are nocturnal. One of the largest, *Microcebus furcifer*, is reddish-grey, and distinguished by a dark median stripe on its back which divides on the top of the head into two branches, one of which passes forwards above each eye. The most interesting peculiarity of these

lemurs is that certain species (*Opolemur samati*, *Chirogale milii*, &c.) during the dry season coil themselves up in holes of trees, and pass into a state of torpidity, like that of the hibernating animals in the winter of northern climates. Before this takes place an immense deposit of fat accumulates upon certain parts of the body, especially the basal portion of the tail. The smallest species, *M. pusillus*, lives among the slender branches on the tops of the highest trees, feeding on fruit and insects, and making nests like those of birds.

In the sub-family *Indrisinae* the dentition of the adult consists of thirty teeth, usually expressed by the formula $i. \frac{2}{1}, c. \frac{1}{1}, p. \frac{2}{2}, m. \frac{2}{2}$; but possibly $i. \frac{2}{1}, c. \frac{1}{1}, p. \frac{2}{2}, m. \frac{2}{2}$. In the milk-dentition there are twenty-two teeth, the two additional teeth in the fore part of the lower jaw having no successors in the permanent series. Hind limbs greatly developed, but the tarsus normal, the great toe of large size, and very opposable; the other toes united at their base by a fold of skin, which extends as far as the end of the first phalange. The thumb is but slightly opposable; and all the fingers and toes are hairy. The length of the tail is variable. Two pectoral teats. Caecum very large, and colon extremely long and spirally coiled. The brain is large and the thorax wide.

The animals of this group are essentially arboreal, and feed exclusively on fruit, leaves, buds and flowers. When they descend

teats, inguinal in position, a feature peculiar to this species. All the digits of both feet with pointed, rather compressed claws, except the great toe, which has a flattened nail; middle digit of the hand excessively attenuated. Vertebrae: C.7, D.12, L.6, S.3, Ca.27 (see AYE-AYE).

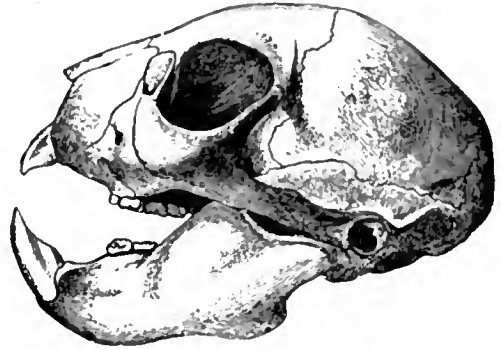
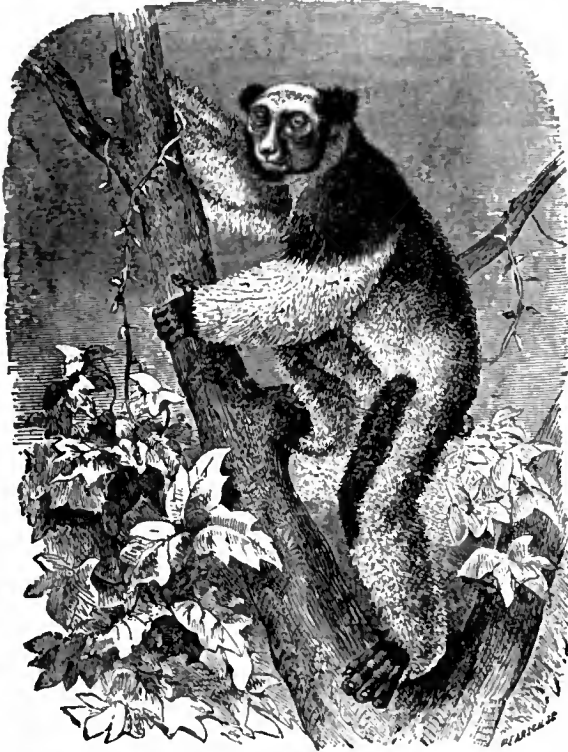

FIG. 21.—Skull of the Aye-aye (*Chiromys madagascariensis*). $\times \frac{1}{2}$.

Galagos and Lorises.—The lemurs of Africa and the Indo-Malay countries—commonly mis-called sloths—differ from the *Lemuridae* in that the tympanic enters into the formation of the auditory meatus, in consequence of which they are referred to a family by themselves, the *Nycticebidae*, which is in turn divided into two sub-families, *Galaginae* and *Nycticebinae*. The African galagos or *Galaginae*, which have the same dental formula as the *Lemuridae*, are distinguished by the elongation of the calcaneum and navicular of the tarsus. In the single genus *Galago*, with the sub-genera *Otolemur* and *Hemigalago*, the last upper premolar, which is nearly as large as the first molar, has two large external cusps. Vertebrae: C.7, D.13, L.6, S.3, Ca.22–26. Tail long, and generally bushy. Ears large, rounded, naked and capable of being folded at the will of the animal. Teats four, two pectoral and two inguinal (see GALAGO). The lorises, *Nycticebinae* (*Lorisinae*), are distinguished as follows: Index-finger very short, sometimes rudimentary and nailless. Fore and hind limbs nearly equal in length. Tarsus not specially elongated. Thumb and great toe diverging widely from the other digits, the latter especially being habitually directed backwards. Tail short or rudimentary. Teats two or four. Lorises and pottos (as the African representatives of the group are called) are essentially nocturnal, and remarkable for the slowness of their movements. They are completely arboreal, their limbs being formed only for climbing and clinging to branches, not for jumping or running. They have rounded heads, very large eyes, short ears and thick, short, soft fur. They feed, not only on vegetable substances, but, like many of the *Lemuridae*, also on insects, eggs and birds, which they steal upon while roosting at night. One of the greatest anatomical peculiarities of these animals is the breaking up of the large arterial trunks of the limbs into numerous small parallel branches, constituting a *rete mirabile*, which is found also in the sloths, with which the lorises are sometimes confounded on account of the slowness of their movements. The Asiatic lorises, which are divided into two genera, are characterized by the retention of the normal number of phalanges in the small index-finger, and the presence of a pair of minute abdominal teats



(From Milne-Edwards and Granddier.)

FIG. 20.—The Indri (*Indris brevicaudatus*).

to the ground, which is but seldom, they sit upright on their hind legs, and move from one clump of trees to another by a series of short jumps, holding their arms above them in the air. Among them are the largest members of the order. The genus *Indris* has the upper incisors sub-equal in size; upper canine larger than the first premolar, muzzle moderately long, ears exerted. Carpus without an os centrale. Tail rudimentary. Vertebrae: C.7, D.12, L.9, S.4, Ca.9. The indri (*I. brevicaudatus*, fig. 20), discovered by Sonnerat in 1780, is the largest of the group, and has long woolly hair, partly brown and partly white. In the sifakas, *Propithecus*, of which there appear to be three species, with numerous local races, the second upper incisor is much smaller than the first. Upper canine larger than the first premolar. Muzzle rather short. Ears short, concealed by the fur. An os centrale in the carpus. Tail long. Vertebrae: C.7, D.12, L.8, S.3, Ca.28. In *Avalhis*, represented only by *A. laniger*, the second upper incisor is larger than the first. Upper canine scarcely larger than the first premolar. Muzzle very short. Ears very small and hidden in the fur, which is very short and woolly. Carpus without os centrale. Tail long. Vertebrae: C.7, D.11, L.9, S.3, Ca.23 (see INDRI and SIFAKA).

The last sub-family, *Chiromyinae* (formerly regarded as a family), is represented only by the aye-aye, *Chiromys* (or *Daubentonia*) *madagascariensis*, and has the following characteristics: Dentition of adult, $i. \frac{2}{1}, c. \frac{1}{1}, p. \frac{2}{2}, m. \frac{2}{2}$, total 18. Incisors (fig. 21) very large, compressed, curved, with persistent pulps and enamel only in front, as in rodents. Teeth of cheek-series with flat indistinctly tuberculated crowns. In the young, the first set of teeth more resemble those of normal lemurs, being $i. \frac{2}{1}, c. \frac{1}{1}, m. \frac{2}{2}$, all very small. Four



(From A. Milne-Edwards.)

FIG. 22.—The Slow Loris (*Nycticebus tardigradus*).

(the existence of which has only recently been discovered by Messrs Annandale and Willey). In the slow lorises, forming the genus *Nycticebus* (fig. 22), the first upper incisor is larger than the second, which is often early deciduous. Inner margin of the orbits separated from each other by a narrow flat space. Nasal and

premaxillary bones projecting but very slightly in front of the maxillae. Body and limbs stout. No tail. Vertebrae: C.7, D.17, L.6, S.3, Ca.12. The single species *N. tardigradus*, with several races, inhabits eastern Bengal, the Malay countries, Sumatra, Borneo, Java, Siam and Cochin China. These lorises lead solitary lives in the recesses of large forests, chiefly in mountainous districts, where they sleep during the day in holes or fissures of large trees, rolled up into a ball, with the head between the hind legs. On the approach of evening they awake, and during the night ramble among the branches of trees slowly, in search of food, which consists of leaves and fruit, small birds, insects and mice. When in quest of living prey they move noiselessly till quite close, and then suddenly seize it with one of their hands. The female produces but one young at a time. In the second genus, represented only by the slender loris (*Loris gracilis*) of southern India and Ceylon, the upper incisors are very small and equal. Orbits very large, and only separated in the middle line above by a thin vertical plate of bone. Nasals and premaxillae produced forwards considerably beyond the anterior limits of the maxillae, and supporting a pointed nose. Body and limbs slender. No external tail. Vertebrae: C.7, D.14, L.9, S.3, Ca.6. The slender loris is about the size of a squirrel, of a yellowish-brown colour, with large, prominent eyes, pointed nose, long thin body, long, angularly bent, slender limbs and no tail. Its habits are like those of the rest of the group. The Indian and Ceylon races are distinct (see LORIS).

The African pottos, *Perodicticus*, differ by the reduction of the index-finger to a mere nailless tubercle, and apparently by the absence of abdominal teats. In the typical section of the genus there is a short tail, about a third of the length of the trunk. Two or three of the anterior dorsal vertebrae have very long slender spinous processes which in the living animal project beyond the general level of the skin forming distinct conical prominences, covered only by an exceedingly thin and naked integument. *P. potto*, the potto, is one of the oldest known members of the lemuroids having been described in 1705 by Bosman, who met with it in his voyage to Guinea. It was, however, lost sight of until 1835, when it was rediscovered in Sierra Leone. It is also found in the Gaboon and the Congo, and is strictly nocturnal and slower in its movements even than *Nycticebus tardigradus*, which otherwise it much resembles in its habits. A second species, *P. batesi*, inhabits the Congo district. A third species, the awantibo (*P. calabarensis*), rather smaller and more delicately made, with smaller hands and feet and rudimentary tail, constitutes the sub-genus *Arctocebus*. It is found at Old Calabar, and is very rare. Vertebrae: C.7, D.15, L.7, S.3, Ca.9.

EXTINCT PRIMATES

The most interesting of all the extinct representatives of the order is *Pithecanthropus erectus* (*q.v.*), which is represented by the imperfect roof of a skull, two molars and a femur, discovered in a bed of volcanic ash in Java. The forehead is extremely low, with beetling brow-ridges, and the whole calvarium presents a curiously gibbon-like aspect. The capacity of the brain-case is estimated to have equalled two-thirds that of an average modern man. The creature is regarded as transitional between the higher apes, more especially the *Hylobatidae* and the lowest representatives of the genus *Homo*, such as the Neanderthal men. From the Lower Pliocene of India has been obtained the palate of a chimpanzee-like ape, which by some is referred to the existing *Anthropopithecus*, while by others it is considered to represent a genus by itself—*Palacopithecus*. The same formation has yielded the canine tooth of a large ape, apparently referable to the existing Asiatic genus *Simia*. From the Miocene of Europe has been described the genus *Dryopithecus*, typified by *D. fontani*, a generalized ape of the size of a chimpanzee, related, perhaps, both to the *Simiidae* and the *Hylobatidae*. The Lower Pliocene of Germany has yielded other remains referred to a distinct genus under the name of *Paidopithecus rhenanus*. From the Miocene of the Vienna basin Dr O. Abel has described certain ape-remains under the name of *Griphopithecus suessi*, as well as others regarded as representing a species of *Dryopithecus* with the name *D. darwini*. As regards the first, all that can be said is that it indicates a member of the group to which *Dryopithecus* belongs. It has been suggested that the latter genus is closely related to man, but this idea is discountenanced by the great relative length of the muzzle and the small space for the tongue. Teeth of another man-like ape from the Tertiary of Swabia, described under the pre-occupied name *Anthropodus*, have been re-named *Neopithecus*. The genus *Anthropodus* is represented by remains of an ape of doubtful position from the French Pliocene. *Pliopithecus*

from the French Miocene is certainly a gibbon, perhaps not distinguishable from *Hylobates*.

Orcopithecus, from the Miocene of Tuscany, is perhaps intermediate between gibbons and baboons (*Papio*), the latter of which, as well as *Macacus*, are represented in the Indian Pliocene. *Mesopithecus*, of the Grecian Lower Pliocene, presents some characters connecting it with *Semnopithecus* and others with *Macacus*. An allied type from the Lower Pliocene of France is *Dolichopithecus*, taking its name from the elongated skull; while *Macacus* occurs in the Upper Pliocene and Pleistocene of several parts of Europe. *Cryptopithecus*, from the Swiss Oligocene, appears to be the oldest known Old World monkey. From the Miocene of Patagonia are known certain monkeys described as *Homunculus*, *Anthropops*, &c., apparently more akin to the *Cebidae* but perhaps representing an extinct family.

Passing on to the lemurs, it may be mentioned in the first place that G. Grandidier has described an extinct lemur from the Tertiary of France, which he believes to be nearly related to the slow lorises, and has accordingly named *Pronycticebus gaudryi*. If the determination be correct the discovery is of interest as tending to link the modern faunas of southern India and West Africa (which possess many features in common) with the Tertiary fauna of Europe. Certain remarkable extinct lemuroids of large size have been discovered in the superficial deposits of Madagascar, in one of which (*Megaladapis*) the upper cheek-teeth are of a tritubercular type (fig. 23), while in the second and smaller form (*Nesopithecus*) the dentition makes a notable approximation to that of the *Cercopithecidae*. Each

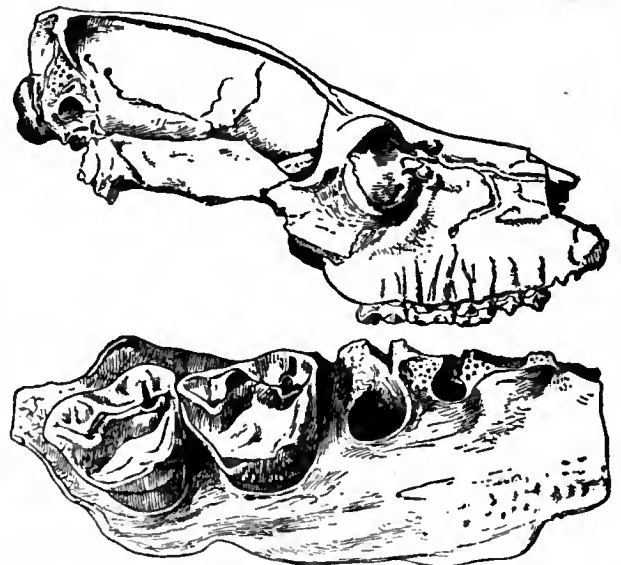

FIG. 23.—Skull and Hinder Right Upper Cheek-teeth of *Megaladapis madagascariensis*.

of these genera, which probably survived till a very late date, is generally regarded as typifying a family group. In *Megaladapis* the skull is distinguished by its elongation and the small size of the eye-sockets, the tritubercular upper molars presenting considerable resemblance to those of the living *Lepidolemur*. The brain is of a remarkably low type. In one species the approximate length of the skull is 250, and in the second 330 millimetres. Even more interesting are the two large species of *Nesopithecus*, one of which was at first described as *Globilemur*. They show a very complicated type of brain, and were at first regarded as indicating Malagasy representatives of the Anthropoidea. In regard to the character of the tympanic region of the skull this genus shows several features characteristic of the more typical Malagasy lemuroids; and the eye-sockets are open behind, while the dentition is numerically the same as in some of the latter. On the other hand, in several features *Nesopithecus* resembles the Anthropoidea; the upper incisors are not separated in the middle line, and the upper molars

present the pattern found in the *Cercopithecidae*, while in one species the lachrymal bone and foramen are within the orbit. The resemblances to apes are not confined to the skull, but are found in almost all the bones. Probably the genus may be regarded as a specialized lemuroid. The Oligocene and Eocene formations of Europe and North America have yielded remains of a number of primitive lemuroids, grouped together under the name of *Mesodonta* or *Pseudolemures*, and divided into families severally typified by the genera *Hyopsodus*, *Notharctus*, *Anaptomorphus* and *Microchoerus* (*Necrolemur*), of which the last two are European and the others American. To particularize the characteristics of the different families would occupy too much space, and only the following features of the group can be mentioned. The dental formula is $i. \frac{3}{1}, c. \frac{1}{1}, p. \frac{4}{2}$ or $\frac{3}{2}, m. \frac{3}{3}$. The canines are often large; the upper molars carry from three to six cusps, while the lower ones are of the tuberculo-sectorial type with either four or five cusps. The lachrymal foramen may be either within or without the orbit, which is in free communication with the temporal fossa, with or without a complete bony ring. The humerus has an entepicondylar foramen. It is specially noteworthy that *Adapis* resembles the *Lemuridae* in the form and relations of the tympanic ring. *Anaptomorphus* has large orbits and tritubercular molars. Certain Middle and Lower Eocene North American genera, such as *Mixodectes* and *Pelycodus*, together with the European *Plesiadapis* and *Protoadapis*, which have been regarded as lemuroids, are now frequently referred to the RODENTIA (*q.v.*). On the other hand, *Metachiromys*, of the Bridger Eocene of America, originally described as a relative of *Chiromys*, has been stated to be an armadillo.

LITERATURE.—The above article is based on the articles APE and LEMUR in the 9th edition of this encyclopaedia. The following are the chief works on the subject: H. O. Forbes, "A Handbook to the Primates," Allen's Naturalists' Library (2 vols., 1904); A. A. W. Hubrecht, "The Descent of the Primates" (New York, 1897); "Furchung und Keimblatt-bildung bei Tarsius spectrum," *Verh. Ac. Amsterdam* (1902); C. J. Forsyth Major, "Our Knowledge of Extinct Primates from Madagascar," *Geol. Magazine*, decade 7, vol. vii. (1900); "Skulls of Foetal Malagasy Lemurs," *Proc. Zool. Soc.* (London, 1899); "The Skull in Lemurs and Monkeys," *ibid.* (1904); H. Winge, "Jordfundne og nulevende Aber" (Primates), *E. Mus. Lundi* (1895); C. Earle, "On the Affinities of Tarsius," *American Naturalist* (1897); W. Leche, "Untersuchungen über das Zahnsystem lebender und fossiler Halbaffen," *Gegenbaurs Festschrift* (Leipzig, 1896); E. Dubois, "*Pithecanthropus erectus*, eine menschenähnliche Uebergangsform aus Java" (Batavia, 1894); A. Keith, "On the Chimpanzees and their relationship to the Gorilla," *Proc. Zool. Soc. London* (1899); W. Rothschild, "Notes on Anthropoid Apes," *ibid.* (1905); O. Schlaginhaufen, "Das Hautleistsystem der Primatenplanta," *Morphologisches Jahrbuch*, vols. iii. and xxxiv. (1905); G. E. Smith, "The Morphology of the Occipital Region of the Cerebral Hemisphere in Man and Apes," *Anatomischer Anzeiger*, vol. xxiv. (1904); H. F. Standing, "Primates from Madagascar," *Trans. Zool. Soc.*, 1908, 18, pp. 59-216. (R. L. *)

PRIME, PRIMER AND PRIMING. These three words are to be referred to Lat. *primus*, first, "prime," in O. Eng. *prim*, occurs first in the ecclesiastical sense of the Latin *prima hora*, the first hour, one of the lesser canonical hours of the Roman Church (see BREVIARY). Hence the word "primer" (Med. Lat. *primarius*), *i.e.* a book of hours. This was a book for the use of the laity and not strictly a service book. These books originally contained parts of the offices for the canonical hours, the penitential and other psalms, the Litany, devotional prayers and other matter. There were several "Primers" printed in the reign of Henry VIII.; the *King's Primer* of 1545 contained the Calendar, the Commandments, Creed, Lord's Prayer, the penitential psalms, Litany and prayers for special occasions. The primer of William Marshall, the printer and reformer, 1534, is entitled *The Prymer in Englyshe, with certeyn prayers and godly meditations, very necessary for all people that understande not the Latyne Tongue*. Later these primers contained the Catechism, graces before and after meals, and the A. B. C. They were published for children, like the earlier Sarum Primer (1537), and became educational in purpose, as reading books. The earlier primers were also used in this way, as is shown

by the "litel child" of Chaucer's *Prioress's Tale*, who sitting "at his prymer, redemptorie herde syngne." Thus "primer" or "primmer" became the regular name for an elementary book for learners. For the type known as "great primer" and "long primer," see TYPOGRAPHY.

Apart from the use of "prime" as the period of greatest vigour of life, the first of the guards in fencing, and for those numbers which have no divisors except themselves and unity (see ARITHMETIC), the principal use is that of the verb, in the sense of to insert in the pan of an old-fashioned small arm, the "primer," containing powder which, on explosion by percussion, fires the charge. This use seems to be due to "priming" being the first stage in the discharge of the weapon. Finally "priming" is the first coat of size or colour laid on a surface as a preparation for the body colour.

PRIME MINISTER, or **PREMIER**, in England, the first minister of the Crown. Until 1905 the office of prime minister was unknown to the law,¹ but by a royal warrant of the 2nd of December of that year the holder of the office, as such, was given precedence next after the archbishop of York. The prime minister is the medium of intercourse between the cabinet and the sovereign; he has to be cognizant of all matters of real importance that take place in the different departments so as to exercise a controlling influence in the cabinet; he is virtually responsible for the disposal of the entire patronage of the Crown; he selects his colleagues, and by his resignation of office dissolves the ministry. Yet he was until 1905, in theory at least, but the equal of the colleagues he appointed. The prime minister is nominated by the sovereign. "I offered," said Sir Robert Peel on his resignation of office, "no opinion as to the choice of a successor. That is almost the only act which is the personal act of the sovereign; it is for the sovereign to determine in whom her confidence shall be placed." Yet this selection by the Crown is practically limited. No prime minister could carry on the government of the country for any length of time who did not possess the confidence of the House of Commons. The prime minister has no salary as prime minister, but he usually holds the premiership in connexion with the first lordship of the treasury, the chancellorship of the exchequer, a secretaryship of state or the privy seal. Sir Robert Walpole must be regarded as the first prime minister—that is, a minister who imposed harmonious action upon his colleagues in the cabinet. This was brought about partly by the capacity of the man himself, partly by the lack of interest of George I. and II. in English home affairs. This creation, as it were, of a superior minister was so gradually and silently effected that it is difficult to realize its full importance. In previous ministries there was no prime minister except so far as one member of the administration dominated over his colleagues by the force of character and intelligence. In the reign of George III. even North and Addington were universally acknowledged by the title of prime minister, though they had little claim to the independence of action of a Walpole or a Pitt.

British Prime Ministers.

Sir R. Walpole	1721-1742	Earl of Shelburne	
John, Lord Carteret		(afterwards Mar-	
(afterwards Earl		quess of Lans-	
Granville)	1742-1744	downe)	1782-1783
Henry Pelham	1744-1754	Lord North (after-	
Duke of Newcastle	1754-1756	wards Earl of Guil-	
William Pitt and		ford)	1783
Duke of Newcastle	1756-1762	W. Pitt	1783-1801
Earl of Bute	1762-1763	H. Addington (after-	
George Grenville	1763-1765	wards Viscount	
Marquess of Rock-		Sidmouth)	1801-1804
ingham	1765-1766	W. Pitt	1804-1806
W. Pitt, Earl of		Lord Grenville	1806-1807
Chatham	1766-1767	Duke of Portland	1807-1809
Duke of Grafton	1767-1770	Spencer Perceval	1809-1812
Lord North	1770-1782	Earl of Liverpool	1812-1827
Marquess of Rock-		G. Canning	1827
ingham	1782		

¹ The first formal mention in a public document appears to be in 1878, where, in the opening clause of the treaty of Berlin, the earl of Beaconsfield is referred to as "First Lord of Her Majesty's Treasury, Prime Minister of England."

Viscount Goderich (afterwards Earl of Ripon)	1827-1828	B. Disraeli (after- wards Earl of Beaconsfield)	1868
Duke of Wellington	1828-1830	W. E. Gladstone	1868-1874
Earl Grey	1830-1834	B. Disraeli (Beacons- field)	1874-1880
Viscount Melbourne	1834	W. E. Gladstone	1880-1885
Sir R. Peel	1834-1835	Marquess of Salis- bury	1885-1886
Viscount Melbourne	1835-1841	W. E. Gladstone	1886
Sir R. Peel	1841-1846	Marquess of Salis- bury	1886-1892
Lord John Russell (afterwards Earl Russell)	1846-1852	W. E. Gladstone	1892-1894
Earl of Derby	1852	Earl of Rosebery	1894-1895
Earl of Aberdeen	1852-1855	Marquess of Salis- bury	1895-1902
Viscount Palmerston	1855-1858	A. J. Balfour	1902-1905
Earl of Derby	1858-1859	Sir H. Campbell- Bannerman	1905-1908
Viscount Palmerston	1859-1865	H. H. Asquith	1908-
Earl Russell	1865-1866		
Earl of Derby	1866-1868		

PRIMERO (Span. first), a card game of Spanish origin, which Strutt calls "the oldest game of cards played in England." It is described as having a close resemblance to *Ombre* (*q.v.*), by which it had been superseded. In both games the spadillo or ace of spades was the best card, but Primero was played with six cards and *Ombre* with nine. The exact method of play is uncertain.

PRIME VERTICAL, in astronomy, the vertical circle passing east and west through the zenith, and intersecting the horizon in its east and west points (see **ASTRONOMY**).

PRIMITIVE METHODIST CHURCH, THE, a community of nonconformists, which owes its origin to the fact that Methodism as founded by the Wesleys tended, after the first generation, to depart from the enthusiasm that had marked its inception and to settle down to the task of self-organization. There were, however, some ardent spirits who continued to work along the old lines and whose watchword was revivalism, and out of their efforts came the Bible Christian, the Independent Methodist and the Primitive Methodist denominations. These enthusiastic evangelists esteemed zeal a higher virtue than discipline and decorum, and put small emphasis on church systems as compared with conversions. One of the men to whom Primitive Methodism owes its existence was Hugh Bourne (1772-1852), a millwright of Stoke-upon-Trent. He joined a Methodist society at Burslem, but business taking him at the close of 1800 to the colliery district of Harsisehead and Kidsgrove, he was so impressed by the prevailing ignorance and debasement that he began a religious revival of the district. His open-air preaching was accompanied by prayer and singing, a departure from Wesley's practice and the forerunner of the well-known "Camp Meeting." A chapel was built at Harsisehead, and a second revival occurred in September 1804, largely the result of a meeting held at Congleton by some enthusiasts from Southport. One of the after-fruits of this revival was the conversion (Jan. 1805) of the joint founder of Primitive Methodism, William Clowes (1780-1851), a native of Burslem, who had come to Tunstall. Clowes was a man of fine appearance and open disposition, with a compelling personality that found expression in a steady glance and a thrilling voice. He was a potter by trade, and had a national reputation as a dancer. He joined a Methodist class, threw his house open for love-feasts and prayer-meetings, and did a great deal of itinerant evangelization among the cottages of the countryside. Lorenzo Dow (1777-1834), an eccentric American Methodist revivalist, visited North Staffordshire and spoke of the camp-meetings held in America, with the result that on the 31st of May 1807 the first real English gathering of the kind was held on Mow Cop, since regarded as the Mecca of Primitive Methodism. It lasted from 6 a.m. to 8 p.m., and Bourne and his friends determined to continue the experiment as a counterblast to the parish wakes of the time, which were little better than local saturnalia. Opposition from a master potter of the district, who threatened to put the Conventicle Act in force, was overcome, but more serious difficulties were presented by the antagonism of the Wesleyan Methodist circuit authorities. But Bourne and his friends persisted against both Conference and the local super-

intendent, who issued bills declaring that no camp-meeting would be held at Norton in August 1807. The meeting was held and ten months later Bourne was expelled by the Burslem Quarterly Meeting, ostensibly for non-attendance at class (he had been away from home, evangelizing), really, as the Wesleyan superintendent told him "because you have a tendency to set up other than the ordinary worship" which was precisely the reason why, fifty years earlier, the Anglican Church had declined to sanction the methods of John Wesley. The camp-meetings went steadily on, and their influence is reflected in the writings of George Eliot, George Borrow and William Howitt. The societies which Bourne formed were for a time allowed to go under (Wesleyan) Methodist protection, but the crisis came in 1810, when the Stanley class of ten members declined to wash their hands of the Camp-Meeting Methodists, and so were refused admission. About this time, too (1809), Bourne appointed James Crawfoot, a Wesleyan local preacher who had been removed from the list for assisting the Independent Methodists, as a travelling preacher at 10s. a week, instructing him to give his whole time to evangelization and to get his converts to join the denominations to which they were most inclined. Clowes, who, in spite of his revivalist sympathies, was more attached to Methodism than Bourne, was cut off from his church for taking part in camp-meetings at Ramsor in 1808 and 1810. His personality drew a number of strong men after him, and a society meeting held in a kitchen and then in a warehouse became the nucleus of a circuit, a chapel being built at Tunstall in July 1811, two months after the fusion of the Bourne and Clowes forces. Clowes, like Crawfoot, was set apart as a preacher to "live by the gospel," and in February 1812 the name "Primitive Methodist" was formally adopted, although for nearly a generation the name "Clowesites" survived in local use.

The first distinct period in the history of Primitive Methodism proper is 1811-1843. It was a time of rapid expansion, marked by great missionary fervour, and may be called the Circuit Period, for even after the circuits were grouped into districts in 1821 they did not lose their privilege of missionary initiative. The line of geographical progress first followed the valley of the Trent. The original circuit at Tunstall no sooner felt its feet than it favoured consolidation rather than extension. But irrepressibles like John Benton broke through the "non-mission law," and pressed forward through the "Adam Bede" country to Derby (which became the 2nd circuit in 1816); Nottingham, where a great camp-meeting on Whit Sunday 1816 was attended by 12,000 people; Leicestershire, where Loughborough became the 3rd circuit, with extensions into Rutland, Lincolnshire and Norfolk; and ultimately to Hull, which became the 4th circuit, and where a meeting which deserves to be called the First Conference was held in June 1819. The Hull circuit during the next five years, through its Yorkshire, Western, North-Western and Northern Missions, carried on a vigorous campaign with great success, especially among the then semi-savage colliers of Durham and Northumberland. During the five years 1819-1824 there had been made from Hull 17 circuits with a membership of 7600, and Hull itself had 3700 more.

Simultaneously with this work in the north, Tunstall circuit, having thrown off its lethargy at the Wrine Hill camp-meeting on the 23rd of May 1819, was carrying on an aggressive evangelism. In the Black Country, Darlaston circuit was formed in 1820, and John Wedgewood's Cheshire Mission, begun in 1819, led to work in Liverpool on the one hand and in Salop on the other. From Macclesfield a descent was made on Manchester; from Oakengates in South Shropshire came extensions to Herefordshire, Glamorganshire and Wiltshire, where the famous Brinkworth circuit was established. The succeeding years, however, 1825-1828, showed a serious set-back, due to the lack of discipline. But drastic measures were taken, and in one year thirty preachers were struck off the list. Thenceforward, while the Oxford Movement was awakening one section of the people of England the Primitive Methodists were making themselves felt among other classes of the population. John Oxtoby, who evangelized Filey and became known as "Praying Johnny,"

was known to spend six hours at a time in intercession. Robert Key at Saham Tony in 1832 won over a young woman who converted her brother, Robert Eaglen, who, eighteen years later at Colchester, proved so decisive a factor in the life of Charles Haddon Spurgeon.

The Times of the 27th of December 1830, referring to the disaffected state of the southern counties, said: "The present population must be provided for in body and spirit on more liberal and Christian principles, or the whole mass of labourers will start into legions of banditti—banditti less criminal than those who have made them so, and who by a just and fearful retribution will soon become their victims." These were the classes the Primitive Methodists tried to reach, and in doing so they found themselves between two fires. On the one hand there was the mob violence that often amounted to sheer ruffianism, especially in Wessex and the home-counties. On the other hand there was legal persecution all over the country, and the preachers suffered many things from the hands of rural clergy and county magistrates. There are a score of cases of serious imprisonment, and a countless number of arrests and temporary detention. Local preachers received notice to quit their holdings, labourers were discharged, those who opened their cottages for meetings were evicted, and to show any hospitality to a travelling preacher was to risk the loss of home and employment. But the spirit of the evangelists was unquenchable.

At the Conference of 1842 both Clowes and Bourne became supernumeraries with a pension of £25 a year each. Clowes, indeed, had been free from circuit work since 1827, and he continued to pray and preach as he was able till his death in March 1851. Bourne, who worked at his trade more or less all through life, spent his last ten years in advocating the temperance cause; he died in October 1852. The years 1842–1853 mark a transition period in the history of Primitive Methodism. It was John Flesher who chiefly guided the movement from a loosely jointed Home Missionary Organization on to the lines of a real Connexionism. One of the first steps was to move the Book Room and the meeting place of the executive committee from Bemersley to London. Soon after came the gradual process by which the circuits handed over their mission-work to a central Connexional Committee. The removal to London was proof that the leaders were alive to the necessity of grappling with the rapid growth of towns and cities, and that the Connexion, at first mainly a rural movement, had also urban work to accomplish. The famous Hull circuit long retained a number of powerful branches, a survival of the first period, but by 1853 it had come into line with what was by that time regarded as the normal organization.

The period 1853–1885 (where typical names are W. and S. Antliff, Thomas Bateman and Henry Hodge) finds Primitive Methodism as a connexion of federated districts, a unity which may be described as mechanical rather than organic. The districts between 1853 and 1873 were ten in number, Tunstall, Nottingham, Hull, Sunderland, Norwich, Manchester, Brinkworth, Leeds, Bristol and London. Conference—the supreme assembly—was a very jealously guarded preserve, being attainable only to preachers who had travelled 18 and superintended 12 years, and to laymen who had been members 12 and officials 10 years. This exclusiveness naturally strengthened the popularity and power of the districts, where energy and talent found a scope elsewhere denied. Thus Hull district inaugurated a bold policy of chapel-buildings; Norwich that of a foreign mission; Sunderland and Manchester the ideal of a better-educated ministry, Sunderland institute being opened in 1868; Nottingham district founded a middle-class school; Leeds promoted a union of Sunday-schools, and the placing of chapel property on a better financial footing. The period as a whole had some anxious moments; emigration to the gold-fields and the strife which afflicted Wesleyan Methodism brought loss and confusion between 1853 and 1860. Yet when Conference met at Tunstall in the latter year to celebrate its jubilee it could report 675 ministers and 11,384 local preachers, 132,114 members,

2267 chapels, 167,533 scholars and 30,988 teachers. Over-seas, too, there was much activity and success. Work begun in Australia and New Zealand prospered, and the former country finally contributed over 11,000 members to the formation of the United Methodist Church of Australia, New Zealand with its 2600 members preferring to remain connected with the home country. In the United States there had been a quiet but steady growth since the first agents went out in 1829 and Hugh Bourne's advisory visit in 1844. There are now three Conferences—the Eastern, Pennsylvania and Western, with about 70 ministers, 100 churches and 7000 members. The Canadian churches had a good record, consummated in 1884 when they contributed 8000 members and 100 ministers to the United Methodist Church of the Dominion. In January 1870 the first piece of real foreign missionary work was begun at Fernando Po, followed in December of the same year by the mission at Aliwal North on the Orange River in South Africa. This station is the centre of a polyglot circuit or district 150 m. by 50 m., and there is a membership of 1731 and an efficient institution for training teachers, evangelists and artisans. In 1899 another South African mission was started, ultimately locating itself at Mashukulumbwe, and a few years later work was begun in Southern Nigeria.

Since 1885 Primitive Methodism has been developing from a "Connexion" into a "Church," the designation employed since 1902. At home a Union for Social Service was formed in 1906, the natural outcome of Thomas Jackson's efforts for the hungry and distressed in Clapton and Whitechapel, and of similar work at St George's Hall, Southwark. Other significant episodes have been the Unification of the Funds, the Equalization of Districts and the reconstruction of Conference on a broader basis, the Ministers' Sustentation Fund and the Church Extension Fund, and the enlargement and reorganization of the college at Manchester. This undertaking owes much to the liberality of Sir William P. Hartley, whose name the college, which is a school of the Victoria University, now bears. The Christian Endeavour movement in Great Britain derives, perhaps, its greatest force from its Primitive Methodist members; and the appointment of central missions, connexional evangelists and mission-vans, which tour the more sparsely populated rural districts, witness to a continuance of the original spirit of the denomination, while the more cultured side is fostered by the Hartley lecture. In celebration of the centenary of the Church, a fund of £250,000 was launched in 1907, and this was brought to a successful issue. Statistics for 1909 show 1178 ministers, 16,158 local preachers, 212,168 members, 4484 chapels, 465,531 Sunday scholars, 59,557 teachers. In the United States there were, in 1906, 101 church edifices and a total membership of 7558.

See H. B. Kendall, *The Origin and History of the Primitive Methodist Church* (2 vols., 1906); and *What hath God Wrought? A Centenary Memorial of the P.M. Church* (1908). (A. J. G.)

PRIMOGENITURE (Lat. *primus*, first, and *genitus*, born, from *gignere*, to bring forth), a term used to signify the preference in inheritance which is given by law, custom or usage, to the eldest son and his issue, or in exceptional cases to the line of the eldest daughter. The practice is almost entirely confined to the United Kingdom, having been abolished by the various civil codes of the European states, and having been rejected in the United States as contrary to the spirit of the constitution. The history of primogeniture is given in the article SUCCESSION, while the existing English law will be found in the articles HEIR; INHERITANCE; WILL, &c. But it may be briefly said here that the English law provided that in ordinary cases of inheritance to land of intestates the rule of primogeniture shall prevail among the male children of the person from whom descent is to be traced, but not among the females; and this principle is applied throughout all the degrees of relationship. There are exceptions to this rule, as in the cases of "gavelkind" and "borough-English," and in the copyhold lands of a great number of manors, where customs analogous to those of gavelkind and borough-English have existed from time immemorial. In another class of exceptions the rule of primogeniture is applied

to the inheritance of females, who usually take equal shares in each degree. The necessity for a sole succession has, for example, introduced succession by primogeniture among females in the case of the inheritance of the Crown, and a similar necessity led to the maxim of the feudal law that certain dignities and offices, castles acquired for the defence of the realm, and other inheritances under "the law of the sword," should not be divided, but should go to the eldest of the co-heiresses (Bracton, *De Legibus*, ii. c. 76; Co. Litt., 165a). There are also many other special customs by which the ordinary rule of primogeniture is varied. It may be remarked that the English law of inheritance of land creates a double preference, subject to certain exceptions and customs, in favour of the male over the female and of the first-born among the males. This necessitates the rule of representation by which the issue of children are regarded as standing in the places of their parents, called "representative primogeniture." The rule appears to have been firmly established in England during the reign of Henry III., though its application was favoured as early as the 12th century throughout the numerous contests between brothers claiming by proximity of blood and their nephews claiming by representation, as in the case of King John and his nephew Prince Arthur (Glanvill, vii. c. 3; Bracton, *De Legibus*, ii. c. 30).

See Pollock and Maitland, *History of English Law*; K. E. Digby, *History of the Law of Real Property*; Sir H. Maine, *Ancient Law and Early History of Institutions*; C. S. Kenny, *Law of Primogeniture in England*.

PRIMROSE.¹ The genus *Primula* contains numerous species distributed throughout the cooler parts of Europe and Asia, and found also on the mountains of Abyssinia and Java; a few are American. They are herbaceous perennials, with a permanent stock from which are emitted tufts of leaves and flower-stems which die down in winter; the new growths formed in autumn remains in a bud-like condition ready to develop in spring. They form the typical genus of Primulaceae (*q.v.*), the floral conformation of which is very interesting on several accounts independently of the beauty of the flowers. The variation in the length of the stamens and of the style in the flowers of *Primula* has attracted much attention since Charles Darwin pointed out the true significance of these varied arrangements. Briefly it may be said that some of the flowers have short stamens and a long style, while others have long stamens, or stamens inserted so high up that the anthers protrude beyond the corolla tube, and a short style. Gardeners and florists had for centuries been familiar with these variations, calling the flowers from which the anthers protruded "thrum-eyed" and those in which the stigma appeared in the mouth of the tube "pin-eyed." Darwin showed by experiment that the most perfect degree of fertility, as shown by the greatest number of seeds and the healthiest seedlings, was attained when the pollen from a short-stamened flower was transferred to the stigma of a short-styled flower, or when the pollen from the long stamens was applied to the long style. As in any given flower the stamens are short (or low down in the flower-tube) and the style long, or conversely, it follows that to ensure a high degree of fertility cross fertilization must occur, and this is effected by the transfer of the pollen from one flower to another by insects. Incomplete fertility arises when the stigma is impregnated by the pollen from the same flower. The size of the pollen-grains and the texture of the stigma are different in the two forms of flower (see figure under PRIMULACEAE). The discovery of the physiological significance of these variations in structure, which had long been noticed, was made by Darwin, and formed the first of a series of similar observations and experiments by himself and subsequent observers (see Darwin, *Different Forms of Flowers*, &c.). Among British species may be mentioned the Common Primrose (*P. vulgaris*); the cowslip (*P. veris*); the true Oxlip (*P. elatior*), a rare plant only found in the eastern counties; and the common

oxlip, the flowers of which recall those of the common primrose, but are provided with a supporting stem, as in the cowslip; it is, in fact, a hybrid between the cowslip and the primrose. In addition to these two other species occur in Britain, namely, *P. farinosa*, found in Wales, the north of England and southern Scotland, and *P. scotica*, which occurs in Orkney and Caithness. These two species are found also in high Arctic latitudes, and *P. farinosa*, or a very closely allied form, exists in Fuegia.

The *Auricula* (*q.v.*) of the gardens is derived from *P. Auricula*, a yellow-flowered species, a native of the Swiss mountains. The *Polyanthus* (*q.v.*), a well-known garden race, is probably derived from a cross between the primrose and cowslip. The Himalayas are rich in species of primrose, often very difficult of determination or limitation, certain forms being peculiar to particular valleys. Of these *P. denticulata*, *Stuartii*, *sikkimensis*, *nivalis*, *floribunda*, may be mentioned as frequently cultivated, as well as the lovely rose-coloured species *P. rosea*.

The Royal Cowslip (*P. imperialis*) resembles *P. japonica*, but has leaves measuring 18 in. long by 5 in. wide. It grows at an elevation of 9000 ft. in Java, and has deep yellow or orange flowers.

The primrose is to be had in cultivation in a considerable variety of shades of colour, ranging from the palest yellow to deep crimson and blue. As the varieties do not reproduce quite true from seed, it is necessary to increase special kinds by division. The primrose is at its best in heavy soils in slight shade, and with plenty of moisture during the summer.

One of the most popular of winter and early spring decorative plants is the Chinese primrose, *Primula sinensis*, of which some superb strains have been obtained. For ordinary purposes young plants are raised annually from seeds, sown about the beginning of March, and again for succession in April and, if needed, in May. The seed should be sown in well-drained pots or pans, in a compost of three parts light loam, one part well-rotted leaf-mould, and one part clean gritty sand, as it does not germinate freely if the soil contains stagnant moisture, afterwards placing a sheet of glass over the pans to prevent evaporation of moisture. When the seeds germinate, remove the glass and place the pans in a well-lighted position near the glass, shading them from the sun with thin white paper, and giving water moderately as required. When the seedlings are large enough to handle, prick them out in pans or shallow boxes, and, as soon as they have made leaves an inch long, pot them singly in 3-in. pots, using in the soil a little rotten dung. They should then be placed in a light frame near the glass in an open situation, facing the north. When their pots are filled with roots they should be moved into 6-in. or 7-in. pots. The soil should now consist of three parts good loam broken with the hand, one part rotten dung and leaf-mould, and as much sand as will keep the whole open. They should be potted firmly, and kept in frames close up to the glass till September, excess in watering being carefully avoided. In the autumn they should be transferred to a light house and placed near the glass, the atmosphere being kept dry by the occasional use of fire-heat. The night temperature should be kept about 45°. When the flowering stems are growing up, manure water once or twice a week will be beneficial. The semi-double varieties are increased from seeds, but the fully-double ones, and any particular sort, can only be increased by cuttings. *Primula japonica*, a bold-growing and very beautiful Japanese plant, is hardy in sheltered positions in England. *P. cortusoides*, var. *Sieboldii* (Japan), of which there are many lovely forms, is suitable for outdoor culture and under glass. There are several small-growing hardy species which should be accommodated on the best positions on rockeries where they are secure from excessive dampness during winter; excess of moisture at that season is the worst enemy of the choice Alpine varieties. They are propagated by seed and by division of the crowns after flowering. *P. Forrestii* is a quite new orange-yellow flowered species from China; as is also *P. Bulleyi*. They are probably hardy—at least in favoured spots.

Evening primrose belongs to the genus *Oenothera* (natural order Onagraceae), natives of temperate North and South America. The common evening primrose, *Oe. biennis*, has become naturalized in Britain and elsewhere in Europe; the form or species known as var. *grandiflora* or *Oe. Lamarckiana* is a very showy plant with larger flowers than in the common form. Other species known in gardens are *Oe. missouriensis* (*macrocarpa*), 6 to 12 in., which has stout trailing branches, lance-shaped leaves and large yellow blossoms; *Oe. taraxacifolia*, 6 to 12 in., which has a stout crown from which the trailing branches spring out, and these bear very large white flowers changing to delicate rose; this perishes in cold soils, and should therefore be raised from seed annually. Of erect habit are *Oe. speciosa*, 1 to 2 ft., with large white flowers; *Oe. fruticosa*, 2 to 3 ft., with abundant yellow flowers.

The name of Cape Primrose has been given by some to the hybrid forms of *Streptocarpus*, a South African genus belonging to the natural order Gesneraceae.

¹ Lat. *primula*; Ital. and Span. *primavera*; Fr. *primevère*, or in some provinces *primerole*. Strangely enough, the word was applied, according to Dr Prior, in the middle ages to the daisy (*Bellis perennis*), the present usage being of comparatively recent origin.

PRIMROSE LEAGUE, THE, an organization for spreading Conservative principles amongst the British democracy. The primrose is associated with the name of Lord Beaconsfield (*q.v.*), as being preferred by him to other flowers. On a card affixed to the wreath of primroses sent by Queen Victoria to be placed upon his coffin was written in Her Majesty's own handwriting: "His favourite flowers: from Osborne: a tribute of affectionate regard from Queen Victoria." On the day of the unveiling of Lord Beaconsfield's statue all the members of the Conservative party in the House of Commons were decorated with the primrose. A small group had for some time discussed the means for obtaining for Conservative principles the support of the people. Sir H. D. Wolff therefore said to Lord Randolph Churchill, "Let us found a primrose league." The idea was accepted by several gentlemen in the habit of working together, and a meeting was held at the Carlton Club shortly afterwards, consisting Lord Randolph Churchill, Sir H. Drummond Wolff, Mr (afterwards Sir John) Gorst, Mr Percy Mitford, Colonel Fred Burnaby and some others, to whom were subsequently added Mr Satchell Hopkins, Mr J. B. Stone, Mr Rowlands and some Birmingham supporters of Colonel Fred Burnaby, who also wished to return Lord Randolph Churchill as a Conservative member for that city. These gentlemen were of great service in remodelling the original statutes first drawn up by Sir H. Drummond Wolff. The latter had for some years perceived the influence exercised in benefit societies by badges and titular appellations, and he further endeavoured to devise some quaint phraseology which would be attractive to the working classes. The title of Knight Harbinger was taken from an office no longer existing in the Royal Household, and a regular gradation was instituted for the honorific titles and decorations assigned to members. This idea, though at first ridiculed, has been greatly developed since the foundation of the order; and new distinctions and decorations have been founded, also contributing to the attractions of the league. The League was partially copied from the organization of the Orange Society in Ireland. In lieu of calling the different subsidiary associations by the ordinary term "Lodges," the name was given of "Habitations," which could be constituted with thirteen members. These were intended as a substitute for the paid canvassers, about to be abolished by Mr Gladstone's Reform Bill. The principles of the League are best explained in the declaration which every member is asked to sign: "I declare on my honour and faith that I will devote my best ability to the maintenance of religion, of the estates of the realm, and of the imperial ascendancy of the British Empire; and that, consistently with my allegiance to the sovereign of these realms, I will promote with discretion and fidelity the above objects, being those of the Primrose League." The motto was "Imperium et libertas"; the seal, three primroses; and the badge, a monogram containing the letters PL, surrounded by primroses. Many other badges and various articles of jewellery have since been designed, with this flower as an emblem.

A small office was first taken on a second floor in Essex Street, Strand; but this had soon to be abandoned, as the dimensions of the League rapidly increased. Ladies were generally included in the first organization of the League, but subsequently a separate Ladies' Branch and Grand Council were formed. The founder of the Ladies' Grand Council was Lady Borthwick (afterwards Lady Glenesk), and the first meeting of the committee took place at her house in Piccadilly on the 2nd of March 1885. The ladies who formed the first committee were: Lady Borthwick, the dowager-duchess of Marlborough (first lady president), Lady Wimborne, Lady Randolph Churchill, Lady Charles Beresford, the dowager-marchioness of Waterford, Julia marchioness of Tweeddale, Julia countess of Jersey, Mrs (subsequently Lady) Hardman, Lady Dorothy Nevill, the Honourable Lady Campbell (later Lady Blythswood), the Honourable Mrs Armitage, Mrs Bischoffsheim, Miss Meresia Nevill (the first secretary of the Ladies' Council).

When the League had become a success, it was joined by Lord Salisbury and Sir Stafford Northcote, who were elected Grand

Masters. Its numbers gradually increased to a marvellous extent, as may be seen by the following figures:—

Year.	Knights.	Dames.	Associates.	Total.	Habitations.
1884	747	153	57	957	46
1885	8071	1381	1914	11,366	169
1886	32,645	23,381	181,257	237,283	1200
1887	50,258	39,215	476,388	565,861	1724
1888	54,580	42,791	575,235	672,606	1877
1889	58,180	46,216	705,832	810,228	1986
1890	60,795	48,796	801,261	910,852	2081
1891	63,251	50,973	887,068	1,001,292	2143
1901	75,260	64,906	1,416,473	1,556,639	2392
1910	87,235	80,038	1,885,746	2,053,019	2645

See an article in the *Albemarle* of January 1892, written by Miss Meresia Nevill; and the *Primrose League Manual*, published at the offices at Westminster. The latter publication is interesting as a history of the organization. (H. D. W.)

PRIMULACEAE, in botany, an order of Gamopetalous Dicotyledons belonging to the series Primulales and containing 28 genera with about 350 species. It is cosmopolitan in distribution, but the majority of the species are confined to the temperate and colder parts of the northern hemisphere and many are arctic or alpine. Eight genera are represented in the British flora. The plants are herbs, sometimes annual as in pimpernel (*Anagallis arvensis*) (fig. 1), but generally perennial as in *Primula*,



(After Wossido. From Strasburger's *Lehrbuch der Botanik*, by permission of Gustav Fischer.)

FIG. 1.—*Anagallis arvensis* (pimpernel).
 1, Flowering branch. 3, Capsule.
 2, A flower cut through longitudinally, showing the central placenta. 4, Seed.
 2, 3, 4, Enlarged.

where the plant persists by means of a sympodial rhizome, or in *Cyclamen* by means of a tuber formed from the swollen hypocotyl. The leaves form a radical rosette as in *Primula* (primrose, cowslip, &c.), or there is a well-developed aerial stem which is erect, as in species of *Lysimachia*, or creeping, as in *Lysimachia Nummularia* (creeping jenny or money-wort). *Hottonia* (water violet) is a floating water plant with submerged leaves cut into fine linear segments. The leaves are generally simple, often with a toothed margin; their arrangement is alternate, opposite or whorled, all three forms occurring in one and the same genus *Lysimachia*. The flowers are solitary in the leaf-axils as in pimpernel, money-wort, &c., or umbelled as in primrose, where the umbel is sessile, and cowslip, where it is stalked, or in racemes or spikes as in species of *Lysimachia*. Each flower is subtended by a bract, but there are no bracteoles, and corresponding with the absence of the latter the two first developed sepals stand right and left (fig. 2).

The flowers are hermaphrodite and regular with parts in fives (pentamerous) throughout, though exceptions from the pentamerous arrangement occur. The sepals are leafy and persistent; the corolla is generally divided into a longer or shorter tube and a limb which is spreading, as in primrose, or reflexed, as in *Cyclamen*; in *Soldanella* it is bell-shaped; in *Lysimachia* the tube is often very short, the petals appearing almost free; in *Glauca* the petals are absent. The five stamens spring from the corolla-tube and are

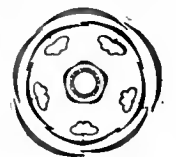

FIG. 2.
 Diagram of a typical flower of Primulaceae.

opposite to its lobes; this anomalous position is generally explained by assuming that an outer whorl of stamens opposite the sepals has disappeared, though sometimes represented by scales as in *Samolus* and *Soldanella*. Another explanation is based on the late appearance of the petals in the floral development and their origin from the backs of the primordia of the stamens; it is then assumed that three alternating whorls only are present, namely, sepals, stamens bearing petal-like dorsal outgrowths, and carpels. The superior ovary—half-inferior in *Samolus*—bears a simple style ending in a capitate entire stigma, and contains a free-central placenta bearing generally a large number of ovules, which are exceptional in the group Gamopetalae in having two integuments. The fruit is a capsule dehiscing by 5 sometimes 10 teeth or valves, or sometimes transversely (a pyxidium) as in *Anagallis*.

Cross pollination is often favoured by dimorphism of the flower, as shown in species of *Primula* (fig. 3). The two forms have long and short styles respectively, the stamens occupying corresponding positions half-way down or at the mouth of the corolla-tube; the long-styled flowers have smaller pollen-grains, which correspond with smaller stigmatic papillae on the short styles.

The order is divided into five tribes by characters based on differences in position of the ovules—which are generally semi-anatropous so that the seed is peltate with the hilum in the centre on one side (or ventral), but sometimes, as in *Hottonia* and



(From Strasburger's *Lehrbuch der Botanik*.)

FIG. 3.—*Primula sinensis*.

- L, Long-styled flowers. P, Pollen grains, and N, stigmatic papillae of long-styled form.
 K, Short-styled flowers. p, n, Ditto of short-styled form.
 G, Style. S, Anthers. (P, N, p, n, X 110.)

Samolus, anatropous with the hilum basal—together with the method of dehiscence of the capsule and the relative position of the ovary. The chief British genera are *Primula*, including *P. vulgaris*, primrose, *P. veris*, cowslip, *P. elatior*, oxlip, and the small alpine species *P. farinosa*, with mealy leaves; *Lysimachia*, loose strife, including *L. Nummularia*, money-wort; *Anagallis*, pimpernel; and *Hottonia*, water violet.

PRIMULINE, a dye-stuff containing the thiazole ring system conjointly with a benzene ring. The primulines are to be considered as derivatives of dehydrothiolumidine (aminobenzyltoluylmercaptan), which is obtained when para-tolui-

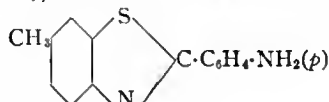

Primuline.

dine is heated with sulphur for eighteen hours at 180–190° C. and then for a further six hours at 200–220° C. (P. Jacobson, *Ber.*, 1889, 22, p. 333; L. Gattermann, *ibid.* p. 1084). Dehydrothiolumidine is not itself a dye-stuff, but if the heating be carried out at a higher temperature in the presence of more sulphur, then a base is formed, which gives primuline-yellow on sulphonation (A. G. Green, *Journ. Soc. Chem. Ind.*, 1888, 1, p. 194). Primuline-yellow is a mixture of sodium salts and probably contains in the molecule at least three thiazole rings

in combination. It is a substantive cotton dye of rather fugitive shade, but can be diazotized on the fibre and then developed with other components, so yielding a series of ingrain colours.

Thioflavine T is obtained by the methylation of dehydrothiolumidine with methyl alcohol in the presence of hydrochloric acid [German Patent 51738 (1888)]. Thioflavine S results from the methylation of dehydrothiolumidine sulphonic acid. This sulphonic acid on oxidation with bleaching powder or with lead peroxide, in alkaline solution yields *chloramine yellow*, which dyes cotton a beautiful yellow.

PRIMUS, MARCUS ANTONIUS, Roman general, was born at Tolosa in Gaul about A.D. 30–35. During the reign of Nero he was resident in Rome and a member of the senate, from which he was expelled for forgery in connexion with a will and was banished from the city. He was subsequently reinstated by Galba, and placed in command of the 7th legion in Pannonia. During the civil war he was one of Vespasian's strongest supporters. Advancing into Italy, he gained a decisive victory over the Vitellians at Bedriacum (or Betricum) in October 69, and on the same day stormed and set fire to Cremona. He then crossed the Apennines, and made his way to Rome, into which he forced an entrance after considerable opposition. Vitellius was seized and put to death. For a few days Primus was virtually ruler of Rome, and the senate bestowed upon him the rank and insignia of a consul. But on the arrival of Licinius Mucianus he was not only obliged to surrender his authority, but was treated with such ignominy that he left Rome. Primus must have been alive during the reign of Domitian, since four epigrams of Martial are addressed to him. Tacitus describes him as brave in action, ready of speech, clever at bringing others into odium, powerful in times of civil war and rebellion, greedy, extravagant, in peace a bad citizen, in war an ally not to be despised.

See Tacitus, *Histories*, ii., iii., iv.; Dio Cassius lxx. 9–21.

PRINA, GIUSEPPE (1768–1814), Italian statesman. He gave early proofs of rare talent, and after studying at the university of Pavia he passed as doctor of law in 1789. He was a firm adherent of Napoleon Bonaparte, and when Eugène Beauharnais became viceroy of Italy, was appointed minister of finance. Genial in private life, he was harsh and unyielding in his official capacity, and his singular skill in devising fresh taxes to meet the enormous demands of Napoleon's government made him the best-hated man in Lombardy, the more so that, being a Piedmontese, he was regarded as a foreigner. The news of the emperor's forced abdication on the 11th of April 1814 reached Milan on the 16th, and roused hopes of independence. The senate assembled on the 19th and Prina's party moved that delegates should be despatched to Vienna to request that Eugène Beauharnais should be raised to the throne of a free Italian kingdom. In spite of precautions this fact became public and provoked the formidable riot styled "The battle of the umbrellas" that broke out the next day. A furious mob burst into the senate, pillaged its halls and sought everywhere for the execrated Prina. Not finding him there, the rioters rushed to his house, which they wrecked, and seizing the doomed minister, who was discovered in a remote chamber donning a disguise, during four hours dragged him about the town, until wounded, mutilated, almost torn to pieces, he received his death-blow. The mob then insulted his miserable remains, stuffing stamped-paper into his mouth. These horrors were enacted by day, in a thoroughfare crowded with "respectable" citizens sheltered from the rain by umbrellas. The authorities were passive, and although some courageous persons actually rescued the victim at an early stage and concealed him in a friendly house, the blood-thirsty mob soon discovered his refuge and were about to force an entrance, when the dying man surrendered to save his deliverer's property. The riots directly contributed to the re-establishment of Austrian rule in Milan.

See M. Fabi, *Milano ed il ministro Prina* (Novara, 1860); F. Lemmi, *La Restaurazione austriaca a Milano nel 1814* (Bologna,

1902); Ugo Foscolo, *Alcune parole intorno alla fine del regno d'Italia*. The story of the murder of Prina forms the subject of a play by G. Rovetta, entitled *Principio di secolo*.

PRINCE (Lat. *princeps*, from *primus capio*, "I am the first to take"; Ital. *principe*, Fr. *prince*), a title implying either political power or social rank. The Latin word *princeps* originally signified "the first" either in place or action (cf. Ger. *Fürst*; O.H.G. *foristo* = English "first"). As an honorary title it was applied in the Roman republic to the *princeps senatus*, i.e. the senator who stood first on the censor's list, and the *princeps juventutis*, i.e. the first on the roll of the equestrian order. The assumption of the style of *princeps senatus* by Augustus (q.v.) first associated the word with the idea of sovereignty and dominion, but throughout the period of the empire it is still used as a title of certain civil or military officials (e.g. *princeps officii*, for the chief official of a provincial governor, in the Theodosian code, leg. I., *De offic. rect. prov.* i. 7; *princeps militiae*, i.e. the commander of a cohort or legion); while in the middle ages the term is still applied vaguely in charters to the magnates of the state or the high officials of the palace, *principes* being treated as the equivalent of *proceres*, *optimates* or *seniores*. Yet the idea of sovereignty as implied in the word *princeps*, used as a title rather than as a designation, survived strongly. In the Visigothic and Lombard codes *princeps* is the equivalent of *rex* or *imperator*; and when, after the overthrow of the Lombard kingdom by the Franks, Arichis II. (d. 787) of Beneventum wished to assert his independent sovereignty, he had himself anointed and crowned, and exchanged his style of duke for that of prince.

From Italy the use of the title spread—first, with the Crusaders, to the Holy Land, where Bohemund, son of Tancred, took the style of prince of Antioch; next, with the Latin conquerors, into the East Roman Empire, where in 1205 William de Champllette, a cadet of the house of Champagne, founded the principality of Achaëa and the Morea. This example was followed by lesser magnates, who styled themselves loosely, or were so styled by the chroniclers, "princes," even though they had little claim to independent sovereignty. From the East the

France. fashion was carried back to France; but there the erection of certain fiefs into "principalities," which became common in the 15th and 16th centuries, certainly implied no concession of independent sovereignty, and the title of "prince" thus bestowed ranked below that of "duke," being sometimes borne by cadet branches of ducal houses, e.g. the princes of Léon and of Soubise, cadets of the house of Rohan. On the other hand, the title of "prince" was borne from the time of Charles VII. or Louis XI. by the sons of the royal house, so-called "princes of the blood" (*princes du sang*), who took precedence in due order after the king. To these were added, from the time of Louis XIV., the *princes légitimés*, recognized bastards of the sovereign, who ranked next after the princes of the blood. Thus, e.g. the princes of Condé, Conti and Lamballe owed their exalted precedence, not to their principalities, but to their royal descent.

In Germany, Austria and other countries formerly embraced in the Holy Roman Empire the title of "prince" has had a somewhat different history. During the first period of the empire, the "princes" were the whole body of the *optimates* who took rank next to the emperor. In the 11th century, with the growth of feudalism, all feudatories holding in chief of the Crown ranked as "princes," from dukes to simple counts, together with archbishops, bishops and the abbots of monasteries held directly of the emperor. Towards the end of the 12th century, however, the order of princes (*Fürstenstand*) was narrowed to the more important spiritual and temporal feudatories who had a right to a seat in the diet of the empire in the "college of princes" (*Fürstenbank*). Finally, in the 13th century, seven of the most powerful of these separated themselves into a college which obtained the sole right of electing the emperor. These were called "prince electors" (*Kurfürsten*), and formed the highest rank of the German princes (see ELECTOR). The formal designation of "prince" (*Fürst*) was, however, extremely rare in Germany in the middle ages. Examples are

the princes of Mecklenburg (Prilislav I., prince of the Holy Roman Empire in 1170) and Rügen, the latter title now belonging to the kings of Prussia. In the 17th century some half-dozen more principalities were created, of which that of Schwarzburg-Sondershausen (1697) survives as a sovereign house. The 18th century increased their number, and of the princely houses of this period those of Schwarzburg-Rudolstadt (1710), Waldeck (1712) and Reuss, elder branch (1778), have preserved their sovereignty. Of the other sovereign "princes" in Germany, Reuss, cadet branch, obtained the title in 1806, Schaumburg-Lippe in 1807. Outside the German Empire the prince of Liechtenstein, whose title dates from 1608, still remains sovereign.

Thus, in Germany, with the decay of the empire the title "prince" received a sovereign connotation, though it ranks, as in France, below that of "duke." There are, however, in the countries formerly embraced in the Holy Roman Empire other classes of "princes." Some of these inherit titles, sovereign under the old empire, but "mediatized" during the years of its collapse at the beginning of the 19th century, e.g. Thurn and Taxis (1695), Hohenlohe (1764), Leiningen (1779); others received the title of "prince" immediately before or after the end of the empire as "compensation" for ceded territories, e.g. Metternich-Winneburg (1803). Besides these mediatized princes, who transmit their titles and their privilege of "royal" blood to all their legitimate descendants, there are also in Austria and Germany "princes," created by the various German sovereigns, and some dating from the period of the old empire, who take a lower rank, as not being "princes of the Holy Roman Empire" nor entitled to any royal privileges. Some of these titles have been bestowed to give a recognized rank to the morganatic wives and children of royal princes, e.g., the princes of Battenberg, or the title of "princess" of Hohenberg borne by the consort of the Archduke Francis Ferdinand d'Este; others as a reward for distinguished service, e.g. Hardenberg, Blücher, Bismarck. In this latter case the rule of primogeniture has been usual, the younger sons taking the title of "count" (*Graf*). These non-royal princes are ranked in the *Almanach de Gotha* with British and French dukes and Italian princes. All these various classes of princes are styled *Fürst* and have the predicate "Serene Highness" (*Durchlaucht*). The word *Prinz*, actually synonymous with *Fürst*, is reserved as the title of the non-reigning members of sovereign houses and, with certain exceptions (e.g. Bavaria), for the cadets of mediatized ducal and princely families. The heir to a throne is "crown prince" (*Kronprinz*), "hereditary grand duke" (*Erbgrossherzog*) or "hereditary prince" (*Erbprinz*). The heir to the crown of Prussia, when not the son of the monarch has the title of "prince of Prussia" (*Prinz von Preussen*).¹

In Italy the title "prince" (*principe*) is also of very unequal value. In Naples, following the precedent set by Arichis II., "much affecting the glory of a greater name than duke," it ranked above that of duke. In other parts of Italy the heads of great families sometimes bear the title of "prince," e.g. Prince Corsini, duke of Casigliano; sometimes that of "duke," e.g. the Caetani, princes of Teano, whose chief is styled "duke of Sermoneta," the title of "prince of Teano" being borne by his eldest son. The title of "prince of Naples" is attached to the eldest son of the king of Italy. The excessive multiplication of the title has tended to deprive it of much social value in itself, and under the democratic constitution of Italy it confers neither power nor precedence.

"Prince" is also the translation of the Russian title *knyaz*, though *veliky knyaz*, the style of the Imperial princes, is rendered "grand duke." Some of the Russian, or Polish-Russian, princely families are of great importance—**Russia.** e.g. the Czartoryskis, the Swiatopolk-Czetwertynskis, or the Russian

¹ *Fürst* may or may not be a sovereign or territorial title, but it is only borne by the head of the family, e.g. Heinrich XIV., *regierender Fürst* (reigning prince) von Reuss or *Fürst* Bismarck. *Prinz* always implies cadetship, e.g. *Prinz* Heinrich XLV. Reuss. The title *Prinz von Preussen*, therefore, excludes any idea of territorial sovereignty, whereas the correct German rendering of that of prince of Wales, which originally at least implied such sovereignty, would be *Fürst von Wales*.

branch of the Lubomirskis. But, in general, though the title "prince" implies descent from one or other of the ruling dynasties of Russia, it is in itself of little account, being exceedingly common owing to its being borne by every member of the family. The predicate of "Serene Highness," though borne by certain magnates who were princes before they became Russians—as in the case of the families mentioned above—is not attached to the Russian title of "prince." In some cases, however, it is conferred with the title by imperial warrant (e.g. Lieven, 1826).

The title of "prince" is also borne by the descendants of those Greek Phanariot families (see PHANARIOTS), e.g. Mavrocordato, Ypsilanti, Soutzo, who formerly supplied hospodars to the Turkish principalities on the Danube. In the Ottoman Empire the rulers appointed to the quasi-independent Christian communities subject to it have usually been designated "prince," and the title has thus come to signify in connexion with the Eastern Question a sovereignty more or less subordinate. As such it was rejected on behalf of the Bavarian prince Otho, when he accepted the throne of Greece, in favour of that of "king." On the other hand, the substitution, in 1852, in Montenegro of the title of "prince and lord" (*knyaz i gospodar*) for the ancient title of *vladika* (archbishop) certainly implied no such subordination. The only other instance in Europe of "prince" as a completely sovereign title is that of the prince of Monaco, the formal style having been adopted by the Grimaldi lords in 1641.

In Great Britain "prince" and "princess" as titles are confined to members of the royal family, though non-royal dukes are so described in their formal style (see DUKE).

Nor is this use of great antiquity; the custom of giving the courtesy title of "prince" to all male descendants of the sovereign to the third and fourth generation being of modern growth and quite foreign to English traditions. It was not till the reign of Henry VII. that the king's sons began to be styled "princes"; and as late as the time of Charles II., the daughters of the duke of York, both of whom became queens regnant, were called simply the Lady Mary and the Lady Anne. The title of "princess royal," bestowed on the eldest daughter of the sovereign was borrowed by King George II. from Prussia. Until recent years the title "prince" was never conferred on anybody except the heir-apparent to the Crown, and his principality is a peerage. Since the reign of Edward III. the eldest sons of the kings and queens of England have always been dukes of Cornwall by birth, and, with a few exceptions, princes of Wales by creation. Before that Edward I. had conferred the principality on his eldest son, afterwards Edward II., who was summoned to and sat in parliament as prince of Wales. But Edward the Black Prince was the original grantee of the principality as well as of the dukedom, under the special limitations which have continued in force to the present day. The entail of the former was "to him and his heirs the kings of England" and of the latter "to him and his heirs the first-begotten sons of the kings of England." Hence when a prince of Wales and duke of Cornwall succeeds to the throne the principality in all cases merges at once in the Crown, and can have no separate existence again except under a fresh creation, while the dukedom, if he has a son, descends immediately to him, or remains in abeyance until he has a son if one is not already born. If, however, a prince of Wales and duke of Cornwall should die in the lifetime of the sovereign, leaving a son and heir, both dignities are extinguished, because his son, although he is his heir, is neither a king of England nor the first-begotten son of a king of England. But, if instead of a son he should leave a brother his heir, then—as was decided in the reign of James I. on the death of Henry, prince of Wales, whose heir was his brother Charles, duke of York—the dukedom of Cornwall would pass to him as the first-begotten son of the king of England then alive, the principality of Wales alone becoming merged in the Crown. It has thus occasionally happened that the dukes of Cornwall have not been princes of Wales, as Henry VI. and Edward VI., and that the princes

of Wales have not been dukes of Cornwall, as Richard II. and George III.

But even now the cadets of the reigning family can only by royal intervention legally be saved from merging, as of old, in the general untitled mass of the people. The children of the sovereign other than his eldest son, though by courtesy "princes" and "princesses," need a royal warrant to raise them *de jure* above the common herd; and even then, though they be dubbed "Royal Highness" in their cradles, they remain "commoners" till raised to the peerage. In 1905 King Edward VII. established what appears to be a new precedent, by conferring the titles of "princess" and "highness" upon the daughters of the princess Louise, duchess of Fife, created "princess royal."

This use of the word "prince"—which has in England so lofty a connotation—to translate foreign titles of such varying importance and significance naturally leads to a good deal of confusion in the public mind. It is not uncommon in English society to see, e.g. a Russian prince, who may be only the cadet of a family not included in the *Almanach de Gotha*, given precedence as such over the untitled members of a great English ducal family, and treated with some of that exaggerated deference paid to "royalty." On the other hand, the insular complacency of many Englishmen is apt to regard all German princes with a certain contempt, whereas the title is in Germany sometimes associated with sovereign power, sometimes with vast territorial possessions, and always with high social position.

See, Du Cange, *Glossarium*, s.v. "Principes," ed. G. A. L. Henschel (Niort, 1883); John Selden, *Titles of Honour* (London, 1672); *Almanach de Gotha* (1906); H. Schulze, *Die Hausgesetze der regierenden deutschen Fürstenhäuser* (3 vols., Jena, 1862–1883); H. Rehm, *Modernes Fürstenrecht* (Munich, 1904). (W. A. P.)

PRINCE EDWARD ISLAND, a province of the Dominion of Canada, lies between 45° 58' and 47° 7' N. and 62° and 64° 27' W. The underlying geological formation is Permian, though outliers of Triassic rock occur. The coal seams supposed to underlie the Permian formation are apparently too deep down to be of practical value. The rocks consist of soft red micaceous sandstone and shales, with interstratified but irregular beds of brownish-red conglomerates containing pebbles of white quartz and other rocks. There are also beds of hard dark-red sandstone with the shales. Bands of moderately hard reddish-brown conglomerate, the pebbles being of red shale and containing white calcite, are seen at many points; and then greenish-grey irregular patches occur in the red beds, due to the bleaching out of the red colours by the action of the organic matter of plants. Fossil plants are abundant at many places. Beds of peat, dunes of drifted sand, alluvial clays and mussel mud occur in and near the creeks and bays.

Physical Features.—The island lies in a great semi-circular bay of the Gulf of St Lawrence, which extends from Point Miscou in New Brunswick to Cape North in Cape Breton. From the mainland it is separated by Northumberland Strait, which varies from 9 to 30 miles in width. It is extremely irregular in shape, and deep inlets and tidal streams almost divide it into three approximately equal parts; from the head of Hillsborough river on the south to Savage Harbour on the north is only one and a half miles, while at high tide the distance between the heads of the streams which fall into Bedeque and Richmond Bays is even less. North of Summerside the land nowhere rises more than 175 ft. above sea-level; but between Summerside and Charlottetown, especially near north Wiltshire, is a ridge of hills, running from north to south and rising to a height of nearly 500 ft. From Charlottetown eastwards the land is low and level. The north shore, facing the gulf, is a long series of beaches of fine sand, and is a favourite resort in summer. On the south, low cliffs of crumbling red sandstone face the strait. The climate is healthy, and though bracing, milder than that of the neighbouring mainland. Fogs are much less common than in either New Brunswick or Nova Scotia.

Area and Population.—The greatest length of the island is 145 m., its greatest breadth 34 m., its total area 2184 sq. m.

Prince of Wales.

The population in 1901 was 103,259, having sunk from 109,078 in 1891. It is thus much the most densely populated province in Canada, there being nearly fifty-two persons to the sq. m. Though very large families are not so common as in the province of Quebec, the agricultural character of the population makes the average number of persons to a family greater (5.51) than in any other province. As in all the maritime provinces, there is a steady immigration to the Canadian West and to the United States. The population is mainly of British descent, but also comprises descendants of the French Acadians and of the American loyalists. About 200 Indians of the Mic-Mac tribe remain, and have slightly increased in numbers since 1891. In 1901 the origin of the people was: Scots, 41,753; English, 24,043; Irish, 21,992; French, 13,867; all other nationalities, 1604. The principal religious denominations and the number of their adherents were as follows: Church of Rome, 45,796; Presbyterians, 30,750; Methodists, 13,402; Anglican, 5976; Baptists, 5905. The Irish and French are almost entirely Roman Catholic, the Scots about two-thirds Presbyterian and one third Roman Catholic. Jurisdiction over the Catholics is held by the bishop of Charlottetown, and over the Anglicans by the bishop of Nova Scotia. The Presbyterians form part of the synod of the Maritime Provinces.

Administration, &c.—Five members of the House of Commons and four senators are sent to the federal legislature. At its entry into federation in 1873, the number of members was six, and the reduction to five in 1901 was bitterly denounced. The local government now consists of a lieutenant-governor and of a legislative assembly. This conducts not only the general affairs of the province, but most of those of the towns and villages; legal provision has, however, been made for the establishment of a municipal system, and Charlottetown and Summerside are incorporated municipalities, though with powers of self-government much more limited than those of any other incorporated Canadian towns. The provincial revenues, which tend to prove inadequate, are largely made up of the subsidy paid by the federal government, though there are numerous taxes, which bear heavily on the small industrial population. But for the increase in 1907 of the federal subsidy, financial exigencies might have forced the adoption of direct taxation, in spite of its unpopularity among the farmers.

Education.—Primary education in the province has been given free since 1852. Since 1877 it has been under the control of a minister of education with a seat in the provincial cabinet. At Charlottetown is the Prince of Wales College, really a rather advanced secondary school, with which is affiliated the Normal School. St Dunstan's College, another advanced high school in Charlottetown, is under Roman Catholic control. Advanced university education is not given in the province. Attendance at the primary schools is by law compulsory, but the exigencies of a farming population and the lack of adequate means of enforcement render the law inoperative. The salaries of the teachers are, as a rule, low, and the school buildings cheerless and ill-maintained.

Agriculture.—The soil, an open sandy loam, deep red in colour, which was slightly exhausted at the beginning of the century by repeated crops of cereals, has been renewed by the application of mussel mud dredged from the bays and tidal streams. All the staple crops are grown—especially oats, potatoes and turnips. Wheat is raised only for local consumption. Cattle and hogs flourish. In the last years of the 19th century the introduction of co-operation gave a great impetus to the manufacture of butter and cheese. The first cheese factory was opened in 1892, and the first creamery in 1894. Of over 15,000 farmers all, save about 900, own their own farms, and are in nearly all cases well-to-do. Large quantities of animal and vegetable food, amounting to about one-half of the total product, are exported, chiefly to Cape Breton, Newfoundland, and the New England states. Fruit is raised less extensively than in Nova Scotia, but enough is grown to supply the local market, and apples of good quality are exported.

Fisheries.—Though smaller in value than those of any other

sea-board province, the fisheries of Prince Edward Island are, in proportion to the total population, extremely productive. Of the catch of about £200,000, lobsters, most of which are canned, are worth about £90,000, and oysters £20,000, in the latter case about half the total value of the catch of the Dominion, which is compelled to import largely from the United States. There are signs of the approaching exhaustion of the oyster beds, but no adequate remedy or new source of supply has been found. Herring, cod, mackerel and smelts are also caught in large quantities in the coast waters.

Other Industries.—About one-third of the province is covered with birch, beech, maple, pine, spruce, cedar and other woods, but though a little lumber is exported, the industry is declining. The building of wooden ships, a flourishing trade till about 1886, is now almost extinct. The packing of pork and of lobsters is actively pursued near Charlottetown, and small factories have been established for the manufacture of boots and shoes, tobacco, condensed milk, &c., but the great bulk of the manufactured goods used are imported from the other provinces.

Communications.—The Prince Edward Island branch of the Intercolonial railway, owned and worked by the federal government, runs from Souris in the east to Tignish in the north-west, with branches to Georgetown, Murray Harbour, Charlottetown and Cape Traverse. Good wagon roads intersect each other everywhere, and nearly all the villages and country districts are connected by telephone. During spring, summer and autumn Charlottetown has daily communication with Pictou in Nova Scotia and Shediac in New Brunswick, and a frequent service to other ports in Nova Scotia, Newfoundland and Massachusetts. The harbour of Charlottetown and the Northumberland Straits are closed by ice from about the middle of December to the beginning of April, after which there is a service by specially constructed ice-breaking boats between Georgetown and Pictou. The ice is often too thick to make a regular service possible, and the island has long agitated for federal construction of a railway tunnel between Cape Traverse in Prince Edward Island and the neighbouring shore of New Brunswick, 9 m. distant.

History.—Jacques Cartier sighted Prince Edward Island on his first voyage in June 1534, but mistook it for part of the mainland. Succeeding voyagers discovered his mistake, and toward the end of the 16th century it was called Isle St Jean, which name it retained till 1798, when it was given its present name out of compliment to the duke of Kent, at that time commanding the British forces in North America. In 1603 Champlain took possession of it for France, and in 1663 it was granted by the company of New France to Captain Doublet, an officer in the navy whose failure to make permanent settlements soon brought about the loss of his grant. Little attention was paid to the island until after the Peace of Utrecht, when the French made efforts to colonize it. In 1719 it was granted, *en franc alleu noble*, to the count of St Pierre, who tried to establish fisheries and a trading company. He spent large sums on his enterprise, but the scheme proved unsuccessful and his grant was revoked. In 1758, soon after the capture of Louisbourg, Isle St Jean was occupied by a British force under Lord Rollo (see *Annual Register*, 1758). Its population at this time numbered about 4000, under a military governor with his headquarters at Port la Joie (Charlottetown). After its final cession to Great Britain in 1763 it was placed under the administration of Nova Scotia, but later was made a separate government, its first parliament meeting in 1773.

In 1764-1765 it was surveyed, and most of the present names given; in 1767 it was divided into townships of about 20,000 acres each, grants of which were made to individuals with claims on the government. They were to pay a small sum as quit rents, and the conditions imposed provided for the establishment of churches and wharves and bona-fide settlement. On these terms practically the whole island was granted away in a single day. The grantees were in most cases mere speculators, and the lands fell into the hands of a large number of non-residents. A continual agitation against the absentees was kept up by the settlers, who rapidly increased in numbers. During the early

19th century many Scottish immigrants settled in the island. A commission appointed in 1860 advised the compulsory purchase of the lands, and their sale in smaller holdings to genuine settlers, but a bill passed with this intent was disallowed by the imperial authorities.

In 1864 a conference to consider the question of maritime union met at Charlottetown. The visit of delegates from Canada widened it into a general conference on federation, from which sprang the Dominion of Canada. Prince Edward Island's local patriotism forced its representatives to withdraw from the later conferences, but the abrogation in 1866 by the United States of the Reciprocity Treaty of 1854, financial difficulties connected with the building of an island railway, and the offer of better terms by the Dominion government, brought it into federation in 1873. A bill on the lines of that formerly disallowed was soon afterwards passed, and the land difficulty was finally settled. Since then the main political issues have been the quarrel with the federal government over the construction of a tunnel and the control of the liquor traffic, which has been prohibited but by no means suppressed.

AUTHORITIES.—Sir J. W. Dawson, *Acadian Geology* (1891); *Report of Dr R. W. Ells, Geological Survey* (1882-1884); *Report of R. Chalmers, Geological Survey* (1894); Rev. G. Sutherland, *Manual of History of Prince Edward Island* (1861); D. Campbell, *History of Prince Edward Island* (1875); *Special Reports on Educational Subjects*, vol. iv. (London, 1901); articles in J. C. Hopkins's *Canada, an Encyclopaedia* (Toronto, 1898-1900). (W. L. G.)

PRINCES' ISLANDS (anc. *Demonesi*; Byzantine, *Papadonisia*; Turkish, *Kizil Adalar*, or "Red Islands," from the ruddy colour of the rocks), a cluster of nine islands in the Sea of Marmora, forming a caza of the prefecture of Constantinople. They figure in Byzantine history chiefly as places of banishment. A convent in Prinkipo (now a mass of ruins at the spot called Kamares) was a place of exile for the empresses Irene, Euphrosyne, Zoe and Anna Dalassena. Antigone was the prison of the patriarch Methodius, and its chapel is said to have been built by the empress Theodora. In Khalki the monastery of the Theotokos (originally of St John), which since 1831 has been a Greek commercial school, was probably founded by John VI. or VII. Palaeologus, was rebuilt about 1680, and again in the 18th century by Alexander Ypsilanti, hospodar of Moldavia. Close beside it is the tomb of Edward Barton, second English ambassador to the Porte. Hagia Trias (a school of theology since 1844) was rebuilt by the patriarch Metrophanes. On Prote were the monasteries to which Bardanes (Philippicus), Michael I. Rhangabes, Romanus I., Lecapenus and Romanus IV. Diogenes were banished. The islands are a favourite summer resort; four are inhabited and noted for the mildness and salubrity of their climate. Prinkipo (*Pityusa*), altitude 655 ft.; Khalki (*Chalcitis*; Turkish *Heibeli*), 445 ft.; Prote (Turkish *Kinali*), 375 ft.; and Antigone (*Panormus*; Turkish *Burgaz Adasi*), 500 ft. The buildings on all the islands were injured by the earthquake of 1894, especially the naval college, and monastery of St George on Khalki, and the monastery of Christ on Prinkipo. The population is about 10,500, half being Greek. Khalki contains an Ottoman naval school and Greek theological and commercial colleges.

See G. Schlumberger, *Les Îles des Princes* (Paris, 1884); A. Grisebach, *Rumelien und Brussa* (Göttingen, 1839).

PRINCETON, a city and the county-seat of Gibson county, Indiana, U.S.A., about 27 m. N. of Evansville. Pop. (1900), 6041, 628 being of negro descent and 198 foreign-born; (1910) 6443. It is served by the Evansville & Terre Haute and the Southern railways (the latter of which has shops here), and by the Evansville & Southern Indiana traction line (electric). It has a considerable trade in oil and coal and in the agricultural products of the surrounding region, and has various manufactures. Princeton was first settled in 1814, and was chartered as a city in 1884.

PRINCETON, a borough of Mercer county, New Jersey, on Stony Brook, and the Delaware & Raritan canal, 49 m. S.W. of New York City. Pop. (1905) 6029; (1910) 5136. Princeton is served by the Pennsylvania railroad, and by two electric lines

to Trenton (10 m.), passing through Lawrenceville (in Lawrence township; until 1816 called Maidenhead; pop., 2522 in 1910), the seat of the Lawrenceville school (1882), for boys, which was endowed by the residuary legatees of John Cleve Green (1800-1875), and is probably the first endowed secondary school for boys in the Middle States.

Princeton is situated 210 ft. above sea-level, and the county to the east, north and west is rocky and hilly. The borough is the seat of Princeton University (*q.v.*), and of "The Theological Seminary of the Presbyterian Church in the United States of America," commonly known as Princeton Theological Seminary, which was opened in 1812, and was chartered in 1824. The seminary was for one year under the sole care of Archibald Alexander (*q.v.*), and among its teachers and representative theologians have been Samuel Miller (1769-1850), who was professor of ecclesiastical history and church government here (1813-1849), Charles Hodge, Joseph Addison Alexander and James Waddell Alexander, William Henry Green, Archibald Alexander Hodge, Francis L. Patton, who became president in 1902 and Benjamin B. Warfield (b. 1851), professor of didactic and polemic theology from 1887. Under such leaders Princeton theology has been distinctly conservative, supporting the old standards of the Westminster Confession and Catechisms. The seminary is well endowed, so that there is no charge for tuition or room rent; among its principal benefactors were James Lenox (1800-1880), Robert Leighton Stuart (1806-1882), his widow and his brother Alexander (1810-1879), John Cleve Green, mentioned above, and Mrs Mary J. Winthrop (d. 1902). It has a fine campus south-west of the business centre of the borough; in the Lenox Library and the Lenox Reference Library, built in 1843 and 1879 respectively, and gifts of James Lenox, there were 82,200 bound volumes and 31,500 pamphlets in 1909; Stuart Hall (1876) contains lecture-rooms; Miller Chapel is the place of worship; and the three dormitories are Alexander Hall (the "Old Seminary"), first used for this purpose in 1817, Brown Hall, built in 1864-1865, and Hodge Hall (1893). In 1908-1909 the faculty numbered 16 and the students 153, of whom 8 were fellows and 17 graduate students.

Princeton became in 1897 the home of Grover Cleveland, who died there; and from 1898 until his death it was the residence of Laurence Hutton (1843-1904), a well-known writer on the history of the stage. Besides its fine residences and buildings of the seminary and of the university, the only notable buildings are the handsome Princeton Inn, about midway between the campus of the university and that of the seminary, and "Morven," the homestead of the Stocktons, built in the first decade of the 18th century. In the Princeton Cemetery are buried presidents and professors of the university.

The first settlers were the companions of Richard Stockton, the grandfather of Richard Stockton, signer of the Declaration of Independence. The removal hither in 1756 from Newark of the College of New Jersey, later Princeton University, gave the place its first educational prominence. At the time of the War of Independence town and gown were both strongly patriotic. The first state legislature of New Jersey met here on the 27th of August 1776; and in Nassau Hall, the first of the college buildings, erected in 1754-1756, which was then the largest edifice in the colonies, the Continental Congress sat from the 30th of June to the 4th of November 1773, and on the 31st of October Congress received the news of the signature of the definitive treaty of peace with Great Britain. After the battle of Trenton Cornwallis's troops were hurried to that place, three regiments and three companies of light-horse being left at Princeton when the main body, on the 2nd of January 1777, passed through. Washington, unable to retreat or to meet the British attack, turned Cornwallis's left flank and advanced on the weak British garrison in Princeton. A detachment under General Hugh Mercer (*c.* 1720-1777), ordered to destroy the Stony Brook bridge, and so cut off escape to Trenton, met two of the three regiments, led by Lieut.-Colonel Charles Mawhood, near the bridge, and, though doing great execution with its rifles at a distance, was unable, being unequipped with bayonets, to hold its ground

in hand-to-hand fighting, and fled through an orchard, leaving Mercer there mortally wounded; he died on the 12th in a farmhouse (still standing) on the battlefield. Washington's main army now came to the assistance of the retreating Americans, and forced the retreat of the other British regiments (the 55th and 40th) to Princeton, where they either surrendered or fled towards New Brunswick. The British losses were heavy and the Americans lost many officers. The bridge was destroyed by the American troops just before the approach of General Alexander Leslie (c. 1740-1794) with reinforcements from Cornwallis. Washington's flank movement at Trenton and his engagement with the British at Princeton made necessary the withdrawal of the British from West Jersey. In the autumn of 1783 Washington, summoned to Princeton by Congress, then in session there, made his headquarters at Rocky Hill, about 4 m. north of Princeton in Montgomery township, Somerset county, whence on the 2nd of November he issued his farewell address to the army; his headquarters is preserved as a museum. A battle monument in Princeton, designed by MacMonnies and paid for by the Federal Congress, the state of New Jersey and the borough of Princeton, has been projected.

See J. R. Williams, *Handbook of Princeton* (New York, 1905); J. F. Hageman, *History of Princeton and its Institutions* (2 vols., Philadelphia, 1879); W. S. Stryker, *The Battles of Trenton and Princeton* (Boston, 1898); and V. L. Collins, *The Continental Congress at Princeton* (Princeton, 1908).

PRINCETON UNIVERSITY, an American institution of higher learning in Princeton, New Jersey, until 1896 called officially the college of New Jersey. Its campus consists of 539 acres comprised in three tracts of ground adjoining each other. The main campus, one of the most beautiful in the country, is on the south side of Nassau Street, the old country road between Philadelphia and New York, and is principally contained in a block of about 225 acres, which on its west side has an almost continuous row of English collegiate Gothic buildings: Blair Hall, Stafford Little Hall and the gymnasium.

Nassau Hall, which was built in 1756, nearly destroyed by fire in 1802, rebuilt in 1804, and damaged by fire in 1855, is a squarely built edifice in the Georgian style. Originally housing the whole college, it is familiarly known as North College, in a quadrangle arrangement of which West College, built in 1836, is the only other remainder; the south side having been occupied since 1838 by Clio Hall and Whig Hall, the homes of the two literary societies, founded respectively in 1765 and 1769, and since 1893 housed in white marble buildings of classical type; and East College, having given place to the main building of the University Library (1897), in Oxford Gothic of Longmeadow stone, the gift of Mrs Percy Rivington Pyne. Besides West College, the dormitories are Reunion Hall (1870), commemorating the reconciliation of the Old and New schools of the Presbyterian Church; University Hall (1876), formerly an hotel and now housing on its lower floors the university dining halls for all freshmen and sophomores; Witherspoon Hall (1877), in Victorian Gothic of grey stone trimmed with brown; Edwards Hall (1880), a brown stone Gothic building; Albert B. Dod Hall (1890), a granite limestone-trimmed Italian building; David Brown Hall (1891), granite and Pompeian brick, in Florentine Renaissance; the Pyne Buildings (1896) in half-timbered Chester style; Blair Hall (1897), built in English Collegiate Gothic of white Germantown stone, on the south-western margin of the campus; the Stafford Little Hall (1899 and 1901), in the same style as Blair Hall, and joining it on the south; Seventy-nine Hall (1904), the gift of the class of 1879, another Tudor Gothic building of red brick trimmed with Indiana limestone; and Patton Hall (1906); Campbell Hall (1909), the gift of the class of 1877; and a new group of buildings, chiefly dormitories, occupying the entire north-west corner of the main campus, fronting on Nassau and University Place, three sections of which (two being the gift of Mrs Russell Sage) were completed in 1910. These buildings are in the same architectural style and of the same materials as Blair and Little Halls. There is accommodation for about 90% of the undergraduates of the

university in the campus dormitories, including the new buildings.

The recitation halls are: Dickinson (1870; remodelled in 1876) and McCosh Hall (1907), for the academic department; and the school of science building (1873), a gift of John C. Green, on the north-east corner of the main block of the campus. The Halsted Observatory (1869) and the Observatory of Instruction (1878) are well known for the work done in them by the astronomer Charles Augustus Young (1834-1908); among the laboratories are the biological (1887), the chemical (1891), the civil engineering (1904), the Palmer physical (1908), and, for natural science, Guyot Hall (1909), which also houses the natural science museum, including valuable fossils. There is a museum of historic art (1887) which includes the finds of the Princeton archaeological expedition to Syria, and in Nassau Hall there is a psychological laboratory. There are two auditoriums, the Marquand chapel (1881), the gift of Henry G. Marquand, and Alexander Hall (1892), used for commencement exercises. Also on the campus are the dean's house (1756), until 1878 the president's residence; Prospect (1849), bought by the college in 1878, which is the president's residence; the university offices (1803); and Dodge Hall (1900) and Murray Hall (1879), which are the home of the college Y.M.C.A., the Philadelphian Society, founded in 1825.

The university library is housed in a large building already described, built (1896) on to the Chancellor Green library building (1872), given by John C. Green in memory of his brother Henry Woodhull Green, chancellor of the state of New Jersey, and now the reading room and reference library. In 1910 the library had a collection of 257,800 volumes and about 58,000 unbound pamphlets. There are two athletic fields: one, the university, two blocks east of the main campus, and the other, the Brokaw field, in the south-west corner of the main campus; immediately north of the latter are the Brokaw Memorial gateway and building (1892), with a swimming pool, and the university gymnasium (1903). South-east of the Campus is Lake Carnegie, an artificial widening of Millstone River, the gift of Andrew Carnegie; it is used for boating.

A notable feature of the university is its upper-class club-houses. The upper-class clubs have in the social life of Princeton somewhat the place of the Greek letter societies elsewhere. There are no fraternities at Princeton: each entering student pledges himself to "have no connexion whatever with any secret society, nor be present at the meetings of any secret society" so long as he is a member of the university, "it being understood that this promise has no reference to the American Whig and Closophic Societies." These two societies, the object of which is particularly to cultivate skill in debate and public speaking, are affiliated with the English department of the faculty.

A peculiarity of the university is its system of student government, which is most markedly developed in the Princeton "honour system" in examinations and written recitations, under which every student signs a pledge on his paper that he has "neither given nor received assistance," and there is no faculty or monitorial watch over students in examinations; the system is administered by a student committee, to which any dishonesty in examinations is to be reported, and which then investigates the charge, and if it finds it true reports the offender to the faculty for dismissal.

The university in 1910 included an academic department, leading to the degree of A.B., or Litt. B.; the John C. Green school of science (1873), offering courses leading to the degree of B.S. and C.E.; a school of electrical engineering; and a graduate department (1877), with courses leading to master's and doctor's degrees. Entrance requirements are largely in accordance with the recommendations of the National Educational Association and the college entrance examination board; students entering the academic department must offer Greek if they are candidates for the degree of A.B.; students (not offering Greek for entrance) who concentrate in mathematics or science in junior and senior year are candidates for the B.S. degree, and those who concentrate in other departments during those years, for the Litt. B. degree. The entrance requirements for the B.S. and Litt. B. degree are the same, and they differ from those for the A.B. degree (and agree with those for the C.E. degree) in including more mathematics, i.e. solid geometry and plane trigonometry. The school of electrical engineering is graduate and professional in its scope. The graduate school (1871) is only slightly developed, and this development has been almost entirely since 1900; a bequest of more than \$300,000 in 1906 provided for the John R. Thomson Graduate College; and the estate of Isaac Chauncey Wyman (d. 1910), of the class of 1848, valued at about

\$3,000,000, was left to the university for the establishment of the graduate school.

A notable feature of the scheme of instruction is the preceptorial (or tutorial) system, introduced in 1905; it somewhat resembles Jowett's method at Balliol College, Oxford; the preceptors, usually young men (many of them domiciled in the dormitories), have "conferences" each with a certain number of students on prescribed reading, especially in the departments of philosophy, history and politics, art and archaeology, and the languages. The preceptorial system has been a great success, and seems to have given the university a greater intellectual vitality. In 1909-1910 the university faculty numbered 169, of whom 51 were preceptors. In the same year there were 1400 students of whom 134 were in the graduate school, 13 in the school of electrical engineering, 521 in the A.B. course, 440 in the Litt.B. and B.S. courses, 203 in the C.E. course, and 89 not in regular courses.

The corporate title of the university is "The Trustees of Princeton University," and the university is governed by the trustees, of whom the governor of the state of New Jersey is *ex officio* president. The president of the university is president of the board in the absence of the governor. The Board consists of twenty-five "life trustees," a self-perpetuating body, two *ex officio* trustees, and (since 1900) five alumni trustees, elected by the graduates of the university for a five-year term, one each year.

The tuition fee is \$160 a year in all undergraduate courses. There are many scholarships and prizes, a fund for the remission of tuition to students of insufficient means, and funds for the assistance of students for the ministry. In July 1909 the assets of the university were \$4,749,482, of which \$4,168,900 was invested for endowment; of the endowment \$3,410,907 was special, \$330,445 general, \$60,000 historical, \$122,643 was for scholarships and \$244,905 was for professorships; and in this fiscal year the gifts for current expenses and special purposes amounted to \$199,294 and the gifts for endowment to \$1,508,283.

The university owes its origin to a movement set on foot by the Synod of Philadelphia in 1739 to establish in the Middle Colonies a college to rank with Harvard and Yale in New England and William and Mary in Virginia. Owing to dissension in the Church, no progress was made until 1746, when the plan was again broached by the synod of New York, recently formed by the secession of the presbytery of New York and the presbytery of New Brunswick, radical (New School) presbyteries of the Synod of Philadelphia. The synod of New York was led by Ebenezer Pemberton (1704-1779), a graduate of Harvard (1721), and Jonathan Dickinson (1688-1747), a graduate of Yale (1706). Together they had attempted to make peace between the conservatism of the presbytery of Philadelphia and the radicalism of the presbytery of New Brunswick. Most of the leaders of the presbytery of New Brunswick had been educated at the Log College, a school with restricted curriculum, situated about 20 m. N.N.E. of Philadelphia, but recently closed. The students of the Log College were almost without exception preparing for the Presbyterian ministry, and on the closing of the Log College, the opportunity was taken by the synod of New York to found a larger and better institution of higher learning, broader in scope and training, and to transfer to the new project the Log College interests. On October 22nd 1746, John Hamilton, acting governor of New Jersey, granted a charter for erecting a college in New Jersey. The college of New Jersey was opened in May 1747 at Elizabeth, New Jersey, with the Rev. Jonathan Dickinson as president. Little was accomplished until 1748, when, on the 14th of September, a second charter was granted to the "trustees of the College of New Jersey," thirteen in number. The college under the administration of Jonathan Dickinson, held its exercises from the last of May 1747 to the 7th of October 1747, when Dickinson died. Upon the succession of Aaron Burr to the presidency, the school removed to Newark, where the first commencement was held in 1748 and where Burr began the work of organizing the college and its curriculum; but the situation was unsuitable, and in 1752 the trustees voted to remove the college to Princeton, where land was given for the Campus by Nathaniel Fitz Randolph. While funds were being collected in Great Britain, work was begun in Princeton in 1754 on the first college building, which, at Governor Belcher's request, was named Nassau Hall, in honour of King William. A year after the completion of this single college building and the removal of the students to Princeton, Burr died and was succeeded by his father-in-law,

Jonathan Edwards, who died after five weeks in office (1758). He was succeeded (1759-1761) by Samuel Davies, and Davies (in 1761-1766) by Samuel Finley (1715-1766). John Witherspoon (*q.v.*) was president from 1768 until his death in 1794, and more than any of his predecessors influenced the college. The presidents immediately succeeding Witherspoon were: his son-in-law, Samuel Stanhope Smith (1750-1819), who resigned in 1812; Ashbel Green (1762-1848), who resigned in 1822; James Carnahan (1775-1859), who held office for thirty-one years (1823-1854), and in whose presidency there was, in 1846-1852, a department of law in the college; and John Maclean (1800-1886), who was president from 1854 to 1868. Up to the outbreak of the Civil War, the college was largely attended by Southerners, and the Civil War thus dealt it a doubly heavy blow, from which it began to recover under the long presidency (1868-1888) of James McCosh, who, like his successor, Francis Landey Patton (*q.v.*), president from 1888 to 1902, greatly advanced the material welfare of the college. Fourteen new buildings were erected during Dr McCosh's administration, and the John C. Green School of Science was established in 1873 by the gift of John Cleve Green; and during Dr Patton's administration the enrolment of students more than doubled, as did the number of members of the faculty. In October 1896, on the 150th anniversary of its founding, the official name of the College of New Jersey, long popularly displaced by Princeton, was dropped, and the corporation became "The Trustees of Princeton University," although the institution did not become, in the usual American use of the term, a university, having no professional schools whatever, and only a small post graduate department. On Dr Patton's resignation in 1902 he was succeeded by Woodrow Wilson (*q.v.*), the first layman to become president, who introduced the preceptorial system already described.

PRINCIPAL, a person or thing first, or chief in rank or importance, or, more widely, prominent, leading. The Lat. adj. *principalis*, first, chief, original, also princely, is formed from *princeps*, the first, chief, prince, from *primus*, first, and *capere* to hold. In Late Lat. *principalis* was used as a substitute for an overseer or superintendent, and also for the chief magistrate of a municipality (Symmachus, *Ep.* 9, 1). It is a common title for the head of educational institutions, universities, colleges and schools. It is thus used of the director, of some of the heads of newer universities in England, *e.g.* London and Birmingham, always so in Scotland, and frequently combined with the vice-chancellorship. At the university of Oxford the name occurs twice as the title of the head of a college, *viz.* of Brasenose and Jesus. It was always used of the heads of halls, of which St Edmund Hall alone remains. It is also the designation used of the head of the newer theological or denominational colleges, and also of the women's colleges. At Cambridge it does not occur. In law, it is used in distinction from "accessory," for the person who actually commits the crime, "principal in the first degree," or who is present, aiding and abetting at the commission of the crime," principal in the second degree;" and also for the person for whom another acts by his authority (see **PRINCIPAL AND AGENT** below). Finally as a shortened form of "principal sum," "principal money," &c., the term is used of the original sum lent or invested upon which interest is paid, and so, widely of any capital sum, as opposed to interest or income derived from it.

PRINCIPAL AND AGENT. In law an agent is a person authorized to do some act or acts in the name of another, who is called his principal. The law regulating the relations of principal and agent has its origin in the law of mandate among the Romans, and in England the spirit of that system of jurisprudence pervades this branch of the law. The law of agency is thus almost alike throughout the whole British Empire, and a branch of the British commercial code, in which it is of great importance that different nations should understand each other's system, differs only slightly from the law of the rest of Europe.

In a general view of the law of agency it is necessary to have regard to the rights and duties of the principal, the agent, and the public. The agent should not do what he has no authority

for; yet if he be seen to have authority, those with whom he deals should not be injured by secret and unusual conditions. The employer is bound by what his agent does in his name, but the public are not entitled to take advantage of obligations which are known to be unauthorized and unusual. The agent is entitled to demand performance by the principal of the obligations undertaken by him within the bounds of his commission, but he is not entitled to pledge him with a recklessness which he would certainly avoid in the management of his own affairs. It is in the regulation of these powers and corresponding checks in such a manner that the legal principle shall apply to daily practice, that the niceties of this branch of the law consist.

Agents are of different kinds, according to their stipulated or consuetudinary powers. The main restraint in the possible powers of an agent is in the old maxim, *delegatus non potest delegare*, designed to check the complexity that might be created by inquiries into repeatedly-deputed responsibility. The agent cannot delegate his commission or put another in his place; but in practice this principle is sometimes modified, for it so may arise from the nature of his office that he is to employ other persons for the accomplishment of certain objects. Thus, there is nothing to prevent a commercial agent from sending a portion of the goods entrusted by him to his own agent for disposal.

In the general case agency is constituted by the acceptance of the mandate or authority to act for the principal, and the evidence of this may be either verbal or in writing. The English statute of frauds requires an agent to have authority in writing for the purposes of its 1st, 2nd and 3rd clauses relating to leases. "And it is a general rule, that an agent who has to execute a deed, or to take or give livery or seisin, must be appointed by deed for that purpose. Moreover, as a corporation aggregate can in general act only by deed, its agent must be so appointed, though it would seem that some trifling agencies, even for corporations, may be appointed without one." (Smith's *Mercantile Law*, B. I. ch. iv.). It is a general rule that those obligations which can only be undertaken by solemn formalities cannot be entered on by a delegate who has not received his authority in writing. But it is often constituted, at the same time that its extent is defined, by mere appointment to some known and recognised function—as where one is appointed agent for a banking establishment, factor for a merchant, broker, supercargo, traveller, or attorney. In these cases, usage defines the powers granted to the agent; and the employer will not readily be subjected to obligations going beyond the usual functions of the office; nor will the public dealing with the agent be bound by private instructions inconsistent with its usual character. While, however, the public, ignorant of such secret limitations, are not bound to respect them, the agent himself is liable for the consequences of transgressing them. Agency may also be either created or enlarged by *implication*. What the agent has done with his principal's consent the public are justified in believing him authorized to continue doing. Thus, as a familiar instance, the servant who has continued to purchase goods for his master at a particular shop on credit is presumed to retain authority and trust, and pledges his master's credit in further purchases, though he should, without the knowledge of the shopkeeper, apply the articles to his own uses. The law is ever jealous in admitting as accessories of a general appointment to any particular agency the power to borrow money in the principal's name, to give his name to bill transactions, and to pledge him to guaranties; but all these acts may be authorized by implication, or by being the continuation of a series of transactions, of the same kind and in the same line of business, to which the principal has given his sanction. Thus an employer may, by the previous sanction of such operations, be liable for the bills or notes drawn, indorsed and accepted by his clerk or other mandatary; nay, may be responsible for the obligations thus incurred after the mandatary's dismissal, if the party dealing with him knew that he was countenanced in such transactions, and had no reason to suppose that he was dismissed. In questions of this kind the distinction between a general and a special agent is important. A general agent is employed to

transact all his principal's business of a particular kind, at a certain place—as a factor to buy and sell; a broker to negotiate contracts of a particular kind; an attorney to transact his legal business; a shipmaster to do all things relating to the employment of a ship. Such an agent's power to do everything usual in the line of business in which he is employed is not limited by any private restriction or order unknown to the party with whom he is dealing. On the contrary, it is incumbent on the party dealing with a particular agent, *i.e.* one specially employed in a single transaction, to ascertain the extent of his authority. The law applicable to a mercantile agent's power to pledge or otherwise dispose of the goods entrusted to him being in an unsatisfactory state, a statutory remedy was applied to it by an act of 1825 (6 Geo. IV. c. 94), amended in 1842 (5 & 6 Vict. c. 39) and replaced by the Factors Act 1889.

The obligations of the principal are: to pay the agent's remuneration, or, as it is often called, *commission*, the amount of which is fixed by contract or the usage of trade; to pay all advances made by the agent in the regular course of his employment; and to honour the obligations lawfully undertaken for him. The agent is responsible for the possession of the proper skill and means for carrying out the functions which he undertakes. He must devote to the interests of his employer such care and attention as a man of ordinary prudence bestows on his own—a duty capable of no more certain definition, the application of it as a fixed rule being the function of a jury. He is bound to observe the strictest good faith; and the law even interposes to remove him from temptation to sacrifice his employer's interests to his own (see *COMMISSION: Secret*). Thus, when he is employed to buy, he must not be the seller. When an agent is employed to sell, he must not be the purchaser. He ought only to deal with persons in good credit, but he is not responsible for their absolute solvency unless he guarantee them. A mercantile agent guaranteeing the payments he treats for is said to hold a *del credere* commission.

See also AUCTIONS AND AUCTIONEERS; BROKER; FACTOR; GUARANTEE, &c.; also Smith's *Mercantile Law* (11th ed., 1905); Bowstead, *On Agency* (4th ed., 1909).

PRINGLE, SIR JOHN (1707-1782), British physician, was the younger son of Sir John Pringle, of Stichel, Roxburghshire, and was born on the 10th of April 1707. He was educated at St Andrews, at Edinburgh, and at Leiden. He took the degree of doctor of physic at the last-named university, where he was an intimate friend of G. van Swieten and A. von Haller. He settled in Edinburgh at first as a physician, but after 1734 also acted as professor of moral philosophy in the university. In 1742 he became physician to the earl of Stair, then commanding the British army in Flanders, and in 1744 was appointed by the duke of Cumberland physician-general to the forces in the Low Countries. In 1749, having settled in London, he was made physician in ordinary to the duke of Cumberland; and in 1752 he married a daughter of Dr William Oliver (1695-1764) of Bath, the inventor of "Bath Oliver" biscuits. Subsequently he received other court appointments as physician, and in 1766 was made a baronet. His first book, *Observations on the Nature and Cure of Hospital and Jail Fevers*, was published in 1750, and in the same year he contributed to the *Philosophical Transactions* of the Royal Society three papers on "Experiments on Septic and Antiseptic Substances," which gained him the Copley medal. Two years later he published his important work, *Observations on the Diseases of the Army in Camp and Garrison*, which entitles him to be regarded as the founder of modern military medicine. In November 1772 he was elected president of the Royal Society. In this capacity he delivered six "discourses," which were afterwards collected into a single volume (1783). After passing his seventieth year he resigned his presidency and removed to Edinburgh in 1780, but returned to London in September 1781, and died on the 18th of January following. There is a monument to him in Westminster Abbey, executed by Nollekens.

A *Life of Pringle* by Andrew Kippis is prefixed to the volume containing the *Six Discourses*. The library of the College of Physicians of Edinburgh possesses ten folio volumes of his unedited MSS. including an essay "On Air, Climate, Diet and Exercise." There are *Eloges* on him by Vicq d'Azyr and Condorcet.

PRINGSHEIM, NATHANAEL (1823-1894), German botanist, was born at Wziesko in Silesia, on the 30th of November 1823. He studied at the universities of Breslau, Leipzig, and Berlin successively. He graduated in 1848 as doctor of philosophy with the thesis *De forma et incremento stratorum crassiorum in plantarum cellula*, and rapidly became a leader in the great botanical renaissance of the 19th century. His contributions to scientific algology were of striking interest. Pringsheim was among the very first to demonstrate the occurrence of a sexual process in this class of plants, and he drew from his observations weighty conclusions as to the nature of sexuality. Together with the French investigators G. Thuret and E. Bornet, Pringsheim ranks as the founder of our scientific knowledge of the algae. Among his researches in this field may be mentioned those on *Vaucheria* (1855), the Oedogoniaceae (1855-1858), the Coleochaeteae (1860), *Hydrodictyon* (1861), and *Pandorina* (1866); the last-mentioned memoir bore the title *Beobachtungen über die Paarung de Zoosporen*. This was a discovery of fundamental importance; the conjugation of zoospores was regarded by Pringsheim, with good reason, as the primitive form of sexual reproduction. A work on the course of morphological differentiation in the Sphacelariaceae (1873), a family of marine algae, is of great interest, inasmuch as it treats of evolutionary questions; the author's point of view is that of Naegeli rather than Darwin. Closely connected with Pringsheim's algological work was his long-continued investigation of the Saprolegniaceae, a family of algaoid fungi, some of which have become notorious as the causes of disease in fish. Among his contributions to our knowledge of the higher plants, his exhaustive monograph on the curious genus of water-ferns, *Savinia*, deserves special mention. His career as a morphologist culminated in 1876 with the publication of a memoir on the alternation of generations in thallophytes and mosses. From 1874 to the close of his life Pringsheim's activity was chiefly directed to physiological questions: he published, in a long series of memoirs, a theory of the carbon-assimilation of green plants, the central point of which is the conception of the chlorophyll-pigment as a screen, with the main function of protecting the protoplasm from light-rays which would neutralize its assimilative activity by stimulating too active respiration. This view has not been accepted as offering an adequate explanation of the phenomena. Pringsheim founded in 1858, and edited till his death, the classical *Jahrbuch für wissenschaftliche Botanik*, which still bears his name. He was also founder, in 1882, and first president, of the German Botanical Society. His work was for the most part carried on in his private laboratory in Berlin; he only held a teaching post of importance for four years, 1864-1868, when he was professor at Jena. In early life he was a keen politician on the Liberal side. He died in Berlin on the 6th of October 1894.

A fuller account of Pringsheim's career will be found in *Nature*, (1895) vol. li., and in the *Berichte der deutschen botanischen Gesellschaft*, (1895) vol. xiii. The latter is by his friend and colleague, Ferdinand Cohn. (D. H. S.)

PRINSEP, JAMES (1799-1840), Anglo-Indian scholar and antiquary, was born on the 20th of August 1799. In 1819 he was given an appointment in the Calcutta mint, where he ultimately became assay-master, succeeding H. H. Wilson, whom he likewise succeeded as secretary of the Asiatic Society. Apart from architectural work (chiefly at Benares), his leisure was devoted to Indian inscriptions and numismatics, and he is remembered as the first to decipher and translate the rock edicts of Asoka. Returning to England in 1838 in broken health, he died in London on the 22nd of April 1840. Prinsep's Ghat, an archway on the bank of the Hugli, was erected to his memory by the citizens of Calcutta.

PRINSEP, VALENTINE CAMERON (1838-1904), English artist, was born on the 4th of February 1838. His father, Henry

Thoby Prinsep, who was for sixteen years a member of the Council of India, had settled at Little Holland House, which became a centre of artistic society. Henry Prinsep was an intimate friend of G. F. Watts, under whom his son first studied. Val Prinsep also worked in Paris in the *atelier* Gleyre; and "Taffy" in his friend Du Maurier's novel *Trilby*, is said to have been sketched from him. He was an intimate friend of Millais and of Burne-Jones, with whom he travelled in Italy. He had a share with Rossetti and others in the decoration of the hall of the Oxford Union. He first exhibited at the Royal Academy in 1862 with his "Bianca Capella," his first picture, which attracted marked notice, being a portrait (1866) of General Gordon in Chinese costume; the best of his later exhibits were "À Versailles," "The Emperor Theophilus chooses his Wife," "The Broken Idol" and "The Goose Girl." He was elected A.R.A. in 1879 and R.A. in 1894. In 1877 he went to India and painted a huge picture of the Delhi durbar, exhibited in 1880, and afterwards hung at Buckingham Palace. He married in 1884 Florence, daughter of the well-known collector, Frederick Leyland. Prinsep wrote two plays, *Cousin Dick* and *Monsieur le Duc*, produced at the Court and the St James's theatres respectively; two novels; and *Imperial India: an Artist's Journal* (1879). He was an enthusiastic volunteer, and one of the founders of the Artists' Corps. He died on the 11th of November 1904.

PRINT, the colloquial abbreviation used to describe printed cloths generally, though it is most commonly applied to the staple kinds of cotton goods. The word must be distinguished from "printer," which refers to the regular kinds of cotton cloths intended for printing. (See TEXTILE PRINTING.)

PRINTING (from Lat. *imprimere*, O. Fr. *empreindre*), the art or practice of transferring by pressure, letters, characters or designs upon paper or other incompressible surfaces, usually by means of ink or oily pigment. As thus defined, it includes three entirely different processes: copperplate printing, lithographic or chemical stone-printing, and letterpress printing. The difference between the three lies in the nature or conformation of the surface which is covered with the pigment and afterwards gives a reproduction in reverse on the material impressed. For the nature and method of preparing these surfaces see respectively ENGRAVING (and allied articles), LITHOGRAPHY and TYPOGRAPHY. In copperplate printing the whole of the plate is first inked, the flat surface is then cleaned, leaving ink in the incisions or trenches cut by the engraver, so that, when dampened paper is laid over the plate and pressure is brought to bear, the paper sinks into the incisions and takes up the ink, which makes an impression in line or lines on the paper. In lithographic printing the surface of the stone, which is practically level, is protected by dampening against taking the ink except where the design requires. In letterpress printing the printing surface is in relief, and alone receives the ink, the remainder being protected by its lower level. Before the invention of typography, pages of books, or anything of a broadside nature, were printed from woodcuts, *i.e.* blocks cut with a knife on wood *plankwise*, as distinct from wood engravings which are cut with a burin on the *end* grain, a more modern innovation. These woodcuts, like the lithographic or engraved surface, served one definite purpose only, but in typography the types can be distributed and used again in other combinations.

The term "printing" is often used to include all the various processes that go to make the finished product; but in this article it is properly confined to "press-work," *i.e.* to the work of the printing-press, by which the book, newspaper, or other printed article, when set up in type and ready as a surface to be actually impressed on the paper, is finally converted into the shape in which it is to be issued or published.

History of Printing-press.

Before dealing with modern machinery it will be necessary to consider the historical evolution of the printing-press, especially since the middle of the 19th century, from which point printing machinery has developed in a most remarkable manner.

It is not clear how the first printers struck off their copies, but without doubt Gutenberg did use at an early period in his career a mechanical press of some kind, which was constructed of wood. In fact he could not have produced his famous forty-two line Bible without such aid.

The earliest picture of a press shows roughly the construction to have been that of an upright frame, the power exerted by a movable handle, placed in a screw which was tightened up to secure the requisite impression, and was loosened again after the impression was obtained. The type pages were placed on a flat bed of solid wood or stone, and it was quite a labour to run this bed into its proper position

Wooden Hand-presses.

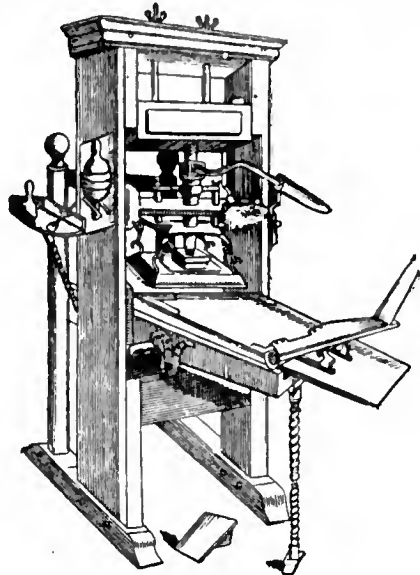

FIG. 1.—Blaeu's Wooden Hand-press.

under the hanging but fixed horizontal plane, called the *platen*, which gave the necessary impress when screwed down by the aid of the movable bar. This labour had to be repeated in order to release the printed sheet and before another copy could be struck off. This same press, with a few modifications, was apparently still in general use till the early part of the 17th century, when Willem Janszon Blaeu (1571-1638) of Amsterdam, who was appointed map maker to the Dutch Republic in 1633, made some substantial improvements in it. Our first authority on printing, Joseph Moxon, in his *Mechanick Exercises, as Applied to the Art of Printing* (vol. i., 1683), says, "There are two sorts of presses in use, viz. the old fashion and the new fashion," and he gives credit to Blaeu for the invention of the new and decidedly improved press (fig. 1).

Blaeu's improvement consisted of putting the spindle of the screw through a square block which was guided in the wooden frame, and from this block the platen was suspended by wires or cords. This block gave a more rigid platen, and at the same time ensured a more equal motion to the screw when actuated by the bar-handle. He also invented a device which allowed the bed on which the type pages were placed to run in and out more readily, thus reducing the great labour involved in that part of the work of the older form of press, and he also used a new kind of iron lever or handle to turn the screw which applied the necessary pressure. The value of these various improvements, which were in details rather than in principles, was speedily recognized, and the press was introduced into England and became known as the "new fashion."

From this it will be observed that in a general way there had only been two kinds of wooden presses in use for a period of no less than three hundred and fifty years, and when the work of some of the early printers is studied, it is marvellous how often good results were obtained from such crude appliances.

The iron press (fig. 2) invented by Charles, 3rd earl Stanhope (1753-1816), at the end of the 18th century was a decided advance on those made of wood. Greater power was obtained

at a smaller expenditure of labour, and it allowed of larger and heavier surfaces being printed. The chief points of the iron press consisted of an improved application of the power to the spindle. The main part of it was the upright frame or staple, of iron; the feet of this staple rested upon two pieces of substantial timber dovetailed into a cross, which formed a base or foundation for the

Iron Hand-presses.

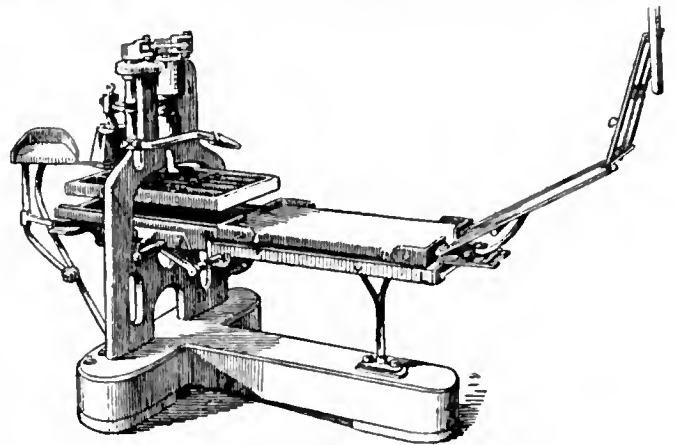

FIG. 2.—The Stanhope Iron Hand-press.

complete press to stand upon. The staple was united at the top and bottom, but the neck and body were left open, the former for the mechanism and the latter for the platen and the bed when run in preparatory to taking the impression. The upper part of the staple, called the nut, answered the same purpose as the head in the older kind of wooden press, and was in fact a box with a female screw in which the screw of the spindle worked. The lower portion of the neck was occupied by a piston and cup, in and on which the toe of the spindle worked. On the near side of the staple was a vertical pillar, termed the arbor, the lower end of which was inserted into the staple at the top of the shoulder—the upper end passing through a top-plate, which being screwed on to the upper part of the staple held it firmly. The extreme upper end of the arbor, which was hexagonal, received a head, which was really a lever of some length; this head was connected by a coupling-bar to a similar lever or head, into which the upper end of the spindle was inserted. The bar by which the power was applied by the pressman was fixed into the arbor, and not into the spindle, so that the lever was the whole width of the press, instead of half, as in Blaeu's wooden press, and it was better placed for the application of the worker's strength. There was also another lever to the arbor head in addition to that of the spindle head; and lastly, the screw itself was so enlarged that it greatly increased the power. The platen was screwed on to the under surface of the spindle; the table or bed had slides underneath which moved in, and not on, ribs as in the older form of press, and was run in and out by means of strips of webbing fastened to each end and passed round a drum or wheel. As the platen was very heavy the operator was assisted in raising it from the type-forme by a balance weight suspended upon a hooked lever at the back of the press. This somewhat counterbalanced the weight of the platen, raised it after the impression had been taken, and brought the bar-handle back again to its original position, ready for another pull.

The Stanhope press, which is still in use, was soon followed by other hand-presses made of iron, with varying changes of details. The most successful of these were the Albion and Columbian presses, the former of English manufacture, and the latter invented (1816) by an American, George Clymer (1754-1834), of Philadelphia.

The *Albion press* (fig. 3), which was designed by Richard Whittaker Cope, was afterwards much improved upon by John Hopkinson (1840-1808). It is still used where hand printing prevails, and it was this form of press which was employed by William Morris at his famous, but short-lived, Kelmscott Press.

in the production of many sumptuous books, the most celebrated of which was the *Chaucer*, a large folio volume, illustrated by Sir Edward Burne-Jones. The chief characteristics of the Albion are its lightness of build and its ease in running; the pull is short, the power great, and the means whereby it is attained so simple that the press does not readily get out of order. It is easily taken to pieces for cleaning, and readily re-erected. The power is obtained by pulling the bar-handle across, which causes

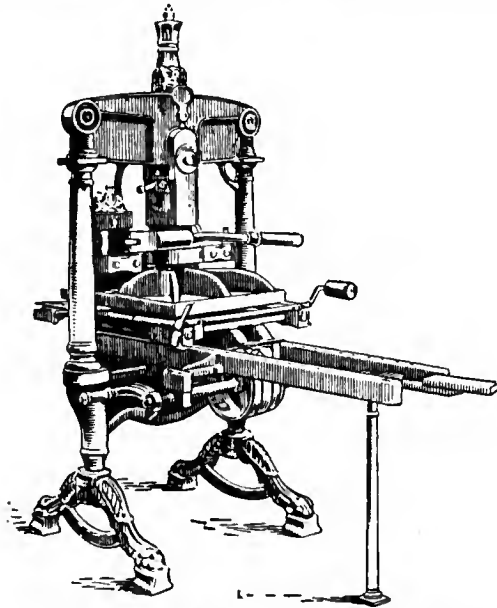

FIG. 3.—Payne & Sons' Albion Hand-press.

an inclined piece of wedge-shaped steel, called the chill, to become perpendicular; in so doing the platen is forced down, and the impression takes place at the moment the chill is brought into a vertical position. On the return of the bar the platen is raised by a spiral spring, placed in a box and fixed at the head of the press. The larger sizes of these presses usually print a sheet of double crown, measuring 30×20 in.

Although the Columbian is not so much in demand as the Albion, it is still employed for heavy hand-work because of its greater stability and power. This power is acquired by a very massive lever, moving on a pivot bolt in the top of the near side of the staple, and passing across the press to the further side of the frame, at which end the power is applied through the coupling-bar by a bar-handle working from the near side. The platen is attached to the centre of the lever by a square bar of iron, and its vertical descent is assured by two projecting guides, one from each cheek; it is then raised from the type-forme, and the iron bar carried back by two levers—the one attached to and above the head and weighted with the eagle; the other behind the press, attached to the arm to which the coupling-bar is fixed, and which also has a weight at the end. The great power of this press adapts it to the working of large and solid formes in printing, but it is somewhat slower in action than the Albion press, which is both lighter in construction and quicker in working.

The average output of the modern hand-press, when all is made ready for running, is about two hundred and fifty impressions per hour. This number, it should be said, is the product of two men who work together as "partners." One inks the type-forme and keeps a sharp look-out for any inequality of inking, and sees generally that the work is being turned out in a workmanlike manner. The other lays on the sheet to certain marks, runs the carriage in under the platen, and pulls the bar-handle across to give the necessary impression. He then runs back the carriage and takes out the printed sheet, which he replaces by another sheet, and repeats the different operations for the next impression. During the interval between taking off the printed sheet and laying on the next one his partner inks

the type surface with a roller which carries just sufficient ink properly distributed to preserve uniformity of "colour."

Having dealt with hand-presses, we must now go back to the end of the 18th century, when the first experiments were made to devise some mechanical means of producing larger printed sheets, and at a quicker rate. In England the broad distinction between "presses" and "machines" is generally considered to rest in the fact that the former are worked by hand, and the latter by steam, gas or electricity; and the men who work by these two methods are called respectively "pressmen" and "machine minders" or "machine managers." But in America the terms "presses" and "pressmen" are universally applied to machines and the men who operate them. For the purposes of this article presses and machines are used as synonymous terms.

Various schemes had been propounded with a view of increasing the output of the hand-press, and in 1790 William Nicholson (1753-1815) evolved his ideas on the *The First Cylinder Machine* subject, which were suggestions rather than definite inventions. Nicholson was not a printer, but, as he was an author and editor, it is presumed that he had some knowledge of printing. His proposals were to print from type placed either on a flat bed or a cylinder, and the impression was to be given by another cylinder covered with some suitable material, the paper being fed in between the type and the impression cylinder, and the ink applied by rollers covered with cloth or leather, or both. While Nicholson's schemes did not bear any practical result they certainly helped others later on. His suggestion to print from type made wedge-shaped (that is, smaller at the foot and wider at the top) to allow of its being so fixed on a cylinder that it would radiate from the centre and thus present an even printing surface, was adopted later by Applegath and others, and really was the first conception of printing on the rotary principle which has now been brought to such perfection.

It was left to Friedrich König (1774-1833), a German, to produce the first really practical printing machine. His invention was to print type placed on a flat bed, the impression being given by a large cylinder, under which the type passed, but his inking appliances were not satisfactory. He induced the proprietor of *The Times* (London) to take two of these machines, and in 1814 that newspaper was printed with steam power at the rate of 1100 impressions per hour, a great advance on the number produced up to that time. Both Nicholson's and König's machines printed only one side at a time—the second or backing printing being a separate and distinct operation—but they really embodied the general principles on which all other machines have been constructed or modelled.

It will be understood that Nicholson's theories were to print both from the flat and from type arranged in circular or cylinder form. These two principles are defined as *reciprocating*, for the flat bed which travels backwards and forwards; and *rotary*, for that which continuously revolves or rotates. König's invention was a reciprocating one.

Two other classes of presses of somewhat different design were largely in operation in the middle of the 19th century—the "double platen," which still printed only one side at each impression from each end, and the "perfecting machine," which was made with two large cylinders and printed from two type-formes placed on separate beds. Although the latter machine turned out sheets printed on both sides before it delivered them (hence its name), the second impression was still a distinct operation. The double platen press was somewhat analogous to the hand-press, both the type beds and impressions being flat. A machine of this kind, if it printed a sheet of double demy, which measures 35×22½ in., was about 13 ft. in length, and the platen itself, of very massive construction, was placed in the centre. This platen had a perpendicular motion, being guided in grooves and worked by a connecting rod fixed to a cross beam and crank, which acquired its motion from the main shaft. There were two type beds and two inking tables, which travelled backwards and forwards, and one platen only, situated in the middle of the machine,

which in turn gave the needful impression as the type-formes passed underneath. The sheets were laid or fed to certain marks between the frisket and tympan, and when these were closed together the carriage was propelled under the platen and the impression was given to that portion of the machine, while at the other end another sheet was being fed in ready to receive its impression in due course.

It was once thought that the finest work could not be produced by a cylinder impressing a surface in the progress of its reciprocating motion, but that it was likely to give a slurred or blurred impression. This is why machines of flat construction were so long employed for the best class of work. But cylinder presses are now made so truly turned, and geared to such nicety, that this idea no longer prevails. The cylinder press is able to produce generally quite as good work as the double platen, its speed is much greater, and it requires a smaller amount of power to drive it.

The perfecting machine has had a great vogue, and has been much improved from time to time, especially in America, though the two-revolution machine in recent years superseded it, whether temporarily or not being still uncertain. We shall deal with it more fully below in relation to the modern and more complicated class of machinery; and this also applies to the ordinary stop or single cylinder, and small platen machines, both of which have been in use many years, and are still in demand.

Before the general introduction of rotary machines which print from curved stereotype plates from an endless web or reel of paper (see below), several other presses of a revolving character were made, to some extent based on Nicholson's ideas. The first printing surface used was ordinary type, because the difficulty of curving the stereotype plates had not been surmounted. This type was fixed, both in vertical and in perpendicular positions, upon a cylinder, round which rotated other cylinders, which held and compressed the sheets against the larger one, which also revolved and carried the printing surface. These machines were made to print several sheets at a time, and were called four-, six-, eight- or ten-feeders, according to the number of sheets fed in and printed. They necessitated a great deal of labour, because each feed required a separate layer-on and taker-off besides the superintending printer, and other hands to carry away the sheets as fast as they accumulated at the different taking-off boards. Besides, these sheets all had to be folded by hand. In this class of machine various improvements were made from time to time by different manufacturers, each profiting by the experiences of the others, and two kinds of such revolving presses may now be given as examples.

After many experiments Augustus Applegath (1789-1871) in 1848 constructed for *The Times* (London), a machine which was an eight-feeder, built entirely on the cylindrical principle, the cylinders placed not in a horizontal but in a vertical position. The type was fixed on a large cylinder, and instead of the printing surface presenting a complete circle, the different columns were each arranged so as to form a polygon. Around this large type cylinder were eight smaller ones, all upright, for taking the impression for each of the eight sheets fed in separately, and rollers were so arranged as to apply the ink to the type as it passed alternately from one impression cylinder to the other. The sheets were laid in from eight different feed-boards, placed horizontally, and they passed through tapes, when they were seized by another series of tapes and then turned sideways between their corresponding impression and type cylinder, thus obtaining sheets printed on one side only. The impression cylinder then delivered the sheets separately (still in a vertical position) into the hands of the boys employed as takers-off. The results from this press were, at the time, considered fairly satisfactory, the number of copies (about 8000) printed per hour from one type-forme having been materially increased by the employing of the eight different stations to feed the sheets in, all of which in turn were printed from the same single type surface.

About 1845 Robert Hoe & Co. of New York, and subsequently of London, had constructed, to meet the increased demands of newspapers, the "Hoe Type Revolving Machine," one good point of which was an apparatus for securely fastening in the type on a large central cylinder fixed horizontally. This was accomplished by the construction of cast-iron beds, one for each separate page (not column, as in Applegath's machine). The column rules were made tapering towards the feet of the type, and the type was securely locked in on these beds so that it could be held firmly in the required position to form a complete circle, thus allowing the cylinder to revolve at a greater speed than Applegath's, which was polygonal. Around the large type cylinders were placed the smaller impression cylinders, the number of these being governed by the output required. Hoe's first presses were four-feeders, but as many as ten feeds were supplied, as in the case of the two presses built to replace the Applegath machine for *The Times*, each of which produced about 2000 impressions from each feed, making a total of 20,000 per hour, printed on one side, or from two machines 20,000 sheets printed on both sides. As will be observed, the only differences in principle between these two type revolving machines were in the positions of the respective cylinders, and the fixing of the type to form a printing surface.

It was Sir Rowland Hill who first suggested the possibilities of a press which should print both sides at once, from a roll or reel of paper. This was about 1825, but it was William A. Bullock (1813-1867) of Philadelphia who in 1865 invented the first machine to print from a continuous web of paper. This machine had two pairs of cylinders, that is, two type or stereotype cylinders, and two others which gave the impression as the web passed between. The second impression cylinder was made somewhat larger so as to give a greater tympan surface, to lessen the off-set from the side first printed. In his machine the stereotype plates were not made to fill the whole periphery of the forme cylinders so as to allow of the sheets being cut before printing, a difficulty which the first machines did not satisfactorily overcome. The sheets were severed by knives placed on the cylinders, and when cut were carried by grippers and tapes; and delivery was made by means of automatic metal fingers fixed upon endless belts at such distances apart as to seize each sheet in succession as it left the last printing cylinder. These presses were not at first reliable in working, especially in the cutting and delivery of the sheets after printing, but were finally so far improved that the Bullock press came into quite general use. The inventor was killed by being caught in the driving belt of one of his own presses.

Modern Presses.

The machines invented during the second half of the 19th century and still in general use, are best classified as follows:—

1. *The iron hand-press*, such as the Albion or the Columbian, used for the pulling of proofs, or for the printing of limited *éditions de luxe*.
2. *Small platen machines* (worked by foot or power) used for the printing of cards, circulars and small jobbing or commercial work.
3. *Single cylinder machines* (in England generally called "Wharfedales"), usually built on the "stop" cylinder principle, and printing one side of the sheet only.
4. *Perfecting machines*, usually with two cylinders, and printing or "perfecting" both sides of a sheet before it leaves the machine, but with two distinct operations.
5. *Two-revolution machines*, which, although with but one cylinder, have largely superseded perfecting machines, as their output has been increased and the quality of their work compares favourably with that of the average two-cylinder.
6. *Two-colour machines*, usually made with one feed, that is, with only one cylinder, but with two printing surfaces, and two sets of inking apparatus one at each end of the machine. Occasionally these machines are made with two cylinders.
7. *Rotary machines*, printing from an endless web of paper from curved stereotype or electrotpe plates, principally used

Classification of Modern Presses and Machines.

for newspaper or periodical work. They are made to print upon a single reel, or upon two, four, six or even eight reels, in both single or double widths, *i.e.* two or four pages wide.

The hand-press has already been sufficiently described, and we may proceed to deal with the other classes.

The small but useful platen machine (fig. 4) is very largely employed in those printing-houses that make commercial work a speciality. The smaller machines can be worked with the foot, but if the establishment is equipped with power it is customary to gear them for driving. The larger machines require power. As its name implies, the type bed and impression platen are both flat surfaces as in the hand-press, but as they are self-inking and are easily driven, the

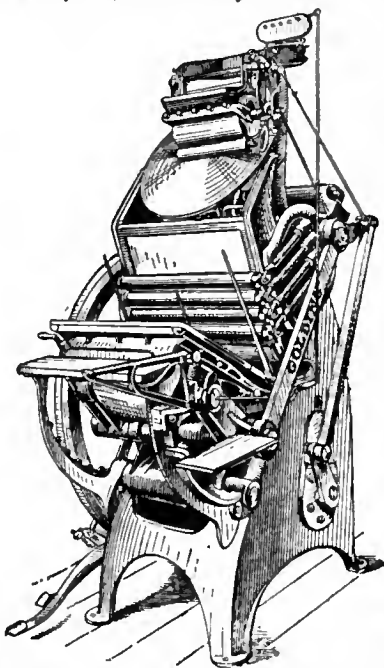

FIG. 4.—The Golding Jobber Platen Machine.

average output is about 1000 copies per hour, and but one operator is required, whereas two men at a hand-press can produce only 250 copies in the same time. In design these platen presses usually consist of a square frame with a driving shaft fixed horizontally across the centre of it. This shaft is attached to a large fly-wheel which gives impetus to the press when started and assists in carrying over the impression when the platen is in contact with the printing surface. The type-forme is usually fixed in an almost vertical and stationary position, and it is the platen on which the sheet is laid which rises from the horizontal position to the vertical in order to give the necessary impact to produce a printed impression from the type-forme. Practically this platen is, as it were, hinged at the off side, nearest the type bed, and its rise and fall is effected by the use of two arms, one on each side of the platen, which derive an eccentric motion from

cams geared in connexion with the shaft. When the sheet is printed and the platen falls back to the horizontal the operator removes it with one hand and with the other lays on a fresh sheet. Generally the larger of these machines will print a sheet up to 21 x 16 in. The modern single or "stop" cylinder, quite different in construction from the old single cylinder machines, largely succeeded the double platen machine. The principle of the stop cylinder was really a French invention, but it has been more commonly adopted in Great Britain, where the machines are known as "Wharfedales" (fig. 5). They are much

"Wharfedale" Machines.

used for the printing of books and commercial work. The average production is about 1000 copies per hour. The type bed travels with a reciprocating motion upon rollers or runners made of steel, the bed being driven by a simple crank motion, starting and stopping without much noise or vibration. All the running parts are made of hard steel. The cylinder is "stopped" by a cam motion while the bed is travelling backward, and during this interval the sheet to be printed is laid against the "marks," and the gripper closes on it before the cylinder is released, thus ensuring great accuracy of lay, and consequent good register. After the impression is made the sheet is seized by another set of fingers and is transferred to a second and smaller cylinder over the larger one, and this smaller cylinder or drum delivers the sheet to the "flyer," or delivery apparatus, which in turn deposits it upon the table. The inking arrangements are usually very good, for, by a system of racks and cogs which may be regulated to a nicety, the necessary distribution of ink and rolling of the printing surface runs in gear with the travelling type bed or coffin. All the accessories for inking are placed at the end of the machine, the ink itself being supplied from a ductor, which can be so regulated by the keys attached to it as to let out the precise amount of pigment required. The ink passes to a small solid metal roller, and is then conveyed by a vibrating roller made of composition to a larger and hollow metal cylinder or drum which distributes the ink for the first time. This revolves with the run of the machine and at the same time has a slight reciprocating action which helps the distribution. A second vibrating composition roller conveys the ink from this drum to the distributing table or ink slab, on which other rollers, called distributors, still further thin out the ink. As the type bed travels, larger composition rollers, called inkers, placed near the cylinder, adjusted to the requisite pressure on the type, pick up the necessary amount of ink for each impression and convey it to the type as it passes under them. Usually three or four such rollers are required to ink the forme.

The perfecting machine is so named because it produces sheets printed on both sides or, in technical language, "perfected." This operation is performed by two distinct printings. This class of machine has been in use a great many years, *Perfecting Machines*, although both the stop-cylinder and the two-revolution press have to some extent superseded it. It is perhaps best adapted for the printing of newspapers or magazines having circulations that do not require rotary machines intended for long runs. Although some perfecting machines have been made with one cylinder only, which reverses itself on the old "tumbler" principle, they now are made with two cylinders, and it is with this class that we are particularly concerned. There are various makes of perfecting machines of which the Dryden & Foord is shown in fig. 6; among the best recent typed is the Huber Perfecter.

Although the two-type beds have a reciprocating motion, as in the ordinary one-sided press, the two cylinders rotate towards each other. The frame of the machine, owing to the fact that it contains two carriages and a double inking apparatus, is long, the exact size depending on the size of the sheet to be printed. Close to the large cylinders are the inking rollers, which take the necessary amount of ink, each set from its own slab as it passes under, and these rollers convey the requisite ink to the printing surface as the forme-carriage runs under its own cylinder. The distinctive feature is the ingenious manner in which the sheets are printed first on one side, and then on the other. This is performed by carrying them over a series of smaller cylinders or drums by means of tapes. The pile of sheets

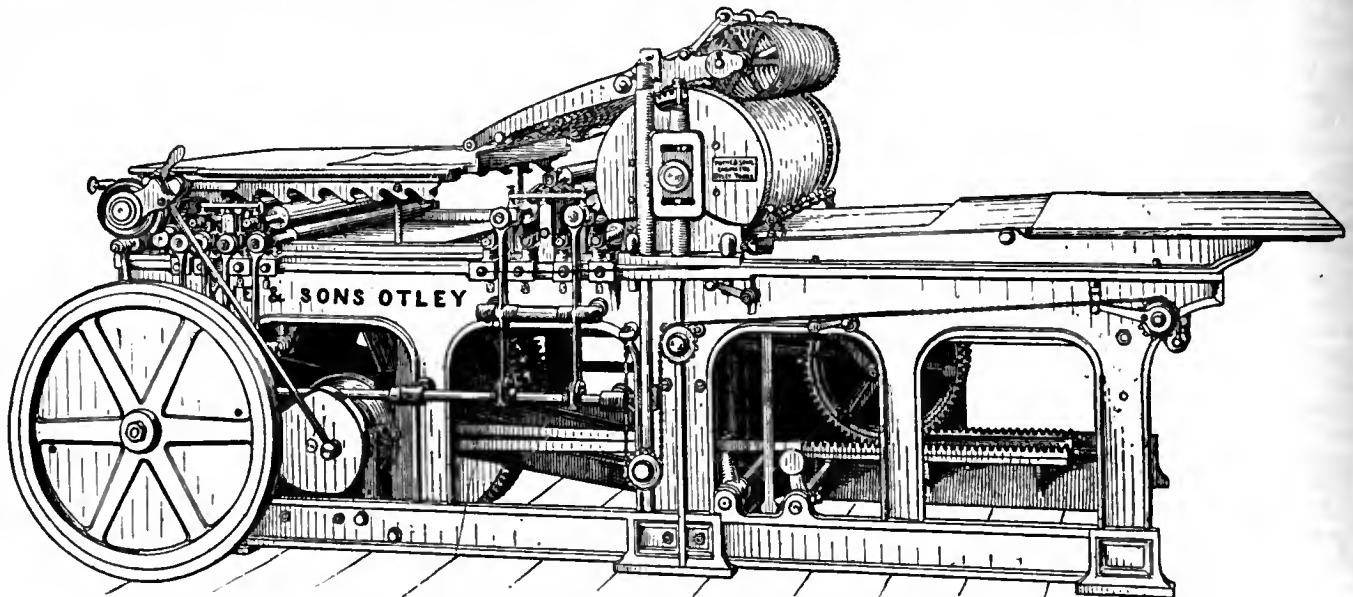

FIG. 5.—Payne & Sons' Wharfedale Stop-Cylinder Machine.

to be fed in stands on a high board at one end. The sheet is laid to its mark and is conveyed round an entry drum; thence it is carried round the first impression cylinder, and under this, moving at the same speed as the cylinder, is the type bed containing the inner

of broad tapes which lie on the laying-on board and are fastened to a small drum underneath it. This drum has a series of small cogs which move the web or tapes in the same direction. The sheet is laid to a back mark on the tapes, and is propelled between two rollers

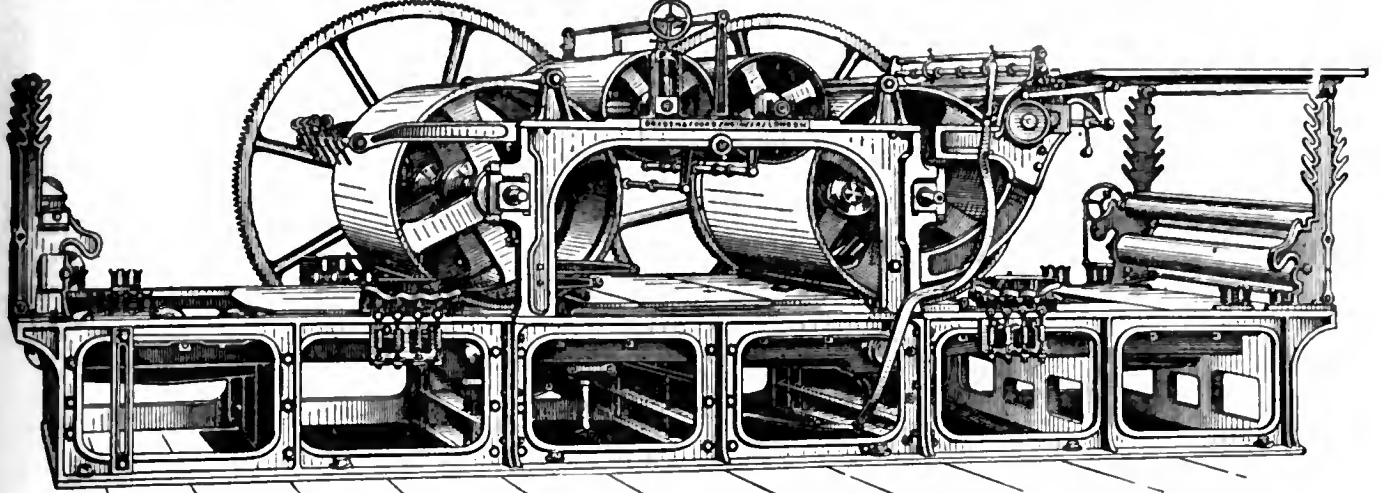

FIG. 6.—Dryden & Foord's Perfecting (two-cylinders) Machine.

forme already inked. The paper then receives its impression on the first side. In the older type of machine it is next led up to the right-hand one of the two reversing drums, which are placed above the large printing cylinders, and over which it passes with the printed side downwards. It is then brought under the second or left-hand drum, and so on to the other large impression cylinder, with the blank side of the sheet exposed to the type of the outer forme on the table underneath. Thus it will be seen that the sheet is reversed in its travel between the first and second large cylinders which give the impression. The sheet is then finally run out and delivered in the space between the two large cylinders, and laid on the delivery board—usually with the aid of flyers. In the more recent type of

direct into the machine. Another variety employs grippers somewhat after the manner of the ordinary single cylinder. The Anglo-French perfecting machine is one of that class. As a rule most double-cylinder presses produce on an average about 1000 copies per hour, printed both sides.

The two-revolution machine is another one-cylinder machine built on the reciprocating principle. Its speed is greater than the stop cylinder (it may be geared to produce from 1500 to 2000 copies per hour, printed one side only). The *Two-Revolution Machines.* The Miehle (fig. 7), which is of American design but now made also in Great Britain, is a good example of this kind of machine and is much used, especially for illustrated work. It has

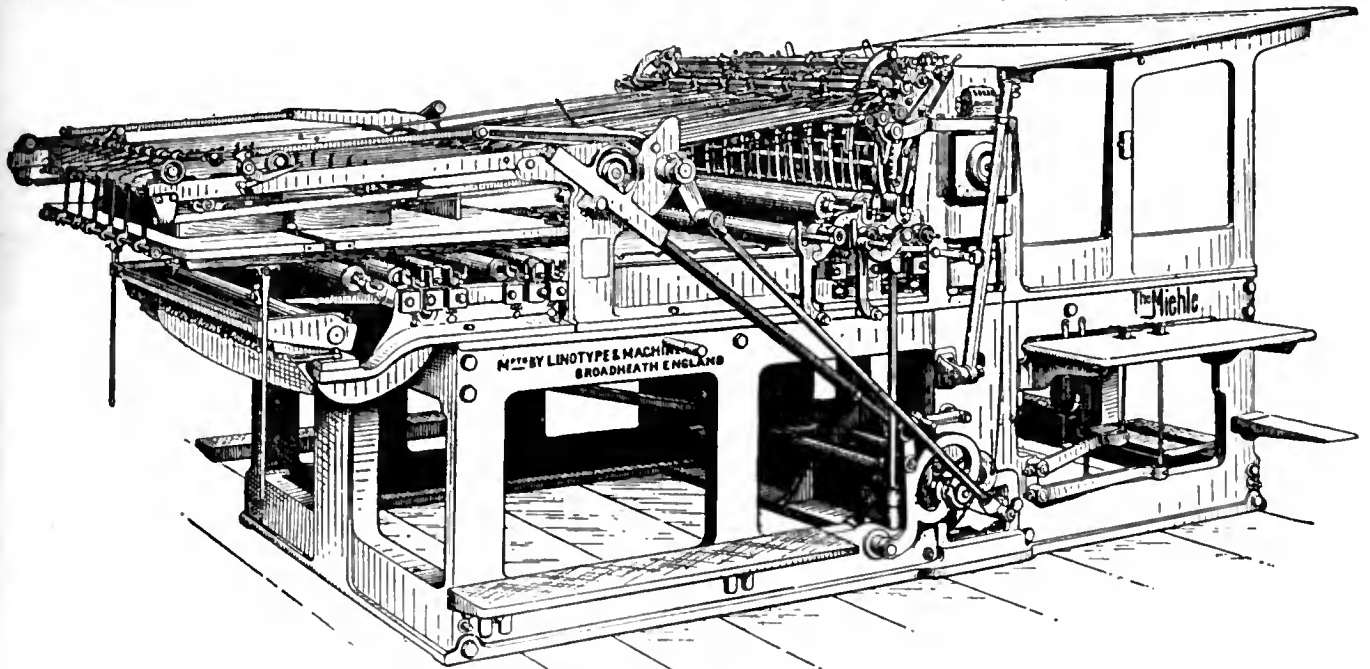

FIG. 7.—The Miehle Two-revolution Cylinder Machine.

perfecting machines the sheet is fed directly into grippers, change taking place when grippers on each cylinder meet, the outer forme grippers taking the sheet from the inner forme grippers.

This is a general description of the principles on which these machines are built, but, as in other classes, there are many variations in details. For example, there are the drop-bar, the web and the gripper methods of feeding these presses. In the first case a bar descends upon the paper after it is laid to point marks, and this bar, having a rotary motion, runs the sheet between a roller and a small drum into the machine. The web arrangement consists of a series

of the high over-feedboard, and the taking-off apparatus is automatic but on a different plan from that of the ordinary Wharfedale, the sheets being carried over tapes with the freshly-printed side uppermost, thus preventing smearing; they are then carried on to the heap or pile by the frame or long arms placed at the end of the machine. A recent feature of this machine is the tandem equipment, whereby two, three or even four machines may be coupled together for colour work. Only one layer-on is required and register is obtained automatically throughout.

The principle of the two-revolution press is that the cylinder

always rotates in the same direction, and twice for each copy given, once for the actual impression, and again to allow of the return of the forme-carriage in its reciprocating action. This also allows time for the feeding in of the next sheet to be printed. Among other advantages claimed for this press one is that the movement which governs the action of the type bed in reversing is so arranged that the strain which sometimes occurs in other reciprocating machines is considerably reduced; another is that the registering or correct backing of the pages on the second side in printing is uncommonly good; but this depends much upon the layer-on. In many of the old kinds of two-revolution machines, owing to the cylinder being geared separately from the type bed, it was apt to be occasionally thrown out, but in the Miehle, for instance, it is only out of gear in reversing, and in gear while printing. Great strength is imparted to the frame, and the type bed is particularly rigid. These points, together with a truly turned and polished cylinder, with carefully planned means of adjustment, much simplify the preparation of making-ready of any kind of type-forme or blocks for printing, which is carried out much in the same way as on the ordinary single cylinder, but in a more convenient manner. Many of these machines are made to print four double crowns, 60 X 40 in., or even larger.

continuously rotate, the web of paper travelling in and out, in a serpentine manner, between various cylinders of two characters—one (the type cylinders) carrying the surface to be impressed, usually curved stereotype plates, and the other (the impression cylinders) giving the desired impression. Such a press, if driven by electric power, is set in motion by merely pushing a button or small switch, a bell first giving warning of the press being about to move. The number of duplicate sets of stereotype plates to be worked from by these presses is determined by the size and number of the pages to be printed, and this in turn is regulated by the capacity of the machine.

As already explained, the forerunners of the rotary presses of the present day were the type-revolving printing-machines, and, whilst they were still being used, experiments were being made to cast curved stereotype plates which would facilitate and simplify the work of producing newspapers. This was successfully accomplished by the use of flexible paper matrices, from which metal plates could be cast in shaped moulds to any desired curve. These plates were then fixed on the beds of the Hoe type revolving machine, which were adapted to receive them instead of the movable type-formes previously used. This new method enabled the printers

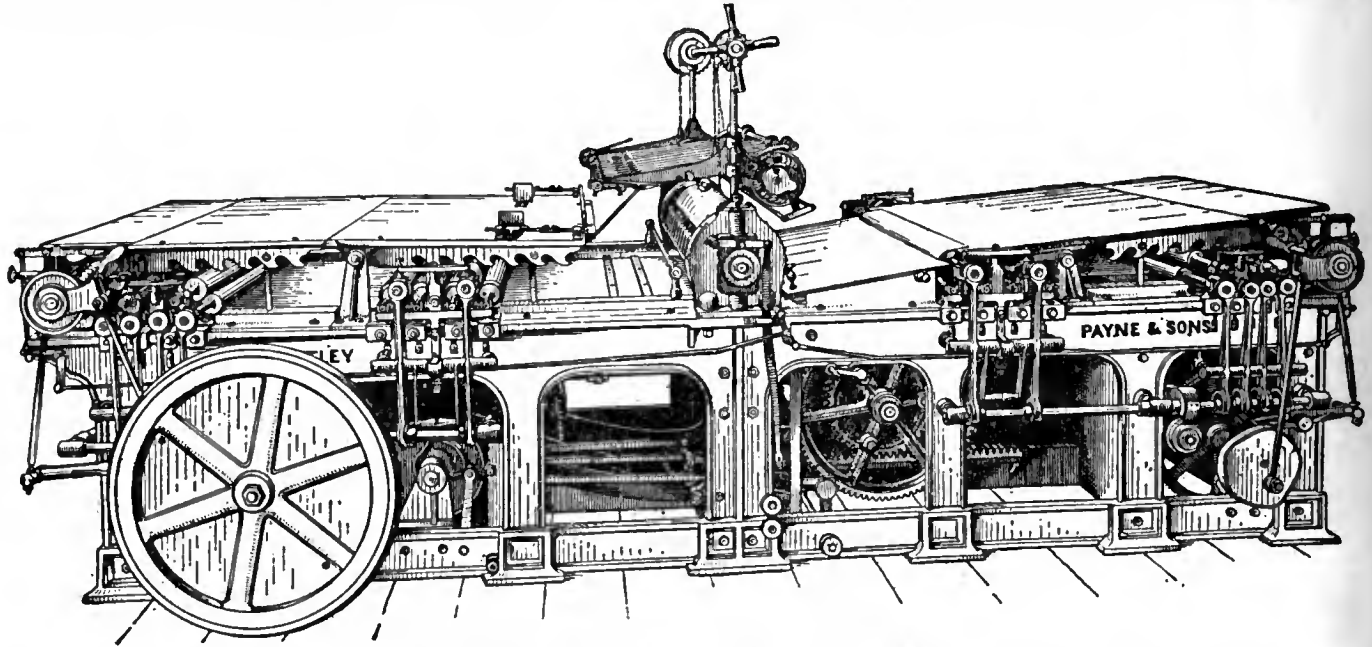

FIG. 8.—Payne & Sons' Two-colour Single Cylinder Machine.

The two-colour machine is generally a single cylinder (fig. 8) with one feed only, and the bed motion reciprocating. The two colours are printed each at one revolution from the two type-formes as they pass under the cylinder, which rotates twice in its travel. A double inking apparatus is of course necessary, and the inking arrangements are placed at the two extreme ends of the machine. In comparison with the ordinary single cylinder the two-colour machine is built with a longer frame, as is necessary to allow the two type-formes to pass under the cylinder, both in its travel forward and on its return. This cylinder on its return is stationary, in fact it might be called a double or rather an alternative stop-cylinder machine, with the inking facilities arranged somewhat on the same plan as on either a two-feeder or a perfecting machine. These two-colour presses are intended only for long runs, short runs may be worked to advantage separately on the ordinary single-colour machine. Generally, with the exception just mentioned, the machine is much the same as the ordinary stop or Wharfedale.

Before leaving the subject of printing with the reciprocating bed-motion, it may be mentioned that although in all modern machines of that kind the printed sheet is self-delivered, the imprinted paper has generally been fed in by hand, and for some classes of work this is still done. But many automatic feeders have been invented from time to time, which for the many purposes for which they are suitable must be reckoned part of a modern printing establishment.

As distinct from flat bed printing with a reciprocating motion, printing on rotary principles is a most interesting study, and it is this department of printing mechanics which has developed so very much in recent years. It seems almost as though this branch had reached its limit, and as though any further developments can only be a question of duplication of the existing facilities so as to print from a greater number of cylinders than, say, an octuple machine. This would be merely a matter of building a higher machine so as to take a larger number of reels arranged in decks. As the name implies, these presses are so constructed that both printing surfaces and paper

to duplicate the type pages and to run several machines at the same time, thus producing copies with far greater rapidity. In some large offices as many as five machines were in constant use. About this period the English stamp duty on printed matter was repealed, and this materially aided the development of the newspaper press.

Subsequently the proprietors of *The Times* made various experiments with a view to making a rotary perfecting press, and as a result started the first one about 1868. It was somewhat similar in design to the Bullock press, so far as the printing apparatus was concerned, except that the cylinders were all of one size and placed one above the other. The sheets were severed after printing, brought up by tapes, and carried down to a sheet flyer, which moved backwards and forwards, and the sheets were alternately "flown" into the hands of two boys seated opposite each other on either side of the flyers. Hippolyte Marinoni (1823-1904), of Paris, also devised a machine on a somewhat similar principle, making the impression and type cylinders of one size and placing them one over the other. About 1870 an English rotary machine called the "Victory" was invented by Messrs Duncan & Wilson. It printed from the web, and had a folder attached. An improved form of this machine is still in use. This machine had separate fly-boards for the delivery of the sheets. In 1871 Messrs Hoe & Co. again turned their attention to the construction of a rotary perfecting press to print from the reel or continuous web of paper, and from stereotype plates fastened to the cylinder.

The rotary presses in use at the present time are indeed wonderful specimens of mechanical ingenuity, all the various operations of damping (when necessary), feeding, printing (both sides), cutting, folding, pasting, wrapping (when required) and counting being purely automatic. These machines are of various kinds, and are specially made to order so as to cope with the particular class of work in view. They may be built on the "deck" principle of two, three, four, or even more reels of paper, and either in single width (two pages wide), or double width (four pages wide). Single and two-reel machines are generally constructed on the "straight line" principle, i.e. arranged with the paper at one end of the machine,

and passing through the cylinders to the folder at the other end where the copies are delivered. Three- and four-reel machines have also been constructed on the same principle, but the more usual arrangement of the four-reel press is to place two reels at either end, with the folders and delivery boards in the centre. This makes it possible to operate them as independent machines, or to run in combination with each other.

When presses are made in double width a two-reel machine is known as a quadruple, a three-reel as a sextuple, and a four-reel as an octuple machine. Double sextuple and double octuple machines are made, having six and eight reels respectively. The quadruple machine is a favourite one and is perhaps most in demand for newspaper work. This press prints from two reels of the double width. The first reel is placed to the right of the machine near the floor, and the second at the back of the machine and at right angles to it. A quadruple machine will produce 48,000 copies per hour of four, six or eight pages; and proportionately less of a greater number of pages; all folded, counted and pasted if required. The four cylinders, which are on the right-hand side of the press, are respectively the

plates, four pages on each type cylinder, making a total of thirty-two pages in all. Each press produces of that number of pages 50,000 copies per hour, printed both sides, cut, folded and counted off in quires complete; by increasing the sets of stereotype pages the same machine will produce 100,000 copies per hour of sixteen pages, and by duplicating the folding and delivery apparatus, 200,000 copies of eight pages of the same size. This mammoth press measures 54 ft. in length, 19 ft. in height and 12 ft. across; its dead weight is about 110 tons, and roughly 100,000 different pieces of metal were used in its construction. The rough cost of such a machine is probably about £18,000. Such a press requires two 55 h.p. motors, one at each end, to drive it. The press is practically four quadruple machines built together, each of which can be worked independently of the other. The paper is fed from reels placed at the two ends in decks, one above the other, each reel containing about five miles of paper, and weighing about fourteen hundredweight. The process of unwinding these long reels of paper in the course of printing takes only half an hour; they are arranged on a revolving stand so that directly they are

Octuple Rotary Machines.

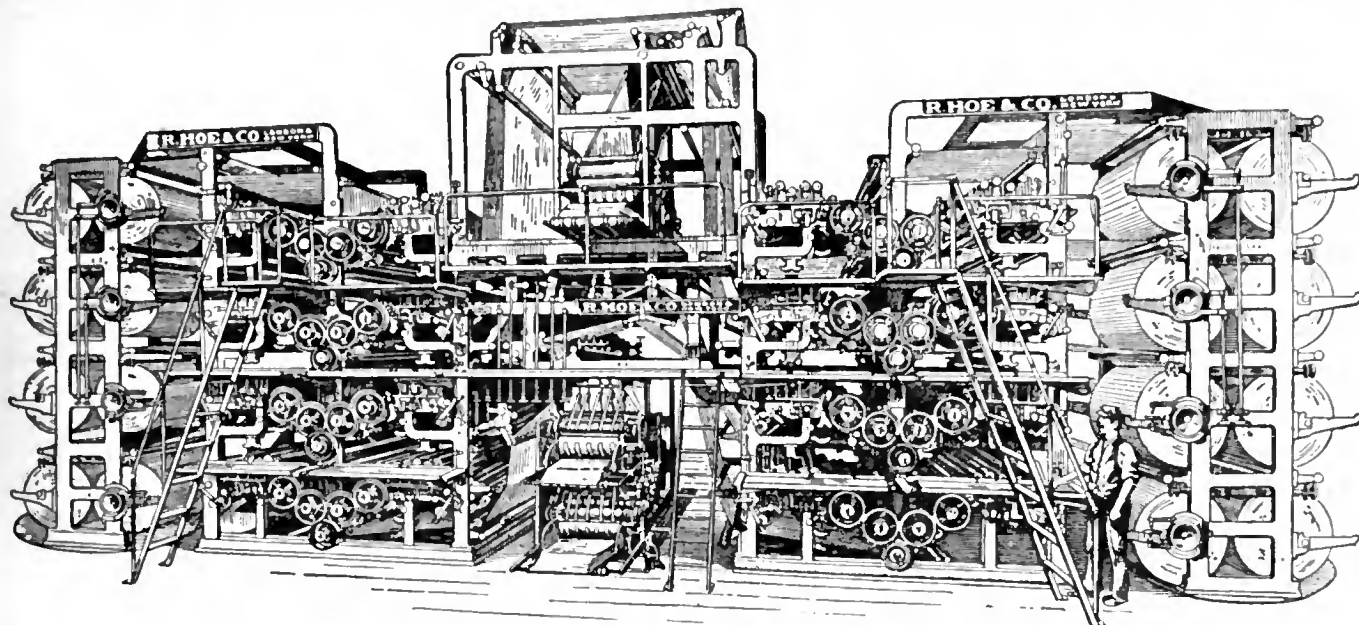

FIG. 9.—Hoe's Double Octuple Rotary Machine.

printing and impression cylinders—the two inside ones being those giving the impression, and the two outer ones bearing the printing surfaces. The inking arrangements are placed at the two extreme ends of these four drums or cylinders, thus being near the type surfaces in each case. As the paper is unwound from the reel below it travels between the first two cylinders when it is printed on the first side; it then passes to the third and fourth cylinders, which give it the second backing side, thus "perfecting" the printed sheet. From this point the long sheet is carried overhead to the left-hand side of the machine, where it is cut longitudinally and divided, and then associated with the other web similarly printed by the other half of the press. They then descend into the two different folders, where they are folded and cut—the copies being discharged on to the delivery boards situated at the two sides of the left-hand portion of the machine, and each quire is counted or told off by being jogged forward. This description applies to one half of the machine only, for while this is in operation the same thing is being repeated by the other half situated at the back.

Another machine, somewhat complex but quite complete in itself, is that constructed by Messrs Robert Hoe & Co. in London from drawings and patterns sent over from New York, for weekly papers of large circulation. Double sets of plates are placed on the main machine, which is capable of taking twenty-four pages, but by using narrower rolls the number of pages may be reduced to either sixteen or twenty if a smaller paper is desired. In addition to the body of the paper it prints a cover, and is capable of producing 24,000 complete copies per hour, folded, insetted, cut, pasted and covered. That portion of the machine which prints the cover is fed from a narrower reel of a different colour of paper from that used for the inside pages. The printing surface for one side of the cover is placed at one end of the cylinder and the reverse side is placed at the other end. This ingenious combination results in the printing of one cover for every copy of the paper.

The double octuple machines (fig. 9) erected by the same firm for the printing of *Lloyd's Weekly News* were probably, in 1908, the latest development in rotary printing. These presses print from eight different reels of the double width, four placed at each end of the machine, the delivery being in the centre, and from eight sets of

spent the stand is turned half way round, and four other full reels already in position are presented ready to be run into the press. This ingenious arrangement, whereby the reels can be changed in about three minutes, obviates the loss of time previously incurred by the press being kept standing while the empty spindles were removed and replaced with four full reels.

Having described some representative types of the different classes of printing-presses in use, we may now treat of the methods employed by the workmen in securing the best results in printing. The real art of printing, as far as presswork is concerned, lies in the careful preparation of the printing surface for printing before running off any number of impressions. This preparation is technically called "making-ready," and is an operation requiring much time and care, especially in the case of illustrated work, where artistic appreciation and skill on the part of the workman is of great assistance in obtaining satisfactory and delicate results. Theoretically, if both type and press were new, little or no preparation should be necessary, but practical experience proves that this need of preparation has not yet been entirely obviated and still remains an important factor. Single proofs of type, stereotype, electrotype or blocks of any description can often be struck off without making-ready with fairly good results, but if precision of "colour" (that is, inking) and uniformity of impression throughout a volume are desired, it is necessary to put the forme, whether type or blocks or both, into a proper condition before starting the printing of an edition, whatever its number. And this applies to all good work produced from whatever presses or machines other than those built on the rotary principle. In these, even if time permitted, little can be done in the way of making-ready; nor

The Preparation or Making-ready for Printing.

is it really necessary for newspapers, printed and read one day, and then generally thrown away the next. But for finely printed works this preparation is essential; the actual results vary with the operator, both as regards quality and, what is very important to the employer, in the length of time taken. Some men labour more at it than others, and it is considered that a press is only really paying while it is actually running.

The system of making-ready employed now is quite different from that in use when it was necessary to dampen paper before it could be satisfactorily printed. It was then customary to print with a good deal of packing, usually consisting of a thick blanket together with several thicknesses of paper, all of which intervened between the printing and the impression surface, whether the latter was flat or cylindrical. There was much in favour of this system, because a good firm impression could be obtained, and the "nutmeg-grater" effect on the reverse, when the impression was too heavy, could, after the sheets were dry, be removed by cold-pressing in a hydraulic press. It is still the best method for obtaining first-rate results in fine work, where hand-made or other rough paper is used. But the demand for cheap literature required quicker means of production, and the introduction of process blocks, especially those made by the half-tone process, necessitated the use of smooth paper and a faster drying ink, both of which are to be deplored, because to calender the paper to the degree requisite for this kind of printing practically means destroying its natural surface, and in rendering the ink quicker in drying the pigment undoubtedly suffers. On the other hand, there has been a compensating advantage in the fact that improved machinery has been demanded for this class of work, and the British manufacturer has been stimulated by the American manufacturers, who have taken the initiative in the change of methods in printing. Cylinders are now turned so truly and ground to such a nicety that very little packing is required between type and sheet to be impressed, so that a new system of making-ready, termed "hard-packing," has been resorted to. The fact that the iron impression cylinder was nearer the type forbade the large amount of soft-packing formerly used, besides which process blocks, whether line or half-tone, could not be rendered properly by a soft impression. Although less packing is necessary, greater care is required in preparing type or blocks for printing by this new method.

The method in making-ready ordinary plain formes is as follows. The type-forme is placed on the coffin or bed of the press and fixed into its proper position—the precise position being regulated by the exact size of the sheet of paper on which the work is to be printed. The cylinder is first dressed with a fine and thin calico drawn tightly over and fastened securely, which serves as a base on which to fasten sheets. A sheet of some hard paper, such as manila, is then placed over it to form, as it were, a foundation.

The printer next proceeds to pull a sheet, without ink, to test the impression. We take it that the machine has already been regulated by means of the impression screws at the respective ends of the cylinder for all-round or average work, and that any inequality of impression can be remedied by adding or taking away from the sheets on the cylinder. Now, supposing the forme to be dealt with consists of thirty-two pages to be printed on quad crown paper, measuring 40×30 in., on a suitable size of single cylinder machine of the Wharfedale class, it would be found, although both the machine and type were fairly new (that is, not much worn), that there was some amount of inequality in the impression given to the whole sheet. This is easily detected by examining the sheet the reversed side in a strong side-light. Although the greater part may be fairly even, some pages, or portions of pages, would show up too strongly, the impress almost cutting through the paper, while in other portions the impression would be so faint that it could hardly be seen. These differences of impression are called respectively "high" and "low." All these difficulties have to be rectified by the printer either overlaying or cutting away pieces in this first trial sheet. If the "set" of the cylinder is about correct, and the impression sheet has been taken with neither too many nor too few sheets on the cylinder, it will be a matter rather of overlaying, or "patching up," than of cutting away from this trial sheet. As soon as this first sheet has been levelled up it is fixed on to the cylinder to its exact position, so that it will register or correspond with the type when the press is running, and another trial sheet is struck off, which is treated precisely in the same manner, and is then fastened up on the cylinder on top of the first sheet. It may even be necessary for fine printing to repeat this a third time, especially if the forme includes blocks of any kind. When this preparation is completed, the whole is covered up by a somewhat stouter sheet, which forms a protection to the whole making-ready, but which can easily be lifted should it be necessary to give any finishing touches to it before beginning to run.

If the forme to be printed consists of both type and blocks mixed, a somewhat different treatment has to be employed in order to put the blocks into a relative position with the type for printing. This is done by the usual trial impression sheet, and, as blocks are found to vary much in height and are generally low as compared with type, this deficiency has to be remedied by underlaying the

blocks so that they are brought to the height of the type, or a shade higher. This is usually done by pasting layers of thickish paper, or even thin cards, underneath the blocks. This must be carefully done so as to make them stand squarely and firmly on their base, in order that they may not rock and give a slur in printing. After underlaying, and to emphasize the respective degrees of light and shade in the illustrations, a separate and careful overlaying is required for the blocks before anything is done to the main forme. This is particularly necessary if the blocks are woodcuts, or electrotypes of woodcuts, which require a different cutting of perhaps three different thicknesses, all on thin hard paper, to give their full effect. But with half-tone process illustrations very little overlaying is required, provided the blocks have been brought up to the proper height by underlaying in the first instance—the various tones being already in the block itself—and it is little more than a matter of sharp, hard impression to give full effect to these, if both paper and ink are suitable. For line process blocks a still different treatment in making-ready is desirable, so as to get rid of the hard edges which are nearly always found in this kind of block. Here too it is essential that the preliminary underlaying be done with extreme care if good work is desired. The originals and the engraver's proofs are of great assistance to the workman in bringing out the details of an illustration when he is preparing it for printing. In rotary printing from the curved stereotype plate and from the endless web of paper much can be done to assist the printer if good stereotype plates are supplied to him, and, if the forme contains any illustrations, both the artist and the engraver can help him if they keep in mind the particular character of illustration which they are preparing for the press. The artist can accentuate the high lights or solids in the original drawing or photograph, and the stereotyper can emphasize points in the picture by thickening the plate in the parts necessary to stand out.

The past generation has seen many improvements in printing machinery, all tending to an increased production, and generally to the betterment of the work turned out. This is particularly true of three-colour printing (see PROCESS), which for commercial purposes has been brought to a high degree of perfection. Only what may be fairly considered as representative presses have been dealt with in this article, but there are many others, some of which have been most ingeniously constructed for special purposes. Process engraving has practically superseded wood engraving, and the new processes have brought new conditions, requiring a different making-ready, paper and ink. Some of these altered conditions are to be regretted. For instance, it is unfortunate that the quality and surface of papers have to be sacrificed to the demands for cheap literature, and this especially applies to illustrated work.

The introduction of the autoplate is of great advantage to those using rotary presses, because it allows the production of a large number of duplicate stereotype plates of satisfactory quality speedily. This is all important in a newspaper office, where the margin of time between the caserom and machine department is usually so limited, for it permits several machines being quickly equipped with duplicate sets of the same pages.

Power is another matter that is changing fast. Electricity is supplanting both steam and gas, and is being installed in most large printing-houses, including newspaper offices. Suction gas is being tried in some offices as a supplanter of electricity and is said to be much cheaper as a power producer. The independent system of motors is generally adopted, because it is found more economical and better for driving purposes, besides dispensing with the overhead shafting and belting, always unsightly, and dangerous to the workpeople. Speeds can be regulated to a nicety for each separate machine, and any machine can be set in motion by pressing a button.

A printing-house of average size, which makes book printing a speciality, consists of many departments under the supreme control of a general manager. His deputy may be said to be the works manager, who is responsible for all work being produced in a proper manner by the different departments. The progress of the work is as follows. The MS., or "copy" as it is called, is handed, with all instructions, to the overseer of the caserom, who gives it out to the compositors in instalments as they finish the work already in hand. Formerly the greater bulk of composition was done on the piece-work system, but as machine composition has largely superseded hand labour for the more ordinary class of work, piece-work is declining, and there is a greater tendency to have the work done on "establishment" ("stab"), i.e. fixed weekly wages. When the copy is in type a proof is struck off and sent to the reading closet, where the corrector of the press (see PROOF-READING), with the aid of a reading-boy, will compare it with the original MS. or copy, and mark all errors on the proof, so that they may be amended by the compositor at his own cost before it is despatched to the author or customer, who in turn revises or corrects it for the general improvement of the work. The proof is then returned to the printer, and if these corrections are at all heavy, another proof, called the "revise," is submitted, together with the first marked one, so that the author may see that his emendations have been made. This may even be repeated, but when finally corrected the proof is marked "press"

Recent Developments.

The Management of a Printing-house.

and is sent to the printer with the necessary instructions as to printing. After another reading or revision in the reading closet it is sent to the compositors, who make the final corrections in the type and hand the forme to the printing department to deal with. It is this department which contributes most to the success of any printing firm, and it requires a really good man at its head. He must be a thoroughly practical printer familiar with the different kinds of printing machinery. To make the department pay, the machines must be kept fully employed with the many classes of work that a large concern has to deal with; the wheels must be kept running as much as possible, and the time for making-ready curtailed as far as is consistent with the proper preparation of the forme. Here again it is most important that a sharp eye be kept on the materials used. Ink forms a large item in the total expenses of this department, besides which there are: oil for lubricating, turpentine and other solvents for cleaning, paper for proofs and making-ready, &c. When the work is printed it is handed to the warehousemen, who are responsible both for unprinted and printed paper. Lastly, the counting-house deals with all accounts, both departments' and customers'.

BIBLIOGRAPHY.—The following books and periodicals may be specially referred to: *Books*—J. Southward (and subsequently A. Powell), *Practical Printing*, a handbook of the art of typography (2 vols. 8vo, London, 1900); J. Southward, *Modern Printing*, a treatise on the principles and practice of typography, &c. (large 8vo, London, 1900); C. T. Jacobi, *Printing*, a practical treatise on the art of printing, &c. (8vo, 4th ed., London, 1908); W. J. Kelly, *Press-work*, a practical handbook for the use of pressmen and their apprentices (8vo, 2nd ed., Chicago, 1902); C. T. Jacobi, *The Printer's Handbook of Trade Recipes*, &c. (8vo, 3rd ed., London, 1905); F. J. F. Wilson and D. Grey, *Modern Printing Machinery and Letterpress Printing* (large 8vo, London, 1888); Robert Hoe, *A Short History of the Printing Press* (4to, New York, 1902); T. L. de Vinne, *The Invention of Printing* (New York, 1876). *Periodicals*—*The British and Colonial Printer and Stationer* (London, bi-weekly); *The British Printer* (Leicester, alternate months); *The Printer's Register* (London, monthly); *The Printing World* (London, monthly); *The Caxton Magazine* (London, monthly); *The Printing Art* (Cambridge, Mass., U.S.A., monthly); *The Inland Printer* (Chicago, monthly); *The American Printer* (New York, monthly); *The International Printer* (Philadelphia, monthly). See also the bibliography attached to the article **TYPOGRAPHY**. (C. T. J.)

PRIOR, MATTHEW (1664–1721), English poet and diplomatist, was the son of a Nonconformist joiner at Wimborne-Minster, East Dorset, and was born on the 21st of July 1664. His father moved to London, and sent him to Westminster, under Dr Busby. At his father's death he left school, and fell to the care of his uncle, a vintner in Channel Row. Here Lord Dorset found him reading Horace, and set him to translate an ode. He acquitted himself so well that the earl offered to contribute to the continuance of his education at Westminster. One of his schoolfellows and friends was Charles Montagu, afterwards earl of Halifax. It was to avoid being separated from Montagu and his brother James that Prior accepted, against his patron's wish, a scholarship recently founded at St John's College. He took his B.A. degree in 1686, and two years later became a fellow. In collaboration with Montagu he wrote in 1687 the *City Mouse and Country Mouse*, in ridicule of Dryden's *Hind and Panther*. It was an age when satirists were in request, and sure of patronage and promotion. The joint production made the fortune of both authors. Montagu was promoted at once, and Prior three years later was gazetted secretary to the embassy at the Hague. After four years of this employment he was appointed one of the gentlemen of the king's bedchamber. Apparently, also, he acted as one of the king's secretaries, and in 1697 he was secretary to the plenipotentiaries who concluded the peace of Ryswick. Prior's talent for affairs was doubted by Pope, who had no special means of judging, but it is not likely that King William would have employed in this important business a man who had not given proof of diplomatic skill and grasp of details. The poet's knowledge of French is specially mentioned among his qualifications, and this was recognized by his being sent in the following year to Paris in attendance on the English ambassador. At this period Prior could say with good reason that "he had commonly business enough upon his hands, and was only a poet by accident." To verse, however, which had laid the foundation of his fortunes, he still occasionally trusted as a means of maintaining his position. His occasional poems during this period include an elegy on Queen Mary in

1695; a satirical version of Boileau's *Ode sur le prise de Namur* (1695); some lines on William's escape from assassination in 1696; and a brief piece called *The Secretary*. After his return from France Prior became under-secretary of state and succeeded Locke as a commissioner of trade. In 1701 he sat in parliament for East Grinstead. He had certainly been in William's confidence with regard to the Partition Treaty; but when Somers, Orford and Halifax were impeached for their share in it he voted on the Tory side, and immediately on Anne's accession he definitely allied himself with Harley and St John. Perhaps in consequence of this for nine years there is no mention of his name in connexion with any public transaction. But when the Tories came into power in 1710 Prior's diplomatic abilities were again called into action, and till the death of Anne he held a prominent place in all negotiations with the French court, sometimes as secret agent, sometimes in an equivocal position as ambassador's companion, sometimes as fully accredited but very unpunctually paid ambassador. His share in negotiating the treaty of Utrecht, of which he is said to have disapproved, personally led to its popular nickname of "Matt's Peace." When the queen died and the Whigs regained power he was impeached by Sir Robert Walpole and kept in close custody for two years (1715–1717). In 1709 he had already published a collection of verse. During this imprisonment, maintaining his cheerful philosophy, he wrote his longest humorous poem, *Alma*; or, *The Progress of the Mind*. This, along with his most ambitious work, *Solomon*, and other *Poems on several Occasions*, was published by subscription in 1718. The sum received for this volume (4000 guineas), with a present of £4000 from Lord Harley, enabled him to live in comfort; but he did not long survive his enforced retirement from public life, although he bore his ups and downs with rare equanimity. He died at Wimpole, Cambridgeshire, a seat of the earl of Oxford, on the 18th of September 1721, and was buried in Westminster Abbey, where his monument may be seen in Poet's Corner. *A History of his Own Time* was issued by J. Bancks in 1740. The book pretended to be derived from Prior's papers, but it is doubtful how far it should be regarded as authentic.

Prior had very much the same easy, pleasure-loving disposition as Chaucer (with whose career his life offers a certain parallelism), combined with a similar capacity for solid work. His poems show considerable variety, a pleasant scholarship and great executive skill. The most ambitious, *i.e.* *Solomon*, and the paraphrase of the *Nut-Brown Maid*, are the least successful. But *Alma*, an admitted imitation of Butler, is a delightful piece of wayward easy humour, full of witty turns and well-remembered allusions, and Prior's mastery of the octo-syllabic couplet is greater than that of Swift or Pope. His tales in rhyme, though often objectionable in their themes, are excellent specimens of narrative skill; and as an epigrammatist he is unrivalled in English. The majority of his love songs are frigid and academic, mere wax-flowers of Parnassus; but in familiar or playful efforts, of which the type are the admirable lines *To a Child of Quality*, he has still no rival. "Prior's"—says Thackeray, himself no mean proficient in this kind—"seem to me amongst the easiest, the richest, the most charmingly humorous of English lyrical poems. Horace is always in his mind, and his song and his philosophy, his good sense, his happy easy turns and melody, his loves and his Epicurianism, bear a great resemblance to that most delightful and accomplished master."

The largest collection of Prior's verses is that by R. Brimley Johnson in the "Aldine Poets" (2 vols., 1892). There is also a selection in the "Parchment Library," with introduction and notes by Austin Dobson (1889). (A. D.)

PRIOR (from Lat. *prior*—former, and hence superior, through O. Fr. *priour*), a title applied generally to certain monastic superiors, but also in the middle ages to other persons in authority. Under the Roman Empire the word *prior* is found signifying "ancestor." In the early middle ages it was commonly applied to secular officials and magistrates, and it remained all though the middle ages as the title of certain officials in the

Italian city states. Noteworthy among these were the famous *priores artis* at Florence. These were appointed governors of the Florentine republic when the Companies of the Arts seized the government in 1282.

The term *prior* was most commonly used to denote the superiors in a monastery, at first with an indefinite significance, but later, as monastic institutions crystallized, describing certain definite officials. In the Rule of St Benedict and other early rules the titles *praepositus* and *praelatus* (see PRELATE) are generally used, but *prior* is also found signifying in a general way the superiors and elders in a monastery. When used by St Benedict in the singular number it seems (according to the commentator Ménard) to denote the abbot himself. At a later date in the order of St Benedict the title was applied to the monk next in authority to the abbot, though this usage was not adopted technically until the 13th century. In some monasteries several priors were to be found and generally at least two. Thus we find the terms *prior*, *sub-prior*, *tertius prior*, *quartus prior*, *quintus prior*. The first prior was sometimes called *prior major*, sometimes *prior claustralis*. Occasionally both titles are found in one house, the latter ranking below the former. The first prior acted as vicar in all matters in the absence of the abbot, and was generally charged with the details of the discipline of the monastery. With the foundation of the order of Cluny in the 10th century there appeared the *conventual prior* who ruled as head of a monastery, but was subject in some degree to the *archiabbas* of the mother-house of Cluny. The Regular Canons later gave this title of prior to the heads of their houses, as did also the Carthusians and the Dominicans. It was in houses of these orders that the sub-prior became a regular official. Among the Dominicans the head of a province is known as the "prior provincial." In the order of St John of Jerusalem (*q.v.*) a priory was a group of commanderies ruled by a "grand prior."

The term prior was applied also in the middle ages in a very general manner. Thus there was the *prior scholae* or leader of the choir, *prior scriuariorum*, &c.

See Du Cange, *Glossarium mediae et infimae latinitatis*, new edition by L. Favre (Niort, 1883, &c.); Sir William Smith and S. Cheetham, edd. *Dictionary of Christian Antiquities* (1875-1880). (E. O'N.)

PRISCIAN [PRISCIANUS CAESARIENSIS], the celebrated Latin grammarian, lived about A.D. 500, *i.e.* somewhat before Justinian. This is shown by the facts that he addressed to Anastasius, emperor of the East (491-518), a laudatory poem, and that the MSS. of his *Institutiones grammaticae* contain a subscription to the effect that the work was copied (526, 527) by Flavius Theodorus, a clerk in the imperial secretariat. Three minor treatises are dedicated to Symmachus (the father-in-law of Boëtius). Cassiodorus, writing in the ninety-third year of his age (560? 573?), heads some extracts from Priscian with the statement that he taught at Constantinople in his (Cassiodorus's) time (Keil, *Gr. Lat.* vii. 207). His title *Caesariensis* points, according to Niebuhr and others, to Caesarea in Mauretania. Priscian's teacher was Theoctistus, who also wrote an *Institutio artis grammaticae*. Priscian was quoted by several writers in Britain of the 8th century—Aldhelm, Bede, Alcuin—and was abridged or largely used in the next century by Hrabanus Maurus of Fulda and Servatus Lupus of Ferrières. There is hardly a library in Europe that did not and does not contain a copy of his great work, and there are about a thousand MSS. of it. The greater part of these contain only books i.-xvi. (sometimes called *Priscianus major*); a few contain (with the three books *Ad Symmachum*) books xvii., xviii. (*Priscianus minor*); and a few contain both parts. The earliest MSS. are of the 9th century, though a few fragments are somewhat earlier. All are ultimately derived from the copy made by Theodorus. The first printed edition was in 1470 at Venice.

The *Institutiones grammaticae* is a systematic exposition of Latin grammar, dedicated to Julian, consul and patrician, whom some have identified with the author of a well-known epitome of Justinian's *Novellae*, but the lawyer appears to be somewhat later than Priscian. It is divided into eighteen books,

of which the first sixteen deal mainly with sounds, word-formation and inflexions; the last two, which form from a fourth to a third of the whole work, deal with syntax. Priscian informs us in his preface that he has translated into Latin such precepts of the Greeks Herodian and Apollonius as seemed suitable, and added to them from Latin grammarians. He has preserved to us numerous fragments which would otherwise have been lost, *e.g.* from Ennius, Pacuvius, Accius, Lucilius, Cato and Varro. But the authors whom he quotes most frequently are Virgil, and, next to him, Terence, Cicero, Plautus; then Lucan, Horace, Juvenal, Sallust, Statius, Ovid, Livy and Persius. His industry in collecting forms and examples is both great and methodical. His style is somewhat heavy, but sensible and clear; it is free, not of course from usages of Late Latin, but from anything that can be called barbarism. Its defects may be referred in the main to four heads. (1) Priscian avowedly treats Greek writers on (Greek) grammar as his supreme authorities; and bears too little in mind that each has a history of its own and is a law to itself. (2) There had been no scientific study of phonetics, and consequently the changes and combinations of languages are treated in a mechanical way: *e.g.* *i* passes into *a*, as *genus*, *generis*, *generatum*; into *o*, as *saxi*, *saxosus*; *q* passes into *s*, as *torqueo*, *torsi*, &c. (3) The resolution of a word into root or stem and inflexional or derivative affixes was an idea wholly unknown, and the rules of formation are often based on unimportant phenomena; *e.g.* *Venus*, like other names ending in *us*, ought to have genitive *Veni*, but, as this might be taken for a verb, it has *Veneris*. *Ador* has no genitive because two rules conflict; for neuters in *or* have a short penult (*e.g.* *aequor*, *aequoris*), and *adoro*, from which it is derived, has a long penult. (4) The practical meaning of the inflexions is not realized, and syntactical usages are treated as if they were arbitrary or accidental associations. Thus, after laying down as a general rule for declinable words that, when they refer to one and the same person, they must have the same case, gender and number, Priscian adds that when there are transitive words we may use different numbers, as *doceo discipulos*, *docemus discipulum*. He often states a rule too broadly or narrowly, and then, as it were, gropes after restrictions and extensions.

His etymologies are of course sometimes very wild: *e.g.* *caelebs* from *caelestium vitam ducens*, *b* being put for consonantal *u* because a consonant cannot be put before another consonant; *deterior* from the verb *detero*, *deteris*; *potior* (adj.) from *potior*, *potiris*; *arbor* from *robur*; *verbum* from *verberatus aeris*, &c. Nor is he always right in Greek usages.

Priscian's three short treatises dedicated to Symmachus are on weights and measures, the metres of Terence, and some rhetorical elements (exercises translated from the *Προγυμνάσματα* of Hermogenes). He also wrote *De nomine, pronomine, et verbo* (an abridgment of part of his *Institutiones*), and an interesting specimen of the school teaching of grammar in the shape of complete parsing by question and answer of the first twelve lines of the *Aeneid* (*Partitiones xii. versuum Aeneidos principalium*). The metre is discussed first, each verse is scanned, and each word thoroughly and instructively examined. A treatise on accents is ascribed to Priscian, but is rejected by modern writers on the ground of matter and language. He also wrote two poems, not in any way remarkable, *viz.* a panegyric on Anastasius in 312 hexameters with a short iambic introduction, and a faithful translation into 1087 hexameters of Dionysius's *Periegesis* or geographical survey of the world.

The best edition of the grammatical works is by Hertz and Keil, in Keil's *Grammatici latini*, vols. ii., iii.; poems in E. Bährens' *Poetae latini minores*, the "Periegesis" also, in C. W. Müller, *Geographi graeci minores*, vol. ii. See J. E. Sandys, *History of Classical Scholarship* (ed. 1906), pp. 272 sqq.

PRISCILLIAN (d. 385), Spanish theologian and the founder of a party which, in spite of severe persecution for heresy, continued to subsist in Spain and in Gaul until after the middle of the 6th century. He was a wealthy layman who had devoted his life to a study of the occult sciences and the deeper problems of philosophy. He was largely a mystic and regarded the Christian

life as continual intercourse with God. His favourite idea is that which St Paul had expressed in the words "Know ye not that ye are the temple of God?" and he argued that to make himself a fit habitation for the divine a man must, besides holding the Catholic faith and doing works of love, renounce marriage and earthly honour, and practise a hard asceticism. It was on the question of continence in, if not renunciation of, marriage, that he came into conflict with the authorities. Priscillian and his sympathizers, who were organized into bands of *spirituales* and *abstinentes*, like the Cathari of later days, indignantly refused the compromise which by this time the Church had established in the matter (see MARRIAGE: *Canon Law*). This explains the charge of Manichaeism levelled against Priscillian (Jerome, for his talk of the *Sordes nuptiarum*, had been similarly accused, and to escape popular indignation had retired to Bethlehem),¹ and to this was added the accusation of magic and licentious orgies. Among the more prominent of Priscillian's friends were two bishops, named Instantius and Salvianus, and Hyginus of Cordova also joined the party; but, through the exertions of Idacius of Emerita, the leading Priscillianist, who had failed to appear before the synod of Spanish and Aquitanian bishops to which they had been summoned, were excommunicated at Saragossa in October 380. Meanwhile, however, Priscillian was made bishop of Avila, and the orthodox party found it necessary to appeal to the emperor (Gratian), who issued an edict threatening the sectarian leaders with banishment. Priscillian, Instantius and Salvianus succeeded, however, in procuring the withdrawal of Gratian's edict, and the attempted arrest of Ithacius of Ossonuba. On the murder of Gratian and accession of Maximus (383) Ithacius fled to Treves, and in consequence of his representations a synod was held (384) at Bordeaux, where Instantius was deposed. Priscillian appealed to the emperor, with the unexpected result that with six of his companions he was burned alive at Treves in 385. The first instance of the application of the Theodosian law against heretics had the approval of the synod which met at Treves in the same year, but Ambrose of Milan and Martin of Tours can claim the glory of having in some measure stayed the hand of persecution. The heresy, notwithstanding the severe measures taken against it, continued to spread in France as well as in Spain; in 412 Lazarus, bishop of Aix in Provence, and Herod, bishop of Arles, were expelled from their sees on a charge of Manichaeism. Proculus, the metropolitan of Marseilles, and the metropolitans of Vienne and Narbonensis Secunda were also followers of the rigorous tradition for which Priscillian had died. Something was done for its repression by a synod held by Turibius of Astorga in 446, and by that of Toledo in 447; as an openly professed creed it wholly disappeared after the second synod of Braga in 563. "The official church," says F. C. Conybeare, "had to respect the ascetic spirit to the extent of enjoining celibacy upon its priests, and of recognizing, or rather immuring, such of the laity as desired to live out the old ascetic ideal. But the official teaching of Rome would not allow it to be the ideal and duty of every Christian. Priscillian perished for insisting that it was such; and seven centuries later the Church began to burn the Cathari by thousands because they took a similar view of the Christian life."

The long prevalent estimation of Priscillian as a heretic and Manichaean rested upon Augustine, Turibius of Astorga, Leo the Great and Orosius, although at the Council of Toledo in 400, fifteen years after Priscillian's death, when his case was reviewed, the most serious charge that could be brought was the error of language involved in rendering *ἀγέννητος* by *innascibilis*. It was long thought that all the writings of the "heretic" himself had perished, but in 1885, G. Schepss discovered at Würzburg eleven genuine tracts, since published in the Vienna *Corpus*. "They contain nothing that is not orthodox and commonplace,

¹ Cf. the outbreak at Rome in 384 against the *gymnosophists*, emaciated monks who walked the streets and vehemently denounced marriage. The epistles of Pope Siricius (who wished to stand well with the people) are full of scorn for these ascetics, and the Leonine sacramentary contains prayers which severely denounce them.

nothing that Jerome might not have written," and go far to justify the description of Priscillian as "the first martyr burned by a Spanish Inquisition."

See E. Ch. Babut, *Priscillian et le Priscillianisme* (Paris, 1909). (A. J. G.)

PRISCUS, of Panium in Thrace, Greek sophist and historian, lived during the 5th century A.D. He accompanied Maximin, the ambassador of Theodosius the Younger, to the court of Attila (448). During the reign of Marcian (450-457) he also took part in missions to Arabia and the Egyptian Thebaïd. Priscus was the author of an historical work in eight books (*Βυζαντινῆ Ἱστορία*), probably from the accession of Attila to that of Zeno (433-474). Only fragments of the work remain, but the description of Attila and his court and the account of the reception of the Roman ambassadors is a most valuable piece of contemporary history. Priscus's style is pure, and his impartiality and trustworthiness entitle him to an honourable place among the writers of his time.

Fragments and life in C. W. Müller, *Fragmenta historicorum graecorum*, iv. 69-110; v. 24-26, ed. B. G. Niebuhr in Bonn, *Corpus scriptorum hist. byzantinae* (1829), vol. vi., and L. Dindorf in *Historici graeci minores* (1870), vol. i. For the embassy to Attila see Gibbon, *Decline and Fall*, ch. 34.

PRISCUS, a Greek Neoplatonist philosopher, of the school of Iamblichus and Aedesius. He died about the year 398 at the age of ninety. The emperor Julian frequently invited him to court on the strength of his reputation in connexion with theurgy. Eunapius says that he was a man of dignified and austere habit. Unlike Maximus, he used his influence over Julian with great moderation. He died during the Gothic invasion of Greece (A.D. 396-98). He is important partly as maintaining the best traditions of philosophy during a period when Neoplatonism as a whole was a parasite of imperial power, and partly as being a connecting link between Iamblichus and Plutarch of Athens.

See Zeller's *Hist. of Greek Phil.*

PRISHTINA, PRICHTINA, or PRISTINA, the chief town of a sanjak in the vilayet of Kossovo, Albania, European Turkey; on a small tributary of the river Sitnftza, an affluent of the Ibar, and 3 m. E. of the Prishtina station on the Salonica-Mitrovitza railway. Pop. (1905), about 11,000. Prishtina is the seat of a governor-general and of a general of division, and possesses many mosques, a military hospital and a higher class school. The trade is considerable, the exports including chrome, wheat, maize, barley, skins, wine and timber from the magnificent beech forests in the sanjak. The plain of Kossovo (*Kossovo-polye*, "Field of Blackbirds"), to the west, was the scene of the battle in which the Servian empire was destroyed by the Turks in 1389. To the south-east lies the partly ruined monastery of Grachanitzza founded by King Milutin of Servia (1275-1321). Among the frescoes are a remarkable head of Christ in the dome, and portraits of the founder and his queen Simonida, daughter of Andronicus II. Palaeologus.

See G. M. M. Mackenzie and A. P. Irby, *Travels in the Slavonic Provinces of Turkey* (1877).

PRISM (Gr. *πρίσμα*, properly a thing sawn, *πρίζειν*, to saw), in geometry a solid enclosed by plane surfaces, two of which, termed the ends, are parallel, equal, similar and similarly situated polygons, and the faces connecting the ends are parallelograms, equal in number to the sides of the polygon. If the faces be perpendicular to the ends the prism is a "right prism," and the faces are rectangles; otherwise the prism is "oblique." The *axis* is the line joining the centres of the ends. It may be generated by moving a plane (corresponding to an end or base) parallel to itself. A prismoid differs from a prism in having for its ends two dissimilar parallel figures. For illustrations see CRYSTALLOGRAPHY, and for the mensuration see that article. In optics the word denotes a triangular prism, *i.e.* one having a triangle for base, used to decompose white light. (See REFRACTION and DISPERSION.)

PRISON (derived through the Fr. from the Lat. *prehensio*, seizure), a place for the confinement or compulsory restraint of

persons after arrest or sentence by arbitrary authority or process of law.

The earliest object sought in imprisonment was to secure the person of the accused to ensure his appearance before his judges for trial, and after conviction to produce him to take his punishment. They were applied to other uses less justifiable or defensible; they served to execute the will of the despotic master upon all who set themselves in opposition to his authority, or were decreed, more or less wisely but still arbitrarily, by a government in the best interests of society, organized for the general good. Coercion and intimidation slowly came to be leading ideas, the infliction of a lesser penalty than the capital. The deprivation of liberty under irksome circumstances, rough lodging, hard fare and perpetual labour was after all a milder measure than death, although long years elapsed before the prison was so used. Penal codes depended rather upon shorter and more cruel methods; the scaffold was in constant use, with all manner of physical pain, torture before and after sentence, shameful exposure, hideous mutilation, exile, selling into bondage as slaves. Incarceration was no doubt practised by irresponsible masters, regardless of personal rights, callous to the sufferings of their victims, to which death by starvation or horrible neglect was a welcome relief. But consignment to a prison for lengthened periods was, as a penalty, of more recent introduction, and of still later date is the recognition of the duties incumbent upon the authority to use its powers mercifully by humane endeavours to reform and improve those on whom it laid hands.

The progress made can only be realized by considering what prisons once were. The shocking picture drawn by John Howard of the state of prisons at the latter end of the 18th century will last for all time. They were for the most part pestiferous dens, overcrowded, dark, foully dirty, not only ill ventilated, but deprived altogether of fresh air. The wretched inmates were dependent for food upon the caprice of their gaolers or the charity of the benevolent; water was denied them except in the scantiest proportions; their only bedding was putrid straw. Every one in durance, whether tried or untried, was heavily ironed. All alike were subject to the rapacity of their gaolers and the extortions of their fellows. Gaol fees were levied ruthlessly—"garnish" also, the tax or contribution paid by each individual to a common fund to be spent by the whole body, generally in drink. Idleness, drunkenness, vicious intercourse, sickness, starvation, squalor, cruelty, chains, awful oppression and everywhere culpable neglect—in these words may be summed up the state of the gaols at the time of Howard's visitation.

At this time prisons were primarily places of detention, not of punishment, peopled by accused persons, still innocent in the eyes of the law, and debtors guilty only of breaches of the financial rules of a commercial country, framed chiefly in the interest of the creditor. Freedom from arrest was guaranteed by Magna Carta, save on a criminal charge, yet thousands were committed to gaol on legal fictions and retained indefinitely for costs far in excess of the original debt. The impecunious were locked up and deprived of all hope of earning means to obtain enlargement; while their families and persons dependent on them shared their imprisonment and added to the overcrowding. The prisons were always full. Gaol deliveries were of rare occurrence, even when tardy trial ended in acquittal release was delayed until illegal charges in the way of fees had been satisfied.

In the article DEPORTATION it is shown how the discoveries in the southern seas led to the adoption of penal exile in preference to other suggested improvements in the English prison systems. The penitentiary scheme proposed by Howard was not, however, abandoned. It was revised and kept alive by Jeremy Bentham in his fanatical scheme for a "panopticon or inspection house," described as "a circular building, an iron cage glazed, a glass lantern as large as Ranelagh, with the cells on the outer circumference." His plan was to keep every inmate of every cell under constant close observation, and all were to be reformed by solitude and seclusion while constantly

employed in remunerative labour, in the profits of which they were to share. The scheme hung fire, owing, it was alleged, to the personal hostility of George III. to Bentham as an advanced radical. Lands were, however, purchased which were eventually taken over by the government and utilized for the erection of Millbank penitentiary, begun in 1813 and partially completed in 1816. It was now fully recognized that the reformation of prisoners could best be attempted by seclusion, "employment and religious instruction." Millbank, as a new and most enlightened undertaking in prison affairs, was opened with much éclat. It was to be governed by a specially appointed committee of distinguished personages, the chairman being the Speaker of the House of Commons. The sum total expended upon the buildings amounted to half a million of money, and the yearly charges of the establishment were a heavy burden on the exchequer.

The erection of Millbank was a step in the right direction. The energy with which it was undertaken was the more remarkable because elsewhere throughout the United Kingdom the prisons, with few exceptions, remained deplorably bad. J. Neild, who in 1812 followed in the footsteps of John Howard, found that the old conditions remained unchanged. "The great reformation produced by Howard," to use Neild's own words, "was merely temporary . . . prisons were relapsing into their former horrid state of privation, filthiness, severity and neglect." Yet the legislature was alive to the need for prison reform. Besides the building of Millbank it had promulgated many acts for the amelioration of prisoners. Gaol fees were once more distinctly abolished; the appointment of chaplains was insisted upon, and the erection of improved prison buildings was rendered imperative upon local authorities. But these, with other and much older acts, remained in abeyance. Thus an act which provided for the classification of prisoners had remained a dead letter; even the separation of the males from the females was not a universal rule. Roused by these crying evils, a small band of earnest men formed themselves into an association for the improvement of prison discipline. They perambulated the country inspecting the prisons; they issued lengthy interrogatories to prison officials; they published periodical reports giving the result of their inquiries, with their views on the true principles of prison management, and much sound advice, accompanied by elaborate plans on the subject of prison construction. The labours of this society brought out into strong relief the naked deformity of the bulk of the British gaols. Speaking of St Albans from his personal observation Mr (afterwards Sir T. F.) Buxton, a most active member of the society, said: "All were in ill health; almost all were in rags; almost all were filthy in the extreme. The state of the prison, the desperation of the prisoners, broadly hinted in their conversation and plainly expressed in their conduct, the uproar of oaths, complaints and obscenity, the indescribable stench, presented together a concentration of the utmost misery and the utmost guilt." The reports of the society laid bare the existence of similar horrors in numbers of other gaols. Yet this was in 1818, when the legislature was setting a praiseworthy example—when half a million had been spent in providing large airy cells for a thousand prisoners. Even in London itself, within easy reach of the palatial Millbank penitentiary, the chief prison of the city, Newgate, was in a disgraceful condition. This had been exposed by a parliamentary inquiry as far back as 1814, but nothing had been done to remedy the evils laid bare. The state of the female side had already attracted the attention of that devoted woman, Mrs Fry, whose ministrations and wonderful success no doubt encouraged, if they did not bring about, the formation of the Prison Society. Mrs Fry went first to Newgate in 1813, but only as a casual visitor. It was not until 1817 that she entered upon the noble work with which her name will ever be associated. She worked a miracle there in an incredibly short space of time. The ward into which she penetrated was like a den of wild beasts; it was filled with women unsexed, fighting, swearing, dancing, gaming, yelling and justly deserved its name of "hell above ground." Within a month it was transformed,

and presented, says an eyewitness, "a scene where stillness and propriety reigned." The wild beasts were tamed. Movements similar to that which Mrs Fry headed were soon set on foot both in England and on the Continent, and public attention was generally directed to the urgent necessity for prison reform.

Stimulated by the success achieved by Mrs Fry, the Prison Discipline Society continued its labours. Hostile critics were not wanting; many voices were raised in protest against the ultra-humanitarianism which sought to make gaols too comfortable and tended to pamper criminals. But the society pursued its objects, undeterred by sarcasm. Many of these are now accepted as axioms in prison treatment; for instance, that female officers only should have charge of female prisoners, that prisoners of both sexes should be kept apart and constantly employed. Yet these principles were unacknowledged at that time and were first enunciated in acts such as the 4 Geo. IV. c. 65 and the 5 Geo. IV. c. 85 (1823-1824), the passing of which were mainly due to the strenuous exertions of the Prison Discipline Society. It was laid down in these that over and above safe custody it was essential to preserve health, improve morals, and enforce hard labour on all prisoners sentenced to it. Irons were strictly forbidden except in cases of "urgent and absolute necessity," and it was ruled that every prisoner should have a bed to himself—if possible a separate cell, the last being the first formal statement of a principle upon which all future prison discipline was to be based.

The importance of these acts cannot be over-estimated as supplying a legal standard of efficiency by which all prisons could be measured. Still the progress of improvement was extremely slow, and the managers of gaols still evaded or ignored the acts. Many local authorities grudged the money to rebuild or enlarge their gaols; others varied much in their interpretation of the rules as to hard labour and the hours of employment. One great drawback to general reform was that a large number of small prisons lay beyond the reach of the law. Those under small jurisdictions in the boroughs and under the petty corporate bodies continued open to the strongest reprobation, and thus remained until they were swept away by the measure which brought about the reform of the municipal corporations in 1835. But by this time a still more determined effort had been made to establish some uniform and improved system of prison discipline. In 1831 a select committee of the House of Commons went into the whole subject of secondary punishment and reported that, as the difficulties in the way of an effective classification of prisoners were insurmountable, they were strongly in favour of the confinement of prisoners in separate cells, recommending that the whole of the prisons should be altered accordingly and the expense borne by the public exchequer. There can be little doubt that this committee was greatly struck by the superior methods of prison discipline pursued in the United States. The best American prisons had recently been visited by two eminent Frenchmen, J. A. de Beaumont and A. de Tocqueville, who spoke of them in terms of the highest praise. It was with the object of appropriating what was best in the American system that Mr W. Crawford was despatched across the Atlantic on a special mission of inquiry. His exhaustive report, published in 1834, was a valuable contribution to the whole question of penal discipline. Another select committee, this time of the House of Lords, returned to the subject in 1835, and after a long investigation re-enunciated the theory that all prisoners should be kept separate from one another. It also urged in strong terms the necessity for one uniform system of treatment, more especially as regarded dietaries, labour and education, and strongly recommended the appointment of official inspectors to enforce obedience to the acts. These recommendations were eventually adopted and formed the basis of a new departure.

For fifty years transportation (see DEPORTATION) had been in England the principal form of secondary punishment for crime.

Primary or capital punishment still existed, but to a greatly modified extent. The pious Quakers of Pennsylvania at the end of the 18th century had realized a deeper duty towards the offenders than their extinction,

and sought to amend and reform the living. The note struck first in the Walnut Street penitentiary began a new era in prison treatment, and the methods adopted were destined to extend over the whole world. This was the germ of the nearly universal principle of individual confinement, and the origin of what some advanced thinkers have denounced as the greatest crime of the present age, the invention of the separate cell. It was and still is held by many that the criminal may be best and most effectually weaned from his evil ways by shutting him up for lengthy periods between four walls, and subjecting him, when most susceptible, to curative processes, to constant exhortation and searching introspection, changing his nature and restoring him to society a reformed man.

It must be at once admitted that the system of isolation has produced no remarkable results. Solitary confinement has neither conquered nor appreciably diminished crime, even where it has been applied with extreme care, as in Belgium, and more recently in France, where it obtains strict and unbroken for long terms of years. Cloistered seclusion is an artificial condition quite at variance with human instincts and habits, and the treatment, long continued, has proved injurious to health, inducing mental breakdown. A slow death may be defended indeed on moral grounds if regeneration has been compassed, but it is only another form of capital punishment. Still the measures introduced in the United States and the action taken upon them fill a large page in prison history and must be recorded here.

Several states in the Union followed the lead of Pennsylvania. That of New York built the great Auburn penitentiary in 1816 to carry out the new principles. There every prisoner was kept continuously in complete isolation. He saw no one, spoke to no one, and did no work. Within a short period very deplorable results began to show themselves. Many prisoners became insane; health was generally impaired and life greatly endangered. Mr Crawford, whose mission to the United States has been already referred to, was in favour of solitary confinement, but he could not deny that several cases of suicide followed this isolation. Some relaxation of the disastrous severity seemed desirable, and out of this grew the second great system, which was presently introduced at Auburn and afterwards at the no less renowned prison of Sing Sing. It was called the silent system. While the prisoners were still separated at night or meals, they were suffered to labour in association, but under a rule of silence ruthlessly and rigorously maintained. The latter, entrusted to irresponsible subordinates, degenerated into a despotism which brought the system into great discredit. All discipline officers were permitted to wield the whip summarily and without the slightest check. Under such a system the most frightful excesses were possible and many cases of brutal cruelty were laid bare. Reviewing the merits and demerits of each system, Mr Crawford gave his adhesion to that of unvarying solitude as pursued in the Eastern penitentiary in Pennsylvania.

Mr Crawford came back from the United States an ardent champion of the solitary system. He saw, however, great difficulties in making this the universal rule, chief among which was the enormous expense of providing suitable prisons. Some modification of the rule of unbroken solitude would be inevitable; but he strongly urged its adoption for certain classes, and he was equally convinced of the imperative necessity for giving every prisoner a separate sleeping cell. It is clear that the government endorsed Mr Crawford's views. Where it was possible they gave effect to them at once. At Millbank, with its spacious solitary cells, the rule of seclusion was more and more strictly enforced. Ere long permissive legislation strove to disseminate the new principles. In 1830 Lord John Russell had given it as his opinion that cellular separation was desirable in all prisons. But it was not until 1830 that an act was passed which laid it down that individuals might be confined separately in single cells. Even now the executive did not insist upon the construction of prisons on a new plan. It only set a good example

Cellular
Separation.

by undertaking the erection of one which should serve as a model for the whole country. In 1840 the first stone of Pentonville prison was laid, and after three years of considerable outlay, its cells, 520 in number, were occupied on the solitary, or more exactly the separate system—the latter being somewhat less rigorous and irksome in its restraints. To the credit of many local jurisdictions, they speedily followed the lead of the central authority. Within half a dozen years no fewer than fifty-four new prisons were built on the Pentonville plan, which now began to serve generally as a "model" for imitation, not in England alone, but all over the world. Sir Joshua Jebb, who presided over its erection, may fairly claim indeed to be the author and originator of modern prison architecture.

The building of Pentonville was epoch-making. The modern prison dates from it. The penal discipline of to-day, much modified and varied it is true, may be largely traced to it. The "cell" scheme of individual separation holds the ground, and countries which can afford the outlay have built or are building cellular prisons. France has made steady progress in this respect. Great additions have been made to La Santé prison in Paris, and a new prison on gigantic lines has been opened at Fresnes les Rungis, on the outskirts of the metropolis, to replace the obsolete Mazas, and to give cellular accommodation to the large numbers always on hand in Paris. Germany has embarked on penitentiary reforms with the provision of several new prisons; it is the same with the United States, Austria, Holland, Spain, Portugal, Denmark, Norway, Sweden. In Italy a comprehensive scheme has been drawn up so that cellular imprisonment may become a general rule. In Belgium, where penal administration has received the closest attention for a number of years, the régime of cellular imprisonment has been long carried to its farthest limits, and solitary confinement ranging over ten years and in some cases much more has been strictly enforced. Of late years however a new school has arisen in Belgium which expresses strong doubts of the wisdom or efficacy of prolonged cellular confinement. In England, moreover, which, if not the first to adopt separation in principle, certainly gave the largest effect to it in practice, continuous cellular confinement for short terms is ceasing to be the inevitable rule; and although it has been retained in cases of penal servitude for the first six months, it was in 1809 practically abandoned for lesser sentences, and all prisoners after the first month work together in association under surveillance. In July 1910 the home secretary announced his intention to reduce it to one month in all cases, except those of recidivists (see RECIDIVISM). The bias of modern practice, in short, is towards milder methods, not only in treatment, but in those anticipatory processes which may render imprisonment unnecessary.

To understand the existing British prison system it is necessary to consider its gradual growth and the steps taken to establish it. Its foundations were laid by Sir George Grey, **The Modern British System.** when transportation ended rather abruptly by the refusal of the chief colonies to continue to be the dumping ground for British convicts. Sir George Grey sought to deal with the difficulty as a whole, and to provide for all classes of criminals, the most heinous deserving severe correction and the minor offenders in the earliest stages of misconduct. For the first there was some urgency, the latter was still the business of the local jurisdictions. The system now introduced consisted of three principal parts: (1) of a limited period of separate confinement in a home prison or penitentiary, accompanied by industrial employment and moral training; (2) of hard labour at some public works prison either at home or abroad; and (3) of exile to a colony with a conditional pardon or ticket-of-leave (*q.v.*). No pains were spared to give effect to this plan. Pentonville was available for the first phase; Millbank was also pressed into the service, and accommodation was hired in some of the best provincial prisons, as at Wakefield and Leicester. Few facilities existed for carrying out the second stage, but they were speedily improvised. Although the hulks at home had been condemned, convict establishments in which these floating prisons still

formed the principal part were organized at Bermuda and Gibraltar. Neither of these was a conspicuous success; they were too remote for effective supervision; and although they lingered on for some years they were finally abolished. The chief efforts of the authorities were directed to the formation of public works prisons at home, and here the most satisfactory results were soon obtained. The construction of a harbour of refuge at Portland had been recommended in 1845; in 1847 an act was passed to facilitate the purchase of land there, and a sum of money was taken in the estimates for the erection of a prison which was begun next year. At another point, Dartmoor, a prison already stood available, although it had not been occupied since the last war, when ten thousand French and American prisoners had been incarcerated in it. A little reconstruction made Dartmoor into a modern gaol, and in the waste lands around there was ample labour for any number of convict hands. Dartmoor was opened in 1850; two years later a convict prison was established at Portsmouth in connexion with the dockyard, and another of the same class at Chatham in 1856. The third stage in Sir George Grey's scheme contemplated the enforced emigration of released convicts, whom the discipline of separation and public works was supposed to have purged and purified, and who would have better hopes of entering on a new career of honest industry in a new country than when thrown back among vicious associations at home. The theory was good, the practice impossible. No colony would receive these ticket-of-leave men. Van Diemen's Land positively refused to do so, even though this denial cut off the supply of labour, now urgently needed. The appearance of a convict ship at the Cape of Good Hope nearly produced a revolt. Although Earl Grey addressed a circular letter to all colonial governments offering them the questionable boon of transportation, only one, the comparatively new colony of Western Australia, accepted. But this single receptacle could not absorb a tithe of the whole number of convicts awaiting exile. It became necessary therefore to find some other means for their disposal. Accordingly, in 1853 the first Penal Servitude Act was passed, substituting certain shorter sentences of penal servitude for transportation. It was only just to abbreviate the terms; under the old sentence the transportee knew that if well conducted he would spend the greater part of it in comparative freedom. But although sentences were shortened it was not thought safe to surrender all control over the released convict; and he was only granted a ticket-of-leave for the unexpired portion of his original sentence. No effective supervision was maintained over these convicts at large. They speedily relapsed into crime; their numbers, as the years passed, became so great and their depredations so serious, especially in garrotte robberies, that a cry of indignation was raised against the system, which led to its arraignment before a select committee of the House of Commons in 1863.

Meanwhile prison discipline in the elementary stage, as inflicted on lesser offenders, was continually discussed. The subject was referred to many committees for inquiry, and it was shown that there was a lamentable want of uniformity in the enforcement of legal penalties. The processes and treatment varied with the localities. Diets differed, here too ample, there meagre to starvation. The amount of exercise allowed varied greatly; there was no universal rule as to employment. In some prisons hard labour was insisted upon, and embraced tread-wheels or the newly-invented cranks; in some it did not exist at all. The cells inhabited by prisoners (and separate cellular confinement was now very general) were of different dimensions—variously lighted, warmed and ventilated. The time spent in these cells was not invariably the same, and as yet no authoritative decision had been made between the solitary and silent systems. The first named had been tried at Pentonville, but the period had been greatly reduced. The duration had been at first fixed at eighteen months, but it was proved that the prisoners' minds had become enfeebled by this long isolation, and the period was limited to nine months. In many jurisdictions however the silent system, or that of associated

labour in silence, was still preferred; and there might be prisons within a short distance of each other at which two entirely different systems of discipline were in force. In 1849 Mr Charles Pearson, M.P., moved for a select committee to report upon the best means of securing some uniform system which should be at once punitive, reformatory and self-supporting. He urged that all existing plans were inefficacious, and he advocated a new scheme by which the labour of all prisoners should be applied to agriculture in district prisons. The result of a full inquiry was the reiteration of views already accepted in theory but not yet generally adopted in practice. Thirteen more years elapsed and still no such steps had been taken. A new committee sat in 1863, and in its report again remarked in no measured terms upon the many and wide differences that still existed in the gaols of Great Britain as regards construction, diet, labour and general discipline, "leading to an inequality, uncertainty and inefficiency of punishment productive of the most prejudicial results." Matters could only be mended by the exercise of legislative authority, and this came in the Prison Act of 1865, an act which consolidated all previous statutes on the subject of prison discipline, many of its provisions being still in force. Yet the years passed and uniformity was still far from secured; it was impossible indeed while prison administration was still left to a number of local authorities, no two of which were often of the same mind. The legislature had tried its best, but had failed. It had exercised some supervision through its inspectors, had forbidden cells to be used until duly certified as fit, and had threatened to withhold exchequer contributions from prisons of which unfavourable reports were received. Such penalties had exercised no sufficient terrors. It began to be understood, moreover, that the prisons under local jurisdictions were not always conveniently and economically situated. Crime, with the many facilities offered for rapid locomotion to those who committed it, had ceased to be merely local, and the whole state rather than individual communities ought to be taxed; prison charges should be borne by the public exchequer and not by local rates. These considerations gained strength and led at length to the introduction of the Prison Bill which became law in 1877, by which the control of all gaols was vested in a body of prison commissioners appointed by and responsible to the home secretary. These commissioners had power to consolidate by closing superfluous prisons, to establish one system of discipline, and generally by watchful supervision, aided by the experience of specialists, to maintain that much-desired uniformity which had been so long and unsuccessfully sought. At the same time the co-operation of the local magistrates was invited so far as advice and assistance were concerned; but all real power and control has passed from their hands into that of the commissioners of prisons. The system established by the act of 1877 is that now in force.

As for penal servitude, the punishment reserved for the gravest offences, great changes had been introduced. We left this branch of the subject at a parliamentary inquiry. The verdict given was in the main satisfactory; but doubts were expressed as to the severity of the discipline inflicted, the principal features of which were moderate labour, ample diet and substantial gratuities. The first was far less than the work free men did for a livelihood, the second larger, the third excessive, so that convicts often left prisons with thirty, forty, even eighty pounds in their pockets. Penal servitude, to use the words of the lord chief justice Sir Alexander Cockburn, one of the members of the committee, "was hardly calculated to produce on the mind of the criminal that salutary dread of the recurrence of the punishment which may be the means of deterring him and, through his example, others from the commission of crime." The chief recommendation put forward to mend the system comprised lengthening of all sentences, a diminution in the dietaries, the abolition of large gratuities, and, speaking broadly, a general tightening of the reins. The most notable change however was in regard to labour, the quantity and value of which was to be regulated in future by the so-called "mark-system." This plan had originated with Captain

Maconochie, at one time superintendent in Norfolk Island, who had recommended that the punishment inflicted upon criminals should be measured, not by time, but by the amount of labour actually performed. In support of his theory he devised an ingenious system of recording the convicts' daily industry by marks, which on reaching a given total would entitle them to their release. This mark system had already been tried with good results in Ireland, where the Irish system, as it was called, introduced by Sir Walter Crofton, had attracted widespread attention. There had been a very marked diminution in crime, attributable it was supposed to this system, which was in almost all respects the same as the English, although the Irish authorities had invented an "intermediate stage" in which convicts worked in a state of semi-freedom and thus practised the self-reliance which in many produced reform. As a matter of fact the diminution in crime was traceable to general causes, such as a general exodus by emigration, the introduction of a poor law and an increase in the facilities for earning an honest livelihood. It may be added here that judged by later experience the Irish system had no transcendent merits, and it is now extinct. But we owe something to the Irish practice which first popularized the idea of maintaining a strict supervision over convicts in a state of conditional release, and it reconciled us to a system which was long wrongfully stigmatized as espionage. The mark system, as recommended by the committee of 1863 and as subsequently introduced, had however little in common with either Maconochie's or the Irish plan. It was similar in principle and that was all. According to the committee, every convict should have it in his power to earn a remission—in other words, to shorten his sentence by his industry. This industry was to be measured by marks earned by hard labour at the public works, after a short probational term of close "separate" confinement. But the remission gained did not mean absolute release. All males were to be sent, during the latter part of their sentence, "without disguise to a thinly peopled colony," to work out their time and their own rehabilitation. The committee still clung to the old theory of transportation, and this in spite of the lively protests of some of its members. The one outlet remaining, however, that of Western Australia, was soon afterwards (1867) closed to convict emigrants; and this part of the committee's recommendations became a dead letter. Not so the mark system, or the plan of earning remission by steady industry. This was carried out on a broad and intelligent basis by officials prompt to avail themselves of the advantages it offered. Thus in 1877-1878 efforts were made to minimize contamination by segregating the worst criminals and restricting conversation at exercise. A special class was formed in 1880, in which all convicts "not versed in crime," first offenders and comparatively innocent men, are now kept apart from the older and more hardened criminals. The committee last quoted gave it as their opinion that "penal servitude as at present administered is on the whole satisfactory; it is effective as a punishment and free from serious abuses . . . a sentence of penal servitude is now generally an object of dread to the criminal population." Since then, steps have been taken in the classification of convicts when undergoing sentence with a view to dealing more effectually with habitual criminals.

Having thus traced the history of secondary punishments and prison discipline in England, it will be well to describe the system now actually in force. This will be best understood if we follow those who break the law through all the stages from that of arrest, through conviction, to release, conditional or complete.

After a short detention in a police cell, an offender, unless disposed of summarily, passes into one of His Majesty's prisons, there to await his trial at sessions or assizes. The period thus spent in the provinces will never exceed three months; in London, with the frequent sitting at Clerkenwell and of the Central Criminal Court, it is seldom more than one month. While awaiting trial the prisoner may wear his own clothes, provide

his own food, see and communicate with his friends and legal adviser so as to prepare fully for his defence. His fate after conviction depends on his sentence. If this be "imprisonment," so called to distinguish it from "penal servitude," although both mean deprivation of liberty and are closely akin, it is undergone in one of the "local" prisons—the prisons till 1878 under local jurisdiction, but now entirely controlled by the state through the home secretary and the commissioners of prisons. The régime undergone is cellular; able-bodied prisoners are kept in strict separation for at least a month, and during that time subjected to severe labour; although the term of first-class hard labour and of purely penal character no longer exists. The tread-wheel has also been abolished. A system of progressive stages based on the mark system has been adopted in the local prisons, and the prisoner's progress through each depends on his own industry and good conduct. During the first month he sleeps on a plank bed, a wooden frame raised from the floor, with bedding but without mattress. When he has earned the proper number of marks, which at the earliest cannot be until one month has elapsed, he passes into the second stage and is allowed better diet and a mattress twice a week. The third stage, at the end of the third month, gives him further privileges as regards diet and bed. The fourth stage concedes to the prisoner a mattress every night, and the privilege, if well conducted, to communicate by letter or through visits with his friends outside. These stages are applicable to females except as regards the plank bed; youths under sixteen and old men above sixty are also allowed mattresses. A small gratuity may be earned during the second and three following stages, amounting in the aggregate to ten shillings. The labour, too, may be industrial, and include instruction in tailoring, shoemaking, basket-making, bookbinding, printing, and many more handicrafts. Throughout the sentence the prisoner has the advantage of religious and moral instruction; he attends divine service regularly, and whatever his creed is visited by a chaplain professing it, and receives educational assistance according to his needs. His physical welfare is watched over by competent medical men; close attention is paid to the sanitary condition of prisons; strict rules govern the size of cells, with their lighting, warming and ventilation. Diets are everywhere the same; they are calculated with great nicety according to the time of duration, and afford variety and ample nutrition without running into excess. In a word, as regards discipline, labour, treatment, exactly the same system obtains in the "local" prisons throughout the United Kingdom.

Where the sentence passes beyond two years it ceases to be styled imprisonment and becomes penal servitude, which may be inflicted for any period from three years to life. The prisoner becomes a convict and undergoes his penalty in one or more of the convict prisons. These are entirely under state management. A sentence of penal servitude as now administered, consists of three distinct periods or stages: (1) that of probation endured in separate confinement at a so-called "close" prison; (2) a period of labour in association at a public works prison; and (3) conditional release for the unexpired portion of the sentence upon licence or ticket-of-leave.

1. In the first stage, which was limited to six months, but which it is proposed to reduce to one month, the convict passes his whole time in his cell apart from other prisoners, engaged at some industrial employment. He exercises and goes to chapel daily in the society of others, but holds no communication with them; his only intercourse with his fellow-creatures is when he is visited by the governor, chaplain, schoolmaster or trade instructor. This period of almost unbroken solitude is of a painful character, and its duration has therefore been wisely limited.

2. The second is a longer stage and endures for the whole or a greater part of the remainder of the sentence, its duration being governed by the power a convict holds in his own hands to earn a remission. It is now passed at a public works prison; either at Aylesbury (females), Borstal, Dartmoor, Parkhurst or Portland. While cellular separation, except at work,

at prayers or exercise, is strictly maintained, labour is in association under the close and constant supervision of officials. Intercommunication no doubt takes place; men working together in quarry, brickfield or barrow-run, and out of earshot of their guardians, may and do converse at times. But the work is too arduous to allow of long and desultory conversation; the chance of contamination is now minimized by the careful separation of the less hardened from the old offenders. There is no reason to suppose that any great evils arise from this association, and without it the execution of the many important national public works which now attest its value would have been impossible. Among these may be mentioned the following: the quarrying of stone for the great Portland breakwater, nearly 2 m. in length and between 50 and 60 ft. deep in the sea, with the defensive works on the Verne, batteries, casements and barracks intended to render the island of Portland impregnable, and the enlargement and extension of the dockyards at Chatham and Portsmouth. At Borstal a line of forts intended to protect Chatham on the south and west have been erected by convicts; they have also built magazines at Chattenden on the left bank of the Medway. Besides this, convict labour has been usefully employed in the erection of prison buildings at new points or in extension of those at the old. In all cases the bricks have been made, the stone quarried and dressed, the timber sawn, the iron cast, forged and wrought by the prisoners. The great merit of this system is the skill acquired in handicrafts by so many otherwise idle and useless hands. Convict mechanics are rarely found ready made. It is a fact that a large percentage of the total number employed at trades learnt them in prison. These results are no doubt greatly aided by the judicious stimulus given to the highest effort of the mark system. The chief objection to enforced labour has been the difficulty in ensuring this; but the convict nowadays eagerly tries his best, because only thus can he win privileges while in prison and an earlier release from it. Every day's work is gauged and marks recorded according to its value; upon the total earned depends his passage through the stages or classes which regulate his diet and general treatment, and more especially his interviews and communications with his relations and friends. Yet more; steady willing labour continuously performed will earn a remission of a fourth of the sentence. It must be borne in mind that the marks thus earned may be forfeited at any time by misconduct, but affect remission to this extent only. The full remission in a five years' sentence is one year and ninety-one days; in seven years, one year two hundred and seventy-three days; in fourteen, three years one hundred and ninety-seven days; in twenty, four years one hundred and ninety days. "Lifers" cannot claim any remission, but their cases are brought forward at the end of twenty years and then considered on their merits.

3. Having earned his remission the convict enters upon the third stage of his punishment. He is released, but only conditionally, on licence or ticket-of-leave. This permission to be at large may easily be forfeited by fresh breaches of the law. Stringent conditions are endorsed upon the licence and well known to every licence holder (see TICKET-OF-LEAVE).

Further modifications have been introduced from time to time in the British penal system, tending mostly to milder discipline, more intelligent classification of prisoners and a certain amelioration of their lot. In its general outlines the system as set forth above has been maintained, but the departmental committee appointed in 1895 made some important recommendations which were presently adopted in part. The committee was dissatisfied with the moral results achieved and thought that more attention should be paid to reformatory processes. They believed that "few inmates left prison better than when they came in." Reconvictions were frequent and recidivism on the increase. Imprisonment was not sufficiently deterrent to the habitual criminal class, and small attention was paid to the reclamation of less hardened offenders. The views of this committee were embodied in a Penal Servitude bill which was long debated, but became law in 1898. It

emphasized the excellence of the system devised in 1879 for the segregation of the comparatively innocent from convicts hardened in crime. The system of the "star" class as originally established provided that the prisoner never previously convicted should be kept absolutely apart, at chapel, labour, exercise and in quarters, from his less fortunate fellows who had already been imprisoned. The rule was strictly enforced and with the most conspicuous results, so that little more than 1% of "stars" have been re-convicted when once more at large. The privilege of the "star" is only accorded after careful inquiry and reasonable proof that the individual has never before been sent to prison. Reference is made to the police at the time of conviction, and the duty of looking into previous and present character is very strictly performed. The inquiry is continuous and may be prolonged into the sentence; then, if necessary, correction is applied. But as a matter of fact very few mistakes are made. It is obvious that wrongful admission into the "star" class might be fraught with mischievous consequences, and it is well known that a first sentence does not necessarily mean absolute unacquaintance with crime. For administrative convenience the "stars"—whose name comes from the scrap of crimson cloth worn on cap and jacket sleeve—have been generally concentrated at Portland, and employed in labours specially allotted to them, for the most part demanding a higher rate of intelligence than the general average shown by convicts. Moulders, blacksmiths, carpenters, tinsmiths, stonemasons, bookbinders, painters and various other trades and handicrafts are the peculiar province of the "stars."

The Prison Act of 1898 made some marked changes in penal discipline. One was the strict limitation of corporal punishment to offences of mutiny and gross personal violence to officers, where previously it might be inflicted for many forms of misconduct, and it can only now be adjudged under great restrictions. It was feared that the removal of this powerful deterrent would adversely affect discipline, but on the contrary, the yearly average of prison offences has diminished from 147 to 131 per thousand prisoners, and it has been felt by the authorities that the limitation was salutary and wise. Another change was the power given to courts of law to differentiate between offenders by ordering them one of three classes of treatment ranging from severe to less rigorous. The first of these divisions was akin to that of former first-class misdemeanants; the second division was allotted to persons guilty of trivial offences not amounting to moral depravity, the third division was apportioned to serious crime calling for severe repression, involving strict separation for the first twenty-eight days with "hard labour" (now an obsolete expression, since all prison labour is nowadays accounted "hard"). The scheme was judicious, but courts have been slow to make use of its provisions. Yet a third improvement was permission conceded to prisoners locked up in default of payment of fine, to obtain a reduction of time proportionate to part payment of the fine. The numbers under both categories are considerable, and taken together show a steady increase in the ten years from 1892 (when the acts first came into effect) to 1902, the figures being 33,802 in 1892 and 51,302 in 1902.

Imprisonment, albeit somewhat modified and diluted, continues to be used as the chief penalty and most trusted panacea for all crime. The medicine is so simple in application and so easily available that it is served out almost automatically and indifferently to every law-breaker; the pickpocket and the burglar are locked up next door to the clergyman at variance with his bishop; the weak-kneed and self-indulgent drunkard rubs shoulders with the political zealot who has endangered the peace of nations. There is an enormous mass of so-called crime in England which is not crime at all, and still is perpetually penalized by an infliction of imprisonment for such short periods as to be perfectly futile. The bulk of the offences for which it is meted out are trivial and unimportant. Eighty-three per cent of the annual convictions, summarily and on indictment, followed by committal to gaol, are for misconduct that is distinctly non-criminal, such as breaches of municipal by-laws and police regulations, drunkenness, gaming and offences under the

vagrancy acts. The leniency of the sentences indicates the comparatively trifling character of the wrongdoing. Forty per cent. of the males and 39% of the females were sent to prison for periods of a week or less; on the other hand, no more than 4% were sentenced to six months and under, only 2% were imprisoned for terms between six months and one year; and 75% to more than one year. The question will arise some day whether it is really necessary to maintain fifty-six local prisons, with all their elaborate paraphernalia, their imposing buildings and expensive staff, to maintain discipline in daily life and insist upon the proper observance of customs and usages, many of them of purely modern invention. Of course there is in most cases the alternative of a fine, the non-payment of which entails the imprisonment; yet a penalty imposed on the pocket is so clearly the proper retribution for such misdeeds that better methods should be devised for the collection of fines.

The chief aim of penal legislation should indeed be either to keep gaols empty or to use them only where distinct reduction in the number of offenders, whether by regeneration or by continuous withdrawal from noxious activity, can be obtained. An axiom based upon this view has been formulated, and although paradoxical it may well be quoted here. The great aim and object of all penal processes, it has been said, should be the recognition of the general principle of dividing all offenders into two categories: (1) those who ought never to enter a gaol, and (2) those who ought never to be allowed to leave it. Praise-worthy efforts to compass the first end have been made in recent legislation. The First Offenders Act in 1887 had the effect of postponing sentence and sparing these offenders from incarceration subject to their good conduct. An average of about 4500 thus escaped imprisonment in the five years between 1893 and 1897, and an average of 5500 the five following years. The gain in this was great, seeing that no more than 6 to 8% were actually sent to gaol after the commission of a second offence, and that there was therefore a very distinct saving in expense of maintenance of prisoners incarcerated. The value of this act is to be seen in its wide adoption. It is in force in some of the states of the American Union. It was adopted in France by the Berenger law of 1891, and in Belgium, where 14% of sentences of imprisonment in one year and a-half were postponed. In some countries the concession has been accompanied by admonition. The Summary Jurisdiction Acts, by which large numbers of minor offenders were discharged on bail, or subjected to fines or very brief terms of imprisonment, have also tended to diminish the prison population enormously. The number annually discharged increased from 33,000 in 1893 to 51,302 in 1902. This excellent system has commended itself to many countries and it is now adopted by the bulk of governments and jurisdictions owing allegiance to the British Crown.

Two new systems of applying imprisonment have commended themselves to English administrators, and both have been effected by the Prevention of Crime Act 1908. The first is a new method for educating and reforming young offenders, already on the frontiers of habitual crime, no longer children, but at an age still susceptible of permanent improvement; the second is the legal acceptance of the principle of indefinite detention, the willingness to inflict an indeterminate sentence on those who have already forfeited the right to be at large.

Both these measures originated in the United States. The Borstal scheme of a juvenile-adult reformatory has been to some extent planned on the institutions of Elmira reformatory in the state of New York and of Concord in Massachusetts (see JUVENILE OFFENDERS). Side by side with the new processes introduced, the idea of the indeterminate sentence was started and put in practice, by which release was made to depend upon reasonable hope of amendment and sentences were prolonged until it was more or less certain that the treatment had resulted in cure.

Other measures are set forth in the new classification of convicts, prescribed by the secretary of state in the rules submitted by him to the House of Commons in 1904. All convicts

are classed in three categories, viz. (A) the Ordinary division; (B) the Habitual Offenders' division; and (C) the Long Sentence division.

The "A" or Ordinary division comprises all ordinary convicts under old rules who are still separated into the three classes of "star," intermediate and recidivist, as provided by the act of 1898. The qualifications for each class are clearly laid down. Only those never previously convicted, or known as of not habitually criminal or corrupt habits, are eligible for the "star" class. The intermediate class takes those not previously convicted but deemed unsuitable as "stars" from antecedents and generally unsatisfactory character. The recidivist class is for those previously sentenced to penal servitude or whose record shows them to have been guilty of grave and persistent crime.

These three classes begin with cellular confinement, but for varying periods; the first for three months, the second six months and the third for nine months, in all cases subject to a medical report upon mental and physical condition. Female convicts pass the first three months of their sentence in separate cells.

The "B" division indicates the worst penalties to be inflicted upon habitual criminals. There is no recognition whatever of the principle of the indeterminate sentence. The law merely prescribes the forfeiture of all remission. The convict is not eligible for release or licence, but when the time of conditional liberation would have formerly arrived the case is submitted to the authorities and dealt with on its merits. Early release depends upon the reports on industry and conduct, and the prospect of his keeping straight if set free. He may have to "do" his whole time but not an hour beyond it.

Certain privileges are conceded to the "B" division to compensate those in it for the loss of remission. They wear a special dress, a band of blue cloth on the left arm; they may earn an extra gratuity and spend a part of it in buying extra food or articles of comfort and relaxation; they may take their meals in association, converse at them or at exercise, but not at labour.

The "C" division has been designed for convicts serving long sentences, who have gained all possible privileges in the early years of sentence and have little or nothing to expect further until the last year of their sentence, when they may earn an additional gratuity. But after ten years they may enter the "C" division, earn a special gratuity therein, and enjoy the various privileges accorded to the "B" or habitual criminals' division with the additional advantage that there is no interference with their remission.

Still milder and more humanitarian prison treatment was that put forward by the home secretary in 1910 in his speech already referred to. In it he suggested that the following reforms should be carried out, some by administrative order and some by future legislation: (1) time for the payment of fines inflicted for minor offences; (2) disciplinary treatment outside prison for all offenders under 21 years of age; (3) punishment of those guilty of offences not involving moral turpitude to be relieved of all degrading features; (4) the reduction of the period of solitary confinement to a maximum of one month; (5) and the abolition of the ticket-of-leave system. It was also proposed to give four lectures or concerts a year in convict prisons.

Prisons in other Countries.—The general progress made in prison treatment will be best realized by a brief survey of penal institutions in the principal countries of the world. It will be convenient to take them alphabetically.

1. *Austria-Hungary.*—The régime of cellular confinement has not been universally adopted; only six prisons are built on that principle and no more than 15% of the whole number of prisoners can be subjected to the system. Cellular separation is not inflicted for long periods, the minimum being six months and the maximum three years. The bulk of the prisoners live and labour in common. A great feature has been the execution of public works by prisoners in a state of semi-liberty beyond prison walls—the practical adoption of the so-called "Irish" or intermediate prison—and good results are seen in road-making and the improvement of river courses.

2. *Belgium.*—This country has spared neither pains nor money in carrying out penal processes, and the Belgian prisons are examples of the cellular system prolonged to the utmost limits of human endurance. There is a minimum of ten years, but the individual may elect to continue in separation, or be transferred to partial association. A new school of Belgian criminologists has been headed by M. Prins, the chief of the prison department, who has protested that to hope the vicious, hardened offender, after a long detention, "surrounded with every attention, soaked with good counsel, will leave his cell regenerated," is a Utopian dream.

3. *British Dominions beyond the Sea.*—The principle of cellular separation was accepted as far back as 1836 and the model prison of Pentonville, opened in 1842, has since been copied throughout the civilized world. The cellular system has been adopted in all British colonies with various modifications, and prisons built on modern principles are to be found in Canada, Australia, New Zealand and the Cape of Good Hope. India retains association as the system most suitable for its criminal classes, with other methods generally abandoned in Great Britain, such as the employment of well-conducted prisoners as auxiliaries in prison discipline and service; deportation is still the penalty for the worst offences and is carried out on a large scale and with satisfactory results in the Andaman Islands. In Egypt since the establishment of British control a very marked change has been introduced in prison affairs.

4. *Denmark.*—In Denmark all convicted prisoners pass through several stages, from cellular treatment to the intermediate prison and conditional liberty. Two new prisons on the latest model have been erected at Copenhagen, one for males and the other for females. The smaller gaols for short terms are mostly on the cellular plan.

5. *France.*—France has devoted very considerable attention to prison matters and is now practising the two extremes of treatment, the strict cellular isolation of the Belgian system and the penal exile or transportation which was long the English rule.

6. *Germany.*—The unified German Empire has not as yet adopted one system of prison treatment, and its various component kingdoms still retain independence in views and practice.

Baden has a well-known cellular prison at Bruchsal, but separation is not imposed for more than four years and associated labour is carried out in another quarter of the prison.

Bavaria has four cellular prisons, the chief being at Munich and Nuremberg, but the collective system also obtains.

Prussia having declared for the cellular system constructed the well-known Moabit prison in Berlin, also those of Ratibor in Silesia and of Herford in Westphalia, while those of Graudenz, Breslau, Werden and Cologne have been added since. The total number of separate cells to-day is 11,041 against 3247 in 1869. Two new cellular prisons, Luttringhausen and Saarbruck, have recently been added. Frankfurt has a good prison on the Pentonville (London) plan; so has Hamburg; and new buildings have been erected at Wohlan, Siegburg, Breslau and Munster. Separate cells in Prussia had increased in 1896 from 3247 to 6573. The cellular régime is applicable to prisoners between 18 and 30, and to first offenders of 50 years of age, the term being fixed by the governor of the gaol, but never exceeding three years.

Saxony established a penitentiary at Zwickau in 1850 and in its earlier management exhibited exaggerated kindness to its inmates. Both the cellular and the associated systems obtain.

Württemberg has accepted the cellular system. There are prisons for females at Heilbronn, and for males at Ludwigsburg and Stuttgart; in Württemberg itself the régime is collective.

7. *Holland* has followed her nearest neighbour Belgium and has now at command separate cells sufficient to receive the whole number of her prison population. The system of unbroken seclusion, prolonged to five years, is maintained with strictness.

8. *Italy.*—Although accepting the principle of cellular imprisonment, Italy has not adopted it largely, partly from want of funds and not a little because the current of thought has set against it. The really penal establishments are 77 in number, the great *ergastolo* of San Stefano being one. Agricultural labour for convicts has been tried in colonies of *coatti* (or those provisionally released) planted out in the islands of the Italian archipelago.

9. *Norway.*—The separation of Norway, as an independent state, from Sweden has produced no great change in its prison institutions, which still follow the lines of the neighbouring country.

10. *Portugal.*—There are three or more cellular prisons at Lisbon, Coimbra and Santarem, and the system of strict separation when first adopted in 1884 was expected both to amend and deter.

11. *Sweden.*—Prince Oscar of Sweden was one of the earliest adherents of cellular imprisonment, and at his urgent representation penitentiary reform was warmly espoused in 1841. His influence is still felt, and the system in force in Norway and Sweden is progressive from strict separation to working outside the cell. Sweden, which adopted the cellular system in 1842, has now cells sufficient for prisoners sentenced to two years and less. There are three principal central prisons, one at Langholm near Stockholm, a second at Malmo and a third at Mya Varfet near Gothenburg.

12. *United States.*—The penal system of the United States varies between being the most advanced and the most backward in the civilized world. At one end of the scale are the numerous bad

county gaols and the horrors of the convict lease system in the southern states, now nearly extinct; at the other such modern and well-equipped reformatories as Elmira and Concord (see JUVENILE OFFENDERS). The worst feature is the indiscriminate association sometimes seen of all inmates, bond and free, the convicted and accused; even witnesses against whom there is no shadow of a charge are sometimes imprisoned among felons. Nor is it only in distant corners of the great continent that this criticism applies, though constant improvements are removing the grounds for it. It is only a short time since the local gaol in the city of New York, "the Tombs," a house of detention for prisoners awaiting trial, was described in an official report to the state legislature as "a disgrace. . . . It is defective in every modern appliance. It is dark, damp and ill-ventilated. . . . worst of all is the hideous system of keeping two or three men in a cell; . . . a means of indescribable torture to a decent man and a prolific source of vice and crime to a criminal. Such treatment of dogs would be gross cruelty." This building has, however, now been pulled down, and a new and better one has taken its place. The administration of prisons rests mainly with the various state authorities, and there is no federal or general system which would introduce uniformity of treatment. The federal government has no influence or control except for offences against the federal laws, regulating coinage, postal service, the revenue and so forth. Prison management is essentially a local concern, but some general features are common to all states, such as the rule that while petty offenders and prisoners awaiting trial are under county and city jurisdiction, the state takes charge of all persons convicted of serious crimes. The state prisons receive by far the largest proportion of the criminal population, more than half the general total being imprisoned therein. Some of them are models of cleanliness and good order, built on the best and most imposing lines with large comfortable cells and an abundance of light and air. The earnest desire of most prison administration is to develop industrial training and trade profits side by side with mildness of treatment. The latter sometimes lapses into methods which are not usually thought compatible with prison discipline, such as the permission to play on musical instruments, the holding of concerts, the privilege of smoking and chewing tobacco, of receiving baskets of provisions, novels and newspapers from friends outside.

It is worthy of note that prison architecture in the United States misses many of the gloomy features common to such constructions. The newest prisons are generally lighter, more roomy, better ventilated and on the whole more comfortable than even the best British prisons. In 1900 Sir E. Ruggles Brise, the English expert on prisons, declared that "the purity of the air and the cleanliness of the American prisons are admirable, and under a very elaborate system of warming by hot air, a regular and uniform temperature is sustained throughout the year, which, considering the varying nature of the climate from extreme heat to cold many points below zero, is a considerable engineering triumph."

Prison Industries.—It is an axiom in prison science that enforced labour cannot easily be made productive. No doubt the problem has been in a measure solved in England by that useful incentive to industry, the mark system. But the more substantial returns cannot always be expected with the sedentary employments and single-handed effort inseparable from the régime of cellular imprisonment. England for many years past, in adopting the principle of Public Works Prisons after a certain short period spent in separation, has pronounced in favour of open-air employment in association. Although the system still has many hostile critics its value cannot be contested. It has been said by a trustworthy authority,¹ "We are convinced also that severe labour on public works is most beneficial in teaching criminals habits of industry and training them to such employments as digging, road-making and brick-making—work of a kind which cannot be carried on in separate confinement." A good proof of the value of the system as remunerative and healthful, morally and physically, is seen in the growing desire of other countries to follow our lead. Very similar operations have been carried out in Austria-Hungary, where large tracts of land have been brought into cultivation, and watercourses have been diverted successfully despite serious difficulties, climatic and physical; in Russia convict labour has been largely used in the construction of the Trans-siberian railway; the military operations in the Sudan were greatly aided by convict labourers engaged in useful work at the base and all along the line; Italy passed a law in 1904 enacting outdoor labour for the reclamation and draining of waste lands by prisoners under long sentence; and France, although much wedded to cellular imprisonment, is beginning to favour extra-mural employment of prisoners under strict regulations. The subject was discussed at the Penitentiary Congress at Budapest in 1905, and a resolution passed recommending extra-mural employment for prisoners of rural origin, vagrants and drunkards, and those subject to tuberculous disease, "so largely the concomitant of cellular confinement."

Prison industries continue to be largely sedentary in character; they cover a wide range, although the conditions of life are for the most part artificial. Most trades and handicrafts are practised, such as shoemaking, tailoring, carpentry, the work of white-

blacksmiths; skilful and intelligent workmen, such as the French and Japanese, find a wide outlet for their versatile and artistic talent. The well-known products, styled *articles de Paris*, prison-made, find a large sale, and many objects of high art, fine paintings, cloisonné enamels and gold lacquer are among the beautiful products from Japanese prisoners. The indoor manufactures followed in British prisons are not so varied as the foregoing and have been limited by the protests and objections raised by free or outside labour against alleged unfair competition. Accordingly, the production of goods has been largely curtailed for the open market and prison labour is restricted nowadays to supplying articles required for current use by public departments—such as the navy, army, post office and, of course, all prison establishments. Prison labour has found an outlet, therefore, in such work as service blanket making, hammock making, mail-bag making, the manufacture of cartridge cases, flags, chopping firewood for barracks and so on, having been diverted almost entirely from mat-making, once an exclusive prison trade originally invented indeed by prison task-masters. The total annual value of the labour applied in English prisons has varied. In 1896–1897 the total accruing from manufactures, farm operations and the ordinary service of the prison was £213,812, the prison population in local and convict prisons being 17,614; in 1903–1904 the total amounted to £244,518, the prison population on the 31st of March 1904 being 21,117. The gross expenditure was £524,289 for 1896–1897, as against £615,656 for 1903–1904. Figures are not available for any exact comparison of outlay and return in other countries, but the earnings in European countries generally run to about half the expenditure. In the United States the policy varies between the two extremes of making prisoners self-supporting and of leaving them in idleness so that the whole weight of expense falls upon the state. In some states economic considerations have carried the day; in others the stringency of labour laws under the pressure of labour associations has paralysed all prison industry. In the first mentioned, the contract system, by which a contractor hires the prisoner's labour from the state, has proved very profitable, but at the sacrifice of discipline and neglect of reformatory processes upon the individual. This leasing-out system has been carried further in some of the southern states, and has produced the convict camps, which have been much criticized and condemned from the harshness of the discipline enforced, the many abuses that exist and the meagre results other than monetary that have been obtained.

The modern movement in favour of industrial employment combined with humane and intelligent considerations has swept away the more or less barbaric method of enforcing labour by automatic machinery such as the treadmill, crank and shot drill (see TREADMILL).

AUTHORITIES.—John Howard, *State of Prisons in England and Wales* (1784); Cesare Lombroso, *L'Uomo delinquente*, &c. (1899); Beaumont and A. de Tocqueville, *Système pénitentiaire aux États-Unis* (1837); Crawford, *Report on Penitentiaries* (U.S.A., 1838); Maconochie, *Prison Discipline* (1856); Dr Guillaume, *Progress of Prison Discipline in Switzerland* (1872); Arthur Griffiths, *Memorials of Millbank* (1873), *Chronicles of Newgate* (1882); Armingol y Cornet, *Prisons and Prison Discipline in Spain* (1874); Stevens, *Régime des établissements pénitentiaires en Belgique* (1875); F. V. Holtzendorf and von Jagemann, *Handbuch des Gefängniswesens* (1877); Scaglia Beltrani, *Reforma penitenciaría in Italia* (1879); Sir Edmund F. Du Cane, *Punishment and Prevention of Crime* (1885); Braco, *Estudios penitenciarios e criminaes* (Lisbon, 1888); Garfalo, *Studio sul delitto, sulle sue cause e sui mezzi di repressione* (1890); Adolphe Guillot, *Les Prisons de Paris* (1890); Tallack, *Preventive and Penological Principles* (1896); Salillas, *Vida penal en España* (Madrid).

(A. G.)

PRISONERS' BASE (PRISONERS' BARS), an ancient game much affected by children. The players are divided into two sides, each standing within a base or home marked off at some distance apart. After preliminary songs and war-like challenges, a player on one side runs out and is pursued by one of "the enemy"; if touched he becomes a prisoner of the side to which his captor belongs. If another player from the side of the pursued runs between him and his pursuer, the latter has to follow *him*, but the last to leave his base is privileged to touch any one of the enemy who left his base before him. The rules of the game are, however, traditional, and necessarily somewhat elastic. The end comes, of course, when all of one side have been captured by the other.

PRITCHARD, CHARLES (1808–1893), British astronomer, was born at Alberbury, Shropshire, on the 20th of February 1808. At the age of eighteen he was enrolled as a sizar at St John's College, Cambridge, whence he graduated in 1830 as fourth wrangler. In 1832 he was elected fellow of his college, and in the following year he was ordained, and became head master of a private school at Stockwell. From 1834 to 1862 he was headmaster of Clapham grammar school. He then

¹ *Report of the Royal Commission on Penal Servitude* (1878–1879).

retired to Freshwater, in the Isle of Wight, and took an active interest in the affairs of the Royal Astronomical Society, of which he became honorary secretary in 1862 and president in 1866. His career as a professional astronomer began in 1870, when he was elected Savilian professor of astronomy at Oxford. At his request the university determined to erect a fine equatorial telescope for the instruction of his class and for purposes of research, a scheme which, in consequence of Warren de la Rue's munificent gift of instruments from his private observatory at Cranford, expanded into the establishment of the new university observatory. By De la Rue's advice, Pritchard began his career there with a determination of the physical libration of the moon, or the nutation of its axis. In 1882 Pritchard commenced a systematic study of stellar photometry. For this purpose he employed an instrument known as the "wedge photometer" (see PHOTOMETRY, CELESTIAL, and *Mem. R.A.S.* xlvii. 353), with which he measured the relative brightness of 2784 stars between the North Pole and about -10° declination. The results were published in 1885 in his *Uranometria Nova Oxoniensis*, and their importance was recognized by the bestowal in 1886 upon him, conjointly with Professor Pickering, of the Royal Astronomical Society's gold medal. He now resolved to try the experiment of applying photography to the determination of stellar parallax. With the object of testing the capabilities of the method, he took for his first essay the well-known star β Cygni, and his results agreed so well with those previously attained that he undertook the systematic measurement of the parallaxes of second-magnitude stars, and published the outcome in the third and fourth volumes of the Publications of the Oxford University Observatory. Although some lurking errors impaired the authority of the concluded parallaxes this work ranks as a valuable contribution to astronomy, since it showed the possibility of employing photography in such delicate investigations. When the great scheme of an international survey of the heavens was projected, the zone between 25° and 31° north declination was allotted to him, and at the time of his death some progress had been made in recording its included stars. Pritchard became a fellow of New College, Oxford, in 1883, and an honorary fellow of St John's College, Cambridge, in 1886. He was elected a fellow of the Royal Society in 1840, and in 1892 was awarded one of the royal medals for his work on photometry and stellar parallax. He died on the 28th of May 1893.

See *Proc. Roy. Soc.* liv. 3; *Month. Notices, Roy. Astr. Soc.* liv. 198; W. E. Plummer, *Observatory*, xvi. 256 (portrait); *Astr. and Astrophysics*, xii. 592; J. Foster, *Oxford Men and their Colleges*, p. 206; *Hist. Register of the Univ. of Oxford*, p. 95; *The Times* (May 30, 1893); C. J. Robinson's *Register of Merchant Taylors' School*, ii. 210; Charles Pritchard, D.D., *Memoirs of his Life*, by Ada Pritchard (London, 1897).

PRITCHARD, HANNAH (1711-1768), English actress, whose name before her early marriage—to an actor—was Vaughan, first attracted attention as a singer at Bartholomew's Fair in 1733. She was soon playing a wide variety of parts, mostly comedy, at the Haymarket, Drury Lane and Covent Garden. When Garrick became patentee of Drury Lane in 1747 she joined his company and played with him for twenty years, her last appearance being as Lady Macbeth—one of her greatest rôles—in April 1768, a few months before her death. Her talents were highly thought of by the critics of the day. Her daughter, who had studied under Garrick, and whose beauty created a sensation when she made her début (as "Miss Pritchard") in October 1756, did not live up to the expectations then raised. She married in 1762 the actor John Palmer, retired from the stage at the same time as her mother, and after her husband's death married a political writer named Lloyd.

PRITTLEWELL, a residential parish in the borough of Southend-on-Sea, and in the S.E. parliamentary division of Essex, England; lying $1\frac{1}{2}$ m. inland (N.N.W.) from Southend, with a station on the Southend branch of the Great Eastern railway. The church of St Mary the Virgin has fine Perpendicular work and traces of Norman work. There are fragments of a Cluniac priory of the 12th century. Pop. (1901), 27,245.

PRIVAS, a town of south-eastern France, capital of the department of Ardèche, 95 m. S. by W. of Lyons on a branch line of the railway from that city to Nîmes. Pop. (1906), town, 3495; commune, 7000. Privas is situated near the Ouvèze, here joined by the Mezayon and Chazalon. The town is the seat of a prefecture, a court of assizes and a tribunal of first instance. Other institutions are training colleges for both sexes, a communal college and a lunatic asylum for the departments of Ardèche and Drôme. Silk-milling is carried on. The rearing of silkworms and the cultivation of the mulberry are widespread industries. There are mines of iron ore in the vicinity. Trade is in silk, tanned leather, game, chestnuts and fruit preserves.

Privas is first heard of in the 12th century, as a possession of the counts of Valentinois, and subsequently became the seat of a separate barony. One of the strongholds of the Reformed Faith, it suffered terribly during the Wars of Religion. Ineffectually besieged by the royal troops in 1574, it passed in 1619, by the marriage of the heiress of the barony, Paule de Chambaud, into the possession of the vicomte de Lestrange, a Roman Catholic noble. A general rising followed, and in 1629 it was besieged and taken by Louis XIII. It was reduced to ruins, and the king decreed that it should not be again inhabited; but in 1632, some of the townspeople having fought against Lestrange, who had joined Montmorency's rebellion, the inhabitants were allowed to return. Some ancient houses, which escaped the general destruction, are still standing.

PRIVATEER, an armed vessel belonging to a private owner, commissioned by a belligerent state to carry on operations of war. The commission is known as *letters of marque*. Acceptance of such a commission by a British subject is forbidden by the Foreign Enlistment Act 1870. Privateering is now a matter of much less importance than it formerly was, owing to the terms of art. 1 of the Declaration of Paris, April 16, 1856, "Privateering is and remains abolished." The declaration binds only the powers who are signatories or who afterwards assented, and those only when engaged in war with one another. The United States and Spain have not acceded to it, but though it did not hold as between them in the war of 1898, they both observed it. Privateers stand in a position between that of a public ship of war and a merchant vessel, and the raising of merchant vessels to the status of warships has in recent wars given rise to so much difficulty in distinguishing between volunteer war-ships and privateers that the subject was made one of those for settlement by the Second Hague Conference (1907). The rules adopted are as follows:—

1. A merchant-ship converted into a war-ship cannot have the rights and duties appertaining to vessels having that status unless it is placed under the direct authority, immediate control and responsibility of the power the flag of which it flies.
2. Merchant-ships converted into war-ships must bear the external marks which distinguish the war-ships of their nationality.
3. The commander must be in the service of the state and duly commissioned by the proper authorities. His name must figure on the list of the officers of the fighting fleet.
4. The crew must be subject to military discipline.
5. Every merchant-ship converted into a war-ship is bound to observe in its operations the laws and customs of war.
6. A belligerent who converts a merchant-ship into a war-ship must, as soon as possible, announce such conversion in the list of its war-ships.

In connexion with the conversion of the "Peterburg" and "Smolensk" on the high seas during the Russo-Japanese War, and the ruse by which they came through the Bosphorus and the Dardanelles, it was agreed, after a vain attempt to solve the question in a way satisfactory to all parties, that the subject of whether the conversion may take place upon the high seas should remain outside the scope of the convention. (T. BA.)

PRIVET, in botany, the vernacular name of *Ligustrum*,¹ a genus of Oleaceae, containing about thirty-five species, natives

¹Other vernacular names for the common species are prim, primprint, primwort and primrose.

of temperate and tropical Asia; only the common privet is a native of Europe. They are shrubs or low trees with evergreen or nearly evergreen opposite entire leaves, and dense clusters of small, white, tubular four-parted flowers, enclosing two stamens and succeeded by small, globular, usually black berries, each with a single pendulous seed. The best-known species is the common European privet, *L. vulgare*, which makes good hedges; *L. ovalifolium* (a native of Japan) thrives by the seaside and even in towns; there is a yellow-leaved variety (var. *variegatum*), the leaves becoming white as they get older. *L. lucidum* (China) is taller and handsomer. There are numerous varieties of *L. vulgare* in cultivation; var. *buxifolium* has broader and more persistent leaves; var. *fructu-luteum* has bright yellow fruit; var. *pendulum* has long weeping branches; and var. *variegatum* has the leaves variegated with bright yellow. *L. japonicum*, *L. Massalongoianum* (Khassia Hills) and other species are also cultivated. Mock-privet is *Phillyrea*, a member of the same order and a small genus of ornamental hardy evergreen shrubs, natives of the Mediterranean region and Asia Minor.

PRIVILEGE, in law, an immunity or exemption conferred by special grant in derogation of common right. The term is derived from *privilegium*, a law specially passed in favour of or against a particular person. In Roman law the latter sense was the more common; in modern law the word bears only the former sense. Privilege in English law is either *personal* or *real*—that is to say, it is granted to a person, as a peer, or to a place, as a university. The most important instances at present existing in England are the privilege of parliament (see PARLIAMENT), which protects certain communications from being regarded as libellous (see LIBEL and SLANDER), and certain privileges enjoyed by the clergy and others, by which they are to some extent exempt from public duties, such as serving on juries. Privileged copyholds are those held by the custom of the manor and not by the will of the lord. There are certain debts in England, Scotland and the United States which are said to be privileged—that is, such debts as the executor must first apply the personal estate of the deceased, in payment, for example, of funeral expenses or servants' wages. In English law the term "preferred" rather than "privileged" is generally applied to such debts. There are certain deeds and summonses which are privileged in Scots law, the former because they require less solemnity than ordinary deeds, the latter because the ordinary *induciae* are shortened in their case (see Watson, *Law Dict.*, s.v. "Privilege").

In the United States the term privilege is of considerable political importance. By art. iv. § 2 of the constitution, "the citizens of each state shall be entitled to all privileges and immunities of citizens in the several states." By art. xiv. § 1 of the amendments to the constitution (enacted July 28, 1868), "no state shall make or enforce any law which shall abridge the privileges or immunities of citizens of the United States." It will be noticed that the former applies to citizens of the states, the latter to citizens of the United States. "The intention of this clause (art. iv.) was to confer on the citizens of each state, if one may so say, a general citizenship, and to communicate all the privileges and immunities which the citizens of the same state would have been entitled to under the like circumstances" (Story, *Constitution of the United States*, § 1806). The clauses have several times been the subject of judicial decision in the Supreme Court. With regard to art. iv., it was held that a state licence tax discriminating against commodities the production of other states was void as abridging the privileges and immunities of the citizens of such other states (*Ward v. State of Maryland*, 12 Wallace's Reports, 418). With regard to art. xiv. 1, it was held that its main purpose was to protect from the hostile legislation of the states the privileges and immunities of citizens of the United States, looking more especially to the then recent admission of negroes to political rights. Accordingly it was held that a grant of exclusive right or privilege of maintaining slaughter-houses for twenty-one years, imposing at the same time the duty of providing ample con-

veniences, was not unconstitutional, as it was only a police regulation for the health of the people (*The Slaughter-House Cases*, 16 Wallace, 36). The same has been held of a refusal by a state to grant to a woman a licence to practise law (*Bradwell v. The State*, 16 Wallace, 130), of a state law confining the rights of suffrage to males (*Minor v. Happersett*, 21 Wallace, 162), and of a state law regulating the sale of intoxicating liquors (*Barthemeyer v. Iowa*, 18 Wallace, 129). Suits to redress the deprivation of privilege secured by the constitution of the United States must be brought in a United States court. It is a crime to conspire to prevent the free exercise and enjoyment of any privilege, or to conspire to deprive any person of equal privileges and immunities, or under colour of law to subject any inhabitant of a state or territory to the deprivation of any privileges or immunities. (*Revised Statutes of United States*, §§ 5507, 5510, 5519).

PRIVY COUNCIL. The origin of the privy council dates back substantially to the Norman period of English history. The *commune concilium*, the assembly, in theory, of all the tenants-in-chief of the Crown, had attached to and included in it a group of officers of state and of the royal household, who with a staff of clerks and secretaries carried on the executive, judicial and financial business of government. This group, of necessity permanent, it is suggested, formed the *curia regis*; and appears to have consisted of the chancellor, the chief justiciary (so long as the office lasted), the treasurer, the steward, the chamberlain, the marshal and the constable, together with the two archbishops and any other persons the king might choose to appoint. Their duties were to advise the king in matters of legislation and administration, to see justice done and generally to execute the royal will. Such a blend of advisory, executive and judicial power could exist only in a simple condition of affairs, and therefore it was to be expected that as government became more settled, and so more complicated, a separation of powers would inevitably follow. The change came quickly. Quite early finance was dealt with by a small section of the court convened at the exchequer chamber; this soon developed into a separate department controlled by the treasurer, managing the revenue and deciding all suits connected with its administration. A little later the court of king's bench and the court of common pleas grew into being, and by the end of the reign of John these two courts were finally separated from one another and from the *curia*. The establishment of separate courts of justice, although relieving the *curia* of much of its work, did not deprive it of all judicial power. The king was the fountain of justice, and where redress could not be obtained in the ordinary way, either from the greatness of the disputants, through private oppression, or because no other means existed, resort still remained to the Crown, either in the first instance or when all other courses had failed the petitioner. Relieved of financial detail and the bulk of its judicial work, the *curia* continued to develop on the lines of an advisory and administrative council. Becoming prominent as a council of regency during the minority of Henry III., it quickly assumed definite form as the *concilium regis*. Under Edward I. "its members take an oath; they are sworn of the council—swearing to give good advice, to protect the king's interests, to do justice honestly, to take no gifts" (Maitland, *Const. Hist.* p. 91). At this period in addition to the great officers of state the judges and a number of bishops appear among the members. One of the most important duties of the council was to advise the Crown in matters of legislation. During the fourteenth and fifteenth centuries, ordinances in subordinate matters appear to have been made regularly by the king in council and accepted as legal by parliament and by the judges. In early parliamentary days it was also part of the council's duty to put into legislative form the petitions sent up by the Commons. Frequently the statute in its final form did not correspond with the petition, and the Commons were continually complaining of the council's unwarrantable interference. Eventually by the reign of Henry VII. the council had ceased to interfere, the petitions being drawn in the form of a bill, and enacted without alteration.

During the 14th century the *concilium regis* had become definitely distinct as well from parliament as from the courts of law. Under Henry IV. in 1404 the council numbered nineteen—three bishops, nine peers and seven commoners. The members held office at the king's pleasure, they are sworn to give their best advice and are well paid for their work. They meet continually, though the king is often absent, but their proceedings are committed to writing. Maitland (*Const. Hist.* p. 199) sums up the work as follows: "The function of the Council is to advise the King upon every exercise of the royal power. Every sort of ordinance, licence, pardon, that the King can issue is brought before the Council. Sometimes Parliament trusts it with extraordinary powers of legislation and taxation; to raise loans and the like. It is to the advice of the Council that the King looks in all his financial difficulties." The powers of the council naturally varied with the character of the king. Quiescent and obedient under a strong king, its influence was re-asserted under a weak one; and when infant kings sat on the throne, for all practical purposes it became the ruler of the land.

In spite of the existence of regular courts of law the council continually interfered with affairs of justice. Many attempts were made by it to set aside or to disregard the judgments of the ordinary courts, but by the beginning of the 15th century parliament had forcibly intervened, and the council gave in. Repeatedly statutes were passed during the reign of Edward III. with a view to checking the council's original jurisdiction in criminal matters, but without effect, as in the reigns of Henry IV. and his son the Commons are found still petitioning against the practice. Yet during the period under review parliament is continually enacting that certain offenders are to be punished by and at the discretion of the council. Evidently such a tribunal, quickly and informally constituted, bound by no legal rules and maxims, proved a useful engine for sharp and speedy punishment. In 1487 was passed an act (3 Hen. VII. c. 1) which is accounted the creator of the Court of Star Chamber. Perjury, riot, bribery of jurors and misconduct of officials had grown rife, and the act authorizes certain members of the council to call offenders before it, to examine them, and if satisfied of their guilt, to punish them. In later years a committee of the council appear to have sat and exercised a widely extended criminal jurisdiction, inflicting every kind of punishment short of the death penalty. This body became known as the Court of Star Chamber and remained in existence until its abolition by act of parliament in 1641.

During the 14th century many petitions relating to civil disputes were presented to the council and were frequently taken into consideration by it on the ground that extraordinary remedies were required, either from lack of legal form or owing to influential private oppression. Eventually where the courts could decide, it became the practice of the council not to interfere, but where no relief could be obtained the council passed the petition on to the chancellor. In course of time the petitions went direct to the chancellor, and in this manner the equity jurisdiction of the court of chancery was established. The act of 1641, which abolished the Court of Star Chamber, also formally forbade the council to meddle with civil causes.

During the Tudor period the council grew in importance; it became useful to the Crown as a vehicle for straining prerogative to the utmost. By the act 31 Hen. VIII. the king's proclamation acquired the force of law, and for a short period the king in council had concurrent legislative power with parliament. Henry's statute was repealed by 1 Edw. VI. c. 12 and the legislative supremacy of parliament re-established. In 1553 the council numbered forty members—four bishops, fourteen peers and the rest commoners. The increase in the number of its members, the direct and often independent communication between the Crown and its secretaries, and the strong personality of the Tudor sovereigns quickly reacted on the work of the council. It had become too large for consultative purposes and the sovereign began a practice, which quickly grew, of consulting only its important members. In this way, within the council

itself, there appears a small inner ring—a true privy council—the parent of the cabinet of later days.

The struggle of James I. and Charles I. for absolute power and finally the Rebellion, ended by leaving the council for the time being impotent. The act of 1641 had not only abolished its special criminal jurisdiction but forbade its interference in civil cases, while the growth of the Secretariat had gradually removed the bulk of its administrative powers. In the end there was little left for it but occasional meetings to give legal sanction to orders it had no concern with, and on the judicial side to act as a court of final resort in Admiralty matters and for all civil and criminal appeals from the courts of the Crown's dominions beyond the seas.

In the reign of Charles II. an attempt was made to revive the usefulness of the council. A scheme was prepared by Sir William Temple in 1679 and accepted by the king. A representative council of thirty members came into being and attempted to carry out the new scheme, but the king, after a short trial, held to his old opinion that the numbers of the council made it "unfit for the secrecy and despatch which are necessary in many great affairs." Once more the king returned to his confidential committee, his cabal, out of which the cabinet of the future grew. Under William III. faction flourished and made general agreement at the council board impossible. George I., ignorant of the English language, never appeared at its meetings, with the result that the direction of affairs passed into the hands of a committee of ministers—the cabinet.

Although the true privy council is the cabinet, the name is to-day given collectively to a large number of eminent people whose membership and position are titular only. All members of the cabinet if not already privy councillors become so on appointment to cabinet office. Occasionally, subordinate members of the ministry and some of its private supporters are made privy councillors as a special distinction. The lord chancellor, the lords of appeal in ordinary, the president of the probate division, the lord president of the court of session in Scotland, the lord justice clerk and the lord advocate of Scotland are always privy councillors, as are the archbishops of Canterbury and York and the bishop of London. In 1807 all the premiers of the self-governing colonies were made privy councillors. Of recent years, retired ambassadors, judges, retired civil servants and persons distinguished in science, letters and arts have been appointed. The custom seems also to be growing of using the honour of privy councillor to reward political supporters who do not wish for hereditary titles. The collective title of the council is "the Lords and others of His Majesty's Most Honourable Privy Council." The members are addressed as "Right Honourable" and wear a state uniform. The appointment is informal, the new privy councillor simply being invited by the king to take his seat at the board. He is then sworn in, and his name placed on the list. Office lasts for the life of the sovereign and six months after, but it is the modern custom for the new sovereign to renew the appointment.

Meetings of the whole council are held at the beginning of a new reign or when the reigning sovereign announces his or her marriage. The lord mayor of London is then summoned to attend. The whole council might also be summoned on other occasions of state and ceremony.

The formal meetings of the council are attended by the few councillors concerned with the orders to be issued. These are generally ministers or officials. The chief officer of the council is the lord president, now a cabinet minister of the highest rank, but without departmental duties. The office of clerk of the council dates from 1540 and his signature is necessary to authenticate all orders.

The administrative work of the council has always been done through committees, and during the last two centuries in spite of changed conditions this rule has been preserved in theory. The board of trade, the local government board, the education department and the board of agriculture were all committees of the council. Now, of course, these so-called committees are state departments presided over by ministers responsible to

parliament. The existing jurisdiction of the council is both administrative and judicial.

Administrative.—This jurisdiction depends chiefly upon statutory authority, which practically makes of the privy council a subordinate legislature. It is found impossible for parliament to enact long and intricate measures dealing with departmental detail, hence a general measure is passed and the privy council is authorized under the act to draw up orders in council which of course have the full force of law. This power is exercised usually by committees to which matters are referred by the Crown in council, the departments of state concerned settling the details. Other examples of administrative work are the universities committee, with temporary powers under the Universities Act (1877), and the committee of council for the consideration of charters of incorporation under the Municipal Corporations Act (1882), the latter a work of considerable difficulty and delicacy and usually carried out in close consultation with the local government board. Cases affecting the constitutional rights of the Channel Islands are referred to a committee for the affairs of Jersey and Guernsey. The committees report to the Crown in council, and their report is adopted and enforced by an order in council published in the *Gazette*. Among other acts conferring administrative powers on the privy council are the Pharmacy Act (1852), as amended by 31 & 32 Vict. c. 121, the Medical Act (1858), the Foreign Enlistment Act (1870), the Destructive Insects Act (1877), the Contagious Diseases (Animals) Act (1878), the Dentists Act (1878) the Veterinary Surgeons Act (1881).

Judicial.—By the 3 & 4 Will. IV. c. 41 a judicial committee of the council was constituted. It consists of all the members of the council holding or having held the office of lord president or lord chancellor or certain high judicial offices enumerated in the act. By the Appellate Jurisdiction Acts of 1876 and 1887 other high judicial offices are included. All the lords of appeal in ordinary are members of the committee. Under the act of 1833 the king may also appoint any other two persons, being councillors. By the acts of 1833 and 1887 two persons having been Indian or Colonial judges may be appointed, and such appointments carry an annual salary of £400. By an act of 1895 any of the chief justices of certain colonies who are also privy councillors may be appointed to the committee, but not more than five such appointments may be made. Under this act certain colonial chief justices now sit. In appeals under the Clergy Discipline Acts three bishops sit as assessors. In colonial Admiralty appeals two nautical assessors attend. These assessors are merely technical advisers, and have no part in any decision. Appeals also lie from consular courts and prize courts. The decisions of ecclesiastical courts are subject to review by the committee, the sovereign being the "supreme governor" of the Church, but no appeal is competent where the case is one for the exercise of the bishop's discretion. In these ecclesiastical cases the committee does not profess to expound and settle doctrine with ecclesiastical authority: it merely interprets the laws of the Church. In matters relating to ritual history and precedents are taken into account. Appeals also lie from vice-admiralty courts abroad, the Channel Islands, the Isle of Man, India and all the colonies. As a rule they lie as of right when the value of the matter at issue is of a certain amount (the amount varying according to the appeal rules of the different foreign possessions) and in a few other cases. Recent legislation, at the instance of the colonies, has to some extent further restricted the right to appeal. Appeals lie at the discretion of the committee on leave being obtained by petition for special leave to appeal. All proceedings are by petition (see PETITION) which is addressed to the Crown in council in the first instance. The judicial proceedings of the council are in reality conducted like an ordinary case in the courts of law. Counsel are heard, and the ordinary rules of law and legal practice followed, and costs taxed. Judgment is given by motion which takes the form of advice to the Crown, and whatever may have taken place privately in discussion between the members, outwardly the committee is unanimous. Within recent years it has been suggested that the appellate jurisdiction of the House of Lords and the privy council should be coalesced, and thus constitute one final court of appeal for the whole empire. Besides the appellate there exists in the sovereign in council an original jurisdiction in questions concerning boundaries between dependencies, the extent of charters and the like. Until recently the council dealt with the petitions to extend the time patents were protected, but this work has now been given by statute to the controller-general of patents.

Ireland has its own privy council. The lord-lieutenant takes the place of the Crown. There is little real work and the distinction of membership is titular as in England. Scotland has had no privy council since the Act of Union which provided for one council for Great Britain. British colonies with parliamentary government have cabinets or committees of ministers, borrowed from the English model, but no privy council. In France, before the Revolution, the king had a council which bore some resemblance to the English type (see FRANCE: *Law and Institutions*). In Germany a "privy council" (*Geheimes Rats-Kollegium*, *Geheimes Conseil*, *Staatsrat*), which under the prince formed the supreme organ of government, formerly existed in the various states of the empire, and out of this the ministries developed in the 17th century. These

were originally committees of the council (*Geheime Konferenz*, *Geheimes Kabinett*, &c.) which, as in England, gradually absorbed its functions. In some of the German states, however, it still survives as the "council of state" (*Staatsrat*) and in Württemberg as "privy council" (*Geheimer Rat*). The title *Wirklicher Geheimer Rat* (real privy councillor), with the predicate *Excellenz* is given to the highest officials. That of *Geheimer Rat* simply is very generally, e.g. in Prussia, given to high officials, usually with the addition of the branch of the service to which they belong, e.g. *Geheimer Finanzrat*, *Geheimer Justizrat*. The title is also sometimes purely honorary, e.g. that of *Geheimer Commerzienrat*, bestowed on eminent men of business. (G. E.)*

PRIVY PURSE, is the amount set apart in the civil list (*q.v.*) for the private and personal use of the sovereign in England. During the reign of Queen Victoria it was £60,000 a year, but on the accession of Edward VII. the amount was fixed at £110,000 a year, which was the amount paid to the last sovereign (William IV.) who had a queen consort. The official who is charged with all payments made by the sovereign for his private expenses or charities is termed the keeper of the privy purse. The department of the keeper of the privy purse to the sovereign, assumed its existing shape in the earlier part of the last century. Under Queen Victoria the offices of keeper of the privy purse and private secretary were combined. As now organized these branches of the royal household consist of the private secretary and the keeper of the privy purse, two assistant private secretaries and keepers of the privy purse, and a secretary, assistant secretary and several clerks of the privy purse. These officials, though of the royal household, are not in the department of the lord steward or the lord chamberlain, but are of the king's *personal staff*.

PRIVY SEAL, a seal of the United Kingdom, next in importance to the great seal, and occupying an intermediate position between it and the signet. The authority of the privy seal was principally of a two-fold nature. It was a warrant to the lord chancellor to affix the great seal to such patents, charters, &c., as must necessarily pass the great seal (more particularly letters patent (*q.v.*)). It was also the authority required for the issue of money from the exchequer, and was appended to documents of minor importance which did not require the great seal. Previous to the Great Seal Act 1884, all letters patent conferring any dignity, office, monopoly, franchise or other privilege were always passed under the privy seal before passing under the great seal.

Lord Privy Seal is the title of the officer who had the custody of the privy seal. He was originally known as the "keeper of the privy seal." The importance of the office was due to the desire of the privy council and the parliament in the 14th and 15th centuries to place some check on the issue of public money, as well as to prevent the use of the great seal by the sovereign without any intermediary except the lord chancellor. The lord privy seal first appears as a minister of state in the reign of Edward III. Until 1537 he was always an ecclesiastic, but is now more usually a temporal lord. He is the fifth great officer of state, and takes rank next after the president of the council and before all dukes.

See Anson, *Law and Custom of the Constitution* (1896).

PRIZE, or **PRIZE OF WAR** (Fr. *prise*, from *prendre*, to take), a vessel or cargo captured by a belligerent on the high seas; also the act of capture. Under **BLOCKADE**, **CONTRABAND**, and **NEUTRALITY** will be found details of existing practice as regards infringements of international law which expose neutrality vessels and cargoes to capture and trial in a prize court. Under **WAR** will be found the application of international law in relation to the private property of subjects and citizens of belligerent states as between them. We treat here of the manner of dealing with prizes after they have been brought into the jurisdiction of the prize court.

Under the law in force at the beginning of 1910 the subject was governed by the following English acts: the Naval Prize Act 1864 (27 & 28 Vict. c. 25); the Colonial Courts of Admiralty Act 1890 (53 & 54 Vict. c. 27); the Supreme Court of Judicature Act 1891 (54 & 55 Vict. c. 53, s. 4), and the Prize Courts Act 1894 (57 & 58 Vict. c. 39). A new Naval Prize Act was,

however, already in contemplation, repealing the acts of 1864 and 1894, consolidating and re-enacting their main provisions and making such statutory provisions as will permit of the ratification of a convention adopted at the second Hague Conference (1907) for the establishment of an International Prize Court.

The Convention referred to above contains an elaborate scheme of 50 articles setting out the constitution and procedure of the court. It begins with the following declaration of its objects:—

Animated by the desire to settle in an equitable manner the differences which sometimes arise in the course of a naval war in connexion with the decisions of national prize courts:

Considering that, if these courts are to continue to exercise their functions in the manner determined by national legislation, it is desirable that in certain cases an appeal should be provided under conditions conciliating, as far as possible, the public and private interests involved in matters of prize:

Whereas, moreover, the institution of an international court, whose jurisdiction and procedure would be carefully defined, has seemed to be the best method of attaining this object:

Convinced, finally, that in this manner the hardships consequent on naval war would be mitigated; that, in particular, good relations will be more easily maintained between belligerents and neutrals, and peace better assured. . . .

It prescribes that the court shall be composed of fifteen members out of the whole panel (art. 14). Of these Great Britain, France, Germany, Austria-Hungary, Russia, Italy, the United States and Japan each appoint one (art. 15). A schedule of the other powers is appended to the Convention, under which they take their turn to sit to the number of seven, making up together the prescribed fifteen. As composed under the first year's distribution, the other judges would be appointed by Argentina, Colombia, Spain, Greece, Norway, Holland and Turkey.

There are also full provisions as to the procedure and conduct of the proceedings in the court, but the only provisions of concern to general readers are those relating to international law, which are as follows:—

1. The validity of the capture of a merchant-ship or its cargo is decided before a prize court in accordance with the present convention when neutral or enemy property is involved.

2. Jurisdiction in matters of prize is exercised in the first instance by the prize courts of the belligerent captor.

The judgments of these courts are pronounced in public or are officially notified to parties concerned who are neutrals or enemies.

3. The judgments of national prize courts may be brought before the international prize court:—

i. When the judgment of the national prize courts affects the property of a neutral power or individual;

ii. When the judgment affects enemy property and relates to:—

(a) Cargo on board a neutral ship;

(b) An enemy ship captured in the territorial waters of a neutral power, when that power has not made the capture the subject of a diplomatic claim;

(c) A claim based upon the allegation that the seizure has been effected in violation, either of the provisions of a convention in force between the belligerent powers, or of an enactment issued by the belligerent captor.

The appeal against the judgment of the national court can be based on the ground that the judgment was wrong either in fact or in law.

4. An appeal may be brought:—

i. By a neutral power, if the judgment of the national tribunals injuriously affects its property or the property of its nationals (art. 3 [(i.)]), or if the capture of an enemy vessel is alleged to have taken place in the territorial waters of that power (art. 3 [(ii.) (b)]);

ii. By a neutral individual, if the judgment of the National Court injuriously affects his property (art. 3 [(i.)]), subject, however, to the reservation that the power to which he belongs may forbid him to bring the case before the court, or may itself undertake the proceedings in his place;

iii. By an individual subject or citizen of an enemy power, if the judgment of the national court injuriously affects his property in the cases referred to in art. 3 [(ii.)], except that mentioned in paragraph (b).

5. An appeal may also be brought on the same conditions as in the preceding article, by persons belonging either to neutral states or to the enemy, deriving their rights from and entitled to represent an individual qualified to appeal, and who have taken part in the proceedings before the national court. Persons so entitled may appeal separately to the extent of their interest.

The same rule applies in the case of persons belonging either to

neutral states or to the enemy who derive their rights from and are entitled to represent a neutral power whose property was the subject of the decision.

6. When, in accordance with the above art. 3, the international court has jurisdiction, the national courts cannot deal with a case in more than two instances. The municipal law of the belligerent captor shall decide whether the case may be brought before the international court after judgment has been given in first instance or only after an appeal.

If the national courts fail to give judgment within two years from the date of capture, the case may be carried direct to the international court.

7. If a question of law to be decided is covered by a treaty in force between the belligerent captor and a power which is itself or whose subject or citizen is a party to the proceedings, the court is governed by the provisions of the said treaty.

In the absence of such provisions, the court shall apply the rules of international law. If no generally recognized rule exists, the court shall give judgment in accordance with the general principles of justice and equity.

The above provisions apply equally to questions relating to the order and mode of proof.

If, in accordance with art. 3 [(ii.) (c)], the ground of appeal is the violation of an enactment issued by the belligerent captor, the court shall enforce the enactment.

The court may disregard failure to comply with the procedure laid down in the legislation of the belligerent captor, when it is of opinion that the consequences of complying therewith are unjust and inequitable.

8. If the court pronounces the capture of the vessel or cargo to be valid, they shall be disposed of in accordance with the laws of the belligerent captor.

If it pronounces the capture to be null, the court shall order restitution of the vessel or cargo, and shall fix, if there is occasion, the amount of the damages. If the vessel or cargo have been sold or destroyed, the court shall determine the compensation to be given to the owner on this account.

If the national prize court pronounced the capture to be null, the court can only be asked to decide as to the damages.

9. The contracting powers undertake to submit in good faith to the decisions of the international prize court, and to carry them out with the least possible delay.

The British delegates, in their report on the work of the Conference, wrote that it was to them a subject of satisfaction that they had been able to accomplish the task thus laid upon them, "not, indeed, in the form of an adaptation of the machinery of the existing court, but in the form of a new institution"; and that the convention drawn appeared to them to be "a very noteworthy step in the history of law as the first attempt to constitute a really international court, and as the first device to produce uniformity in any branch of international law." Here, however, the delegates overstated the scope of the work done, and in order to obtain that uniformity a further conference was held in London (Dec. 1908–Feb. 1909) "to arrive at an agreement as to what are the generally recognized rules of international law within the meaning of art. 7" of the Convention. The London Conference drew up a series of rules which it declared "correspond in substance with the generally recognized principles of international law" on Blockade (*q.v.*), Contraband of War (*q.v.*), Unneutral service, Destruction of Neutral Prizes, Transfer to a Neutral Flag, Enemy Character, Convoy (*q.v.*), Resistance to Search and Compensation. These rules, if ratified, will bind the international court.

The proposal to submit captures in war to a special international jurisdiction has often been made, and in fact it suggests itself whenever there are two opinions concerning the justice of a prize court's decision.

The Institute of International Law in 1887, after adopting a very full code of prize law, consisting of no fewer than 122 articles and covering every branch of the subject, forwarded them to the different European governments, with the expression of a wish that "in the future reform might take a still more complete shape by the institution of an international tribunal for trial of prize cases."

The subject was brought up at the session in 1905 at Christiania of the International Law Association. The discussion showed that there was much to be said on both sides. Mr Justice Phillimore *inter alios* seemed favourable to the institution of an independent court of appeal only.

This was the position of the discussion at the opening of the

second Hague Conference in June 1907, when the British and German delegates announced that they had been instructed to present schemes for the establishment of an international court of appeal in matters of naval prize. Two projects were simultaneously presented on behalf of Great Britain and Germany.

The original English idea was to "secure the adaptation" of the machinery of the existing Hague Court to the purposes of an "International Tribunal of Appeal" from decisions of belligerent prize courts. The official instructions, published in the correspondence respecting the Second Conference¹ observed, in reference to the proposal, that the "judgments of the tribunal in such cases would probably prove the most rapid and efficient means which can, under existing conditions, be devised for giving form and authority to the canons of international law in matters of prize." The instructions continue that the advantages would far outweigh any difficulty which might arise from the fact that some alterations in the municipal laws of this country, and probably also of other states, would be required, and that "H.M. Government considered that if the Hague Conference accomplished no other object than the constitution of such a tribunal, it would render an inestimable service to civilization and mankind."

The objection to the existing system is that the judge is appointed by the belligerent state whose interest it is to condemn the capture; that his bias, if any, is against the neutral interest. But will there be no room in an international prize court for bias against the belligerent? "Representing as we do," said Mr Choate at the sitting of the 11th of July, "a widely extended maritime nation, and a nation which hopes and confidently expects always in the future to be a neutral nation, we deem the establishment of an international court of prize by this Conference to be a matter of supreme importance." The converse may obviously be as important for a nation which, with its vast dependencies, cannot with equal confidence expect to remain a mere spectator among the rivalries of expanding states in different quarters of the globe. The interests of the civilized world in time of war are divisible into three groups, namely, the respective interests of the two belligerents, and the interest of the neutrals. In practice the interest of the neutrals is against the making of captures. Under the system hitherto prevailing it is the judge appointed by the captor who decides whether the capture was a legitimate one or not. It may be contended, however, that he hears the cause and gives his judgment in the face of the whole neutral world, at all times the larger part of civilized mankind, and one which has now infinitely greater facilities for making its voice heard than it had a century earlier, when a powerful belligerent maritime state was, out of all proportion to any neutral combination, able to enforce its views as regards neutral property. (T. BA.)

PRIZREN (also written *Prisren*, *Prisrend*, *Prizrendi*, *Prezdra* and *Perzerin*), the capital of the sanjak of Prizren, in the vilayet of Kossovo, Albania, European Turkey; 65 m. E. by N. of Scutari, on the river Bistritza, a left-hand tributary of the White Drin. Pop. (1905), about 30,000, chiefly Mahomedan Albanians, with a minority of Roman Catholic Albanians, Serbs and Greeks. Prizren is beautifully situated 1424 ft. above sea-level, among the northern outliers of the Shar Planina. To the north-west a fertile and undulating plain, watered by the White Drin, extends as far as Ipek (42 m.). A good road connects Prizren with the Ferisovich station on the Salonica-Mitrovitza railway (37 m.). The city is the seat of a Roman Catholic archbishop, a Greek bishop, and a Servian theological seminary. Its chief buildings are the citadel and many mosques, one of which is an ancient Byzantine basilica, originally a

¹ Prince von Bülow was credited with suggesting in his correspondence on the question of the *Bundesrath* that a tribunal of arbitration should be instituted to deal with all questions of capture. At any rate, on the 19th of January 1900 he wrote that the German government had proposed that all the points then in dispute should be submitted to arbitration. The British government declared their concurrence in the institution of a tribunal to arbitrate upon claims for compensation.

Servian cathedral. In its bazaars an active trade in agricultural produce, glass, pottery, saddlery, and copper and iron ware is carried on; but the manufacture of fire-arms, for which Prizren was long famous throughout European Turkey, has suffered greatly from foreign competition.

Prizren has sometimes, though on doubtful evidence, been identified with the ancient Tharendus or Theranda. In the 12th century it was the residence of the kings of Servia, and the sanjak of Prizren forms part of the region still called Old Servia (*Stara Srbija*) by the Slavs. From the 13th century to the 16th Prizren had a flourishing export trade with Ragusa, and it has always been one of the principal centres of commerce and industry in Albania.

PRJEVALSKY [PRZHEVALSKY], **NIKOLAI MIKHAILOVICH** (1839-1888), Russian traveller, born at Kimbory, in the government of Smolensk, on the 31st of March 1839, was descended from a noble Cossack family. He was educated at the Smolensk gymnasium, and in 1855 entered an infantry regiment as a subaltern. In November 1856 he became an officer, and four years later he entered the academy of the general staff. From 1864 to 1866 he taught geography at the military school at Warsaw, and in 1867 he was admitted to the general staff and sent to Irkutsk, where he started to explore the highlands on the banks of the Usuri, the great southern tributary of the Amur. This occupied him until 1869, when he published a book on the Usuri region, partly ethnographical in character. Between November 1870 and September 1873, accompanied by only three men and with ridiculously small pecuniary resources, he crossed the Gobi desert, reached Peking, and, pushing westwards and south-westwards, explored the Ordos and the Ala-shan, as well as the upper part of the Yangtze-kiang. He also penetrated into Tibet, reaching the banks of the Di Chu river. By this remarkable journey he proved that, for resolute and enduring men, travelling in the Central Asian plateaus was easier than had been supposed. The Russian Geographical Society presented him with the great Constantine medal, and from all parts of Europe he received medals and honorary diplomas. The work in which he embodied his researches was immediately translated into all civilized languages, the English version, *Mongolia, the Tangut Country, and the Solitudes of Northern Tibet* (1876), being edited by Sir Henry Yule. On his second journey in 1877, while endeavouring to reach Lhasa through east Turkestan, he re-discovered the great lake Lop-nor (*q.v.*), which had not been visited by any European since Marco Polo. On his third expedition in 1879-1880 he penetrated, by Hami, the Tsai-dam and the great valley of the Tibetan river Kara-su, to Napchu, 170 m. from Lhasa, when he was turned back by order of the Dalai Lama. In 1883-1885 he undertook a fourth journey of exploration in the wild mountain regions between Mongolia and Tibet. On these four expeditions he made collections of plants and animals of inestimable value, including nearly twenty thousand zoological and sixteen thousand botanical specimens. Among other remarkable discoveries were those of the wild camel, ancestor of the domesticated species, and of the early type of horse, now known by his name (*Equus przewalskii*). Prjevalsky's account of his second journey, *From Kulja, across the Tian-Shan, to Lop-nor*, was translated into English in 1879. In September 1888 he started on a fifth expedition, intending to reach Lhasa, but on the 1st of November he died at Karakol on Lake Issyk-kul. A monument was erected to his memory on the shores of the lake, and the Russian government changed the name of the town of Karakol to Przhevalsk (*q.v.*) in his honour.

PROA (Malay, *prau*), the general term in the Malay language for all vessels, from the *sampan* or canoe to the square-rigged *kapal*, but in western usage confined to the swift-sailing craft that the pirates of the Indian Ocean made familiar to sailors in eastern waters. The chief points which characterize these vessels are that while the weather-side is rounded the lee-side is flat from stem to stern, that both stem and stern are exactly similar in shape, and that there is a small similarly shaped hull swung out from the side of the main hull on poles, which acts

as an outrigger and prevents the vessel heeling over. The main hull carries the mast rigging and an enormous triangular-shaped sail.

PROBABILISM (from Lat. *probare*, to test, approve), a term used both in theology and in philosophy with the general implication that in the absence of certainty probability is the best criterion. Thus it is applied in connexion with casuistry for the view that the layman in difficult matters of conscience may safely follow a doctrine inculcated by a recognized doctor of the church. This view was originated by the monk Molina (1528–1581), and has been widely employed by the Jesuits. In philosophy the term is applied to that practical doctrine which gives assistance in ordinary matters to one who is sceptical in respect of the possibility of real knowledge: it supposes that though knowledge is impossible a man may rely on strong beliefs in practical affairs. This view was held by the sceptics of the New Academy (see SCEPTICISM and CARNEADES). Opposed to “probabilism” is “probabiliorism” (Lat. *probabilior*, more likely), which holds that when there is a preponderance of evidence on one side of a controversy that side is presumably right.

PROBABILITY (Lat. *probabilis*, probable or credible), a term which in general implies credibility short of certainty.

The mathematical theory of probabilities deals with certain phenomena which are employed to measure credibility. This measurement is well exemplified by games of chance. **Description and Division of the Subject.** If a pack of cards is shuffled and a card dealt, the probability that the card will belong to a particular suit is measured by—we may say, is—the ratio $1:4$, or $\frac{1}{4}$; there being four suits to any one of them the card might have belonged. So the probability that an ace will be drawn is $\frac{4}{52}$, as out of the 52 cards in the pack 4 are aces. So the probability that ace will turn up when a die is thrown is $\frac{1}{6}$. The probability that one or other of the two events, ace or deuce, will occur is $\frac{2}{6}$. If simultaneously a die is thrown and a card is dealt from a pack which has been shuffled, the probability that the double event will consist of two aces is 1×4 divided by 6×52 , as the total number of double events formed by combining a face of a die with a face of a card is 6×52 , and out of these 1×4 consist of two aces.

The data of probabilities are often *prima facie* at least of a type different from that which has been described. For example, the probability that a child about to be born will be a boy is about 0.51. This statement is founded solely on the observed fact that about 51% of children born (alive, in European countries) prove to be boys. The probability is not, as in the instance of dice and cards, measured by the proportion between a number of cases favourable to the event and a total number of possible cases. Those instances indeed also admit of the measurement based on observed frequency. Thus the number of times that a die turns up ace is found by observation to be about 16.6% of the number of throws; and similar statements are true of cards and coins.¹ The probabilities with which the calculus deals admit generally of being measured by the number of times that the event is found by experience to occur, in proportion to the number of times that it might possibly occur.

The idea of a probable or expected number is not confined to the number of times that an event occurs; if the occurrence of the event is associated with a certain amount of money or any other measurable article there will be a probable or expected amount of that article. For instance, if a person throwing dice is to receive two shillings every time that six turns up, he may expect in a hundred throws to win about 2×16.6 (about 33.3) shillings. If he is to receive two shillings for every six and one shilling for every ace, his expectation will be $2 \times 16.6 + 1 \times 16.6$ (50) shillings. The expectation of lifetime is calculated on this principle. Of 1000 males aged ten say the probable number who will die in their next year is 490, in the following year 397, and so on; if we (roughly) estimate that those who die in the first year will have enjoyed one year of life after ten, those who die in the next year will have enjoyed two years of life, and so on;

¹ Cf. note to par. 5 below.

then the total number of years which the 1000 males² aged ten may be expected to live is

$$1 \times 1000 + 2 \times (1000 - 490) + 3 (1000 - 490 - 397) + \dots$$

Space as well as time may be the subject of expectation. If drops of rain fall in the long run with equal frequency on one point—or rather on one small interval, say of a centimetre or two—on a band of finite length and negligible breadth, the distance which is to be expected between a point of impact in the upper half of the line and a point of impact in the lower half has a definite proportion to the length of the given line.³

Expectation in the general sense may be considered as a kind of average.⁴ The doctrine of averages and of the deviations therefrom technically called “errors” is distinguished from the other portion of the calculus by the peculiar difficulty of its method. The paths struck out by Laplace and Gauss have hardly yet been completed and made quite secure. The doctrine is also distinguished by the importance of its applications. The theory of errors enables the physicist so to combine discrepant observations as to obtain the best measurement. It may abridge the labour of the statistician by the use of samples.⁵ It may assist the statistician in testing the validity of inductions.⁶ It promises to be of special service to him in perfecting the logical method of concomitant variations; especially in investigating the laws of heredity. For instance the correlation between the height of parents and that of children is such that if we take a number of men all of the same height and observe the average height of their adult sons, the deviation of the latter average from the general average of adult males bears a definite proportion—about a half—to the similarly measured deviation of the height common to the fathers. The same kind and amount of correlation between parents and children with respect to many other attributes besides stature has been ascertained by Professor Karl Pearson and his collaborators.⁷ The kinetics of free molecules (gases) forms another important branch of science which involves the theory of errors.

The description of the subject which has been given will explain the division which it is proposed to adopt. In Part I. probability and expectation will be considered apart from the peculiar difficulties incident to errors or deviation from averages. The *first* section of the first part will be devoted to a preliminary inquiry into the evidence of the primary data and axioms of the science. Freed from philosophical difficulties the mathematical calculation of probabilities will proceed in the *second* section. The analogous calculation of expectation will follow in the *third* section. The contents of the first three sections will be illustrated in the *fourth* by a class of examples dealing with space measurements—the so-called “local” or “geometrical” probabilities. Part II. is devoted to averages and the deviations therefrom, or more generally that grouping of statistics which may be called a law of frequency. Part II. is divided into two sections distinguished by differences in character and extent between the principal generalizations respecting laws of frequency.

PART I.—PROBABILITY AND EXPECTATION

Section I.—*First Principles.*

1. As in other mathematical sciences, so in probabilities, or even more so, the philosophical foundations are less clear than the calculations based thereon. On this obscure and controversial topic absolute uniformity is not to be expected. But it is hoped that the following summary in which diverse authoritative judgments are balanced may minimize dissent.
2. (1) *How the Measure of Probability is Ascertained.*—The first question which arises under this head is: on what evidence are the facts obtained which are employed to measure probability? A very generally accepted view is that which Laplace has thus expressed:

² It is more usual to speak of the *mean* expectation, the average number of years *per head*.

³ Below, par. 88.

⁴ For more exact definition see below, par. 95.

⁵ See Bowley's Address to Section F. of the British Association (1906).

⁶ Edgeworth, “Methods of Statistics,” *Journal of the Statistical Society* (Jubilee volume, 1885).

⁷ See *Biometrika*, vol. iii. “Inheritance of Mental Characters.”

"The probability of an event is the ratio of the number of cases which favour it to the number of all the possible cases, when nothing leads us to believe that one of these cases ought to occur rather than the others; which renders them, for us, equally possible."¹ Against this view it is urged that merely psychological facts can at best afford a measure of belief, not of credibility. Accordingly, the ground of probability is sought in the observed fact of a class or "series"² such that if we take a great many members of the class, or terms of the series, the members thereof which belong to a certain assigned species compared with the total number taken tends to a certain fraction as a limit. Thus the series which consists of heads and tails obtained by tossing up a well-made coin is such that out of a large number of throws the proportion giving heads is nearly half.

3. These views are not so diametrically opposed as may at first appear. On the one hand, those who follow Laplace would of course admit that the presumption afforded by the "number of favourable cases" with respect to the probability of throwing either five or six with a die must be modified in accordance with actual experience such as that below cited³ respecting particular dice that they turn up five or six rather oftener than once in three times. On the other hand, the series which is regarded as the empirical basis of probability is not a simple matter of fact. There are implied conditions which are not satisfied by the sort of uniformity which ordinarily characterizes scientific laws; which would not be satisfied for instance by the proportionate frequency of any one digit, e.g. 8, in the expansion of any vulgar fraction, though the expression may consist of a circulating decimal with a very long period.⁴

4. The type of the series is rather the frequency of the several digits in the expansion of an incommensurable constant such as $\sqrt{2}$, $\log 11$, π , &c.⁵ The observed fact that the digits occur with equal frequency is fortified by the absence of a reason why one digit should occur oftener than another.⁶

5. The most perfect types of probability appear to present the two aspects: proportion of favourable cases given a priori and frequency of occurrence observed a posteriori. When one of these attributes is not manifested it is often legitimate to infer its existence from the presence of the other. Given numerous batches of balls, each batch numbering say 100 and consisting partly of white and partly of black balls; if the percentages of white balls presented by the set of batches averaged, and, as it were, hovered about some particular percentage, e.g. 50, though we knew as an independent datum, or by inspection of the given percentages, that the series was not obtained by simply extracting a hundred balls from a jar containing a *mélange* of white and black balls, we might still be justified in concluding that the observed phenomenon resulted from a system equivalent to a number of jars of various constitution, compounded in some complicated fashion. So Laplace may be justified in postulating behind frequencies embodied in vital statistics the existence of a "constitution" analogous to games of chance, "possibilities" or favourable cases which might conceivably be "developed" or discussed.⁷ On the other hand, it is often legitimate to infer from the known proportion of favourable cases a corresponding frequency of occurrence. The cogency of the inference will vary according to the degree of experience. That one face of a die or a coin will turn up nearly as often as another might be affirmed with perfect confidence of the particular dice which Weldon threw some thousands of times,⁸ or the coins with which Professor Pearson similarly operated.⁹ It may be affirmed with much confidence of ordinary coins and dice without specific experience, and generally, where fairplay is presumed, of games of chance. This confidence is based not only on experiments like those tried by Buffon, Jevons and many others,¹⁰ but also on a continuous, extensive, almost unconsciously registered experience in *pari materia*. It is this sort of experience which justifies our expectation that commonly in mathematical tables one digit will occur as often as another, that in a shower about as many drops

will fall on one element of area as upon a neighbouring spot of equal size. Doubtless the presumption must be extended with caution to phenomena with which we are less familiar. For example, is a meteor equally likely to hit one square mile as another of the earth's surface? We seem to descend in the scale of credibility from absolute certainty that alternative events occur with about equal frequency to absolute ignorance whether one occurs more frequently than the other. The empirical basis of probability may appear to become evanescent in a case like the following, which has been discussed by many writers on Probabilities.¹¹ What is the probability of drawing a white ball from a box of which we only know that it contains balls both black and white and none of any other colour? In this case, unlike the case of an urn containing a mixture of white and black balls in equal proportions, we have no reason to expect that if we go on drawing balls from the urn, replacing each ball after it has been drawn, that the series so presented will consist of black and white in about equal numbers. But there is ground for believing that in the long course of experiences *in pari materia*—other urns of similar constitution, other cases in which there is no reason to expect one alternative more than another—an event of one kind will occur about as often as one of another kind. A "cross-series"¹² is thus formed which seems to rest on as extensive if not so definite an empirical basis as the series which we began by considering. Thus the so-called "intellectual probability"¹³ which it has been sought to separate from the material probability verified by frequency of occurrence, may still rest on a similar though less obvious ground of experience. This type of probability not verified by specific experience is presented in two particularly important classes.

6. *Unverified Probabilities.*—In applying the theory of errors to the art of measurement it is usual to assume that prior to observation one value of the quantity under measurement is as likely as another. "When the probability is unknown," says Laplace,¹⁴ "we may equally suppose it to have any value between zero and unit." The assumption is fundamentally similar whether the quantum is a ratio to be determined by the theorem of Bayes,¹⁵ or an absolute quantity to be determined by the more general theory of error. Of this first principle it is well observed by Professor Karl Pearson¹⁶: "There is an element of human experience at the bottom of Laplace's assumption." Professor Pearson quotes with approbation¹⁷ the following account of the matter: "The assumption that any probability-constant about which we know nothing in particular is as likely to have one value as another is grounded upon the rough but solid experience that such constants do as a matter of fact as often have one value as another."

7. It may be objected, no doubt, that one value (of the object under measurement) is often known beforehand *not* to be as likely as another. The barometric height for instance is *not* equally likely to be 29 in. or to be 2 in. The reply is that the postulate is only required with respect to a small tract in a certain neighbourhood, some 2 in. above and below 29½ in. in the case of barometric pressure.

8. It is further objected that the assumption in question involves inconsistencies in cases like the following. Suppose observations are made on the length of a pendulum together with the time of its oscillation. As the time is proportional to the square root of the length, it follows that if the values of the length occur with equal frequency those of the time cannot do so; and, inversely, if the proposition is true of the times it cannot be true of the lengths.¹⁸ One reply to this objection is afforded by the reply to the former one. For where we are concerned only with a small tract of values it will often happen that *both* the square and the square root and any ordinary function of a quantity which assumes equivalent values with equal probability will each present an approximately equal distribution of probabilities.¹⁹ It may further be replied that in general the reasoning does not require the a priori probabilities of the different values to be very nearly equal; it suffices that they should not be very unequal;²⁰ and this much seems to be given by experience.

9. Whenever we can justify Laplace's first principle²¹ that "probability is the ratio of the number of favourable cases to the number of all possible cases" no additional difficulty is involved in his second

¹ Laplace, *Théorie analytique des probabilités*, liv. II. ch. i. No. 1. Cf. Introduction, II^e principe.

² The term employed by Venn in his important *Logic of Chance*.

³ Below, par. 119.

⁴ E.g. 1881, in the expansion of which the digit 8 occurs once in ten times in seemingly random fashion (see *Mess. of Maths.* 1864, vol. 2, pp. 1 and 39).

⁵ The type shows that the phenomena which are the object of probabilities do not constitute a distinct class of things. Occurrences which perfectly conform to laws of nature and are capable of exact prediction yet in certain aspects present the appearance of chance. Cf. Edgeworth, "Law of Error," *Cam. Phil. Trans.*, 1905, p. 128.

⁶ Cf. Venn, *op. cit.* ch. v. § 14; and v. Kries on the "Prinzip des mangelnden Grundes" in his *Wahrscheinlichkeitsrechnung*, ch. i. § 4, *et passim*.

⁷ In a passage criticized unfavourably by Dr Venn, *Logic of Chance*, ch. iv. § 14.

⁸ Below, par. 115.

⁹ *Chances of Death*, i. 44.

¹⁰ A summary of such experiments, comprising above 100,000 trials, is given by Professor Karl Pearson in his *Chances of Death*, i. 48.

¹¹ E.g. J. S. Mill, *Logic*, bk. III., ch. xviii. § 2.

¹² Cf. Venn, *Logic of Chance*, ch. vi. § 24.

¹³ Boole, *Trans. Roy. Soc.* (1862), ix. 251.

¹⁴ *Op. cit.* Introduction.

¹⁵ Below, par. 130.

¹⁶ *Grammar of Science*, ed. 2, p. 146.

¹⁷ From the article by the present writer on the "Philosophy of Chance" in *Mind*, No. ix., in which some of the views here indicated are stated at greater length than is here possible.

¹⁸ Cf. v. Kries, *op. cit.* ch. ii.

¹⁹ On the principle of Taylor's theorem; cf. Edgeworth, *Phil. Mag.* (1892), xxxiv. 431 seq.

²⁰ Cf. J. S. Mill, in the passage referred to below, par. 13, on the use that may be made of an "antecedent probability," though "it would be impossible to estimate that probability with anything like numerical precision."

²¹ *Op. cit.* Introduction.

principle, of which the following may be taken as an equivalent. If we distribute the favourable cases into several groups the probability of the event will be sum of the probabilities pertaining to each group.¹

10. Another important instance of unverified probabilities occurs when it is assumed without specific experience that one phenomenon is independent of another in such wise that the probability of a double event is equal to the product of the one event multiplied by the probability of the other—as in the instance already given of two aces occurring. The assumption has been verified with respect to "runs" in some games of chance;² but it is legitimately applied far beyond those instances. The proposition that very long runs of particular digits, e.g. of 7, may be expected in the development of a constant like π —e.g. a run of six consecutive *sevens* if the expansion of the constant was carried to a million places of decimals—may be given as an instance in which our conviction greatly transcends specific verification. In the calculation of probable, and improbable, errors, it³ has to be assumed without specific verification that the observations on which the calculation is based are independent of each other in the sense now under consideration. With these explanations we may accept Laplace's third principle "If the events are independent of each other the probability of their concurrence (*l'existence de leur ensemble*) is the product of their separate probabilities."⁴

11. *Interdependent Probabilities.*—Among the principles of probabilities it is usual to enunciate, after Laplace, several other propositions.⁵ But these may here be rapidly passed over as they do not seem to involve any additional philosophical difficulty.

12. It has been shown that when two events are independent of each other the product of their separate probabilities forms the probability of their concurrence. It follows that the probability of the double event divided by the probability of either, say the first, component gives the probability of the other, the second component event. The quotient, we might say, is the probability that when the first event has occurred, the second will occur. The proposition in this form is true also of events which are not independent of one another. Laplace exemplifies the composition of such interdependent probabilities by the instance of three urns, A, B, C, about which it is known that two contain only white balls and one only black balls.⁶ The probability of drawing a white ball from an assigned urn, say C, is $\frac{1}{3}$. The probability that, a white ball having been drawn from C, a ball drawn from B will be white, is $\frac{1}{2}$. Therefore the probability of the double event drawing a white ball from C and also from B is $\frac{1}{3} \times \frac{1}{2}$, or $\frac{1}{6}$. The question now arises. Supposing we know only the probability of the double event, which probability we will call [BC], and the probability of one of them, say [C] (but not, as in the case instanced, the mechanism of their interdependence); what can we infer about the probability [B] of the other event (an event such as in the above instance drawing a white ball from the urn B)—the separate probability irrespective of what has happened as to the urn C? We cannot in general say that [B]=[BC] divided by [C] but rather that quotient $\times k$, where k is an unknown coefficient which may be either positive or negative. It might, however, be improper to treat k as zero on the ground that it is equally likely (in the long run of similar data) to be positive or negative. For given values of [BC] and [C], k has not this equiprobable character, since its positive and negative ranges are not in general equal; as appears from considering that [B] cannot be less than [BC], nor greater than unity.⁷

13. *Probability of Causes and Future Effects.*—The first principles which have been established afford an adequate ground for the reasoning which is described as deducing the probability of a cause from an observed event.⁸ If with the poet⁹ we may represent a perfect mixture by the waters of the Po in which the "two Doras" and other tributaries are indiscriminately commingled, there is no great difference in respect of definition and deduction between the probability that a certain particle of water should have emanated from a particular source, or should be discharged through a particular mouth of the river. "This principle," we may say with De Morgan, "of the retrospective or 'inverse' probability is not essentially

different from the one first stated (Principle I.)."¹⁰ Nor is a new first principle necessarily involved when after ascending from an effect to a cause we descend to a collateral effect.¹¹ It is true that in the investigation of causes it is often necessary to have recourse to the unverified species of probability. An instance has already been given of several approximately equiprobable causes, the several values of a quantity under measurement, from one of which the observed phenomena, the given set of observations, must have, so to speak, emanated. A simpler instance of two alternative causes occurs in the investigation which J. S. Mill¹² has illustrated—whether an event, such as a succession of aces, has been produced by a particular cause, such as loading of the die, or by that mass of "fleeting causes" called chance. It is sufficient for the argument that the "a priori" probabilities of the alternatives should not be very unequal.¹³

14. (2) *Whether Credibility is Measurable.*—The domain of probabilities according to some authorities does not extend much, if at all, beyond the objective phenomena which have been described in the preceding paragraphs. The claims of the science to measure the subjective quantity, degree of belief, are disallowed or minimized. Belief, it is objected, depends upon a complex of perceptions and emotions not amenable¹⁴ to calculus. Moreover, belief is not credibility; even if we do believe with more or less confidence in exact conformity with the measure of probability afforded by the calculus, *ought* we so to believe? In reply it must be admitted that many of the beliefs on which we have to act are not of the kind for which the calculus prescribes. It was absurd of Craig¹⁵ to attempt to evaluate the credibility of the Christian religion by mathematical calculation. But there seem to be a number of simpler cases of which we may say with De Morgan¹⁶ "that in the universal opinion of those who examine the subject, the state of mind to which a person *ought* to be able to bring himself" is in accordance with the regulation measure of probability. If in the ordeal to which Portia's suitors were subjected there had been a picture of her not in one only, but in two of the caskets, then—though the judgment of the principal parties might be distorted by emotion—the impartial spectator would normally expect with greater confidence than before that at any particular trial a casket containing the likeness of the lady would be chosen. So the indications of a thermometer may not correspond to the sensations of a fevered patient, but they serve to regulate the temperature of a public library so as to secure the comfort of the majority. This view does not commit us to the quantitative precision of De Morgan that in a case such as above supposed we ought to "look three times as confidently upon the arrival as upon the non-arrival" of the event.¹⁷ Two or three roughly distinguished degrees of credibility—very probable, as probable as not, very improbable, practically impossible—suffice for the more important applications of the calculus. Such is the character of the judgments which the calculus enables us to form with respect to the occurrence of a certain difference between the real value of any quantity under measurement and the value assigned to it by the measurement. The confidence that the constants which we have determined are accurate within certain limits is a subjective feeling which cannot be dislodged from an important part of probabilities.¹⁸ This sphere of subjective probability is widened by the latest developments of the science¹⁹ so far as they add to the number of constants for which it is important to determine the probable—and improbable—error. For instance, a measure of the deviation of observations from an average or mean value was required by the older writers only as subordinate to the determination of the mean, but now this "standard deviation" (below, par. 98) is often treated as an entity for which it is important to discover the limits of error.²⁰ Some of the newer methods may also serve to countenance the measurement of subjective quantity, in so far as they successfully apply the calculus to quantities not admitting of a precise unit, such as colour

¹⁰ De Morgan, *Theory of Probabilities*, § 19; cf. Venn, *Logic of Chance*, ch. vii. § 9; Edgeworth, "On the Probable Errors of Frequency Constants," *Journ. Stat. Soc.* (1908), p. 653. The essential symmetry of the inverse and the direct methods is shown by an elegant proof which Professor Cook Wilson has given for the received rules of inverse probability (*Nature*, 1900, Dec. 13).

¹¹ Laplace's *Seventh Principle*.

¹² *Logic*, book III., ch. xviii. § 6.

¹³ Cf. above, par. 8; below, par. 46.

¹⁴ Cf. Venn, *Logic of Chance*, p. 126.

¹⁵ See the reference to Craig in Todhunter, *History... of Probability*.

¹⁶ *Formal Logic*, p. 173.

¹⁷ *Ibid.* Cf. "Theory of Probabilities" (*Encyc. Metrop.*), note to § 5. "Wherever the term greater or less can be applied there twice, thrice, &c., can be conceived, though not perhaps measured by us."

¹⁸ It is well remarked by Professor Irving Fisher (*Capital and Income*, 1907, ch. xvi.), that Bernoulli's theorem involves a "subjective" element a "psychological magnitude." The remark is applicable to the general theory of error of which the theorem of Bernoulli is a particular case (see below, pars. 103, 104).

¹⁹ In the hands of Professor Karl Pearson, Mr Sheppard and Mr Yule. Cf. par. 149, below.

²⁰ Cf. Edgeworth, *Journ. Stat. Soc.* (Dec. 1908).

¹ Bertrand on "Probabilités composées," *op. cit.* art. 23.

² In some of the experiences referred to at par. 5.

³ See below, pars. 132, 159.

⁴ *Op. cit.* Introduction.

⁵ There is a good statement of them in Boole's *Laws of Thought*, ch. xvi. § 7. Cf. De Morgan "Theory of Probabilities" (*Encyc. Metrop.*), §§ 12 seq.

⁶ Laplace, *op. cit.* Introduction, IV^e Principe; cf. V^e Principe and liv., II. ch. i. § 1.

⁷ In such a case there seems to be a propriety in expressing the indeterminate element in our data, not as above, but as proposed by Boole in his remarkable *Laws of Thought*, ch. xvii., ch. xviii., § 1 (cf. *Trans. Edin. Roy. Soc.*, (1857), vol. xxi.; and *Trans. Roy. Soc.*, 1862, vol. ix., vol. clii. pt. i. p. 251); the undetermined constant now representing the probability that if the event C does not occur the event B will. The values of *this* constant—in the absence of specific data, and where independence is not presumable—are, it should seem, equally distributed between the values 0 and 1. Cf. as to Boole's Calculus, *Mind, loc. cit.*, ix. 230 seq.

⁸ Laplace's *Sixth Principle*. ⁹ Manzoni.

of eye or curliness of hair.¹ A closer analogy is supplied by the older writers who boldly handle "moral" or subjective advantage, as will be shown under the next head.

15. (3) *Axioms of Expectation*.—Expectation so far as it involves probability presents the same philosophical questions. They occur chiefly in connexion with two principles analogous to and deducible from propositions which have been stated with respect to probability.² (i.) The expectation of the sum of two quantities subject to risk is the sum of the expectations of each. (ii.) The expectation of the product of two quantities subject to risk is the product of the expectations of each; provided that the risks are independent. For example, let one of the fortuitously fluctuating quantities be the winnings of a player at a game in which he takes the amount A if he throws ace with a die (and nothing if he throws another face). Then the expectation of that quantity is $\frac{1}{6}A$; or, in n trials (n being large), the player may expect to win about $n\frac{1}{6}A$. Let the other fortuitously fluctuating quantity be winnings of a player at a game in which he takes the amount B when an ace of any suit is dealt from an ordinary pack of cards. The expectation of this quantity is $\frac{1}{13}B$; or in n trials the player may expect to win about $n\frac{1}{13}B$. Now suppose a compound trial at which one simultaneously throws a die and deals a card; and let his winning at a compound trial be the sum of the amounts which he would have received for the die and the card respectively at a simple trial. In n such compound trials he may expect to win about $n\frac{1}{6}A + n\frac{1}{13}B$, or the expectation of the winning at a compound trial is the sum of the separate expectations. Next suppose the winning at a compound trial to be the product of the two amounts which he would have received for the die and the card if played at a simple trial. It is zero unless the player obtains two aces. It is $A \times B$ when this double event occurs. But this double event occurs in the long run only once in 78 times. Accordingly the expectation of the winning at a compound trial at which the winning is the product of the winnings at two simple trials is the product of the separate expectations. What has been shown for two expectations of the simplest type, where a is the probability of an event which has been associated with a quantity a , may easily be extended to several expectations each of the type

$$a_1a_1 + a_2a_2 + a_3a_3 + \dots$$

where a_r is an expectation of the simplest type, above exemplified, or of the type $a_1a_1 \times a_2a_2 \times a_3a_3 \times \dots$ or a mixture of these types. For by the law which has been exemplified the sum of r expectations can always be reduced to the sum of $r-1$, and then the $r-1$ to $r-2$, and so on; and the like is true of products.

16. It should be remarked that the proviso as to the *independence* of the probabilities involved is required only by the *second* of the two fundamental propositions. It may be dispensed with by the first. Thus in the example of interdependent probabilities given by Laplace³—three urns about which it is known that two contain only black balls and one only white—if a person drawing a ball first from C and then from B is to receive x shillings every time he draws a white ball, from one or other of the urns, he may expect if he performs the compound operation n times to receive $n \times 2 \times \frac{1}{3}x$ shillings. But the expectation of the product of the number of shillings won by drawing a white ball from C and the number of shillings won by afterwards drawing a white ball from B is not $n(\frac{1}{3})^2x^2$, but $n\frac{1}{3}x^2$.

17. The first of the two principles is largely employed in the practical applications of probabilities. The second principle is largely employed in the higher generalizations of the science⁴ (the laws of error demonstrated in Part II.); the requisite independence of the involved probabilities being mostly of the unverified⁵ species.

18. *Expectation of Utility*.—A philosophical difficulty peculiar to expectation⁶ arises when the quantity expected has not the objective character usually presupposed in the applications of mathematics. The most signal instance occurs when the expectation relates to an advantage, and that advantage is estimated subjectively by the amount of utility or satisfaction afforded to the possessor. Mathematicians have commonly adopted the assumption made by Daniel Bernoulli that a small increase in a person's material means or "physical fortune" causes an increase of satisfaction or "moral fortune," inversely proportional to the physical fortune; and accordingly that the moral fortune is equateable to the logarithm of the physical fortune.⁷ The spirit in which this assumption should be employed is well expressed by Laplace when he says⁸ that the expect-

tion of subjective advantage (*l'espérance morale*) "depends on a thousand variable circumstances which it is almost always impossible to define and still more to submit to calculation." "One cannot give a general rule for appreciating this relative value," yet the principle above stated in "applying to the commonest cases leads to results which are often useful."

19. In this spirit we may regard the logarithm in Bernoulli's (as in Malthus's) theory as representative of a more general relation. Thus generalized the principle has been accepted by economists and utilitarian philosophers whose judgment on the relation between material goods and utility or satisfaction carries weight. Thus Professor Alfred Marshall writes:⁹ "In accordance with a suggestion made by Daniel Bernoulli, we may perhaps suppose that the satisfaction which a person derives from his income may be regarded as beginning when he has enough to support life and afterwards as increasing by equal amounts with every equal successive percentage that is added to his income; and vice versa for loss of income."¹⁰ The general principle is embodied in Bentham's utilitarian reasoning which has been widely accepted.¹¹ The possibility of formulating the relation between feeling and its external cause is further supported by Fechner's investigations. This branch of Probabilities also obtains support from another part of the science, the calculation sanctioned by Laplace, of the disutility incident to error of measurement.¹² Altogether it seems impossible to deny that some simple mathematical operations prescribed by the calculus of probabilities are sometimes serviceably employed to estimate prospective benefit in the subjective sense of desirable feeling.

20. *Single Cases and "Series"*.—Analogous to the question regarding the standard of belief which arose under a former head, a question regarding the standard of action arises under the head of expectation. The former question, it may be observed, arises chiefly with respect to events which are considered as singular, not forming part of a series. There is no doubt, there is a full belief, that if we go on tossing (unloaded) dice the event which consists of obtaining either a five or a six will occur in approximately 33·3% of the trials. The important question is what is or should be our state of mind with regard to the result of a trial which is *sui generis* and not to be repeated, like the choice of a casket in the *Merchant of Venice*.¹³ A similar difficulty is presented by singular events, with respect to volition. Is the chance of one to a thousand of the prize £1000 at a lottery approximately equivalent to £1 in the eyes of a person who for once, and once only, has the offer of such a stake? The question is separable from one with which it is often confounded, the one discussed in the last paragraph what is the "moral" value of the prize? The person might be a millionaire for whom £1 and £1000 both belong to the category of small change. The stake and the prize might both be "moral." The better opinion seems that apart from a system of transactions like that in which an insurance company undertakes, or at least a "cross-series"¹⁴ of the kind which seem largely to operate in ordinary life, expectations in which the risks are very different are no longer equateable. So De Morgan with regard to the "single case" (the solitary transaction in question) declares that the "mathematical expectation is not a sufficient approximation to the actual phenomenon of the mind when benefits depend upon very small probabilities; even when the fortune of the player forms no part of the consideration"¹⁵ [without making allowance for the difference between "moral" and mathematical probabilities]. So Condorcet, "If one considers a single man and a single event there can be no kind of equality"¹⁶ (between expectations with very different risks). It is only for the long run—*lorsqu'on embrasse la suite indéfinie des évènements*—that the rule is valid: To the same effect at greater length the logicians Dr Venn¹⁷ and von Kries.¹⁸ Some of the mathematical writers have much to learn from their logical critics¹⁹ on this and other questions relating to first principles.

Section II.—Calculation of Probability.

21. *Object of the Section*.—In the following calculations the principal object is to ascertain the number of cases favourable to an event in proportion to the total number of possible cases.²⁰

⁹ *Principles of Economics*, book III., ch. vi. § 6, p. 209, ed. 4.

¹⁰ Cf. below, par. 71.

¹¹ Some further references bearing on the subject are given in a paper by the present writer on the "Pure Theory of Taxation," No. III. *Economic Journ.* (1897), vii. 550-551.

¹² Below, par. 131.

¹³ Above, par. 14.

¹⁴ Above, par. 5.

¹⁵ Article on "Probabilities" (*Encyc. Metrop.*), § 40.

¹⁶ *Essai* (1785), pp. 142 et seq.

¹⁷ *Logic of Chance*, ch. vi. §§ 24-28.

¹⁸ *Wahrscheinlichkeitsrechnung*, pp. 184 seq.

¹⁹ The relations of recent logicians to the older mathematical writers on Probabilities may be illustrated by the relations of modern "historical" economists to their more abstract predecessors.

²⁰ Of the two properties which have been found to characterize probability (above, par. 5)—proportionate (1) number of (equally) favourable cases and (2) frequency of observed occurrence—the former especially pertain to the data and *quaesita* of this section.

¹ Below, par. 152.

² Consider the equivalent of Laplace's second principle given at par. 9, above, and his third principle quoted at par. 10.

³ Above, par. 12.

⁴ In the more familiar form; that (of two independently fluctuating quantities) the mean of the product is the product of the means (cf. Czuber, *Theorie der Beobachtungsfehler*, p. 133).

⁵ Above, par. 6.

⁶ These peculiarities afford some justification for Laplace's restriction of the term expectation to "goods." As to the wider definition here adopted see below, par. 94 and par. 95, note.

⁷ Each fortune referred to is divided by a proper parameter. See below, par. 69.

⁸ *Op. cit.* liv. II. ch. xiii. No. 41. Cf. liv. II. ch. i. No. 2.

"The difficulty consists in the enumeration of the cases," as Lagrange says. Sometimes summation is the only mathematical operation employed; but very commonly it is necessary to apply the theory of permutations and combinations involving multiplication.¹

22. *Fundamental Theorem.*—One of the simplest problems of this sort is one of the most important. Given a *mélange* of things consisting of two species, if n things are taken at random what is the probability that s out of these n things will be of a certain species? For example, the *mélange* might be a well-shuffled pack of cards, and the species black and red; the *quæsitum*, what is the probability that if n cards are dealt, s of them will be black? There are two varieties of the problem: either after each card is dealt it is returned to the pack, which is reshuffled, or all the n cards are dealt (as in ordinary games of cards) without replacement. The first variety of the problem deserves its place as being not only the simpler, but also the more important, of the two.

23. At the first deal there are 26 cases favourable to black, 26 to red. When two deals have been made (in the manner prescribed), out of 52^2 cases formed by combinations between a card turned up at the first deal and a card turned up at the second, 26×26 cases are combinations of two blacks, 26×26 are combinations of two reds, and the remainder $2(26 \times 26)$ are made up of combinations between one black and one red; 26×26 cases of black at the first deal and red at the second, and 26×26 cases of red at the first and black at the second deal. The number of cases favourable to each alternative is evidently given by the several terms in the expansion of $(26+26)^2$. The corresponding probabilities are given by dividing each term by the total number of cases, viz. 52^2 . Similarly, when we go on to a third deal, the respective probabilities of the three possible cases, three blacks, two blacks and one red, two reds and one black, three blacks, are given by the successive terms in the binomial expansion of $(26+26)^3$, and so on. The reasoning is quite general. Thus for the event which consists of dealing either clubs or spades (black) we might substitute an event of which the probability at a single trial is not $\frac{1}{2}$, e.g. dealing hearts. Generally, if p and $1-p$ are the respective probabilities of the event occurring or not occurring at a single trial, the respective probabilities that in n trials the event will occur n times, $n-1$ times . . . twice, once or not at all, are given by the successive terms in the expansion of $[p+(1-p)]^n$; of which expansion the general term is $\frac{n!}{s!(n-s)!} p^s(1-p)^{n-s}$.

24. The probability may also be calculated as follows. Taking for example the case in which the event consists of dealing hearts; consider any particular arrangement of the n cards, of which s are hearts, e.g. the arrangement in which the s cards first dealt are hearts and the following $n-s$ all belong to other suits. The probability of the first s cards being all hearts is $(\frac{1}{52})^s$; the probability that none of the last $(n-s)$ cards are hearts is $(\frac{51}{52})^{n-s}$. Hence the probability of that particular arrangement occurring is $(\frac{1}{52})^s(\frac{51}{52})^{n-s}$. But this arrangement is but one of many, e.g. that in which the s hearts are the last dealt, which are equally likely to occur. There are as many different arrangements of this type as there are combinations of n things taken together s times, that is $n!/s!(n-s)!$. The probability thus calculated agrees with the preceding result.

25. It follows from the law of expansion for $[p+(1-p)]^n$ that as n is increased, the value of the fractions which form the terms at either extremity diminishes. When n becomes very large, the terms which are in the neighbourhood of the greatest term of the expansion overbalance the sum total of the remaining terms.² Thus in the example above given, if we go on and on dealing cards (with replacement) the ratio of the red cards dealt to all the cards dealt tends to become more and more nearly approximate to the limit $\frac{1}{2}$. These statements are comprised in the theorem known as James Bernoulli's. Stated in its simplest form—that "in the long run all events will tend to occur with a relative frequency proportional to their objective probabilities"³—this theorem has been regarded as tautological or circular. Yet the proofs of the theorem which have been given by great mathematicians may deserve attention as at least showing the consistency of first principles.⁴ Moreover, as usually stated, James Bernoulli's imports something more than the first axiom of probabilities.⁵

26. The generalization of the Binomial Theorem which is called

¹ Cf. Bertrand's distinction between "Probabilités totales," and "Probabilités composées," *Calcul des probabilités*, ch. ii. arts. 23, 24.

² Cf. Todhunter, *History . . . of Probability*, p. 360, and other statements of James Bernoulli's Theorem, referred to in the index.

³ Venn, *op. cit.* p. 91.

⁴ Some of these proofs are adduced, and a new and elegant one added by Bertrand, *op. cit.* ch. v.

⁵ When the degree in which a certain range of central terms tends to preponderate over the residue of the series is formulated with precision, as in the statement given by Todhunter (*op. cit.* p. 548) when he is interpreting Laplace, then James Bernoulli's theorem presents a particular case of the law of error—the case considered below in par. 103.

the "Multinomial Theorem"⁶ gives the rule when there are more than two alternatives at each trial. For instance, if there are three alternatives, hearts, diamonds or a card belonging to a black suit, the probability that if n cards are dealt there will occur s hearts, t diamonds, and $n-s-t$ cards which are either clubs or spades is

$$\frac{n!}{s!t!(n-s-t)!} \left(\frac{1}{4}\right)^s \left(\frac{1}{4}\right)^t \left(\frac{1}{2}\right)^{n-s-t}$$

27. *Applications of Fundamental Theorem.*—The peculiar interest of the problem which is here placed first is that its solution represents a law of almost universal application: the law assigning the frequency with which different values assumed by a quantity, like most of the quantities with which statistics has to do, depends upon several independent agencies. It is remarkable that the problem in probabilities which historically was almost the first belongs to the kind which is first in interest. Of this character is a question which occupied Galileo and before him Cardan, and an even earlier writer: what are the chances that, when two or three dice are thrown, the sum of the points or pips turned up should amount to a certain number? A particular case of this problem is presented by the old game of "passedix": what is the probability that if three dice are thrown the sum of the pips should exceed ten?⁷ The answer is obtained by considering the number of combinations that are favourable to each of the different alternatives, 18 pips, 17, 16 . . . 11 pips, which make up the event in question. Thus out of the total of 216 (6^3) combinations, one is favourable to 18, three to 17, and so on. There are twenty-five chances, as we may call the permutations, in favour of 12, twenty-seven in favour of 11.⁸ The sum of all these being 108, we have for the event in question $108/216$, an even chance. More generally it may be inquired: what is the probability that, if n dice are thrown, the number of points turned up will be exactly s ? By an extension of the reasoning which was employed in the first problem it is seen that the required probability is that of which the index is s in the expansion of the expression

$$\left[\left(\frac{1}{6}\right)^1 + \left(\frac{1}{6}\right)^2 + \left(\frac{1}{6}\right)^3 + \left(\frac{1}{6}\right)^4 + \left(\frac{1}{6}\right)^5 + \left(\frac{1}{6}\right)^6\right]^n$$

The calculation may be simplified by writing this expression in the form

$$\left(\frac{1}{6}\right)^n \left[1 - \left(\frac{1}{6}\right)^6\right]^n \left[1 - \frac{1}{6}\right]^{-n}$$

The successive terms of the expansion give the respective probabilities that the number in question should be $n, n+1 . . . 6n$ comprising all the possible numbers among which s is presumably included (otherwise the answer is zero). Of course we are not limited to six alternatives; instead of a die we may have a teetotum with any number of sides. The series expressing the probabilities of the different sums can be written out in general terms, as Laplace and others have done; but it seems to be of less interest than the approximate formula which will be given later.⁹

28. *Variant of the Fundamental Theorem.*—The second variety of our first problem may next be considered. Suppose that after each trial the card dealt (ball drawn, &c.) is not replaced *in statu quo ante*. For instance, if r cards are dealt in the ordinary way from a shuffled pack, what is the probability that s of them will be hearts ($s < 13$)? Consider any particular arrangement of the r cards, whereof s are hearts, e.g. that in which the s cards first dealt are all hearts, the remaining $r-s$ belonging to other suits. The probability of the first card being a heart is $\frac{1}{52}$; the probability that, the first having been a heart, the second should be a heart is $\frac{1}{51}$ (since a heart having been removed there are now 12 favourable cases out of a total of 51 cases). And so on. Likewise the probability of the $(s+1)$ th card being not a heart, all the preceding s having been hearts, is $39/(52-s)$, the probability of the $(s+2)$ th card being not a heart is similarly reckoned. And thus the probability of the particular arrangement considered is found to be

$$\frac{13 \cdot 12 \cdot \dots \{13-(s-1)\} \cdot 39 \cdot 38 \cdot \dots \{39-r-s-1\}}{52 \cdot 51 \cdot \dots \{52-(s-1)\} \cdot \{52-s\} \{52-(s+1)\} \dots \{52-(r-1)\}}$$

Now consider any other arrangement of the r cards, e.g. t of the s hearts to occur first and the remaining $s-t$ last. The denominator in the above expression will remain the same; and in the numerator only the order of the factors will be altered. The probability of the second arrangement is therefore the same as that of the first; and the probability that some one or other of the arrangements will occur is given by multiplying the probability of any one arrangement and the number of different arrangements, which, as in the simpler case of the problem,¹⁰ is the same as the number of combinations formed by r things taken together s times, that is $r!/s!(r-s)!$. The formula thus obtained may be generalized by substituting n for

⁶ See Chrystal, *Algebra*, ch. xxiii. § 12; or other textbook of algebra.

⁷ See Todhunter, *History . . . of Probability*, art. 8; Bertrand, *Calcul des probabilités*, p. vii., or the original documents.

⁸ As Galileo discerned. A friend of his had observed that 11 occurred 1080 times to 1000 times of 12.

⁹ The law of error given below, par. 104.

¹⁰ Above, par. 24.

52, pn for 13, qn for 39 (where $p+q=1$; pn and qn are integers). A formula thus generalized is proposed by Professor Karl Pearson¹ as proper to represent the frequency with which different values are assumed by a quantity depending on causes which are not independent.

29. *Miscellaneous Examples: Games of Chance.*—The majority of the problems under this heading cannot, like the preceding two, be regarded as conducing directly to statistical methods which are required in investigating some parts of nature. They are at best elegant exercises in a kind of mathematical reasoning which is required in most of such methods. Games of chance present some of the best examples. We may begin with one of the oldest, the problem which the Chevalier de Méré put to Pascal when he questioned: How many times must a pair of dice be thrown in order that it may be an even chance that double six—the event called *sonnez*—may occur at least once?² The answer may be obtained by finding a general expression for the probability that the event will occur at least once in n trials; and then determining n so that this expression = $\frac{1}{2}$. The probability of the event occurring is the difference between unity and the probability of its failing. Now the probability of "sonnez" failing at a single throw (of two dice) is $\frac{35}{36}$. Therefore the probability of its failing in n throws is $(\frac{35}{36})^n$. Whence we obtain, to determine n , the equation $1 - (\frac{35}{36})^n = \frac{1}{2}$, which gives $n = 24.605$ nearly.

30. In the preceding problem the *quaesitum* was (unity minus) the probability that out of all the possible events an assigned one ("sonnez") should fail to occur in the course of n trials. In the following problem the *quaesitum* is the probability that out of all the possible events one or other should fail—that they should not all be represented in the course of n trials. A die being thrown n times, what is the probability that all three of the following events will not be represented (that one or other of the three will not occur at least once); viz. (a) either ace or deuce turning up, (b) either 3 or 4, (c) either 5 or 6. The number of cases in which one at least of these events fails to occur is equal to the number of cases in which (a) fails, plus the number in which (b) fails, plus the number in which (c) fails, minus the number of cases in which two of the events fail concurrently (which cases without this subtraction would be counted twice).³ Now the number of cases in which (a) fails to occur in the course of the n trials is $(\frac{2}{3})^n$ of all the possible cases numbering 3^n . Like propositions are true of (b) and (c). The number of cases in which both (a) and (b) fail is $(\frac{1}{3})^n$ of the total;⁴ and the like is true of the cases in which both (a) and (c) fail and the cases in which both (b) and (c) fail. Accordingly the probability that one at least of the events will fail to occur in the course of n trials is

$$3(\frac{2}{3})^n - 3(\frac{1}{3})^n.$$

31. One more step is required by the following problem: If n cards are dealt from a pack, each card after it has been dealt being returned to the pack, which is then reshuffled, what is the probability that one or other of the four suits will not be represented? The probability that hearts will fail to occur in the course of the n deals is $(\frac{3}{4})^n$; and the like is true of the three other suits. From the sum of these probabilities is to be subtracted the sum of the probabilities that there will be concurrent failures of any two suits; but from this subtrahend are to be subtracted the proportional number of cases in which there are concurrent failures of any three suits (otherwise cases such as that in which e.g. hearts, diamonds and clubs concurrently failed⁵ would not be represented at all). Now the probability of any assigned two suits failing is $(\frac{2}{4})^n$; the probability of any assigned three suits failing is $(\frac{1}{4})^n$. Accordingly the required probability is

$$4(\frac{3}{4})^n - 6(\frac{2}{4})^n + 4(\frac{1}{4})^n.$$

The analogy of the Binomial Theorem supplies the clue to the solution of the general problem of which the following is an example.

¹ *Trans. Roy. Soc.* (1895). See below, par. 165.
² Todhunter, *History . . . of Probability*, and Bertrand, *Calcul des probabilités*, p. 9.
³ All three events cannot fail.
⁴ (c) occurring n times.
⁵ The reasoning may be illustrated by using the area of a circle to represent the frequency with which hearts fail, another (equal) circle for diamonds; for the case in which both hearts and diamonds fail the area common to the circles overlapping, and so on.

If a die is thrown n times the probability that every face will have turned up at least once is⁶

$$1 - 6(\frac{5}{6})^n + 15(\frac{4}{6})^n - 20(\frac{3}{6})^n + 15(\frac{2}{6})^n - 6(\frac{1}{6})^n.$$

32. If in the (first) problem stated in paragraph 31 the cards are dealt in the ordinary way (without replacement), we must substitute for $(\frac{3}{4})^n$, the continued product $\frac{39}{52} \cdot \frac{38}{51} \dots \frac{39-(n-1)}{52-(n-1)}$; for $(\frac{2}{4})^n$ the continued product $\frac{26}{52} \cdot \frac{25}{51} \dots \frac{26-(n-1)}{52-(n-1)}$, and so on.

33. Still considering miscellaneous examples relating to games of chance let us inquire what is the probability that at whist each of the two parties should have two honours?⁷ If the turned-up card is an honour, the probability that of the three other honours an assigned one is among the twenty-five which are in the hands of the dealer or his partner, while the remaining two honours are in the hands of the other party, is $\frac{25}{51} \cdot \frac{26}{50} \cdot \frac{25}{49}$. But the assigned card may with equal probability be any one of three honours; and accordingly the above written probability is to be multiplied by 3. If the turned-up card is not an honour then the probability that an assigned pair of honours is in the hands of the dealer or his partner, while the remaining two honours are in the hands of their adversaries, is $\frac{25}{51} \cdot \frac{24}{50} \cdot \frac{26}{49} \cdot \frac{25}{48}$; this probability is to be multiplied by six, as the assigned pair may be any of the six binary combinations formed by the four honours. Now the probability of the alternative first considered—the turned-up card being an honour—is $\frac{4}{13}$; and the probability of the second alternative, $\frac{9}{13}$. Accordingly the required probability is

$$\frac{4}{13} \cdot 3 \cdot \frac{25}{51} \cdot \frac{26}{50} \cdot \frac{25}{49} + \frac{9}{13} \cdot 6 \cdot \frac{25}{51} \cdot \frac{24}{50} \cdot \frac{26}{49} \cdot \frac{25}{48} = \frac{325}{833}.$$

34. The probability that each of the four players should have an honour may be calculated thus.⁸ If the card turned up is an honour then *ipso facto* the dealer has one honour and the probability that the remaining players have each an assigned one of the three remaining honours, is $\frac{13}{51} \cdot \frac{13}{50} \cdot \frac{13}{49}$. Which probability is to be multiplied by 3!, as there are that number of ways in which the three cards may be assigned. If the card turned up is not an honour the probability that each player has an assigned honour is $\frac{13}{51} \cdot \frac{13}{50} \cdot \frac{13}{49} \cdot \frac{12}{48}$. Which probability is to be multiplied by 4!. Accordingly the required probability is

$$\frac{4}{13} \cdot 3! \cdot \frac{13^3}{51 \cdot 50 \cdot 49} + \frac{9}{13} \cdot 4! \cdot \frac{12 \cdot 13^3}{48 \cdot 51 \cdot 50 \cdot 49} = \frac{6 \cdot 13^3}{51 \cdot 50 \cdot 49}$$

(the chance not being affected by the character of the card turned up).
 35. The probability of all the trumps being held by the dealer is

$$\frac{12}{51} \cdot \frac{11}{50} \dots \frac{2}{41} \cdot \frac{1}{40} \text{ or } \frac{12! \cdot 39!}{52!}, \text{ which being calculated by means of tables for (logarithms of) factorials}^9 \text{ or directly,}^{10} \text{ is } 158,753,389,900.$$

36. There is a set of dominoes which goes from double blank to double nine (each domino presenting either a combination—which occurs only once—of two digits, or a repetition of the same digit). What is the probability that a domino drawn from the set will prove to be one assigned beforehand? The probability is the reciprocal of the number of dominoes: which is $10 \times 9 / 2$ (the number of combinations of different digits) + 10 (the number of doubles) = 55.

37. *Choice and Chance.*—When we leave the sphere of games of chance and frame questions relating to ordinary life there is a danger of assuming distributions of probability which are far from probable. For example, let this be the question. The House of Commons formerly consisting of 489 English members, 60 Scottish and 103 Irish, what was the probability that a committee of three members should represent the three nationalities? An assumption of indifference where it does not exist is involved in the answer that the required probability is the ratio of the number of favourable triplets, viz. $489 \times 60 \times 103$ to the total number of triplets, viz. $652 \times 651 \times 650 / 3!$ A similar absence of selection is postulated by the ordinary treatment of a question like the following. There being s candidates

⁶ See Whitworth, *Exercises in Choice and Chance*, No. 502 (p. 125); referring to prop. xiv. of the same author's *Choice and Chance*.
⁷ Cf. Whitworth, *Choice and Chance*, question 143, p. 183, ed. 4.
⁸ *Ibid.*
⁹ There is such a table at the end of De Morgan's article in the *Calculus of Probabilities* in the *Ency. Brit.* "Pure Sciences," vol. ii.
¹⁰ Cancelling factors common to the numerator and denominator.

at an examination and r optional subjects from which each candidate chooses one ($r > s$), what is the probability that no two candidates should choose the same subject? If the candidates be arranged in any order, the probability that the second candidate should not choose the same subject as the first candidate is $(n-1)/n$. The probability that the third candidate will not choose either of the two subjects taken by the aforesaid candidates is $(n-2)/n$, and so on. Thus the required probability is

$$\frac{n(n-1)(n-2)\dots\{n-(s-1)\}}{n^s}$$

38. When as in these cases the interest of the problem lies chiefly in the application of the theory of combinations, or permutations, there is a propriety in Whitworth's enunciation of the questions under the head of *choice* rather than *chance*. It comes to the same whether we say that there are x ways in which an event may happen, or that the probability of its happening in an assigned one of those ways is $1/x$. For example, suppose that there are n couples waltzing at a ball; if the names of the men are arranged in alphabetical order, what is the probability that the names of their partners will also be in alphabetical order? The probability that the man who is first in alphabetical order should have for partner the lady who is first in that order is $1/n$. The probability that the man who is second in alphabetical order should have for partner the lady who is second in that order is $1/(n-1)$, and so on. Therefore the required probability is $1/n!$. Or it may be easier to say that the number of ways, each consisting of a set of couples in which the party can be arranged, is $n!$; of which only one is favourable.

39. The same principle governs the following question. For how many days can a family of 10 continue to sit down to dinner in a different order each day; it not being indifferent who sits at the head of the table—what is the absolute, as well as the relative, position of the members? The number of permutations, viz. 10!, is the answer. If we are to attend to the relative position only—as would be natural if the question related to 10 children turning round a fly-pole—the number of different arrangements would be only 9!

40. *Method of Equations in Finite Differences.*—The last question may serve to introduce a method which Laplace has applied with great *éclat* to problems in probabilities. Let y_n be the number of ways in which n men can take their places at a round table, without respect to their *absolute* position; and consider how the number will be increased by introducing an additional man. From every particular arrangement of the original n men can now be obtained n different arrangements of the $n+1$ men (since the additional man may sit between any two of the party of n). Hence $y_{n+1} = ny_n$, an *equation of differences* of which the solution is $C(n-1)!$. The constant may be determined by considering the case in which n is 2.

41. The following example is not quite so simple. If a coin is thrown n times, what is the chance that head occurs at least twice running? Calling each sequence of n throws a "case," consider the number of cases in which head never occurs twice running; let u_n be this number, then $2^n - u_n$ must be the number of cases when head occurs at least twice successively. Consider the value of u_{n+2} ; if the last or $(n+2)$ th throw be tail, u_{n+2} includes all the cases (u_{n+1}) of the $n+1$ preceding throws which gave no succession of heads; and if the last be head the last but one must be tail, and these two may be preceded by any one of the u_n favourable cases for the first n throws. Consequently,

$$u_{n+2} = u_{n+1} + u_n$$

If α, β are the roots of the quadratic $x^2 - x - 1 = 0$, this equation gives¹

$$u_n = A\alpha^n + B\beta^n$$

Here A and B are easily found from the conditions $u_1 = 2, u_2 = 3$; viz.

$$A = \frac{\alpha^2}{\alpha - \beta}, B = \frac{\beta^2}{\beta - \alpha}$$

whence
$$u_n = \frac{n+2}{2^{n+1}} \left\{ 1 + \frac{(n+1)n}{1 \cdot 2 \cdot 3} 5 + \&c. \right\}$$

The probability that head never turns up twice running is found by dividing this by 2^n , the whole number of cases. This probability, of course, becomes smaller and smaller as the number of trials (n) is increased. This is a particular case of a more general problem solved by Laplace² as to the occurrence i times running of an event of which the probability at one trial is p .

42. In such problems where we now employ the calculus of finite difference Laplace employed his method of generating functions. A distinguished instance is afforded by the problem of points which was put by the Chevalier de Méré to Pascal and has exercised generations of mathematicians. It is thus stated by Laplace.³ Two players of equal skill have staked equal sums; the stakes to belong to the player who shall have won a certain number of games. Suppose they agree to leave off playing when one player, A, wants x "points" (games to be won) in order to complete the assigned number, while the second player wants x' points: how ought they

to divide the stakes? This is a question in *Expectation*, but its difficulty consists in determining the probability that one of the players, say A, shall win the stakes. Let that probability be $y_{x,x'}$. Then, after the next game, if A has won, the probability of his winning the stakes will be $y_{x-1,x'}$. But if A loses, B winning, the probability will be $y_{x,x'-1}$. But these alternatives are equally likely. Accordingly the probability of A winning the stakes may be written

$$y_{x,x'} = \frac{1}{2} y_{x-1,x'} + \frac{1}{2} y_{x,x'-1}$$

This is the same probability as that which was before written $y_{x,x'}$. Equating the two expressions we have, for the function y , an equation of finite difference involving two variables, of which the solution is⁴

$$y = \frac{1}{2^{x+x'}} \left\{ 1 + \frac{x}{1} \frac{1}{2} + \frac{x(x+1)}{1 \cdot 2} \frac{1}{2^2} + \dots + \frac{x(x+1)\dots(x+x'-2)}{1 \cdot 2 \dots (x'-1)} \frac{1}{2^{x'-1}} \right\}$$

43. The problem of points is to be distinguished from another classical problem, relating to a contest in which the winner has not simply to win a certain number of games, but to win a certain number of counters from his opponent.⁵ Space does not admit even the enunciation of other complicated problems to which Laplace has applied the method of generating functions.

44. *Probability of Causes Deduced from Observed Events.*—Problems relating to the probability of alternative causes, deduced from observed effects, are usually placed in the separate category of "inverse" probability, though, as above remarked,⁶ they do not necessarily involve different principles. The difference principally consists in the need of evidence, other than that which is afforded by the observed event, as to the probability of the alternative causes existing and operating. The following is an example free from the difficulty incident to unverified a priori probabilities, which commonly besets this kind of problem. A digit having been taken at random from mathematical tables (or the expansion of an endless constant such as π); a second digit is obtained by taking from a random succession of digits one that added to the first digit makes a sum greater than 9. Given a result thus formed, what are the respective probabilities that the second digit should have been 0, 1, 2, . . . 8 or 9? In the long run the first digit assumes with equal frequency the values 0, 1, 2 . . . 8, 9. Accordingly the second digit can never be 0. There is only one chance of its being 1, namely when the first digit is 9. If the second digit is 2, and the first either 8 or 9, the observed effect will be produced. And so on. If the second digit is 9, the effect may occur in nine ways. Accordingly in the long run of pairs thus formed it will occur that the cases or causes which are defined by the circumstances that the second digit is 0, 1, 2, . . . 8, 9, respectively, will occur with frequencies in the following ratios 0 : 1 : 2 : . . . 8 : 9. The probability of the observed event having been caused by a particular (second) digit, e.g. 7, is $7/(0+1+2+\dots+9) = 7/45$.

45. The following example taken from Laplace⁷ is of a more familiar type. An urn is known to contain three balls made up of white and black balls in some unknown proportion. From this urn a ball is extracted m times (being each time replaced after extraction). If a white ball is drawn every time, what are the respective probabilities that the number of white balls in the urn are 3, 2, 1 or 0? By parity of reasoning it appears that in the first case the result is certain, its probability 1, in the second case the probability of the observed event occurring is $(\frac{2}{3})^m$, in the third case that probability is $(\frac{1}{3})^m$, in the fourth case *zero*. Accordingly the respective inverse probabilities are in the ratios

$$1 : (\frac{2}{3})^m : (\frac{1}{3})^m : 0;$$

provided that (as in the preceding example, with respect to the second digits) the alternative causes, the four possible constitutions of the urn, are (a priori) equally probable. This is rather a bold assumption with respect to the contents of concrete urns⁸ and similar groupings; but with regard to things in general may perhaps be justified on the principle of *cross-series*.⁹

46. Often in the investigation of causes we are not thrown back on unverified a priori probabilities. We have some specific evidence though of a very rough character. An example has been cited from Mill in a preceding paragraph.¹⁰ Against the improbabilities calculated by the methods of the present section there has often to be balanced an improbability evidenced by common sense, which does not admit of mathematical calculation. Bertrand¹¹ puts the following case. The manager of a gambling house has purchased a roulette table which is found to give *red* 5300 times, *black* 4700 times, out of 10,000 trials. The purchaser claims an indemnity from the maker. What can the calculus tell us as to the justice of the claim? Nothing

⁴ A clear and corrected version of Laplace's reasoning is given by Todhunter, *History . . . of Probability*, art. 973, p. 528, with reference to the more general cases in which the "skills" of each party—their chances of winning a single game—are not equal but respectively p and q ($p+q=1$). See also Czuber, *Wahrscheinlichkeitstheorie*, pp. 30 seq.

⁵ See Todhunter, *op. cit.* art. 107, and other articles referring to duration of play. See also Boole, *Finite Differences*, ch. xiv., art. 7, ex. 6.

⁶ Above, par. 13.

⁷ *Op. cit.* liv. II, ch. i. No. 1.

⁸ Cf. Bertrand, *op. cit.* § 118.

⁹ Above, par. 5.

¹⁰ Par. 13.

¹¹ *Op. cit.* § 134.

¹ Cf. Boole's *Finite Differences*, ch. vii. § 5.

² *Op. cit.* liv. II, ch. ii., No. 12.

³ *Op. cit.* liv. II, ch. ii., No. 8.

precise, yet something worth knowing. The a priori improbability of the maker's inaccuracy must be very great to overcome the improbability of such an event occurring by chance if the machine is accurately made (accuracy being defined, say, by the condition that the ratio of red to [red+white] would prove to be in the indefinitely long run of trials between 0.499 and 0.501). The odds against the so defined event occurring are found to be some millions to one.¹

47. The difficulty recurs in more practical problems: for instance, certain symptoms having been observed, to find the probability that they are produced by a particular disease. Such concrete applications of probabilities are often open to the sort of objections which have been urged against the classical use of the calculus to determine the probability that witnesses are true, or judges just.

48. *Probability of Testimony.*—The application of probabilities to testimony proceeds upon two assumptions: (1) that to each witness there pertains a coefficient of probability representing the average frequency with which he speaks the truth or untruth, (2) that the statements of witnesses are independent in the sense proper to probabilities. Thus if two witnesses concur in making a statement which must be either true or false, their agreement is a circumstance which is only to be accounted for by one of two alternatives: either that they are both speaking the truth, or both false. If the average truthfulness—the credibility—of one witness is p , that of the other p' , then the probabilities of the two alternative explanations are to each other in the ratio $pp' : (1-p)(1-p')$; the probability that the statement is true is $pp' / \{pp' + (1-p)(1-p')\}$. So far no account is taken of the a priori probability of the statement. This evidence may be treated as an independent witness. Thus, if a person whose credibility is p asserts that he has seen at whist a hand consisting entirely of trumps dealt from a well-shuffled pack of cards, there are two alternative explanations of his assertion, with probabilities in the ratio

$$p \times 0.000,000,000,0063 : (1-p) \times 0.999,999,999,993.$$

The truthfulness of the witness must be very great to outweigh the a priori improbability of the fact.² These formulae are easily extended to the case of three or more witnesses. The probability of a statement made by three witnesses of respective credibilities p, p', p'' is

$$pp'p'' / \{pp'p'' + (1-p)(1-p')(1-p'')\}.$$

For r witnesses we have

$$p_1 p_2 \dots p_r / \{p_1 p_2 \dots p_r + (1-p_1)(1-p_2) \dots (1-p_r)\}.$$

Dividing both the numerator and the denominator by $p_1 p_2 \dots p_r$, we see that the probability of the statement increases with the number of the witnesses, provided that for every witness $(1-p)/p$ is a proper fraction, and accordingly $p > \frac{1}{2}$. As an example of several witnesses, let us inquire how many witnesses to a fact such as a hand at whist consisting entirely of trumps would be required in order to make it an even chance that the fact occurred, supposing the credibility of each witness to be $\frac{3}{4}$. Let x be the required number of witnesses. We have the $1 / (1 + (\frac{1}{4})^x \times 0.000,000,000,006) = \frac{1}{2}$, or $x \log 9 = 12.2$. Whence, if x is 13, it is more than an even chance that the statement is true.

49. When an event may occur in two or more ways equally probable a priori, the formulae show that the probability of the statement will depend on the credibility of the witnesses; and accordingly the explicit consideration of a priori probabilities may, as in our first instance, be omitted. One who reports the number of a ticket obtained at a lottery ordinarily makes a statement against which there is no a priori improbability; but if the number is one which had

been predicted, there is an a priori improbability $\frac{1}{n}$ that an assigned ticket should be drawn out of a *mélange* of n tickets. Similar reasoning is applicable to the probability that the decisions of judgments, the verdict of juries, is right.

50. The assumptions upon which all this reasoning is based are open to serious criticisms. The postulated independence of witnesses and judges is frequently not realized. The revolutionary tribunal which condemned Condorcet was affected by an identity of illusions and passions which that mathematician had not taken into account when he calculated "that the probability of a decision being conformable to truth will increase indefinitely as the number of voters is increased."⁴

51. The use of coefficients based on the average truthfulness or justice of each witness and judge involves the neglect of particulars which ought to influence our estimate of probability, such as the consistency of a witness's statements and the relation of the case to the interests, prejudices and capacities of the witness or the judge.⁵ Thus even in so simple a case as the alleged occurrence of

an extraordinary hand at whist, the "truthfulness" of the witness in the general sense of the term may not adequately represent his liability to have made a mistake about the shuffling.⁶ A neglect of particulars, however, is sometimes practised with success in the applications of statistics (insurance, for instance). Perhaps there are broad results and general rules to which the mathematical theory may be applicable. Perhaps the laborious researches of Poisson on the "probability of judgments" are not, as they have been called by an eminent mathematician, *absolument rien*.⁷ More than mathematical interest may attach to Laplace's investigation of a rule appropriate to cases like the following. An event (suppose the death of a certain person) must have proceeded from one of n causes A, B, C, &c., and a tribunal has to pronounce on which is the most probable. Professor Morgan Crofton's original proof of Laplace's rule is here reproduced.⁸

52. Let each member of the tribunal arrange the causes in the order of their probability according to his judgment, after weighing the evidence. To compare the presumption thus afforded by any one judge in favour of a specified cause with that afforded by the other judges, we must assign a value to the probability of the cause derived solely from its being, say, the r th on his list. As he is supposed to be unable to pronounce any closer to the truth than to say (suppose) H is more likely than D, D more likely than L, &c., the probability of any cause will be the average value of all those which that probability can have, given simply that it always occupies the same place on the list of the probabilities arranged in order of magnitude. As the sum of the n probabilities is always 1, the question reduces to this:—

Any whole (such as the number 1) is divided at random into n parts, and the parts are arranged in the order of their magnitude—least, second, third, . . . greatest; this is repeated for the same whole a great number of times; required the mean value of the least, of the second, &c., parts, up to that of the greatest.

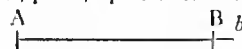

Let the whole in question be represented by a line $AB = a$, and let it be divided at random into n parts by taking $n-1$ points indiscriminately on it. Let the required mean values be

$$\lambda_1 a, \lambda_2 a, \lambda_3 a \dots \lambda_n a,$$

where $\lambda_1, \lambda_2, \lambda_3 \dots$ must be constant fractions. As a great number of positions is taken in AB for each of the n points, we may take a as representing that number; and the whole number N of cases will be

$$N = a^{n-1}.$$

The sum of the *least* parts, in every case, will be

$$S_1 = N \lambda_1 a = \lambda_1 a^n.$$

Let a small increment, $Bb = \delta a$, be added on to the line AB at the end B ; the increase in this sum is $\delta S_1 = n \lambda_1 a^{n-1} \delta a$. But, in dividing the new line Ab , either the $n-1$ points all fall on AB as before, or $n-2$ fall on AB and 1 on Bb (the cases where 2 or more fall on Bb are so few we may neglect them). If all fall on AB , the least part is always the same as before except when it is the last, at the end B of the line, and then it is greater than before by δa ; as it falls last in $n-1$ of the whole number of trials, the increase in S_1 is $n^{-1} a^{n-1} \delta a$. But if one point of division falls on Bb , the number of new cases introduced is $(n-1) a^{n-2} \delta a$; but, the least part being now an infinitesimal, the sum S_1 is not affected; we have therefore

$$\delta S_1 = n \lambda_1 a^{n-1} \delta a = n^{-1} a^{n-1} \delta a; \therefore \lambda_1 = n^{-2}.$$

To find λ_2 , reasoning exactly in the same way, we find that where one point falls on Bb and $n-2$ on AB , as the least part is infinitesimal, the *second least* part is the *least* of the $n-1$ parts made by the $n-2$ points; consequently, if we put λ'_1 for the value of λ_1 when there are $n-1$ parts only, instead of n ,

$$\delta S_2 = n \lambda_2 a^{n-1} \delta a = n^{-1} a^{n-1} \delta a + (n-1) a^{n-2} \lambda'_1 a \delta a, \therefore n \lambda_2 = n^{-1} + (n-1) \lambda'_1; \text{ but } \lambda'_1 = (n-1)^{-2}; \therefore n \lambda_2 = n^{-1} + (n-1)^{-1}.$$

In the same way we can show generally that

$$n \lambda_r = n^{-1} + (n-1) \lambda'_{r-1};$$

and thus the required mean value of the r th part is

$$\lambda_r a = a^{n-1} \{ n^{-1} + (n-1)^{-1} + (n-2)^{-1} + \dots + (n-r+1)^{-1} \}.$$

he places among the "misapplications of the calculus which have made it the real opprobrium of mathematics" (*Logic*, Book III, ch. xviii. § 3). Cf. Bertrand, *Calcul des probabilités*; Venn, *Logic of Chance*, ch. xvi. § 5-7; v. Kries, *Principien der Wahrscheinlichkeitsrechnung*, ch. ix., preface, § v., and ch. xiii. §§ 12, 13; Laplace's general reflections on this matter seem more valuable than his calculations: "Tant de passions et d'intérêts particuliers y mêlent si souvent leur influence qu'il est impossible de soumettre au calcul cette probabilité," *op. cit.* Introduction (*Des Choix et décisions des assemblées*).

⁶ As to the possibility of mistake in this respect, see Proctor, *How to play Whist*, p. 121.

⁷ Bertrand, *loc. cit.*

⁸ *Loc. cit.* § 43.

¹ By a calculation based on the fundamental theorem (above, par. 23; cf. below, par. 103).

² But see below, par. 51.

³ Morgan Crofton, *loc. cit.* p. 778, par. 1.

⁴ *Essai*, p. 6 (there is postulated a proviso analogous to that which has been stated in par. 49 above, with reference to witnesses: that the probability of any one voter being right is $> \frac{1}{2}$).

⁵ See Mill's forcible remarks on this use of probabilities, which

Thus each judge implicitly assigns the probabilities

$$\frac{1}{n^2}, \frac{1}{n} \left(\frac{1}{n} + \frac{1}{n-1} \right), \frac{1}{n} \left(\frac{1}{n} + \frac{1}{n-1} + \frac{1}{n-2} \right),$$

to the causes as they stand on his list, beginning from the lowest. The values assigned for the probability of each alternative cause may be treated as so many equally authoritative observations representing a quantity which it is required to determine. According to a general rule given below the observations are to be added and divided by their number; but here if we are concerned only with the relative magnitudes of the probabilities in favour of each alternative it suffices to compare the sums of the observations. We thus arrive at Laplace's rule. Add the numbers found on the different lists for the cause A, for the cause B, and so on; that cause which has the greatest sum is the most probable.

53. *Probability of Future Effects deduced from Causes.*—Another class of problems which it is usual to place in a separate category are those which require that, having ascended from an observed event to probable causes, we should descend to the probability of collateral effects. But no new principle is involved in such problems. The reason may be illustrated by the following modification of the problem about digits which was above set ² to illustrate the method of deducing the probability of alternative causes. What is the probability that if to the *second* digit which contributed to the effect there described there is added a *third* digit taken at random, the sum of the second and third will be greater than 10 (or any other assigned figure)? The probabilities—the a posteriori probabilities derived from the observed event (that the sum of the first and second digit exceeds 9)—each multiplied by 45, of the alternatives constituted by the different values 0, 1, 2, . . . 8, 9 of the second figure are written in the first of the subjoined rows.

0	1	2	3	4	5	6	7	8	9
0	0	1	2	3	4	5	6	7	8
0	0	2	6	12	20	30	42	56	72

Below each of these probabilities is written the probability, $\times 10$ that if the corresponding cause existed the effect under consideration would result. The product of the two probabilities pertaining to each alternative way of producing the event gives the probability of the event occurring in that way. The sum of these products which are written in the third row divided by 45×10 , viz. $\frac{342}{450} = \frac{7}{10}$, is the required probability. It may be expected that actual trial would verify this result.

54. "*Rule of Succession.*"—One case of inferred future effects, sometimes called the "rule of succession," claims special notice as having been thought to furnish a test for the cogency of induction. A white ball has been extracted (with replacement after extraction) n times from an immense number of black and white balls mixed in some unknown proportion; what is the probability that at the $(n+1)$ th trial a white ball will be drawn? It is assumed that each constitution of the *mélange*³ formed by the proportion of white balls (the probability of drawing a white ball), say p , is a priori as likely to have any one value as another of the series

$$\Delta p, 2\Delta p, 3\Delta p, \dots, 1-2\Delta p, 1-\Delta p, 1.$$

Whence a posteriori the probability of any particular value of p as the cause of the observed recurrence is $p^n / \Sigma p^n$, where p in the denominator receives every value from Δp to 1. The probability that this cause, if it exists, will produce the effect in question, the extraction of a white ball at the $(n+1)$ th trial, is p . The probability of the event, obtained by summing the probabilities of all the different ways in which it may occur, is accordingly $\Sigma p^{n+1} / \Sigma p^n$, where p both in the numerator and the denominator is to receive all possible values between Δp and 1. In the limit we have

$$\int_0^1 p^{n+1} dp / \int_0^1 p^n dp = (n+1) / (n+2).$$

In particular if $n=1$, the probability that an event which has been observed once will recur on a second trial is $\frac{2}{3}$. These results are perhaps not so absurd as they have seemed to some critics, when the principle of "cross-series"⁴ is taken into account. Among authorities who seem to attach importance to the rule of succession, in addition to the classical writers on Probabilities, may be mentioned Lotze⁵ and Karl Pearson.⁶

Section III.—*Calculation of Expectation.*

55. *Analogue of Preceding Problems.*—This section presents problems analogous to the preceding. If n balls are extracted

¹ Below, pars. 135, 136. A difficulty raised by Cournot with respect to the determination of several quantities which are connected by an equation does not here arise. The system of values determined for the several causes fulfils by construction the condition that the sum of the values should be equal to unity.

² Above, par. 44.

³ It comes to the same to suppose the total number of balls in the mixture to be N ; and to assume that the number of white balls is a priori equally likely to have any one of the values 1, 2, . . . $N-1, N$.

⁴ Above, par. 5.

⁵ *Logic*, bk. ii. ch. ix. § 5.

⁶ *Grammar of Science*, ch. iv. § 16. Cf. the article in *Mind* above referred to, ix. 234.

from an urn containing black and white balls mixed up in the proportions p : $(1-p)$, each ball being replaced after extraction, the expected number of white balls in the set of n is by definition np .⁷ It may be instructive to verify the consistency of first principles by *demonstrating* this axiomatic proposition.⁸ Consider the respective probabilities that in the series of n trials there will occur no white balls, exactly one white ball, exactly two white balls, and so on, as shown in the following scheme:—

No. of white balls	0,	1,	2,	...	n
Corresponding probability.	$(1-p)^n,$	$\frac{nl}{(n-1)!} (1-p)^{n-1} p,$	$\frac{n!}{(n-2)! 2!} (1-p)^{n-2} p^2,$...	p^n

To calculate the expectation of white balls it is proper to multiply 1 by the probability that exactly one white ball will occur, 2 by the probability of two white balls, and so on. We have thus for the required expectation

$$\begin{aligned} & \frac{n!}{(n-1)!} (1-p)^{n-1} p + \frac{n!}{(n-2)!} (1-p)^{n-2} p^2 + \dots \\ & \quad + \frac{n!}{(n-r)! r!} (1-p)^{n-r} p^r + \dots + np^n \\ = & np [(1-p)^{n-1} + (n-1)(1-p)^{n-2} p + \dots \\ & \quad + \frac{(n-1)!}{(n-r)! r!} (1-p)^{n-r} p^{r-1} + \dots + p^{n-1}] \\ = & np[(1-p) + p]^{n-1} = np. \end{aligned}$$

The expectation in the case where the balls are not replaced—not similarly axiomatic—may be found by approximative formulae.⁹

56. *Games of Chance.*—With reference to the topic which occurred next under the head of probabilities, a distinction must be drawn between the number of trials which make it an even chance that all the faces of a die will not have turned up at least once, and the number of trials which are made on an average before that event occurs. We may pass from the probability to expectation in such cases by means of the following theorem. If s is the number of trials in which on an average success (such as turning up every face of a die at least once) is obtained, then $s = 1 + f_1 + f_2 + \dots$; where f_r denotes the probability of failing in the first r trials. For the required expectation is equal to $1 \times$ probability of succeeding at the first trial $+ 2 \times$ probability of succeeding at the second trial $+ \&c.$ Now the probability of succeeding at the first trial is $1 - f_1$; the probability of succeeding at the second trial (after failing at the first) is $f_1(1 - f_2)$; the probability of succeeding at the third trial is similarly $f_2(1 - f_3)$; and so on. Substituting these values for the expression for the expectation, we have the proposition which was to be proved. In the proposed problem

$$f_n = 6 \left(\frac{5}{6} \right)^n - 15 \left(\frac{4}{6} \right)^n + 20 \left(\frac{3}{6} \right)^n - 15 \left(\frac{2}{6} \right)^n + 6 \left(\frac{1}{6} \right)^n$$

Assigning to n in each of these terms, every value from 1 to ∞ we have $6 \cdot \frac{5}{6} / (1 - \frac{5}{6}) = 30$, for the sum of the first set, with corresponding expressions for the sets formed from the following terms. Whence $s = 1 + 30 - 30 + 20 - \frac{15}{2} + \frac{6}{3} = 14.7$. By parity of reasoning it is proved that on an average $7\frac{1}{2}$ cards¹⁰ must be dealt before at least one card of every suit has turned up.¹¹

57. Dominoes are taken at random (with replacement after each extraction) from the set of the kind described in a preceding paragraph.¹² What is the difference (irrespective of sign) to be expected between the two numbers on each domino? The digit 9, according as it is combined with itself, or any smaller digit, gives the sum of differences

$$0 + 1 + 2 + \dots + 9.$$

The digit 8 combined with itself or any smaller digit gives the sum of differences $0 + 1 + 2 + \dots + 8$ and so on. The sum of the differences is $\Sigma \frac{1}{2} r \cdot r + 1$, where r has every integer value

from 1 to 9 inclusive, $= \frac{9(9+1)(9+2)}{2 \cdot 3} = 165$. And the number

of the differences is $10 + 9 + 8 + \dots + 2 + 1 = 55$. Therefore the required expectation is $165/55 = 3$.

58. *Digits taken at Random.*—The last question is to be distinguished from the following. What is the difference (irrespective of sign) between two digits, taken at random from mathematical tables, or the expansion of an endless constant like π ? The combinations of different digits will now occur twice as often as the repetitions of the same digit. The sum of the differences may now be obtained from the consideration that the sum of the *positive* differences must be equal to sum of the *negative* differences when the *null* differences are distributed equally between the positive and the negative set. The sum of the positive set is, as before,

⁷ See the introductory remarks headed "Description and Division of the Subject."

⁸ Cf. above, par. 25.

⁹ See Pearson, *Phil. Trans.* (1895), A.

¹⁰ Whitworth, *Exercises*, No. 502.

¹¹ *Ibid.* No. 504, cf. above, par. 29.

¹² *Ibid.* par. 36.

165. But the denominator of this numerator is not the same as before, but less by half the number of null differences, that is 5. We thus obtain for the required expectation $165/50 = 3.3$.

59. A simple verification of this prediction may thus be obtained. In a table of logarithms note any two digits so situated as to afford no presumption of close correlation; for instance, in the last place of the logarithm of 10009 the digit 7 and in the last place of the logarithm of 10019 the digit 4, and take the difference between these two, viz. 3, irrespective of sign. Proceed similarly with the similarly situated pair which form the last places of the logarithms of 10029 and 10039; for which the difference is 1, and so on. The mean of the differences thus found ought to be approximately 3.3. Experimenting thus on the last digits of logarithms, in Hutton's tables extending to seven places, from the logarithm of 10009 to the logarithm of 10909, the writer has found for the mean of 250 differences, 3.2.

60. *Points taken at Random.*—By parity of reasoning it may be shown that if two different milestones are taken at random on a road n miles long (there being a stone at the starting-point) their average distance apart is $\frac{1}{3}(n+2)$.

61. If instead of finite differences as in the last two problems the intervals between the numbers or degrees which may be selected are indefinitely small, we have the theorem that the mean distance between two points taken at random on a finite straight line is a third of the length of that straight line.

62. The fortuitous division of a straight line is happily employed by Professor Morgan Crofton to exhibit Laplace's method of determining the worth of several candidates by combining the votes of electors. There is a close relation between this method and the method above given for determining the probabilities of several alternatives by combining the judgments of different judges.¹ But there is this difference—that the several estimates of worth, unlike those of probability, are not subject to the condition that their sum should be equal to a constant quantity (unity). The *quaesita* are now expectations, not probabilities. Professor Morgan Crofton's version² of the argument is as follows. Suppose there are n candidates for an office; each elector is to arrange them in what he believes to be the order of merit; and we have first to find the numerical value of the merit he thus implicitly attributes to each candidate. Fixing on some limit a as the maximum of merit, n arbitrary values less than a are taken and then arranged in order of magnitude—least, second, third, . . . greatest; to find the mean value of each.

Rules for Voting at Elections.

Take a line $AB = a$, and set off n arbitrary lengths AX, AY, AZ, \dots beginning at A ; that is, n points are taken at random in AB . Now the mean values of AZ, XY, YZ, \dots are all equal; for if a new point P be taken at random, it is equally likely to be 1st, 2nd, 3rd, &c., in order beginning from A , because out of $n+1$ points the chance of an assigned one being 1st is $(n+1)^{-1}$; of its being 2nd $(n+1)^{-1}$; and so on. But the chance of P being 1st is equal to the mean value of AX divided by AB ; of its being 2nd $M(XY) \div AB$; and so on. Hence the mean value of AX is $AB(n+1)^{-1}$; that of AY is $2AB(n+1)^{-1}$; and so on. Thus the mean merit assigned to the several candidates is

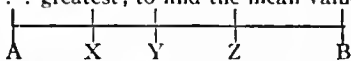

$a(n+1)^{-1}, 2a(n+1)^{-1}, 3a(n+1)^{-1}, \dots, na(n+1)^{-1}$.

Thus the relative merits may be estimated by writing under the names of the candidates the numbers 1, 2, 3, . . . n . The same being done by each elector, the probability will be in favour of the candidate who has the greatest sum.

Practically it is to be feared that this plan would not succeed, because, as Laplace observes, not only are electors swayed by many considerations independent of the merit of the candidates, but they would often place low down in their list any candidate whom they judged a formidable competitor to the one they preferred, thus giving an unfair advantage to candidates of mediocre merit.

63. This objection is less appropriate to competitive examinations, to which the method may seem applicable. But there is a more fundamental objection in this case, if not indeed in every case, to the reasoning on which the method rests: viz. that there is supposed an a priori distribution of values which is in general not supposable; viz. that the several estimates of worth, the marks given to different candidates by the same examiner, are likely to cover evenly the whole of the tract between the minimum and maximum, e.g. between 0 and 100. Experience, fortified by theory, shows that very generally such estimates are not thus indifferently disposed, but rather in an order which will presently be described as the normal law of error.³ The theorem governing the case would therefore seem to be not that which is applied by Laplace and Morgan Crofton, but that which has been investigated by Karl Pearson,⁴ a theorem which does not lend itself so readily to the purpose in hand.⁶

64. *Expectation of Advantage.*—The general examples of expectation which have been given may be supplemented by some appropriate to that special use of the term which Laplace has sanctioned when he considers the subject of expectation as a "good"; in particular money, or that for the sake of which money is desired, "moral" advantage, in more modern phrase utility or satisfaction.

65. *Pecuniary Advantage.*—The most important calculations of pecuniary expectation relate to annuities and insurance; based largely on life tables from which the expectation of life itself, as well as of money value at the end, or at any period, of life is predicted. The reader is referred to these heads for practical exemplifications of the calculus. It must suffice here to point out how the calculations are facilitated by the adoption of a law of frequency, the Gompertz or the Gompertz-Makeham law, which on the one hand can hardly be ranked with hypotheses resting on a *vera causa*, yet on the other hand is not purely empirical, but is recommended, as germane to the subject-matter, by colourable suppositions.⁸

66. There is space here only for one or two simple examples of money as the subject of expectation. Two persons A and B throw a die alternately, A beginning, with the understanding that the one who first throws an ace is to receive a prize of $\pounds 1$. What are their respective expectations?⁷ The chance that the prize should be won at the first throw is $\frac{1}{6}$, the chance that it should be won at the second throw is $\frac{5}{6} \times \frac{1}{6}$; at the third throw $(\frac{5}{6})^2 \times \frac{1}{6}$, at the fourth throw $(\frac{5}{6})^3 \times \frac{1}{6}$, and so on. Accordingly the expectation of A

is $\pounds 1 \times \frac{1}{6} \{1 + (\frac{5}{6})^2 + (\frac{5}{6})^4 + \dots\}$;

expectation of B

is $\pounds 1 \times \frac{1}{6} \times \frac{5}{6} \{1 + (\frac{5}{6})^2 + (\frac{5}{6})^4 + \dots\}$.

Thus A 's expectation is to B 's as 1 : $\frac{5}{6}$. But their expectations must together amount to $\pounds 1$. Therefore A 's expectation is $\frac{6}{11}$ of a pound, B 's $\frac{5}{11}$.

67. There are n tickets in a bag, numbered 1, 2, 3, . . . n . A man draws two tickets at once, and is to receive a number of sovereigns equal to the product of the numbers drawn. What is his expectation?⁸ It is the number of pounds divided by an improper fraction of which the denominator is the number of possible products, $\frac{1}{2}n(n-1)$, and the numerator is the sum of all possible products $= \frac{1}{2}\{1+2+3+\dots+n\}^2 - (1^2+2^2+\dots+n^2)$. Whence the required number (of pounds) is found to be $\frac{1}{2}(n+1)(3n+2)$. The result may be contrasted with what it would be if the two tickets were not to be drawn at once, but the second after replacement of the first. On this supposition the expectation in respect of one of the tickets separately is $\frac{1}{2}(n+1)$. Therefore, as the two events are now independent, the expectation of the product,⁹ being the product of the expectations, is $\frac{1}{4}(n+1)^2$.

68. Peter throws three coins, Paul two. The one who obtains the greater number of heads wins $\pounds 1$. If the number of heads are equal, they play again, and so on, until one or other obtains a greater number of heads. What are their respective expectations?¹⁰ At the first trial there are three alternatives: (a) Peter obtains more heads than Paul, (b) an equal number, (c) fewer. The cases in favour of a are (1) Peter obtains three heads, (2) Peter, two heads, while Paul one or none, (3) Peter one head, Paul none. The cases in favour of b are (1) two heads for both, or (2) one head, or (3) none, for both. The remaining case favours c . The probability of a is $\frac{1}{8} + \frac{3}{8} + \frac{3}{8} = \frac{7}{8}$. The probability of b is $\frac{3}{8} + \frac{3}{8} + \frac{1}{8} = \frac{7}{8}$. The probability of c is $1 - \frac{7}{8} = \frac{1}{8}$. Alternative b is to be split up into three a', b', c' , of which the probabilities (when b has occurred) are as before, $\frac{2}{7}, \frac{2}{7}, \frac{1}{7}$. b' is similarly split up, and so on. Thus Peter's expectation is $\frac{7}{8}(1 + \frac{7}{8} + (\frac{7}{8})^2 + \dots) \pounds 1 = \frac{49}{15} \pounds 1$. Paul's expectation is $\frac{7}{8} \pounds 1$.

An urn contains m balls marked 1, 2, 3, . . . m . Paul extracts successively the m balls, under an agreement to give Peter a shilling every time that a ball comes out in its proper order. What is Peter's expectation? The expectation with respect to any one ball is $\frac{1}{m}$, and therefore the expectation with respect to all is 1 (shilling).¹¹

69. *Advantage subjectively estimated.*—Elaborate calculations are paradoxically employed by Laplace and other mathematicians to determine the expectation of subjective advantage in various cases of risk. The calculation is based on Daniel Bernoulli's formula which may be written thus: If x denote a man's physical fortune, and y the corresponding moral fortune

$$y = k \log(x/h),$$

k, h being constants. x and y are always positive, and $x > h$; for every

trace Karl Pearson's theory in the statistics relating to the efficiency of wages (*Economic Journal*, Dec. 1907; and *Journ. Stat. Soc.*, Dec. 1907).

⁶ Cf. below, par. 169.

⁷ Whitworth, *Choice and Chance*, question 126.

⁸ Whitworth, *Exercises*, No. 567.

⁹ According to the principle above enounced, par. 15.

¹⁰ Bertrand, id. § 44, prob. xlvii.

¹¹ Bertrand, id. § 39, prob. xliii. It is not to be objected that the probabilities on which the several expectations are calculated are not independent (above, par. 16).

¹ Above, par. 52.

² *Loc. cit.* § 45.

³ See Edgeworth, "Elements of Chance in Examinations," *Journ. Stat. Soc.* (1890). Cf. below, par. 124.

⁴ *Biometrika*, i. 390.

⁵ Moore, of Columbia University, New York, has attempted to

man must possess some fortune, or its equivalent, in order to live. To estimate now the value of a *moral expectation*. Suppose a person whose fortune is a to have the chance p of obtaining a sum a , q of obtaining β , r of obtaining γ , &c., and let

$$p+q+r+\dots=1,$$

only one of the events being possible. Now his moral expectation from the first chance—that is, the increment of his moral fortune multiplied by the chance—is

$$pk \left\{ \log \frac{a+a}{h} - \log \frac{a}{h} \right\} = pk \log (a+a) - pk \log a.$$

Hence his whole moral expectation is ¹

$$E = kp \log (a+a) + kq \log (a+\beta) + kr \log (a+\gamma) + \dots - k \log a;$$

and, if Y stands for his moral fortune including this expectation, that is, $k \log (a/h) + E$, we have

$$Y = kp \log (a+a) + kq \log (a+\beta) + \dots - k \log h.$$

To find X , the physical fortune corresponding to this moral one, we have

$$Y = k \log X - k \log h.$$

Hence $X = (a+a)^p (a+\beta)^q (a+\gamma)^r$,

and $X-a$ will be the actual or physical increase of fortune which is of the same value to him as his expectation, and which he may reasonably accept in lieu of it. The mathematical value of the same expectation is ²

$$pa+q\beta+r\gamma+\dots$$

70. *Gambling and Insurance*.—These formulae are employed, often with the aid of refined mathematical theorems, to demonstrate received propositions of great practical importance: that in general gambling is disadvantageous, insurance beneficial, and that in speculative operations it is better to subdivide risks—not to “have all your eggs in one basket.”

71. These propositions may be deduced by the use of a formula which perhaps keeps closer to the facts: viz. that utility or satisfaction is a function of material goods not definitely ascertainable, defined only by the conditions that the function continually increases with the increase of the variable, but at a continually decreasing rate (and some additional postulate as to the lower limit of the variable), say $y = \psi(x)$ (if x as before denotes physical fortune, and y the corresponding utility or satisfaction); where all that is known in general of ψ is that $\psi'(x)$ is positive, $\psi''(x)$ is negative; and $\psi(x)$ is never less, x is always greater than zero. Suppose a gambler whose (physical) fortune is a , to have the chance p of obtaining a sum a and the chance $q (= 1-p)$ of losing the sum β . If the game is fair in the usual sense of the term $pa = q\beta$. Accordingly the prospective psychological advantage of the party is $p\psi(a+a) + q\psi(a-\beta) = p\psi(a+a) + q\psi[a - (p/q)a]$, say y_a . When a is zero the expression reduces to the first state of the man, $\psi(a)$, say y_0 . To compare this state with what it becomes by the gambling transaction, let a receive continually small increments of Δa . When a is zero the first differential coefficient of $(y_a - y_0)$, viz. $p\psi'(a) - p\psi'(a)$, = 0. Also the second differential coefficient, viz. $p\psi''(a) + \frac{p^2}{q}\psi''(a)$, is negative, since by hypothesis ψ'' is continually negative. And as a continues to increase from zero, the second differential coefficient of $(y_a - y_0)$, viz. $p\psi''(a+a) + \frac{p^2}{q}\psi''(a + \frac{p}{q}a)$, continues to be negative. Therefore the increments received by the first differential coefficient of $(y_a - y_0)$ are continually negative; and therefore $(y_a - y_0)$ is continually negative; $y_a < y_0$,³ for finite values of a (not exceeding qa/p).⁴

72. To show the advantage of insurance, let us suppose with Morgan Crofton⁵ that a merchant, whose fortune is represented by 1, will realize a sum ϵ if a certain vessel arrives safely. Let the probability of this be p . To make up exactly for the risk run by the insurance company, he should pay them a sum $(1-p)\epsilon$. If he does, his moral fortune becomes, according to the formula now proposed $\psi(1+p\epsilon)$, since his physical fortune is increased by the secured sum ϵ , minus the payment $(1-p)\epsilon$; while if he does not insure it will be $p\psi(1+\epsilon) + (1-p)\psi(1)$. We have then to compare $\psi(1+p\epsilon)$, say y_1 , with $p\psi(1+\epsilon) + (1-p)\psi(1)$, say y_2 . By reasoning analogous to that of the preceding paragraph it appears that $(y_2 - y_1)$ is zero when $\epsilon = 0$ and continually diminishes as ϵ increases up to any assigned finite (admissible) value. Similarly it may be shown that it is better to expose one's fortune in a number of separate sums to risks independent of each other than

to expose the whole to the same danger. Suppose a merchant, having a fortune, has besides a sum ϵ which he must receive if a ship arrives in safety. Then, if the chance of the ship arriving = p , and $q = 1-p$, his prospective advantage is $p\psi(1+\epsilon) + q\psi(1)$. Now instead of exposing the lump sum ϵ to a single risk, let him subdivide ϵ into n equal parts, each exposed to an independent equal risk (q) of being lost. As n is made larger⁶ it becomes more and more nearly a certainty that he will realize $p\epsilon$ out of the total ϵ exposed to risk. Therefore his condition (in respect of the sort of advantage which is under consideration) will be approximately $\psi(1+p\epsilon)$. Then we have to compare $\psi(1+p\epsilon)$, say y_1 , with $p\psi(1+\epsilon) + q\psi(1)$, say y_2 . By reasoning analogous to that which has been above employed—observing that $(p-p^2)\psi''(1)$ is negative for all possible values of p —we conclude that $y_2 < y_1$.

73. *The Petersburg Problem*.—The doctrine of “moral fortune” was first formulated by Daniel Bernoulli⁷ with reference to their celebrated “Petersburg Problem,” which is thus stated by Todhunter⁸: “A throws a coin in the air: if head appears at the first throw he is to receive a shilling from B, if head does not appear until the second throw he is to receive 2s., if head does not appear until the third throw he is to receive 4s., and so on, required the expectation of A.” So many lessons are presented by this problem that there has been room for disputing what is the lesson. Laplace and other high authorities follow Daniel Bernoulli. Poisson finds the explanation in the fact that B could not be expected to pay up so large a sum. Whitworth, who regards the disadvantage of gambling as consisting mainly in the danger of becoming “cleaned out,”⁹ finds this moral in the Petersburg problem. All have not noticed what some regard as the principal lesson to be obtained from the paradox: viz. that a transaction which cannot be regarded as one of a series—at least a “cross-series”¹⁰—is not subject to the general rule for expectations of advantage whether material or moral.¹¹

Section IV.—Geometrical Applications.

74. Under this head occur some interesting illustrations of principles employed in the preceding sections; in particular of a priori probabilities and of the relation between probability and expectation.

75. *Illustrations of a priori Probabilities*.—The assumption which has been made under preceding heads that the probability of certain alternatives is approximately equal appears to rest on evidence of much the same character as the assumption which is made under this head that one point in a line, plane or volume is as likely to occur as another, under certain circumstances. Thus consider the proposition: if a given area S is included within a given area A , the chance of a point P , taken at random on A , falling on S is S/A . In a great variety of circumstances such a size can be assigned to the spaces, and “taking at random” can be so defined that the proposition is more or less directly based on experience. The fact that the points of incidence are equally distributed in space is observed, or connected by inference with observation, in many cases, e.g. raindrops and molecules. There is a solid substratum of evidence for the premiss employed in the solution of problems like the following: On a chess-board, on which the side of every square is a , there is thrown a coin of diameter b ($b < a$) so as to be entirely on the board, which may be supposed to have no border. What is the probability that the coin is entirely on one square?¹² The area on which the coin can fall is $(8a-b)^2$. The portion of the area which is favourable to the event is $64(a-b)^2$. Therefore the required probability is $(a-b)^2/(a-\frac{1}{2}b)^2$.

76. *Random Lines*.—Speculative difficulties recur when we have to define a straight line taken at random in a plane; for instance, in the following problem proposed by Buffon.¹³

A floor is ruled with equidistant parallel lines; a rod, shorter than the distance between each pair, being thrown at random on the floor, to find the chance of its falling on one of the lines. The problem is usually solved as follows:—

Let x be the distance of the centre of the rod from the nearest line, θ the inclination of the rod to a perpendicular to the parallels, $2a$ the common distance of the parallels, $2c$ the length of rod; then, as all values of x and θ between their extreme limits are equally probable, the whole number of cases will be represented by

$$\int_0^a \int_{-\pi/2}^{\pi/2} dx d\theta = \pi a.$$

¹ It is important to remark that we should be wrong in thus adding the expectations if the events were not mutually exclusive. For the mathematical expectations it is not so.

² This paragraph is taken from Morgan Crofton's article on “Probability,” in the 9th edition of the *Ency. Brit.*

³ Cf. Marshall, *Principles of Economics*, Mathematical Appendix, note ix.

⁴ Or should we rather say, not exceeding the limit at which $\psi(a-pa/q)$ becomes 0? (The value of $\psi(0)$ may be regarded as $-\infty$.) Neither of the proposed limitations materially affects the validity of the theorem.

⁵ *Loc. cit.*, par. 25.

⁶ See above, par. 25 (James Bernoulli's theorem).

⁷ *Specimen theoriae novae de mensura sortis* (16), translated (into German) with notes by Pringsheim (1906).

⁸ *Op. cit.*, art. 389.

⁹ *Choice and Chance*, pp. 211, 232. The danger of a party to a game of chance being “ruined” (by losing more than his whole fortune), which forms a separate chapter in some treatises, is readily deducible from the theory of deviations from an average which will be stated in pt. ii.

¹⁰ Above, par. 5.

¹¹ Above, par. 20.

¹² Whitworth, *Exercises*, No. 500.

¹³ Cf. Morgan Crofton, *loc. cit.*

Now if the rod crosses one of the lines we must have $c > x/\cos \theta$; so that the favourable cases will be measured by

$$\int_{-\pi/2}^{\pi/2} d\theta \int_0^{c \cos \theta} dx = 2c.$$

Thus the probability required is $p = 2c/\pi a$.

It may be asked—why should we take the centre of the rod as the point where distance from the nearest line has all its values equally probable? Why not one extremity of the line, or some other point suited to the circumstances of projection? Fortunately it makes no difference in the result to what point in the rod we assign this pre-eminence.

77. The legitimacy of the assumption obtains some verification from the success of a test suggested by Laplace. If a rod is actually thrown, as supposed in the problem, a great number of times, and the frequency with which it falls on one of the parallels is observed, that proportionate number thus found, say p , furnishes a value for the constant π . For π ought to equal $2c/pa$. The experiment has been made by Professor Wolf of Frankfort. Having thrown a needle of length 36 mm. on a plane ruled with parallel lines at a distance from each other of 45 mm. 5000 times, he observed that the needle crossed a parallel 2532 times. Whence the value of π is deduced 3.1596, with a probable error¹ $\approx .05$.

78. More hesitation may be felt when we have to define a random chord of a circle,² for instance, with reference to the question, what is the probability that a chord taken at random will be greater than the side of an equilateral triangle? For some purposes it would no doubt be proper to assume that the chord is constructed by taking any point on the circumference and joining it to another point on the circumference, the points from which one is taken at random being distributed at equal intervals around the circumference. On this understanding the probability in question would be $\frac{1}{3}$. But in other connexions, for instance, if the chord is obtained by the intersection with the circle of a rod thrown in random fashion, it seems preferable to consider the chord as a case of a straight line falling at random on a plane. Morgan Crofton³ himself gives the following definition of such a line: If an infinite number of straight lines be drawn at random in a plane, there will be as many parallel to any given direction as to any other, all directions being equally probable; also those having any given direction will be disposed with equal frequency all over the plane. Hence, if a line be determined by the co-ordinates p, ω , the perpendicular on it from a fixed origin O , and the inclination of that perpendicular to a fixed axis, then, if p, ω be made to vary by equal infinitesimal increments, the series of lines so given will represent the entire series of random straight lines. Thus the number of lines for which p falls between p and $p+dp$, and ω between ω and $\omega+d\omega$, will be measured by $dpd\omega$, and the integral $\iint dpd\omega$, between any limits, measures the number of lines within those limits.

79. Authoritative and useful as this definition is, it is not entirely free from difficulty. It amounts to this, that if we write the equation of the random line

$$x \cos \alpha + y \sin \alpha - p = 0,$$

we ought to take a and p as those variables, of which the equiprobable values are equally probable—the equiprobable variables, as we may say. But might we not also write the equation in either of the following forms

$$(1) \quad x/a + y/b - 1 = 0,$$

$$(2) \quad ax + by - 1 = 0,$$

and take a and b in either system as the equiprobable variables? To be sure, if the equal distribution of probabilities is extended to infinity we shall be landed in the absurdity that of the random lines passing through any point on the axis of y a proportion differing infinitesimally from unity—100%—are either (1) parallel or (2) perpendicular to the axis of x . But the admission of infinite values will render any scheme for the equal distribution of probabilities absurd. If Professor Crofton's constant p , for example, becomes infinite, the origin being thus placed at an infinite distance, all the random chords intersecting a finite circle would be parallel!

80. However this may be, Professor Crofton's conception has the distinction of leading to a series of interesting propositions, of which specimens are here subjoined.⁴ The number of random lines which meet any closed convex contour of length L is measured by L . For, taking O inside the contour, and integrating first for p , from 0 to p , the perpendicular on the tangent to the contour, we have $\int pd\omega$; taking this through four right angles for ω , we have

¹ As recorded by Czuber, *Geometrische Wahrscheinlichkeiten*, p. 90.

² Cf. Bertrand, *Calcul des probabilités*, pp. 4 seq. The matter has been much discussed in the *Educational Times*. See *Mathematical Questions* . . . from the *Educational Times* [a reprint], xxix. 17-20, containing references to earlier discussions, e.g. x. 33 (by Woolhouse).

³ *Loc. cit.* § 75.

⁴ The whole of p. 787 of Morgan Crofton's article is often referred to, and parts of pp. 786, 788 are transferred here.

by Legendre's theorem on rectification, N being the measure of the number of lines,

$$N = \int_0^{2\pi} pd\omega = L.$$

Thus, if a random line meet a given contour, of length L , the chance of its meeting another convex contour, of length l , internal to the former is $p = l/L$. If the given contour be not convex, or not closed, N will evidently be the length of an endless string, drawn tight around the contour.

81. If a random line meet a closed convex contour of length L , the chance of it meeting another such contour, external to the former, is $p = (X - Y)/L$, where X is the length of an endless band enveloping both contours, and crossing between them, and Y that of a band also enveloping both, but not crossing. This may be shown by means of Legendre's integral above; or as follows:—

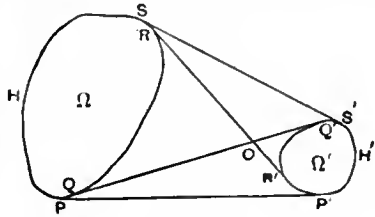

FIG. 1.

Call, for shortness, $N(A)$ the number of lines meeting an area A ; $N(A, A')$ the number which meet both A and A' ; then (fig. 1)

$$N(SROQPH) + N(S'Q'OR'P'H) = N(SROQPH + S'Q'OR'P'H) + N(SROQPH, S'Q'OR'P'H),$$

since in the first member each line meeting both areas is counted twice. But the number of lines meeting the non-convex figure consisting of $OQPHSR$ and $OQ'S'H'P'R'$ is equal to the band Y , and the number meeting both these areas is identical with that of those meeting the given areas Ω, Ω' ; hence $X = Y + N(\Omega, \Omega')$. Thus the number meeting both the given areas is measured by $X - Y$. Hence the theorem follows.

82. Two random chords cross a given convex boundary, of length L , and area Ω ; to find the chance that their intersection falls inside the boundary.

Consider the first chord in any position; let C be its length; considering it as a closed area, the chance of the second chord meeting it is $2C/L$; and the whole chance of its coordinates falling in $dp, d\omega$ and of the second chord meeting it in that position is

$$\frac{2C}{L} \frac{dpd\omega}{\iint dpd\omega} = \frac{2}{L^2} C dpd\omega.$$

But the whole chance is the sum of these chances for all its positions;

$$\therefore \text{prob.} = 2L^{-2} \iint C dpd\omega.$$

Now, for a given value of ω , the value of $\int C dp$ is evidently the area Ω ; then, taking ω from π to 0, we have

$$\text{required probability} = 2\pi\Omega L^{-2}.$$

The mean value of a chord drawn at random across the boundary is

$$M = \frac{\iint C dpd\omega}{\iint dpd\omega} = \frac{\pi\Omega}{L}.$$

83. A straight band of breadth c being traced on a floor, and a circle of radius r thrown on it at random; to find the mean area of the band which is covered by the circle. (The cases are omitted where the circle falls outside the band.)⁵

If S be the space covered, the chance of a random point on the circle falling on the band is $p = M(S)/\pi r^2$, this is the same as

⁵ This result also follows by considering that, if an infinite plane be covered by an infinity of lines drawn at random, it is evident that the number of these which meet a given finite straight line is proportional to its length, and is the same whatever be its position. Hence, if we take l the length of the line as the measure of this number, the number of random lines which cut any element ds of the contour is measured by ds , and the number which meet the contour is therefore measured by $\frac{1}{2}L$, half the length of the boundary. If we take $2l$ as the measure for the line, the measure for the contour will be L , as above. Of course we have to remember that each line must meet the contour twice. It would be possible to rectify any closed curve by means of this principle. Suppose it traced on the surface of a circular disk, of circumference L , and the disk thrown a great number of times on a system of parallel lines, whose distance asunder equals the diameter, if we count the number of cases in which the closed curve meets one of the parallels, the ratio of this number to the whole number of trials will be ultimately the ratio of the circumference of the curve to that of the circle. [Morgan Crofton's note.]

⁶ Or the floor may be supposed painted with parallel bands, at a distance asunder equal to the diameter; so that the circle must fall on one.

if the circle were fixed, and the band thrown on it at random. Now let A (fig. 2) be a position of the random point; the favourable cases are when HK, the bisector of the band, meets a circle, centre A, radius $\frac{1}{2}c$; and the whole number are when HK meets a circle, centre O, radius $r + \frac{1}{2}c$; hence the probability is

$$p = \frac{2\pi \cdot \frac{1}{2}c}{2\pi(r + \frac{1}{2}c)} = \frac{c}{2r + c}$$

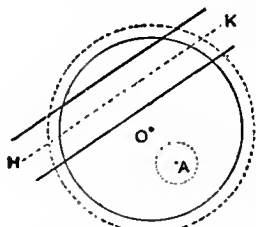

FIG. 2.

This is constant for all positions of A; hence, equating these two values of p , the mean value required is $M(S) = c(2r + c)^{-1}\pi r^2$.

The mean value of the portion of the circumference which falls on the band is the same fraction $c/(2r + c)$ of the whole circumference.

If any convex area whose surface is Ω and circumference L be thrown on the band, instead of a circle, the mean area covered is

$$M(S) = \pi c(L + \pi c)^{-1}\Omega.$$

For as before, fixing the random point at A, the chance of a random point in Ω falling on the band is $p = 2\pi \cdot \frac{1}{2}c/L'$, where L' is the perimeter of a parallel curve to L , at a normal distance $\frac{1}{2}c$ from it. Now

$$L' = L + 2\pi \cdot \frac{1}{2}c, \\ \therefore \frac{M(S)}{\Omega} = \frac{\pi c}{L + \pi c}$$

84. Buffon's problem may be easily deduced in a similar manner.

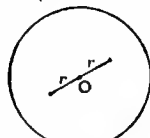

FIG. 3.

Thus, if $2r$ = length of line, a = distance between the parallels, and we conceive a circle (fig. 3) of diameter a with its centre at the middle O of the line, rigidly attached to the latter, and thrown with it on the parallels, this circle must meet one of the parallels; if it be thrown an infinite number of times we shall thus have an infinite number of chords crossing it at random. Their number is measured by $2\pi \cdot \frac{1}{2}a$, and the number which meet $2r$ is measured by $4r$. Hence the chance that the line $2r$ meets one of the parallels is $p = 4r/\pi a$.

85. To investigate the probability that the inclination of the line joining any two points in a given convex area Ω shall lie within given limits. We give here a method of reducing this question to calculation, for the sake of an integral to which it leads, and which is not easy to deduce otherwise.

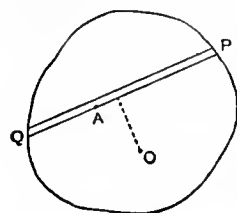

FIG. 4.

First let one of the points A (fig. 4) be fixed; draw through it a chord PQ = C, at an inclination θ to some fixed line; put AP = r , AQ = r' ; then the number of cases for which the direction of the line joining A and B lies between θ and $\theta + d\theta$ is measured by $\frac{1}{2}(r^2 + r'^2)d\theta$.

Now let A range over the space between PQ and a parallel chord distant dp from it, the number of cases for which A lies in this space and the direction of AB from θ to $\theta + d\theta$ is (first considering A to lie in the element $d\theta dp$)

$$\frac{1}{2}dpd\theta \int_0^C (r^2 + r'^2)dr = \frac{1}{3}C^3dpd\theta.$$

Let p be the perpendicular on C from a given origin O, and let ω be the inclination of p (we may put $d\omega$ for $d\theta$), C will be a given function of p , ω ; and, integrating first for ω constant, the whole number of cases for which ω falls between given limits ω', ω'' is

$$\frac{1}{3} \int_{\omega'}^{\omega''} d\omega \int C^3 dp;$$

the integral $\int C^3 dp$ being taken for all positions of C between two tangents to the boundary parallel to PQ. The question is thus reduced to the evaluation of this double integral, which, of course, is generally difficult enough; we may, however, deduce from it a remarkable result; for, if the integral $\frac{1}{3} \int \int C^3 dp d\omega$ be extended to all possible positions of C, it gives the whole number of pairs of positions of the points A, B which lie inside the area; but this number is Ω^2 ; hence

$$\int \int C^3 dp d\omega = 3\Omega^2,$$

the integration extending to all possible positions of the chord C, — its length being a given function of its co-ordinates p, ω .²

COR. Hence if L, Ω be the perimeter and area of any closed convex contour, the mean value of the cube of a chord drawn across it at random is $3\Omega^2/L$.

86. Let there be any two convex boundaries (fig. 5) so related that a tangent at any point V to the inner cuts off a constant segment S from the outer (e.g. two concentric similar ellipses); let the annular area between them be called A; from a point X taken at random on this annulus draw tangents XA, XB to the inner. The mean value of the arc AB, $M(AB) = LS/A$, L being the whole length of the inner curve ABV.

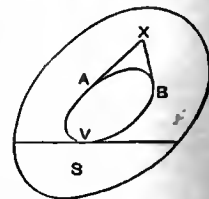

FIG. 5.

The following lemma will first be proved:—

If there be any convex arc AB (fig. 6), and if N_1 be (the measure of) the number of random lines which meet it once, N_2 the number which meet it twice,



FIG. 6.

$$2 \text{ arc } AB = N_1 + 2N_2.$$

For draw the chord AB; the number of lines meeting the convex figure so formed is $N_1 + N_2 = \text{arc} + \text{chord}$ (the perimeter); but $N_1 = \text{number of lines meeting the chord} = 2 \text{ chord}$;

$$\therefore 2 \text{ arc} + N_1 = 2N_2 + 2N_2, \therefore 2 \text{ arc} = N_1 + 2N_2.$$

Now fix the point X, in fig. 5, and draw XA, XB. If a random line cross the boundary L, and p_1 be the probability that it meets the arc AB once, p_2 that it does so twice,

$$2AB/L = p_1 + 2p_2;$$

and if the point X range all over the annulus, and p_1, p_2 are the same probabilities for all positions of X,

$$2M(AB)/L = p_1 + 2p_2.$$

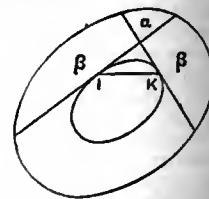

FIG. 7.

Let now IK (fig. 7) be any position of the random line; drawing tangents at I, K, it is easy to see that it will cut the arc AB twice when X is in the space marked α , and once when X is in either space marked β ; hence, for this position of the line, $p_1 + 2p_2 = 2(\alpha + \beta)/A = 2S/A$, which is constant; hence $M(AB)/L = S/A$.

Hence the mean value of the arc is the same fraction of the perimeter that the constant area S is of the annulus.

If L be not related as above to the outer boundary, $M(AB)/L = M(S)/A$, $M(S)$ being the mean area of the segment cut off by a tangent at a random point on the perimeter L.

The above result may be expressed as an integral. If s be the arc AB included by tangents from any point (x, y) on the annulus,

$$\iint s dx dy = LS.$$

It has been shown (*Phil. Trans.*, 1868, p. 191) that, if θ be the angle between the tangents XA, XB,

$$\iint \theta dx dy = \pi(A - 2S).$$

The mean value of the tangent XA or XB may be shown to be $M(XA) = SP/2A$, where P = perimeter of locus of centre of gravity of the segment S.

87. When we go on to species of three dimensions further speculative difficulties occur. How is a random line through a given point to be defined? Since it is usual to define a vector by two angles (viz. ϕ the angle made with the axis X by a vector r in the plane XY, and θ (or $\frac{1}{2}\pi - \theta$) the angle made by the vector ρ with r in the plane containing both ρ and r and the axis Z) it seems natural to treat the angles ϕ and θ as the equiprobable variables. In other words, if we take at random any meridian on the celestial globe and combine it with any right ascension the vector joining the centre to the point thus assigned is a random line.³ It is possible that for some purposes this conception may be appropriate. For many purposes surely it is proper to assume a more symmetrical distribution of the terminal points on the surface of a sphere, a distribution such that each element of the surface shall contain an approximately equal number of points. Such an assumption is usually made in the kinetic theory of molecules with respect to the direction of the line joining the centres of two colliding spheres in a "molecular chaos."⁴ It is safe to say with Czuber, "No discussion can remove indeterminateness." Let us hope with him that "though this branch of probability can for the present claim only a theoretic interest, in the future it will perhaps also lead to practical results."⁵

88. Illustrations of probability and expectation.—The close relation between probability and expectation is well illustrated by geometrical examples. As above stated, when a given space S is included within a given space A, if p is the probability that a point

¹ The line might be anywhere within the circle without altering the question.

² This integral was given by Morgan Crofton in the *Comptes rendus* (1869), p. 1469. An analytical proof was given by Serret, *Annales scient. de l'école normale* (1869), p. 177.

³ Cf. Bertrand, *op. cit.* § 135.

⁴ See e.g. Watson, *Kinetic Theory of Gases*, p. 2; Tait, *Trans. Roy. Soc., Edin.* (1888), xxxiii. 68.

⁵ *Wahrscheinlichkeitstheorie*, p. 64.

P, taken at random on A, falling on S, $p = S/A$. If now the space S be variable, and $M(S)$ be its mean value

$$p = M(S)/A.$$

For, if we suppose S to have n equally probable values S_1, S_2, S_3, \dots , the chance of any one S_1 being taken, and of P falling on S_1 , is

$$p_1 = n^{-1}S_1/A;$$

now the whole probability $p = p_1 + p_2 + p_3 + \dots$, which leads at once to the above expression. The chance of two points falling on S is, in the same way,

$$p = M(S^2)/A^2,$$

and so on.

In such a case, if the probability be known, the mean value follows, and vice versa. Thus, we might find the mean value of the n th power of the distance XY between two points taken at random in a line of length l , by considering the chance that, if n more points are so taken, they shall all fall between X and Y. This chance is

$$M(XY)^n/l^n = 2(n+1)^{-1}(n+2)^{-1};$$

for the chance that X shall be one of the extreme points, out of the whole $(n+2)$, is $2(n+2)^{-1}$; and, if it is, the chance that the other extreme point is Y is $(n+1)^{-1}$. Therefore

$$M(XY)^n = 2l^n(n+1)^{-1}(n+2)^{-1}.$$

A line l is divided into n segments by $n-1$ points taken at random; to find the mean value of the product of the n segments. Let a, b, c, \dots be the segments in one particular case. If n new points are taken at random in the line, the chance that one falls on each segment is

$$1.2.3 \dots nbc \dots /l^n;$$

hence the chance that this occurs, however the line is divided, is $n!l^{-n}M(abc \dots)$.

Now the whole number of different orders in which the whole $2n-1$ points may occur is $(2n-1)!$; out of these the number in which one of the first series falls between every two of the second is easily found by the theory of permutations to be $n!(n-1)!$. Hence the required mean value of the product is

$$M(abc \dots) = \frac{(n-1)!}{(2n-1)!} l^n.$$

89. Additional examples of the relation between probability and expectation appear in the following series of propositions: (1) If M be the mean value of any quantity depending on the positions of two points (e.g. their distance) which are taken, one in a space A, the other in a space B (external to A); and if M' be the same mean when both points are taken indiscriminately in the whole space A+B; M_a, M_b the same mean when both points are taken in A and both in B respectively; then

$$(A+B)^2 M' = 2ABM + A^2 M_a + B^2 M_b.$$

If the space $A=B$, $4M' = 2M + M_a + M_b$; if, also, $M_a = M_b$, then $2M' = M + M_a$.

(2) The mean distance of a point P within a given area from a fixed straight line (which does not meet the area) is evidently the distance of the centre of gravity G of the area from the line. Thus, if A, B are two fixed points on a line outside the area, the mean value of the area of the triangle APB = the triangle AGB. From this it will follow that, if X, Y, Z are three points taken at random in three given spaces on a plane (such that they cannot all be cut by any straight line), the mean value of the area of the triangle XYZ is the triangle GG'G'', determined by the three centres of gravity of the spaces.

(3) This proposition is of use in the solution of the following problem:—

Two points X, Y are taken at random within a triangle. What is the mean area M of the triangle XYC, formed by joining them with one of the angles of the triangle?

Bisect the triangle by the line CD; let M_1 be the mean value when both points fall in the triangle ACD, and M_2 the value when one falls in ACD and the other in BCD; then $2M = M_1 + M_2$. But $M_1 = \frac{1}{2}M$; and $M_2 = GG'C$, where G, G' are the centres of gravity of ACD, BCD; hence $M_2 = \frac{1}{3}ABC$, and $M = \frac{1}{3}ABC$.

(4) From this mean value we pass to probabilities. The chance that a new point Z falls on the triangle XYC is $\frac{1}{3}$; and the chance that three points X, Y, Z taken at random form, with a vertex C, a re-entrant quadrilateral, is $\frac{1}{3}$.

90. The calculation of geometrical probability and expectation is much facilitated by the following general principle: If M be a mean value depending on the positions of n points falling on a space A; and if this space receive a small increment a , and M' be the same mean when the n points are taken on A+a, and M the same mean when one point falls on a and the remaining $n-1$ on A; then, the sum of all the cases being $M'(A+a)^n$, and this sum consisting of the cases (1) when all the points are on A, (2) when one is on a the others on A (as we may neglect all where two or more fall on a), we have

$$M'(A+a)^n = MA^n + nM_1 a^{n-1};$$

$$\therefore (M' - M)A = nA(M_1 - M),$$

as M' nearly = M. For example, suppose two points X, Y are taken in a line of length l , to find the mean value M of $(XY)^n$. If l receives an increment dl , $ldM = 2dl(M_1 - M)$. Now M_1 here = the mean n th power of the distance of a single point taken at random in l from one extremity of l ; and this is $l^n(n+1)^{-1}$ (as is shown by finding the chance of n other points falling on that distance); hence

$$ldM = 2dl\{l^n(n+1)^{-1} - M\};$$

$$\therefore ldM + 2Mdl = 2(n+1)^{-1}l^n dl,$$

$$l^{-1}.d.Ml^n = 2(n+1)^{-1}l^n dl;$$

$$\therefore Ml^n = 2(n+1)^{-1}l^{n+1} dl = 2l^{n+2}/(n+1)(n+2) + C;$$

$$\therefore N = 2l^n/(n+1)(n+2),$$

C being evidently 0.

91. The corresponding principle for probabilities may thus be stated: If p is the probability of a certain condition being satisfied by the n points within A in art. 90, p' the same probability when they fall on the space A+a, and p'' the same when one point falls on a and the rest on A, then, since the numbers of favourable cases are respectively $p'(A+a)^n, pA^n, np_1 a A^{n-1}$, we find

$$(p' - p)A = na(p' - p).$$

Hence if $p' = p$ then $p_1 = p$. For example, if we have to find the chance of three points within a circle forming an acute-angled triangle, by adding an infinitesimal concentric ring to the circle, we have evidently $p' = p$; hence the required chance is unaltered by assuming one of the three points taken on the circumference. Again, in finding the chance that four points within a triangle shall form a convex quadrilateral, if we add to the triangle a small band between the base and a line parallel to it, the chance is clearly unaltered. Therefore we may take one of the points at random on the base (fig. 8), the others X, Y, Z within the triangle. Now the four lines from the vertex B to the four points are as likely to occur in any specified order as any other. Hence it is an even chance that X, Y, Z fall on one of the triangles ABW, CBW, or that two fall on one of these triangles and the remaining one on the other. Hence the probability of a re-entrant quadrilateral is

$$\frac{1}{2}p_1 + \frac{1}{2}p_2,$$

where $p_1 = \text{prob. (WXYZ re-entrant), X, Y, Z in one triangle;}$
 $p_2 = \text{do., X in one triangle, Y in the other, Z in either.}$

But $p_1 = \frac{1}{3}$. Now to find p_2 ; the chance of Z falling within the triangle WXY is the mean area of WXY divided by ABC. Now by par. 89, for any particular position of W, $M(WXY) = WGG'$, where G, G' are the centres of gravity of ABW, CBW. It is easy to see that $WGG' = \frac{1}{3}ABC = \frac{1}{3}$, putting $ABC = 1$. Now if Z falls in CBW, the chance of WXYZ re-entrant is $2M(IYW)$, for Y is as likely to fall in WXZ as Z to fall in WXY; also if Z falls in ABW the chance of WXYZ re-entrant is $2M(IXW)$. Thus the whole chance is $p_2 = 2M(IYW + IXW) = \frac{1}{3}$. Hence the probability of a re-entrant quadrilateral is

$$\frac{1}{2} \cdot \frac{1}{3} + \frac{1}{2} \cdot \frac{1}{3} = \frac{1}{3}.$$

That of its being convex is $\frac{2}{3}$.

92. From this probability we may pass to the mean value of the area XYZ, if M be this mean, and A the given area, the chance of a fourth point falling on the triangle is M/A ; and the chance of a re-entrant quadrilateral is four times this, or $4M/A$. This chance has just been shown to be $\frac{1}{3}$; and accordingly $M = \frac{1}{12}A$.

93. The preceding problem is a particular case of a more general problem investigated by Sylvester. For another instance, let the given area A be a circle; within such three points are taken at random; and let M be the mean value of the triangle thus formed. Adding a concentric ring a , we have since $M' : M$ as the areas of the circles, $M' = M(A+a)/A$.

$$AMa/A = 3a(M_1 - M); \therefore M = \frac{1}{3}M_1,$$

where M_1 is the value of M when one of the points is on the circumference. Take O fixed; we have to find the mean value of OXY (fig. 9). Taking $(\rho, \theta)(\rho', \theta')$ as co-ordinates of X, Y,

$$M_1 = (\pi a^2)^{-2} \iint \rho d\rho d\theta \iint \rho' d\rho' d\theta' (OXY).$$

$$\therefore M_1 = (\pi^2 a^4)^{-1} \iiint \int \frac{1}{2} \rho \rho' \sin(\theta - \theta') \rho \rho' d\rho d\rho' d\theta d\theta'$$

$$= (\pi^2 a^4)^{-1} \cdot \frac{1}{2} \iint \int \frac{1}{2} r^2 r'^2 \sin(\theta - \theta') d\theta d\theta',$$

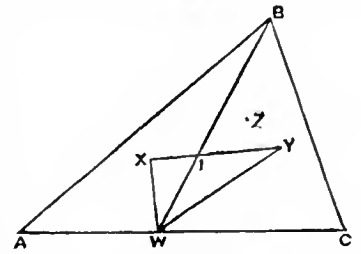

FIG. 8.

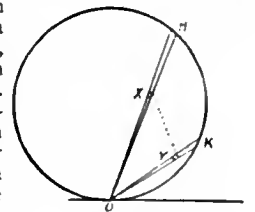

FIG. 9.

putting $r = OH, r' = OK$; as $r = 2a \sin \theta, r' = 2a \sin \theta'$,

$$M_1 = \frac{1}{\pi^2 a^4} \cdot \frac{(2a)^2}{9} \int_0^\pi \int_0^\theta \sin^2 \theta \sin^2 \theta' \sin(\theta - \theta') d\theta d\theta'$$

Professor Sylvester has remarked that this double integral, by means of the theorem

$$\int_0^a \int_0^x f(x, y) dx dy = \int_0^a \int_0^x f(a-y, a-x) dx dy,$$

is easily shown to be identical with

$$2 \int_0^\pi \int_0^\theta \sin^2 \theta \sin^2 \theta' \cos \theta' d\theta d\theta' = \frac{1}{2} \int_0^\pi \sin^2 \theta d\theta = \frac{1}{2} \cdot \frac{3}{2} \cdot \frac{5}{4} \cdot \frac{7}{8} \pi.$$

$$\therefore M_1 = \frac{35a^2}{36\pi}; \quad \therefore M = \frac{35}{48\pi^2} \pi a^2.$$

From this mean value we pass to the probability that four points within a circle shall form a re-entrant figure, viz.

$$p = \frac{35}{12\pi^2}.$$

94. The function of expectation in this class of problem appears to afford an additional justification of the position here assigned to this conception¹ as distinguished from an average in the more general sense which is proper to the following Part.

PART II.—AVERAGES AND LAWS OF ERROR

95. *Averages.*—An average may be defined as a quantity derived from a given set of quantities by a process such that, if the constituents become all equal, the average will coincide with the constituents, and the constituents not being equal, the average is greater than the least and less than the greatest of the constituents. For example, if x_1, x_2, \dots, x_n are the constituents, the following expressions form averages (called respectively the arithmetic, geometric and harmonic means):—

$$\frac{x_1 + x_2 + \dots + x_n}{n}$$

$$(x_1 \times x_2 \times \dots \times x_n)^{\frac{1}{n}}$$

$$1 / \left(\frac{1}{n} \left(\frac{1}{x_1} + \frac{1}{x_2} + \dots + \frac{1}{x_n} \right) \right)$$

The conditions of an average are likewise satisfied by innumerable other symmetrical functions, for example:—

$$\left(\frac{x_1^2 + x_2^2 + \dots + x_n^2}{n} \right)^{\frac{1}{2}}$$

The conception may be extended from symmetrical to unsymmetrical functions by supposing any one or more of the constituents in the former to be repeated several times. Thus if in the first of the averages above instanced (the arithmetic mean) the constituent x_r , occurs l times, the expression is to be modified by putting lx_r for x_r in the numerator, and in the denominator, for $n, n+l-1$. The definition of an average covers a still wider field. The process employed need not be a *function*.² One of the most important averages is formed by arranging the constituents in the order of magnitude and taking for the average a value which has as many constituents above it as below it, the median. The designation is also extended to that value about which the greatest number of the constituents cluster most closely, the “centre of greatest density,” or (with reference to the geometrical representation of the grouping of the constituents) the greatest ordinate, or, as recurring most frequently, the mode.³ But to comply with the definition there must be added the condition that the mode does not occur at either extremity of the range between the greatest and the least of the constituents. There should be also in general added a definition of the process by which the mode is derived from the given constituents.⁴ Perhaps this specification may be dispensed

¹ See introductory remarks and note to par. 95.

² A great variety of (functional) averages, including those which are best known, are comprehended in the following general form $\phi^{-1}\{M[\phi(x_1), \phi(x_2), \dots, \phi(x_n)]\}$; where ϕ is an arbitrary function, ϕ^{-1} is inverse (such that $\phi^{-1}(\phi(x)) \equiv x$), M is any (functional) mean. When M denotes the arithmetic mean; if $\phi(x) \equiv \log x$ ($\phi^{-1}(x) \equiv e^x$) we have the geometric mean; if $\phi(x) \equiv 1/x$, we have the harmonic mean. Of this whole class of averages it is true that the average of several averages is equal to the average of all their constituents.

³ This convenient term was introduced by Karl Pearson.

⁴ E.g. some specified method of *smoothing* the given statistics.

with when the number of the constituents is indefinitely large. For then it may be presumed that *any* method of determining the mode will lead to the same result. This presumption presupposes that the constituents are quantities of the kind which form the sort of “series” which is proper to Probabilities.⁵ A similar presupposition is to be made with respect to the constituents of the other averages, so far as they are objects of probabilities.

96. *The Law of Error.*—Of the propositions respecting average with which Probabilities is concerned the most important are those which deal with the relation of the average to its constituents, and are commonly called “laws of error.” Error is defined in popular dictionaries as “deviation from truth”; and since truth commonly lies in a mean, while measurements are some too large and some too small, the term in scientific diction is extended to deviations of statistics from their average, even when that average—like the mean of human or barometric heights—does not stand for any real objective thing. A “law of error” is a relation between the extent of a deviation and the frequency with which it occurs: for instance, the proposition that if a digit is taken at random from mathematical tables, the difference between that figure and the mean of the whole series (indefinitely prolonged) of figures so obtained, namely, 4.5, will in the long run prove to be equally often $\pm 0.5, \pm 1.5, \pm 2.5, \pm 3.5, \pm 4.5$.⁶ The assignment of frequency to *discrete* values—as 0, 1, 2, &c., in the preceding example—is often replaced by a continuous curve with a corresponding equation. The distinction of being *the* law of error is bestowed on a function which is applicable not merely to one sort of statistics—such as the digits above instanced—but to the great variety of miscellaneous groups, generally at least, if not universally. What form is most deserving of this distinction is not decided by uniform usage; different authorities do not attach the same weight to the different grounds on which the claim is based, namely the extent of cases to which the law may be applicable, the closeness of the application, and the presumption prior to specific experience in favour of the law. The term “the law of error” is here employed to denote (1) a species to which the title belongs by universal usage, (2) a wider class in favour of which there is the same sort of a priori presumption as that which is held to justify the more familiar species. The law of error thus understood forms the subject of the first section below.

97. *Laws of Frequency.*—What other laws of error may require notice are included in the wider genus “laws of frequency,” which forms the subject of the second section. Laws of frequency, so far as they belong to the domain of Probabilities, relate much to the same sort of grouped statistics as laws of error, but do not, like them, connote an explicit reference to an average. Thus the sequence of random digits above instanced as affording a law of error, considered without reference to the mean value, presents the law of frequency that one digit occurs as often as another (in the long run). Every law of error is a law of frequency; but the converse is not true. For example, it is a law of frequency—discovered by Professor Pareto⁷—that the number of incomes of different size (above a certain size) is approximately represented by the equation $y = A/x^2$, where x denotes the size of an income, y the number of incomes of that size. But whether this generalization can be construed as a law of error (in the sense here defined) depends on the nice inquiry whether the point from which the frequency diminishes as the income x increases can be regarded as a “mode,” y diminishing as x decreases from that point.

⁵ See above, pt. i., pars. 3 and 4. Accordingly the *expected* value of the sum of n (similar) constituents $(x_1 + x_2 + \dots + x_n)$ may be regarded as an average, the average value of nx , where x_r is any one of the constituents.

⁶ See as to the fact and the evidence for it, Venn, *Logic of Chance*, 3rd ed., pp. 111, 114. Cf. *Ency. Brit.*, 8th ed., art “Probability,” p. 592; Bertrand, *op. cit.*, preface § ii.; above, par. 59.

⁷ See his *Cours d'économie politique*, ii. 306. Cf. Bowley, Evidence before the Select Committee on Income Tax (1906, No. 365, Question 1163 seq.); Benini, *Metodologica statistica*, p. 324, referred to in the *Journ. Stat. Soc.* (March, 1909).

Section I.—The Law of Error.

98. (1) *The Normal Law of Error.*—The simplest and best recognized statement of the law of error, often called the "normal law," is the equation

$$z = \frac{1}{\sqrt{\pi}c} e^{-(x-a)^2/c^2}$$

more conveniently written $(1/\sqrt{\pi}c) \exp-(x-a)^2/c^2$, where x is the magnitude of an observation or "statistic," z is the proportional frequency of observations measuring x , a is the arithmetic mean of the group (supposed indefinitely multiplied) of similar statistics: c is a constant sometimes called the "modulus" proper to the group; and the equation signifies that if any large number N of such a group is taken at random, the number of observations between x and $x+\Delta x$ is (approximately) equal to the right-hand side of the equation multiplied by $N\Delta x$. A graphical representation of the corresponding curve—sometimes called the "probability-curve"—is here given (fig. 10), showing the general shape of the curve, and how its dimensions vary with the magnitude of the modulus c . The area being constant (viz. unity), the curve is furled up when c is small, spread out when c is large. There is added a table of integrals, corresponding to areas subtended by the curve; in a form suited for calculations of probability, the variable, τ , being the length of the abscissa referred to (divided by) the modulus.³ It may be noted that the points of inflexion in the figure are each at a distance from the origin of $1/\sqrt{2}$ modulus, a distance equal to the square root of the mean square of error—often called the "standard deviation." Another notable value of the abscissa is that which divides the area on either side of the origin into two equal parts; commonly called the "probable error." The value of τ which corresponds to this point is 0.4769. . . .

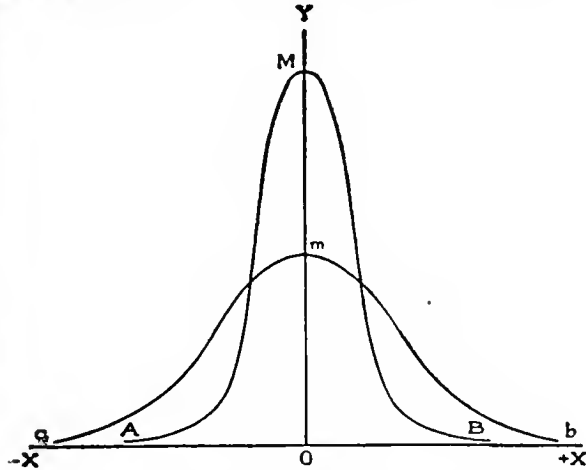

FIG. 10.

99. An a priori proof of this law was given by Herschel⁴ as follows: "The probability of an error depends solely on its magnitude and not on its direction;" positive and negative errors are equally probable. "Suppose a ball dropped from a given height with the intention that it should fall on a given mark," errors in all directions are equally probable, and errors in perpendicular directions are independent. Accordingly the required law, "which must necessarily be general and apply alike in all cases, since the causes of error are supposed alike unknown,"⁵ is for one dimension of the form $\phi(x^2)$, for two dimen-

¹ On this conception see below, par. 122.
² E.g. in the article on "Probability" in the 9th ed. of the *Ency. Brit.*; also by Airy and other authorities. Bravais, in his article *Sur la probabilité des erreurs*. . . . "Mémoires présentés par divers savants" (1846), p. 257, takes as the "modulus or parameter" the inverse square of our c . Doubtless different parameters are suited to different purposes and contexts; c when we consult the common tables, and in connexion with the operator, as below, par. 160; $k (= \frac{1}{2}c^2)$ when we investigate the formation of the probability-curve out of independent elements (below, par. 104); $h (= 1/c^2)$ when we are concerned with weights or precisions (below, par. 134). If one form of the coefficient must be uniformly adhered to, probably, $\sigma (= c/\sqrt{2})$, for which Professor Pearson expresses a preference, appears the best. It is called by him the "standard deviation."

³ Fuller tables are to be found in many accessible treatises. Burgess's tables in the *Trans. of the Edin. Roy. Soc.* for 1900 are carried to a high degree of accuracy. Thorndike, in his *Mental and Social Measurements*, gives, among other useful tables, one referred to the standard deviation as the argument. New tables of the probability integral are given by W. F. Sheppard, *Biometrics*, ii. 174 seq.

⁴ *Edinburgh Review* (1850), xcii. 19.

⁵ The italics are in the original. The passage continues: "And

sions $\phi(x^2 + y^2)$; and $\phi(x^2 + y^2) \equiv \phi(x^2) \times \phi(y^2)$; a functional equation of which the solution is the function above written. A reason which satisfied Herschel is entitled to attention, especially if it is endorsed by Thomson and Tait.⁶ But it must be confessed that the claim to universality is not, without some strain of interpretation,⁷ to be reconciled with common experience.

Table of the Values of the Integral $I = \frac{2}{\sqrt{\pi}} \int_0^\tau e^{-x^2} dx$.

τ	I	τ	I	τ	I	τ	I
0.00	0.00000	2	.22270	1.3	.93401	2.4	.99931
.01	.01128	3	.32863	1.4	.95229	2.5	.99959
.02	.02256	4	.42839	1.5	.96611	2.6	.99976
.03	.03384	5	.52050	1.6	.97635	2.7	.99986
.04	.04511	6	.60386	1.7	.98379	2.8	.99992
.05	.05637	7	.67780	1.8	.98909	2.9	.99996
.06	.06762	8	.74210	1.9	.99279	3.0	.99998
.07	.07886	9	.79691	2.0	.99532	∞	1.00000
.08	.09008	1.0	.84270	2.1	.99702		
.09	.10128	1.1	.88020	2.2	.99814		
.1	.11246	1.2	.91031	2.3	.99886		

100. There is, however, one class of phenomena to which Herschel's reasoning applies without reservation. In a "molecular chaos," such as the received kinetic theory of gases postulates, if a molecule be placed at rest at a given point and the distance which it travels from that point in a given time, driven hither and thither by colliding molecules, is regarded as an "error," it may be presumed that errors in all directions are equally probable and errors in perpendicular directions are independent. It is remarkable that a similar presumption with respect to the velocities of the molecules was employed by Clerk Maxwell, in his first approach to the theory of molecular motion, to establish the law of error in that region.

101. *The Laplace-Quetelet Hypothesis.*—That presumption has, indeed, not received general assent; and the law of error appears to be better rested on a proof which was originated by Laplace. According to this view, the normal law of error is a first approximation to the frequency with which different values are apt to be assumed by a variable magnitude dependent on a great number of independent variables, each of which assumes different values in random fashion over a limited range, according to a law of error, not in general the law, nor in general the same for each variable. The normal law prevails in nature because it often happens—in the world of atoms, in organic and in social life—that things depend on a number of independent agencies. Laplace, indeed, appears to have applied the mathematical principle on which this explanation depends only to examples (of the law of error) artificially generated by the process of taking averages. The merit of accounting for the prevalence of the law in *rerum natura* belongs rather to Quetelet. He, however, employed too simple a formula⁸ for the action of the causes. The hypothesis seems first to have been stated in all its generality both of mathematical theory and statistical exemplification by Glaisher.⁹

102. The validity of the explanation may best be tested by first (A) deducing the law of error from the condition of numerous independent causes; and (B) showing that the law is adequately fulfilled in a variety of concrete cases, in which the condition is probably present. The condition may be supposed to be perfectly fulfilled in *games of chance*, or, more generally, *sortitions*, characterized by the circumstance that we have a knowledge prior to specific experience of the proportion of what Laplace calls favourable cases¹⁰ to all cases—a category which includes, for instance, the distribution of digits obtained by random extracts from mathematical tables, as well as the distribution of the numbers of points on dominoes.

103. The genesis of the law of error is most clearly illustrated by the simplest sort of "game," that in which the sortition is between two alternatives, heads or tails, hearts or not-hearts, or, generally, success or failure, the probability of a success being p and that of a failure q , where $p + q = 1$. The number of such successes in the course of n trials may be considered as an aggregate made up of n independently varying elements, each of which assumes the values 0 or 1 with respective frequency q and p . The frequency of each value of the

(A) Deduction from Hypothetical Conditions.

Games of Chance.

it is on this ignorance, and not on any peculiarity in cases, that the idea of probability in the abstract is formed." Cf. above, par. 6.

⁶ *Natural Philosophy*, pt. i. art. 391. For other a priori proofs see Czuber, *Theorie der Beobachtungsfehler*, th. i.

⁷ Cf. note to par. 127.

⁸ He considered the effect as the sum of causes each of which obeys the simplest law of frequency, the symmetrical binomial.

⁹ *Memoirs of Astronomical Society* (1878), p. 105. Cf. Morgan Crofton, "On the Law of Errors of Observation," *Trans. Roy. Soc.* (1870), vol. clx. pt. i. p. 178.

¹⁰ Above, par. 2.

aggregate is given by a corresponding term in the expansion of $(q+p)$, and by a well-known theorem¹ this term is approximately equal to $\frac{1}{\sqrt{2\pi npq}}$; where ν is the number of integers by which the term is distant from np (or an integer close to np); provided that ν is of (or $<$) the order \sqrt{n} . Graphically, let the sortition made for each element be represented by the taking or not taking with respective frequency p and q a step of length i . If a body starting from zero takes successively n such steps, the point at which it will most probably come to a stop is at npi (measured from zero); the probability of its stopping at any neighbouring point within a range of $\pm \sqrt{ni}$ is given by the above-written law of frequency, ν being the distance of the stopping-point from npi . Put $\nu = x$ and $2npqi^2 = c^2$; then the probability may be written $(1/\sqrt{\pi c}) \exp -x^2/c^2$.

104. It is a short step, but a difficult one, from this case, in which the element is *binomial*—heads or tails—to the general case, in which the element has several values, according to the law of frequency—consists, for instance, of the number of points presented by a randomly-thrown die. According to the general theorem, if Q is the sum² of numerous elements, each of which assumes different magnitudes according to a law of frequency, $z = f(x)$, the function f being in general different for different elements, the number of times that Q assumes magnitudes between x and $x + \Delta x$ in the course of N trials is $Nz\Delta x$, if $z = (1/\sqrt{2\pi k}) \exp - (x-a)^2/2k$; where a is the sum of the arithmetic means of all the elements, any one of which $a_r = \int x f_r(x) dx$, the square brackets denoting that the integrations extend between the extreme limits of the element's range, if the frequency-locus for each element is continuous, it being understood that $\int f_r(x) dx = 1$; and k is the sum of the mean squares of error for each element, $= \sum \int x^2 f_r(x) dx$, if the frequency-locus for each element is continuous, where a_r is the arithmetic mean of one of the elements, and ξ the deviation of any value assumed by that element from a_r , Σ denoting summation over all the elements. When the frequency-locus for the element is not continuous, the *integrations* which give the arithmetic mean and mean square of error for the element must be replaced by *summations*. For example, in the case of the dice above instanced, the law of frequency for each element is that it assumes equally often each of the values 1, 2, 3, 4, 5, 6. Thus the arithmetic mean for each element is 3.5, and the mean square of error $\{(3.5 - 1)^2 + (3.5 - 2)^2 + \dots\}/6 = 2.916$. Accordingly, the sum of the points obtained by tossing a large number, n , of dice at random will assume a particular value x with a frequency which is approximately assigned by the equation

$$z = (1/\sqrt{\pi 5.83n}) \exp - (x - 3.5)^2/5.83n.$$

The rule equally applies to the case in which the elements are not similar; one might be the number of points on a die, another the number of points on a domino, and so [on. Graphically, each element is no longer represented by a step which is either null or i , but by a step which may be, with an assigned probability, one or other of several degrees between those limits, the law of frequency and the range of i being different for the different elements.

105. *Variation Proofs.*—The evidence of these statements can only be indicated here. All the proofs which have been offered involve some postulate as to the deviation of the elements from their respective centres of gravity, their "errors." If these errors extended to infinity, it might well happen that the law of error would not be fulfilled by a sum of such elements.³ The necessary and sufficient postulate appears to be that the mean powers of deviation for the elements, the second (above written) and the similarly formed third, fourth, &c., powers (up to some assigned power), should be finite.⁴

106. (1) The proof which seems to flow most directly from this postulate proceeds thus. It is deduced that the mean powers of deviation for the proposed representative curve, the law of error (up to a certain power), differ from the corresponding powers of the actual locus by quantities which are negligible when the number of the elements is large.⁵ But loci which have their mean powers of deviation (up to some certain power) approximately equal may be considered as approximately coincident.⁶

107. (2) The earliest and best-known proof is that which was

¹ By the use of Stirling's and Bernoulli's theorems, Todhunter, *History . . . of Probability*.

² The statement includes the case of a linear function, since an element multiplied by a constant is still an element.

³ E.g. if the frequency-locus of each element were $1/\pi(1+x^2)$, extending to infinity in both directions. But extension to infinity would not be fatal, if the form of the element's locus were *normal*.

⁴ For a fuller exposition and a justification of many of the statements which follow, see the writer's paper on "The Law of Error" in the *Camb. Phil. Trans.* (1905).

⁵ *Loc. cit.* pt. i. § 1.

⁶ On this criterion of coincidence see Karl Pearson's paper "On the Systematic Fitting of Curves," *Biometrika*, vols. i. and ii.

originated by Laplace and generalized by Poisson.⁷ Some idea of this celebrated theory may be obtained from the following free version, applied to a simple case. The case is that in which all the elements have one and the same locus of frequency, and that locus is symmetrical about the centre of gravity. Let the locus be represented by the equation $\eta = \phi(\xi)$, where the centre of gravity is the origin, and $\phi(+\xi) = \phi(-\xi)$; the construction signifying that the probability of the element having a value ξ (between say $\xi - \frac{1}{2}\Delta\xi$ and $\xi + \frac{1}{2}\Delta\xi$) is $\phi(\xi)\Delta\xi$. Square brackets denoting summation between extreme limits, put $\chi(a)$ for $[\text{S}\phi(\xi)e^{\nu - \nu a \xi} \Delta\xi]$ where ξ is an integer multiple of $\Delta\xi$ (or $\Delta x = \rho\Delta\xi$, say). Form the m th power of $\chi(a)$.

The coefficient of $e^{\nu - \nu a \xi}$ in $(\chi(a))^m$ is the probability that the sum of the values of the m elements should be equal to $\nu a \Delta x$; a probability which is equal to $\Delta x y$, where y is the ordinate of the locus representing the frequency of the compound quantity (formed by the sum of the elements). Owing to the symmetry of the function ϕ the value of y , will not be altered if we substitute for $e^{\nu - \nu a \Delta x}$, $e^{-\nu - \nu a \Delta x}$, nor if we substitute $\frac{1}{2}(e^{\nu - \nu a \Delta x} + e^{-\nu - \nu a \Delta x})$, that is $\cos a \Delta x$. Thus $(\chi(a))^m$ becomes a sum of terms of the form $\Delta x y$, $\cos a \Delta x$, where $y_r = y_{-r}$. Now multiply $(\chi(a))^m$ thus expressed by $\cos i \Delta x a$, where, i being an integer, $i \Delta x = x$, the abscissa of the "error" the probability of whose occurrence is to be determined. The product will consist of a sum of terms of the form $\Delta x y$, $\frac{1}{2}(\cos a(r+i)\Delta x + \cos a(r-i)\Delta x)$. As every value of $r-i$ (except zero) is matched by a value [equal in absolute magnitude, $-r+i$, and likewise every value of $r+i$ is matched by value $-r-i$, the series takes the form $\Delta x y \Sigma \cos q a \Delta x + \Delta x y$, where q has all possible integer values from 1 to the largest value of $|r-i|$ increased by $|i|$; and the term free from circular functions is the equivalent of $\Delta x y$, $\cos a(r+i)\Delta x$, when $r = -i$, together with $\Delta x y$, $\cos a(r-i)\Delta x$, when $r = +i$. Now substitute for $a \Delta x$ a new symbol β ; and integrate with respect to β , the thus transformed $(\chi(a))^m \cos i \Delta x a$ between the limits $\beta = 0$ and $\beta = \pi$. The integrals of all the terms which are of the form $\Delta x y \cos q \beta$ will vanish, and there will be left surviving only $\pi \Delta x y$.

We thus obtain, as equal to $\pi \Delta x y$, $\int_0^\pi \{\chi(\beta/\Delta x)\}^m \cos i \beta d\beta$. Now change the independent variable to a ; then as $d\beta = da \Delta x$,

$$\Delta x y_i = \Delta x \int_0^{\pi/\Delta x} da (\chi(a))^m \cos i \Delta x a.$$

Replacing $i \Delta x$ by x , and dividing both sides by Δx , we have

$$y_x = \int_0^{\pi/\Delta x} da (\chi(a))^m \cos ax.$$

Now expanding the $\cos ax$ which enters into the expression for $\chi(a)$, we obtain

$$\chi(a) = [\text{S}\phi(a)] - \frac{1}{2!} [\text{S}\phi(a)a^2]x^2 + \frac{1}{4!} [\text{S}\phi(a)a^4]x^4 \dots$$

Performing the summations indicated, we express $\chi(a)$ in terms of the mean powers of deviation for an element. Whence $\chi(a)^m$ is expressible in terms of the mean powers of the compound locus. First and chief is the mean second power of deviation for the compound, which is the sum of the mean second powers of deviation for the elements, say k . It is found that the sought probability may be equated to

$$\int_0^{\pi/\Delta x} dx e^{-\frac{1}{2}a^2 k} \cos ax + \frac{1}{4!} k_2 \int_0^{\pi/\Delta x} dx a^4 e^{-\frac{1}{2}a^2 k} \cos ax - \dots,$$

where k_2 is the coefficient defined below.⁹ Here $\pi/\Delta x$ may be replaced by ∞ , since the finite difference Δx is small with respect to unity when the number of the elements is large;¹⁰ and thus the integrals involved become equateable to known definite integrals. If it were allowable to neglect all the terms of the series but the first the

expression would reduce to $\frac{1}{\sqrt{2\pi k}} e^{-x^2/k}$, the normal law of error.

But it is allowable to neglect the terms after the first, in a first approximation, for values of x not exceeding a certain range, the number of the elements being large, and if the postulate above enunciated is satisfied.¹¹ With these reservations it is proved that the sum of a number of similar and symmetrical elements conforms to the normal law of error. The proof is by parity extended to the case in which the elements have different but still symmetrical frequency functions; and, by a bolder use of imaginary quantities, to the case of unsymmetrical functions.

⁷ Laplace, *Théorie analytique des probabilités*, bk. ii. ch. iv.; Poisson, *Recherches sur la probabilité des jugements*. Good restatements of this proof are given by Todhunter, *History . . . of Probability* art. 1004, and by Czuber, *Theorie der Beobachtungsfehler*, art. 38 and Th. 2, § 4.

⁸ The symbol $||$ is used to denote absolute magnitude, abstraction being made of *sign*.

⁹ Below, pars. 159, 160.

¹⁰ *Loc. cit.* app. I.

¹¹ *Loc. cit.* p. 53 and context.

108. (3) De Forest¹ has given a proof unencumbered by imaginaries of what is the fundamental proposition in Laplace's theory that, if a polynomial of the form

$$A_0 + A_1z + A_2z^2 + \dots + A_mz^m$$

be raised to the n th power and expanded in the form

$$B_0 + B_1z + B_2z^2 + \dots + B_mz^m,$$

then the magnitudes of the B 's in the neighbourhood of their maximum (say B_1) will be disposed in accordance with a "probability-curve," or normal law of error.

109. (4) Professor Morgan Crofton's original proof of the law of error is based on a datum obtained by observing the effect which the introduction of a new element produces on the frequency-locus for the aggregate of elements. It seems to be assumed, very properly, that the sought function involves as constants some at least of the mean powers of the aggregate, in particular the mean second power, say k . We may without loss of generality refer each of the elements (and accordingly the aggregate) to its respective centre of gravity. Then if $y = f(x)$, is the ordinate of the frequency-locus for the aggregate before taking in a new element, and $y = \partial y$ the ordinate after that operation, by a well-known principle,² $y + \partial y = [S\phi_m(\xi)f(x - \xi)\Delta\xi]$, where $\eta = \phi_m(\xi)$, is the frequency-locus for the new element, and the square brackets indicate that the summation is to extend over the whole range of values assumed by that element. Expanding in ascending powers of (each value of) ξ and neglecting powers above the second, as is found to be legitimate under the conditions specified, we have (since the first mean power of the element vanishes)

$$\partial y = \frac{1}{2} [S\xi^2\phi_m(\xi)\Delta\xi] \frac{d^2f}{dx^2}$$

From the fundamental proposition that the mean square for the aggregate equals the sum of mean squares for the elements it follows that $[S\xi^2\phi_m(\xi)\Delta\xi]$ the mean second power of deviation for the m th element is equal to ∂k , the addition to k the mean second power of deviation for the aggregate. There is thus obtained a partial differential equation of the second order

$$\frac{dy}{dk} = \frac{1}{2} \frac{d^2y}{dk^2} \tag{1}$$

A subsidiary equation is (in effect) obtained by Professor Crofton from the property that if the unit according to which the axis of x is graduated is altered in any assigned ratio, there must be a corresponding alteration both of the ordinate expressing the frequency: of the aggregate and of the mean square of deviation for the aggregation. By supposing the alteration indefinitely small he obtains a second partial differential equation, viz. (in the notation here adopted)

$$y + x \frac{dy}{dx} + 2k \frac{dy}{dk} = 0. \tag{2}$$

From these two equations, regard being had to certain other conditions of the problem,³ it is deducible that $y = Ce^{-x^2/2k}$, where C is a constant of which the value is determined by the condition that

$$\int_{-\infty}^{\infty} y dx = 1.$$

110. (5) The condition on which Professor Crofton's proof is based may be called differential, as obtained from the introduction of a single new element. There is also an integral condition obtained from the introduction of a whole set of new elements. For let A be the sum of m_1 elements, fluctuating according to the sought law of error. Let B be the sum of another set of elements m_2 in number (m_1 and m_2 both large). Then Q a quantity formed by adding together each pair of concurrent values presented by A and B must also conform to the law of error, since Q is the sum of $m_1 + m_2$ elements. The general form which satisfies this condition of *reproductivity* is limited by other conditions to the normal law of error.⁴

111. The list of variant proofs is not yet exhausted,⁵ but enough has been said to establish the proposition that a sum of numerous elements of the kind described will fluctuate approximately according to the normal law of error.

112. As the number of elements is increased, the constant above designated k continually increases; so that the curve representing the frequency of the compound magnitude spreads out from its centre. It is otherwise if instead of the simple sum we consider the linear function formed by adding the m elements each multiplied by $1/m$. The "spread" of the average thus constituted will continually diminish as the number of the elements is increased; the sides closing in as the

Varieties of Linear Function.

vertex rises up. The change in "spread" produced by the accession of new elements is illustrated by the transition from the high to the low curve, in fig. 10, in the case of a *sum*; in the case of an *average* (arithmetic mean) by the reverse relation.

113. The proposition which has been proved for linear functions may be extended to any other function of numerous variables, each representing the value assumed by an independently fluctuating element; if the function may be expanded in ascending powers of the variables, according to Taylor's theorem, and all the powers after the first may be neglected. The matter is not so simple as it is often represented, when the variable elements may assume large, perhaps infinite, values; but with the aid of the postulate above enunciated the difficulty can be overcome.⁶

Extension to Non-linear Functions.

114. All the proofs which have been noticed have been extended to errors in two (or more) dimensions.⁷ Let Q be the sum of a number of elements, each of which, being a function of two variables, x and y , assumes different pairs of values according to a law of frequency $z = f(x, y)$, the functions being in general different for different elements. The frequency with which Q assumes values of the variables between x and $x + \Delta x$ and between y and $y + \Delta y$ is $z \Delta x \Delta y$, if

Extension to two or more Dimensions.

$$z = \frac{1}{2\pi\sqrt{km - l^2}} \exp - \frac{m(x-a)^2 - 2l(x-a)(y-b) + k(y-b)^2}{2(km - l^2)}$$

where, as in the simpler case, $a = \Sigma a$, a , being the arithmetic mean of the values of x assumed in the long run by one of the elements, b is the corresponding sum for values of y , and

$$k = \Sigma \left[\iint (x - a)^2 f_r(x, y) dx dy \right]$$

$$m = \Sigma \left[\iint (y - b)^2 f_r(x, y) dx dy \right]$$

$$l = \Sigma \left[\iint (x - a)(y - b) f_r(x, y) dx dy \right];$$

the summation extending over all the elements, and the integration between the extreme limits of each; supposing that the law of frequency for each element is continuous, otherwise summation is to be substituted for integration. For example, let each element be constituted as follows: Three coins having been tossed, the number of heads presented by the first and second coins together is put for x , the number of heads presented by the second and third coins together is put for y . The law of frequency for the element is represented in fig. 11, the integers outside denoting the values of x or y , the fractions inside probabilities of particular values of x and y concurring.

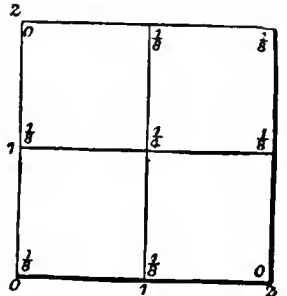

FIG. 11.

If i is the distance from 0 to 1 and from 1 to 2 on the abscissa, and i' the corresponding distance on the ordinate, the mean of the values of x for the element— Δa , as we may say,—is i , and the corresponding mean square of horizontal deviations is $\frac{1}{2}i^2$. Likewise $\Delta b = i'$; $\Delta m = \frac{1}{2}i'^2$; and $\Delta l = \frac{1}{2}(+i \times +i' - i \times -i') = \frac{1}{2}ii'$. Accordingly, if n such elements are put together (if n steps of the kind which the diagram represents are taken), the frequency with which a particular pair of aggregates x and y will concur, with which a particular point on the plane of xy , namely, $x = ri$ and $y = ri'$, will be reached, is given by the equation

$$z = \frac{1}{2\pi\sqrt{3^n}} \exp - \frac{8}{3^n} \left[(r-n)^2i^2 - (r-n)(r'-n)ii' + (r'-n)^2i'^2 \right].$$

115. A verification is afforded by a set of statistics obtained with dice by Weldon, and here reproduced by his permission. A *success* is in this experiment defined, not by obtaining a head when a coin is tossed, but by obtaining a face with more than three points on it when a die is tossed; the probabilities of the two events are the same, or rather would be if coins and dice were perfectly symmetrical.⁸ Professor Weldon virtually took six steps of the sort above described when, six painted dice having been thrown, he added the number of successes in that painted batch to the number of successes in another batch of six to form his x , and to the number of successes in a third batch of six to form his y . The result is represented in the annexed table, where each degree on the axis of x and y respectively corresponds to the i and i' of the preceding paragraphs, and $i = i'$. The observed frequencies being represented by numerals, a general correspondence between the facts and the formula is apparent.

¹ *Loc. cit.* pt. ii. § 7.

² The second by Burbury, in *Phil. Mag.* (1894), xxxvii. 145; the third by its author in the *Analyst* for 1881; and the remainder by the present writer in *Phil. Mag.* (1896), xii. 247; and *Camb. Phil. Trans.* (1905), *loc. cit.*

³ Compare the formula for the simple case above, § 4.

⁴ On the irregularity of the dice with which Weldon experimented, see Pearson, *Phil. Mag.* (1900), p. 167.

¹ The *Analyst* (Iowa), vols. v., vi., vii. *passim*; and especially vi. 142 seq., vii. 172 seq.

² Morgan Crofton, *loc. cit.* p. 781, col. a. The principle has been used by the present writer in the *Phil. Mag.* (1883), xvi. 301.

³ For a criticism and extension of Crofton's proof see the already cited paper on "The Law of Error," *Camb. Phil. Trans.* (1905), pt. i. § 2. Space does not permit the reproduction of Crofton's proof as given in the 9th ed. of the *Ency. Brit.* (art. "Probability," § 48).

⁴ *Loc. cit.* pt. 1. § 4; and app. 6.

⁵ *Loc. cit.* p. 122 seq.

The maximum frequency is, as it ought to be, at the point $x=6i$, $y=6i'$. The density is particularly great along a line through that point, making 45° with the axis of x ; particularly small in the complementary direction. This also is as it ought to be. For if the centre is made the origin by substituting x for $(x-a)$ and y for $(y-b)$, and then new co-ordinates X and Y are taken, making an angle θ with x and y respectively, the curve which is traced on the plane of zX by its intersection with the surface is of the form

$$z = J \exp -X^2 [k \sin^2 \theta - 2l \cos \theta \sin \theta + m \cos^2 \theta] / 2(km - l^2),$$

a probability-curve which will be more or less spread out according as the factor $k \sin^2 \theta - 2l \cos \theta \sin \theta + m \cos^2 \theta$ is less or greater. Now this expression has a minimum or maximum when $(k-m) \sin \theta - 2l \cos \theta = 0$; a minimum when $(k-m) \cos 2\theta + 2l \sin 2\theta$ is positive, and a maximum when that criterion is negative; that is, in the present case, where $k=m$, a minimum when $\theta = \frac{1}{2}\pi$ and a maximum when $\theta = \frac{1}{4}\pi$.

	0	1	2	3	4	5	6	7	8	9	10	11	12
12													
11							1	1	5	1		1	
10						2	6	28	27	19	2		
9				1	2	11	43	76	57	54	15	4	
8				6	18	49	116	138	118	59	25	5	
7				12	47	109	208	213	118	71	23	1	
6				9	29	77	199	244	198	121	32	3	
5		3	12	51	119	181	200	129	69	18	3		
4		2	16	55	100	117	91	46	19	3			
3		2	14	28	53	43	34	17	1				
2			7	12	13	18	4	1	1				
1			2	4	1	2	1						
0													

116. *Characteristics of the Law of Error.*¹—As may be presumed from the examples just given, in order that there should be some approximation to the normal law the number of elements need not be very great. A very tolerable imitation of the probability-curve has been obtained by superposing *three* elements, each obeying a law of frequency quite different from the normal one,² namely, that simple law according to which one value of a variable occurs as frequently as another between the limits within which the variation is confined ($y=1/2a$, between limits $x=+a$, $x=-a$). If the component elements obey unsymmetrical laws of frequency, the compound will indeed be to some extent unsymmetrical, unlike the "normal" probability-curve. But, as the number of the elements is increased, the portion of the compound curve in the neighbourhood of its centre of gravity tends to be rounded off into the normal shape. The portion of the compound curve which is sensibly identical with a curve of the "normal" family becomes greater the greater the number of independent elements; *caeteris paribus*, and granted certain conditions as to the equality and the range of the elements. It will readily be granted that if one component predominates, it may unduly impress its own character on the compound. But it should be pointed out that the characteristic with which we are now concerned is not average magnitude, but deviation from the average. The component elements may be very unequal in their contributions to the average magnitude of the compound without prejudice to its "normal" character, provided that the fluctuation of all or many of the elements is of one and the same order. The proof of the law requires that the contribution made by each element to the mean square of deviation for the compound, k , should be small, capable of being treated as differential with respect to k . It is not necessary that all these small quantities should be of the same order, but only that they should admit of being rearranged, by massing together those of a smaller order, as a numerous set of

independent elements in which no two or three stand out as *sui generis* in respect of the magnitude of their fluctuation. For example, if one element consist of the number of points on a domino (the sum of two digits taken at random), and other elements, each of either 1 or 0 according as heads or tails turn up when a coin is cast, the first element, having a mean square of deviation 16.5, will not be of the same order as the others, each having 0.25 for its mean square of deviation. But *sixty-six* of the latter taken together would constitute an independent element of the same order as the first one; and accordingly if there are several times sixty-six elements of the latter sort, along with one or two of the former sort, the conditions for the generation of the normal distribution will be satisfied. These propositions would evidently be unaffected by altering the average magnitude, without altering the deviation from the average, for any element, that is, by adding a greater or less *fixed* magnitude to each element. The propositions are adapted to the case in which the elements fluctuate according to a law of frequency other than the normal. For if they are already normal, the aforesaid conditions are unnecessary. The normal law will be obeyed by the sum of elements which each obey it, even though they are not numerous and not independent and not of the same order in respect of the extent of fluctuation. A similar distinction is to be drawn with respect to some further conditions which the reasoning requires. A limitation as to the range of the elements is not necessary when they are already normal, or even have a certain affinity to the normal curve. Very large values of the element are not excluded, provided they are sufficiently rare. What has been said of curves with special reference to one dimension is of course to be extended to the case of surfaces and many dimensions. In all cases the theorem that under the conditions stated the normal law of error will be generated is to be distinguished from the hypothesis that the conditions are fairly well fulfilled in ordinary experience.

117. Having deduced the genesis of the law of error from ideal conditions such as are attributed to perfectly fair (B) *Verification of the Normal Law.* games of chance, we have next to inquire how far these conditions are realized and the law fulfilled in common experience.

118. Among important concrete cases errors of observation occupy a leading place. The theory is brought to bear on this case by the hypothesis that an error is the algebraic sum of numerous elements, each varying according to a law of frequency special to itself. This hypothesis involves *Errors proper.* two assumptions: (1) that an error is dependent on numerous independent causes; (2) that the function expressing that dependence can be treated as a linear function, by expanding in terms of ascending powers (of the elements) according to Taylor's theorem and neglecting higher powers, or otherwise. The first assumption seems, in Dr Glaisher's words, "most natural and true. In any observation where great care is taken, so that no large error can occur, we can see that its accuracy is influenced by a great number of circumstances which ultimately depend on independent causes: the state of the observer's eye and his physiological condition in general, the state of the atmosphere, of the different parts of the instrument, &c., evidently depend on a great number of causes, while each contributes to the actual error."³ The second assumption seems to be frequently realized in nature. But the assumption is not always safe. For example, where the velocities of molecules are distributed according to the normal law of error, with zero as centre, the *energies* must be distributed according to a quite different law. This rationale is applicable not only to the fallible perceptions of the senses, but also to impressions into which a large ingredient of inference enters, such as estimates of a man's height or weight from his appearance,⁴ and even higher acts of judgment.⁵ Aiming at an object is an act similar to measuring an object, misses are produced by much the same variety of causes as mistakes; and, accordingly, it is found that shots aimed at the same bull's-eye are apt to be distributed according to the normal law, whether in two dimensions on a target or according to their horizontal deviations, as exhibited below (par. 156). A residual class comprises miscellaneous statistics, physical as well as social, in which the normal law of error makes its appearance, presumably in consequence of the action of numerous independent influences. Well-known *Miscellaneous Statistics.* instances are afforded by human heights and other bodily measurements, as tabulated by Quetelet⁶ and others.⁷ Professor Pearson has found that "the normal curve suffices to describe within the limits of random sampling the distribution of the chief characters in man."⁸ The tendency of social phenomena to conform to the normal law of frequency is well

¹ Experiments *in pari materia* performed by A. D. Darbishire afford additional illustrations. See "Some Tables for illustrating Statistical Correlation," *Mem. and Proc. Man. Lit., and Phil. Soc.*, vol. li. pt. iii.

² *Journ. Stat. Soc.* (March 1900), p. 73, referring to Burton, *Phil. Mag.* (1883), xvi. 301.

³ *Memoirs of Astronomical Society* (1878), p. 105.

⁴ *Journ. Stat. Soc.* (1890), p. 462 seq.

⁵ E.g. the marking of the same work by different examiners. *Ibid.*

⁶ *Lettres sur la théorie des probabilités et Physique sociale.*

⁷ E.g. the measurements of Italian recruits, adduced in the *Atlante statistico*, published under the direction of the Ministero de Agricoltura (Rome, 1882); and Weldon's measurements of crabs, *Proc. Roy. Soc. liv.* 321; discussed by Pearson in the *Trans. Roy. Soc.* (1894), vol. clxxxv. A.

⁸ *Biometrika*, iii. 395. Cf. *ibid.* p. 141.

exemplified by A. L. Bowley's grouping of the wages paid to different classes.¹

119. The division of concrete errors which has been proposed is not to be confounded with another twofold classification, namely, observations which stand for a real objective thing, and such statistics as are not thus representative of something outside themselves, groups of which the mean is called "subjective." This division would be neither clear nor useful. On the one hand so-called real means are often only approximately equal to objective quantities. Thus the proportional frequency with which one face of a die—the six suppose—turns up is only approximately given by the objective fact that the six is one face of a nearly perfect cube. For a set of dice with which Weldon experimented, the average frequency of a throw, presenting either five or six points, proved to be not .3, but 0.3377.² The difference of this result from the regulation 0.3 is as unpredictable from objective data, prior to experiment, as any of the means called subjective or fictitious. So the mean of errors of observation often differs from the thing observed by a so-called "constant error." So shots may be constantly deflected from the bull's-eye by a steady wind or "drift."

120. On the other hand, statistics, not purporting to represent a real object, have more or less close relations to magnitudes which cannot be described as fictitious. Where the items averaged are ratios, e.g. the proportion of births or deaths to the total population in several districts or other sections, it sometimes happens that the distribution of the ratios exactly corresponds to that which is obtained in the simplest games of chance—"combinational" distribution in the phrase of Lexis.³ There is unmistakably suggested a *sortition* of the simplest type, with a real ascertainable relation between the number of "favourable cases" and the total number of cases. The most remarkable example of this property is presented by the proportion of male to female (or to total) births. Some other instances are given by Lexis⁴ and Westergaard.⁵ A similar correspondence between the actual and the "combinational" distribution has been found by Bortkevitch⁶ in the case of very small probabilities (in which case the law of error is no longer "normal"). And it is likely that some ratios—such as general death-rates—not presenting combinational distribution, might be broken up into subdivisions—such as death-rates for different occupations or age-periods—each distributed in that simple fashion.

121. Another sort of averages which it is difficult to class as subjective rather than objective occurs in some social statistics, under the designation of index-numbers. The percentage which represents the change in the value of money between two epochs is seldom regarded as the mere average change in the price of several articles taken at random, but rather as the measure of something, e.g. the variation in the price of a given amount of commodities, or of a unit of commodity.⁷ So something substantive appears to be designated by the *volume of trade*, or that of the *consumption of the working classes*, of which the growth is measured by appropriate *index-numbers*,⁸ the former due to Bourne and Sir Robert Giffen,⁹ the latter to George Wood.¹⁰

122. But apart from these peculiarities, any set of statistics may be related to a certain *quæsitum*, very much as measurements are related to the object measured. That *quæsitum* is the limiting or ultimate mean to which the series of statistics, if indefinitely prolonged, would converge, the mean of the complete group; this conception of a limit applying to any *frequency-constant*, to "c," for instance, as well as "a" in the case of the normal curve.¹¹ The given statistics may be treated as samples from which to reason up to the true constant by that principle of the calculus which determines the comparative probability of different causes from which an observed event may have emanated.¹²

123. Thus it appears that there is a characteristic more essential to the statistician than the existence of an objective *quæsitum*, namely, the use of that method which is primarily, but not exclusively, proper to that sort of *quæsitum*—*inverse probability*.¹³

Without that delicate instrument the doctrine of error can seldom be fully utilized; but some of its uses may be indicated before the introduction of technical difficulties.

124. Having established the prevalence of the law of error,¹⁴ we go on to its applications. The mere presumption that wherever three or four independent causes co-operate, the law of error tends to be set up, has a certain speculative interest.¹⁵ The assumption of the law as a hypothesis is legitimate. When the presumption is confirmed by specific experience this knowledge is apt to be turned to account. It is usefully applied to the practice of gunnery,¹⁶ to determine the proportion of shots which under assigned conditions may be expected to hit a zone of given size. The expenditure of ammunition required to hit an object can thence be inferred. Also the comparison between practice under different conditions is facilitated. In many kinds of examination it is found that the total marks given to different candidates for answers to the same set of questions range approximately in conformity with the law of error. It is understood that the civil service commissioners have founded on this fact some practical directions to examiners. Apart from such direct applications, it is a useful addition to our knowledge of a class that the measurable attributes of its members range in conformity with this general law. Something is added to the truth that "the days of a man are threescore and ten," if we may regard that epoch, or more exactly for England, 72, as "Nature's aim, the length of life for which she builds a man, the dispersion on each side of this point being . . . nearly normal."¹⁷ So Herschel says: "An [a mere] average gives us no assurance that the future will be like the past. A [normal] mean may be reckoned on with the most complete confidence."¹⁸ The existence of independent causes,¹⁹ inferred from the fulfilment of the normal law, may be some guarantee of stability. In natural history especially have the conceptions supplied by the law of error been fruitful. Investigators are already on the track of this inquiry: if those members of a species whose size or other measurable attributes are above (or below) the average are preferred—by "natural" or some other kind of selection—as parents, how will the law of frequency as regards that attribute be modified in the next generation?

125. A particularly perfect application of the normal law of error in more than one dimension is afforded by the movements of the molecules in a homogeneous gas. A general idea of the rôle played by probabilities in the explanation of these movements may be obtained without entering into the more complicated and controverted parts of the subject, without going beyond the initial very abstract supposition of perfectly elastic equal spheres. For convenience of enunciation we may confine ourselves to two dimensions. Let us imagine, then, an enormous billiard-table with perfectly elastic cushions and a frictionless cloth on which millions of perfectly elastic balls rush hither and thither at random—colliding with each other—a homogeneous chaos, with that sort of uniformity in the midst of diversity which is characteristic of probabilities. Upon this hypothesis, if we fix attention on any n balls taken at random—they need not be, according to some they ought not to be, contiguous—if n is very large, the average properties will be approximately the same as those of the total mixture. In particular the average energy of the n balls may be equated to the average energy of the total number of balls, say T/N , if T is the total energy and N the total number of the balls. Now if we watch any one of the n specimen balls long enough for it to undergo a great number of collisions, we observe that either of its velocity-components, say that in the direction of x , viz. u , receives accessions from an immense number of independent causes in random fashion. We may presume, therefore, that these will be distributed (among the n balls) according to the law of error. The law will not be of the type which was first supposed, where the "spread" continually increases as the number of the elements is increased.²⁰ Nor will it be of the type which was afterwards mentioned²¹ where the spread diminishes as the number of the elements is increased. The linear function by which the elements are aggregated is here of an intermediate type; such that the mean square of deviation corresponding to the velocity remains constant. The method of composition might be illustrated by the process of taking r digits at random from mathematical tables adding the differences between each digit and 4.5 the mean value of digits, and dividing the sum by \sqrt{r} . Here are some figures obtained by taking at random batches of sixteen digits from the expansion of π , subtracting 16×4.5 from the sum of each batch, and dividing the remainder by $\sqrt{16}$ —

Applications of the Normal Law.

Normal Distribution of Molecular Velocities.

¹ *Wages in the United Kingdom in the Nineteenth Century*; and art.

"Wages" in the *Ency. Brit.*, 10th ed., vol. xxxiii.

² *Phil. Mag.* (1900), p. 168.

³ Cf. *Journ. Stat. Soc.*, Jubilee No., p. 192.

⁴ *Massenerscheinungen*.

⁵ *Grundzüge der Statistik*. Cf. Bowley, *Elements of Statistics*, p. 302.

⁶ *Das Gesetz der kleinen Zahlen*.

⁷ See for other definitions *Report of the British Association* (1889), pp. 136 and 161, and compare Walsh's exhaustive *Measurement of General Exchange-Value*.

⁸ Cf. Bowley, *Elements of Statistics*, ch. ix.

⁹ *Journ. Stat. Soc.* (1874 and later). Parly. Papers [C. 2247] and [C. 3079].

¹⁰ "Working-Class Progress since 1860," *Journ. Stat. Soc.* (1899), p. 639.

¹¹ On this conception compare Venn, *Logic of Chance*, chs. iii. and iv., and Sheppard, *Proc. Lond. Math. Soc.*, p. 363 seq.

¹² Laplace's 6th principle, *Théorie analytique*, intro. x.

¹³ See above, pars. 13 and 14.

¹⁴ Cf. above, par. 102.

¹⁵ Cf. Galton's enthusiasm, *Natural Inheritance*, p. 66.

¹⁶ A lucid statement of the methods and results of probabilities applied to gunnery is given in the *Official Text-book of Gunnery* (1902).

¹⁷ Venn, *Journ. Stat. Soc.* (1891), p. 443.

¹⁸ *Ed. Rev.* (1850), xcii. 23.

¹⁹ Cf. Galton, *Phil. Mag.* (1875), xlix. 44.

²⁰ Above, par. 112.

²¹ *Ibid.*

+1.25, +0.75, -1, -1, +5.5, -2.75, +0.75, -2,
+1.75, +3.25, +0.25, -2.75, -2.25, -0.5, +4.75, +0.25.

If, instead of sixteen, a million digits went to each batch, the general character of the series would be much the same; the aggregate figures would continue to hover about zero with a standard deviation of 8.25, a probable error of nearly 2. Here for instance are seven aggregates formed by recombining 252 out of the 256 digits above utilized into batches of 36 according to the prescribed rule: viz. subtracting 36×4.5 from the sum of each batch of 36 and dividing the remainder by $\sqrt{36}$ —

-0.5, +3.3, +2.6, -0.6, +1.5, -2, +1.

The illustration brings into view the circumstance that though the system of molecules may start with a distribution of velocities other than the normal, yet by repeated collisions the normal distribution will be superinduced. If both the velocities u and v are distributed according to the law of error for one dimension, we may presume that the joint values of u and v conform to the normal surface. Or we may reason directly that as the pair of velocities u and v is made up of a great number of elementary pairs (the co-ordinates in each of which need not, initially at least, be supposed uncorrelated) the law of frequency for concurrent values of u and v must be of the normal form which may be written¹

$$z = \frac{1}{2\sqrt{(km \cdot 1 - r^2)}} \exp - \left[\frac{x^2}{k} - 2r \frac{xy}{\sqrt{km}} + \frac{y^2}{m} \right] / 2(1 - r^2).$$

It may be presumed that r , the coefficient of correlation, is zero, for, owing to the symmetry of the influences by which the molecular chaos is brought about, it is not to be supposed that there is any connexion or repugnance between one direction of u , say south to north, and one direction of v , say west to east. For a like reason k must be supposed equal to m . Thus the average velocity = $2k$; which multiplied by m , the mass of a sphere, is to be equated to the average energy T/N . The reasoning may be extended with confidence to three dimensions, and with caution to contiguous molecules.

126. Correlation cannot be ignored in another application of the many-dimensioned law of error, its use in biological inquiries to investigate the relations between different generations.

Normal Correlation in Biology.

It was found by Galton that the heights and other measurable attributes of children of the same parents range about a mean which is not that of the parental heights, but nearer the average of the general population. The amount of this "regression" is simply proportional to the distance of the "mid-parent's" height from the general average. This is a case of very general law which governs the relations not only between members of the same family, but also between members of the same organism, and generally between two (or more) coexistent or in any way co-ordinated observations, each belonging to a normal group. Let x and y be the measurements of a pair thus constituted. Then² it may be expected that the conjunction of particular values for x and y will approximately obey the two-dimensioned normal law which has been already exhibited (see par. 114).

127. *Regression-lines.*—In the expression above given, put $l/\sqrt{km} = r$, and the equation for the frequency of pairs having values of the attribute under measurement becomes

$$z = \frac{1}{2\pi\sqrt{km}\sqrt{1-r^2}} \exp \left[\frac{(x-a)^2}{k} - 2r \frac{(x-a)(y-b)}{\sqrt{k}\sqrt{m}} + \frac{(y-b)^2}{m} \right] / 2(1 - r^2).$$

This formula is of very general application.³ If two sets of measurements were made on the height, or other measurable feature, of the proverbial "Goodwin Sands" and "Tenterden Steeple," and the first measurement of one set was coupled with the first of the other set, the second with the second, and so on, the pairs of magnitudes thus presented would doubtless vary according to the above-written law, only in that case r would presumably be zero; the expression for z would reduce to the product of the two independent probabilities that particular values of x and y should concur. But slight interdependences between things supposed to be totally unconnected would often be discovered by this law of error in two or more dimensions.⁴ It may be put in a more convenient form by substituting ξ for $(x-a)/\sqrt{k}$ and η for $(y-b)/\sqrt{m}$. The equation of the surface then becomes $z = (1/2\pi\sqrt{1-r^2}) \exp - [\xi^2 - 2r\xi\eta + \eta^2] / 2(1 - r^2)$. If the frequency of observations in the vicinity of a point is represented by the number of dots in a small increment of area, when $r=0$ the dots will be distributed uniformly about the origin, the curves of equal probability will be circles. When r is different from zero

the dots will be distributed so that the majority will be massed in two quadrants: in those for which ξ and η are both positive or both negative when r is positive, in those for which ξ and η have opposite signs when r is negative. In the limiting case, when $r=1$ the whole host will be massed along the line $\eta=\xi$, every deviation ξ being attended with an equal deviation η . In general, to any deviation of one of the variables ξ' there corresponds a set or "array" (Pearson) of values of the other variable; for which the frequency is given by substituting ξ' for ξ in the general equation. The section thus obtained proves to be a normal probability-curve with standard deviation $\sqrt{(1-r^2)}$. The most probable value of η corresponding to the assigned value of ξ is $r\xi'$. The equation $\eta=r\xi$, or rather what it becomes when translated back to our original co-ordinates $(y-b)/\sigma_2 = r(x-a)/\sigma_1$, where σ_1, σ_2 are our \sqrt{k}, \sqrt{m} respectively,⁵ is often called a *regression-equation*. A verification is to hand in the above-cited statistics, which Weldon obtained by casting batches of dice. If the dice were perfect, $r (=l/\sqrt{km})$ would equal $\frac{1}{2}$, and as the dice proved not to be very imperfect, the coefficient is doubtless approximately $\frac{1}{2}$. Accordingly, we may expect that, if axes x and y are drawn through the point of maximum-frequency at the centre of the compartment containing 244 observations, corresponding to any value of x , say $2vi$ (where i is the side of each square compartment), the most probable value of y should be vi , and corresponding to $y=2vi$ the most probable value of x should be vi . And in fact these regression-equations are fairly well fulfilled for the integer values of v (more than which could not be expected from discrete observations): e.g. when $x=+4i$, the value of y , for which the frequency (25) is a maximum, is as it ought to be $+2i$; when $x=-2i$ the maximum (119) is at $y=-i$; when $x=-4i$ the maximum (16) is at $y=-2i$; when y is $+2i$ the maximum (138) is at $x=+i$; when y is $-2i$ the maximum (117) at $x=-i$, and in the two cases ($x=+2i$ and $y=+4i$), where the fulfilment is not exact, the failure is not very serious.

128. Analogous statements hold good for the case of three or more dimensions of error.⁶ The normal law of error for any number of variables, x_1, x_2, x_3 , may be put in the form $z = (1/2\pi)^{n/2} \sqrt{\Delta} \exp - [R_{11}x_1^2 + R_{22}x_2^2 + \&c. + 2R_{12}x_1x_2 + \&c.] / 2\Delta$ where Δ is the determinant:—

	1	r_{12}	r_{13} ..
r_{21}		1	r_{23} ..
r_{31}		r_{32}	1 ..
:	:	:	;

each r , e.g. $r_{23} (=r_{32})$, is the coefficient of correlation between two of the variables, e.g. x_2, x_3 ; R_{11} is the first minor of the determinant formed by omitting the first row and first column; R_{22} is the first minor formed by omitting the second row and the second column, and so on; $R_{12} (=R_{21})$ is the first minor formed by omitting the first column and second row (or vice versa). The principle of correlation plays an important rôle in natural history. It has replaced the notion that there is a simple proportion between the size of organs by the appropriate conception that there are simple proportions existing between the deviation from the average of one organ and the most probable value for the coexistent deviation of the other organ from its average.⁷ Attributes favoured by "natural" or other selection are found to be correlated with other attributes which are not directly selected. The extent to which the attributes of an individual depend upon those of his ancestors as measured by correlation.⁸ The principle is instrumental to most of the important "mathematical contributions" which Professor Pearson has made to the theory of evolution.⁹ In social inquiries, also, the principle promises a rich harvest. Where numerous fluctuating causes go to produce a result like pauperism or immunity from small-pox, the ideal method of eliminating chance would be to construct "regression-equations" of the following type: "Change % in pauperism [in the decade 1871-1881] in rural districts = -27.07%, +0.299 (change % out-relief ratio), +0.271 (change % on proportion of old), +.064 (change % in population)."¹⁰

129. In order to determine the best values of the coefficients involved in the law of error, and to test the worth of the results obtained by using any values, recourse must be had to *inverse probability*.

Determination of Constants by the Inverse Method.

130. The simplest problem under this head is where the *quaesitum* is a single real object and the data consist of a large number of observations, x_1, x_2, \dots, x_n , such that if the number were indefinitely increased, the completed series would form a normal probability-curve with the true point as its centre, and having a given modulus c . It is as if we had observed the position of the dints made by the fragments

¹ Above, par. 114, and below, par. 127.

² Some plurality of independent causes is presumable.

³ Herschel's a priori proposition concerning the law of error in two dimensions (above, par. 99) might still be defended either as generally true, so many phenomena showing no trace of interdependence, or on the principle which justifies our putting $\frac{1}{2}$ for a probability that is unknown (above, par. 6), or $\frac{1}{5}$ for a decimal place that is neglected; correlation being equally likely to be positive or negative. The latter sort of explanation may be offered for the less serious contrast between the a priori and the empirical proof of the law of error in one dimension (below, par. 158).

⁴ Cf. above, par. 115.

⁵ Cf. note to par. 98, above.

⁶ *Phil. Mag.* (1892), p. 200 seq.; 1896, p. 211; Pearson, *Trans. Roy. Soc.* (1896), 187, p. 302; Burbury, *Phil. Mag.* (1894), p. 145.

⁷ Pearson, "On the Reconstruction of Prehistoric Races," *Trans. Roy. Soc.* (1898), A, p. 174 seq.; *Proc. Roy. Soc.* (1898), p. 418.

⁸ Pearson, "The Law of Ancestral Heredity," *Trans. Roy. Soc.; Proc. Roy. Soc.* (1898).

⁹ Papers in the Royal Society since 1895.

¹⁰ An example instructively discussed by Yule, *Journ. Stat. Soc.* (1899).

of an exploding shell so far as to know the distance of each mark measured (from an origin) along a right line, say the line of an extended fortification, and it was known that the shell was fired perpendicular to the fortification from a distant ridge parallel to the fortification, and that the shell was of a kind of which the fragments are scattered according to a normal law¹ with a known coefficient of dispersion; the question is at what position on the distant ridge was the enemy's gun probably placed? By received principles the probability, say P, that the given set of observations should have resulted from measuring (or aiming at) an object of which the real position was between x and $x + \Delta x$ is

$$\Delta x J \exp - [(x - x_1)^2 + (x - x_2)^2 + \&c.]/c^2;$$

where J is a constant obtained by equating to unity $\int_{-\infty}^{+\infty} P dx$

(since the given set of observations must have resulted from some position on the axis of x). The value of x , from which the given set of observations most probably resulted, is obtained by making P a maximum. Putting $dP/dx = 0$, we have for the maximum (d^2P/dx^2 being negative for this value) the arithmetic mean of the given observations. The accuracy of the determination is measured by a probability-curve with modulus c/\sqrt{n} . This in the course of a very long siege if every case in which the given group of shell-marks x_1, x_2, \dots, x_n was presented could be investigated, it would be found that the enemy's cannon was fired from the position x' , the (point right opposite to the) arithmetic mean of $x_1, x_2, \&c., x_n$, with a frequency assigned by the equation

$$z = (\sqrt{n}/\sqrt{\pi c}) \exp - n(x - x')^2/c^2.$$

The reasoning is applicable without material modification to the case in which the data and the *quaesitum* are not absolute quantities, but proportions; for instance, given the percentage of white balls in several large batches drawn at random from an immense urn containing black and white balls, to find the percentage of white balls in the urn—the inverse problem associated with the name of Bayes.

131. Simple as this solution is, it is not the one which has most recommended itself to Laplace. He envisages the *quaesitum* not so much as that point which is most probably the real one, as that point which may most advantageously be put for the real one. In our illustration it is as if it were required to discover from a number of shot-marks not the point² which in the course of a long siege would be most frequently the position of the cannon which had scattered the observed fragments but the point which it would be best to treat as that position—to fire at, say, with a view of silencing the enemy's gun—having regard not so much to the frequency with which the direction adopted is right, as to the extent to which it is wrong in the long run. As the measure of the detriment of error, Laplace³ takes "la valeur moyenne de l'erreur à craindre," the mean first power of the errors taken positively on each side of the real point. The mean spare of errors is proposed by Gauss as the criterion.⁴ Any mean power indeed, the integral of any function which increases in absolute magnitude with the increase of its variable, taken as the measure of the detriment, will lead to the same conclusion, if the normal law prevails.⁵

132. Yet another speculative difficulty occurs in the simplest, and recurs in the more complicated inverse problem. In putting P as the probability, deduced from the observations that the real point for which they stand is x (between x and $x + \Delta x$), it is tacitly assumed that prior to observation one value of x is as probable as another. In our illustration it must be assumed that the enemy's gun was as likely to be at one point as another of (a certain tract of) the ridge from which it was fired. If, apart from the evidence of the shell-marks, there was any reason for thinking that the gun was situated at one point rather than another, the formula would require to be modified. This a priori probability is sometimes grounded on our ignorance; according to another view, the procedure is justified by a rough general knowledge that over a tract of x for which P is sensible one value of x occurs about as often as another.⁶

¹ If normally in any direction indifferently according to the two- or three-dimensional law of error, then normally in one dimension when collected and distributed in belts perpendicular to a horizontal right line, as in the example cited below, par. 155.

² Or small interval (cf. preceding section).

³ "Toute erreur soit positive soit négative doit être considérée comme un désavantage ou une perte réelle à un jeu quelconque," *Théorie analytique*, art. 20 seq., especially art. 25. As to which it is acutely remarked by Bravais (*op. cit.*, p. 258), "Cette règle simple laisse à désirer une démonstration rigoureuse, car l'analogie du cas actuel avec celui des jeux de hasard est loin d'être complète."

⁴ *Theoria combinationis*, pt. i. § 6. Simon Newcomb is conspicuous by walking in the way of Laplace and Gauss in his preference of the most advantageous to the most probable determinations. With Gauss he postulates that "the evil of an error is proportioned to the square of its magnitude" (*American Journal of Mathematics*, vol. viii. No. 4).

⁵ As argued by the present writer, *Camb. Phil. Trans.* (1885), vol. xiv. pt. ii. p. 161. Cf. Glaisher, *Mem. Astronom. Soc.* xxxix. 108.

⁶ The view taken by the present writer on the "Philosophy of Chance," in *Mind* (1880; approved by Professor Pearson, *Grammar*

133. Subject to similar speculative difficulties, the solution which has been obtained may be extended to the analogous problem in which the *quaesitum* is not the real value of an observed magnitude, but the mean to which a series of statistics indefinitely prolonged converges.⁷

134. Next, let the modulus, still supposed given, not be the same for all the observations, but c_1 for x_1, c_2 for $x_2, \&c.$ Then P becomes proportional to

$$\exp - [(x - x_1)^2/c_1^2 + (x - x_2)^2/c_2^2 + \&c.].$$

And the value of x which is both the most probable and the "most advantageous" is $(x_1/c_1^2 + x_2/c_2^2 + \&c.)/(1/c_1^2 + 1/c_2^2 + \&c.)$; each observation being weighted with the inverse mean square of observations made under similar conditions.⁸ This is the rule prescribed by the "method of least squares"; but as the rule in this case has been deduced by genuine inverse probability, the problem does not exemplify what is most characteristic in that method, namely, that a rule deducible from the hypothesis that the errors of observations obey the normal law of error is employed in cases where the normal law is not known, or even is known not, to hold good. For example, let the curve of error for each observation be of the form of

$$z = [1/\sqrt{\pi c}] \times \exp [- x^2/c^2 - 2j(x/c - 2x^3/3c^3)],$$

where j is a small fraction, so that z may equally well be equated to $(1/\sqrt{\pi c}) [1 - 2j(x/c - 2x^3/3c^3)] \exp - x^2/c^2$, a law which is actually very prevalent. Then, according to the genuine inverse method, the most probable value of x is given by the quadratic equation

$$\frac{d}{dx} \log P = 0, \text{ where } \log P = \text{const.} - \Sigma(x - x_r)^2/c_r^2 - 2\Sigma j[(x - x_r)^2/c_r^3 - 2(x - x_r)^3/3c_r^3],$$

Σ denoting summation over all the observations. According to the "method of least squares," the solution is the weighted arithmetic mean of the observations, the weight of any observation being inversely proportional to the corresponding mean square, i.e. $c_r^2/2$ (the terms of the integral which involve j vanishing), which would be the solution if the j 's are all zero. We put for the solution of the given case what is known to be the solution of an essentially different case. How can this paradox be justified?

135. Many of the answers which have been given to this question seem to come to this. When the data are unmanageable, it is legitimate to attend to a part thereof, and to determine the most probable (or the "most advantageous") value of the *quaesitum*, and the degree of its accuracy, from the selected portion of the data as if it formed the whole. This throwing overboard of part of the data in order to utilize the remainder has often to be resorted to in the rough course of applied probabilities. Thus an insurance office only takes account of the age and some other simple attributes of its customers, though a better bargain might be made in particular cases by taking into account all available details. The nature of the method is particularly clear in the case where the given set of observations consists of several batches, the observations in any batch ranging under the same law of frequency with mean x'_r and mean square of error k_r , the function and the constants different for different batches; then if we confine our attention to those parts of the data which are of the type x'_r and k_r —ignoring what else may be given as to the laws of error—we may treat the x'_r 's as so many observations, each ranging under the normal law of error with its coefficient of dispersion; and apply the rules proper to the normal law. Those rules applied to the data, considered as a set of derivative observations each formed by a batch of the original observations) averaged, give as the most probable (and also the most advantageous combination of the observations the arithmetic mean weighted according to the inverse mean square pertaining to each observation, and for the law of the error to which the determination is liable the normal law with standard deviation $\sqrt{(\Sigma k/n)}$ —the very rules that are prescribed by the method of least squares.

136. The principle involved might be illustrated by the proposal to make the economy of datum a little less rigid: to utilize, not indeed all, but a little more of our materials—not only the mean square of error for each batch, but also the mean cube of error. To begin with the simple case of a single homogenous batch: suppose that in our example the fragments of the shell are no longer scattered according to the normal law. By the method of least squares it would still be proper to put the arithmetic mean to the given observations for the true point required, and to measure the accuracy of that determination by a probability-curve of which the modulus is $\sqrt{(2k)}$, where k is the mean square of deviation (of fragments from their mean). If it is thought desirable to utilize more of the data there is available, the proposition that the arithmetic mean of a

of Science, 2nd ed. p. 146). See also "A priori Probabilities," *Phil. Mag.* (Sept. 1884), and *Camb. Phil. Trans.* (1885), vol. xiv. pt. ii. p. 147 seq.

² Above, pars. 6, 7.

³ The mean square $\int_{-\infty}^{+\infty} (x^2/\sqrt{\pi c}) \exp - x^2/c^2 dx = c^2/2$.

⁴ The standard deviation pertaining to a set of (n/r) composite observations, each derived from the original n observations by averaging a batch thereof numbering r , is $\sqrt{(k/r)}/\sqrt{(n/r)} = \sqrt{(k/n)}$, when the given observations are all of the same weight; *mutatis mutandis* when the weights differ.

numerous set of observations, say x_1, x_2, \dots, x_n (taken as a sample from an indefinitely large group obeying any the same law of frequency) varies from set to set approximately according to the following law (to be established later)

$$z = \frac{n}{\sqrt{\pi c}} \exp - \left[\frac{nx^2}{c^2} + 2nj \left(\frac{x}{c} - \frac{2x^3}{3c^3} \right) \right] = f(x), \text{ say;}$$

where $c^2/2$ the mean square of deviation, and j = the mean cube of deviation, and j/c_3 , say j , is small. Then, by abstraction analogous to that which has just been attributed to the method of least squares, we may regard the datum as a single observation, the arithmetic mean (of a sample batch of observations) subject to the law of error $z=f(x)$. The most probable value of the *quaesitum* is therefore given by the equation $f'(x-x') = 0$, where x' is the arithmetic mean of the given observations. From the resulting quadratic equation, putting $x = x' + \epsilon$, and recollecting that ϵ is small we have $\epsilon = jc$. That is the correction due to the utilization of the mean cube of error. The most advantageous solution cannot now be determined, $f(x)$ being unsymmetrical, without assuming a particular form for the function of detriment. This method of least squares plus cubes may easily be extended to the case of several batches.

137. This application of probabilities not to the actual data but to a selected part thereof, this economy of the inverse method, is widely practised in miscellaneous statistics, where the object is to determine whether the discrepancy between two sets of observation is accidental or significant of a real difference.² For instance, let the data be ages at death of individuals of two classes (e.g. temperate or not so, urban or rural, &c.) who have been under observation, since the age of, say, 20. Granted that the ages at death conform to Gompertz's law; the determination of the modal age at death, that age at which the proportion of the total observed dying (per unit of time) is a maximum for each class, would most perfectly be effected by the genuine inverse method. That method will also enable us to determine the probability that the two modes should have differed to the observed extent by mere accident.³ According to the abridged method it suffices to proceed as if our data consisted of two observations x' and y' , the average ages at death of the two classes, each average obeying the normal law of error, with respective moduli $c_1 = \sqrt{[(x' - x_1)^2 + (x' - x_2)^2 + \dots]2/n}$, $c_2 = \sqrt{[(y' - y_1)^2 + (y' - y_2)^2 + \dots]2/n}$, where $x_1, x_2, \dots, y_1, y_2, \dots$, are the respective sets of observed ages at death; as follows from the law of error, whatever the law of distribution of the given observations. According to a well-known property of the normal law, the difference between the averages of n and n' observations respectively will range under a probability-curve with modulus $\sqrt{c_1^2 + c_2^2}$, say c . Whence for the probability that a difference as great as the observed one, say e , should have occurred by chance we have $\frac{1}{2}[1 - \theta(\tau)]$, where $\tau = e/c$, and $\theta(x)$ is the integral $2/\sqrt{\pi} \int_0^x (\exp - x^2) dx$, given in many treatises.

138. This sort of abridgment may be extended to other kinds of average besides the arithmetic, in particular the median (that point which has as many of the given observations above as below it). By simple induction we know that the median of a large sample of observations is a probable value for the true median; how probable is determined as follows from a selection of our data. First suppose that all the observations are of the same weight. If x' were the true median, the probability that as many as $\frac{1}{2}n + r$ of the observations should fall on either side of that point is given by the normal law for which the exponent is $-2r^2/n$.⁴ This probability that the observed median will differ from the true one by a certain number of observations is connected with the probability that they will differ by a certain extent of the abscissa, by the proposition that the number of observations contained between the true and apparent median is equal to the small difference between them multiplied by the density of observations at the median—in the case of normal and generally symmetrical curves the greatest ordinate. This is the second datum we require to select. In the case of the normal curve it may be calculated from the modulus itself, determined by induction from a selection of data. If the observations are not all of the same worth, weight may be assigned by counting one observation as if it occurred oftener than another. This is the essence of Laplace's Method of Situation.⁵

¹ The use of the cubes is also contrasted with that of the squares (only) in this respect: that it is no longer a matter of indifference how many of the original observations we assign to the batch of which the mean constitutes the single (compound) observation.

² The object of the writer's paper on "Methods of Statistics" in the Jubilee number of the *Journ. Stat. Soc.* (1885).

³ See on the use of the inverse method to determine the mode of a group, the present writer's paper on "Probable Errors" in the *Journ. Stat. Soc.* (Sept. 1908).

⁴ Above, par. 103.

⁵ *Théorie analytique*, 2nd supp. p. 164. *Mécanique céleste*, bk. iii. art. 40; on which see the note in Bowdich's translation. The method may be extended to other percentiles. See Czuber, *Beobachtungsfehler*, § 58. Cf. *Phil. Mag.* (1886), p. 375; and Sheppard,

139. In its simplest form, where all the given observations are of equal weight, this method is of wide applicability. Compared with the genuine inverse method, it is always more convenient, seldom much less accurate, sometimes even more accurate. If the given observations obey the normal law, the precision of the median is less than the precision of the arithmetic mean by only some 25%—a discrepancy not very serious where only a rough estimate of the worth of an average is required. If the observations do not obey the normal law—especially if the extremities are abnormally divergent—the precision of the median may be greater than that of the arithmetic mean.⁶

140. Yet another instance of the contrast between genuine and abridged inversion is afforded by the problem to determine the modulus as well as the mean for a set of observations known to obey the normal law; what the first problem⁷ becomes when the coefficient of dispersion is not given. By inverse probability we ought in that case, in addition to the equation $dP/dx = 0$, to put $dP/dc = 0$. Whence $c^2 = 2[(x' - x_1)^2 + (x' - x_2)^2 + \dots + (x' - x_n)^2]/n$, and $x' = (x_1 + x_2 + \dots + x_n)/n$. This solution differs from that which is often given in the textbooks⁸ in that there, in the expression for c^2 , $(n - 1)$ occurs in the denominator instead of n . The difference is explained by the fact that the authorities referred to determine c , not by genuine inversion, but by ordinary induction, by a condition which certainly would be fulfilled in the long run, but does not express the whole of our data; a condition in this respect like the equation of c to $\sqrt{\pi}(Ze)/n$, where e is the difference (taken positively, without regard to its sign) between any observation and the arithmetic mean of all the observations.⁹

141. Of course the determination of the most probable value is subject to the speculative difficulties proper to a priori probability: which are particularly striking in this case, as it appears equally natural to take as that constant, of which the values are a priori equally probable, k ($=c^2/2$), or even h ($=1/c^2$), the measure of weight, as in fact Laplace has done;¹¹ yet no two of these assumptions can be exactly true.¹²

142. A more convenient determination is obtained from simple induction by equating the modulus to some datum of the observed group to which it would be equal if the group were complete—in particular to the distance from the median of some percentile (or point which marks off a certain percentage, e.g. 25 of the given observations) multiplied by a factor corresponding to the percentile obtainable from a familiar table. Mr Sheppard has given an interesting proof¹³ that we cannot by way of percentiles obtain such good¹⁴ results for the frequency-constants as by the use of "the average and average square" [the method prescribed by inverse probability].

143. The same philosophical subtleties, with greater mathematical complications, meet us when we pass on to the case of two or more *quaesita*. The problem under this head which mainly exercised the older writers was to determine a number of unknown quantities, given a larger number, n , of equations involving them.¹⁵

144. Supposing the true values approximately known, by substituting the approximate values in the given equations and expanding according to Taylor's theorem, there will be obtained for the corrections, say x, y, \dots, n linear equations of the form

$$\begin{aligned} a_1x + b_1y \dots &= f_1 \\ a_2x + b_2y \dots &= f_2, \end{aligned}$$

where each a and b is a known coefficient, and each f is a fallible observation. Suppose that the error to which each is liable obeys the normal law, and that the modulus pertaining to each observation is the same—which latter condition can be secured by multiplying each equation by a proper factor—then if x' and y' are the true values of the *quaesita*, the frequency with which $(a_1x' + b_1y' - f_1)$ assumes different values is given by the equation $z = 1/(\sqrt{\pi}c) \exp - [a_1x + b_1y - f_1]^2/c_1^2$, where c_1 is a constant which,

Trans. Roy. Soc. (1889), 192, p. 135, ante, where the error incident to this kind of determination is ascertained with much precision.

⁶ Cf. *Phil. Mag.* (1887), xxiv. 269 seq., where the median is prescribed in case of "discordant" (heterogeneous) observations. If the more drastic remedy of rejecting part of the data is resorted to Sheppard's method of performing that operation may be recommended (*Proc. Lond. Math. Soc.* vol. 31). He prescribes for cases to which the median may not be appropriate, namely, the determination of other frequency-constants besides the mean of the observations.

⁷ Above, par. 134.

⁸ E.g. Airy, *Theory of Errors*, art. 60.

⁹ It is a nice point that the expression for c^2 , which has $(n - 1)$ instead of n for denominator, though not the more probable, may yet be the more advantageous (supposing that there were any sensible difference between the two). Cf. *Camb. Phil. Trans.* (1885), vol. xiv. pt. ii. p. 165; and "Probable Errors," *Journ. Stat. Soc.* (June 1908).

¹⁰ Above, par. 96, note.

¹¹ *Théorie analytique*, 2nd supp. ed. 1847, p. 578.

¹² See the matter discussed in *Camb. Phil. Trans.*, loc. cit.

¹³ *Trans. Roy. Soc.* (1899), A, cxcii. 135.

¹⁴ Good as tested by a comparison of the mean squares of errors in the frequency-constant determined by the compared methods.

Determination of Frequency Constants.

Entangled Measurements.

if not known beforehand, may be inferred, as in the simpler case, from a set of observations. Similar statements holding for the other equations, the probability that the given set of observations f_1, f_2, \dots , should have resulted from a particular system of values for x, y, \dots is $J \exp \left[\frac{(a_1x + b_1y - f_1)^2}{c_1^2} + \frac{(a_2x + b_2y - f_2)^2}{c_2^2} + \dots \right]$, where J is a constant determined on the same principle as in the analogous simpler cases.¹ The condition that P should be a maximum gives as many linear equations for the determination of x', y', \dots as there are unknown quantities.

145. The solution proper to the case where the observations are known to arrange according to the normal law may be extended to numerous observations ranging under any law, on the principles which justify the use of the Method of Least Squares in the case of a single *quaesitum*.

146. As in that simple case, the principle of economy will now justify the use of the *median*, e.g. in the case of two *quaesita*, putting for the true values of x and y that point for which the sum of the perpendiculars let fall from it on each of a set of lines representing the given equations (properly weighted) is a minimum.²

147. The older writers have expressed the error in the determination of one of the variables without reference to the error in the other. But the error of one variable may be regarded

Normal Correlation. as correlated with that of another; that is, if the system x', y', \dots forms the solution of the given equations, while $x' + \xi, y' + \eta, \dots$ is the real system, the (small) values of ξ, η, \dots which will concur in the long run of systems from which the given set of observations result are normally correlated. From this point of view Bravais, in 1846, was led to several theorems which are applicable to the now more important case of correlation in which ξ and η are given (not in general small) deviations from the means of two or more correlated members (organs or attributes) forming a normal group.

148. To determine the frequency-constants of such a group it is proper to proceed on the analogy of the simple case of one-dimensional error. In the case of two dimensions, for instance, the probability p_1 that a given pair of observations (x_1, y_1) should have resulted from a normal group of which the means are x', y' respectively, the standard deviations σ_1 and σ_2 and the coefficient of correlation r , may be written—

$$\frac{\Delta x \Delta y \Delta \sigma_1 \Delta \sigma_2 \Delta r (1/2\pi) \sqrt{\sigma_1 \sigma_2 (1-r^2)} \exp -\frac{1}{2} E^2,$$
 where $E^2 = (x' - x_1)^2/\sigma_1^2 - 2r(x' - x_1)(y' - y_1)/\sigma_1 \sigma_2 + (y' - y_1)^2/\sigma_2^2$. A similar statement holds for each other pair of observations $(x_2, y_2), (x_3, y_3), \dots$; with analogous expressions for p_2, p_3, \dots . Whence, as in the simpler case, we have $p_1 \times p_2 \times \dots \times p_n / J$ (a constant) for P , the a posteriori probability that the given observations should have resulted from an assigned system of the frequency-constants. The most probable system is determined by making P a maximum, and accordingly equating to zero each of the following expressions—

$$\frac{dP}{dx}, \frac{dP}{dy}, \frac{dP}{d\sigma_1}, \frac{dP}{d\sigma_2}, \frac{dP}{dr}.$$

The values of the arithmetic mean and of the standard deviation for each variable are what have been obtained in the simple case of one dimension. The value of r is $\Sigma(x' - x_r)(y' - y_r)/\sigma_1 \sigma_2$.³ The probable error of the determination is assigned on the assumption that the errors to which it is liable are small.⁴ Such coefficients have already been calculated for a great number of interesting cases. For instance, the coefficient of correlation between the human stature and femur is 0.8, between the right and left femur is 0.96, between the statures of husbands and wives is 0.28.⁵

149. This application of inverse probability to determine correlation-coefficients and the error to which the determination is liable has been largely employed by Professor Pearson⁶ and other recent writers. The use of the normal formula to measure the probable—and improbable—errors incident to such determinations is justified by reasoning akin to that which has been employed in the general proof of the law of error.⁷ Professor Pearson has pointed out a circumstance which seems to be of great importance in the theory of evolution: that the errors incident to the determination of different frequency-coefficients are apt to be mutually correlated. Thus if a random selection be made from a certain population, the correlation-coefficient which fits the organs of that set is apt to differ from the coefficient proper to the complete group in the same sense as some other frequency-coefficients.

150. The last remark applies also to the determination of the coefficients, in particular those of correlation, by abridged methods, on principles explained with reference to the simple case; for instance by the formula $r = \Sigma \eta / \Sigma \xi$, where $\Sigma \xi$ is the sum of (some or all) the

positive (or the negative) deviations of the values for one organ or attribute measured by the modulus pertaining to that member, and $\Sigma \eta$ is the sum of the values of the other member, which are associated with the constituents of $\Sigma \xi$. This variety of this method is certainly much less troublesome, and is perhaps not much less accurate, than the method prescribed by genuine inversion.

151. A method of rejecting data analogous to the use of percentiles in one dimension is practised when, given the frequency of observations for each increment of area, e.g. each $\Delta x \Delta y$, we utilize only the frequency for *integral* areas. Mr Sheppard has given an elegant solution of the problem: to find the correlation between two attributes, given the medians L , and M , of a normal group for each attribute and the distribution of the total group, as thus.⁸

	<i>Below L,</i>	<i>Above L,</i>
<i>Below M,</i>	<i>P</i>	<i>R</i>
<i>Above M,</i>	<i>R</i>	<i>P</i>

FIG. 12.

If $\cos D$ is put for r , the coefficient of correlation, it is found that $D = \pi R / (P + R)$. For example, let the group of statistics relating to dice already cited from Professor Weldon be arranged in four quadrants by a horizontal and a vertical line, each of which separates the total groups into two halves: lines of which equations prove to be respectively $y = 6.11$ and $x = 6.156$. For R we have 1360.5, and for P 687.5 roughly. Whence $D = \pi \times 0.66$; $r = \cos 0.66 \times \pi = -\frac{1}{2}$ nearly, as it ought; the negative sign being required by the circumstance that the lower part of Mr Sheppard's diagram shown in fig. 12 corresponds to the upper part of Professor Weldon's diagram shown in par. 115.

152. Necessity rather than convenience is sometimes the motive for resort to percentiles. Professor Pearson has applied the median method to determine the correlation between husbands and wives in respect of the darkness of eye-colour, a character which does not admit of exact gradation: "our numbers merely refer to certain groupings, arranged, it is true, in increasing darkness of colour, but in no way corresponding to equal increases in colour-intensity."¹⁰ From data of this sort, having ascertained the number of husbands with eye-colours above the median tint who marry wives with eye-colour above the median tint, Professor Pearson finds for r the coefficient of correlation $+0.1$. A general method for determining the frequency-constants when the data are, or are taken to be, of the integral sort has been given by Professor Pearson.¹¹ Attention should also be called to Mr Yule's treatment of the problem by a sort of logical calculus on the lines of Boole and Jevons.¹²

153. In the cases of correlation which have been so far considered, it has been presupposed that the things correlated range according to the normal law of error. But now, suppose the law of distribution to be no longer normal: for instance, that the dots on the plane of xy ,¹³ representing each a pair of members, are no longer grouped in elliptic (or circular) rings of equal frequency, that the locus of the maximum y deviation, corresponding to an assigned x deviation, is no longer a right line. How is the interdependence of these deviations to be formulated? It is submitted that such data may be treated as if they were normal: by an extension of the *Method of Least Squares*, in two or more dimensions.¹⁴ Thus when the amount of pauperism together with the amount of outdoor relief is plotted in several unions there is obtained a distribution far from normal. Nevertheless if the average pauperism and average outdoor relief are taken for *aggregates*—say quintettes or decades—of unions taken at random, it may be expected that these means will conform to the normal law, with coefficients obtained from the original data, according to the rule which is proper to the case of the normal law.¹⁵ By obtaining averages conforming to the normal law, as by the simple application of the method of least squares, we should not indeed have utilized the whole of our data, but we shall put a part of it in a very useful

⁸ *Trans. Roy. Soc.* (1899), A, 192, p. 141.

⁹ Above, par. 115.

¹⁰ *Grammar of Science*, p. 432.

¹¹ *Trans. Roy. Soc.*, A, vol. 195. In this connexion reference should also be made to Pearson's theory of "Contingency" in his thirteenth contribution to the "Mathematical Theory of Evolution" (*Drapers' Company Research Memoirs*).

¹² *Trans. Roy. Soc.* (1900), A, 194, p. 257; (1901), A, 197, p. 91.

¹³ Above, par. 127.

¹⁴ Above, par. 116.

¹⁵ If from the given set of n observations (each corresponding to a point on the plane xy) there is derived a set of n/s observations each obtained by averaging a batch numbering s of the original observation; the coefficient of correlation for the derived system is the same as that which pertains to the original system. As to the standard deviation for the new system see note to par. 135.

¹ Above, par. 130.

² See *Phil. Mag.* (1888), "On a New Method of Reducing Observations"; where a comparison in respect of convenience and accuracy with the received method is attempted.

³ Corresponding to the k/\sqrt{lm} of pars. 14, 127 above.

⁴ Pearson, *Trans. Roy. Soc.*, A, 191, p. 234.

⁵ Pearson, *Grammar of Science*, 2nd ed. p. 402, 431.

⁶ *Trans. Roy. Soc.* (1898), A, vol. 191; *Biometrika*, ii. 273.

⁷ Above, par. 107. Compare the proof of the "Subsidiary Law of Error," as the law in this connexion may be called, in the paper on "Probable Errors," *Journ. Stat. Soc.* (June 1908).

shape. Although the regression-equations obtained would not accurately fit the original material, yet they would have a certain correspondence thereto. What sort of correspondence may be illustrated by an example in games of chance, which Professor Weldon kindly supplied. Three half-dozen of dice having been thrown, the number of dice with more than three points in that dozen which is made up of the first and the second half-dozen is taken for y , the number of sixes in the dozen made up to the first and the third half-dozen, is taken for x . Thus each twofold observation (xy) is the sum of six twofold elements, each of which is subject to a law of frequency represented in fig. 13; where the figures outside denote the number of successes of each kind, for the ordinate the number of dice with more than three points (out of a cast of two dice), for the co-ordinate the number of sixes (out of a cast of two dice, one of which is common to the aforesaid cast); and the figures inside denote the comparative probabilities of each twofold value (e.g. the probability of obtaining in the first two cast dice each with more than three points, and in the second cast two sixes, is $1/72$). Treating this law of frequency according to the rule which is proper to the normal law, we have (for the element) if the sides of the compartments each = i

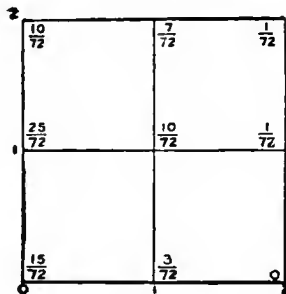

FIG. 13.

number of sixes (out of a cast of two dice, one of which is common to the aforesaid cast); and the figures inside denote the comparative probabilities of each twofold value (e.g. the probability of obtaining in the first two cast dice each with more than three points, and in the second cast two sixes, is $1/72$). Treating this law of frequency according to the rule which is proper to the normal law, we have (for the element) if the sides of the compartments each = i

$$\sigma_1 = i\sqrt{5/18}; \sigma_2 = i/\sqrt{2}; r = 1/\sqrt{20}.$$

Whence for the regression-equation which gives the value of the ordinate most probably associated with an assigned value of the abscissa we have $y = x \times r \sigma_2 / \sigma_1 = 0.3x$; and for the other regression-equation, $x = y/6$. Accordingly, in Professor Weldon's statistics, which are reproduced in the annexed diagram, when $x=3$ the

	0	1	2	3	4	5	6	7	8	9	10	11	12
12					1								
11		4	3	3	3	1							
10	3	17	15	13	10	4	3	1					
9	12	51	59	61	36	14	5	3					
8	36	135	154	150	64	21	5	2	1				
7	74	195	260	179	112	35	5	1					
6	90	248	254	170	75	26	3						
5	93	220	230	124	51	8	2						
4	86	162	127	75	19	4	1						
3	37	86	56	17	6	2							
2	14	23	23	4	3								
1	2	4											
0													

most probable value of y ought to be 1. And in fact this expectation is verified, x and y being measured along lines drawn through the centre of the compartment, which ought to have the maximum of content, representing the concurrence of one dozen with two sixes and another dozen with six dice having each more than three points, the compartment which in fact contains 254 (almost the maximum content). In the absence of observations at $x = -3i$ or $y = \pm 6i$, the regression-equations cannot be further verified. At least they have begun to be verified by batches composed of six elements, whereas they are not verifiable at all for the simple elements. The normal formula describes the given statistics as they behave, not when by themselves, but when massed in crowds: the regression-equation does not tell us that if x' is the magnitude of one member the most probable magnitude of the other member associated therewith is rx' , but that if x' is the average of several samples of the first member, then rx' is the most probable average for the specimens of the other member associated with those samples. Mr Yule's proposal to construct regression-equations according to the normal rule "without troubling to investigate the normality of the distribution" admits of this among other explanations.² Mr Yule's own view of the subject is well worthy of attention.

¹ Cf. above, par. 115. ² Proc. Roy. Soc., vol. 60, p. 477.
³ Below, par. 168.

154. In the determination of the standard-deviation proper to the law of error (and other constants proper to other laws of frequency) it commonly happens that besides the inaccuracy, *Sheppard's Corrections*. which has been estimated, due to the paucity of the data, there is an inaccuracy due to their discrete character: the circumstance that measurement, e.g. of human heights, are given in comparatively large units, e.g. inches, while the real objects are more perfectly graduated. Mr Sheppard has prescribed a remedy for this imperfection. For the standard deviation let μ_2 be the rough value obtained on the supposition that the observations are massed at intervals of unit length (not spread out continuously, as ideal measurements would be); then the proper value, the mean integral of deviation squared, say $(\mu_2) = \mu_2 - \frac{1}{2}h^2$, where h is the size of a unit, e.g. an inch. It is not to be objected to this correction that it becomes nugatory when it is less than the probable error to which the measurement is liable on account of the paucity of observations. For, as the correction is always in one direction, that of subtraction, it tends in the long run to be advantageous even though masked in particular instances by larger fluctuating errors.⁴

155. Professor Pearson has given a beautiful application of the theory of correlation to test the empirical evidence that a given group conforms to a proposed formula, e.g. the normal law of error.⁵

Supposing the constants of the proposed function to be known—in the case of the normal law the arithmetic mean and modulus—we could determine the position of any percentile, e.g. the median, say a . Now the probability that if any sample numbering n were taken at random from the complete group, the median of the sample, a' , would lie at such a distance from a that there should be r observations between

$$a \text{ and } a' \text{ is } \int_r^\infty \sqrt{2/\pi n} \exp -2r^2/n. \text{ } ^6$$

If, then, any observed set has an excess which makes the above written integral very small, the set has probably not been formed by a random selection from the supposed given complete group. To extend this method to the case of two, or generally n , percentiles, forming $(n+1)$ compartments, it must be observed that the excesses say e and e' , are not independent but correlated. To measure the probability of obtaining a pair of excesses respectively as large as e and e' , we have now (corresponding to the extremity of the probability-curve in the simple case) the solid content of a certain probability-surface outside the curve of equal probability which passes through the points on the plane xy assigned by e, e' (and the other data). This double, or in general multiple, integral, say P , is expressed by Professor Pearson with great elegance in terms of the quadratic factor, called by him χ^2 , which forms the exponent of the expression for the probability that a particular system of the values of the correlated $e, e', \&c.$, should occur—

$$P = \sqrt{2/\pi} \int_x^\infty e^{-\lambda^2} d\lambda + \sqrt{\frac{2}{\pi}} e^{-\lambda^2} \left[\frac{\lambda}{1} + \frac{\lambda^3}{1 \cdot 3} + \dots + \frac{\lambda^{n-2}}{1 \cdot 3 \dots (n-2)} \right]$$

when n is odd; with an expression different in form, but nearly coincident in result, when n is even. The practical rule derived from this general theorem may thus be stated. Find from the given observations the probable values of the coefficients pertaining to the formula which is supposed to represent the observations. Calculate from the coefficients a certain number, say n , of percentiles; thereby dividing the given set into $n+1$ sections, any of which, according to calculation, ought to contain say m of the observations, while in fact it contains m' . Put e for $m' - m$; then $\chi^2 = \Sigma e^2/m$. Professor Pearson has given in an appended table the values of P corresponding to values of $n+1$ up to 20, and values of χ^2 up to 70. He does not conceal that there is some laxity involved in the circumstance that the coefficients employed are not known exactly, only inferred with probability.⁷

156. Here is one of Professor Pearson's illustrations. The table on next page gives the distribution of 1000 shots fired at a line in a target, the hits being arranged in belts drawn on the target parallel to the line. The "normal distribution" is obtained from a normal curve, of which the coefficients are determined from the observations. From the value of χ^2 , viz. 45.8, and of $(n+1)$, viz. 11, we deduce, with sufficient accuracy from Professor Pearson's table, or more exactly from the formula on which the table is based, that $P = .000,001,5 \dots$. "In other words, if shots are distributed on a target according to the normal law, then such a distribution as that cited could only be expected to occur on an average some 15 or 16 times in 10,000,000 times."

157. "Such a distribution" in this argument must be interpreted as a distribution for which it is claimed that the observations are all independent of each other. Suppose that there were only 500 independent observations, the remainder being merely duplicates of these 500. Then in the above

⁴ Just as the removal of a tax tends to be in the long run beneficial to the consumer, though the benefit on any particular occasion may be masked by fluctuations of price due to other causes.

⁵ Phil. Mag. (July, 1900).

⁶ As shown above, par. 103.

⁷ Loc. cit. p. 166.

The Criterion Criticized.

table the columns for the normal distribution and for the discrepancy e should each be halved; and accordingly the column for e^2/m should be halved. Thus e^2/m being reduced to 22.9, P as found from Professor Pearson's table is between 995 and 629. That is, such a distribution might be expected to occur once on an average some once or twice in a hundred times. If actual duplication of this sort is not common in statistics,¹ yet in all such applications of the

Belt.	Observed Frequency.	Normal Distribution.	e .	e^2/m .
1	1	1	0	0
2	4	6	-2	0.667
3	10	27	-17	10.704
4	89	67	+22	7.224
5	190	162	+28	4.839
6	212	242	-30	3.719
7	204	240	-36	5.400
8	193	157	+36	8.255
9	79	70	+9	1.157
10	16	26	-10	3.846
11	2	2	0	0
	1000	1000	—	45.811

Pearsonian criterion—and in other calculations involving the number of observations, in particular the determinations of probable error—a good margin is to be left for the possibility that the n observations are not perfectly independent: e.g. the accidents of wind or nerve which affected one shot may have affected other shots immediately before or after.

158. (2) *The Generalized Law of Error.*—That the normal law of error should not be exactly fulfilled is not disconcerting to those who ground the law upon the plurality of independent causes. On that view the normal law would only be exact when the numbers of elements from which it is generated is very great. In general, when that number is large, but not indefinitely great,² there is required a correction owing to one or other of the following imperfections: that the elements do not fluctuate according to the normal law of frequency; that their fluctuations are not independent of each other; that the function whereby they are aggregated is not linear. The correction is formed by a series of terms descending in the order of magnitude.

159. The first term of this series may be written

$$-2(k/c^3)[x/c - 2x^3/3c^3];$$

where $c^2/2$ is the mean square of deviation for the compound and also the sum of the mean squares of deviations for the component elements, k_1 is the mean cube of deviations for the compound and the sum of the mean cubes for the components, and the elements are supposed to be such and so numerous that k_1/c^3 is of the order $1/\sqrt{n}$.

Second and Third Approximations.

This second approximation, first given by Poisson, was rediscovered by De Forest.³ The present writer has obtained it⁴ by a variety of methods. By a further extension of these methods a third and further approximations may be found. The corrected normal law is then of the form⁵

$$z = \frac{1}{\sqrt{\pi c}} \left(\exp - \frac{x^2}{c^2} \right) \left[1 - 2k \left(\frac{x}{c} - \frac{2x^3}{3c^3} \right) + k^2 \left(-\frac{5}{3} + 10 \frac{x^2}{c^2} - \frac{20}{3} \frac{x^4}{c^4} + \frac{8}{9} \frac{x^6}{c^6} \right) + k_2 \left(\frac{1}{2} - 2 \frac{x^2}{c^2} + \frac{2}{3} \frac{x^4}{c^4} \right) \right];$$

where $k = k_1/c^3$, $k_2 = k_2/c^4$, k_1 and c are defined as above, k_2 is the sum of the respective differences for each element between its mean fourth power of error and thrice its mean square of error,⁶ and also the corresponding difference for the compound. The formula may be verified by the case of the binomial, considered as a simple case of the law of great numbers. Here

$$c^2 = 2npq, k_1 = npq(q-p), k_2 = npq(1-6pq).⁷$$

These values being substituted for the coefficients in the general formula, there results an expression which may be obtained directly by continuing⁸ to expand the expression for a term of the binomial.

In virtue of the second approximation a set of observations is not to be excluded from the affinity to the normal curve because, like the curve of barometric heights,⁹ it is slightly asymmetrical. In virtue of the third approximation it is not excluded because, like the group of shot-marks above examined, it is, though almost perfectly symmetrical, in other respects apparently somewhat abnormal.

160. If the third approximation is not satisfactory there is still available a fourth, or a still higher degree of approximation.¹⁰ The general expression for y which (multiplied by Δx) represents the probability that an error will occur at a particular point (within a particular small interval) may be written

$$e^{-k_1 \frac{1}{3!} \left(\frac{d}{dx} \right)^3 + k_2 \frac{1}{4!} \left(\frac{d}{dx} \right)^4 - \dots + (-1)^t \frac{k_t}{(t+2)!} \left(\frac{d}{dx} \right)^{t+2} \dots y_0,$$

where y_0 is (the normal error-function) $\frac{1}{\sqrt{2k\pi}} e^{-x^2/2k}$, k is the

mean square of deviation; k_1, k_2, \dots , &c., are coefficients formed from the mean powers of deviation according to the rule that k_t is the difference between the t th mean power as it actually is and what it would be if the $(t-1)$ th approximation were perfectly correct. Thus k_1 is the difference between the actual mean third power and what the third power would be if the first approximation, the normal law, were perfectly correct, that is, the difference between the actual mean third power, often written μ_3 , and zero, that is μ_3 . Similarly k_2 is the difference between the actual mean fourth power of deviation, say μ_4 , and what that mean power would be if the second approximation were perfectly correct, viz. $3k^2$. Thus $k_2 = \mu_4 - 3k^2$. The series k_1, k_2, k_3 , &c., k, k_2, k_4 , &c., form each a succession of terms descending in the order of magnitude, when each k_t , e.g. k_1 has been divided by the corresponding power, i.e. the power $(t+2)$ of the parameter or modulus $c = \sqrt{2k}$, which division is secured by the successive differ-

entiations of y_0 , with which each k is associated, e.g. k_1 with $\left(\frac{d}{dx} \right)^{t+2}$.

Moreover, the first term of the odd series of k 's when divided by the proper power of the parameter, viz. c^3 is small in comparison with the first term of the even series, viz. k , properly referred—divided by $c^2 (= 2k)$.

161. Whatever the degree of approximation employed, it is to be remembered that the law in general is only applicable to a certain range of the compound magnitude here represented by the abscissa x .¹¹ The curve of error, even when generalized as here proposed, coincides only with the central portion—the body, as distinguished from the extremities—of the actual locus; a greater or less proportion.

162. The law thus generalized may be extended, with similar reservations, to two or more dimensions. For example, the second approximation in two dimensions may be written

$$z_0 - \frac{1}{3!} \left(3_0 k \frac{d^2 z_0}{dx^2} + 3_{21} k \frac{d^2 z_0}{dx^2 dy} + 3_{12} k \frac{d^2 z_0}{dx dy^2} + 0_3 k \frac{d^2 z_0}{dy^2} \right);$$

Extension to Two or More Dimensions.

$$\frac{1}{\pi(1-1^2)} \exp. - \frac{(x^2 - 2rxy + y^2)}{(1-r^2)},$$

x and y are (as before) co-ordinates measured from the centre of gravity of the group as origin, each referred to (divided by) its proper modulus; r is the ordinary coefficient of regression; $3_0 k$ is the mean value of the cubes x^3 , $3_{21} k$ is the mean value of the products $x^2 y$, and so on; all these k 's being quantities of an order less than unity. This form lends itself readily to the determination of a second approximation to the regression-curve, which is the locus of that y , which is the most probable value of the ordinate corresponding to an assigned value of x . Form the logarithm of the above-written expression (for the frequency-surface); and differentiate that logarithm with respect to x . The required locus is given by equating this

¹ It is frequent in the statistics of wages.
² See on this subject, in addition to the paper on the "Law of Error" already cited (*Camb. Phil. Trans.*, 1905), another paper by the present writer, on "The Generalized Law of Error," in the *Journ. Stat. Soc.* (September, 1906).
³ *The Analyst* (Iowa), vol. ix.
⁴ *Phil. Mag.* (Feb., 1896) and *Camb. Phil. Trans.* (1905).
⁵ The part of the third approximation affected with k^2 may be found by proceeding to another step in the method described (*Phil. Mag.*, 1896, p. 96). The remaining part of the third approximation is found by the same method (or the variant on p. 97) from the

new partial differential equation $\frac{dy}{dx} = \frac{1}{24} \frac{d^4 y}{dx^4}$, where k_2 is the difference between the actual mean fourth power of deviation and what it would be if the normal law held good. Further approximations may be obtained on the same principle.
⁶ $\mu_4 - 3\mu_2^2$ in the notation which Professor Pearson has made familiar.
⁷ Cf. Pearson, *Trans. Roy. Soc.* (1895), A, clxxxvi. 347.

⁸ Above, § 103, referring to Todhunter, *History*, art. 993. The third (or second additional term of) approximation for the binomial, given explicitly by Professor Pearson, *Trans. Roy. Soc.* (1895), A, footnote of p. 347, will be found to agree with the general formula above given, when it is observed that the correction affecting the absolute term, his y_0 , disappears in his formula by division.
⁹ *Journ. Stat. Soc.* (1899), p. 550, referring to Pearson, *Trans. Roy. Soc.* (1898), A.

¹⁰ Practically no doubt the law is not available beyond the third or fourth approximation, for a reason given by Pearson, with reference to his generalized probability-curve, that the probable error incident to the determination of the higher moments becomes very great.
¹¹ This consideration does not present the determination of the true moments from the complete set of observations if homogeneous, according as the system of elements fulfils more or less perfectly certain conditions.

differential to zero (the second differential being always negative). The resulting equation is of the form

$$y - rx - T - ax^2 - 2\beta xy - \gamma y^2 = 0,$$

where T, α, β, γ are all small, linear functions of the k 's. As y is nearly equal to rx , it is legitimate to substitute rx for y , when y is multiplied by a small coefficient. The curve of regression thus reduces to a parabola with equation of the form

$$y - T = rx - qx^2;$$

where q is a linear function of the third mean powers and moments of the given group.

163. *Dissociation of certain Heterogeneous Groups.*—Under the head of law of error may be placed the case in which statistics relating to two (or more) different types, each separately conforming to the normal law, are mixed together; for instance, the measurements of human heights in a country comprising two distinct races.

In this case the *quaesita* are the constants in a curve of the form:

$$y = \alpha(1/\sqrt{\pi c_1}) \exp - (x-a)^2/c_1^2 + \beta(1/\sqrt{\pi c_2}) \exp - (x-b)^2/c_2^2,$$

where α and β are the proportionate sizes of the two groups ($\alpha + \beta = 1$); a and b are the respective centres of gravity; and c_1, c_2 the respective moduli. The data are measurements each of which relates to one or other of these component curves. A splendid solution of this difficult problem has been given by Professor Pearson. The five unknown quantities are connected by him with the centre of gravity of the given observations, and the mean second, third, fourth and fifth powers of their deviations from that centre of gravity, by certain rational algebraic equations, which reduce to an equation in one variable of the *ninth* dimension. In an example worked by Professor Pearson this fundamental equation had three possible roots, two of which gave very fair solutions of the problem, while the third suggested that there might be a *negative* solution, importing that the given system would be obtained by *subtracting* one of the normal groups from the other; but the coefficients for the negative solution proved to be imaginary. "In the case of crabs' foreheads, therefore, we cannot represent the frequency curve for their forehead length as the difference of two normal curves." In another case, which *prima facie* seemed normal, Professor Pearson found that "all nine roots of the fundamental nomic lead to imaginary solutions of the problem. The best and most accurate representation is the normal curve."

164. This laborious method of separation seems best suited to cases in which it is known beforehand that the statistics are a mixture of two normal groups, or at least this is strongly suggested by the two-headed character of the given group. Otherwise the less troublesome generalized law of error may be preferable, as it is appropriate both to the mixture of two—not very widely different—normal groups, and also the other cases of composition. Even when a group of statistics can be broken up into two or three frequency curves of the normal—or not very abnormal—type, the group may yet be adequately represented by a single curve of the "generalized" type, provided that the heterogeneity is not very great, not great enough to prevent the constants k_1, k_2, k_3 , &c., from being small. Thus, suppose the given group to consist of two normal curves each having the same modulus c , and that the distance between the centres is considerable, so considerable as just to cause the central portion of the total group to become saddle-backed. This phenomenon sets in when the distance between the centre of gravity of the system and the centre of either component $= \sqrt{1/2}c$.¹ Even in this case k_2 is only -0.125 ; k_4 is 0.25 (the odd k 's are zero).

Section II.—Laws of Frequency.

165. A formula much more comprehensive than the corrected normal law is proposed by Professor Pearson under the designation of the "generalized probability-curve." "Generalized Probability Curve." The ground and scope of the new law cannot be better stated than in the words of the author: "The slope of the normal curve is given by a relation of the form

$$\frac{1}{y} \frac{dy}{dx} = -\frac{x}{c_1}.$$

The slope of the curve correlated to the skew binomial, as the normal curve to the symmetrical binomial, is given by a relation of the form

$$\frac{1}{y} \frac{dy}{dx} = -\frac{x}{c_1 + c_2 x}.$$

Finally, the slope of the curve correlated to the hypergeometrical series (which expresses a probability distribution in which the contributory causes are not independent, and not equally likely to give equal deviations in excess and defect), as the above curves to their respective binomials, is given by a relation of the form

¹ Cf. *Journ. Stat. Soc.* (1899), lxii. 131. A similar substitution of the generalized law of error may be recommended in preference to the method of translating a normal law of error (putting $x=f(x)$, where x obeys the normal law of error) suggested by the present writer (*Journ. Stat. Soc.*, 1898), and independently by Professor J. C. Kapteyn (*Skew Frequency Curves*, 1903).

$$\frac{1}{y} \frac{dy}{dx} = -\frac{x}{c_1 + c_2 x + c_3 x^2}.$$

This latter curve comprises the two others as special cases, and, so far as my investigations have yet gone, practically covers all homogeneous statistics that I have had to deal with. Something still more general may be conceivable, but I have found no necessity for it." The "hypergeometrical series," it should be explained, had appeared as representative of the distribution of black balls, in the following case. "Take n balls in a bag, of which pn are black and qn are white, and let r balls be drawn and the number of black be recorded. If $r > pn$, the range of black balls will lie between 0 and pn ; the resulting frequency-polygon is given by a hypergeometrical series."

Further reasons in favour of his construction are given by Professor Pearson in a later paper.⁴ "The immense majority, if not the totality, of frequency distributions in homogeneous material show, when the frequency is indefinitely increased, a tendency to give a smooth curve characterized by the following properties. (i.) The frequency starts from zero, increases slowly or rapidly to a maximum and then falls again to zero—probably at a quite different rate—as the character for which the frequency is measured is steadily increased. This is the almost universal unimodal distribution of the frequency of homogeneous series. . . (ii.) In the next place there is generally contact of the frequency-curve at the extremities of the range. These characteristics at once suggest the following of frequency curve, if $y \delta x$ measure the frequency falling between x and $x + \delta x$ —

$$\frac{dy}{dx} = \frac{y(x+a)}{F(x)} \dots$$

Now let us assume that $F(x)$ can be expanded by Maclaurin's theorem. Then our differential equation to the frequency will be

$$\frac{1}{y} \frac{dy}{dx} = \frac{x+a}{b_0 + b_1 x + b_2 x^2 + \dots}$$

Experience shows that the form (x) ["keeping b_0, b_1, b_2 , only"] suffices for certainly the great bulk of frequency distributions."⁶

166. The "generalized probability-curve" presents two main forms⁸—

$$y = y_0(1 + x/a_1)^{\nu a_1} (1 - x/a_2)^{\nu a_2},$$

$$\text{and } y = y_0 \frac{1}{(1 + x^2/a^2)^{\nu}} e^{-\nu \tan^{-1} x/a}.$$

When a_1, a_2, ν are all finite and positive, the first form represents, in general, a skew curve, with limited range in both directions; in the particular case, when $a_1 = a_2$, a symmetrical curve, with range limited in both directions. If $a_2 = \infty$, the curve reduces to

$$y = y_0(2 + x/a_1)^{\nu a_1} e^{-\nu x/a_1};$$

representing an asymmetrical binomial with $\nu = 2\mu_2/\mu_3$, and $2_1 = 2\mu_2^2/\mu_3 - a\mu_3/\mu_3$, μ_2 and μ_3 , being respectively the mean second and mean third power of deviation measured from the centre of gravity. In the particular case, when μ_2 is small, this form reduces to what is above called the "quasi-normal" curve; and when μ_2 is zero, a_1 becoming infinite, to the simple normal curve. The pregnant general form yields two less familiar shapes apt to represent curves of the character shown in figs. 14 and 15—the one occurring in a



FIG. 14.

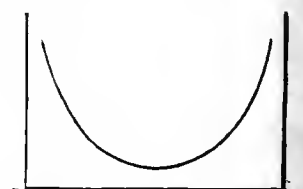

FIG. 15.

good number of instances, such as infant deaths, the values of houses, the number of petals in certain flowers; the other less familiarly illustrated by *Consumptivity* and *Cloudiness*.⁷ The second solution represents a skew curve with unlimited range in both directions.⁸ Professor Pearson has successfully applied these formulae to a number of beautiful specimens culled in the most diverse fields of statistics. The flexibility with which the generalized probability-curve adapts itself to every variety of existing groups no doubt gives it a great advantage over the normal curve, even in its extended form. It is only in respect of a priori evidence that the latter can claim precedence.⁹

167. *Skew Correlation.*—Professor Pearson has extended his

² *Trans. Roy. Soc.* (1895), A, p. 381. ³ *Ibid.* p. 360.
⁴ "Mathematical Contributions to the Theory of Evolution" (*Drapers' Company Research Memoirs, Biometric Series II.*), xiv. 4.
⁵ p. 7, *loc. cit.* ⁶ *Ibid.* p. 367.
⁷ Pearson, *loc. cit.*, p. 364, and *Proc. Roy. Soc.*
⁸ A lucid exposition of Professor Pearson's various methods is given by W. Palin Elderton in *Frequency-curves and Correlation* (1906).
⁹ *Journ. Stat. Soc.* (1895), p. 506.

method to frequency-loci of two dimensions;¹ constructing for the curve of regression (as a substitute for the normal right line), in the case of "skew correlation," a parabola,² with constants based on the higher moments of the given group.

168. In this connexion reference may again be made to Mr Yule's method of treating skew surfaces as if they were normal. It is certainly remarkable that the correlation should be so well represented by a line—the property of a normal surface—in cases of which normality cannot be predicated: for instance, the statistics of the number of husbands (or wives) living at each age who have wives (or husbands) living at different ages.³ It may be suggested that though in this case there is one dominant cause, the continual decrease of the population, inconsistent with the plurality of causes postulated for the law of error, yet there is a sufficient degree of accidental variation to realize one property at least of the normal locus.

169. There is possibly an extensive class of phenomena of which frequency depends largely on fortuitous causes, yet not so completely as to present the genuine law of error.⁴ This mixed class of phenomena might be amenable to a kind of law of frequency that would be different from, yet have some affinity to, the law of error. The double character may be taken as the definition of the laws proper to the present section. The definition of the class is more distinct than its extent. Consider for example the statistics which represent the numbers out of a million born that die in each year of age after thirty or forty—the latter part of the column in a life-table. These are well represented by a species of Professor Pearson's "generalized probability-curve,"⁵ his type iii. of the form

$$y = y_0 (1 + x/a)^{\gamma a} e^{-\gamma x}.$$

The statistics also lend themselves to the Gompertz-Makeham formula for the number living at the age

$$l_x = S^2 g^{x/c}.$$

The former law, the simplest species of the "generalized probability-curve," may well be attributed in part to the operation of a plexus of causes such as that which is apt to generate the law of error. In fact, a high authority, Professor Lexis, has seen in these statistics—or continental statistics *in pari materia*—a fulfilment of the normal law of error.⁶ They at least fulfil tolerably the generalized law of error above described. But the Gompertz-Makeham formula is not thus to be accounted for; at least it is not thus that it was regarded by its discoverers. Gompertz justifies his law⁷ by a "hypothetical deduction congruous with many natural effects," such as the exhaustion of air by a pump; and Makeham follows⁸ in the same track of explanation by way of natural laws. Of course it is not denied that mortality is subject to accident. But the Gompertz-Makeham law purports to be fulfilled in spite of, not by reason of, fortuitous agencies. The formula is accounted for not by the interaction of fleeting causes which is characteristic of probability, but by causes of that ordinary kind of which the investigation constitutes the greater part of natural science. Laws of frequency thus conceived do not belong to the theory of Probabilities.

AUTHORITIES.—As a comprehensive and masterly treatment of the subject as a whole, in its philosophical as well as mathematical character, there is nothing similar or second to Laplace's *Théorie analytique des probabilités*. But this "ne plus ultra of mathematical skill and power" as it is called by Herschel (*Edinburgh Review*, 1850) is not easy reading. Much of its difficulty is connected with the use of a mathematical method which is now almost superseded,

"Generating Functions." Not all parts of the book are as rewarding as the Introduction (published separately as *Essai philosophique des probabilités*) and the fourth and subsequent chapters of the second book. Among numerous general treatises E. Czuber's *Wahrscheinlichkeitstheorie* (1899) may be noticed as terse, lucid and abounding in references. Other authorities may be mentioned in relation to the different parts of the subject as above divided. First principles are discussed with remarkable acumen by J. Venn in *Logic of Chance* (1st ed., 1876, 3rd ed., 1888) and by J. v. Kries in *Prinzipien der Wahrscheinlichkeitsrechnung* (1886). As a repertory of neat problems involving the calculation of probability and expectation W. A. Whitworth's *Choice and Chance* (5th ed., 1901), and *DCC. Exercices . . . in Choice and Chance* (1897) deserve mention. But this advantage is afforded in nearly as great perfection by more comprehensive works. Bertrand's *Calcul des probabilités* (1889) abounds in choice examples, while it excels in almost every other branch of the subject. Special mention is also deserved by H. Poincaré's *Calcul des probabilités (leçons professées, 1893-1894)*. On local or geometrical probability Professor Morgan Crofton is one of the highest authorities. His paper on "Local Probability" in *Phil. Trans.* (1868), and on "Geometrical Theorems," *Proc. Lond. Math. Soc.* (1887), viii., should be read in connexion with the section on "Local Probability" in his article on "Probability" in the 9th edition of the *Ency. Brit.*, from which section several paragraphs have been transferred *en bloc* to the section on Geometrical Applications in the present article. The topic is treated exhaustively by Czuber in *Geometrische Wahrscheinlichkeiten und Mittelworte* (1884). Czuber is also to be mentioned as the author of *Theorie der Beobachtungsfehler*, in which he has reproduced, often with improvement, or referred to, almost everything of importance in the work of his predecessors. A. L. Bowley's *Elements of Statistics*, pt. 2 (2nd ed., 1902), forms an introduction to the law of error which leads the beginner easily, yet far. References to other writers are given in Section I. of Part II. above. A list of writings on the cognate topic, the method of least squares, has been given by Merriman (*Connecticut Trans.* vol. iv.). On laws of frequency, as above defined, Professor Karl Pearson is the highest authority. His "Contributions to the Mathematical Theory of Evolution," of which twelve have appeared in the *Trans. Roy. Soc.* (1894-1903) and others are being published by the Drapers' Company, teem with new theories in Probabilities. (F. Y. E.)

PROBATE, in English law, the "proving" (Lat. *probatio*) of a will. The early jurisdiction of the English ecclesiastical courts over the probate of wills of personality is discussed under WILL. The Court of Probate Act 1857 transferred the jurisdiction both voluntary and contentious of all ecclesiastical, royal peculiar, peculiar and manorial courts to the court of probate thereby constituted, created a judge and registrars of that court, abolished the old exclusive rights in testamentary matters of the advocates of Doctors' Commons, and laid down rules of procedure. Contentious jurisdiction was given to county courts when the personal estate of the deceased was under £200 in value. The Judicature Act 1873 merged the old court of probate in the probate divorce and admiralty division of the High Court of Justice. The division now consists of the president and one other judge. The practice of the division is mainly regulated by the rules of the Supreme Court 1883. Appeals lie to the court of appeal and thence to the House of Lords. Probate may be taken out either in *common* or *solemn* form. In the former case, which is adopted when there is no dispute as to the validity of the will, the court simply recognizes the will propounded as the last will of the deceased. This formality is necessary to enable the executor to administer the estate of his testator. Probate in this form is granted simply as a ministerial act if the attestation clause declares that the formalities of the Wills Act have been complied with, or if other evidence to that effect is produced. Such grant is liable to revocation, but it is provided that any person dealing with an executor on the faith of a grant of probate in common form, shall not be prejudiced by its revocation. The executor may within thirty years be called upon to prove in solemn form, or a person who doubts the validity of the will propounded may enter a caveat which prevents the executor proving for six months and the caveat may be renewed each six months. The executor may however take out a summons to get the caveat "subducted" or withdrawn, but if an appearance to the summons is entered

⁹ These initials do not apply to certain passages in the above article, namely, the greater part of paragraphs 41, 52, 62 and 72, and almost the whole of the 4th section of Part. I. (pars. 76-93), which have been adopted from the article "Probability" in the 9th edition of the *Ency. Brit.*, written by Professor Morgan Crofton.

¹ "Contributions," No. xiv. (above cited).
² Not the same parabola as that proposed at par. 162.
³ *Census of England and Wales General Report* (cod. 2174), p. 226. Cf. p. 70, as to the rationale of the phenomenon.
⁴ A good example of the suggested blend between law and chance is presented by an hypothesis which Benine (in a passage referred to above, par. 97) has proposed to account for Pareto's income-curve.
⁵ "Contributions," No. ii., *Phil. Trans.* (1895), vol. 186, A.
⁶ Lexis, *Massenerscheinungen*, § 46. Cf. Venn, cited above, par. 124.
⁷ *Phil. Trans.* (1-25).
⁸ *Assurance Magazine* (1866), xi. 315.

within six days to the summons the executor is then compelled to prove in solemn form. Probate in *solemn* form is a judgment of the court in favour of the will propounded, and is only revocable by the discovery of a later will. In order, therefore, to obtain such grant proceedings have to be taken by action, and witnesses produced in support of the will, and the action proceeds in the usual way.

The principal rules now obtaining as to probate are these. Probate, which since the Land Transfer Act 1897 must be taken out for wills of realty as well as wills of personalty, may be granted either in the principal or in a district registry, and should be obtained within six months after the testator's death. When no executor is named the will is not now invalid, as was once the case, but administration *cum testamento annexo* is granted. The same course is pursued where the executor renounces or dies intestate before administering the estate of the deceased. After probate, the probate itself (as the official copy of the will is called) becomes evidence, the original will being deposited in the principal registry at Somerset House, London. On grant of probate, estate duty, denoted by a stamp on the affidavit sworn for that purpose, is payable. It varies according to the amount at which the estate of the deceased is fixed by the oath of the executor (see ESTATE DUTY). The act of 1881 enables any officer of inland revenue to grant probate where the personal estate does not exceed £300.

Ireland.—In 1867 an act on lines similar to the English act was passed for Ireland and under the Irish Judicature Act of 1877 the then existing court of probate was merged in the High Court of Justice.

Scotland.—Confirmation includes both the probate and letters of administration of English procedure. Without confirmation by the court interference by the executor becomes a vitious intromission. Originally confirmation of testaments of movables fell, as in England, under the cognizance of the church courts. Such jurisdiction certainly existed at the time of *regiam majestatem*. This ecclesiastical right continued through the commissary court at Edinburgh (constituted by Queen Mary in 1563), and the local commissaries, until modern times when the jurisdiction of the courts was at first transferred and then abolished by a series of enactments from the Commissary Courts Act 1823 to the Sheriff Courts Act 1876. The act of 1823 placed the commissary jurisdiction in the sheriff courts; by the act of 1876 the sheriffs sit as sheriffs in testamentary matters, no longer as commissaries. Confirmation of wills where the whole estate is under £300 is regulated by the Customs and Inland Revenue Act 1881 and other acts. An aik is an addition to a confirmation made on discovery of additional effects of the deceased after confirmation.

United States.—Probate is granted in some states by the ordinary chancery or common law courts, but more frequently by courts of special jurisdiction, such as the prerogative court in New Jersey, the surrogates' court in New York, the orphans' court in Pennsylvania.

"In a great majority of the states the original equitable jurisdiction over administrations is in all ordinary cases—without any special circumstances such as fraud, or without any other equitable feature such as trust—either expressly or practically abrogated. The courts of equity, in the absence of such special circumstances or distinctively equitable features, either do not possess or will not exercise the jurisdiction, but leave the whole matter of administrations to the special probate tribunals" . . . so that "unless the case involves some special feature or exceptional circumstances of themselves warranting the interference of equity, such as fraud, waste, and the like, or unless it is of such an essential nature that a probate court is incompetent to give adequate relief, or is one of which the probate court having taken cognizance has completely miscarried and failed to do justice by its decree, the courts of equity will refuse to interpose and to exercise whatever dormant powers they may possess, but will leave the subject matter and the parties to the statutory forum which the legislature plainly regarded as sufficient and intended to be practically exclusive" (Rice's *Probate Law*, pp. 4 and 5).

Probate courts are in most if not all the states courts of record, having a public seal and a clerk (or the judge has authority to act as clerk); they issue process and execute their decrees by appropriate officers in the same manner as the common law and chancery courts. They sit at stated terms. They have power to punish for contempt, and to compel obedience to their orders and decrees, and their judgments upon matters within their jurisdiction are enforced usually by the same means as common

law and chancery courts (Noemen's *Law of Administration*, § 145).

Jurisdiction as to wills and their probate as such is neither included in nor excepted out of the grant of judicial power to the courts of the United States (*i.e.* the *Federal* as distinguished from the state courts). So far as it is *ex parte* and merely administrative it is not conferred, and it cannot be exercised by them at all until in a case at law or in equity its exercise becomes necessary to settle a controversy by reason of the (diverse) citizenship of the parties. An action to set aside the probate of a will of real estate may be maintained in a Federal court when the parties on one side are citizens of a different state from the parties on the other side (*Ellis v. Davis*, 109 U.S. Reports, 485). Probate in solemn form, *i.e.* after due notice to all parties in interest is the almost universal form in use in the United States. One reason for this no doubt is that all documents affecting title to real estate must be recorded and probate in solemn form concludes all parties to the proceeding and thus tends to establish the title to all real estate passing under the will.

In the United States wills of real property must be separately proven in the proper probate court in each state in which the real property is situated, unless statute dispenses with separate probate (each state being "foreign" to every other for this purpose). Copies of such will and probate should be filed also in the office of the register of deeds of each county in the state in which any real property belonging to the testator is situated.

In the state of *New Jersey* it has been held that an unprobated will is capable of conveying an interest in the property devised, and when a conveyance is made under a power in the will before probate a subsequent probate validates the conveyance (1906, *Mackey v. Mackey*, 63 Atl. Rep. 984).

In *Illinois* a court of equity has no *inherent* power to entertain a bill to contest a will (1906; *O'Brien v. Bonfield*, 220 Ill. Rep. 219).

In *Missouri* a foreign (New York) will of real estate in Missouri, probate of which was duly recorded in Missouri, cannot be *collaterally* attacked, and cannot be set aside by direct proceeding after being filed for record more than five years in Missouri (1907; *Cohen v. Herbert*, 104 So. W. Rep. 84).

PROBATION. The probation system, in penology, is an attempt to reform a prisoner outside prison, a special kind of warder—the probation officer—supervising the prisoner in the prisoner's own home. The state of Massachusetts in America was the first to attempt "probation," and at first (1878) in a tentative manner. As success crowned the efforts of the reformers the system was developed and applied to an increasing number of cases; and gradually other American states followed with some variations in their plans. The probation officers attend the court and the judge officially gives up the prisoner to the officer chosen to supervise him, generally explaining to the prisoner that, if he is not obedient to all the rules made for him by the officer, he will be returned to court and prison will be his fate. An officer generally has from sixty to eighty cases under his care. Women officers are in charge of women and boys and girls under eighteen. A probation officer has a special area of the town allotted to him and usually gets all prisoners from that area. He acquires an intimate knowledge of the physical, economic and social surroundings in which his prisoner lives. He is therefore well fitted to watch him and to help him to become once more a decent citizen. He gradually gives him back his liberty and removes restrictions until he is capable of living a decent life alone. The powers of the probation officer are necessarily very great. The prisoner continues his work as before, but the officer visits his factory or workshop and arranges to receive his wages each week, passing over the greater part of them to the wife to keep up the home, giving a very small sum to the prisoner for personal expenses, and retaining a small sum, which is paid back to the prisoner when he becomes a free man.

The advantages claimed for the probation system are these, that a number of independent well-paid probation officers, chosen for their knowledge of human nature and their skill in reforming it, can give personal attention to individual cases; the stigma of prison is avoided, and while great care is taken that the prisoner shall be strictly controlled and effectively

restrained, his self-respect is carefully developed; the family benefits, the home is not broken up, the wages still come in, and if the prisoner is a mother and a wife, it is, of course, most important that she should retain her place in the home; the prisoner does not "lose his job" nor his mechanical skill if he is a skilled workman. Lastly, the system is far cheaper than imprisonment. The prisoner keeps himself and his family, and one officer can attend to from 60 to 80 prisoners.

In the United Kingdom the probation system has been applied to young offenders by the Prevention of Crime Act 1908. That act empowered the prison commissioners to place offenders on licence from the Borstal Institution (see JUVENILE OFFENDERS) at any time after six months (in the case of a female, three months), if satisfied that there was a reasonable probability of their abstaining from crime and leading a useful and industrious life. The condition of their release is that they be placed under the supervision or authority of some society or person (named in the licence) willing to take charge of the case. This is, of course, only a limited application of the system of probation, for those detained in a Borstal Institution are offenders between the ages of sixteen and twenty-one who have been convicted of an indictable offence. It does not apply to those of full age, nor to those under twenty-one years of age who have been committed to prison for minor offences. It has been long held by English prison reformers that young persons under the age of twenty-one should not be committed to prison, unless for serious offences, but that they should be put under some system of probation. Legislation to this effect was foreshadowed by the home secretary in his speech on prison reform in the House of Commons on the 20th of July 1910.

PROBOSCIDEA (animals "with a proboscis"), the scientific name of the group of mammals represented at the present day only by the two species of elephant. Although here regarded as a sub-order of UNGULATA (*q.v.*), the group is sometimes accorded the rank of an order by itself.¹ The existing elephants are widely sundered from all other living mammals, and for a long time palaeontology afforded but little clue as to their ancestry. Discoveries made during the first few years of the 20th century in the Lower Tertiary deposits of the Fayum district of Egypt have, however, brought to light the existence of several kinds of primitive proboscideans which serve to link the group with other ungulates, and likewise apparently indicate affinity with the *Sirenia*.

The following are some of the leading characteristics of existing elephants. The combined upper lips and nose are produced into a long muscular, flexible and prehensile proboscis, or trunk, with the nostrils at its tip. The teeth consist of a pair of large upper permanently growing incisors or tusks; and a set of cheek-teeth having their crowns composed of a series of tall transverse vertical plates gradually increasing in number from the first to the last of the series; and only portions of two of these teeth being in use at any one time. There are no clavicles; and the limbs are stout, with their component segments placed nearly in a vertical line, and the upper segment, especially in the hind-limb, the longest; the radius and ulna are distinct, the latter articulating extensively with the carpus; the fibula and tibia also distinct; the astragalus very flat on both surfaces; and both front and hind feet short, broad and massive, with five toes (though the outer pair may be more or less rudimentary), all encased in a common integument, though with distinct, broad, short hoofs; third digit the largest. Two anterior venae cavae entering the right auricle. Stomach simple. A capacious caecum. Testes permanently abdominal. Uterus bicornuate. Placenta deciduate and zonary. Teats two, pectoral.

In order to understand the peculiar nature of the dentition, it is necessary to discuss to some extent those of the immediate ancestors of the true elephants, such as the mastodons (see **Dentition**. MASTODON). As regards the incisors, or tusks, which

project largely out of the mouth, and are of an elongated conical form and generally curved, these are composed mainly of solid dentine, the fine elastic quality and large mass of which renders it invaluable as "ivory" for commerce and the arts. A peculiarity of the dentine of the Proboscidea is that it shows, in transverse fractures or sections, fine lines proceeding in the arc of a circle from the centre

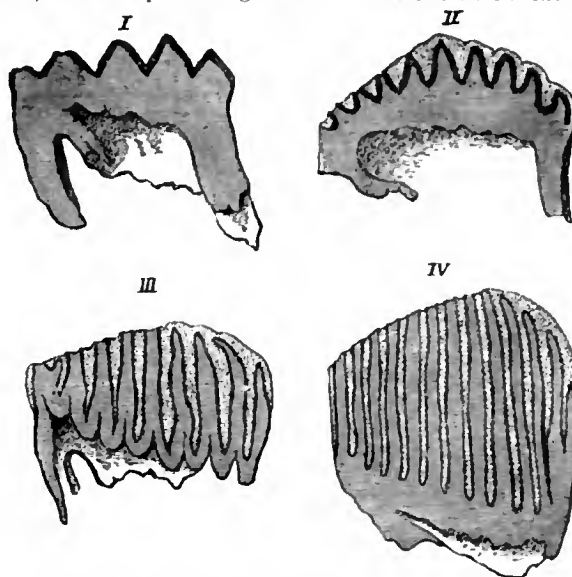

FIG. 1.—Longitudinal Sections of the Crowns of Molar Teeth of various Proboscideans, showing stages in the gradual modification from the simple to the complex form. The dentine is indicated by transverse lines, the cement by a dotted surface, and the enamel is black.

- | | |
|--|----------------------------------|
| I, <i>Mastodon americanus</i> ; | III, <i>Elephas africanus</i> ; |
| II, <i>Elephas (Stegodon) insignis</i> ; | IV, <i>Elephas primigenius</i> . |

to the circumference in opposite directions, and forming by their decussations curvilinear lozenges, as in the "engine-turning" of the case of a watch. The enamel-covering in existing species is confined to the extreme apex, and very soon wears off, but in some extinct species it forms persistent longitudinal bands of limited breadth. The tusks have small milk-predecessors, shed at an early age.

As regards the cheek-teeth, these are composed in the mastodons of a variable number of enamel-covered transverse ridges, often divided into inner and outer columns, which may partially alternate, and complicated by smaller additional columns; but in the unworn tooth they stand out freely on the surface of the crown, with deep valleys between (fig. 1, 1). In the elephants the ridges are increased in number, and consequently become narrower from before backwards, while they are greatly extended in vertical height. In order to give solidity to what would otherwise be a comb-like tooth, the whole structure is enveloped and united in a large mass of cement, which completely fills the valleys, and gives a general smooth appearance to the unworn tooth; but as the wear consequent upon the masticating process proceeds, the alternate layers of tissue of different hardness—cement, dentine and enamel—which are disclosed upon the surface form a fine and efficient grinding instrument. The intermediate stages between the molar of a modern elephant and that of a mastodon are so fully known that it is not possible to draw a definite line between the two types of tooth-structure (see fig. I, II, III, IV).

As regards the mode of succession, that of modern elephants is very peculiar. During the complete lifetime of the animal there are but six cheek-teeth, which it will be convenient to allude to as molars, on each side of each jaw, with occasionally a rudimentary one in front, completing the typical number of seven. The last three represent the molars of ordinary mammals, those in front are milk-molars, which are never replaced by permanent successors, the whole series gradually moving forwards in the jaw, and the teeth becoming worn away and their remnants cast out in front, while development of others proceeds behind. The individual teeth are so large, and the processes of growth and destruction by wear take place so slowly, that not more than one, or portions of two, teeth are ever in place and in use on each side of each jaw at one time, and the whole series of changes coincides with the usual duration of the animal's life. On the other hand, the earlier representations of the proboscidean series referred to below have the whole of the cheek-teeth in place and use at one time, and the milk-molars vertically displaced by premolars in the ordinary fashion. Among mastodons transitional forms occur in the mode of succession as well as in structure, many species showing a vertical displacement of one or more of the milk-molars, and the same has been observed

¹ Cuvier's order Pachydermata (Gr. *παχύς*, thick and *δέρμα*, skin), containing the elephants, hippopotami, rhinoceros, swine, tapirs, hyraxes, &c., is now abandoned, its members now forming the orders Proboscidea and Hyracoidea and the sub-order Parisso-dactyla. A few Artiodactyla are also included.

in one extinct species of true elephant (*Elephas planifrons*) as regards some of these teeth.

Most proboscideans are animals of large dimensions, and some are the most colossal of land mammals. The head is of great proportionate size; and, as the brain-case increases but little in bulk during growth, while the exterior wall of the skull is required to be of great superficial extent to support the trunk and the ponderous tusks, and to afford space for the attachment of muscles of sufficient size and strength to

**Physical
Character-
istics.**

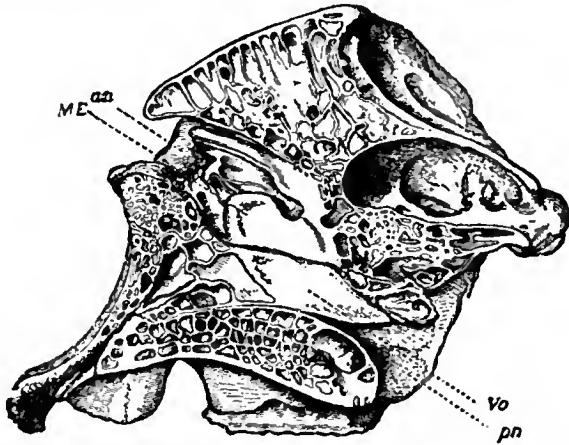

(Flower's Osteology of Mammalia.)

FIG. 2.—Section of the Skull of the African Elephant (*Elephas africanus*) taken to the left of the middle line, and including the vomer (*Vo*) and the mesethmoid (*ME*).

an, Anterior, *pn*, Posterior nasal aperture. ($\frac{1}{2}$ nat. size.)

wield the skull thus heavily weighted, an extraordinary development of air-cells takes place in the cancellous tissue of nearly all the bones of the cranium. These cells are not only formed in the walls of the cranium proper, but are also largely developed in the nasal bones and upper part of the premaxillae and maxillae, the bones forming the palate and the basi-cranial axis, and even extend into the interior of the ossified mesethmoid and vomer. Where two originally distinct bones come into contact, the cells pass freely from one to the other, and almost all the sutures become obliterated in old animals. The intercellular lamellae in the great mass which surrounds the brain-cavity superiorly and laterally mostly radiate from the inner to the outer table, but in the other bones their direction is more irregular. Like the similar but less developed air-cells in the skulls of many other mammals, they all communicate with the nasal passages, and they are entirely secondary to the original growth of the bones, their development having scarcely commenced in the new-born animal, and gradually enlarge as the growth of the creature proceeds. The nasal bones are very short, and the anterior nasal aperture situated high in the face. The zygomatic arch is slender and straight, the jugal bone being small, and forming only the middle part of the arch, the anterior part of which (unlike that of true Ungulates) is formed only by the maxilla. The maxillo-turbinates are rudimentary, the elongated proboscis supplying their place functionally in warming and clearing from dust the inspired air.

The neck is very short. The limbs, as already mentioned, are long and stout, and remarkable for the great length of the upper segment (especially the femur) as compared with the lower segment, as represented by the foot. It is owing to this and the vertical position of the femur that the knee-joint in the hind-leg is placed much lower, and is more conspicuous externally than in most quadrupedal mammals; and this having been erroneously compared with the hock-joint or ankle of the more ordinary ungulates, gave rise to the popular fallacy that the joints of the elephant's leg bend in a contrary direction to that of other mammals. There is no round ligament in the hip-joint, or third trochanter to the femur. The radius and ulna are distinct, though fixed in a crossed or prone position; and the fibula also is quite separated from the tibia. The feet are short and broad, the carpal and tarsal bones being very square, with flattened surfaces for articulation; the astragalus especially differs from that of the more typical ungulates in its flatness, in the absence of distinct pulley-like articular surface at either extremity, and in having no articular facet for the cuboid. The fibula articulates with the calcaneum, as in the artiodactyle sub-order of Ungulata. Of the five toes present on each foot, the middle one is somewhat the largest, while the lateral ones are the smallest, and generally lack (especially in the hind-foot) the complete number of phalanges. The terminal phalanges are all small, irregular in form, and late in ossification. The whole are encased in a common integument, with a flat, subcircular, truncated sole, the only external indication of the toes being the broad oval nails or hoofs arranged in a semicircle around the front edge of the

sole. The hind foot is smaller and narrower than the front. The liver is small and simple, and there is no gall-bladder. In form the brain resembles that of the lower orders of mammals in that the cerebellum is entirely behind and uncovered by the cerebrum, but the hemispheres of the latter are richly convoluted.

Elephants are exclusively vegetable-feeders, living chiefly on leaves and young branches of forest trees and various kinds of herbage, or roots, which they gather and convey to their mouth by a very mobile proboscis, an organ which combines in a marvellous manner strength with dexterity of application, and is a necessary compensation for the shortness and inflexibility of the neck, as it is by this that many of the functions of the lips of other animals are performed. By its means elephants are enabled to drink without bending the head or limbs. The end of the trunk being dipped, for instance, into a stream or pool, a forcible inspiration fills the two capacious air-passages in its interior with water, which, on the tip of the trunk being turned upwards and inserted into the mouth, is ejected by a blowing action, and swallowed. Or if the animal wishes to refresh and cool its skin, it can throw the water in a copious stream over any part of its surface. Elephants can also throw dust and sand over their bodies by the same means and for the same purpose, and they have frequently been observed fanning themselves with boughs held in the trunk.

The following are the distinctive features of the genus *Elephas*, the type of the family Elephantidae: Dentition: *i.* $\frac{1}{2}$, *c.* $\frac{1}{2}$, *m.* $\frac{3}{2}$ = 26. The incisors variable, but usually of very large size, especially in the male sex, directed somewhat outwards, and curved upwards, without enamel except on the apex before it is worn; preceded by small milk-incisors. The molars succeed each other by horizontal replacement from before backwards, never more than one or part of two being in use on each side of each jaw at the same time; each composed of numerous flattened enamel-covered plates or ridges of dentine, projecting from a common many-rooted base, surrounded and united together by cement. The number of plates increases from the anterior to the posterior molar in regular succession, varying in the different species, but the third and fourth (or the last milk-molar and the first true molar), and these only, have the same number of ridges, which always exceeds five. Skull of adult very high and globular. Lower jaw ending in front in a deflected, spout-like symphysis. Vertebrae: *C.* 7, *D.* 19-21, *L.* 3-4, *S.* 4, *C.* 26-33.

The two existing species of elephant are the Indian or Asiatic (*Elephas maximus*), and the African (*E. africanus*), the distinctive characteristics of which are given under ELEPHANT. See also MAMMOTH and MASTODON.

EXTINCT PROBOSCIDEA

Elephas.—The extinct representatives of the Proboscidea are of the greatest importance and interest, since they serve to connect the modern elephants with ungulates of more ordinary type. The MAMMOTH (*Elephas primigenius*) is treated in a separate article. Nearly allied is *E. armeniacus* of Asia Minor; but *E. antiquus*, of which the remains are abundant in many of the superficial formations of England and Europe generally, approximates in the structure of its molar teeth to the African elephant. It is represented in the Pleistocene of India by the closely allied or identical *E. namadicus*. Affinity with the African species is strongly marked in the case of the dwarf elephants of Malta (*E. melitensis*) and Cyprus (*E. cypriotus*); and the gigantic *E. meridionalis*, of the "forest-bed" of the east coast of England and the Upper Pliocene of the Val D'Arno, has likewise molars showing the broad lozenges of enamel-bordered dentine characteristic of the African type. These and other species indicate, however, that, so far as dental characters are concerned, generic separation of the African from the Asiatic elephant is impossible. In North America the mammoth occurs in the far north, *E. columbi*, more akin to *E. antiquus* chiefly in the Central United States, and *E. imperator* (allied to *E. meridionalis*) in the south. The oldest representatives of this group are *E. hysudricus* and *E. planifrons* of the Lower Pliocene of Northern India; the latter of which developed premolars vertically replacing the anterior teeth of the molar series.

From *E. planifrons* there is an almost complete transition to the ridge-toothed elephants, such as *E. ganesa*, *E. insignis*.

E. bombifrons and *E. clifti*, typically from the Lower Pliocene of India and Burma, but some of which extend eastwards to Java, Borneo, China and Japan. These constitute the group (or genus) *Stegodon*, and are characterized by the lowness of the crowns of the molar teeth, in which the tall plates of the more typical elephants are reduced to low ridges with more or less completely open valleys between them; the number of ridges in each tooth is always much lower than in the corresponding teeth of the typical elephants. Premolars, vertically replacing the anterior molars, were often developed. These stegodont elephants appear to have been confined to India and the countries farther east, and exhibit an almost complete transition, so far as dental characters are concerned, to the mastodons of the same region.

Mastodon.—The connexion between the stegodont elephants and the mastodons (see MASTODON) is formed by the Indian and Burmese *Mastodon latidens* and *M. cautleyi*. In fact the main distinction between these animals and the stegodont elephants is the smaller number of ridges in the third, fourth and fifth molars, which is usually four, and never exceeds five, whereas in the stegodonts it is at least six and the numbers are not the same in each of the three teeth. In the two species named the transverse ridges are more or less continuous. Many other species, such as the European *M. arvernensis* (see fig. 2 in art. MASTODON) and the Indian *M. sivalensis*, have, however, the ridges broken up into columns, or cones, more or less alternately arranged, and thus blocking the intermediate valleys. In these species, which are of Pliocene age, there are four ridges in molars 3, 4 and 5; but in the Pleistocene North American *M. americanus* (as well as in many other species) these are reduced to three in each of the aforesaid teeth. The lower jaw of the latter species frequently shows small tusks, which are, however, generally shed in mature age. Premolars, which vertically replace some of the anterior molars (milk-molars), are developed in many species, although not in *M. americanus*. Species of the genus are found over the greater part of the world, inclusive of Europe, Asia and North and South America; *M. humboldti* being the best known South American species. A single tooth referable to this or the next genus has been obtained from South Africa.

Tetrabelodon.—The more primitive mastodons constitute the genus *Tetrabelodon*, and are characterized by the presence of a pair of short chisel-shaped tusks in the lower jaw, which is prolonged into a trough-like chin for their support; tusks being also present in the upper jaw. These animals were provided with a snout-like muzzle instead of a trunk (see MASTODON). Their birthplace was Africa; the Miocene European *M. angustidens* having been discovered in Egypt in strata overlying those from which were obtained the remains of the under-mentioned more primitive genera. Tetrabelodont mastodons were, however, by no means confined to the Miocene, *Tetrabelodon longirostris* occurring in the Lower Pliocene of Europe, and *T. pandionis* in that of India. Most of these four-tusked mastodons were smaller animals than modern elephants.

Palaeomastodon.—No proboscidean earlier than *Tetrabelodon* occurs in Europe, but the group is represented in the Upper Eocene of Egypt by a smaller and more primitive type known as *Palaeomastodon*. This genus resembles *Tetrabelodon* in having four pairs of tusks, but differs in the less elephant-like skull, and the simpler character of the molar teeth, of which five pairs were in use at one time, whereas in *Tetrabelodon* and *Mastodon* there were never more than two pairs and a portion of a third in simultaneous wear.

Moeritherium.—The earliest representative of the proboscidean stock at present known is *Moeritherium*, from the Middle Eocene of Egypt, which includes still smaller animals, whose relationship to *Elephas* would scarcely be realized were it not for the intermediate links. All six pairs of cheek-teeth (*pm.* 2-*m.* 3,

fig. 3) were in use at once, and there was a comparatively full series of teeth in the front of the jaws; while the premolars were preceded by milk-molars in the normal manner. Very significant is the enlargement of the second pair of incisors in each jaw, thereby foreshadowing the tusks of *Tetrabelodon*. There was, however, no lengthening of the chin, so that the muzzle was

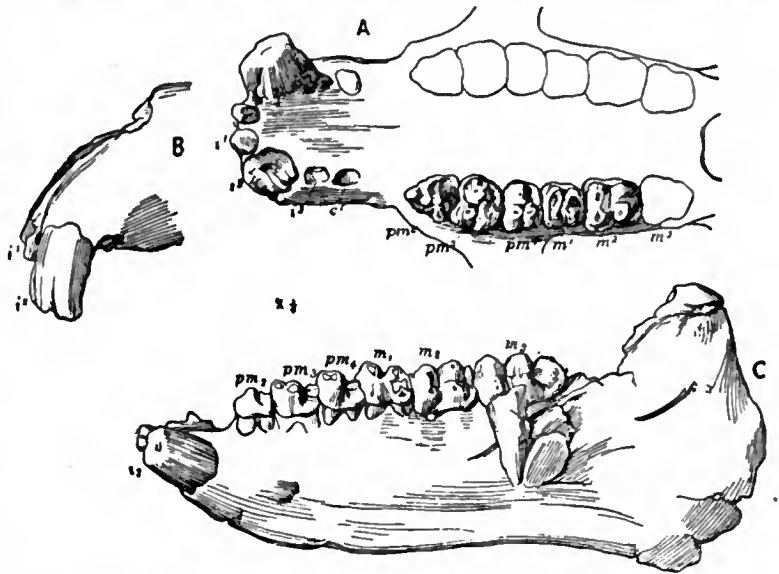

(From the *Geological Magazine*.)

FIG. 3.—Dentition of *Moeritherium lyonsi*. ($\frac{1}{4}$ nat. size.)
A, Upper teeth.
B, Front of snout, showing the tusk-like second incisors.
C, Left ramus of mandible from outer side.

probably of normal proportions. This animal was not larger than a tapir.

Dinotherium.—The huge proboscidean from the Lower Pliocene and Middle Miocene strata of Europe and India, known as *Dinotherium*, indicates a type off the line of descent of the elephants. Upper tusks were apparently wanting, but the



FIG. 4.—Skull of *Dinotherium giganteum* (Lower Pliocene. Eppelsheim, Hesse-Darmstadt).

lower jaws carried a pair of large tusks bent downwards in a peculiar manner (fig. 4). The cheek-teeth formed five pairs, all in use at one time, and premolars vertically replacing milk-molars in the ordinary fashion. The ridge-formula of the permanent teeth of the cheek series was 2.2.3.2.2.

Barytherium and *Pyrotherium*.—Very problematical are the

affinities of *Barytherium* of the Egyptian Eocene and *Pyrotherium* of the Lower Tertiaries of Patagonia; although it is possible that they may both be offshoots from the primitive proboscidean stock. *Pyrotherium* had a pair of upwardly directed tusks in the lower jaw. The cheek-teeth are five in number and carry transverse ridges similar to those on the molars of *Dinotherium*, although there are only two to each tooth. If really related to the Proboscidea, *Pyrotherium* may be derived from the African ancestral stock of that group which reached South America by way of a former land-connexion between that continent and Africa. So far as can be determined, *Barytherium* approximates in many respects to *Dinotherium*, but in others seems to approach *Uintatherium* of the North American Tertiaries (see AMBLYPODA).

See C. W. Andrews, *Descriptive Catalogue of the Tertiary Vertebrata of the Fayum*, British Museum, 1906. (R. L.)*

PROBOSCIS, the trunk of an elephant (Gr. *προβόσκis*, *πρό*, before, *βόσκειν*, to feed), the long flexible snout of the order of Mammalia called *Proboscidea* (q.v.), which embraces the elephant and its extinct allies the mammoths and mastodons. The term is also applied to the snout of the tapir and of the "kahan" or proboscis-monkey (*Nasalis larvatus*), and more particularly to the elongated parts of the mouth of various insects, such as the *rostrum* or beak of a rhynchophorus beetle, the antlia of *Lepidoptera*, the sucking mouth of the house-fly, &c. Various worms possess a tubular structure which can be extended at the anterior portion of the body, and some gastropods a sucking tongue, to both of which the name "proboscis" is applied.

PROBOSCIS-MONKEY, a large, long-tailed, red Bornean species characterized by the extraordinary prolongation of the nose of the adult male, which hangs, however, down in front of the upper lip and does not stand straight out from the face in the manner commonly represented in pictures. From this feature the species, which is the only representative of its genus, derives its name of *Nasalis larvatus*. In females and young the nose is much less developed, with a tendency to turn upwards in the latter. This monkey is a leaf-eater, nearly allied to the langurs, as typified by the sacred ape of India. (See PRIMATES.)

PROBUS, MARCUS AURELIUS, Roman emperor A.D. 276 to 282, was a native of Sirmium in Pannonia. At an early age he entered the army, where he distinguished himself under the emperors Valerian, Claudius and Aurelian. He was appointed governor of the East by the emperor Tacitus, at whose death he was immediately proclaimed his successor by the soldiers. Florianus, who had claimed to succeed his brother, was put to death by his own troops, and the senate eagerly ratified the choice of the army. The reign of Probus was mainly spent in successful wars by which he re-established the security of all the frontiers, the most important of these operations being directed to clearing Gaul of the Germans. Probus had also put down three usurpers, Saturninus, Proculus and Bonosus. One of his principles was never to allow the soldiers to be idle, and to employ them in time of peace on useful works, such as the planting of vineyards in Gaul, Pannonia and other districts. This increase of duties was naturally unpopular, and while the emperor was urging on the draining of the marshes of his native place he was attacked and slain by his own soldiers. Scarcely any emperor has left behind him so good a reputation; his death was mourned alike by senate and people, and even the soldiers repented and raised a monument in his honour.

Life by Vopiscus; Zosimus i. 64; Zonaras xii. 29; Aurelius Victor, *Caes.* and *Epit.* 37; H. Schiller, *Geschichte der römischen Kaiserzeit* (1883), vol. i.; E. Lépaulle, *Étude historique sur M. A. Probus d'après la numismatique* (1885); Pauly-Wissowa, *Realencyclopädie*, ii. 2516 (Henze).

PROBUS, MARCUS VALERIUS, of Berytus, Roman grammarian and critic, flourished during the reign of Nero. He was a student rather than a teacher, and devoted himself to the criticism and elucidation of the texts of classical authors (especially the most important Roman poets) by means of marginal

notes or by signs, after the manner of the Alexandrine grammarians. In this way he treated Horace, Lucretius, Terence and Persius, the biography of the last-named being probably taken from Probus's introduction to his edition of the poet. With the exception of these texts, he published little, but his lectures were preserved in the notes taken by his pupils. Some of his criticisms on Virgil may be preserved in the commentary on the *Bucolics* and *Georgics* which goes under his name. We possess by him part of a treatise *De notis*, probably an excerpt from a larger work. It contains a list of abbreviations used in official and historical writings (especially proper names), in laws, legal pleadings and edicts.

The following works have been wrongly attributed to him. (1) *Catholica Probi*, on the declension of nouns, the conjugation of verbs, and the rhythmic endings of sentences. This is now generally regarded as the work of the grammarian Marius Plotius Sacerdos (3rd century). (2) *Instituta artium*, on the eight parts of speech, also called *Ars vaticana* from its having been found in a Vatican MS. As mention is made in it of the baths of Diocletian, it cannot be earlier than the 4th century. It is possibly by a later Probus, whose existence is, however, problematical. (3) *Appendix Probi*, treating of the noun, the use of cases, rules of orthography (valuable in reference to the pronunciation of Latin at the time), and a table of *Differentiae*. As the author has evidently used the *Instituta*, it also must be assigned to a late date. (4) *De nomine excerpta*, a compilation from various grammatical works.

See J. Steup, *De Probiis grammaticis* (1871); Teuffel-Schwabe, *Hist. of Roman Literature* (Eng. trans.), 301.

PROCEDURE (Fr. *procédure*, from Lat. *procedere*, to go forward), in general, a method or course of action. In law, procedure may be defined as the mode in which the successive steps in litigation are taken. As a term in English law it dates only from the passing of the Common Law Procedure Acts 1852-1860; it is usually coupled with, or more often replaced by, the word "practice." The procedure of the High Court of Justice in England is governed by the rules of the supreme court, which are published in the *Annual Practice*. Procedure has been defined (per Lush, L.J., *Poyser v. Minors*, L. R. 7 Q.B.D. 329), as "the mode of proceeding by which a legal right is enforced as distinguished from the law which gives or defines the right, and which by means of the proceeding the court is to administer; the machinery as distinguished from the product." T. E. Holland (*Elements of Jurisprudence*, 1906, p. 86) describes procedure, or "adjective" law, as that part of law which provides a method of aiding and protecting rights.

See the articles on the various branches of law, as ADMIRALTY JURISDICTION, CRIMINAL LAW, DIVORCE, &c.; also ACTION, APPEAL, EVIDENCE, PLEADING, SUMMONS, TRIAL, &c.

PROCESS, a general term now technically employed for the photo-mechanical processes by which illustrations are reproduced in printing. Until the last quarter of the 19th century reproductive processes, save as regards line reproduction, can hardly be said to have had an existence. Paintings, drawings, and engravings, which it was desired to put into form which by means of the printing-press could be multiplied indefinitely had to go through a process of interpretation by an engraver or draughtsman, who, on a metal plate, a block of wood or stone, gave a rendering of the original subject. The means at his disposal were lines and dots, which, varying in their thickness and proximity, expressed dark or light passages in the scheme of light and shade of the original. It will readily be understood how such interpretations would vary. An engraver with fine art instincts would produce a result as distinct in character as an engraving as was the original as a painting or drawing, and engravings were sought after as works of art, and treasured for their artistic qualities. But engraving of this kind took time. Years were devoted to the production of one steel- or copper-plate, while wood engravers who were artists could only work on a block when in the mood; and for that mood the publisher had to wait, and he grew impatient and was willing to accept rapid interpretation of originals by men who could produce them under other than artistic conditions. But the pain of the artist at the bad rendering of his original was often great, so that he, not less than the publisher, though for another reason, hailed

the attempts that were being made to reproduce his work mechanically without the intervention of the translator or interpreter. The ideal of an artist would naturally be a reproduction of his work in facsimile, which retained all, or as many as possible of, the individual characteristics of his work; and to give him this was the aim of the school of wood engravers which originated in the United States and made a last stand to maintain the position of their art in the field of book illustration. By a system of extremely fine work the American wood engravers were able to keep much closer to the tones of an original than had previously been possible; but the result was obtained at the sacrifice of the artistic rendering of the best old engravings, and was so mechanical in its character that when it had to compete with a real mechanical process the engraving could not hold its ground, the enormous difference in the cost of production being a factor of sufficient importance in itself to make it impossible for the engraving to retain the field. A similar development had been going on in the other branches of engraving. The line engraver and the etcher, to whom had been entrusted the interpreting of works of art first produced in other forms, found themselves faced by mechanical reproductions in plate form which, while preserving more of the character of the original work, were produced in much less time and at a greatly reduced cost. It has thus come about that the last quarter of the 19th century witnessed the dispossession of the hand engraver from the field of interpretative engraving, and the occupation of his position by the chemist and the mechanic.

The term "process," which has come to be applied to all photo-mechanical reproductions, is a somewhat unfortunate one, inasmuch as it is descriptive of nothing. From time to time various names have been given to its varying forms, indicative either of the name of the inventor or of some peculiarity of method. Zincography, gillotype, photogravure, heliogravure, heliotype, phototype, albertype, are illustrations of the kind of name given often to very slightly varying applications of the same principle, but usage has come to apply the term "process" to any printing surface that is produced by chemical and mechanical means. The whole of these processes may be arranged under three heads: (1) relief; (2) intaglio; (3) planographic.

1. *Relief Processes.*—An engraving in relief is one in which the printing surface stands up above the surrounding ground. The history of the development of relief processes is really the history of photography (*q.v.*); for whilst attempts were made to obtain results without the aid of photography, by drawing upon plates with prepared chalk or ink, "rolling them up" with printer's ink and etching away the ground with acid, as in the case of zincography, the real progress of all process has been upon the lines of photography; and to Niepce and Daguerre may be attributed the origin of the modern mechanical and chemical processes.

Speaking broadly, all the modern "processes" are the outcome of a discovery by Mungo Ponton that a preparation of albumen or other colloid substance and bichromate of potash could be hardened and rendered insoluble and nonabsorbent in water by exposure to light, and that as a photographic negative permitted the passage through it of light in varying degrees of intensity, so a film of the preparation placed under a negative was liable to be hardened and rendered insoluble in degrees varying with the intensity of the light affecting it. This discovery governs the production of process blocks or plates of all kinds.

The methods of reproduction of pure line work differ greatly from those for the reproduction of originals in tone. As the first necessity in securing a good result is the suitability of the original to be reproduced, it is desirable to make clear the character of a good original. This should be of one tone or degree of colour all through. It may be all grey; it is better that it be all black. It may not be black in parts only and grey in others. The lines of an original may be of any variety of thickness. It is necessary, therefore, for the draughtsman to see that he works with a good black

ink, or ink that will tell as black when it is exposed to the photographic plate. Inks of a warm tone—that is, inclining to red or orange—yield better results than cold inks which incline to blue.

Most prepared liquid inks have a tendency to lose their blackness by exposure to the atmosphere on the removal of the cork from the bottle. The ideal ink is one freshly ground from a dry cake of colour when beginning work. Indian ink is good if well ground and kept sufficiently thick to assure the necessary blackness. It has the advantage of not washing up when colour in washes is passed over it, but it must be used freshly ground. The addition of a little Indian yellow, burnt sienna or sepia, gives a warmth of tone to it and renders it photographically more active. Bourgeois ink, prepared by Bourgeois of Paris, appears to be prepared with the admixture of some warm colour with the black base. It is a good ink for the purpose, and is prepared both in solid and liquid form. Lampblack gives good black lines; so does ivory black, which is warmer in tone than lampblack. Higgins' Indian ink or American drawing ink is an American ink made in liquid form which has the reputation of not fading by exposure. Stephens's Ebony Stain is a fine black medium which does not clog the pen; if it thickens and dries, it cracks off and does not corrode the pen.

Besides the pen a brush brought to a fine point is much preferred by some artists, as it yields a line less monotonous than that given by a pen, though the brush cannot be used so freely. The paper used should be smooth and as white as possible. A paper is made with a surface coating of white chalk, which admits of the use of a scraper to remove lines or to break them up.

It is not possible to lay down a rule for the amount of reduction to be made when photographing for the reproduction; the finer the drawing the less should be the reduction made; but experience is the only guide. Sometimes, where the lines are very fine and the drawing minute in character, an enlargement is desirable. Where drawings are reduced too much, there is a tendency for the spaces between the lines to fill up, and to give a coarse, heavy result. Faulty drawing is not lessened by reduction. On the contrary, the fault becomes more evident, so it is desirable to make all necessary corrections in the drawing.

The original drawing which has to be reproduced is photographed to the size of the required block. The negative taken is absolutely dense except where the lines of the drawing have affected it, and these are absolutely clear, admitting the unrestricted passage of light through them. A piece of planished copper or zinc is prepared or made sensitive to light by a preparation of albumen or gelatin and bichromate of potash spread upon its surface. The negative is laid upon the sensitized metal and placed in the light in the way an ordinary photograph is printed. The light passes through the transparent lines of the negative and hardens the bichromated film beneath them. Both negative and plate are then taken into a darkened room, where the metal plate is rolled with an inked roller, placed in a bath of cold water and allowed to soak until the albumen and bichromate becomes so softened everywhere, except where the light has hardened them, that they all wash away, and nothing is left but the hardened lines. The lines are dusted with asphalt, which by heat is melted on to them, and makes a ground which resists the action of acid. A coat of varnish is put over the back and edges of the plate, to protect them from the acid also, and only the spaces between the lines on the surface are left free to its action. The plate is then placed in a bath of dilute nitric acid, which eats away the metal wherever it is exposed; but it leaves the lines of the drawing, which are protected by the hardened film standing up above the eaten or etched surface; and these lines, which correspond to those of a wood engraving, are the printing surface of the plate. The plate is mounted on a wood or metal block, made type-high, and it can then be used along with type in the printing-press.

Various devices have been resorted to that effects of tone may be obtained by means of the simple line process. Grained papers with a surface of chalk, upon which are printed close-ruled lines crossing at right angles, or rows of dots give the papers a heavy, flat, "tone," upon which a drawing can be made in pencil, chalk or ink, and gradations of tone introduced by means of scrapers, which remove partially or entirely the black ruled lines or dots, leaving, if desired, high lights of pure white. A drawing on such

paper consists of lines or dots, a combination of the original lines or dots of the paper and those of the drawing itself, the scraper splitting up lines into dots or removing them altogether. The result is quite easily reproduced by the line process. Another method is by the use of what are known as Day's "shades," or shading mediums. They are transparent films of gelatin which have upon them lines or dots in varying combination in relief, so that they can be inked up by a roller. When placed over a drawing, their transparency enables the operator to see exactly what passage he is dealing with, and he can by means of a burnisher impress the lines or dots of the shade upon any passage of the drawing; these lines or dots then become part of the drawing; and are reproduced in the usual way.

Pencil or chalk drawings upon simple white-grained paper, where the pencil or chalk passing over the ruts or hollows in the paper makes a mark on the top of the grain only, are also reproducible by the line process, but such drawings are apt to be unequal in colour and difficult to deal with. The difficulty led to the invention of a process by Henry Matheson, who, not having the capital to work it, joined the late Mr Dawson, senior, whose sons continued to work the process with Matheson under the name of the Swelled Gelatin

**Swelled
Gelatin
Process.**

Process. It is based upon the fact that gelatin, sensitized with bichromate of potash, swells when placed in water, and swells in proportion to the amount of light to which it has been exposed. A negative taken from a drawing which varies in tone, not being thoroughly black all through, varies in the quality of its transparent lines and dots; and when a piece of paper or glass coated with sensitized gelatin is exposed to the action of such a negative it is affected according to the amount of light the negative allows to pass. After making a print on such paper or glass, it is placed in a dish of water and the surface allowed to swell, which it does in varying degrees, the portion unaffected by the light absorbing most water and swelling most, the hardened lines of the drawing not swelling at all. This swelled print is then placed in a frame, and a preparation of plaster is poured upon it to make a mould of its surface. When this has set and the gelatin has been removed, this mould is filled with a preparation of wax, which sets in a few minutes sufficiently for it to be released from its plaster mould. Additional wax is built up when necessary upon the "whites," as they are technically called—that is, the passages which represent what will be the hollows in the block—so that these may be as deep as possible; and this wax mould is electrotyped in copper. The lines and dots of this copper block, which when finished is backed up with metal and mounted, vary slightly in height, the result being that the slightly lower dots do not come so closely in contact with the inking roller or with the paper, and so produce when printed a grey impression corresponding to the greyness of the original drawing.

The drawback to the use of the process is that it is about three times as costly as the ordinary process. It is a method much used for the reproduction of line and stipple engravings, where fine dots and lines are apt to be printed in delicate tones. The finest results by this method are producible, however, by omitting the plaster mould and wax-cast stages, and by coating the sensitized gelatin with plumbago or other impalpable metal preparation which will enable it to receive a copper deposit to qualify it to take its place in the electrotyper's bath, and so to get the needed thin coating of copper from the surface of the gelatin itself; but this needs to be done with the greatest care, and is still more costly.

A non-photographic process of obtaining line blocks in relief has been for a long time successfully worked by Messrs Dawson. A brass plate is coated with a film or ground of wax upon which a tracing of the drawing to be reproduced may be rubbed down. By means of an etching needle the lines of the drawings are incised upon the thin wax ground down to the surface of the brass plate. A pencil of wax and a pencil of hot metal are then used to produce a flow of melted wax which drops from the wax pencil upon the ridges of wax between the lines and builds them up until they are of sufficient height. The risk that this wax may run into the incised lines has to be carefully guarded against, but skilful treatment manages so that it stops at the edges and does not run over. In maps and diagrams where lettering or figures are necessary, type is impressed into the wax with a very neat and precise result. By this means a mould is formed, an electrotype from which gives a really good relief block which may be printed with type.

The invention of line processes only stimulated the efforts to find out some means whereby tones might be reproduced on blocks or plates that could be printed along with

**Half-tone
Processes.**

type in the ordinary rapid printing-press. It is only possible to approximate to the printing of a flat or graduated tone by producing a broken or granulated surface which shall present a series of lines or dots that, when inked and impressed upon paper, shall by the variations of proximity and size give the impression of an unbroken tone. This necessitates the lines or dots being so small that the eye

shall not at a glance appreciate the broken-up character of the surface of the block. Many efforts resulted in the production of what is known as the *screen*, which itself was only made possible by the invention of ruling machines of a delicacy previously unknown.

A screen is made by coating a sheet of glass—which must be flawless both as to body and surface—with a composition analogous to the ground used by an etcher to coat his plate before drawing upon it with his needle. The glass so coated is placed in an automatic ruling machine, of which the ruling point is a diamond, and which can be adjusted so as to rule any number of lines from 50 to 300 to the inch. The lines are ruled diagonally on the glass, and at mathematically equal distances from each other. The sheet of glass, after ruling, is treated with hydrofluoric acid, and the lines where the ground is cleared away by the diamond point are etched or bitten into it. The plate is cleaned up and an opaque dark pigment rubbed into the lines. Two such ruled sheets of glass are sealed together face to face with Canada balsam, with the diagonally ruled lines crossing each other at right angles, the result being a grating or screen containing innumerable little squares of clear glass through which the light can pass, which it cannot do through the ruled lines, which are filled by the opaque pigment.

To produce a half-tone block from a picture, a black and white drawing in tone, or a photograph, a negative is exposed in the camera in the usual way, with this screen quite close to it but not in contact; and the subject is photographed on to the negative through the screen, and what is termed a "screen negative" is the result. It is a photograph of so much of the original as could affect the negative through the little clear squares of the screen, and represents the tones of it by innumerable dots and lines, the size and proximity of which are regulated by the fineness or coarseness of the screen used.

In the early days zinc was the metal used for these half-tone blocks; but experience showed that though more difficult to etch to the necessary depth, the closer, denser texture of copper rendered plates of this metal much more suitable for the production of the best blocks, and zinc now is used only for inferior blocks. Whichever metal may be used, a sheet of it, most carefully planished, is sensitized with a coating of gelatin or fish-glue and bichromate of potash, dried and exposed under the screen negative to the action of light, as in the ordinary method of photographic printing. The action of the light hardens the gelatin film, the portion not so hardened being soluble by water. The plate with the gelatin picture in lines and dots is exposed to heat and the image is burnt in on the surface of the metal like an enamel, which enables the photographic picture to resist the subsequent etching. The plate is placed in a bath of iron perchloride and etched until sufficient depth is obtained. Wherever the surface of the plate is free from the lines and dots, it is bitten away by the perchloride, and the lines and dots are left in relief. This first biting in the bath produces a rather flat general impression of the original, and is termed "rough etching." To produce finer results, and to bring out the contrasts of black and white necessary to a good reproduction, the block has to go through processes of stopping out and rebiting similar to those of etching an intaglio plate. This "fine etching" calls for the artistic taste and judgment of the craftsman; and with a good photograph to work from the final quality of a block will depend largely upon its treatment by the fine etcher. A substitute for the acid bath has been found in an acid blast. The acid is driven in the form of a spray with some force on to the surface of the prepared plate, which it etches more rapidly and more effectively than the bath.

One risk to be guarded against is the underbiting of the lines and dots which form the printing surface. As soon as the acid has eaten its way downwards past the protecting surface film, it will attack the sides of the upstanding dots as well as the ground that supports them, with the result that they become weakened and rendered liable to break off in the process of printing, as well as to make the obtaining of electrotypes from the blocks a

PROCESS



A.

GALLIREX JOHNSTONI.
The Turaco of Ruwenzori.

B.

From a Drawing by Sir Harry Johnston, from "The Uganda Protectorate," by Permission of Hutchinson & Co.



Three-Colour Process.

C.



D.

*Andre & Sleigh, Ltd., Engravers,
Bushey, Herts.*

SHOWING THE SEPARATE COLOURS EMPLOYED IN PHOTO-REPRODUCTION
BY THE THREE-COLOUR PROCESS

The three primary colours are separated out by photography, each colour sensation is etched on copper, and when the Blocks representing Yellow (A), Red (B), and Blue (C), as illustrated above, are superimposed in the printing press, the result (D) is a reproduction of the original in all its combinations of colour.

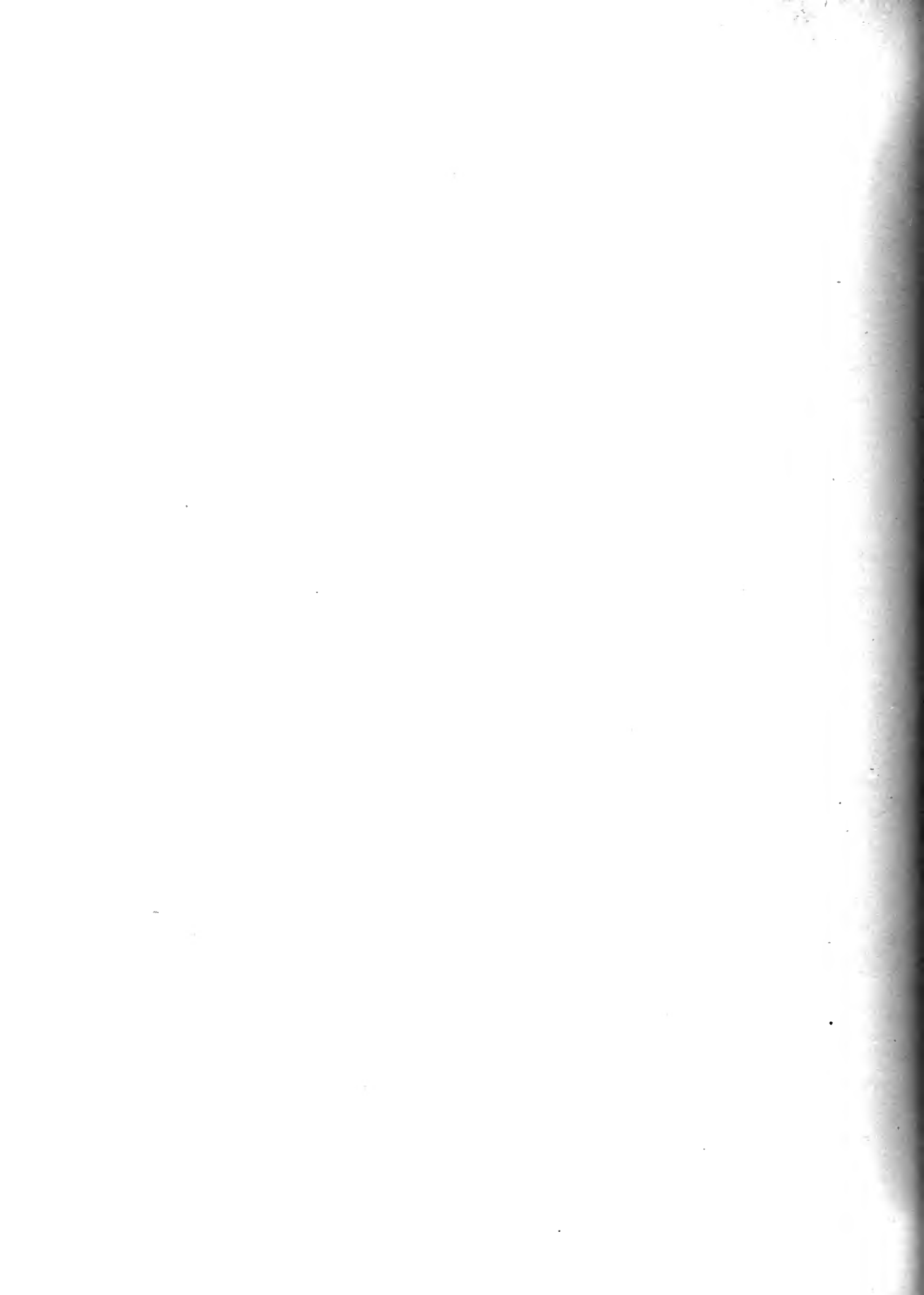

matter of extreme difficulty, the underbitten points breaking or tearing away in the mould. To avoid this underbiting a fatty ground is laid over the surface of the block each time it is etched; by exposure to heat this ground is sufficiently melted to permit of its running down the sides of the upstanding points, and so giving them the required protection. The acid blast is less liable than the bath process to eat away the sides of the dots.

This method of making tone relief blocks is most generally known as the "Meisenbach" process, from Meisenbach, of Munich, who was the first to make it commercially successful, but the history of its development is somewhat obscure. Fox Talbot as early as 1852 took out a patent for using a screen of crape or muslin; he also suggested dusting glass with a fine powder to produce a grain screen. All the early ruled screens were single line, and the credit is due of suggesting the shifting of the single line screen during the operation and, by reversing it, producing the effect of the double line, to Sir Joseph Swan, who patented the process in 1879. Meisenbach's patent for a similar method is dated 1882. The development of the screen was the important factor in the development of the process. The early screens were photographs of ruled plates and the great advance was made by Max Levy of Philadelphia, who made it possible by his ruling machines to produce screens of a fineness and clearness not previously practicable. It was F. E. Ives who, in 1886, introduced ruled screens placed face to face and sealed up so as to produce cross-lined screens.

The chief objection to this process is its inability to reproduce the extremes of expression employed by the artist in black and white; actual white is impossible, and delicate tones, such as are characteristic of skies, are destroyed by the cross-bar lines of the screen, which cover down all light passages and rob the reproduction of that brilliancy which characterized wood engraving. It is true that the addition of hand engraving can be resorted to in the case of the process block, and lights and other varieties of tone and form introduced, but this can only be done on blocks of very fine texture, and the cost of reproduction is greatly increased by the introduction of such handwork by the engraver.

The most important development of the half-tone process is in the direction of the reproduction of works in colour by means of relief blocks. The theories of colour (*q.v.*) in light and in pigments enter largely into this development. White or solar light is composed of rays of light of three distinct colours, red, green and violet, which are called the primary or fundamental colours because by their combination in various proportions all other tones of colour are produced, but they cannot themselves be produced by any combination of other coloured rays. The theory of pigmental colour differs from this in that the primary or foundation colours from which all others are produced, while being themselves unproducable by any admixture, are blue, red and yellow, and while the combination of the red, green and violet of the scientist produces white, the combination of the primaries of pigments in their full strength produces black.

Colour is the result of the absorption and reflection of the rays of light which strike upon a body. The rays which are reflected are those which affect the vision and produce the sense of colour. Should the object absorb all the rays it appears black, should it absorb none but reflect all it is white, and between these two extremes lie an infinite variety of tones. Filters have been made which absorb and refuse passage to certain coloured rays, while permitting the passage of others, e.g. a photographic filter of a certain colour will absorb and stop the passage of red and green rays, while permitting the passage through it of the violet. It will then be perceived how, when a picture or other coloured object is placed before a camera, with one of these filters between it and the exposed negative, the rays of light of the colour which can pass through the filter to the negative will be the only ones which can affect it, and that it is possible in this way to secure on three separate negatives a record of the green, red and violet rays which are reflected from its coloured surface by any object placed before the camera.

These records are coloured photographs; they are simply ordinary negatives, records of colour values which may be translated into colour by the use of coloured inks. The principle governing the process is analysis or separation followed by recombination. Positives are made from these colour records, from which by means of the rule screens already described half-tone process blocks are made which, when printed one over the other in coloured inks, combine again the colours which were separated by the filtering process and give approximately a reproduction of the original in its true colours. The colour used with each block must have a relation to the filter used in its production. It must represent a combination of the two colours stopped out by the filter when making the negative from which the block was made, that is to say, the colour used must be complementary to the colours stopped out. Certain subjects which are amenable to long exposures can be dealt with by what is known as the "direct process," whereby the screen negative and the colour record are made by one operation on the same plate. By this means six of the fifteen otherwise necessary operations are saved, but the method is not always practicable.

As far back as 1861 the suggestion was made at the Royal Institution by Clerk Maxwell to reproduce objects in their natural colours by superimposing the three primary colours. Later Baron Ransomut, of Vienna, Mr Collen, a gentleman who taught drawing to Queen Victoria, and two Frenchmen, MM. Chas. Cros and Ducos du Hauron, carried on the idea and made experiments with the aid of photography, which were still further developed in Germany by Professor Husnik, of Prague, Dr Vogel, of Berlin, and others; but it was in America that the first three-colour blocks for letterpress printing were made, F. E. Ives, at Philadelphia, being their maker in 1881.

This three-colour relief process has made great advances in recent years. The first great practical difficulty which had to be overcome was to produce three screen blocks which could be printed one over the other. Were the screens of each block used at the same angle, the lines and dots would print on the top of one another; but a great deal of the colour result depends upon a considerable proportion of each colour being on the white paper. Artists know well that much purer and more brilliant results are produced by placing touches of colour side by side than one over another; small patches of red and blue, placed side by side, yield to the eye a purple of much greater purity and beauty than the same touches of colour worked one over the other. Consequently it was found necessary to turn the screen at a different angle for each block, so that the lines should not fall on each other but should cross each other; but the risk of this is that, used at certain angles, the crossing of the screen lines will produce what is known as the *moiré antique* result. Vogel took out a patent in Great Britain for the process, and he therein stated that the screens should be used at certain stated angles. He also proposed to use single-line screens, similar to those used by F. E. Ives at Philadelphia, instead of cross-line; but it has since been found that the cross- or double-line screens can be used successfully; and that the angle at which they can be used is not a fixed one.

Filters are made in a dry or wet form. The dry filter is made by spreading a film of gelatin or collodion, tinted by an aniline colour, upon a piece of glass. The wet filter is a cell or trough made of two sheets of glass, sealed all round and filled with water tinted with an aniline dye or colour. The accuracy of the tint of the colour-filter may be tested by the spectroscope, or by an instrument invented by Sir William Abney, and known as the Abney colour sensitometer. This is a theoretical test. The practical test is by photographing through them patches of blue, red, and yellow. If, for example, the filter for blue records the full strength of blue with the full strength of the colour of the negative, while giving slight or no record at all of the red and yellow, it is practically a true filter. It is possible to treat the negatives themselves so as to render them more sensitive to the special colour they are intended to record. Indeed Dr Albert, of Munich, has produced a collodion emulsion which is so sensitized that the various colour sensations are directly obtained without the interposition of a colour filter. Different makes of plates demand different colour-filters. (For colour-filter making see Ives.

Colour
Filters.

Photographic Journal, vol. xx. No. 11). The preparation of these colour-filters calls for great perfection of quality in the materials employed, and great accuracy in the using of them. The glass, whether for the dry or wet filter, must be absolutely flat as to its surface, and its two sides must be absolutely parallel. In the wet filter the glasses forming the sides of the cell or trough must be parallel to each other.

Coloured glass is sometimes used in combination with the tinted collodion, but there is no particular advantage in this, because two glasses are always used in the making of a filter, and each one may, if desired, be coated with different dyes and afterwards cemented together with Canada balsam.

The following dyes or their equivalents form a basis for nearly all three-colour filters:—

For the red printing negative	{ Brilliant green.
	{ Brilliant yellow.
	{ Cochineal red.
“ blue ”	{ Brilliant yellow.
	{ Methyl violet.
“ yellow ”	{ Naphthol green.

The first dye named is the base colour in each case, the second is employed in small proportions to produce the required modification of tint.

The theory of the three-colour process is that the same three colours shall be used for the printing of every subject; and there is no doubt that if the filtration were perfect and the printing inks absolutely pure, the theory would work out fairly correctly in practice; but there is room for improvement in both these matters, and it is therefore often found desirable to print special subjects with special pigments, which makes it difficult to print several subjects together. Special care is called for on the part of the printer. There must be the most perfect register of the three subjects, otherwise a blurred effect results; there must be constant watchfulness to see that there is no excess of ink of any one colour, or the whole scheme of colour will be destroyed. This three-colour process has been a rather long time in establishing itself and nothing has so tended to retard it as bad printing. Good blocks have been obtainable, but in the hands of ordinary printers they have yielded but indifferent results. It is hardly to be expected that the untrained eye of the ordinary printer should be successful where the work requires the cultivated judgment of an artist. There is one other necessity for success in all tone relief work, and that is the use of the right quality of paper and ink. The blocks are so delicate they soon fill up if an excess of ink is used. Ink of a good quality can be used in much less quantity than common kinds, but it must be impressed upon paper that is sympathetic and will “bear out” the ink.

The best results can be obtained only with the use of what is known as “coated” paper. It is a paper which, after manufacture, is passed through a bath of a preparation of china clay, which by means of brushes is rubbed into the surface of the paper. When dry the surface takes a high polish, and is sensitive to the smallest amount of ink. The polish of this coated paper is objectionable to many readers of illustrated books, and the clay adds considerably to the weight. Paper makers are, however, supplying a dull-surfaced highly calendered rag paper which is very good for artistic and scientific illustrations and obviates both the glossy surface and the supposed lack of permanency of chromo paper.

2. *Intaglio Processes*.—An intaglio engraving is one in which the printing surface is sunk below the surrounding portions of the plate; the lines or dots—pressed, cut or bitten into the surface—holding the ink which is to be impressed upon the paper when the original surface of the plate is wiped clean. The old-fashioned steel engraving may be taken as the type of an intaglio plate, in which the lines which printed were cut into the surface of the plate, instead of being left standing up in relief, as in the case of a wood engraving.

“Photogravure” is the name by which the many processes are generally known by means of which intaglio engravings are made mechanically, “heliogravure” being another name for the process, or special application of it. Photogravure reproduces the tones of photographs or drawings, and gives the nearest approach to a facsimile reproduction that has yet been arrived at. Gelatin bichromatized is the medium by means of which the photogravure plate is produced; but as the screen is not used in ordinary work, it is necessary to produce an ink-holding grain in some way upon the plate. This is done by allowing a cloud of bitumen dust, raised inside a box, to settle upon the surface of a copper plate; it is fixed by heat, which, though insufficient to melt it, is enough to attach the fine grains to the

plate. Over this prepared surface is laid the film of bichromatized gelatin, upon which is printed the subject through a glass positive; the usual hardening process takes place by the action of light, followed by a washing out of the unhardened portions of the gelatin. The plate is exposed to the action of ferric chloride, which attacks it most strongly in the least exposed parts, but which cannot eat it away in broad flat masses of dark, even in the non-exposed portions, owing to the existence of the bitumen granulation, which ensures the keeping of a grained surface even in the darkest passages.

Photogravure is a costly process to employ for illustration. The plates have to be printed slowly, with much hand work, as in the case of etchings. It is the printing that makes its use expensive, rather than the making of the plates; and as each plate must be printed separately and on special paper, it cannot be employed with type, like relief blocks.

There is much uncertainty about the production of plates by the photogravure method; and although great improvements have been made in the process, it is often necessary to produce several plates before a satisfactory one is obtained. In all these reproductive processes the more artistic the workman the better the result; this is especially true of photogravure, in which the aim is to come very much nearer to the original work of the artist designer than in the less perfect processes.

The method of Rousillon, which was adopted by Goupil in the production of photogravure plates in the early days of the process, was to prepare the surface of the plate with a secret preparation of certain salts, which crystallized under the action of light, so that when exposed under the negative the surface was broken up by this crystallization more or less, according to the amount of light the negative permitted to reach it. The plate with its crystallized surface was then electrotyped, and the electrotype was the plate used for printing. It was a deposit process, as opposed to an etching process.

Photogravure plates are made also by the use of the grain screen, in which the reticulations of the screen take the place of the bitumen powder in producing a grain; it is the inversion of the method by means of which points and lines are produced in the relief block. It has not, however, come much into favour, probably owing to the greater coarseness of the grain and the consequent loss of softness in the tones. An application of this method has, however, been made in the development known as the Rembrandt intaglio process. It is a secret process; but the secret lies more in the press by which *Rembrandt* the plates are printed than in the plates themselves, *Intaglio Process*.

which are intaglio plates made with a very fine screen and bent to a cylinder. The attempt to print photogravure plates by machinery was given up because the plates were so shallow they would not stand the wear and tear, and their life was too short and the results too indifferent; but the use of the grain screen renders possible stronger, deeper plates, that will stand harder wear. There is little doubt that the machine used is some form of the machine used to print wall-papers, in which there is a central cylinder engraved with the design, inked by rollers with which it comes in contact. The ink not only fills up the intaglio or sunk portion which has to print the design, but covers as well the whole surface of the plate. To clean this surface, leaving ink only in the sunk dots and lines, another metal cylinder is employed, ground and grooved somewhat like the shaft of the common steel of the dinner table used to sharpen knives, the grooved surface of which, passing over the engraved cylinder, scrapes clean its inked surface, leaving ink only in the sunk portions, which will, as the cylinder comes in contact with the paper, deposit itself and print the picture. The results produced by the Rembrandt intaglio process are softer and smoother than those given by photogravure, and they are free from the gritty qualities which occasionally characterize photogravure; but they lack the brilliancy and depth of the latter. The process on the whole is less costly to use, mainly because the printing is so much more rapid, and is turned out by a machine instead of by hand.

A method of printing intaglio plates made from a screen

negative by the lithographic press was introduced and patented by Sir Joseph Swan and his son, Donald Cameron-Swan. The sunk surfaces are rendered receptive of lithographic ink while the surface of the plate itself is kept damp with water or glycerin and water, and remains clean and free from ink when the plate is rolled.

The monotype is not a new, but a revival of a somewhat old, method of reproducing on paper a painting by an artist. The design is executed on a plate by means of brushes, fingers or other tools, with paint or printer's ink. On the completion of the painting, paper is laid upon it, and plate and paper are together passed through a press, when the ink or colour is transferred to the paper. One impression only is possible, hence the name of the process. A method has been devised by Sir Hubert von Herkomer for dusting the painting while still wet with a fine metallic powder, which gives a tooth to and renders the surface sympathetic to a copper deposit when it is placed in the galvanic bath, by which means an electrotype of the painting, with its varying relief surfaces, is obtained, and forms a plate from which numerous impressions can be taken.

The very large number of impressions it is often required to get from the etched surface of a block has made it necessary to devise means for preserving the original block, and to prepare and work from duplicates, which can be renewed when necessary. For this process the original is coated with a film of the finest plumbago (black lead) powder before being placed face to face with a bed of soft fine wax, into which it is pressed. The plumbago prevents adhesion and facilitates the withdrawal of the block after contact with the wax. The wax mould which is thus obtained is suspended in a galvanic bath of sulphate of copper. On passing a current of electricity through the liquid to the mould, the copper at once begins to deposit itself in metallic form over the face of the wax mould, and in a short time the deposit becomes thick enough, either by itself or when backed up with other metal, to be used as a block in the place of the original. The very fine nature of process blocks, and the necessity of obtaining perfect impressions from them, has led to the introduction of gutta-percha instead of wax as the medium for making a mould. It is melted and poured in a liquid state upon the block, and when cold can be removed without the risk attending the use of wax, which is apt to give way in the course of the separation of the block from the mould. Gutta-percha is much more tenacious, and being somewhat flexible, does not break and tear, as wax is liable to do. The whole process requires the greatest care in its manipulation.

Steel-facing is resorted to where long numbers have to be printed from photogravure plates. The finest film of steel is deposited by an electric battery over the whole face of the plate, which it hardens and protects. This steel face in time begins to wear, through the constant pressure and rubbing incidental to the process of printing, and the copper begins to show through it. As soon as this happens the plate is placed in an acid bath, in which the steel film disappears. The plate itself being still intact, can be re-stepped for further work.

The changes which have taken place in the form of illustrations have necessarily been accompanied by changes in the machinery by which they are printed. Almost all the changes and improvements have been initiated in the United States of America. The vital change made in the interest of process block-printing is what is technically known as "hard packing." Before the introduction of process blocks the "blanket" played an important part in all printing machines. It was a soft woollen sheet, which came between the plate or cylinder and the type and blocks, and modified the force of the contact between them. Owing to the increased fineness of the texture of the process block as compared with the wood engraving, it was found that the blanket was too coarse and soft a material, and that it interfered with the clearness and fineness of the printed result. Blankets of finer material were tried, with improved results; but at last the blanket was entirely superseded by a glazed board, the machinery was more accurately constructed, and the hard, finely-polished steel cylinder, without any intervening substance save the thin glazed board and the sheet of paper to be printed, was brought in contact with the type and blocks. The old soft blanket kept the cylinder or the flat press in contact with the type, in spite of the weak construction of much printing machinery. The new method of work made no allowance for such construction; and the new machinery, to meet the new conditions, had to be very perfect in manufacture. About the old machines there was a lack of solidity, which allowed vibration. Modern work demands absolute rigidity in the machine; and a chief characteristic of the best modern printing machinery is strength and solidity, admitting of precision of impression. Another change has been in the nature and treatment of the printing paper.

Most elaborate methods were adopted for the moistening of the substance of paper before use. Most paper was printed on whilst damp, but damp paper had to disappear with the soft blanket, and a clay-surfaced or highly-calendered paper was introduced with a glazed face in harmony with the polished steel cylinder which pressed it against the type and blocks. It is essential to this paper that it be dry when used; to ensure the best results with it the paper should be kept some weeks or months before use, so that it may be absolutely dry, or seasoned. If printed on too soon, the clay surface tears away when in contact with the "tacky" ink; and instead of the ink being deposited on the paper, bits of the paper surface are left on the forme, and white spots appear in the impression. The bits of paper surface so deposited on the forme get inked as they pass under the rollers, and impress black spots on the sheets that come after. New and unseasoned paper accounts for much bad printing, and this form of badness is due to the change in material due to the necessities of modern process work.

3. *Planographic processes* are such as are printed from a flat surface neither raised above the surrounding ground like a wood engraving or type letter, nor sunk below the ground like an etching or steel engraving. Lithography (*q.v.*) with its flat stone or plate may be taken as the type.

Woodbury type is a development rather than an invention by Walter Woodbury. By an old nature-printing process leaves and other things which lent themselves to the treatment were by extreme pressure forced into a flat surface of soft metal, and the mould so formed was used as a printing surface to reproduce the forms of the impressed object. Woodbury found that a film of bichromated gelatin exposed to the action of light under a negative and the unaffected parts washed away gave him a relief image which was so hardened by the action of light aided by other hardening agents, that it could with no injury to the film itself—which could be used many times to make fresh moulds—be forced by hydraulic pressure into a thin flat plate of lead or type metal, and that the mould so formed could be used in a similar way to the mould formed in the old nature printing process. But a Woodbury type print is rather a cast from the shallow mould than a print in the true sense. It is obtained by filling the mould with a warm solution of coloured gelatin and pressing on it a piece of hard surfaced paper. The pressure forces the solution away from the highest parts of this mould which come in actual contact with the paper, so that none of it is left between them and the surface of the paper which in these parts remains uncoloured. These are the high lights of the print. The pressure forces the colouring matter into the hollows of the mould, and this amount is graduated according to the depth of the hollows. The coloured gelatin gradually cools and hardens and adheres to the paper which on its removal from the mould retains a delicate cast of the impressed subject. The variety of light and shade is the result of the varying depth of the hollows and the consequent variation of the amount of colouring matter taken up by the impressed paper. The white paper is an important element in the result, the light reflected from it through this coloured gelatin varying according to the thickness of the gelatin film. A drawback to the use of the Woodbury type for book illustration is that every print has to be trimmed and mounted, and of course it cannot be printed with type.

Stannotype is a variation upon Woodbury type. It is an attempt to do away with the need of the hydraulic press for the making of the mould. A film of bichromated gelatin is exposed to the action of light under a positive instead of a negative and the unaffected parts washed away, by which means a mould is obtained corresponding exactly to that obtained in metal by pressure from a film exposed to light under a negative. This mould was covered by a coating of tin foil to give it the necessary metal surface, and good results were obtained from it, but for some reason it has never come much into use.

Collotype or *phototype* is a process in which the film of isinglass, gelatin or gum, treated with bichromate of potash with the addition of alum or some other hardening substance, becomes an actual printing surface inked with an ordinary roller and printed by an ordinary machine. A strong tough film made up of a first coating of a simple gelatinous nature covered by a second film of the sensitive bichromated gelatin is spread upon glass and allowed to dry. Exposed to light under a reversed negative

the unprotected parts are hardened in proportion to the amount of protection they receive from the negative. After exposure under the negative the back of the film is exposed to the action of sunlight through the glass at its back, so that the whole film may be rendered as hard and tough and durable as possible to stand the wear and tear of the process of printing. When in its place in the printing press the film must be kept moistened. The soft parts unacted upon by the light, but from which the bichromate has been since washed, will absorb moisture in proportion to the action the light has exercised upon it, the absolutely hard parts refusing moisture altogether. The film may now be inked with an ordinary inking roller, the ink being freely taken up by the hard and unmoistened passages and by the partly hardened in proportion to the amount of moisture they are capable of absorbing; as in lithography, the constant moistening of the printing surface is a necessity. Collotype is largely used for postcards. It may be printed in a lithographic or ordinary vertical press of the letterpress printer. Admirable colour results are obtained by this process.

Heliotype is a variation of the method of producing the film which is first spread as described upon waxed glass and then stripped from the glass when dry. After hardening the back of the film it is laid down upon a metal plate and firmly secured to it by the use of an india-rubber cement. It is remarkable the admirable results that are obtainable by so delicate a process. The films have not a long life; a few hundreds only can be printed from each, but the renewal of the film is a simple matter. The result is very like a photograph. The use of heliotype is, however, practically obsolete.

Photolithography.—Zinc or aluminium plates are now frequently used instead of the more cumbersome stones for all so called lithographic printing. These plates have the same affinity for fat ink as stone, the method of dealing with them being practically the same as with stones, and the description may be taken as applying to both. The stone itself may be rendered sensitive by coating it with a thin film of bichromated gelatin, exposing it under a reversed negative of the required subject and treating the hardened film as it is treated in the case of collotype. A better plan is to render sensitive a sheet of unsized or transfer paper which is exposed under a negative, moistened, and rolled with transfer ink, which is of a specially fatty nature, and adheres only to the parts hardened by exposure which are unaffected by the moistening and remain dry. This inked sheet is laid upon the stone and the two together are subjected to great pressure, passing through a lithographic press. After further moistening the sheet of transfer paper is peeled off, the stone leaving the inked drawing behind it. The usual methods of lithography are then followed, the stone is treated with a preparation of acid and gum, kept moist and printed from in the ordinary lithographic method. Lithography of all kinds can only deal with lines or solid blocks. Tints present difficulties which are best dealt with by other methods of reproduction, but attempts have been made to obtain tints lithographically by breaking up the solid surfaces of the gelatin print with a grain before rolling it with ink and transferring it to the stone.

One of the most successful of such attempts is known as the *Ink Photo* process, which is more or less of a secret process worked by Messrs Sprague. None of them, however, yield so sound a result as a good drawing made in line, as the grain has a tendency to fill up. Transfers may also be made on to zinc plates which will take the lithographic ink equally well with stones. The plates may be etched—as the inked surfaces resist the action of acid—and by this means a relief plate made, which when mounted on a block, type-high, may be printed typographically. It is known in this form as zincography.

AUTHORITIES.—Eugène Michel Chevreul, *Considérations sur la reproduction par les procédés de M. Niepce de Saint Victor des images gravées dessinées ou imprimées* (Paris, 1847); Niepce de Saint Victor, *Mémoire sur la gravure héliographique sur acier et sur verre* (Baignolles, 1854); Niepce de Saint Victor, *Traité pratique de la gravure héliographique sur acier et sur verre* (Paris, 1856); Alexander de

Courcy Scott, *On Photo-Zincography and other Photographic Processes employed at the Ordnance Survey Office, Southampton* (London, 1862); G. Field, *Chromography* (London, 1885); C. Motteroz, *Essai sur les gravures chimiques en relief* (Paris, 1871); Dr H. Vogel and J. R. Sawyer, *Das photographische Pigment Verfahren oder der Kohleindruck* (Berlin); W. von Bezold, *Theory of Colours*, 1876; (Boston, U.S.A., 1891); J. Husnik, *Das Gesamtgebiet des Lichtdrucks* (Vienna, 1880, and editions); Ceymet, *Traité pratique de phototypie* (Paris, 1883, and editions); W. T. Wilkinson, *Photo-Engraving on Zinc and Copper, in Line and Half-Tone* (London, 1886); Alexander Leslie, *The Practical Instructor of Photo-Engraving and Zinc-Engraving Processes* (New York, and editions); E. Leitze, *Modern Heliographic Processes* (New York, 1899); W. T. Wilkinson, *Photo-Engraving* (London, and editions); Professor Church, *Colour* (London, 1891); W. de W. Abney, *Colour Measurement and Mixture* (London, 1891); R. Meldola, *The Chemistry of Photography* (London, 1891); Colonel Waterhouse, *Practical Notes on the Preparation of Drawings for Photographic Reproduction* (London, 1890); Carl Schraubstaedler, *Photo-Engraving; a Practical Treatise on the Production of Printing Blocks by Modern Photographic Methods* (St Louis, U.S.A., 1892); Dr H. Vogel, *The Chemistry of Light* (London, 1892); S. R. Koehler, *Museum of Fine Arts: a Catalogue of an Exhibition illustrating Reproduction Methods down to the Latest Times* (Boston, U.S.A., 1892); Jules Adeline, *Les Arts de reproduction vulgarisés* (Paris); Sir J. Norman Lockyer, *Studies in Spectrum Analysis* (London, 1894); H. D. Farquhar, *The Grammar of Photo-Engraving*, trans. from the German (London); C. G. Zander, *Photo-Trichromatic Printing* (Leicester, 1896); H. W. Singer and William Strang, *Etching, Engraving, and other Methods of Printing Pictures* (London, 1897); W. Gamble, "The History of the Half-tone Dot," (*The Photographic Journal*, Feb. 20, 1897); T. D. Bolas and others, *A Handbook of Photography in Colours* (London, 1900); W. de W. Abney, *Photography*. Penrose's *Process Annual* contains each year a list of the latest works dealing with the development and progress of mechanical photo processes. (E. BA.)

PROCESS, in law, in the widest sense of the word, any means by which a court of justice gives effect to its authority. In the old practice of the English common law courts process was either original or judicial. Original process was a means of compelling a defendant to compliance with an original writ (see WRIT). Judicial process was any compulsory proceeding rendered necessary after the appearance of the defendant. Process was also divided in civil matters into original, mesne and final. Original process in this sense was any means taken to compel the appearance of the defendant. A writ of summons is now the universal means in the High Court of Justice. Mesne process was either any proceeding against the defendant taken between the beginning and the end of the action, such as to compel him to give bail, or was directed to persons not parties to the action, such as jurors or witnesses. Arrest on mesne process was abolished in England by the Debtors Act 1869. Final process is practically coexistent with execution. In criminal matters process only applies where the defendant does not appear upon summons or otherwise. A warrant is now the usual form of such process.

Stet processus was a technical term used in old common law practice. It consisted of an entry on the record by consent of the parties for a stay of proceedings. Since the Judicature Acts there has been no record, and the *stet processus* has disappeared with it.

In Scots law process is used in a much wider sense, almost equivalent to practice or procedure in English law. Where papers forming steps of a process are borrowed and not returned, the return of the borrowed process may be enforced by caption (attachment). The Scottish process is very much akin to the French *dossier*.

In the United States process is governed by numerous statutes, both of Congress and of the state legislatures. The law is founded upon the English common law.

PROCESSION¹ (M. Eng., *processioun*, Fr., *procession*, Lat., *processio*, from *procedere*, to go forth, advance, proceed), in general, an organized body of people advancing in a formal or ceremonial manner. This definition covers a wide variety of such progresses: the medieval pageants, of which the Lord

¹ In classical Latin the word generally used for a procession was *pompa*, a formal march or progress of persons to some particular spot, to celebrate some event, or for some public or religious purpose. *Processio* is used by Cicero in the sense of "a marching forward, an advance," any public progress, such as the formal entrance of the consul upon his office (Du Cange, s.v. *Processio*), or the public appearance of the emperor. In Late Latin *processio* is generally used of a religious procession, the word having come to be used of the body of persons advancing or proceeding.

Mayor's show in London is the most conspicuous survival; the processions connected with royal coronations and with court ceremonies generally; the processions of friendly societies, so popular in Great Britain and America; processions organized as a demonstration of political or other opinions; processions forming part of the ceremonies of public worship. In a narrower sense of "going forth, proceeding," the term is used in the technical language of theology in the phrase "Procession of the Holy Ghost," expressing the relation of the Third Person in the Triune Godhead to the Father and the Son.

Processions have in all peoples and at all times been a natural form of public celebration, as forming an orderly and impressive way in which a number of persons can take part in some ceremony. They are included in the celebrations of many religions, and in many countries, both in the East and West, they accompany such events as weddings and funerals. Religious and triumphal processions are abundantly illustrated by ancient monuments, e.g. the religious processions of Egypt, those illustrated by the rock-carvings of Boghaz-Keui (see PTERIA), the many representations of processions in Greek art, culminating in the great Panathenaic procession of the Parthenon frieze, and Roman triumphal reliefs, such as those of the arch of Titus.

Processions played a prominent part in the great festivals of Greece, where they were always religious in character. The games were either opened or accompanied by more or less elaborate processions and sacrifices, while processions from the earliest times formed part of the worship of the old nature gods (e.g. those connected with the cult of Dionysus, &c.), and later formed an essential part of the celebration of the great religious festivals (e.g. the processions of the Thesmophoria, and that of the Great Dionysia), and of the mysteries (e.g. the great procession from Athens to Eleusis, in connexion with the Eleusinia).

Of the Roman processions, the most prominent was that of the Triumph, which had its origin in the return of the victorious army headed by the general, who proceeded in great pomp from the Campus to the Capitol to offer sacrifice, accompanied by the army, captives, spoils, the chief magistrate, priests bearing the images of the gods, amidst strewing of flowers, burning of incense and the like (Ovid, *Trist.* iv. 2, 3 and 6). Connected with the triumph was the *pompa circensis*, or solemn procession which preceded the games in the circus; it first came into use at the *ludi romani*, when the games were preceded by a great procession from the Capitol to the Circus. The praetor or consul who appeared in the *pompa circensis* wore the robes of a triumphing general (see Mommsen, *Staatsrecht* I. 397 for the connexion of the triumph with the *ludi*). Thus, when it became customary for the consul to celebrate games at the opening of the consular year, he came, under the empire, to appear in triumphal robes in the *processus consularis*, or procession of the consul to the Capitol to sacrifice to Jupiter. After the establishment of Christianity, the consular processions in Constantinople retained their religious character, now proceeding to St Sophia, where prayers and offerings were made; but in Rome, where Christianity was not so widely spread among the upper classes, the tendency was to convert the procession into a purely civil function, omitting the pagan rites and prayers, without substituting Christian ones (Dahremberg and Saglio, s.v. "Consul"). Besides these public processions, there were others connected with the primitive worship of the country people, which remained unchanged, and were later to influence the worship of the Christian Church. Such were those of the Ambarvalia, Robigalia, &c., which were essentially rustic festivals, lustrations of the fields, consisting in a procession round the spot to be purified, leading the sacrificial victims with prayers, hymns and ceremonies, in order to protect the young crops from evil influences. (See Preller, *Röm. Mythologie*, pp. 370-372.)

As to the antiquity of processions as part of the ritual of the Christian Church, there is no absolute proof of their existence before the 4th century, but as we know that in the catacombs stations were held at the tombs of the martyrs on the anniversary of their death, for the celebration of the eucharist, it

is quite probable that the faithful proceeded to the appointed spot in some kind of procession, though there is no satisfactory evidence that this was the case. There are, indeed, early instances of the use of the word *processio* by Christian writers, but it does not in any case appear to have the modern meaning "procession." Tertullian (2nd century) uses *processio* and *procedere* in the sense of "to go out, appear in public,"¹ and, as applied to a church function, *processio* was first used in the same way as *collecta*, as the equivalent of the Greek *συναξίς*, i.e. for the assembly of the people in the church (Du Cange, s.v.). In this sense it appears to be used by Pope Leo I. (*Ep. IX. ad Diosc. episc.* c. 445: "qui nostris processionibus et ordinationibus frequenter interfuit"), while in the version by Dionysius Exiguus of the 17th canon of the Council of Laodicea *συναξίσει*, is translated by *processionibus* (Smith, *Dic. of Chr. Antiq.* s.v. "Procession").

For the processions that formed part of the ritual of the eucharist, those of the introit, the gospel and the oblation, the earliest records date from the 6th century and even later (see Duchesne, *Origines*, 2nd ed., pp. 77, 154, 181; 78, 194), but they evidently were established at a much earlier date. As to public processions, these seem to have come into rapid vogue after the recognition of Christianity as the religion of the empire. Those at Jerusalem would seem to have been long established when described by the authoress of the *Peregrinatio Silviae* towards the end of the 4th century (see PALM SUNDAY, for the procession of palms).

Very early were the processions accompanied by hymns and prayers, known as *litaniae* (Gr. *λιτανεία*, from *λήτή*, prayer), *rogationes* or *supplicationes* (see LITANY). It is to such a procession that reference appears to be made in a letter² of St Basil (c. 375), which would thus be the first recorded mention of a public Christian procession. The first mention for the Western Church occurs in St Ambrose (c. 388, *Ep.* 40 § 16, *Ad Theodos.* "monachos . . . qui . . . psalmos canentes ex consuetudine usumque veteri pergebant ad celebritatem Machabaeorum martyrum"). In both these cases the litanies are stated to have been long in use. There is also mention of a procession accompanied by hymns, organized at Constantinople by St John Chrysostom (c. 390-400) in opposition to a procession of Arians, in Sozomen, *Hist. eccl.* viii. 8.³ In times of calamity litanies were held, in which the people walked in robes of penitence, fasting, barefooted, and, in later times, frequently dressed in black (*litaniae nigrae*). The cross was carried at the head of the procession and often the gospel and the relics of the saint were carried. Gregory of Tours gives numerous instances of such litanies in time of calamity; thus he describes (*Vita S. Remig.* I.) a procession of the clergy and people round the city, in which relics of St Remigius were carried and litanies chanted in order to avert the plague. So, too, Gregory the Great (*Ep.* xi. 57) writes to the Sicilian bishops to hold processions in order to prevent a threatened invasion of Sicily. A famous instance of these penitential litanies is the *litanía septiformis* ordered by Gregory the Great in the year 590, when Rome had been inundated and pestilence had followed.

¹ See *De praescr. adv. haer.* C. xliii., "Ubi metus in Deum, ibi gravitas honesta . . . et subjectio religiosa, et apparitio devota, et *processio modesta*, et Ecclesia unita et Dei omnia," where it would seem to mean "a modest bearing in public;" also *De cultu foem.* ii. xi., "Vobis autem nulla procedendi causa tetrica; aut imbecillus aliquis ex fratribus visitandus, aut sacrificium offertur, aut Dei verbum administratur," which shows that *procedere* was not used only of going to church. The passage *ad uxorem*, ii. 4, which is sometimes quoted to prove the existence of processions at this date, appears to use *procedere* in the same way as the above passages; "... si procedendum erit, nunquam magis familiae occupatio obveniat. Quis enim sinat conjugem suam visitandorum fratrum gratia vicatim aliena ac quidem pauperiora quaeque turgida circumire? . . . quis denique solemnibus Paschae abnoctantem securus sustinebit?"

² *Ep.* 207 *ad Neocaes.*: 'Αλλ' οὐκ ἦν, φησὶ, ταῦτα ἐπὶ τοῦ μεγάλου Γρηγορίου. 'Αλλ' οὐδὲ αἱ Λιτανεῖαι, ἃς ὑμεῖς νῦν ἐπιτελεῖτε κ. τ. λ.

³ Brawls having arisen with the Catholics, who began singing their hymns in opposition, the emperor prohibited the Arian meetings.

In this litany seven processions, of clergy, laymen, monks, nuns, matrons, the poor, and children respectively, starting from seven different churches, proceeding to hear mass at Sta Maria Maggiore (see Greg. of Tours, *Hist. Fr.* x.1, and Johann. Diac. *Vita Greg. Magn.* i. 42). This litany has often been confused with the *litania major*, introduced at Rome in 598 (*vide supra*), but is quite distinct from it.¹

Funeral processions, accompanied with singing and the carrying of lighted tapers, were very early customary (see LIGHTS, CEREMONIAL USE OF), and akin to these, also very early, were the processions connected with the translation of the relics of martyrs from their original burying place to the church where they were to be enshrined (see e.g. St Ambrose, *Ep.* 29 and St Augustine, *De civitate Dei*, xxii. 8 and *Conf.* viii. 7, for the finding and translation of the relics of Saints Gervasius and Protasius). From the time of the emperor Constantine I. these processions were of great magnificence.²

Some liturgists maintain that the early Church in its processions followed Old Testament precedents, quoting such cases *Origin of Christian Processions* as the procession of the ark round the walls of Jericho (Josh. vi.), the procession of David with the ark (2 Sam. vi.), the processions of thanksgiving on the return from captivity, &c. The liturgy of the early Church as Duchesne shows (*Origines*, ch. i.) was influenced by that of the Jewish synagogue, but the theory that the Church adopted the Old Testament ritual is of quite late growth. What is certain is that certain festivals involving processions were adopted by the Christian Church from the pagan calendar of Rome. Here we need only mention the *litaniae majores et minores*, which are stated by Üsener ("Alte Bittgänge," in Zeller, *Philosophische Aufsätze*, p. 278 seq.) to have been first instituted by Pope Liberius (352-366). It is generally acknowledged that they are the equivalent of the Christian Church of the Roman lustrations of the crops in spring, the *Ambarvalia*, &c. The *litania major*, or great procession on St Mark's day (April 25) is shown to coincide both in date and ritual with the Roman Robigalia, which took place *a.d. vii. Kal. Mai.*, and consisted in a procession leaving Rome by the Flaminian gate, and proceeding by way of the Milvian bridge to a sanctuary at the 5th milestone of the Via Claudia, where the *flamen quirinalis* sacrificed a dog and a sheep to avert blight (*robigo*) from the crops (*Fasti praenestini*, C.T.L.T., p. 317). The *litania major* followed the same route as far as the Milvian bridge, when it turned off and returned to St Peter's, where mass was celebrated. This was already established as an annual festival by 598, as is shown by a document of Gregory the Great (*Regist.* ii.) which inculcates the duty of celebrating *litaniam, quae major ab omnibus appellatur*. The *litaniae minores* or rogations, held on the three days preceding Ascension Day, were first introduced into Gaul by Bishop Mamertus of Vienne (c. 470), and made binding for all Gaul by the 1st Council of Orleans (511). The *litaniae minores* were also adopted for these three days in Rome by Leo III. (c. 800). A description of the institution and character of the Ascensiontide rogations is given by Sidonius Apollinaris (*Ep.* v. 14). "The solemnity of these," he says, "was first established by Mamertus. Hitherto they had been erratic, lukewarm and poorly attended (*vagae, tepentes, infrequentesque*); those which he instituted were characterized by fasting, prayers, psalms and tears." In the Ambrosian rite the rogations take place after Ascensiontide, and in the Spanish on the Thursday to Saturday after Whitsuntide, and in November (Synod of Girona, 517).

¹ Litanies, owing to the fact that they were sung in procession were in England sometimes themselves called "processions." Thus we read in the "Order of making Knights of the Bath for the coronation of Queen Elizabeth": "the parson of the said church knelynge said the procession in Englysche and all that were there answered the parson" (B. M. Add. MSS. 4712, p. 51, printed in Anstis's *Observations*, p. 53).

² See Martigny, *Dict. des antiquités chr. s.v.* "Processions," "Stations," "Translations" for details of processions under Constantine, and Du Cange, *s.v. Processio* for various processions in the middle ages.

It is impossible to describe in detail the vast development of processions during the middle ages. The most important and characteristic of these still have a place in the ritual of the Roman Catholic Church. The rules governing them are laid down in the *Rituale Romanum* (Tit. ix.), and they are classified in the following way:—

(1) *Processiones generales*, in which the whole body of the clergy takes part. (2) *Processiones ordinariae*, on yearly festivals, such as the feast of the Purification of the Virgin (Candlemass, *q.v.*), the procession on Palm Sunday (*q.v.*), the *Litaniae majores* and *minores*, the feast of Corpus Christi (*q.v.*), and on other days, according to the custom of the churches. (3) *Processiones extraordinariae*, or processions ordered on special occasions, e.g. to pray for rain or fine weather, in time of storm, famine, plague, war, or, in *quacunq̄ tribulatione*, processions of thanksgiving, translation of relics, the dedication of a church or cemetery. There are also processions of honour, for instance to meet a royal personage, or the bishop on his first entry into his diocese (*Pontif. rom.* iii.). Those taking part in processions are to walk bare-headed (weather permitting), two and two, in decent costume, and with reverent mien; clergy and laity, men and women, are to walk separately. The cross is carried at the head of the procession, and banners embroidered with sacred pictures in places where this is customary; these banners must not be of military or triangular shape. Violet is the colour prescribed for processions, except on the Feast of Corpus Christi, or on a day when some other colour is prescribed. The officiating priest wears a cope, or at least a surplice with a violet stole, the other priests and clergy wear surplices.

Where the host is carried in procession it is covered always by a canopy, and accompanied by lights. At the *litaniae majores* and *minores* and other penitential processions, joyful hymns are not allowed, but the litanies are sung, and, if the length of the procession requires, the penitential and gradual psalms.

As to the discipline regarding processions the bishop, according to the Council of Trent (*Sess.* 25 *de reg. cap.* 6), appoints and regulates processions and public prayers outside the churches.

The observance or variation of the discipline belongs to the Congregation of Rites; in pontifical processions, which are regulated by the masters of the ceremonies (*magistri ceremoniarum pontificalium*), these points are decided by the chief cardinal deacon. As to processions within the churches, some difference of opinion having arisen as to the regulating authority, the Congregation of Rites has decided that the bishop must ask, though not necessarily follow, the advice of the chapter in their regulation.

Reformed Churches.—The Reformation abolished in all Protestant countries those processions associated with the doctrine of transubstantiation (Corpus Christi); "the Sacrament of the Lord's Supper," according to the 28th Article of Religion of the Church of England "was not by Christ's ordinance reserved, carried about, lifted up, or worshipped." It also abolished those associated with the cult of the Blessed Virgin and the saints. The stern simplicity of Calvinism, indeed, would not tolerate religious processions of any kind, and from the "Reformed" Churches they vanished altogether. The more conservative temper of the Anglican and Lutheran communions, however, suffered the retention of such processions as did not conflict with the reformed doctrines, though even in these Churches they met with opposition and tended after a while to fall into disuse.

The Lutheran practice has varied at different times and in different countries. Thus, according to the *Württemberg Kirchenordnung* of 1553, a funeral procession was prescribed, the bier being followed by the congregation singing hymns; the Brandenburg *Kirchenordnung* (1540) directed a cross-bearer to precede the procession and lighted candles to be carried, and this was prescribed also by the Waldeck *Kirchenordnung* of 1556. At present funeral processions survive in general only in the country districts; the processional cross or crucifix is still carried. In some provinces also the Lutheran Church has retained the ancient rogation processions in the week before Whitsuntide and, in some cases, in the month of May or on special occasions (e.g. days of humiliation, *Busstage*), processions about the fields to ask a blessing on the crops. On these occasions the ancient litanies are still used.

In England "the perambulations of the circuits of the parishes . . . used heretofore in the days of rogations" were ordered to be observed by the *Injunctions* of Queen Elizabeth in 1559; and for these processions certain "psalms, prayers and homilies"

Processions in the modern Roman Catholic Church.

Lutheran Church.

were prescribed. The Puritans, who aimed at setting up the Genevan model, objected; and the visitation articles of the bishops in Charles I.'s time make frequent inquisition into the neglect of the clergy to obey the law in this matter. With "the profane, ungodly, presumptuous multitude" (to quote Baxter's *Saint's Rest*, 1650, pp. 344, 345), however, these "processions and perambulations" appear to have been very popular, though "only the traditions of their fathers." However this may be, the Commonwealth made an end of them, and they seem never to have been revived; Sparrow, in his *Rationale upon the Book of Common Prayer* (London, 1668), speaks of "the service formerly appointed in the Rogation days of Procession."

Among the processions that survived the Reformation in the English Church was that of the sovereign and the Knights of the Garter on St George's day. This was until Charles II.'s time a regular rogation, the choristers in surplices, the gentlemen of the royal chapel in copes, and the canons and other clergy in copes preceding the knights and singing the litany. In 1661, after the Restoration, by order of the sovereign and knights companions in chapter "that supplicational procession" was "converted into a hymn of thanksgiving." Akin to this procession also are the others connected with royal functions; coronations, funerals. These retained, and retain, many pre-Reformation features elsewhere fallen obsolete. Thus at the funeral of George II. (1760) the body was received at the door of the Abbey by the dean and prebendaries in their copes, attended by the choir, all carrying lighted tapers, who preceded it up the church, singing.

The only procession formerly prescribed in the Book of Common Prayer is that in the order of the burial of the dead, where the rubric directs that "the priest and clerks meeting the corpse at the entrance of the churchyard, and going before it, either into the church, or towards the grave, shall say, or sing" certain verses of Scripture. Tapers seem to have been carried, not only at royal funerals, until well into the 18th century (see LIGHTS, CEREMONIAL). Processions, with singing of the litany or of hymns, appear also to have been always usual on such occasions as the consecration of churches and churchyards and the solemn reception of a visiting bishop. Under the influence of the Catholic revival, associated with the Oxford Tractarians, processions have become increasingly popular in the English Church, pre-Reformation usages having in some churches been revived without any legal sanction. The most common forms, however, are the processional litanies, and the solemn entry of clergy and choir into the church, which on festivals is accompanied by the singing of a processional hymn, their exit being similarly accompanied by the chanting of the *Nunc Dimittis*. In this connexion the use of the processional cross, banners and lights has been largely revived.

See the article "Bittgänge," by M. Herold, in Herzog-Hauck, *Realencyklopädie*, iii. 248 (3rd ed., Leipzig, 1897); Wetzler und Welte, *Kirchenlexikon*, s.v. "Prozession, Bittgänge Litanei" and Smith's *Dictionary of Christian Antiquities* s.v. "Procession." For the early ritual see Duchesne, *Origines du culte chrétien* (3rd ed., Paris, 1903). See also G. Catalani, *Rituale romanum perpetuis commentariis exornatum* (1760); N. Serarius, *Sacri peripatetici de sacris ecclesiae catholicae processionibus* (2 vols., Cologne, 1607); Jac. Gretser, *De ecclesiae romanae processionibus* (2 vols., Ingolstadt, 1606); Jac. Eveillon, *De processionibus ecclesiae* (Paris, 1641); Edw. Martène, *De antiquis ecclesiae ritibus* (3 vols., Antwerp, 1763), &c. For the past usage of the Church of England, *Hierurgia anglicana*, ed. Vernon Staley, p. ii pp. 3-22 (London, 1903).

PROCESSION PATH (Lat. *ambitus templi*), the route taken by processions on solemn days in large churches—up the north aisle, round behind the high altar, down the south aisle, and then up the centre of the nave.

PROCÈS-VERBAL (Fr. *procès*, process, Late Lat. *verbalis*, from *verbum*, word), in French law, a detailed authenticated account drawn up by a magistrate, police officer, or other person having authority of acts or proceedings done in the exercise of his duty. In a criminal charge, a *procès-verbal* is a statement of the facts of the case. The term is also sometimes applied to the written minutes of a meeting or assembly.

PROCIDA (Gr. *Προχίτη*, Lat. *Prochyta*), an island off the coast of Campania, Italy, 2 m. S.W. of Capo Miseno, and 2 m. N.E. of Ischia on the west side of the Gulf of Naples, and about 12 m. S.W. of Naples. Pop. (1901), of the town, 2520; of the whole island, one commune, 14,440. It is about 2 m. in length and of varying width, and, reckoning in the adjacent island of Vivara, is made up of four extinct craters, parts of the margins of all of which have been destroyed by the sea. The highest point of it is only 250 ft. above sea-level. It is very fertile, and the population is engaged in the cultivation of vines and fruit and in fishing. Procida, the only town, lies on the east side; its castle is now a prison. It also contains a royal palace. Classical authors explained the name of Procida either as an allusion to its having been detached from Ischia, or as being that of the nurse of Aeneas.

PROCLAMATION (Lat. *proclamare*, to make public by announcement), in English law, a formal announcement (royal proclamation), made under the great seal, of some matter which the king in council desires to make known to his subjects: e.g. the declaration of war, the statement of neutrality, the summoning or dissolution of parliament, or the bringing into operation of the provisions of some statute the enforcement of which the legislature has left to the discretion of the king in council. Royal proclamations of this character, made in furtherance of the executive power of the Crown, are binding on the subject, "where they do not either contradict the old laws or tend to establish new ones, but only confine the execution of such laws as are already in being in such manner as the sovereign shall judge necessary" (Blackstone's *Commentaries*, ed. Stephen, ii. 528; Stephen's *Commentaries*, 14th ed. 1903, ii. 506, 507; Dicey, *Law of the Constitution*, 6th ed., 51). Royal proclamations, which, although not made in pursuance of the executive powers of the Crown, either call upon the subject to fulfil some duty which he is by law bound to perform, or to abstain from any acts or conduct already prohibited by law, are lawful and right, and disobedience to them (while not of itself a misdemeanour) is an aggravation of the offence (see charge of Chief Justice Cockburn to the grand jury in *R. v. Eyre* (1867) and Case of Proclamations 1610, 12 Co. Rep. 74). The Crown has from time to time legislated by proclamation; and the Statute of Proclamations 1539 provided that proclamations made by the king with the assent of the council should have the force of statute law if they were not prejudicial to "any person's inheritance, offices, liberties, goods, chattels or life." But this enactment was repealed by an act of 1547; and it is certain that a proclamation purporting to be made in the exercise of legislative power by which the sovereign imposes a duty to which the subject is not by law liable, or prohibits under penalties what is not an offence at law, or adds fresh penalties to any offence, is of no effect unless itself issued in virtue of statutory authority (see also ORDER IN COUNCIL). The Crown has power to legislate by proclamation for a newly conquered country (Jenkyns, *British Rule and Jurisdiction beyond the Seas*); and this power was freely exercised in the Transvaal Colony during the Boer War of 1899-1902. In the British colonies, ordinances are frequently brought into force by proclamation; certain imperial acts do not take effect in a colony until there proclaimed (e.g. the Foreign Enlistment Act 1870); and proclamations are constantly issued in furtherance of executive acts. In many British protectorates the high commissioner or administrator is empowered to legislate by proclamation.

In the old system of real property law in England, fines, levied with "proclamations," i.e. with successive public announcements of the transaction in open court, barred the rights of strangers, as well as parties, in case they had not made claim to the property conveyed within five years thereafter (acts 1483-1484 and 1488-1489). These proclamations were originally made sixteen times, four times in the term in which the fine was levied, and four times in each of the three succeeding terms. Afterwards the number of proclamations was reduced to one in each of the four terms. The proclamations were endorsed on the back of the record. The system was abolished by the Fines and Recoveries Act 1833. (A. W. R.)

PROCLUS, or **PROCLUSUS** (A.D. 410-485), the chief representative of the later Neoplatonists, was born at Constantinople, but

brought up at Xanthus in Lycia. Having studied grammar under Orion and philosophy under Olympiodorus the Peripatetic, at Alexandria, he proceeded to Athens. There he attended the lectures of the Neoplatonists Plutarch and Syrianus, and about 450 succeeded the latter in the chair of philosophy (hence his surname Diadochus, which, however, is referred by others to his being the "successor" of Plato). As an ardent upholder of the old pagan religion Proclus incurred the hatred of the Christians, and was obliged to take refuge in Asia Minor. After a year's absence he returned to Athens, where he remained until his death. His epitaph, written by himself, is to be found in *Anthologia palatina*, vii. 451. Although possessed of ample means, Proclus led a most temperate, even ascetic life, and employed his wealth in generous relief of the poor. He was supposed to hold communion with the gods, who endowed him with miraculous powers. He acted up to his famous saying that "the philosopher should be the hierophant of the whole world" by celebrating Egyptian and Chaldaean as well as Greek festivals, and on certain days performing sacred rites in honour of all the dead.

His great literary activity was chiefly devoted to the elucidation of the writings of Plato. There are still extant commentaries on the *First Alcibiades*, *Parmenides*, *Republic*, *Timaeus* and *Cratylus*. His views are more fully expounded in the *Περὶ τῆς κατὰ Πλάτωνα θεολογίας* (*In Platonis theologiam*). The *Στοιχείωσις θεολογική* (*Institutio theologica*) contains a compendious account of the principles of Neoplatonism and the modifications introduced in it by Proclus himself. The pseudo-Aristotelian *De causis* is an Arabic extract from this work, ascribed to Alfarabius (d. 950), circulated in the west by means of a Latin translation (ed. O. Bardenhewer, Freiburg, 1882). It was answered by the Christian rhetorician Procopius of Gaza in a treatise which was deliberately appropriated without acknowledgment by Nicolaus of Methone, a Byzantine theologian of the 12th century (see W. Christ, *Gesch. der griechischen Litteratur*, 1898, § 692). Other philosophical works by Proclus are *Στοιχείωσις φυσική ἢ Περὶ κινήσεως* (*Institutio physica sive De motu*, a compendium of the last five books of Aristotle's *Περὶ φυσικῆς ἀκροάσεως*, *De physica auscultatione*), and *De providentia et fato*, *Decem dubitationes circa providentiam*, *De malorum subsistentia*, known only by the Latin translation of William of Moerbeke (archbishop of Corinth, 1277-1281), who also translated the *Στοιχείωσις θεολογική* into Latin. In addition to the epitaph already mentioned, Proclus was the author of hymns, seven of which have been preserved (to Helios, Aphrodite, the Muses, the Gods, the Lycian Aphrodite, Hecate and Janus, and Athena), and of an epigram in the Greek Anthology (*Anthol. pal.* iii. 3, 166 in Didot edition.) His astronomical and mathematical writings include *ὑποτύπωσις τῶν ἀστρονομικῶν ὑποθέσεων* (*Hypotyposis astronomicarum positionum*, ed. C. Manitius, Leipzig, 1909); *Περὶ σφαιρας* (*De sphaera*); *Παράφρασις εἰς τὴν Πτολεμαίου τετράβιβλον*, a paraphrase of the difficult passages in Ptolemy's astrological work *Tetrabiblus*; *Εἰς τὸ πρῶτον τῶν Εὐκλείδου στοιχείων*, a commentary on the first book of Euclid's *Elements*; a short treatise on the effect of eclipses (*De effectibus eclipsium*, only in a Latin translation).

His grammatical works are: a commentary on the *Works and Days* of Hesiod (incomplete); some scholia on Homer; an elementary treatise on the epistolary style, *Περὶ ἐπιστολιμαίου χαρακτήρος* (*Characteres epistolici*), attributed in some MSS. to Libanius. The *Χρηστομαθία γραμματική* by Proclus, who is identified by Suidas with the Neoplatonist, is probably the work of a grammarian of the 2nd or 3rd century, though Wilamowitz-Möllendorff (*Philolog. Untersuch.* vii.; supported by O. Immisch in *Festschrift Th. Gomperz*, pp. 237-274) agrees with Suidas. According to Suidas, he was also the author of *Ἐπιχειρήματα ἢ κατὰ Χριστιανῶν* (*Animadversiones duodevigniti in christianos*). This work, identified by W. Christ with the *Institutio theologica*, was answered by Joannes Philoponus (7th century) in his *De aeternitate mundi*. Some of his commentary on the Chaldaean oracles (*Λόγια Χαλδαϊκά*) has been discovered in modern times.

There is no complete edition of the works of Proclus. The selection of V. Cousin (Paris, 1864) contains the treatises *De providentia et fato*, *Decem dubitationes*, and *De malorum subsistentia*, the commentaries on the *Alcibiades* and *Parmenides*. The *Institutio theologica* has been edited by G. F. Creuzer in the Didot edition of Plotinus (Paris, 1855); the *In Platonis theologiam* has not been reprinted since 1618, when it was published by Aemilius Portus with a Latin translation. Most recent editions of individual works are: Commentaries on the *Parmenides*, French translation with notes by A. E. Chaignet (1900-1903); *Republic*, by W. Kroll (1899-1901); *Timaeus*, by E. Diehl (1903-); *Hymns*, by E. Abel (1883) and A. Ludwig (1895); commentary on Euclid by G. Friedlein (1873); *Λόγια Χαλδαϊκά*, by A. Jahn (1891); *Characteres epistolici*, by A. Westermann (1856), Scholia to Hesiod in E. Vollbeh's edition (1844). Thomas Taylor, the "Platonist," translated the commentaries on the *Timaeus* and Euclid, *The Theology of Plato*, the *Elements of Theology*, and the three Latin treatises.

On Proclus generally and his works see article in Suidas; Marinus, *Vita Procli*; J. A. Fabricius, *Bibliotheca graeca* (ed. Harles), ix. 363-445; W. Christ, *Geschichte der griechischen Litteratur* (1898), § 623; J. E. Sandys, *Hist. of Classical Scholarship* (1906), i. 372; J. B. Bury, *Later Roman Empire* (1889), i. 13, where Proclus is styled the "Hegel of Neoplatonism"; on his philosophy, T. Whittaker, *The Neo-Platonists* (1901), and NEOPLATONISM.

Extracts from the *Χρηστομαθία* are preserved in Photius (*Cod.* 239), almost the only source of information regarding the epic cycle; on the question of authorship, see Christ § 637, and Sandys, p. 379; also D. B. Monro's appendix to his ed. of Homer's *Odyssey*, xiii.-xxiv. (1901).

PROCOPIUS, Byzantine historian, was born at Caesarea in Palestine towards the end of the 5th century A.D. He became a lawyer, probably at Constantinople, and was in 527 appointed secretary and legal adviser to Belisarius, who was proceeding to command the imperial army in the war against the Persians (*De bello persico* i. 12). When the Persian War was suspended and Belisarius was despatched against the Vandals of Africa in 533, Procopius again accompanied him, as he subsequently did in the war against the Ostrogoths of Italy, which began in 535. After the capture of Ravenna in 540 Procopius seems to have returned to Constantinople, since he minutely describes the great plague of 542 (*op. cit.* ii. 22). It does not appear whether he was with the Roman armies in the later stages of the Gothic War, when Belisarius and afterwards Narses fought against Totila in Italy; his narrative of these years is much less full and minute than that of the earlier warfare. Of his subsequent fortunes we know nothing, except that he was living in 559. Whether he was the Procopius who was prefect of Constantinople in 562 (Theophanes, *Chronographia*, 201, 202), and was removed from office in the year following, cannot be determined. As the historian was evidently a person of note, who had obtained the rank of *illustrius* (Suidas), and from a passage in the *Anecdota* (12) seems to have risen to be a senator, there is no improbability in his having been raised to the high office of prefect.

Procopius's writings fall into three divisions: the *Histories* (Persian, Vandal and Gothic Wars), in eight books; the treatise on the *Buildings of Justinian* (*De aedificiis*), in six books; and the *Unpublished Memoirs* (*Ἀνέκδοτα*, *Historia arcana*), so called because they were not published during the lifetime of the author.

The *Histories* are called by the author himself the *Books about the Wars* (*οἱ ὑπὲρ τῶν πολέμων λόγοι*). They consist of: (1) the Persian Wars, in two books, giving a narrative of the long struggle of the emperors Justin and Justinian against the Persian kings Kavadh and Chosroes Anushirvan down to 550; (2) the Vandal War, in two books, describing the conquest of the Vandal kingdom in Africa and the subsequent events there from 532 down to 546 (with a few words on later occurrences); (3) the Gothic War, in three books, narrating the war against the Ostrogoths in Sicily and Italy from 536 till 552. The eighth book contains a further summary of events down to 554. These eight books of *Histories*, although mainly occupied with military matters, contain notices of some of the more important domestic events, such as the Nika insurrection at Constantinople in 532, the plague in 542, the conspiracy of Artabenes in 548. They tell us, however, comparatively little about the civil administration of the empire, and nothing about legislation. On the other hand they are rich in geographical and ethnographical information.

As an historian Procopius is of quite unusual merit, when the generally low literary level of his age is considered. He is industrious in collecting facts, careful and impartial in stating them; his judgment is sound, his reflections generally acute, his conceptions of the general march and movement of things not unworthy of the great events he has recorded. His descriptions, particularly of military operations, are clear, and his especial fondness for this part of the subject seldom leads him into unnecessary minuteness. The style, although marked by mannerisms, by occasional affectations and rhetorical devices, is on the whole direct and businesslike, nor is the Greek bad for the period in which he wrote. His models are Thucydides and Herodotus. The former he imitates in the maxims (γνώμαι) he throws in and the speeches which he puts into the mouth of the chief actors; the latter in his frequent geographical digressions, in the personal anecdotes, in the tendency to collect and attach some credence to marvellous tales. The speeches are obviously composed by Procopius himself, rarely showing any dramatic variety in their language, but they seem sometimes to convey the substance of what was said; and even when this is not the case they frequently serve to bring out the points of a critical situation. Procopius is almost as much a geographer as an historian, and his descriptions of the people and places he himself visited are generally careful and thorough. Although a warmly patriotic Roman, he does full justice to the merits of the barbarian enemies of the empire, particularly the Ostrogoths; although the subject of a despotic prince, he criticizes the civil and military administration of Justinian and his dealings with foreign peoples with a freedom which gives a favourable impression of the tolerance of the emperor. His chief defects are a somewhat pretentious and at the same time monotonous style, and a want of sympathy and intensity.

The *De aedificiis* contains an account of the chief public works executed during the reign of Justinian down to 558 (in which year it seems to have been composed), particularly churches, palaces, hospitals, fortresses, roads, bridges and other river works throughout the empire. All these are of course ascribed to the personal action of the monarch. If not written at the command of Justinian (as some have supposed), it is evidently grounded on official information, and is full of gross flattery of the emperor and of the (then deceased) empress. In point of style it is greatly inferior to the *Histories*—florid, pompous and affected, and at the same time tedious. Its chief value lies in the geographical notices which it contains.

The *Anecdota* ("Secret History") purports to be a supplement to the *Histories*, containing explanations and additions which the author could not insert in the latter work for fear of Justinian and Theodora. It is a furious invective against these sovereigns, their characters, personal conduct and government, with attacks on Belisarius and his wife Antonina, and on other noted officials in the civil and military services of the empire. Owing to the ferocity and brutality of the attacks upon Justinian, the authenticity of the *Anecdota* has often been called in question, but the claims of Procopius to the authorship are now generally recognized. In point of style, the *Anecdota* is inferior to the *Histories*, and has the air of being unfinished, or at least unrevised. Its merit lies in the furious earnestness with which it is written, which gives it a force and reality sometimes wanting in the more elaborate books written for publication. The history of Philip of Macedon by Theopompus probably furnished the author with a model.

The best complete edition of Procopius is by J. Haury (Teubner Series, 1905); the *Gothic War* has been edited by D. Comparetti (1895-1898), with an Italian translation. There are English translations of the *History of the Wars*, by H. Holcroft (1653); of the *Anecdota* (1674, anonymous); of the *Buildings*, by Aubrey Stewart (1888, in *Palestine Pilgrims' Text Society*). Chief authorities: F. Dahn, *Procopius von Cäsarea* (1865); W. S. Teuffel in *Studien und Charakteristiken* (2nd ed., 1889); L. Ranke, *Weltgeschichte* (1883), iv. 2. On the genuineness of the *Anecdota* cf. J. B. Bury (who agrees with Ranke in rejecting the authorship of Procopius) *A History of the Later Roman Empire* (1889), vol. i., and introd. to vol. i. (p. 57) and app. to vol. iv. of his edition of

Gibbon's *Decline and Fall*. For the literature of the subject generally, see C. Krumbacher, *Geschichte der byzantinischen Litteratur* (2nd ed., 1897).

PROCOPIUS OF GAZA (c. 465-528 A.D.), Christian sophist and rhetorician, one of the most important representatives of the famous school of his native place. Here he spent nearly the whole of his life teaching and writing, and took no part in the theological movements of his time. The little that is known of him is to be found in his letters and the encomium by his pupil and successor Choricus. He was the author of numerous rhetorical and theological works. Of the former, his panegyric on the emperor Anastasius alone is extant; the description of the church of St Sophia and the monody on its partial destruction by an earthquake are spurious. His letters (162 in number), addressed to persons of rank, friends, and literary opponents, throw valuable light upon the condition of the sophistical rhetoric of the period and the character of the writer. The fragment of a polemical treatise against the Neoplatonist Proclus is now assigned to Nicolaus, archbishop of Methone in Peloponnesus (β. 12th century). Procopius's theological writings consist of commentaries on the Octateuch, the books of Kings and Chronicles, Isaiah, the Proverbs, the Song of Songs and Ecclesiastes. They are amongst the earliest examples of the "catenic" (*catena*, chain) form of commentary, consisting of a series of extracts from the fathers, arranged, with independent additions, to elucidate the portions of Scripture concerned. Photius (*cod.* 206), while blaming the diffuseness of these commentaries, praises the writer's learning and style, which, however, he considers too ornate for the purpose.

Complete editions of the works of Procopius in Migne, *Patrologia graeca*, lxxxvii; the letters also in *Epistolographi graeci*, ed. R. Hercher (1873); see also K. Seitz, *Die Schilde von Gaza* (1892); D. Russos, *Τρεῖς Γαζαῖοι* (Constantinople, 1893); L. Eisenhofer, *Procopius von Gaza* (1897); further bibliographical notices in C. Krumbacher, *Geschichte der byzantinischen Litteratur* (1897), and article by G. Krüger in Herzog-Hauck's *Realencyclopädie für protestantische Theologie* (1905).

PROCRUSTES (Gr. for "the stretcher"), also called POLYPEMON or DAMASTES, in Greek legend, a robber dwelling in the neighbourhood of Eleusis, who was slain by Theseus. He had two bedsteads (according to some, only one), the one very long, the other very short. When a stranger claimed his hospitality, Procrustes compelled him, if he was tall, to lie down on the short bed, and then cut off his extremities to make him fit. If on the other hand he was short, he was placed on the long bedstead and his limbs pulled out until he died from exhaustion. The "bed of Procrustes" has become proverbial.

Diod. Sic. iv. 59; Hyginus, *fab.* 38; Plutarch, *Theseus*, 11; Pausanias i. 38, 5.

PROCTER, BRYAN WALLER (1787-1874), English poet, was born at Leeds on the 21st of November 1787. He was educated at Harrow, where he had for contemporaries Lord Byron and Sir Robert Peel. On leaving school he was placed in the office of a solicitor at Calne, Wiltshire, remaining there until about 1807, when he returned to London to study law. By the death of his father in 1816 he became possessed of a small property, and soon after entered into partnership with a solicitor; but in 1820 the partnership was dissolved, and he began to write under the pseudonym of "Barry Cornwall." After his marriage in 1824 to Miss Skepper, a daughter of Mrs Basil Montague, he returned to his professional work as conveyancer, and was called to the bar in 1831. In the following year he was appointed, metropolitan commissioner of lunacy—an appointment annually renewed until his election to the permanent commission constituted by the act of 1842. He resigned office in 1861. He died on the 5th of October 1874. Most of his verse was composed between 1815, when he began to contribute to the *Literary Gazette*, and 1823, or at latest 1832.

His principal poetical works were: *Dramatic Scenes and other Poems* (1819), *A Sicilian Story* (1820), *Mirandola*, a tragedy performed at Covent Garden with Macready, Charles Kemble and Miss Foote in the leading parts (1821), *The Flood of Thessaly* (1823), and *English Songs* (1832). He was also the author of

Effigies poetica (1824), *Life of Edmund Kean* (1835), *Essays and Tales in Prose* (1851), *Charles-Lamb; a Memoir* (1866), and of memoirs of Ben Jonson and Shakespeare for editions of their works. A posthumous autobiographical fragment with notes of his literary friends, of whom he had a wide range from Bowles to Browning, was published in 1877, with some additions by Coventry Patmore. Charles Lamb gave the highest possible praise to his friend's *Dramatic Sketches* when he said that had he found them as anonymous manuscript in the Garrick collection he would have had no hesitation about including them in his *Dramatic Specimens*. He was perhaps not an impartial critic. "Barry Cornwall's" genius cannot be said to have been entirely mimetic, but his works are full of subdued echoes. His songs have caught some notes from the Elizabethan and Cavalier lyrics, and blended them with others from the leading poets of his own time; and his dramatic fragments show a similar infusion of the early Victorian spirit into pre-Restoration forms and cadences. The results are somewhat heterogeneous, and lack the impress of a pervading and dominant personality to give them unity, but they abound in pleasant touches, with here and there the flash of a higher, though casual, inspiration.

His daughter, ADELAIDE ANNE PROCTOR (1825–1864), also a poet, was born on the 30th of October 1825. She began to contribute to *Household Words* in 1853. She adopted the name of "Mary Berwick," so that the editor, Charles Dickens, should not be prejudiced by his friendship for the Proctors. Her principal work is *Legends and Lyrics*, of which a first series, published in 1858, ran through nine editions in seven years, while a second series issued in 1860 met with a similar success. Her unambitious verses dealing with simple emotional themes in a simple manner have a charm which is scarcely explicable on the ground of high literary merit, but which is due rather to the fact that they are the cultured expression of an earnest and beneficent life. Among the best known of her poems are *The Angel's Story*, *The Legend of Bregenz* and *The Legend of Provence*. Many of her songs and hymns are very popular. Latterly she became a convert to Roman Catholicism, and her philanthropic zeal appears to have hastened her death, which took place on the 2nd of February 1864.

PROCTOR, ALEXANDER PHIMISTER (1862–), American sculptor and painter, was born in Ontario, Canada, on the 27th of September 1862. As a youth he lived at Denver, Colorado, spending much of his time in the Rocky Mountains, and his familiarity with the ways and habits of wild animals was supplemented later by study in the Jardin des Plantes, Paris. He was a pupil at the National Academy of Design and later in the Art Students' League, in New York, and first attracted attention by his statues of wild animals at the Columbian Exposition, Chicago. In 1896 he won the Rinehart Scholarship, which enabled him to spend five years in Paris, where he studied under Puech and J. A. Injalbert. Among his works of sculpture are: "Indian Warrior" (a small bronze); "Panthers," Prospect Park, Brooklyn, New York; "Quadriga," for United States Pavilion, Paris Exhibition (1900), and groups in the City Park, Denver, and Zoological Park, New York. His pictures of wild animals, mainly in water colours, are also characteristic. He became a member of the Society of American Artists (1895), of the National Academy of Design (1904), of the American Water Color Society, and of the Architectural League, New York.

PROCTOR, RICHARD ANTHONY (1837–1888), British astronomer, was born at Chelsea on the 23rd of March 1837. He was a delicate child, and, his father dying in 1850, his mother attended herself to his education. On his health improving he was sent to King's College, London, from which he obtained a scholarship at St John's College, Cambridge. He graduated in 1860 as 23rd wrangler. His marriage while still an undergraduate probably accounted for his low place in the tripos. He then read for the bar, but turned to astronomy and authorship instead, and in 1865 published an article on the "Colours of Double Stars" in the *Cornhill Magazine*. His first book—*Saturn and his System*—was published in the same year, at his

own expense. This work contains an elaborate account of the phenomena presented by the planet; but although favourably received by astronomers, it had no great sale. He intended to follow it up with similar treatises on Mars, Jupiter, sun, moon, comets and meteors, stars, and nebulae, and had in fact commenced a monograph on Mars, when the failure of a New Zealand bank deprived him of an independence which would have enabled him to carry out his scheme without anxiety as to its commercial success or failure. Being thus obliged to depend upon his writings for the support of his family, and having learned by the fate of his *Saturn* that the general public are not attracted by works requiring arduous study, he cultivated a more popular style. He wrote for a number of periodicals; and although he has stated that he would at this time willingly have "turned to stone-breaking on the roads, or any other form of hard and honest but unscientific labour, if a modest competence had been offered" him in any such direction, he attained a high degree of popularity, and his numerous works had a wide influence in familiarizing the public with the main facts of astronomy. His earlier efforts were, however, not always successful. His *Handbook of the Stars* (1866) was refused by Messrs Longmans and Messrs Macmillan, but being privately printed, it sold fairly well. For his *Half-Hours with the Telescope* (1868), which eventually reached a 20th edition, he received originally £25 from Messrs Hardwick. Although teaching was uncongenial to him he took pupils in mathematics, and held for a time the position of mathematical coach for Woolwich and Sandhurst.

His literary standing meantime improved, and he became a regular contributor to *The Intellectual Observer*, *Chambers's Journal* and the *Popular Science Review*. In 1870 appeared his *Other Worlds than Ours*, in which he discussed the question of the plurality of worlds in the light of new facts. This was followed by a long series of popular treatises in rapid succession, amongst the more important of which are *Light Science for Leisure Hours* and *The Sun* (1871); *The Orbs around Us* and *Essays on Astronomy* (1872); *The Expanse of Heaven*, *The Moon* and *The Borderland of Science* (1873); *The Universe and the Coming Transits and Transits of Venus* (1874); *Our Place among Infinities* (1875); *Myths and Marvels of Astronomy* (1877); *The Universe of Stars* (1878); *Flowers of the Sky* (1879); *The Poetry of Astronomy* (1880); *Easy Star Lessons* and *Familiar Science Studies* (1882); *Mysteries of Time and Space* and *The Great Pyramid* (1883); *The Universe of Suns* (1884); *The Seasons* (1885); *Other Suns than Ours* and *Half-Hours with the Stars* (1887). In 1881 he founded *Knowledge*, a popular weekly magazine of science (converted into a monthly in 1885), which had a considerable circulation. In it he wrote on a great variety of subjects, including chess and whist. He was also the author of the articles on astronomy in the *American Cyclopaedia* and the ninth edition of the *Encyclopaedia Britannica*, and was well known as a popular lecturer on astronomy in England, America and Australia. Elected a fellow of the Royal Astronomical Society in 1866, he became honorary secretary in 1872, and contributed eighty-three separate papers to its *Monthly Notices*. Of these the more noteworthy dealt with the distribution of stars, star-clusters and nebulae, and the construction of the sidereal universe. He was an expert in all that related to map-drawing, and published two star-atlases. A chart on an isographic projection, exhibiting all the stars contained in the *Bonn Durchmusterung*, was designed to show the laws according to which the stars down to the 9-10th magnitude are distributed over the northern heavens. His "Theoretical Considerations respecting the Corona" (*Monthly Notices*, xxxi. 184, 254) also deserve mention, as well as his discussions of the rotation of Mars, by which he deduced its period with a probable error of 0^s.005. He also vigorously criticized the official arrangements for observing the transits of Venus of 1874 and 1882. His largest and most ambitious work, *Old and New Astronomy*, unfortunately left unfinished at his death, was completed by A. Cowper Ranyard and published in 1892. He settled in America some time after his second marriage in 1881, and died at New York on the 12th of September 1888.

See *Monthly Notices*, xlix. 164; *Observatory*, xi. 366; *The Times*, (Sept. 14, 1888); *Knowledge* (Oct. 1888, p. 265); *Appleton's Annual Cyclopaedia*, xiii. 707; *Autobiographical Notes in New Science Review*, i. 393.

PROCTOR, an English variant of the word procurator (*q.v.*); strictly, a person who takes charge or acts for another, and so approaching very nearly in meaning to "agent" (*q.v.*). The title is used in England in three principal senses.

1. A practitioner in the ecclesiastical and admiralty courts. A proctor in this sense is also a qualified person licensed by the archbishop of Canterbury to undertake duties such as are performed in other courts by solicitors, but this matter is now only of historical interest, since by the Judicature Acts 1873 and 1875 all the business formerly confined to proctors may be conducted by solicitors. The king's proctor is the proctor or solicitor representing the Crown in the courts of probate and divorce. In petitions of divorce or for declaration of nullity of marriage the king's proctor may, under direction of the attorney-general, and by leave of the court, intervene in the suit for the purpose of proving collusion between the parties. His power of intervening is limited, by the Matrimonial Causes Act 1860, to cases of *collusion* only, but he may also, as one of the public, show cause against a decree *nisi* being made absolute (see **DIVORCE**). In the admiralty court a proctor or procurator was an officer who, in conjunction with the king's proctor, acted as the attorney or solicitor in all causes concerning the lord high admiral's affairs in the high court of admiralty and other courts. The king's proctor so acted in all causes concerning the king.

2. A representative of the clergy in convocation. A proctor in this sense represents either the chapter of a cathedral or the beneficed clergy of a diocese. In the province of Canterbury two proctors represent the clergy of each diocese; in that of York there are two for each archdeaconry. In both alike each chapter is represented by one.

3. The name of certain important university officials. At Oxford the proctors (*procuratores*), under the statutes, supervise the transaction of university business and appoint delegates to look after any particular affairs wherever these are not otherwise provided for by statute. They are *ex officio* members of all the important delegacies, except that of the University Press. They also act as the assessors of the chancellor or his commissary in particular matters dealt with in the university. They supervise the voting at public meetings of the university and announce the results. They also have, according to the ancient statutes, the power of veto in convocation and congregation: no proposal can be passed into a statute or decree if twice vetoed by them. They are *ex officio* members of the hebdomadal council, the governing council of the university, and they are the assessors of the vice-chancellor when he confers degrees. When a degree is to be granted they walk down the hall in which the ceremony is performed, nominally to ask for the approval of the masters, and it was formerly the custom for any tradesman, or any other person, who had a claim of debt against the postulant for a degree, to pluck the gown of the proctor as he passed and request settlement of the debt before the degree was granted. The proctors are also responsible for the good order of the university, and they are charged with the duty of inquiring into and reporting on any breaches of its statutes, customs or privileges. They are empowered to punish undergraduates, or graduates under the degree of Bachelor of Civil Law and Master of Arts, by fine or by confinement to their colleges or lodgings (familiarily known as "gating"). They have to draw up the list of candidates for examination, and have to be present at all examinations, to see that they are properly conducted. They are responsible for the good order of the streets at night, so far as members of the university are concerned. For this purpose more especially each of them is empowered, immediately on his election, to nominate two masters of at least three years' standing as pro-proctors. The proctors and pro-proctors take it in turn to perambulate the streets nightly, accompanied by two sworn constables, familiarily known as "bulldogs." The proctors are elected by the heads, fellows and resident members of convocation of each college in rotation. They are presented to the

vice-chancellor with much ceremony, part of which consists in taking over the insignia of their office—a copy of the statutes and a bunch of keys—from their predecessors.

At Cambridge the proctors are nominated annually by the colleges in rotation and elected (a formal proceeding) by the senate. They must have been three years members of the senate and have resided two years at the university. The two pro-proctors are not, as at Oxford, nominated by the proctors, but are also elected by the senate on the nomination of the colleges, each college having the right to nominate a pro-proctor the year next before that in which it nominates the proctor (Grace of February 26, 1863). Two additional pro-proctors are also elected by the senate each year, on the nomination of the vice-chancellor and proctors, to assist the latter in the maintenance of discipline (Grace of June 6, 1878).

The early history of the office at Cambridge is obscure, but it seems that the proctors have always represented the colleges in university proceedings. At present their functions are twofold (1) as taking part in all university ceremonials, (2) as enforcing discipline in the case of members of the university who are *in statu pupillari* (*i.e.* undergraduates and Bachelors of Arts and Law). (1) The proctors are not (as at Oxford) *ex officio* members of the council of the senate or of other boards or syndicates, except those with which their duties are specially connected. But their presence is essential at all congregations of the senate, at which the senior proctor reads all the "graces" (already approved by the council of the senate). If any grace is opposed by any member of the senate saying *non placet* the proctors take the votes of those present and announce the result. Graces are offered not only for making changes in university statutes and ordinances and for appointing examiners and the like, but also for granting degrees. When a degree is to be taken the college of the candidate presents a *supplicat* or petition for the degree, this petition is approved by the council of the senate, when they have satisfied themselves that the candidate has fulfilled the conditions, and is read at the congregation by the senior proctor: these *supplicats* are practically never opposed, but graces for new statutes and ordinances are frequently opposed, and on very important occasions many hundreds of non-resident members of the senate come up to record their votes. (2) The proctors' powers as to discipline have a very long history. As far as concerns members of the university they have authority to impose certain fines for minor offences, such as not wearing academical dress on occasions when it is ordered, and also to order a man not to be out of his college after a certain hour for a certain number of days ("gating"). In the case of more serious offences the proctor generally reports the matter to the authorities of the offender's college to be dealt with by them, or as an ultimate resort brings the offender before the university court of discipline, which has power to rusticate or expel. The power of the proctors over persons who are not members of the university dated from charters granted by Elizabeth and James I., which empowered the university authorities to search for undesirable characters, men and women, rogues, vagabonds, and other *personas de malo suspectas*, and punish them by imprisonment or banishment. In recent times this power was regularly exercised with respect to women of bad character. The proctors promenaded the streets attended by their servants (the bulldogs), who are always sworn in as special constables. If occasion arose the proctor could arrest a suspected woman and have her taken to the Spinning House (for which Hobson the carrier had left an endowment); the next day the woman was brought before the vice-chancellor, who had power to commit her to the Spinning House; as a general rule the sentence was not for a longer period than three weeks. For this purpose the vice-chancellor sat *in camera* and the jurisdiction had nothing to do with that of the vice-chancellor's court. In 1898 attention was called to this procedure by the case of a girl named Daisy Hopkins, who was arrested and committed to the Spinning House. Application was made on her behalf to the Queen's Bench Division for a writ of habeas corpus, and when the application came on it appeared that there had been a technical irregularity (the

prisoner not having been formally charged when brought before the vice-chancellor); so the writ was granted and the prisoner released. She afterwards brought an action against the proctor, which failed. It was now decided to abolish the practice of hearing these cases *in camera*. The whole practice was, however, objected to by the authorities of the town, and after conference an agreement was arrived at, the proctorial jurisdiction over persons not members of the university being abolished (1904).

PROCURATION (Lat. *procurare*, to take care of), the action of taking care of, hence management, stewardship, agency. The word is applied to the authority or power delegated to a procurator, or agent, as well as to the exercise of such authority expressed frequently "by procuration" (*per procurationem*), or shortly *per pro.*, or simply *p.p.* In ecclesiastical law, procuration is the providing necessaries for bishops and archdeacons during their visitations of parochial churches in their dioceses. Procuration at first took the form of meat, drink, provender, and other accommodation, but it was gradually compounded for a certain sum of money. Procuration is merely an ecclesiastical due, and is suable only in a spiritual court. In those dioceses where the bishop's estates have vested in the ecclesiastical commissioners procurations are payable to the commissioners who, however, have abandoned their collection (Phillimore, *Ecc. Law*, 2nd ed., 1895, pp. 1051, 1060). Procuration is also used specifically for the negotiation of a loan by an agent for his client, whether by mortgage or otherwise, and the sum of money or commission paid for negotiating it is frequently termed *procuration fee*.

The English criminal law makes the provision or attempted provision of any girl or woman under twenty-one years of age for the purpose of illicit intercourse an offence, known as procuration. (See PROSTITUTION.)

PROCURATOR (Lat. *procurare*, to take care of), generally one who acts for another. With the Romans it was applied to a person who maintained or defended an action on behalf of another, thus performing the functions of a modern attorney. Roman families of importance employed an official corresponding to the modern steward and frequently called the *procurator*. Later the name was applied especially to certain imperial officials in the provinces of the Roman Empire. With the establishment of the imperial power under Augustus, the emperor took under his direct government those of which the condition or situation rendered a large military force necessary. Here certain officials, known as the *procuratores Caesaris*, took the place occupied by the *quaestor* in the senatorial provinces. They were either equites or freedmen of the Caesar and their office was concerned with the interests of the *Fiscus* (the public property of the Caesar). They looked after the taxes and paid the troops. There were also officials bearing this title of *procuratores Caesaris* in the senatorial provinces. They collected certain dues of the *Fiscus* which were independent of those paid to the *acrarium* (the property of the senate). This organization lasted with some modifications until the 3rd century. The *procurator* was an important official in the reorganized empire of Diocletian.

The title remained all through the middle ages to describe very various officials. Thus it was sometimes applied to a regent acting for a king during his minority or absence; sometimes it appears as an alternative title to *seneschal* or *dapifer*. It preserved its legal significance in the title of *procurator animarum*, who acted as solicitor or proxy in the ecclesiastical courts, and was so called because these courts dealt with matters affecting the spiritual interests of the persons concerned. The economical significance remained in such titles as *procurator anniversariorum*, the exactor of dues for the celebration of anniversaries; this office was assigned to laymen. The *procurator draperii* was entrusted with the administration of matters pertaining to the art of cloth-making. The *procurator duplarum* was the collector of fines in certain churches from absent canons, &c. The officials entrusted with the administration of the

goods of a church were called variously *procurator ecclesiae*, *procurator parochialis*, *procurator universitatis*. Bishops and bishops-elect frequently described themselves by the title of *procuratores ecclesiarum*. The prior of a dependent religious house was sometimes styled *procurator obedientiae*. The official who represented the public interests in the courts of the inquisition was known as the *procurator fidei*. The administrator of the affairs of a large community was sometimes called the *procurator syndicus*, the administrator of goods left to the poor, *procurator pauperum*. In monasteries the *economus* was, and is, sometimes described as *procurator*. Thus the procurator has still the administration of material affairs in every Dominican priory. *Procurator di San Marco* was a title of honour in the republic of Venice. There were nine official procurators and numerous distinguished persons bearing the honorary title.

The term procurator (Fr. *procurateur*) is used in those countries whose codes are based on the Roman civil law for certain officials, having a representative character, in the courts of law. Thus under the *ancien régime* in France the *procurateurs du roi* were the representative of the Crown in all causes (see FRANCE: *Law and Institutions*); and now the *procurateurs généraux*, and under them the *procurateurs substitués*, *procurateurs de la république* and *procurateurs* still represent the *ministère public* in the courts. In Scotland the procurator is a law agent who practises in an inferior court. A procurator in Scotland has been, since the Law Agents Acts 1873, exactly in the same legal position as other law agents. The procurator-fiscal is a local officer charged with the prosecution of crimes. He is appointed by the sheriff. He also performs the duties of an English coroner by holding inquiries into the circumstances of suspicious deaths. A common English form of procurator is proctor (*q.v.*).

See Sir William Smith, *Dictionary of Greek and Roman Antiquities* (3rd ed., 1890-1891), and Du Cange, *Glossarium mediae et infimae latinitatis* (new ed. by L. Favre, Nior, 1883). (E. O'N.)

PRODICUS OF CEOS (b. c. 465 or 450 B.C.), a Greek humanist of the first period of the Sophistical movement, known as the "precursor of Socrates." He was still living in 399 B.C. He came to Athens as ambassador from Ceos, and became known as a speaker and a teacher. Like Protagoras, he professed to train his pupils for domestic and civic affairs; but it would appear that, while Protagoras's chief instruments of education were rhetoric and style, Prodicus made ethics prominent in his curriculum. In ethics he was a pessimist. Though he discharged his civic duties in spite of a frail physique, he emphasized the sorrows of life; and yet he advocated no hopeless resignation, but rather the remedy of work, and took as his model Heracles, the embodiment of virile activity. The influence of his views may be recognized as late as the *Shepherd of Hermas*. His views on the origin of the belief in the gods is strikingly modern. First came those great powers which benefit mankind (comparing the worship of the Nile), and after these the deified men who have rendered services to humanity. But he was no atheist, for the pantheist Zeno spoke highly of him. Of his natural philosophy we know only the titles of his treatises *On Nature* and *On the Nature of Man*. His chief interest is that he sought to give precision to the use of words. Two of his discourses were specially famous; one, "On Propriety of Language," is repeatedly alluded to by Plato; the other, entitled *Ἐρπαι*, contained the celebrated apologue of the Choice of Heracles, of which the Xenophontean Socrates (*Mem.* ii. 1, 21 seq.) gives a summary. Theramenes, Euripides and Isocrates are said to have been pupils or hearers of Prodicus. By his immediate successors he was variously estimated: Plato satirizes him in the early dialogues; Aristophanes in the *Ταγνησιαί* calls him "a babbling brook"; Aeschines the Socratic condemns him as a sophist.

See Spengel, *Artium scriptores*, pp. 45 sqq.; Welcker, "Prodikos der Vorgänger des Sokrates," in *Rheinisches Museum* (1833), and in *Kleine Schriften*, ii. 393; Hummel, *De Prodicis Sophista* (Leiden, 1846); Cougny, *De Prodicis Ceio* (Paris, 1858).

PRODIGY, an extraordinary or wonderful thing, person, event, &c.; something which excites amazement and astonishment. The term has been particularly applied to children who display a precocious genius, especially in music. The German expression *Wunderkind* has of late been often adopted by those who have found the name "infant prodigy" too reminiscent of the "infant phenomenon" familiar to readers of Dickens. The Lat. *prodigium*, an omen, portent, and abnormal or monstrous event, is probably not to be derived from *pro* and *dicere*, to foretell, prophesy, but rather, on the analogy of *adagium*, adage, aphorism, from *pro* (*prot* before a vowel), and the root of *aio*, I say.

PRODUCTION (Lat. *productionem*, from *producere*, to produce), in general, the act of producing, or bringing forth. Production, in contrast with distribution and consumption, is one of the great divisions which all treatises on economics make in dealing with the subject, and as such it is defined in every textbook and its elements and processes dealt with at length. J. R. McCulloch's definition may be given as one difficult to improve on: "by production, in the science of political economy, we are not to understand the production of matter, for that is the exclusive attribute of Omnipotence, but the production of utility, and consequently of exchangeable value, by appropriating and modifying matter already in existence, so as to fit it to satisfy our wants, and to contribute to our enjoyments." W. S. Jevons says, "production is one of the very few happily chosen terms which the economist possesses. Etymologically the term implies that we draw wealth forth, and this is the correct idea of production." Though the mere definition of "production" as the creation of utilities is apparently simple enough, the treatment of the subject has varied from time to time in proportion to the changes which economic science has itself undergone; it has been said that the theory of production is based on unalterable natural facts, but even this cannot be too absolutely stated, for the organization of production changes with social growth. Much discussion has, during the growth of the science of economics, centred round what is and what is not productive or unproductive, and as to the relative importance of the functions of production and distribution.

See E. Canaan's *History of the Theories of Production and Distribution* (1893), and the standard treatises on economics. Also the articles, CAPITAL; VALUE; WEALTH.

PROFANITY, irreverent or blasphemous language, swearing, by the use of words casting derision on sacred or divine things, especially the taking of the name of God in vain (see BLASPHEMY; and SWEARING). The word "profane," derived from Lat. *profanum*, outside the temple (*fanum*), hence opposed to *sacrum* or *religiosum*, in the sense of not sacred, common, is used in English not only as meaning irreverent, or blasphemous, but also in the senses of the original Latin, not initiated into sacred mysteries, hence, lay, secular, or as referring to subjects not connected with sacred or biblical matters, e.g. profane literature, history, &c.

PROFESSOR (the Latin noun formed from the verb *profiteri*, to declare publicly, to acknowledge, profess), a term now properly confined to a teacher of a special grade at a university. Its former significance of one who has made "profession" or open acknowledgment of religious belief, or, in particular, has made a promise binding the maker to a religious order, is now obsolete. The educational use is found in post-Augustan Latin, and *profiteri* is used by Pliny (*Ep.* ii. 18, 3, iv. 11, 14), absolutely, in the sense of "to be a teacher," an extension of the classical use in the sense of to practise, profess a science or art, e.g. *profiteri jus, medicinam, philosophiam*, &c. In the universities of the middle ages the conferring of a degree in any faculty or branch of learning meant the right or qualification to teach in that faculty, whence the terms *magister*, "master," and *doctor* for those on whom the degree had been granted. To these names must be added that of "professor." The "three titles of Master, Doctor, Professor, were in the middle ages absolutely synonymous" (H. Rashdall, *The Universities of Europe in the Middle Ages*, 1895, i. 21). At Paris in the faculties of theology,

medicine and arts *professor* is more frequently used than *doctor* but less so than *magister*; at Bologna the teachers of law are known as *professores* or *doctores* (id.). From this position to that of the holder of an endowed "chair," the occupant of which is the principal public teacher of the particular faculty, the evolution was gradual. The first endowed professorship at Oxford was that of divinity, founded by the mother of Henry VII. in 1497 (? 1502) and named after her the "Margaret Professorship." The foundation of the regius professorship by Henry VIII., in 1546 no doubt, as the *New English Dictionary* points out, tended to the general modern use of the word. Subordinate public teachers in faculties or in subjects to which a professorial "chair" is attached, are known as "readers" or "lecturers," and these titles are also used for the principal public teachers in subjects which have not reached professorial rank.

PROFILE, an outline or contour drawing, particularly the drawing of the outline of the human face as seen from the side, or in architecture the contour of a part of a building, of a moulding, &c., as shown by a vertical section. In fortification the "profile" of an earthwork is an outline of a transverse section and gives the relative thickness; so a work is said to be "of strong" or "of weak" profile. The Fr. *profil*, formerly *porfil*, *pourfil*, Ital. *profilo*, *proffilo*, are formed from Lat. *pro*, and *filare*, to draw a line, *filum*, thread.

The French *pourfil* also gave English "purfle," to embroider the edge of a fabric with gold or other thread; this was further corrupted to "purl," now often wrongly spelt "pearl," an inverted stitch in knitting.

PROFIT-SHARING (*i.e.* between employer and employed), a method of remunerating labour, under which the employees receive, in addition to ordinary wages, a share of the profit which the business realizes. The term is not infrequently used loosely to include many forms of addition to ordinary wages, such as bonus on output or quality, gain-sharing and product-bearing. Yet strictly, where an employee or a group works for a share of the product, or is paid so much in addition to ordinary wages in proportion as the product exceeds a certain quantity, or the quality exceeds a certain standard, in neither of these cases have we profit-sharing, for the net result of the business may be a large profit or a small one or a loss, and the employee's claim is unaffected. In the same way if a workman is employed on the basis that if in doing a particular job he saves something out of a stipulated time of labour, or a stipulated amount of materials, he shall receive in addition to ordinary wages a proportion of the value so saved, that is technically gain-sharing, not profit-sharing. Even where the bonus depends strictly on profit, it is not reckoned as profit-sharing, if it is confined to the leading employees.

An agreement is of the essence of the matter. It is not profit-sharing where an employer takes something from his profits at his own will and pleasure, and gives it to his employees. Strictly such gifts in cash are gratuities, while, when they take other forms, such as better houses, libraries, recreation rooms, provision for sickness and old age, all given at the will of the employer, we have paternalism. Such benefits thus taken expressly from profits and varying more or less with the amount of profit certainly approach true profit-sharing: they are sometimes called "indeterminate" profit-sharing. Though many of the above methods of remunerating, or benefiting, the employed are from time to time included under profit-sharing even by writers of repute, the strict sense of the term was defined by the international congress on profit-sharing in 1880 as "an agreement freely entered into by which the employed receives a share of profits determined in advance." It does not follow that the agreement must be actually enforceable at law; some employers to protect themselves from litigation stipulate that it shall not be.

Profit-sharing, in the loose sense, must be of untold antiquity; the first great example of profit-sharing in the strict sense is that of the Parisian house-painter, Edme-Jean Leclair, "The Father of Profit-Sharing." In 1842 he was employing 300 men

on day wages. By greater zeal and intelligence and less waste, not necessarily by harder work, he reckoned they could save £3000 a year; and he made it their interest to do so by arranging that they should receive the greater part of the saving themselves. This arrangement proved a very great success; the material gain to the men and the improvement in their morale were marked; and Leclair, who began life with nothing and died worth £48,000, always maintained that, without the zeal drawn out in his men by profit-sharing, he never could have made so large a business or gained so much wealth. In 1908 the system was still in active operation in the firm. Its main features are as follows: after paying 5% interest on the capital, and small sums as wages of superintendence to the two managing partners, the remaining profit is divided into four parts, one of which goes to the managing partners, one to the Mutual Aid Society, and the remaining half to the employees as a dividend on their ordinary wages, exclusive of piece-work and overtime, on which no dividend is paid. The Mutual Aid Society is a registered body, and is a limited partner in the firm, the liability of the two managing partners being unlimited and the control resting entirely in their hands. The benefits of the Mutual Aid Society, and of the profit-sharing generally, are enjoyed in the main by all the employees of the business, but certain advantages are confined to a limited number of permanent employees.

Leclair's system attracted the marked interest of John Stuart Mill and other English economists, and in 1865-1867 a number of experiments in profit-sharing, or as it was then called, industrial partnership, were made in England, the most noted being that of Henry Briggs, Son & Co., at their collieries in Yorkshire. The main object in this case was to detach the workmen from the trade union and attach them to the firm. In other ways the experiment was very successful, and £40,000 was divided as bonus on wages in nine years, but the main object was not attained; and when the price of coal fell heavily after the inflation of 1873 Briggs's men joined the strike to resist a reduction of wages, and the experiment came to an end.

The present extent of profit-sharing, though in itself considerable, is but small in comparison with the vast extent of the world's commerce and industry, and except in one of its developments, co-partnership, it can hardly be said to be making progress. In 1906 there were in the United Kingdom and its colonies 65 ordinary firms practising profit-sharing in its strictest sense, and 17 others known to have adopted and not known to have discontinued it, making 82 in all as against 92 in 1901, and 101 in 1894. On the other hand the number of employees had grown from 28,000 in 1894 to 48,000 in 1906. In addition about one-fourth of the workmen's co-operative societies in Great Britain (see CO-OPERATION) practise profit-sharing with perhaps 30,000 employees.

In 1894 it was found that there were more profit-sharing firms in the British Empire than in any other country, and this is probably still true. The only rival is France, where, however, the term "participation aux bénéfices" is used in a wider sense. There are also important examples in Germany, the United States, Switzerland (where the state once applied the system in the postal service, and still does in the telegraphs), in Holland, in the socialist co-operative societies of Belgium, and elsewhere.

Profit-sharing has been quickly abandoned in many instances, for various reasons; there were no profits to divide; the small bonus given seemed to have no effect; the hope of detaching the men from their union, or contenting them with lower wages, was not realized; or the business passed into unsympathetic hands. On the other hand, one lasting success in such a matter proves more than many short experiments which failed; and profit-sharing has been splendidly successful where some high-minded man has breathed into it the spirit of partnership. Often it has been a step to actual partnership; the workman has not only received a share of profit, as added remuneration of his labour, but been led on to invest in the capital of the business, and as a shareholder, to take his share of the profits paid on

capital, as well as of responsibility, of loss if any, and of control. This system of profit-sharing plus shareholding is now known as co-partnership (see CO-OPERATION), and is making undoubted progress. It is exemplified in nearly all profit-sharing co-operative societies, and in a growing number of businesses of non-co-operative origin which accumulate part or the whole of labour's profit in shares. In 1908, in the Familistère of Guise the whole capital of £200,000 belonged to the workers and a few retired workers, in Leclair's old business the Mutual Aid Fund owned half, in the Laroche-Joubert paper-works the employees owned more than two-thirds. In the South Metropolitan Gas Co. the employees owned £327,000 and elected three of the nine directors. It would seem to be in this direction, as a step to full partnership, that profit-sharing has a great future before it.

BIBLIOGRAPHY.—A large number of works are noted in the *International Co-operative Bibliography* (London, 1906; International Co-operative Alliance). The following may be specially mentioned: Sedley Taylor, *Profit-sharing between Capital and Labour* (London, 1884; New York, 1886); N. P. Gilman, *Profit-sharing between Employer and Employed* (London and New York, 1892); and N. P. Gilman, *A Dividend to Labour* (London and Boston, 1900); Board of Trade Report by D. F. Schloss, on Profit-sharing (London, 1894; with yearly addenda in the *Labour Gazette*); D. F. Schloss, *Methods of Industrial Remuneration* (London, 1894); Victor Böhmert, *Die Gewinnbetheiligung* (Leipzig, 1878, and Dresden 1903); Publications of the *Société pour l'étude de la participation* (Paris, 1879 and onwards); Albert Trombert, *Guide pratique de la participation* (Paris, 1892); International Co-operative Alliance publications, especially *Report of Fifth Congress* (London, 1902); Labour Co-partnership Association Reports and Publications (London, 1883, and onwards).

(A. Wl.*)

PROGNATHISM (Gr. πρό, forward, and γνάθος, jaw), the term applied by ethnologists, with its opposite *Orthognathism* (ὀρθός, straight), to describe the varying degrees of projection of the upper jaw, which itself is determined by the angle made by the whole face with the brain-cap. *Eurygnathism* (εὐρύς, wide), is the lateral projection of jawbones so characteristic of the Mongolic races. (See CRANIOMETRY.)

PROGNOSIS (Gr. πρόγνωσις, knowledge of recognition beforehand, from προγιγνώσκειν, to know beforehand, cf. "prognostication," prediction), a term used in modern medicine, as it was in Greek, for an opinion, forecast or decision as to the probable course, duration and termination of a case of disease. It is to be distinguished from "diagnosis" (Gr. διάγνωσις, διαγιγνώσκειν to distinguish), the determination or identification of a disease in a particular case from an investigation of its history and symptoms.

PROGRAMME, or PROGRAM, in its original use, following that of Gr. πρόγραμμα, a public notice (προγράψω, to make public by writing), now chiefly in the sense of a printed notice containing the items of a musical concert, with the names of the pieces to be performed, the composers and the performers, or of a theatrical performance, with the characters, actors, scenes, &c. In a wider sense the word is used of a syllabus or scheme of study, order of proceedings or the like, or of a catalogue or schedule containing the chief points in a course of action, and so, politically, in the sense of a list of the principal objects on which a party proposes to base its legislative course of action, as in the "Newcastle Programme" of 1891, drawn up by the Liberal Federation. The spelling "program," now general in America, was that first in use in England, and so continued till the French form "programme" was adopted at the beginning of the 19th century. The *New English Dictionary* considers the earlier and modern American spelling preferable, on the analogy of "diagram," "telegram," "cryptogram" and the like. Scott and Carlyle always used "program."

PROGRAMME MUSIC, a musical nickname which has passed into academic currency, denoting instrumental music without words but descriptive of non-musical ideas. Musical sounds lend themselves to descriptive purposes with an ease which is often uncontrollable. A chromatic scale may suggest the whistling of the wind or the cries of cats; reiterated staccato notes may suggest many things, from raindrops to the cackling of hens. Again, though music cannot directly imitate anything

in nature except sounds, it has a range of contrast and a power of climax that is profoundly emotional in effect; and the emotions it calls up may resemble those of some dramatic story, or those produced by the contemplation of nature. But chromatic scales, reiterated notes, emotional contrasts and climaxes, are also perfectly normal musical means of expression; and the attempts to read non-musical meanings into them are often merely annoying to composers who have thought only of the music. Some distinguished writers on music have found a difficulty in admitting the possibility of emotional contrasts and climaxes in an art without an external subject-matter. But it is impossible to study the history of music without coming to the conclusion that in all mature periods music has been self-sufficient to this extent, that, whatever stimulus it may receive from external ideas, and however much of these ideas it may have embodied in its structure, nothing has survived as a permanently intelligible classic that has not been musically coherent to a degree which seems to drive the subject-matter into the background, even in cases where that subject-matter is naturally present, as in songs, choral works and operas. In short, since sound as it occurs in nature is not sufficiently highly organized to form the raw material for art, there is no natural tendency in music to include, as a "subject," any item conceivable apart from its artistic embodiment. Explicit programme music has thus never been a thing of cardinal importance, either in the transitional periods in which it has been most prominent, or in the permanent musical classics.

At the same time, artistic creation is not a thing that can be governed by any a priori metaphysical theory; and no great artist has been so ascetic as always to resist the inclination to act on the external ideas that impress him. No composer writes important music for the voice without words; for speech is too ancient a function of the human voice to be ousted by any a priori theory of art; and no really artistic composer, handling a living art-form, has failed to be influenced, sooner or later, by the words which he sets. It matters little if these words be in themselves very poor, for even false sentiment must make some appeal to true experience, and the great composers are quicker to seize the truth than to criticize its verbal presentation or to suspect insincerity. The earliest mature musical art was, then, inevitably descriptive, since it was vocal. So incessant is the minute onomatopoeia of 16th-century music, both in the genuine form of sound-painting (*Tonmalerei*) and in the spurious forms to which composers were led by the appearance of notes on paper (e.g. quick notes representing "darkness" because they are printed black!) that there is hardly a page in the productions of the "golden age" of music which has not its literary aspect. Programme music, then, may be expected to derive many of its characteristics from ancient times; but it cannot properly be said to exist until the rise of instrumental music, for not until then could music be based upon external ideas that did not arise inevitably from the use of words or dramatic action.

The resources of the modern orchestra have enabled recent composers to attain a realism which makes that of earlier descriptive music appear ridiculous; but there is little to choose between classics and moderns in the intellectual childishness of such realism. Thunderstorms, bird-songs and pastoral effects galore have been imitated by musicians great and small from the days of the Fitzwilliam Virginal Book to those of the episode of the flock of sheep in Strauss's *Don Quixote*. And, while the progress in realism has been so immense that the only step which remains is to drive a real flock of sheep across the concert-platform, the musical progress implied thereby has been that from inexpensive to expensive rubbish. What is really important, in the programme music of Strauss no less than that of the classics, is the representation of characters and feelings. In this respect the classical record is of high interest, though the greatest composers have contributed but little to it. Thus the *Bible Sonatas* of J. Kuhnau (published in 1700) and Bach's early *Capriccio on the Departure of a Beloved Brother*, which is closely modelled on Kuhnau's programme music, show very

markedly the tendency on the one hand to illustrate characters and feelings, and on the other hand to extract from their programmes every occasion for something that would be a piece of incidental music if the stories were presented as dramas. Thus, though Kuhnau in his naive explanatory preface to his first Bible sonata seems to be trying, like a child, to frighten himself into a fit by describing the size and appearance of Goliath, in the music it is only *le bravate* of Goliath that are portrayed. Thus the best movement in the Goliath sonata is a figured chorale (*Aus tiefer Noth schrei' ich zu Dir*) representing the terror and prayers of the Israelites. And thus the subjects of the other sonatas (*Saul cured by David's music*; *The Marriage of Jacob*; *Hezekiah*; *Gideon*; and *The Funeral of Jacob*) are in various quaint ways musical because ethical; though Kuhnau's conceptions are far better than his execution. In the same way Bach makes his *Capriccio* descriptive of the feelings of the anxious and sorrowing friends of the departing brother, and his utmost realism takes the form of a lively fugue, very much in Kuhnau's best style, on the themes of the postilion's coachhorn and cracking whip. Even Buxtehude's musical illustrations of the "nature and characters of the planets" are probably not the absurdities they have been hastily taken for by writers to whom their title seems nonsensical; for Buxtehude would, of course, take an astrological rather than an astronomical view of the subject, and so the planets would represent temperaments, and their motions the music of the spheres.

Nearly all the harpsichord pieces of Couperin have fantastic titles, and a few of them are descriptive music. His greater contemporary and survivor, Rameau, was an opera composer of real importance, whose harpsichord music contains much that is ingeniously descriptive. *La Poule*, with its theme inscribed "co-co-co-co-co-cocodai," is one of the best harpsichord pieces outside Bach, and is also one of the most minutely realistic compositions ever written. French music has always been remarkably dependent on external stimulus, and nearly all its classics are either programme music or operas. And the extent to which Rameau's jokes may be regarded as typically French is indicated by the fact that Haydn apologized for his imitation of frogs in *The Seasons*, saying that this "französische Quark" had been forced on him by a friend. But throughout the growth of the sonata style, not excepting Haydn's own early work, the tendency towards gratuitously descriptive music is very prominent; and the symphonies of Dittersdorf on the *Metamorphoses of Ovid* are excellent examples of the way in which external ideas may suggest much that is valuable to a musician who struggles with new forms, while at the same time they may serve to distract attention from points in which his designs break down. (See SYMPHONIC POEM.) Strict accuracy would forbid us to include in our survey such descriptive music as comes in operatic overtures or other pieces in which the programme is really necessitated by the conditions of the art; but the line cannot be so drawn without cutting off much that is essential. From the time of Gluck onwards there was a natural and steady growth in the descriptive powers of operatic music, which could not fail to react upon purely instrumental music; but of programme music for its own sake we may say there is no first-rate classic on a large scale before Beethoven, though Beethoven himself could no more surpass Haydn in illustrating an oratorio text (as in the magnificent opening of *The Creation*) than Haydn could surpass Handel.

Mozart's *Musikalischer Spass* is a solitary example of a special branch of descriptive music; a burlesque of incompetent performers and incompetent composers. The lifelike absurdity of the themes with their caricature of classical formulas; the inevitable processes by which the "howlers" in composition seem to arrive as by natural laws, further complicated by the equally natural laws of the howlers in performance; and the unfailing atmosphere of good nature with which Mozart satirizes, among other things, his own style; all combine to make this work very interesting on paper. The effect in performance is astonishing; so exactly, or rather so ideally, is the squalid effect of bad structure and performance kept at a

constant level of comic interest. (In the Leipzig edition of the parts of this work the modern editor has added a new and worthy act to Mozart's glorious farce by correcting and questioning many of the mistakes!) Mozart's burlesque has remained unapproached, even in dramatic music. Compared with it, Wagner's portrait of Beckmesser in *Die Meistersinger* seems embittered in conception and disappointing in comic effect. Mendelssohn is said to have had a splendid faculty for extemporizing similar musical jokes. His Funeral March of Pyramus and Thisbe in the *Midsummer Night's Dream*, and Cornelius's operatic trio in which three persons conjugate the verb *Ich sterbe den Tod des Verräters*, are among the few examples of a burlesque in which there is enough musical sense to keep the joke alive. Such burlesques have their bearing on programme music, in so far as they involve the musical portrayal of character and give opportunity for masterly studies of the psychology of failure. Their special resources thus play a large part in the recent development of the symphonic poem by Richard Strauss, whose instrumental works avowedly illustrate his cheerfully pessimistic views on art and life. But into the main classics of programme music this kind of characterization hardly enters at all.

Beethoven was three times moved to ascribe some of his profoundest music to an external source. In the first instance, that of the *Eroica Symphony*, he did not really produce anything that can fairly be called programme music. Napoleon, before he became emperor, was his ideal hero; and a triumphant symphony, on a gigantic scale and covering the widest range of emotion expressible by music, seemed to him a tribute due to the liberator of Europe; until the liberator became the tyrant. That the slow movement should be a funeral march was, in relation to the heroic tone of the work, as natural as that a symphony should have a slow movement at all. There is no reason in music why the idea of heroic death and mourning should be the end of the representation of heroic ideals. Hence it is unnecessary, though plausible, to hear, in the lively whispering opening of the scherzo, the babel of the fickle crowd that soon forgets its hero; and the criticism which regards the finale as "an inappropriate concession to sonata form" may be dismissed as merely unmusical without therefore being literary. Beethoven's next work inspired from without was the *Pastoral Symphony*; and there he records his theory of programme music on the title-page, by calling it "rather the expression of feeling than tone-painting." There is not a bar of the *Pastoral Symphony* that would be otherwise if its "programme" had never been thought of either by Beethoven or by earlier composers. The nightingale, cuckoo and quail have exactly the same function in the coda of the slow movement as dozens of similar non-thematic episodes at the close of other slow movements (e.g. in the violin sonata Op. 24, and the pianoforte sonata in D minor). The "merry meeting of country folk" is a subject that lends itself admirably to Beethoven's form of *scherzo* (q.v.); and the thunderstorm, which interrupts the last repetition of this scherzo, and forms an introduction to the finale, is none the less purely musical for being, like several of Beethoven's inventions, without any formal parallel in other works. Beethoven's *Battle Symphony* is a clever pot-boiler, which, like most musical representations of such noisy things as battles, may be disregarded in the study of serious programme music. His third great example is the sonata *Les Adieux, l'absence et le retour*. Here, again, we have a monument of pure sonata form; and, whatever light may be thrown upon the musical interpretation of the work by a knowledge of the relation between Beethoven and his friend and patron the Archduke Rudolph and the circumstances of the archduke's departure from Vienna during the Napoleonic wars, far more light may be thrown upon Beethoven's feelings by the study of the music in itself. This ought obviously to be true of all successful programme music; the music ought to illustrate the programme, but we ought not to need to learn or guess at quantities of extraneous information in order to understand the music. No doubt much ingenuity may be spent in tracing external details (the end of the first move-

ment of *Les Adieux* has been compared to the departure of a coach), but the real emotional basis is of a universal and musical kind. The same observations apply to the overtures to *Coriolan*, *Egmont* and *Leonora*; works in which the origin as music for the stage is so far from distracting Beethoven's attention from musical form that the overture which was at first most inseparably associated with the stage and most irregular in form (*Leonora* No. 2) took final shape as the most gigantic formal design ever embodied in a single movement (*Leonora* No. 3), and so proved to be too large for the final version of the opera for which it was first conceived. Beethoven's numerous recorded assertions, whether as to the "picture" he had in his mind whenever he composed, or as to the "meaning" of any particular composition, are not things on which it is safe to rely. Many of his friends, especially his first biographer, Schindler, irritated him into putting them off with any nonsense that came into his head. Composers who have much to express cannot spare time for expressing it in other terms than those of their own art.

Modern programme music shows many divergent tendencies, the least significant of which is the common habit of giving fantastic titles to pieces of instrumental music after they have been composed, as was the case with many of Schumann's pianoforte lyrics. Such a habit may conduce to the immediate popularity of the works, though it is apt to impose on their interpretation limits which might not quite satisfy the composer himself. But there is plenty of genuine programme music in Schumann's case, though, as with Beethoven, the musical sense throws far more light on the programme than the programme throws upon the music. Musical people may profitably study E. T. A. Hoffmann and Jean Paul Richter in the light of Schumann's *Novellettes* and *Kreisleriana*; but if they do not already understand Schumann's music, Jean Paul and Hoffmann will help them only to talk about it. The popular love of fantastic titles for music affected even the most abstract and academic composers during the romantic period. No one wrote more programme music than Spohr; and, strange to say, while Spohr's programme constantly interfered with the externals of his form and ruined the latter part of his symphony *Die Weihe der Töne*, it did not in any way help to broaden his style. Mendelssohn's *Scotch* and *Italian* symphonies, and his *Hebrides Overture*, are cases rather of what may be called local colour than of programme music. His *Reformation Symphony*, which he himself regarded as a failure, and which was not published until after his death, is a composite production, artistically more successful, though less popular, than Spohr's *Weihe der Töne*. The overture to the *Midsummer Night's Dream* is a marvellous musical epitome of Shakespeare's play; and the one point which invites criticism, namely, the comparative slightness and conventionality of its second subject, may be defended as closely corresponding with Shakespeare's equally defensible treatment of the two pairs of lovers.

The one composer of the mid-nineteenth century who really lived on programme music was Berlioz, but he shows a characteristic inability to make up his mind as to what he is doing at any given moment. Externals appeal to him with such overwhelming force that, with all the genuine power of his rhetoric, he often loses grasp of the situation he thinks he is portraying. The moonshine and the sentiment of the *Scène d'amour*, in his *Romeo and Juliet* symphony, is charming; and the agitated sighing episodes which occasionally interrupt its flow, though not musically convincing, are dramatically plain enough to anyone who has once read the balcony scene; but when Berlioz thinks of the nurse knocking or calling at the door his mind is so possessed with the mere incident of the moment that he makes a realistic noise without interrupting the amorous duet. No idea of the emotional tension of the two lovers, of Juliet's artifices for gaining time, and of her agitation at the interruptions of the nurse, seems here to enter into Berlioz's head. Again, if the whole thing is to be expressed in instrumental music, why do we have, before the scene begins, *real* voices of persons in various

degrees of conviviality returning home from the ball? The whole design is notoriously full of similar incongruities, of which these are the more significant for being the most plausible. There is hardly a single work of Berlioz, except the *Harold* symphony and the *Symphonie fantastique*, in which the determination to write programme music does not frequently yield to the impulse to make singers get up and explain in words what it is all about. The climax of absurdity is in the *Symphonie funèbre et triomphale*, written for the inauguration of the Bastille Column, and scored for an enormous military band and chorus. The first movement is a funeral march, and is not only one of Berlioz's finest pieces, but probably the greatest work ever written for a military band. The *Apothéose* chorus is in the form of a triumphal march. Because the occasion was one on which there would be plenty of real speeches, Berlioz must needs write a connecting link called *Oraison funèbre*, consisting of a sermon delivered by a solo trombone; presumably for use in later performances. His naïve Gasconade genius prefers this to the use of the chorus!

Current modern criticism demands plausibility, though it cares little for intellectual soundness: and while practically the whole of Liszt's work is professedly programme music (where it is not actually vocal) and, though there is much in it which is incomplete without external explanation, Liszt is far too "modern" to betray himself into obvious confusion between different planes of musical realism. With all his unreality of style, Liszt's symphonic poems are remarkable steps towards the attainment of a kind of instrumental music which, whether its form is dictated by a programme or not, is at any rate not that of the classical symphony. The programmes of Liszt's works have not always, perhaps not often, produced a living musical form; a form, that is, in which the rhythms and proportions are neither stiff nor nebulous. Both in breadth of design and in organization and flow, the works of Richard Strauss are as great an advance on Liszt as they are more complex in musical, realistic and autobiographical content. Being, with the exception of the latest French orchestral developments, incomparably the most important works illustrating the present state of musical transition, they have given rise to endless discussions as to the legitimacy of programme music. Such discussions are mere windmill-tilting unless it is constantly borne in mind that no artist who has anything of his own to say will ever be prevented from saying it, in the best art-forms attainable in his day, by any scruples as to whether the antecedents of his art-forms are legitimate or not. There is only one thing that is artistically legitimate, and that is a perfect work of art. And the only thing demonstrably prejudicial to such legitimacy in a piece of programme music is that even the most cultured of musicians generally understand music better than they understand anything else, while the greatest musicians know more of their art than is dreamt of in general culture. (D. F. T.)

PROHIBITION (Lat. *prohibere*, to prevent), a term meaning the action of forbidding or preventing by an order, decree, &c. The word is particularly applied to the forbidding by law of the sale and manufacture of intoxicating liquors (see LIQUOR LAWS and TEMPERANCE). In law, as defined by Blackstone, prohibition is "a writ directed to the judge and parties of a suit in any inferior court, commanding them to cease from the prosecution thereof, upon a surmise either that the cause originally or some collateral matter arising therein does not belong to that jurisdiction, but to the cognizance of some other court." A writ of prohibition is a prerogative writ—that is to say, it does not issue as of course, but is granted only on proper grounds being shown. Before the Judicature Acts prohibition was granted by one of the superior courts at Westminster; it also issued in certain cases from the court of chancery. It is now granted by the High Court of Justice. Up to 1875 the high court of admiralty was for the purposes of prohibition an inferior court. But now by the Judicature Act 1873, s. 24, it is provided that no proceeding in the High Court of Justice or the court of appeal is to be restrained by prohibition, a stay of proceedings taking its place where necessary. The admiralty division being now one of the divisions of the High Court can therefore no longer

be restrained by prohibition. The courts to which it has most frequently issued are the ecclesiastical courts, and county and other local courts, such as the lord mayor's court of London, the court of passage of the city of Liverpool and the court of record of the hundred of Salford. In the case of courts of quarter sessions, the same result is generally obtained by *certiorari* (see WRIT). The extent to which the ecclesiastical courts were restrainable by prohibition led to continual disputes for centuries between the civil and the ecclesiastical authorities. Attempts were made at different times to define the scope of the writ, the most conspicuous instances being the statute *Circumspecte Agatis*, 13 Edw. I. st. 4; the *Articuli cleri*, 9 Edw. II. st. 1; and the later *Articuli cleri* of 3 Jac. I., consisting of the claims asserted by Archbishop Bancroft and the reply of the judges. The law seems to be undoubted that the spiritual court acting in spiritual matters *pro salute animae* cannot be restrained. The difficulties arise in the application of the principle to individual cases.

Prohibition lies either before or after judgment. In order that proceedings should be restrained after judgment it is necessary that want of jurisdiction in the inferior court should appear upon the face of the proceedings, that the party seeking the prohibition should have taken his objection in the inferior court, or that he was in ignorance of a material fact. A prohibition goes either for excess of jurisdiction, as if an ecclesiastical court were to try a claim by prescription to a pew, or for transgression of clear laws of procedure, as if such a court were to require two witnesses to prove a payment of tithes. It will not as a rule be awarded on a matter of practice. The remedy in such a case is appeal. Nor will it go, unless in exceptional cases, at the instance of a stranger to the suit. The procedure in prohibition is partly common law, partly statutory. Application for a prohibition is usually made *ex parte* to a judge in chambers on affidavit. The application may be granted or refused. If granted, a rule to show cause why a writ of prohibition should not issue goes to the inferior judge and the other party. In prohibition to courts other than county courts pleadings in prohibition may be ordered. These pleadings are as far as possible assimilated to pleadings in actions. They are rare in practice, and are only ordered in cases of great difficulty and importance.

Much learning on the subject of prohibition will be found in the opinion of Mr Justice Wills delivered to the House of Lords in *The Mayor and Aldermen of London v. Cox* (1867, L.R. 2 Eng. and Ir. Appeals, 239).

In Scots law prohibition is not used in the English sense. The same result is obtained by suspension or reduction. In the United States the Supreme Court has power to issue a prohibition to the district courts when proceeding as courts of admiralty and maritime jurisdiction. Most of the states have also their own law upon the subject, generally giving power to the supreme judicial authority in the state to prohibit courts of inferior jurisdiction.

PROJECTION, in mathematics. If from a fixed point S in space lines or rays be drawn to different points A, B, C, . . . in space, and if these rays are cut by a plane in points A', B', C', . . . the latter are called the projections of the given points on the plane. Instead of the plane another surface may be taken, and then the points are projected to that surface instead of to a plane. In this manner any figure, plane or in space of three dimensions, may be projected to any surface from any point which is called the centre of projection. If the figure projected is in three dimensions then this projection is the same as that used in what is generally known as *perspective* (*q.v.*).

In modern mathematics the word *projection* is often taken with a slightly different meaning, supposing that plane figures are projected into plane figures, but three-dimensional ones into three-dimensional figures. Projection in this sense, when treated by co-ordinate geometry, leads in its algebraical aspect to the theory of linear substitution and hence to the theory of invariants and co-variants (see ALGEBRAIC FORMS).

In this article projection will be treated from a purely geometrical point of view. References like (G. § 87) relate to the article GEOMETRY, § *Projective*, in vol. xi.

§ 1. *Projection of Plane Figures.*—Let us suppose we have in space two planes π and π' . In the plane π a figure is given having known properties; then we have the problem to find its projection from some centre S to the plane π' , and to deduce from the known properties of the given figure the properties of the new one.

If a point A is given in the plane π we have to join it to the centre S and find the point A' where this ray SA cuts the plane π' ; it is the projection of A . On the other hand if A' is given in the plane π' , then A will be its projection in π . Hence if one figure in π' is the projection of another in π , then conversely the latter is also the projection of the former.

A point and its projection are therefore also called corresponding points, and similarly we speak of corresponding lines and curves, &c.

§ 2. We at once get the following properties:—

The projection of a point is a point, and one point only.

The projection of a line (straight line) is a line; for all points in a line are projected by rays which lie in the plane determined by S and the line, and this plane cuts the plane π' in a line which is the projection of the given line.

If a point lies in a line its projection lies in the projection of the line.

The projection of the line joining two points A, B is the line which joins the projections A', B' of the points A, B . For the projecting plane of the line AB contains the rays SA, SB which project the points A, B .

The projection of the point of intersection of two lines a, b is the point of intersection of the projections a', b' of those lines.

Similarly we get—

The projection of a curve is a curve.

The projections of the points of intersection of two curves are the points of intersection of the projections of the given curves.

If a line cuts a curve in n points, then the projection of the line cuts the projection of the curve in n points. Or—

The order of a curve remains unaltered by projection.

The projection of a tangent to a curve is a tangent to the projection of the curve. For the tangent is a line which has two coincident points in common with a curve.

The number of tangents that can be drawn from a point to a curve remains unaltered by projection. Or—

The class of a curve remains unaltered by projection.

§ 3. Two figures of which one is a projection of the other obtained in the manner described may be moved out of the position in which they are obtained. They are then still said to be one the projection of the other, or to be projective or homographic. But when they are in the position originally considered they are said to be in *perspective position*, or (shorter) to be *perspective*.

All the properties stated in §§ 1, 2 hold for figures which are projective, whether they are perspective or not. There are others which hold only for projective figures when they are in perspective position, which we shall now consider.

If two planes π and π' are perspective, then their line of intersection is called the *axis of projection*. Any point in this line coincides with its projection. Hence—

All points in the axis are their own projections. Hence also—

Every line meets its projection on the axis.

§ 4. The property that the lines joining corresponding points all pass through a common point, that any pair of corresponding points and the centre are in a line, is also expressed by saying that the figures are co-linear or co-polar; and the fact that both figures have a line, the axis, in common on which corresponding lines meet is expressed by saying that the figures are co-axial.

The connexion between these properties has to be investigated.

For this purpose we consider in the plane π a triangle ABC , and let the lines BC, CA, AB be denoted by a, b, c . The projection will consist of three points A', B', C' and three lines a', b', c' . These have such a position that the lines AA', BB', CC' meet in a point, viz. at S , and the points of intersection of a and a', b and b', c and c' lie on the axis (by § 2). The two triangles therefore are said to be both co-linear and co-axial. Of these properties either is a consequence of the other, as will now be proved.

If two triangles, whether in the same plane or not, are co-linear they are co-axial. Or—

If the lines AA', BB', CC' joining the vertices of two triangles meet in a point, then the intersections of the sides BC and $B'C', CA$ and $C'A', AB$ and $A'B'$ are three points in a line. Conversely—

If two triangles are co-axial they are co-linear. Or—

If the intersection of the sides of two triangles ABC and $A'B'C'$, viz. of BC and $B'C',$ of CA and $C'A',$ and of AB and $A'B'$, lie in a line, then the lines $AA', BB',$ and CC' meet in a point.

Proof.—Let us first suppose the triangles to be in different planes. By supposition the lines AA', BB', CC' (fig. 1) meet in a point S . But three intersecting lines determine three planes, SCB, SCA and SAB . In the first lie the points B, C and also B', C' . Hence the lines BC and $B'C'$ will intersect at some point P , because any two lines in the same plane intersect. Similarly CA and $C'A'$ will intersect at some point Q , and AB and $A'B'$ at some point R . These points P, Q, R lie in the plane of the triangle ABC because they are points on the sides of this triangle, and similarly in the plane of the triangle $A'B'C'$. Hence they lie in the intersection of two planes—that is, in a line. This line (PQR in fig. 1) is called

the axis of perspective or homology, and the intersection of AA', BB', CC' , i.e. S in the figure, the centre of perspective.

Secondly, if the triangles ABC and $A'B'C'$ lie both in the same plane the above proof does not hold. In this case we may consider the plane figure as the projection of the figure in space of which we have just proved the theorem. Let $ABC, A'B'C'$ be the co-linear triangles with S as centre, so that AA', BB', CC' meet at S . Take now any point in space, say your eye E , and from it draw the rays projecting the figure. In the line ES take any point S_1 , and in EA, EB, EC take points A_1, B_1, C_1 respectively, but so that S_1, A_1, B_1, C_1 are not in a plane. In the plane ESA which projects the line S_1A_1 lie then the line S_1A_1 and also EA' ; these will therefore meet in a point A'_1 , of which A' will be the projection. Similarly points B'_1, C'_1 are found. Hence we have now in space two triangles $A_1B_1C_1$ and $A'_1B'_1C'_1$ which are co-linear. They are therefore co-axial, that is, the points P_1, Q_1, R_1 , where $A_1B_1, &c.$, meet will lie in a line. Their projections therefore lie in a line. But these are the points P, Q, R , which were to be proved to lie in a line.

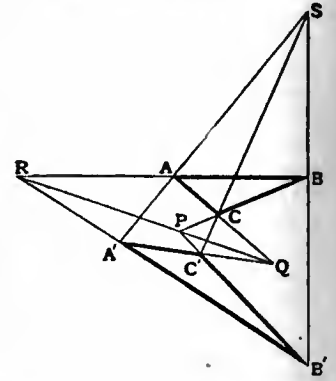

FIG. 1.

This proves the first part of the theorem. The second part or converse theorem is proved in exactly the same way. For another proof see (G. § 37).

§ 5. By aid of this theorem we can now prove a fundamental property of two projective planes.

Let s be the axis, S the centre, and let A, A' and B, B' be two pairs of corresponding points which we suppose fixed, and C, C' any other pair of corresponding points. Then the triangles ABC and $A'B'C'$ are co-axial, and they will remain co-axial if the one plane π' be turned relative to the other about the axis. They will therefore, by Desargue's theorem, remain co-linear, and the centre will be the point S' , where AA' meets BB' . Hence the line joining any pair of corresponding points C, C' will pass through the centre S' . The figures are therefore perspective. This will remain true if the planes are turned till they coincide, because Desargue's theorem remains true.

If two planes are perspective, then if the one plane be turned about the axis through any angle, especially if the one plane be turned till it coincides with the other, the two planes will remain perspective; corresponding lines will still meet on a line called the axis, and the lines joining corresponding points will still pass through a common centre S situated in the plane.

Whilst the one plane is turned this point S will move in a circle whose centre lies in the plane π , which is kept fixed, and whose plane is perpendicular to the axis.

The last part will be proved presently. As the plane π' may be turned about the axis in one or the opposite sense, there will be two perspective positions possible when the planes coincide.

§ 6. Let (fig. 2) π, π' be the planes intersecting in the axis s whilst S is the centre of projection. To project a point A in π

we join A to S and see where this line cuts π' . This gives the point A' . But if we draw through S any line parallel to π , then this line will cut π' in some point I' , and if all lines through S be drawn which are parallel to π these will form a plane parallel to π which will cut the plane π' in a line i' parallel to the axis s . If we say that a line parallel to a plane cuts the latter at an infinite distance, we may say that all points at an infinite distance in π are projected into points which lie in a straight line i' , and conversely all points in the line are projected to an infinite distance in π , whilst all other points are projected to finite points. We say therefore that all points in the plane π at an infinite distance may be considered as lying in a straight line, because their projections lie in a line. Thus we are again led to consider points at infinity in a plane as lying in a line (cf. G. §§ 2-4).

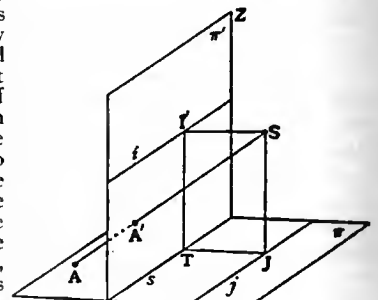

FIG. 2.

Similarly there is a line j in π which is projected to infinity in π' ; this projection will be denoted by j' so that i and j' are lines at infinity.

§ 7. If we suppose through S a plane drawn perpendicular to the axis s cutting it at T , and in this plane the two lines SI' parallel to π and SJ parallel to π' , then the lines through I' and J

parallel to the axis will be the lines i' and j . At the same time a parallelogram SJTI'S has been formed. If now the plane π' be turned about the axis, then the points I' and J will not move in their planes; hence the lengths TJ and TI', and therefore also SI' and SJ, will not change. If the plane π is kept fixed in space the point J will remain fixed, and S describes a circle about J as centre and with SJ as radius. This proves the last part of the theorem in § 5.

§ 8. The plane π' may be turned either in the sense indicated by the arrow at Z or in the opposite sense till π' falls into π . In the first case we get a figure like fig. 3; i' and j will be on the same side of the axis, and on this side will also lie the centre S; and

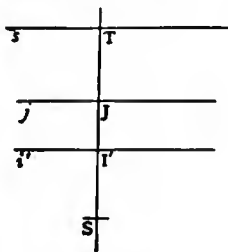

FIG. 3.

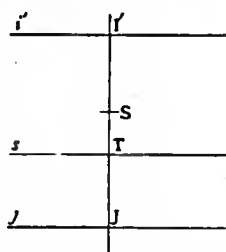

FIG. 4.

then $ST = SJ + SI'$ or $SI' = JT$, $SJ = I'T$. In the second case (fig. 4) i' and j will be on opposite sides of the axis, and the centre S will lie between them in such a position that $I'S = TJ$ and $I'T = SJ$. If $I'S = SJ$, the point S will lie on the axis.

It follows that any one of the four points S, T, J, I' is completely determined by the other three: if the axis, the centre, and one of the lines i' or j are given the other is determined; the three lines s, i', j determine the centre; the centre and the lines i', j determine the axis.

§ 9. We shall now suppose that the two projective planes π, π' are perspective and have been made to coincide.

If the centre, the axis, and either one pair of corresponding points on a line through the centre or one pair of corresponding lines meeting on the axis are given, then the whole projection is determined.

Proof.—If A and A' (fig. 1) are given corresponding points, it has to be shown that we can find to every other point B the corresponding point B'. Join AB to cut the axis in R. Join RA'; then B' must lie on this line. But it must also lie on the line SB. Where both meet is B'. That the figures thus obtained are really projective can be seen by aid of the theorem of § 4. For, if for any point C the corresponding point C' be found, then the triangles ABC and A'B'C' are, by construction, co-linear, hence co-axial; and s will be the axis, because AB and AC meet their corresponding lines A'B' and A'C' on it. BC and B'C' therefore also meet on s .

If on the other hand a, a' are given corresponding lines, then any line through S will cut them in corresponding points A, A' which may be used as above.

§ 10. Rows and pencils which are projective or perspective have been considered in the article GEOMETRY (G. §§ 12-40). All that has been said there holds, of course, here for any pair of corresponding rows or pencils. The centre of perspective for any pair of corresponding rows is at the centre of projection S, whilst the axis contains coincident corresponding elements. Corresponding pencils on the other hand have their axis of perspective on the axis of projection whilst the coincident rays pass through the centre.

We mention here a few of those properties which are independent of the perspective position:—

The correspondence between two projective rows or pencils is completely determined if to three elements in one the corresponding ones in the other are given. If for instance in two projective rows three pairs of corresponding points are given, then we can find to every other point in either the corresponding point (G. §§ 29-36).

If A, B, C, D are four points in a row and A', B', C', D' the corresponding points, then their cross-ratios are equal $(AB, CD) = (A'B, C'D')$ —where $(AB, CD) = AC/BC \cdot AD/DB$.

If in particular the point D be at infinity we have $(AB, CD) = -AC/BC = AC/BC$. If therefore the points D and D' are both at infinity we have $AC/BC = AD/BD$, and the rows are similar (G. § 39). This can only happen in special cases. For the line joining corresponding points passes through the centre; the latter must therefore lie at infinity if D, D' are different points at infinity. But if D and D' coincide they must lie on the axis, that is, at the point at infinity of the axis unless the axis is altogether at infinity. Hence—

In two perspective planes every row which is parallel to the axis is similar to its corresponding row, and in general no other row has this property.

But if the centre or the axis is at infinity then every row is similar to its corresponding row.

In either of these two cases the metrical properties are particularly simple. If the axis is at infinity the ratio of similitude is the same for all rows and the figures are similar. If the centre is at infinity we get parallel projection; and the ratio of similitude changes from row to row (see §§ 16, 17).

In both cases the mid-points of corresponding segments will be corresponding points.

§ 11. Involution.—If the planes of two projective figures coincide, then every point in their common plane has to be counted twice, once as a point A in the figure π , once as a point B' in the figure π' . The points A' and B corresponding to them will in general be different points, but it may happen that they coincide. Here a theorem holds similar to that about rows (G. §§ 76 seq.).

If two projective planes coincide, and if to one point in their common plane the same point corresponds, whether we consider the point as belonging to the first or to the second plane, then the same will happen for every other point—that is to say, to every point will correspond the same point in the first as in the second plane.

In this case the figures are said to be in involution. Proof.—Let (fig. 5) S be the centre, s the axis of projection, and let a point denoted by A in the first plane and by B' in the second

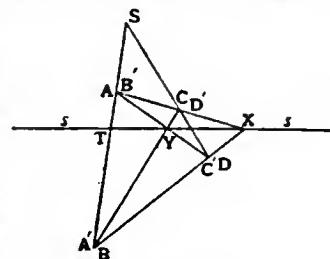

FIG. 5.

have the property that the points A' and B corresponding to them again coincide. Let C and D' be the names which some other point has in the two planes. If the line AC cuts the axis in X, then the point where the line XA' cuts SC will be the point C' corresponding to C (§ 9). The line B'D' also cuts the axis in X, and therefore the point D corresponding to D' is the point where XB cuts SD'. But this is the same point as C'.

This point C' might also be got by drawing CB and joining its intersection Y with the axis to B'. Then C' must be the point where B'Y meets SC. This figure, which now forms a complete quadrilateral, shows that in order to get involution the corresponding points A and A' have to be harmonic conjugates with regard to S and the point T where AA' cuts the axis.

If two perspective figures be in involution, two corresponding points are harmonic conjugates with regard to the centre and the point where the line joining them cuts the axis. Similarly—

Any two corresponding lines are harmonic conjugates with regard to the axis and the line from their point of intersection to the centre. Conversely—

If in two perspective planes one pair of corresponding points be harmonic conjugates with regard to the centre and the point where the line joining them cuts the axis, then every pair of corresponding points has this property and the planes are in involution.

§ 12. Projective Planes which are not in perspective position.—We return to the case that two planes π and π' are projective but not in perspective position, and state in some of the more important cases the conditions which determine the correspondence between them. Here it is of great advantage to start with another definition which, though at first it may seem to be of far greater generality, is in reality equivalent to the one given before.

We call two planes projective if to every point in one corresponds a point in the other, to every line a line, and to a point in a line a point in the corresponding line, in such a manner that the cross-ratio of four points in a line, or of four rays in a pencil, is equal to the cross-ratio of the corresponding points or rays.

The last part about the equality of cross-ratios can be proved to be a consequence of the first. As space does not allow us to give an exact proof for this we include it in the definition.

If one plane is actually projected to another we get a correspondence which has the properties required in the new definition. This shows that a correspondence between two planes conform to this definition is possible. That it is also definite we have to show. It follows at once that—

Corresponding rows, and likewise corresponding pencils, are projective in the old sense (G. §§ 25, 30). Further—

If two planes are projective to a third they are projective to each other. The correspondence between two projective planes π and π' is determined if we have given either two rows u, v in π and the corresponding rows u', v' in π' , the point where u and v meet corresponding to the points where u' and v' meet, or two pencils U, V in π and the corresponding pencils U', V' in π' , the ray UV joining the centres of the pencils in π corresponding to the ray U'V'.

It is sufficient to prove the first part. Let any line a cut u, v in the points A and B. To these will correspond points A' and B' in u' and v' which are known. To the line a corresponds then the line A'B'. Thus to every line in the one plane the corresponding line in the other can be found, hence also to every point the corresponding point.

§ 13. If the planes of two projective figures coincide, and if either four points, of which no three lie in a line, or else four lines, of which no three pass through a point, in the one coincide with their corresponding points, or lines, in the other, then every point and every line coincides with its corresponding point or line so that the figures are identical.

If the four points A, B, C, D coincide with their corresponding points, then every line joining two of these points will coincide with

its corresponding line. Thus the lines AB and CD, and therefore also their point of intersection E, will coincide with their corresponding elements. The row AB has thus three points A, B, E coincident with their corresponding points, and is therefore identical with it (§ 10). As there are six lines which join two and two of the four points A, B, C, D, there are six lines such that each point in either coincides with its corresponding point. Every other line will thus have the six points in which it cuts these, and therefore all points, coincident with their corresponding points. The proof of the second part is exactly the same. It follows—

§ 14. *If two projective figures, which are not identical, lie in the same plane, then not more than three points which are not in a line, or three lines which do not pass through a point, can be coincident with their corresponding points or lines.*

If the figures are in perspective position, then they have in common one line, the axis, with all points in it, and one point, the centre, with all lines through it. No other point or line can therefore coincide with its corresponding point or line without the figures becoming identical.

It follows also that—

The correspondence between two projective planes is completely determined if there are given—either to four points in the one the corresponding four points in the other provided that no three of them lie in a line, or to any four lines the corresponding lines provided that no three of them pass through a point.

To show this we observe first that two planes π , π' may be made projective in such a manner that four given points A, B, C, D in the one correspond to four given points A', B', C', D' in the other; for to the lines AB, CD will correspond the lines A'B' and C'D', and to the intersection E of the former the point E' where the latter meet. The correspondence between these rows is therefore determined, as we know three pairs of corresponding points. But this determines a correspondence (by § 12). To prove that in this case and also in the case of § 12 there is but one correspondence possible, let us suppose there were two, or that we could have in the plane π' two figures which are each projective to the figure in π and which have each the points A'B'C'D' corresponding to the points ABCD in π . Then these two figures will themselves be projective and have four corresponding points coincident. They are therefore identical by § 13.

Two projective planes will be in perspective if one row coincides with its corresponding row. The line containing these rows will be the axis of projection.

As in this case every point on s coincides with its corresponding point, it follows that every row a meets its corresponding row a' on s where corresponding points are united. The two rows a , a' are therefore perspective (G. § 30), and the lines joining corresponding points will meet in a point S. If r be any one of these lines cutting a , a' in the points A and A' and the line s at K, then to the line AK corresponds A'K, or the ray r corresponds to itself. The points B, B' in which r cuts another pair b , b' of corresponding rows must therefore be corresponding points. Hence the lines joining corresponding points in b and b' also pass through S. Similarly all lines joining corresponding points in the two planes π and π' meet in S; hence the planes are perspective.

The following proposition is proved in a similar way:—

Two projective planes will be in perspective position if one pencil coincides with its corresponding one. The centre of these pencils will be the centre of perspective.

In this case the two planes must of course coincide, whilst in the first case this is not necessary.

§ 15. We shall now show that two planes which are projective according to definition (§ 12) can be brought into perspective position, hence that the new definition is really equivalent to the old. We use the following property: If two coincident planes π and π' are perspective with S as centre, then any two corresponding rows are also perspective with S as centre. This therefore is true for the row j and j' and for i and i' , of which i and j are the lines at infinity in the two planes. If now the plane π' be made to slide on π so that each line moves parallel to itself, then the point at infinity in each line, and hence the whole line at infinity in π' , remains fixed. So does the point at infinity on j , which thus remains coincident with its corresponding point on j' , and therefore the rows j and j' remain perspective, that is to say the rays joining corresponding points in them meet at some point T. Similarly the lines joining corresponding points in i and i' will meet in some point T'. These two points T and T' originally coincided with each other and with S.

Conversely, if two projective planes are placed one on the other, then as soon as the lines j and j' are parallel the two points T and T' can be found by joining corresponding points in j and j' , and also in i and i' . If now a point at infinity is called A as a point in π and B' as a point in π' , then the point A' will lie on i' and B on j , so that the line AA' passes through T' and BB' through T. These two lines are parallel. If then the plane π' be moved parallel to itself till T' comes to T, then these two lines will coincide with each other, and with them will coincide the lines AB and A'B'. This line and similarly every line through T will thus now coincide with its corresponding line. The two planes are therefore according to the last theorem in § 14 in perspective position.

It will be noticed that the plane π' may be placed on π in two different ways, viz. if we have placed π' on π we may take it off and turn it over in space before we bring it back to π , so that what was its upper becomes now its lower face. For each of these positions we get one pair of centres T, T', and only one pair, because the above process must give every perspective position. It follows—

In two projective planes there are in general two and only two pencils in either such that angles in one are equal to their corresponding angles in the other. If one of these pencils is made coincident with its corresponding one, then the planes will be perspective.

This agrees with the fact that two perspective planes in space can be made coincident by turning one about their axis in two different ways (§ 8).

In the reasoning employed it is essential that the lines j and j' are finite. If one lies at infinity, say j , then j and j' coincide, hence their corresponding lines i' and j' will coincide; that is, i' also lies at infinity, so that the lines at infinity in the two planes are corresponding lines. If the planes are now made coincident and perspective, then it may happen that the lines at infinity correspond point for point, or can be made to do so by turning the one plane in itself. In this case the line at infinity is the axis, whilst the centre may be a finite point. This gives similar figures (see § 16). In the other case the line at infinity corresponds to itself without being the axis; the lines joining corresponding points therefore all coincide with it, and the centre S lies on it at infinity. The axis will be some finite line. This gives parallel projection (see § 17). For want of space we do not show how to find in these cases the perspective position, but only remark that in the first case any pair of corresponding points in π and π' may be taken as the points T and T', whilst in the other case there is a pencil of parallels in π such that any one line of these can be made to coincide point for point with its corresponding line in π' , and thus serve as the axis of projection. It will therefore be possible to get the planes in perspective position by first placing any point A' on its corresponding point A and then turning π' about this point till lines joining corresponding points are parallel.

§ 16. *Similar Figures.*—If the axis is at infinity every line is parallel to its corresponding line. Corresponding angles are therefore equal. The figures are similar, and (§ 10) the ratio of similitude of any two corresponding rows is constant.

If similar figures are in perspective position they are said to be similarly situated, and the centre of projection is called the centre of similitude. To place two similar figures in this position, we observe that their lines at infinity will coincide as soon as both figures are put in the same plane, but the rows on them are not necessarily identical. They are projective, and hence in general not more than two points on one will coincide with their corresponding points in the other (G. § 34). To make them identical it is either sufficient to turn one figure in its plane till three lines in one are parallel to their corresponding lines in the other, or it is necessary before this can be done to turn the one plane over in space. It can be shown that in the former case all lines are, or no line is, parallel to its corresponding line, whilst in the second case there are two directions, at right angles to each other, which have the property that each line in either direction is parallel to its corresponding line. We also see that—

If in two similar figures three lines, of which no two are parallel, are parallel respectively to their corresponding lines, then every line has this property and the two figures are similarly situated; or

Two similar figures are similarly situated as soon as two corresponding triangles are so situated.

If two similar figures are perspective without being in the same plane, their planes must be parallel as the axis is at infinity. Hence—

Any plane figure is projected from any centre to a parallel plane into a similar figure.

If two similar figures are similarly situated, then corresponding points may either be on the same or on different sides of the centre. If, besides, the ratio of similitude is unity, then corresponding points will be equidistant from the centre. In the first case therefore the two figures will be identical. In the second case they will be identically equal but not coincident. They can be made to coincide by turning one in its plane through two right angles about the centre of similitude S. The figures are in involution, as is seen at once, and they are said to be *symmetrical with regard to the point S as centre*. If the two figures be considered as part of one, then this is said to have a centre. Thus regular polygons of an even number of sides and parallelograms have each a centre, which is a centre of symmetry.

§ 17. *Parallel Projection.*—If, instead of the axis, the centre be moved to infinity, all the projecting rays will be parallel, and we get what is called *parallel projection*. In this case the line at infinity passes through the centre and therefore corresponds to itself—but not point for point as in the case of similar figures. To any point I at infinity corresponds therefore a point I' also at infinity but different from the first. Hence to parallel lines meeting at I correspond parallel lines of another direction meeting at I'. Further, in any two corresponding rows the two points at infinity are corresponding points; hence the rows are similar. This gives the principal properties of parallel projection:—

To parallel lines correspond parallel lines; or

To a parallelogram corresponds a parallelogram.

The correspondence of parallel projection is completely determined as soon as for any parallelogram in the one figure the corresponding parallelogram in the other has been selected, as follows from the general case in § 14. [Corresponding rows are similar (§ 10).]

The ratio of similitude for these rows changes with the direction: If a row is parallel to the axis, its corresponding row, which is also parallel to the axis, will be equal to it, because any two pairs AA' and BB' of corresponding points will form a parallelogram.

Another important property is the following:—

The areas of corresponding figures have a constant ratio.

We prove this first for parallelograms. Let ABCD and EFGH be any two parallelograms in π , A'B'C'D' and E'F'G'H' the corresponding parallelograms in π' . Then to the parallelogram KLMN which lies (fig. 6) between the lines AB, CD and EF, GH, KL, MN will correspond a parallelogram K'L'M'N' formed in exactly the same manner. As ABCD and KLMN are between the same parallels

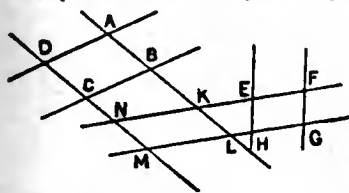

FIG. 6.

their areas are as the bases. Hence—

$$\frac{ABCD}{KLMN} = \frac{AB}{KL}, \text{ and similarly } \frac{A'B'C'D'}{K'L'M'N'} = \frac{A'B'}{K'L'}$$

But $AB/KL = A'B'/K'L'$, as the rows AB and A'B' are similar. Hence

$$\frac{ABCD}{A'B'C'D'} = \frac{KLMN}{K'L'M'N'} \text{ and similarly } \frac{EFGH}{E'F'G'H'} = \frac{KLMN}{K'L'M'N'}$$

Hence also

$$\frac{ABCD}{A'B'C'D'} = \frac{EFGH}{E'F'G'H'}$$

This proves the theorem for parallelograms and also for their halves, that is, for any triangles. As polygons can be divided into triangles the truth of the theorem follows at once for them, and is extended (by the method of exhaustion) to areas bounded by curves by inscribing polygons in, and circumscribing polygons about, the curves.

Just as (G. § 8) a segment of a line is given a sense, so a sense may be given to an area. This is done as follows. If we go round the boundary of an area, the latter is either to the right or to the left. If we turn round and go in the opposite sense, then the area will be to the left if it was first to the right, and vice versa. If we give the boundary a definite sense, and go round in this sense, then the area is said to be either of the one or of the other sense according as the area is to the right or to the left. The area is generally said to be positive if it is to the left. The sense of the boundary is indicated either by an arrowhead or by the order of the letters which denote points in the boundary. Thus, if A, B, C be the vertices of a triangle, then ABC shall denote the area in magnitude and sense, the sense being fixed by going round the triangle in the order from A to B to C. It will then be seen that ABC and ACB denote the same area but with opposite sense, and generally $ABC = BCA = CAB = -ACB = -BAC = -CBA$; that is, an interchange of two letters changes the sense. Also, if A and A' are two points on opposite sides of, and equidistant from, the line BC, then $ABC = -A'BC$.

Taking account of the sense, we may make the following statement:—

If A, A' are two corresponding points, if the line AA' cuts the axis in B, and if C is any other point in the axis, then the triangles ABC and A'BC are corresponding, and

$$\frac{ABC}{A'BC} = \frac{AB}{A'B} = -\frac{AB}{BA'}$$

or The constant ratio of corresponding areas is equal and opposite to the ratio in which the axis divides the segment joining two corresponding points.

§ 18. Several special cases of parallel projection are of interest.

Orthographic Projection.—If the two planes π and π' have a definite position in space, and if a figure in π is projected to π' by rays perpendicular to this plane, then the projection is said to be orthographic. If in this case the plane π be turned till it coincides with π' so that the figures remain perspective, then the projecting rays will be perpendicular to the axis of projection, because any one of these rays is, and remains during the turning, perpendicular to the axis.

The constant ratio of the area of the projection to that of the original figure is, in this case, the cosine of the angle between the two planes π and π' , as will be seen by projecting a rectangle which has its base in the axis.

Orthographic projection is of constant use in geometrical drawing.

Shear.—If the centre of projection be taken at infinity on the axis, then the projecting rays are parallel to the axis; hence corresponding points will be equidistant from the axis. In this case, therefore, areas of corresponding figures will be equal.

If A, A' and B, B' (fig. 7) are two pairs of corresponding points on the same line, parallel to the axis, then, as corresponding segments parallel to the axis are equal, it follows that $AB = A'B'$, hence also $AA' = BB'$. If these points be joined to any point O on the axis, then AO and A'O will be corresponding lines; they will therefore be cut by any line parallel to the axis in corresponding points. In the figure therefore C, C' and also D, D' will be pairs of corresponding points and $CC' = DD'$. As the ratio CC'/AA' equals the ratio of the distances of C and A from the axis, therefore—

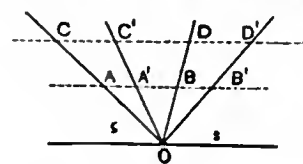

FIG. 7.

Two corresponding figures may be got one out of the other by moving all points in the one parallel to a fixed line, the axis, through distances which are proportional to their own distances from the axis. Points in a line remain hereby in a line.

Such a transformation of a plane figure is produced by a shearing stress in any section of a homogeneous elastic solid. For this reason Lord Kelvin gave it the name of shear.

A shear of a plane figure is determined if we are given the axis and the distance through which one point has been moved; for in this case the axis, the centre, and a pair of corresponding points are given.

§ 19. Symmetry and Skew-Symmetry.—If the centre is not on the axis, and if corresponding points are at equal distances from it, they must be on opposite sides of it. The figures will be in involution (§ 11). In this case the direction of the projecting rays is said to be conjugate to the axis.

The conjugate direction may be perpendicular to the axis. If the line joining two corresponding points A, A' cuts the axis in B, then $AB = BA'$. Therefore, if the plane be folded over along the axis, A will fall on A'. Hence by this folding over every point will coincide with its corresponding point. The figures therefore are identically equal or congruent, and in their original position they are symmetrical with regard to the axis, which itself is called an axis of symmetry. If the two figures are considered as one this one is said to be symmetrical with regard to an axis, and is said to have an axis of symmetry or simply an axis. Every diameter of a circle is thus an axis; also the median line of an isosceles triangle and the diagonals of a rhombus are axes of the figures to which they belong.

In the more general case where the projecting rays are not perpendicular to the axis we have a kind of twisted symmetry which may be called skew-symmetry. It can be got from symmetry by giving the whole figure a shear. It will also be easily seen that we get skew-symmetry if we first form a shear to a given figure and then separate it from its shear by folding it over along the axis of the shear, which thereby becomes an axis of skew-symmetry.

Skew-symmetrical and therefore also symmetrical figures have the following properties:—

Corresponding areas are equal, but of opposite sense.

Any two corresponding lines are harmonic conjugates with regard to the axis and a line in the conjugate direction.

If the two figures be again considered as one whole, this is said to be skew-symmetrical and to have an axis of skew-symmetry. Thus the median line of any triangle is an axis of skew-symmetry, the side on which it stands having the conjugate direction, the other sides being conjugate lines. From this it follows, for instance, that the three median lines of a triangle meet in a point. For two median lines will be corresponding lines with regard to the third as axis, and must therefore meet on the axis.

An axis of skew-symmetry is generally called a diameter. Thus every diameter of a conic is an axis of skew-symmetry, the conjugate direction being the direction of the chords which it bisects.

§ 20. We state a few properties of these figures useful in mechanics, but we omit the easy proofs:—

If a plane area has an axis of skew-symmetry, then the mass-centre (centre of mean distances or centre of inertia) lies on it.

If a figure undergoes a shear, the mass-centre of its area remains the mass-centre; and generally—

In parallel projection the mass-centres of corresponding areas (or of groups of points, but not of curves) are corresponding points.

The moment of inertia of a plane figure does not change if the figure undergoes a shear in the direction of the axis with regard to which the moment has been taken.

If a figure has an axis of skew-symmetry, then this axis and the conjugate direction are conjugate diameters of the momental ellipse for every point in the axis.

If a figure has an axis of symmetry, then this is an axis of the momental ellipse for every point in it.

The truth of the last propositions follows at once from the fact that the product of inertia for the lines in question vanishes.

It is of interest to notice how a great many propositions of Euclid are only special cases of projection. The theorems Euc. 1. 35-41 about parallelograms or triangles on equal bases and between the same parallels are examples of shear, whilst I. 43 gives a case of

skew-symmetry, hence of involution. Figures which are identically equal are of course projective, and they are perspective when placed so that they have an axis or a centre of symmetry (cf. Henri, *Elementary Geometry, Congruent Figures*). In this case again the relation is that of involution. The importance of treating similar figures when in perspective position has long been recognized; we need only mention the well-known proposition about the centres of similitude of circles.

Applications to Conics.

§ 21. Any conic can be projected into any other conic. This may be done in such a manner that three points on one conic and the tangents at two of them are projected to three arbitrarily selected points and the tangents at two of them on the other.

If u and u' are any two conics, then we have to prove that we can project u in such a manner that five points on it will be projected to points on u' . As the projection is determined as soon as the projections of any four points or four lines are selected, we cannot project any five points of u to any five arbitrarily selected points on u' . But if A, B, C be any three points on u , and if the tangents at B and C meet at D , if further A', B', C' are any three points on u' , and if the tangents at B' and C' meet at D' , then the plane of u may be projected to the plane of u' in such a manner that the points A, B, C, D are projected to A', B', C', D' . This determines the correspondence (§ 14). The conic u will be projected into a conic, the points A, B, C and the tangents BD and CD to the points A', B', C' and the lines $B'D'$ and $C'D'$, which are tangents to u' at B' and C' . The projection of u must therefore (G. § 52) coincide with u' , because it is a conic which has three points and the tangents at two of them in common with u' .

Similarly we might have taken three tangents and the points of contact of two of them as corresponding to similar elements on the other.

If the one conic be a circle which cuts the line j , the projection will cut the line at infinity in two points; hence it will be a hyperbola. Similarly, if the circle touches j , the projection will be a parabola; and, if the circle has no point in common with j , the projection will be an ellipse. These curves appear thus as sections of a circular cone, for in case that the two planes of projection are separated the rays projecting the circle form such a cone.

Any conic may be projected into itself.

If we take any point S in the plane of a conic as centre, the polar of this point as axis of projection, and any two points in which a line through S cuts the conic as corresponding points, then these will be harmonic conjugates with regard to the centre and the axis. We therefore have involution (§ 11), and every point is projected into its harmonic conjugate with regard to the centre and the axis—hence every point A on the conic into that point A' on the conic in which the line SA' cuts the conic again, as follows from the harmonic properties of pole and polar (G. § 62 seq.).

Two conics which cut the line at infinity in the same two points are similar figures and similarly situated—the centre of similitude being in general some finite point.

To prove this, we take the line at infinity and the asymptotes of one as corresponding to the line at infinity and the asymptotes of the other, and besides a tangent to the first as corresponding to a parallel tangent to the other. The line at infinity will then correspond to itself point for point; hence the figures will be similar and similarly situated.

§ 22. Areas of Parabolic Segments.—One parabola may always be considered as a parallel projection of another in such a manner that any two points A, B on the one correspond to any two points A', B' on the other; that is, the points A, B and the point at infinity on the one may be made to correspond respectively to the points A', B' and the point at infinity on the other, whilst the tangents at A and at infinity of the one correspond to the tangents at B' and at infinity of the other. This completely determines the correspondence, and it is parallel projection because the line at infinity corresponds to the line at infinity. Let the tangents at A and B meet at C , and those at A', B' at C' ; then C, C' will correspond, and so will the triangles ABC and $A'B'C'$ as well as the parabolic segments cut off by the chords AB and $A'B'$. If (AB) denotes the area of the segment cut off by the chord AB we have therefore

$$(AB)/ABC = (A'B')/A'B'C'; \text{ or}$$

The area of a segment of a parabola stands in a constant ratio to the area of the triangle formed by the chord of the segment and the tangents at the end points of the chord.

If then (fig. 8) we join the point C to the mid-point M of AB , then this line l will be bisected at D by the parabola (G. § 74), and the tangent at D will be parallel to AB . Let this tangent cut AC in E and CB in F , then by the last theorem

$$\frac{(AB)}{ABC} = \frac{(AD)}{ADE} = \frac{(BD)}{BFD} = m,$$

where m is some number to be determined. The figure gives

$$(AB) = ABD + (AD) + (BD).$$

FIG. 8.

Combining both equations, we have

$$ABD = m(ABC - ADE - BFD).$$

But we have also $ABD = \frac{1}{2}ABC$, and $ADE = BFD = \frac{1}{2}ABC$; hence

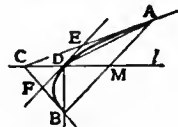
$$\frac{1}{2}ABC = m(1 - \frac{1}{2} - \frac{1}{2})ABC, \text{ or } m = \frac{2}{3}.$$

The area of a parabolic segment equals two-thirds of the area of the triangle formed by the chord and the tangents at the end points of the chord.

§ 23. Elliptic Areas.—To consider one ellipse a parallel projection of another we may establish the correspondence as follows. If AC, BD are any pair of conjugate diameters of the one and $A'C', B'D'$ any pair of conjugate diameters of the other, then these may be made to correspond to each other, and the correspondence will be completely determined if the parallelogram formed by the tangents at A, B, C, D is made to correspond to that formed by the tangents at A', B', C', D' (§§ 17 and 21). As the projection of the first conic has the four points A', B', C', D' and the tangents at these points in common with the second, the two ellipses are projected one into the other. Their areas will correspond, and so do those of the parallelograms $ABCD$ and $A'B'C'D'$. Hence—

The area of an ellipse has a constant ratio to the area of any inscribed parallelogram whose diagonals are conjugate diameters, and also to every circumscribed parallelogram whose sides are parallel to conjugate diameters.

It follows at once that—

All parallelograms inscribed in an ellipse whose diagonals are conjugate diameters are equal in area; and

All parallelograms circumscribed about an ellipse whose sides are parallel to conjugate diameters are equal in area.

If a, b are the length of the semi-axes of the ellipse, then the area of the circumscribed parallelogram will be $4ab$ and of the inscribed one $2ab$.

For the circle of radius r the inscribed parallelogram becomes the square of area $2r^2$ and the circle has the area $r^2\pi$; the constant ratio of an ellipse to the inscribed parallelogram has therefore also the value $\frac{1}{2}\pi$. Hence—

The area of an ellipse equals $ab\pi$.

§ 24. Projective Properties.—The properties of the projection of a figure depend partly on the relative position of the planes of the figures and the centre of projection, but principally on the properties of the given figure. Points in a line are projected into points in a line, harmonic points into harmonic points, a conic into a conic; but parallel lines are not projected into parallel lines nor right angles into right angles, neither are the projections of equal segments or angles again equal. There are then some properties which remain unaltered by projection, whilst others change. The former are called projective or descriptive, the latter metrical properties of figures, because the latter all depend on measurement.

To a triangle and its median lines correspond a triangle and three lines which meet in a point, but which as a rule are not median lines.

In this case, if we take the triangle together with the line at infinity, we get as the projection a triangle ABC , and some other line j which cuts the sides a, b, c of the triangle in the points A_1, B_1, C_1 . If we now take on BC the harmonic conjugate A_2 to A_1 and similarly on CA and AB the harmonic conjugates to B_1 and C_1 respectively, then the lines AA_2, BB_2, CC_2 will be the projections of the median lines in the given figure. Hence these lines must meet in a point.

As the triangle and the fourth line we may take any four given lines, because any four lines may be projected into any four given lines (§ 14). This gives a theorem:—

If each vertex of a triangle be joined to that point in the opposite side which is, with regard to the vertices, the harmonic conjugate of the point in which the side is cut by a given line, then the three lines thus obtained meet in a point.

We get thus out of the special theorem about the median lines of a triangle a more general one. But before this could be done we had to add the line at infinity to the lines in the given figure.

In a similar manner a great many theorems relating to metrical properties can be generalized by taking the line at infinity or points at infinity as forming part of the original figure. Conversely special cases relating to measurement are obtained by projecting some line in a figure of known properties to infinity. This is true for all properties relating to parallel lines or to bisection of segments, but not immediately for angles. It is, however, possible to establish for every metrical relation the corresponding projective property. To do this it is necessary to consider imaginary elements. These have originally been introduced into geometry by aid of co-ordinate geometry, where imaginary quantities constantly occur as roots of equations.

Their introduction into pure geometry is due principally to Poncelet, who by the publication of his great work *Traité des Propriétés Projectives des Figures* became the founder of projective geometry in its widest sense. Monge had considered parallel projection and had already distinguished between permanent and accidental properties of figures, the latter being those which depended merely on the accidental position of one part to another. Thus in projecting two circles which lie in different planes it

depends on the accidental position of the centre of projection whether the projections be two conics which do or do not meet. Poncelet introduced the principle of continuity in order to make theorems general and independent of those accidental positions which depend analytically on the fact that the equations used have real or imaginary roots. But the correctness of this principle remained without a proof. Von Staudt has, however, shown how it is possible to introduce imaginary elements by purely geometrical reasoning, and we shall now try to give the reader some idea of his theory.

§ 25. *Imaginary Elements.*—If a line cuts a curve and if the line be moved, turned for instance about a point in it, it may happen that two of the points of intersection approach each other till they coincide. The line then becomes a tangent. If the line is still further moved in the same manner it separates from the curve and two points of intersection are lost. Thus in considering the relation of a line to a conic we have to distinguish three cases—the line cuts the conic in two points, touches it, or has no point in common with it. This is quite analogous to the fact that a quadratic equation with one unknown quantity has either two, one, or no roots. But in algebra it has long been found convenient to express this differently by saying a quadratic equation has always two roots, but these may be either both real and different, or equal, or they may be imaginary. In geometry a similar mode of expressing the fact above stated is not less convenient.

We say therefore a line has always two points in common with a conic, but these are either distinct, or coincident, or invisible. The word imaginary is generally used instead of invisible; but, as the points have nothing to do with imagination, we prefer the word "invisible" recommended originally by Clifford.

Invisible points occur in pairs of conjugate points, for a line loses always two visible points of intersection with a curve simultaneously. This is analogous to the fact that an algebraical equation with real coefficients has imaginary roots in pairs. *Only one real line can be drawn through an invisible point*, for two real lines meet in a real or visible point. *The real line through an invisible point contains also its conjugate.*

Similarly there are invisible lines—tangents, for instance, from a point within a conic—which occur in pairs of conjugates, two conjugates having a real point in common.

The introduction of invisible points would be nothing but a play upon words unless there is a real geometrical property indicated which can be used in geometrical constructions—that it has a definite meaning, for instance, to say that two conics cut a line in the same two invisible points, or that we can draw one conic through three real points and the two invisible ones which another conic has in common with a line that does not actually cut it. We have in fact to give a geometrical definition of invisible points. This is done by aid of the theory of involution (G. § 76 seq.).

An involution of points on a line has (according to G. § 77 [2]) either two or one or no foci. Instead of this we now say it has always two foci which may be distinct, coincident or invisible. These foci are determined by the involution, but they also determine the involution. If the foci are real this follows from the fact that conjugate points are harmonic conjugates with regard to the foci. That it is also the case for invisible foci will presently appear. If we take this at present for granted we may replace a pair of real, coincident or invisible points by the involution of which they are the foci.

Now any two pairs of conjugate points determine an involution (G. § 77 [6]).

Hence any point-pair, whether real or invisible, is completely determined by any two pairs of conjugate points of the involution which has given the point-pair as foci and may therefore be replaced by them.

Two pairs of invisible points are thus said to be identical if, and only if, they are the foci of the same involution.

We know (G. § 82) that a conic determines on every line an involution in which conjugate points are conjugate poles with regard to the conic—that is, that either lies on the polar of the other. This holds whether the line cuts the conic or not. Furthermore, in the former case the points common to the line and the conic are the foci of the involution. Hence we now say that this is always the case, and that the *invisible* points common to a line and a conic are the *invisible* foci of the involution in question. If then we state the problem of drawing a conic which passes through two points given as the intersection of a conic and a line as that of drawing a conic which determines a given involution on the line, we have it in a form in which it is independent of the accidental circumstance of the intersections being real or invisible. So is the solution of the problem, as we shall now show.

§ 26. We have seen (§ 21) that a conic may always be projected into itself by taking any point S as centre and its polar s as axis of projection, corresponding points being those in which a line through S cuts the conic. If then (fig. 9) A, A' and B, B' are pairs of corresponding points so that the lines AA' and BB' pass through S , then the lines AB and $A'B'$, as corresponding lines, will meet at a point R on the axis, and the lines AB' and $A'B$ will meet at another point R' on the axis. These points R, R' are conjugate points in the involution which the conic determines on the line s ,

because the triangle RSR' is a polar triangle (G. § 62), so that R' lies on the polar of R .

This gives a simple means of determining for any point Q on the line s its conjugate point Q' . We take any two points A, A' on the conic which lie on a line through S , join Q to A by a line cutting the conic again in C , and join C to A' . This line will cut s in the point Q' required.

To draw some conic which shall determine on a line s a given involution.

We have here to reconstruct the fig. 9, having given on the line s an involution. Let Q, Q' and R, R' (fig. 9) be two pairs of conjugate points in this involution. We take any point B and join it to R and R' , and another point C to Q and Q' . Let BR and CQ meet at A , and BR' and CQ' at A' . If now a point P be moved along s its conjugate point P' will also move and the two points will describe projective rows. The two rays AP and $A'P'$ will therefore describe projective pencils, and the intersection of corresponding rays will lie on a conic which passes through A, A', B and C . This conic determines on s the given involution.

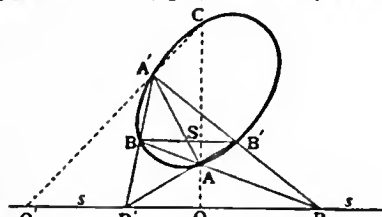

FIG. 9.

Of these four points not only B and C but also the point A may be taken arbitrarily, for if A, B, C are given, the line AB will cut s in some point R . As the involution is supposed known, we can find the point R' conjugate to R , which we join to B . In the same way the line CA will cut s in some point Q . Its conjugate point Q' we join to C . The line CQ' will cut BR' in a point A' , and then AA' will pass through the pole S (cf. fig. 9). We may now interchange A and B and find the point B' . Then BB' will also pass through S , which is thus found. At the same time five points A, B, C, A', B' on the conic have been found, so that the conic is completely known which determines on the line s the given involution. Hence—

Through three points we can always draw one conic, and only one, which determines on a given line a given involution, all the same whether the involution has real, coincident or invisible foci.

In the last case the theorem may now also be stated thus:—*It is always possible to draw a conic which passes through three given real points and through two invisible points which any other conic has in common with a line.*

§ 27. The above theory of invisible points gives rise to a great number of interesting consequences, of which we state a few. The theorem at the end of § 21 may now be stated:—*Any two conics are similar and similarly situated if they cut the line at infinity in the same two points—real, coincident or invisible.*

It follows that

Any two parabolas are similar; and they are similarly situated as soon as their axes are parallel.

The involution which a circle determines at its centre is circular (G. § 79); that is, every line is perpendicular to its conjugate line. This will be cut by the line at infinity in an involution which has the following property: The lines which join any finite point to two conjugate points in the involution are at right angles to each other. Hence all circular involutions in a plane determine the same involution on the line at infinity. The latter is therefore called the *circular involution on the line at infinity*; and the involution which a circle determines at its centre is called the *circular involution at that point*. All circles determine thus on the line at infinity the same involution; in other words, they have the same two invisible points in common with the line at infinity.

All circles may be considered as passing through the same two points at infinity.

These points are called the *circular points at infinity*, and by Professor Cayley the *absolute* in the plane. They are the foci of the circular involution in the line at infinity.

Conversely—*Every conic which passes through the circular points is a circle*; because the involution at its centre is circular, hence conjugate diameters are at right angles, and this property only circles possess.

We now see why we can draw always one and only one circle through any three points; these three points together with the circular points at infinity are five points through which one conic only can be drawn.

Any two circles are similar and similarly situated because they have the same points at infinity (§ 21).

Any two concentric circles may be considered as having double contact at infinity, because the lines joining the common centre to the circular points at infinity are tangents to both circles as the line at infinity is the polar of the centre.

Any two lines at right angles to one another are harmonic conjugates with regard to the rays joining their intersection to the circular points, because these rays are the focal rays of the circular involution at the intersection of the given lines.

To bisect an angle with the vertex A means (G. § 23) to find two rays through A which are harmonic conjugates with regard to the

limits of the angle and perpendicular to each other. These rays are therefore harmonic with regard to the limits of the given angle and with regard to the rays through the circular points. Thus perpendicularity and bisection of an angle have been stated in a projective form.

It must not be forgotten that the circular points do not exist at all; but to introduce them gives us a short way of making a statement which would otherwise be long and cumbersome.

We can now generalize any theorem relating to metrical properties. For instance, the simple fact that the chord of a circle is touched by a concentric circle at its *mid point* proves the theorem:—

If two conics have double contact, then the points where any tangent to one of them cuts the other are harmonic with regard to the point of contact and the point where the tangent cuts the chord of contact.

(O. H.)

PROKOP, the name of two of the most prominent Hussite generals

1. PROKOP, surnamed "Veliky" (the great) or "Holy" (the bald), was a married utraquist priest who belonged to an eminent family of citizens of Prague. Though a priest and continuing to officiate as such, he became the most prominent leader of the advanced Hussite or Taborite forces during the latter part of the Hussite wars. He was not indeed the immediate successor of Žižka as leader of the Taborites, as has been frequently stated, but he commanded the forces of Tabor when they obtained their great victories over the Germans and Romanists at Usti nad Labem (Aussig) in 1426 and Domažlice (Taus) in 1431. He also acted as leader of the Taborites during their frequent incursions into Hungary and Germany, particularly when in 1429 a vast Bohemian army invaded Saxony and the territory of Nuremberg. The Hussites, however, made no attempt permanently to conquer German territory, and on the 6th of February 1430 Prokop concluded at Kulmbach a treaty with Frederick of Brandenburg, burgrave of Nuremberg, by which the Hussites engaged themselves to leave Germany. When the Bohemians entered into negotiations with Sigismund and the Council of Basel and, after prolonged discussions, resolved to send an embassy to the council, Prokop the Great was the most prominent member of this embassy, which reached Basel on the 4th of January 1433. When the negotiations there for a time proved resultless Prokop with the other envoys returned to Bohemia, where new internal troubles broke out. A Taborite army led by Prokop the Great besieged Plzeň, which was then in the hands of the Romanists. The discipline in the Hussite camp had, however, slackened in the course of prolonged warfare, and the Taborites encamped before Plzeň revolted against Prokop, who therefore returned to Prague. Probably encouraged by these dissensions among the men of Tabor, the Bohemian nobility, both Romanist and utraquist, formed a league for the purpose of opposing democracy, which through the victories of Tabor had acquired great strength in the Bohemian towns. The struggle began at Prague. Aided by the nobles, the citizens of the old town took possession of the more democratic new town, which Prokop unsuccessfully attempted to defend. Prokop now called to his aid Prokop "the Lesser," who had succeeded him in the command of the Taborite army before Plzeň. They jointly retreated eastward from Prague, and their forces, known as the army of the towns, met at Lipan, between Kourim and Kolin, the army of the nobles (May 30, 1434). The Taborites were decisively defeated, and Prokop the Great perished in this battle.

2. PROKOP "the Lesser," or PROKUPEK (the Bohemian diminutive of the word Prokop), was one of the greatest Hussite generals. Little is known of his early life. He took part in all the later campaigns of Prokop the Great in Germany, and succeeded him as commander of the Taborite army that besieged Plzeň. After the formation of the confederacy of the nobles he was recalled by Prokop the Great, with whom he shared the command of the army of the towns at the fateful battle of Lipan, in which he also perished.

See Count Lutzow, *Bohemia: A Historical Sketch*; Palacky, *History of Bohemia*; Toman, *Husitske Valečnictvi* (Hussite Warfare).

PROKOPOVICH, THEOFAN (1681–1736), Russian archbishop and statesman, one of the ablest coadjutors of Peter the Great, was sprung from a merchant family. He brilliantly distinguished

himself at the Orthodox academy of Kiev, subsequently completing his education in Poland (for which purpose he turned Uniate), and at Rome in the College of the Propaganda. Primed with all the knowledge of the West, he returned home to seek his fortune, and, as the Orthodox monk, became one of the professors at, and subsequently rector of, the academy of Kiev. He entirely reformed the teaching of theology there, substituting the historical method of the German theologians for the antiquated Orthodox scholastic system. In 1709 Peter the Great, while passing through Kiev, was struck by the eloquence of Prokopovich in a sermon on "the most glorious victory," i.e. Poltava, and in 1716 summoned him to Petersburg. From henceforth it was Theofan's duty and pleasure to explain the new ideas and justify the most alarming innovations from the pulpit. So invaluable, indeed, did he become to the civil power, that, despite the determined opposition of the Russian clergy, who regarded "the Light of Kiev" as an interloper and semi-heretic, he was rapidly promoted, becoming, in 1718, bishop of Pskov, and finally, in 1724, archbishop of Novgorod. As the author of "the spiritual regulation" for the reform of the Russian Church, Theofan must, indeed, be regarded as the creator of "the spiritual department" superseding the patriarchate, and better known by its later name of "the holy synod," of which he was made the vice-president. Penetrated by the conviction that ignorance was the worst of the inveterate evils of old Russia, a pitiless enemy of superstition of every sort, a reformer by nature, overflowing with energy and resource, and with a singularly lucid mind armed at all points by a far-reaching erudition, Prokopovich was the soul of the reforming party after the death of Peter the Great. To him also belongs the great merit of liberating Russian preaching from the fetters of Polish turgidity and affectation by introducing popular themes and a simple style into Orthodox pulpit eloquence.

See I. Chistovitch, *Theofan Prokopovich and his Times* (Rus.; Petersburg, 1868); P. Morozov, *Theofan Prokopovich as a Writer* (Rus.; Petersburg, 1880). (R. N. B.)

PROLEGOMENON (Gr. for "that which is said beforehand," *προλέγειν*, to speak, say before), a preface or introduction to a book, especially a preliminary introductory essay to a learned work, or a treatise which serves as a general survey or introduction to the study of some subject or as a special survey of the subject. The word is more often used in the plural.

PROLETARIAT, or PROLETARIATE, a term borrowed from the French and used collectively of those classes of a political community who depend for their livelihood on their daily labour, the wage-earning, operative class as opposed to the capital-owning class. It is of frequent use by those social reformers who base their theories on the supposed antagonism of capital and labour. The Latin *proletarius*, from which the word was formed, was the name given to the body of citizens possessed of no property and who therefore served the state with their children (*proles*, offspring). This division of the members of the state was traditionally ascribed to Servius Tullius.

PROLOCUTOR, one who speaks for others (Lat. *pro*, for, and *loqui*, to speak); specifically the chairman of the lower house of convocation in the two provinces of the Church of England, who presides in that house and acts as representative and spokesman in the upper house. He is elected by the lower house, subject to the approval of the metropolitan. (See CONVOCATION.)

PROLOGUE (from Gr. *πρό*, before, and *λόγος*, a word), a prefatory piece of writing, usually composed to introduce a drama. The Greeks use a word *πρόλογος*, which included the modern meaning of the prologue, but was of wider significance, embracing any kind of preface, like the Latin *praefatio*. In Attic Greek drama, a character in the play, very often a deity, stood forward or appeared from a machine before the action of the play began, and made from the empty stage such statements as it was necessary that the audience should hear, in order that they might appreciate the ensuing drama. It was the early Greek custom to dilate in great detail on everything that had led up to the play, the latter being itself, as a rule,

merely the catastrophe which had inevitably to ensue on the facts related in the prologue. The importance, therefore, of the prologue in Greek drama was very great; it sometimes almost took the place of a romance, to which, or to an episode in which, the play itself succeeded. It is believed that the prologue in this form was practically the invention of Euripides, and with him, as has been said, it takes the place of "an explanatory first act." This may help to modify the objection which criticism has often brought against the Greek prologue, as an impertinence, a useless growth prefixed to the play, and standing as a barrier between us and our enjoyment of it. The point precisely is that, to an Athenian audience, it was useful and pertinent, as supplying just what they needed to make the succeeding scenes intelligible. But it is difficult to accept the view that Euripides invented the plan of producing a god out of a machine to justify the action of deity upon man, because it is plain that he himself disliked this interference of the supernatural and did not believe in it. He seems, in such a typical prologue as that to the *Hippolytus*, to be accepting a conventional formula, and employing it, almost perversely, as a medium for his ironic rationalism. Many of the existing Greek prologues may be later in date than the plays they illustrate, or may contain large interpolations. On the Latin stage the prologue was often more elaborate than it was in Athens, and in the careful composition of the poems which Plautus prefixes to his plays we see what importance he gave to this portion of the entertainment; sometimes, as in the preface to the *Rudens*, Plautus rises to the height of his genius in his adroit and romantic prologues, usually placed in the mouths of persons who make no appearance in the play itself. Molière revived the Plautian prologue in the introduction to his *Amphitryon*. Racine introduced Piety as the speaker of a prologue which opened his choral tragedy of *Esther*. The tradition of the ancients vividly affected our own early dramatists. Not only were the mystery plays and miracles of the middle ages begun by a homily, but when the drama in its modern sense was inaugurated in the reign of Elizabeth, the prologue came with it, directly adapted from the practice of Euripides and Terence. Sackville, Lord Buckhurst, prepared a sort of prologue in dumb show for his *Gorbuduc* of 1562; and he also wrote a famous *Induction*, which is, practically, a prologue, to a miscellany of short romantic epics by diverse hands. In the Elizabethan drama the prologue was very far from being universally employed. In the plays of Shakespeare, for instance, it is an artifice which the poet very rarely introduced, although we find it in *Henry V.* and *Romeo and Juliet*. Sometimes the Elizabethan prologue was a highly elaborated poem; in 1603 a harbinger recited a sonnet on the stage, to prepare the audience for Heywood's *A Woman Kill'd with Kindness*. Often the prologue was a piece of blank verse, so obscure and complicated that it is difficult to know how its hearers contrived to follow it; such are the prologues of Chapman. Among Elizabethan prologues the most ingenious and interesting are those of Ben Jonson, who varied the form on every occasion. For instance, in *The Poetaster* (1602), Envy comes in "as Prologue," and speaks a long copy of heroics, only to be turned off the stage by an armed figure, who states that he is the real prologue, and proceeds to spout more verses. Jonson's introductions were often recited by the "stage-keeper," or manager. Beaumont and Fletcher seem to have almost wholly dispensed with prologues, and the form was far from being universal, until the Restoration, when it became *de rigueur*. The prologues of the last thirty years of the 17th century were always written in rhymed verse, and were generally spoken by a principal actor or actress in the ensuing piece. They were often, in the hands of competent poets, highly finished essays on social or literary topics. For instance, the famous prologue to Dryden's *Aurengzebe* (1675) is really a brief treatise on fashions in versification. Throughout the 18th century the prologue continued to flourish, but went out of vogue in the early part of the 19th.

See also EPILOGUE.

(E. G.)

PROME, a district in the Pegu division of Lower Burma, with an area of 2915 sq. m. and a population (1901) of 365,804.

It occupies the whole breadth of the valley of the Irrawaddy, between Thayetmyo district on the north and Henzada and Tharrawaddy districts on the south, and originally extended as far as the frontier of Independent Burma, but in 1870 Thayetmyo was formed into an independent jurisdiction. There are two mountain ranges in Promé, which form respectively the eastern and western boundaries. The Arakan Yomas extends along the whole of the western side, and that portion of the district lying on the right bank of the Irrawaddy is broken up by thickly wooded spurs running in a south-easterly direction, the space for cultivation being but limited and confined to the parts adjacent to the river. On the eastern side lies the Pegu Yomas, and north and north-east of the district its forest-covered spurs form numerous valleys and ravines, the torrents from which unite in one large stream called the Na-weng River. The most important of the plains lie in the south and south-west portions of Promé, and extend along the whole length of the railway that runs between the towns of Paungdē and Promé; they are mostly under cultivation, and those in the south are watered by a series of streams forming the Myit-ma-kha or upper portion of the Hlaing. There are in addition large tracts of land covered by tree-jungle which are available for cultivation. The principal river is the Irrawaddy, which intersects the district from north to south; next in importance are the Tha-ni and its tributaries and the Na-weng system of rivers. In the hills near the capital the soil is of Tertiary formation, and in the plains it is an alluvial deposit. The climate is much drier than other districts in Lower Burma, the annual rainfall being about 48 in. The temperature ranges from about 100° in June to 60° in January. The staple crop is rice, but some cotton and tobacco are grown, while the custard apples are famous. Sericulture is extensively carried on by a special class. The forests yield teak and cutch, cotton and silk-weaving are important industries; there are also manufactures of ornamental boxes, coarse brown sugar and cutch.

The early history of the once flourishing kingdom of Promé, like that of the other states which now form portions of Burma, is veiled in obscurity. After the conquest of Pegu in 1758 by Alompra, the founder of the last dynasty of Ava kings, Promé remained a portion of the Burman kingdom till the close of the second Burmese War in 1853, when the province of Pegu was annexed to British territory.

PROME, the chief town of the district, is situated on the left bank of the Irrawaddy, 161 m. N. of Rangoon, population (1901), 27,375.

To the south and south-east the town is closed in by low pagoda-topped hills, on one of which stands the conspicuous gilded Shwe Tsan-daw. The town was taken by the British in 1825 and again in 1852, on both occasions with hardly any opposition. In 1862 it was almost entirely destroyed by fire, and was afterwards relaid out in straight and broad streets. It was erected into a municipality in 1874, and since then great improvements have been made, including waterworks. Its principal manufactures are silk cloths and lacquer ware. It is the terminus of a railway from Rangoon, which runs through the district. The other chief towns in the district are Shwedaung (pop. 10,787) and Paungde (pop. 11,105).

PROMENADE, a walk taken for exercise or more especially for social amusement, hence a road, drive or other public place laid out for the purpose, a parade. The French word *promenade* was formerly *pourmenade*, and came from *pourmener*, *promener*, to take for a walk, Late Latin *prominare*, to drive an animal out to pasture, from *pro*, forward, *minare*, to drive on with cries and threats (*minae*). "Promenade concerts," so called from the fact that the audience are free to walk about or "promenade," were first introduced from Paris to London in 1838 under the name of "promenade concerts à la Musard," after the concerts given by the French musician and conductor, Philippe Musard (1793-1859). They were given at the Lyceum Theatre (English Opera House).

PROMETHEUS, son of the Titan Iapetus by the sea nymph Clymene, the chief "culture hero," and, in some accounts, the

Demiurge of Greek mythical legend. As a culture-hero or inventor and teacher of the arts of life, he belongs to a wide and well-known category of imaginary beings. Thus Qat, Quah-teaht, Pundjel, Maui, Ioskeha, Cagn, Wainamoinen and an endless array of others represent the ideal and heroic first teachers of Melanesians, Ahts, Australians, Maoris, Algonkins, Bushmen and Finns. Among the lowest races the culture-hero commonly wears a bestial guise, is a spider (Melanesia), an eagle hawk (in some myths and south-east Australia), a coyote (north-west America), a dog or raven (Thlinket), a mantis insect (Bushman), and so forth, yet is endowed with human or even super-human qualities, and often shades off into a permanent and practically deathless god. Prometheus, on the other hand, is purely anthropomorphic. He is the friend and benefactor of mankind. He defends them against Zeus, who, in accordance with a widely diffused mythical theory, desires to destroy the human race and supplant them by a new and better species, or who simply revenges a trick in which men get the better of him. The pedigree and early exploits of Prometheus are given by Hesiod (*Theog.* 510-616). On a certain occasion gods and men met at Mecone. The business of the assembly was to decide what portions of slain animals the gods should receive in sacrifice. On one side Prometheus arranged the best parts of the ox covered with offal, on the other the bones covered with fat, as the meat was covered in Homeric sacrifices. Zeus was invited to make his choice, chose the fat, and found only bones beneath. A similar fable of an original choice, in which the chooser is beguiled by appearances, recurs in Africa and North America (see the caskets in the *Merchant of Venice*). The native tribes adapt the myth to explain the different modes of life among themselves and white men. In wrath at this trick, according to Hesiod, or in other versions for the purpose of exterminating the remnants of people who escaped the deluge of Deucalion, Zeus never bestowed, or later withdrew, the gift of fire. In his "philanthropic fashion," Prometheus stole fire, concealed in a hollow fennel stalk (Hesiod, *Op. et Di.*), and a fennel stalk is still used in the Greek islands as a means of carrying a light (cf. Pliny xiii. 22). According to some legends he gained the fire by holding a rod close to the sun. Probably the hollow fennel stalk in which fire was carried got its place in myth from the very fact of its common use.

We thus find Prometheus in the position of the fire-bringer, or fire-stealer, and so connected with a very wide cycle of similar mythical benefactors. Among the Murri of Gippsland, to begin with a backward people, the fire-stealer was a man, but he became a bird. *Tow-e-ra*, or fire, was in the possession of two women who hated the blacks. A man who loved men cajoled the women, stole fire when their backs were turned, and was metamorphosed into "a little bird with a red mark on its tail, which is the mark of fire." The fire-bringer in Brittany is the golden or fire-crested wren. Myths like this kill two birds with one stone, and at once account for the possession of fire by men and for the marking of certain animals regarded as fire-bringers.¹ In another Australian legend fire was stolen by the hawk from the bandicoot, and given to men. In yet another a man held his spear to the sun, and so got a light. A bird is fire-bringer in an Andaman island tale, and a ghost in another myth of the same island.² In New Zealand, Maui stole fire from Mauika, the lord of fire. He used a bird's intervention. Among the Ahts, in North America,³ fire was stolen by animals from the cuttle-fish. Among the Thlinkets, Yehl, the raven god, was the fire-stealer. Among the Cahrocs, the coyote steals fire from "two old women." Among the Aryans of India, Soma is stolen by birds, as water is among the Thlinkets, and mead in the Edda.⁴ Fire concealed himself, in the Veda, was dragged from his hiding place by Mataricvan, and was given to the priestly clan of Bhrigu. We also hear that Mataricvan "brought fire from afar" (*R. V.* iii. 9, 5), and that Bhrigu found fire lurking in the water (*R. V.* x. 46, 2).⁵

In considering the whole question, one must beware of the

¹ For these see Brough Smith with Howitt, *Native Tribes of South-east Australia, Aborigines of Victoria*; Kuhn, on bird fire-bringer in Isle of Man, *Die Herabkunft des Feuers*, p. 109; Van Gennep, *Mythes et légendes d'Australie*.

² *Journ. Anthropol. Inst.* (Nov. 1884).

³ Sproat, *Savage Life*.

⁴ Bancroft, iii. 100; *Aitareya brahmana*, ii. 93, 203; Kuhn, *op. cit.*, 144.

⁵ Cf. Bergaigne, *La Religion védique*, i. 52-56, and Kuhn's *Herabkunft*; and see the essays by Steinthal in appendix to English version of Goldziher's *Mythology among the Hebrews*.

hasty analogical method of reasoning too common among mythologists. For example, when a bird is spoken of as the fire-bringer we need not necessarily conclude that, in each case, the bird means lightning. On the other hand, the myth often exists to explain the cause of the markings of certain actual species of birds. Again, because a hero is said to have stolen or brought fire, we need not regard that hero as the personification of fire, and explain all his myth as a fire-myth. The legend of Prometheus has too often been treated in this fashion, though he is really a culture hero, of whose exploits, such as making men of clay, fire-stealing is no more than a single example. This tendency to evolve the whole myth of Prometheus from a belief that he is personified fire, or the fire-god, has been intensified by Kuhn's ingenious and plausible etymology of the name *Προμηθεΐς*. The Greeks derived it from *προμηθής*, provident, and connected it with other such words as *προμηθούμαι*, *προμηθεΐα*. They had also the proper name *Ἐπιμηθεΐς* for the slow-witted brother of Prometheus who turned all the hero's wisdom to foolishness. Against these very natural etymologies the philologists support a theory that Prometheus is really a Greek form of *pramantha* (Skt.), the fire-stick of the Hindus. The process of etymological change, as given by Steinthal, was this. The boring of the Perpendicular in the horizontal fire-stick, whereby fire was kindled, was called *manthana*, from *math*, "I shake." The preposition *pra* was prefixed, and you get *pramantha*. But Mataricvan was feigned to have brought Agni, fire, and "the fetching of the god was designated by the same verb *mathnāmi* as the proper earthly boring" of the fire-stick. "Now this verb, especially when compounded with the preposition *pra*, gained the signification to tear off, snatch to oneself, rob." Steinthal goes on: "Thus the fetching of Agni became a robbery of the fire, and the *pramātha* (fire-stick) a robber. The gods had intended, for some reason or other, to withhold fire from men; a benefactor of mankind stole it from the gods. This robbery was called *pramātha*; *pramāthyu-s* is 'he who loves boring or robbery, a borer or robber.' From the latter words, according to the peculiarities of Greek phonology, is formed *Προμηθεΐς*, Prometheus. He is therefore a fire-god," &c. Few things more ingenious than this have ever been done by philologists. It will be observed that "forgetfulness of the meaning of words" is made to account for the Greek belief that fire was *stolen* from the gods. To recapitulate the doctrine more succinctly, men originally said, in Sanskrit (or some Aryan speech more ancient still), "fire is got by rubbing or boring;" nothing could have been more scientific and straightforward. They also said, "fire is brought by Mataricvan;" nothing could have been more in accordance with the mythopoeic mode of thought. Then the word which means "fetched" is confused with the word which means "bored," and gains the sense of "robbed." Lastly, fire is said (owing to this confusion) to have been stolen, and the term which meant the common savage fire-stick is by a process of delusion conceived to represent, not a stick, but a person, Prometheus, who stole fire. Thus then, according to the philologists, arose the myth that fire was stolen, a myth which, we presume, would not otherwise have occurred to Greeks. Now we have not to decide whether the Greeks were right in thinking that Prometheus only meant "the fore-sighted wise man," or whether the Germans know better, and are correct when they say the name merely meant "fire-stick." But we may, at least, point out that the myth of the stealing of fire and of the fire-stealer is current among races who are not Aryan, and never heard the word *pramantha*. We have shown that Thlinkets, Ahts, Andaman Islanders, Australians, Maoris, South Sea Islanders, Cahrocs and others all believe fire was originally stolen. Is it credible that, in all their languages, the name of the fire-stick should have caused a confusion of thought which ultimately led to the belief that fire was obtained originally by larceny? If such a coincidence appears incredible, we may doubt whether the belief that is common to Greeks and Cahrocs and Ahts was produced, in Greek minds by an etymological confusion, in Australia, America and so forth by some

⁶ Cf. Kuhn, *op. cit.* pp. 16, 17.

other cause. What, then, is the origin of the widely-diffused myth that fire was stolen? We offer a purely conjectural suggestion. No race is found without fire, but even some civilized races have found the artificial reproduction of fire very tedious. Thus we read (*Od.* v. 488-493), "As when a man hath hidden away a brand in the black embers at an upland farm, one that hath no neighbour nigh, and so saveth the seed of fire that he may not have to seek a light elsewhere, even so did Odysseus cover him with the leaves." If, in the Homeric age, men found it so hard to get the seed of fire, what must the difficulty have been in the earliest dawn of the art of fire-making? Suppose, then, that the human groups of early savages are hostile. One group lets its fire go out, the next thing to do would be to borrow a light from the neighbour, perhaps several miles off. But if the neighbours are hostile the unlucky group is cut off from fire, *igni interdicitur*. The only way to get fire in such a case is to steal it. Men accustomed to such a precarious condition might readily believe that the first possessors of fire, wherever they were, set a high value on it, and refused to communicate it to others. Hence the belief that fire was originally stolen. This hypothesis at least explains all myths of fire-stealing by the natural needs, passions, and characters of men, "a jealous race," whereas the philological theory explains the Greek myth by an exceptional accident of changing language, and leaves the other widely diffused myths of fire-stealing in the dark. It would occupy too much space to discuss, in the ethnological method, the rest of the legend of Prometheus. Like the Australian Pundjel, and the Maori Tiki, he made men of clay. He it was who, when Zeus had changed his wife into a fly, and swallowed her, broke open the god's head and let out his daughter Athena. He aided Zeus in the struggle with the Titans. He was punished by him on some desolate hill (usually styled Caucasus) for fire-stealing, and was finally released by Heracles.

His career may be studied in Hesiod; in the splendid *Prometheus vinculus* of Aeschylus, with the *scholia*; in Heyne's *Apollodorus*; in the excursus (1) of Schüzius to the Aeschylean drama, and in the frequently quoted work of Kuhn. The essay of Steintal may also be examined (Goldziher, *Myth. Hebr.*, Eng. trans., p. 363-392), where the amused student will discover that "Moses is a Pramanthas," with much else that is as learned and convincing. See also Tylor's *Early History of Man*; Nesfield in *Calcutta Review* (January, April, 1884); and the article FIRE. (A. L.)

PROMOTER, one who promotes (Lat. *promovere*, to move forward), advances or forwards any scheme, project or undertaking. The most general specific sense in which the word is now used is that of a person who takes the steps necessary to the incorporation of a joint-stock company (see COMPANY) or to the passing of a private or local act of parliament. In legal history, a promoter was one who prosecuted offenders, originally as an officer of the Crown, later as a common informer; the term is still used thus of the prosecutor in a suit in an ecclesiastical court.

PRONGBUCK, PRONGHORN, or (in America) simply ANTELOPE, the sole existing representative of a family (*Antilocapridae*) of hollow-horned ruminants in which the horn-sheaths are forked and annually shed and renewed. Standing about 3 ft. high at the shoulder and slightly more at the croup, the male prongbuck has the black horns rising vertically upwards immediately above the eyes. The general colour is bright sandy fawn, with much white on the face, three white bars on the throat and white under parts and buttocks. The white throat-bands are evidently protective; and the long white hair on the buttocks can be erected and expanded into large chrysanthemum-like bunches as in Japanese deer; these being guides to the members of the herd when in flight. The tail is short; lateral hoofs are wanting; and the teeth are tall-crowned. Female prongbuck produce one or two young at a birth, and are either hornless or furnished with small and more or less rudimentary horns.

Prongbuck, of which two races, the typical *Antilocapra americana* and *A. mexicana*, are recognized by American naturalists, inhabit the open plains of the temperate districts of western North America, where they were formerly very abundant. Nowadays their numbers have become greatly diminished

and small and isolated bands represent the great herds of former years. Young prongbuck are very liable to be attacked by wolves; to protect them from these marauders the females first clear an area in the middle of a patch of cactus, by jumping on the plants with their sharp hoofs, and bring forth their offspring in the protected space. Certain extinct American ruminants, namely *Cosoryx*, *Blastomeryx* and *Merycodus* are believed to be in some way related to the prongbuck; but they have frontal appendages more like antlers than horns. In view of this presumed relationship it seems preferable to retain the family *Antilocapridae* rather than relegate it to the rank of a sub-family of *Bovidae*. (See PECORA.) (R. L.)*

PRONUNCIATION (Lat. *pronuntiatio*, from *pronuntiare*, proclaim, announce, pronounce), the action of pronouncing, the manner of uttering an articulate vocal sound (see PHONETICS and VOICE). The original sense of the Latin, a public declaration, is preserved in Spanish *pronunciamento*, a manifesto or proclamation, especially as issued by a party of insurrection or revolution.

PRONY, GASPARD CLAIR FRANÇOIS MARIE RICHE DE (1755-1839), French engineer, was born at Chamelet, in the department of the Rhone, on the 22nd of July 1755, and was educated at the École des Ponts et Chaussées. His *Mémoire sur la poussée des voûtes* published in 1783, in defence of the principles of bridge construction introduced by his master J. R. Perronnet, attracted special attention. The laborious enterprise of drawing up the famous *Tables du Cadastre* was entrusted to his direction in 1792, and in 1794 he was appointed professor of the mathematical sciences at the École Polytechnique, becoming director at the École des Ponts et Chaussées four years later. He was employed by Napoleon to superintend the engineering operations for protecting the province of Ferrara against the inundations of the Po and for draining and improving the Pontine Marshes. After the Restoration he was likewise engaged in regulating the course of the Rhone, and in several other important works. He was made a baron in 1828, and a peer in 1835. He died at Asnières (Seine) on the 29th of July 1839. For the "Prony Brake" see DYNAMOMETER.

PROOF (in M. Eng. *provee*, *proeve*, *preve*, &c., from O. Fr. *prueve*, *proeve*, &c., mod. *preuve*, Late. Lat. *proba*, *probare*, to prove, to test the goodness of anything, *probus*, good), a word of which the two main branches are derived from those of "to prove," viz. to show to be true, to test, to try. Of the first division the chief meanings are: that which establishes the truth of a fact or the belief in the truth, demonstration, for the nature of which see LOGIC. In law "proof" is the general term for the establishment of the material facts in issue in a particular case by proper legal means to the satisfaction of the court (see EVIDENCE); specifically, documents so attested as to form legal evidence, written copies of what a witness is prepared to support on oath, and the evidence of any case in the court records are all termed "proofs." In Scots law the term is used of a trial before a judge alone as opposed to trial by jury. From the general sense of examination, trial or assay derived from "to prove," to test the quality of anything, "proof" is used of that which has succeeded in standing a trial or test; the commonest form in which this use appears is as a compound adjective, thus materials are said to be "waterproof," "armour-" "bullet-proof," and the like. The principal other uses are for a standard of strength for spirit (see ALCOHOL and SPIRITS) for a trial impression, in printing, on which corrections and additions can be made (see article PROOF-READING) and, in engraving and etching, for one of a limited number of impressions made before the ordinary issue is printed. In the earlier history of engraving a "proof" was an impression during the process of printing made for the artist's inspection, approval or correction, whence its name. In the modern use of the term, where the impression has been taken before the inscription has been added to the plate, it is called a "proof before letter."

In bookbinding, some of the shorter or narrower leaves are left with rough edges, "uncropped," to show that the book has not been "cut," these are styled "proofs."

PROOF-READING, the art or business of correcting for the press the printed "proofs" of articles or books set in type before publication. The special business of a proof-reader, attached to a printing house, is to correct these proofs before they are shown to the author; he is an intermediary between the compositor and the author, and as such his functions may vary according to his capacities. Proof-reading as a distinct department in the work of a printing office does not date from the very earliest days of "the art preservative of all arts." The first products of the printing-press show abundant evidences of the non-existence of any one specially charged with the duty of correcting the compositors' mistakes. How much conjectural emendation and consequent controversy would have been avoided if the First Folio Shakespeare had been more typographically correct! Sir Theodore Martin said that the typographical errors alone of that work had been computed to number nearly 20,000, which amounts to 2.25% of the total number of words in the volume. It was a usual practice in the 17th and 18th centuries for authors to send the proofs of their works round amongst their personal friends for correction; and in the universities and colleges sheets of works passing through the press were frequently hung up in the quadrangles for public inspection and correction. With the growth of printing gradually came a demand for systematic proof-reading, and the leading printers engaged scholars and men of letters to read proofs for them. Among these may be mentioned Cruden, of *Concordance* fame ("Alexander the Corrector"), and William Julius Mickle, poet, and translator of Luiz de Camoens's *Lusiads*, who was a reader at the Clarendon Press. Goldsmith and Dr Johnson also are credited with having wielded the proof-reader's pen. Times, however, have changed since, as the elder D'Israeli wrote, "it became the glory of the learned to be correctors of the press to eminent printers," and to-day in every printing office the proof-reader is found—an unobtrusive functionary, known to publishers, authors, editors and journalists, but for the most part unknown to the general reading public; a functionary who yet does useful, often valuable, and always indispensable work. The influence of good proof-reading upon the character of book, newspaper and general printing is too often underrated. The celebrated old printing offices and the foremost of the modern ones owe their reputation for good workmanship largely to the excellence and thoroughness of the work done in their reading-rooms, for no perfection of paper, ink, machining or binding can atone for bad or slipshod typography.

The nature of the proof-reader's work, frequently monotonous and uninteresting, will be made clear by what follows. After the compositor (see **TYPESETTING**) has set up, by hand or type-setting machine, the "copy" supplied to him, a slip or page proof is pulled and sent with the manuscript to the proof-reader. The manuscript is then read aloud by a copy-holder, while the proof-reader carefully follows the text before him letter by letter, marking on the margin of the proof all the misspellings, turned letters, "wrong fonts" (letters differing in size or style of face from those in the immediate context) and other errors, and seeing that the punctuation clearly defines the author's meaning. The copy-holder reads rapidly—indeed, an ordinary listener would imagine it to be impossible for the proof-reader to understand him—and as the reader is obliged to keep pace, he goes through the proof again, without the aid of the copy-holder, in order to mark any errors that may have escaped him in the first rapid reading. The proof, called the "first proof," is then sent to the compositor to be corrected. When this has been done, a further proof is submitted to the reader, who, upon satisfying himself by careful revision that it is free from typographical mistakes, passes it as "clean." If the reader, when dealing with the first proof, notices any slips in grammar or errors of fact on the part of the writer, or is in doubt whether any particular word in the manuscript has been correctly deciphered, he underlines the word or passage, and places "Qy." (query) in the margin. The proof is then despatched to the author or editor. On the return of the proof, after the writer's corrections and alterations have been carried

out, the type is made up into pages and sheets and another proof pulled. This passes into the hands of the press reader (as distinguished from the "first proof-reader"), who checks the headlines, page numbers, and sequence of chapters or sections, and observes that the pages are of uniform length and that a sufficient amount of margin is allowed, before finally reading through the text. When the press-reader's corrections have been effected, the work is ready for the printing machine or the stereotyping foundry.

The cost of proof-reading may be said to range from about 7½ to 20% of the cost of composition, varying, of course, with the nature of the work.

Many prominent authors have expressed in warm terms their gratitude to the proof-reader for valuable assistance rendered by apt queries and pertinent suggestions. Two of these expressions of opinion may be given as typical, one from a novelist and one from a poet. Charles Dickens said: "I know from some slight practical experience what the duties of correctors of the press are, and how these duties are usually discharged. And I can testify, and do testify here, that they are not mechanical—that they are not mere matters of manipulation and routine; but that they require from those who perform them much natural intelligence, much super-added cultivation, considerable readiness of reference, quickness of resource, an excellent memory and a clear understanding. And I must gratefully acknowledge that I have never gone through the sheets of any book I have written without having had presented to me by the corrector of the press something I had overlooked—some slight inconsistency into which I had fallen—some little lapse I had made—in short, without having set down in black and white some unquestionable indication that I had been closely followed in my work by a patient and trained mind, and not merely by a skilful eye. In this declaration I have not the slightest doubt that the great body of my brother and sister writers would, as a plain act of justice, heartily concur." Robert Browning thus corroborated Dickens: "I have had every opportunity of becoming acquainted with, and gratefully acknowledging, the extreme service rendered to me; and, if mine be no exceptional case, the qualifications of readers and correctors are important indeed." P. Larousse spoke of French proof-readers as his "collaborateurs les plus chers," and Hugo referred to them as those "modestes savants" so well able "lustrer les plumes du génie"; while the Académie Française consulted them on points arising in the revision of the Academy's dictionary.

Though much good work is done by readers who have not been practical printers, yet the technical knowledge gained by working as a compositor is essential to the best proof-reading. The reader must possess a quick eye, alert to note every error or mechanical imperfection in the type, and must scrutinize closely every letter of every word, clause and sentence, while keeping a grasp of the sense of the matter he is dealing with. The more varied his information and the wider his knowledge, the better. Though his strict duty is merely to see that the author's copy is properly reproduced, he is always glad to give the author the benefit of the experience and knowledge he has acquired, and, as a consequence, he is constantly crossing the line which separates proof-reading from sub-editorial duties. From this last consideration has arisen the plea for the reader, on the daily press especially, being placed under the control of, and made responsible to, the editorial department rather than the head of the composing-room.

Proof-readers in Great Britain have a trade union, and many of them retain membership of the unions to which they belonged when working as compositors; and in some states of the American Union as well as in Scotland the compositors insist upon readers being also members of their society. The oldest English organization devoted entirely to the interests of proof-readers is the Association of Correctors of the Press, founded in 1854. The chief aim of the association is to give its members information as to vacant situations, so as to keep them in full employment; but it also assists members in distress from its benevolent fund, and provides pensions, as well as a sum of money at death. There is in France the *Société des correcteurs des imprimeries de Paris*. There are also proof-readers' societies in several American cities, many of whose members are women, for in the United States women bulk largely in the rank of proof-readers. There are very few women proof-readers in London. In Edinburgh, however, women form a considerable proportion of the proof-readers. (J. A. BL.; J. R.)*

PROPAGATION, the multiplication of a species by natural processes of reproduction (*q.v.*). The Latin *propagare* meant to fasten down (*pro-* and *pangere*, to fasten) layers, shoots or

slips (*propagines*) of plants for the purpose of reproduction, hence to generate, reproduce and generally to extend or increase. It is in this sense that "propagation" is used of the spreading or dissemination of doctrines, ideas, opinions, &c. The term "propaganda," often wrongly used as a plural word, means properly an organization or association for the spreading of particular beliefs or opinions, and is an adaptation of the name of that committee of cardinals in the Roman curia which supervises foreign missions, the full title being *Congregatio de propaganda fide*.

PROPELLANTS, a generic name for explosives used for propelling projectiles from guns and other firearms, in order to distinguish them from the more violent explosives used in shells, mines, &c., to produce a blasting effect. Some explosive substances can be used both as propellants and as bursters, as for example gunpowder, and some of the ingredients of a propellant may be similar, though differently proportioned and combined, to those of a "high explosive." (For details see **EXPLOSIVES; GUNPOWDER; CORDITE, &c.**)

PROPERTIUS, SEXTUS (*fl.* 30–15 B.C.), the greatest of the elegiac poets of Rome, was born of a well-to-do Umbrian family at or near Asisium (Assisi), the birthplace also of the famous St Francis. We learn from Ovid that Propertius was his senior, but also his friend and companion; and that he was third in the sequence of elegiac poets, following Gallus, who was born in 69 B.C., and Tibullus, and immediately preceding Ovid himself, who was born in 43 B.C. We shall not then be far wrong in supposing that he was born about 50 B.C. His early life was full of misfortune. He lost his father prematurely; and after the battle of Philippi and the return of Octavian to Rome, Propertius, like Virgil and Horace, was deprived of his estate to provide land for the veterans, but, unlike them, he had no patrons at court, and he was reduced from opulence to comparative indigence. The widespread discontent which the confiscations caused provoked the insurrection generally known as the *bellum perusinum* from its only important incident, the fierce and fatal resistance of Perugia, which deprived the poet of another of his relations, who was killed by brigands while making his escape from the lines of Octavian. The loss of his patrimony, however, thanks no doubt to his mother's providence, did not prevent Propertius from receiving a superior education. After, or it may be, during its completion he and she left Umbria for Rome; and there, about the year 34 B.C., he assumed the garb of manly freedom. He was urged to take up a pleader's profession; but, like Ovid, he found in letters and gallantry a more congenial pursuit. Soon afterwards he made the acquaintance of Lycinna, about whom we know little beyond the fact that she subsequently excited the jealousy of Cynthia, and was subjected to all her powers of persecution (*vexandi*). This passing fancy was succeeded by a serious attachment, the object of which was the famous "Cynthia." Her real name was Hostia, and she was a native of Tibur. She was a courtesan of the superior class, somewhat older than Propertius, but, as it seems, a woman of singular beauty and varied accomplishments. Her own predilections led her to literature; and in her society Propertius found the intellectual sympathy and encouragement which were essential for the development of his powers. Her character, as depicted in the poems, is not an attractive one; but she seems to have entertained a genuine affection for her lover. The intimacy began in 28 and lasted till 23 B.C. These six years must not, however, be supposed to have been a period of unbroken felicity. Apart from minor disagreements an infidelity on Propertius's part excited the deepest resentment in Cynthia; and he was banished for a year. The quarrel was made up about the beginning of 25 B.C.; and soon after Propertius published his first book of poems and inscribed it with the name of his mistress. Its publication placed him in the first rank of contemporary poets, and amongst other things procured him admission to the literary circle of Maecenas. The intimacy was renewed; but the old enchantment was lost. Neither Cynthia nor Propertius was faithful to the other. The mutual ardour gradually cooled; motives of prudence and decorum urged the

discontinuance of the connexion; and disillusion changed insensibly to disgust. Although this separation might have been expected to be final, it is not certain that it was so. It is true that Cynthia, whose health appears to have been weak, does not seem to have survived the separation long. But a careful study of the seventh poem of the last book, in which Propertius gives an account of a dream of her which he had after her death, leads us to the belief that they were once more reconciled, and that in her last illness Cynthia left to her former lover the duty of carrying out her wishes with regard to the disposal of her effects and the arrangements of her funeral. Almost nothing is known of the subsequent history of the poet. He was alive in 16 B.C., as some allusions in the last book testify. And two passages in the letters of the younger Pliny mention a descendant of the poet, one Passennus Paullus. Now in 18 B.C. Augustus carried the *Leges Juliae*, which offered inducements to marriage and imposed disabilities upon the celibate. Propertius then may have been one of the first to comply with the new enactments. He would thus have married and had at least one child, from whom the contemporary of Pliny was descended.

Propertius had a large number of friends and acquaintances, chiefly literary, belonging to the circle of Maecenas. Amongst these may be mentioned Virgil, the epic poet Ponticus, Bassus (probably the iambic poet of the name), and at a later period Ovid. We hear nothing of Tibullus, nor of Horace, who also never mentions Propertius. This reciprocal silence is probably significant. In person Propertius was pale and thin, as was to be expected in one of a delicate and even sickly constitution. He was very careful about his personal appearance, and paid an almost foppish attention to dress and gait. He was of a somewhat voluptuous and self-indulgent temperament, which shrank from danger and active exertion. He was anxiously sensitive about the opinion of others, eager for their sympathy and regard, and, in general, impressionable to their influence. His over-emotional nature passed rapidly from one phase of feeling to another; but the more melancholy moods predominated. A vein of sadness runs through his poems, sometimes breaking out into querulous exclamation, but more frequently venting itself in gloomy reflections and prognostications. He had fits of superstition which in healthier moments he despised.

The poems of Propertius, as they have come down to us, consist of four books containing 4046 lines of elegiac verse. The first book, or *Cynthia*, was published separately and early in the poet's literary life. It may be assigned to 25 B.C. The dates of the publication of the rest are uncertain, but none of them was published before 24 B.C., and the last not before 16 B.C. The unusual length of the second one (1402 lines) has led Lachmann and other critics to suppose that it originally consisted of two books, and they have placed the beginning of the third book at ii. 10, a poem addressed to Augustus, thus making five books, and this arrangement has been accepted by several editors.

The subjects of the poems are threefold: (1) amatory and personal, mostly regarding Cynthia—seventy-two (sixty Cynthia elegies), of which the last book contains three; (2) political and social, on events of the day—thirteen, including three in the last book; (3) historical and antiquarian—six, of which five are in the last book.

The writings of Propertius are noted for their difficulty and their disorder. The workmanship is unequal, curtness alternating with redundance, and carelessness with elaboration. A desultory sequence of ideas, an excessive vagueness and indirectness of expression, a peculiar and abnormal latinity, a constant tendency to exaggeration, and an immoderate indulgence in learned and literary allusions—all these are obstacles lying in the way of a study of Propertius. But those who have the will and the patience to surmount them will find their trouble well repaid. For power and range of imagination, for freshness and vividness of conception, for truth and originality of presentation, few Roman poets can compare with him when he is at his best. And this is when he is carried out of himself, when the discordant qualities of his genius are, so to say, fused together

by the electric spark of an immediate inspiration. His vanity and egotism are undeniable, but they are redeemed by his fancy and his humour.

Two of his merits seem to have impressed the ancients themselves. The first is most obvious in the scenes of quiet description and emotion in whose presentation he particularly excels. Softness of outline, warmth of colouring, a fine and almost voluptuous feeling for beauty of every kind, and a pleading and melancholy tenderness—such were the elements of the spell which he threw round the sympathies of his reader, and which his compatriots expressed by the vague but expressive word *blanditia*. His poetic *facundia*, or command of striking and appropriate language, is more noticeable still. Not only is his vocabulary very extensive, but his employment of it extraordinarily bold and unconventional. New settings of use, idiom and construction continually surprise us, and, in spite of occasional harshness, secure for his style an unusual freshness and freedom. His handling of the elegiac couplet, and especially of its second line, deserves especial recognition. It is vigorous, varied and even picturesque. In the matter of the rhythms, caesuras and elisions which it allows, the metrical treatment is much more severe than that of Catullus, whose elegiacs are comparatively rude and barbarous; but it is not bound hand and foot, like the Ovidian distich, in a formal and conventional system. An elaborate symmetry is observable in the construction of many of his elegies, and this has tempted critics to divide a number of them into strophes.

Propertius's poems bear evident marks of the study of his predecessors, both Greek and Latin, and of the influence of his contemporaries. He tells us himself that Callimachus and Philetas were his masters (iii. 1, seq.), and that it was his ambition to be the Roman Callimachus (iv. 1, 64). But, as Teuffel has said, his debt to these writers is chiefly a formal one. Even into his mythological learning he breathes a life to which these dry scholars are strangers. We can trace obligations to Meleager, Theocritus, Apollonius Rhodius and other Alexandrines, and amongst earlier writers to Homer, Pindar, Aeschylus and others. Propertius's influence upon his successors was considerable. There is hardly a page of Ovid which does not show obligations to his poems, while other writers made a more sparing use of his stories.

A just appreciation of the genius and the writings of Propertius is made sensibly more difficult by the condition in which his works have come down to us. Some poems have been lost; others are fragmentary; and many are more or less disfigured by corruption and disarrangement. The manuscripts on which we have to rely are both late and deeply interpolated. Thus the restoration and interpretation of the poems is one of peculiar delicacy and difficulty.

On the Propertii see Mommsen in *Hermes*, iv. 370; Haupt, *Opusc.* i. 282. Inscriptions of Propertii have been found at Assisi. Propertius's family was not "noble," ii. 34, 55, 6, and ii. 24, 37 seq. Apart from the question of reading in iv. 1, 125 (MSS. *Asis.*), "the climbing walls of his town" (*scandentes arces, scandens murus*, iv. 1, 65 and *loc. cit.*), its nearness to Perugia, and its position close above the plain (i. 22, 9, 10) are decisive for Assisium as the birthplace of Propertius. Ovid thus assigns Propertius his place: successor fuit hic (Tibullus), tibi, Galle: *Propertius illi* (Tibullo): Quartus ab his serie temporis ipse fui (*Tr.* iv. 10, 53, 54) (cf. *ib.*, ii. 467). For Ovid's friendship with Propertius see below—iv. 1, 121 seq. is the chief authority for the earlier events of his life, 127 seq.: "Ossaque legisti non illa aetate legenda Patris et in tenuis cogeris ipse Lares. Nam tibi cum multi versarent rura iuveni Abstulit excultas peritica tristes opes." Elsewhere he says that he is "non ita dives" ii. 24, *loc. cit.* and that he had "nulla domi fortuna relicta," ii. 34, *loc. cit.* His living on the Esquiline, iii. 23, 24, points to a competence. For the death of his kinsman, generally supposed to be the Gallus of i. 21, see i. 22, 5-8. Propertius's mother is mentioned more than once, in very affectionate terms in i. 1, ii. 21. She was dead when iii. 13 (11) was written, *i.e.* six months after the publication of the first book. For the quality of Propertius's education, the poems themselves are the only, but a sufficient, testimony. For Lycinna see iii. 15, 3-10, 43. Cynthia (Hostia) was a native of Tibur (iv. 7, 85), and probably a grand-daughter (iii. 20, 8) of L. Hostius, who wrote a poem on the Illyrian War of 178 B.C., of which some fragments are preserved. She was older than Propertius (ii. 18, 20). That she was a *meretrix* is clear from many indications—her special accomplishments, her

house in the Subura, the occurrence of scenes like those in i. 3, ii. 29, the fact that Propertius could not marry her, &c. For references to her beauty see ii. 2, 5 sqq. and 3, 9 sqq.; ii. 13, 23, 24; to her poetry, ii. 3, 21; to other accomplishments, i. 2, 27 seq.; iii. 20, 7 seq. She was fickle (i. 15, ii. 6, &c.), avaricious (ii. 16, 11, 12), fond of finery (ii. 3, 15, 16), violent of temper (iii. 8; i. 4, 18 seq.). For the five years see iii. 25, 3, "quinque tibi potui servire fideliter annos"; and for the year of estrangement, iii. 16, 9, "peccaram semel, et totum sum pulsus in annum." The second separation is vouched for by the two last elegies of book iii. For the evidence which iv. 7 furnishes in favour of a reconciliation see Postgate (*Prop.* Introd. p. xxv. seq.); iv. 6 commemorates the celebration of the *ludi quinquennales*, in 16 B.C., and iv. 11, 66 alludes to the consulship of P. Scipio in the same year. For Passennus Paullus (or as an Assisi inscription calls him C. Passennus Sergius Paullus Propertius Blaesus), see Pliny (*Ep. vi.* 15), "municeps Properti atque etiam inter maiores Propertium numerat"; (9, 22), "in litteris veteres aemulatur exprimit reddit: Propertium in primis a quo genus ducit, vera suboles eoque simillima illi in quo ille praecipuus, si elegos eius in manum sumperis, leges opus tersum molle iucundum et plane in Properti domo scriptum." ii. 1 and iii. 9 are addressed to Maecenas, ii. 10 to Augustus. Virgil is spoken of in the highest terms in ii. 34, 61 seq. Other poems are addressed to Ponticus (i. 7, 9), Bassus (i. 4), Lynceus, a tragic poet (i. 19, ii. 34). In *Ep.* ii. 2, 87 seq., Horace has been thought to make a direct attack on Propertius. On Propertius's personal appearance, see i. 1, 22, 5, 21. A likeness of him has possibly been preserved in a double *Hermes* in the Villa Albani and the Vatican, which represents a young beardless Roman, of a nervous and somewhat sickly appearance, together with a Greek poet (Visconti, *Iconograph. romana*, pl. 14, 3, 4). Ill health is proved by i. 15 and the frequent references to death and burial—i. 19, ii. 1, 71 sqq., ii. 13, 17 sqq. For his care about dress and the like see ii. 4, 5, seq. For want of courage and energy see ii. 7, 14, ii. 19, 17-24; and for superstitious leanings, ii. 27, ii. 4, 15, iv. 5, 9 seq. The four-book numbering is now the current one and is adopted in this article though there is little doubt that there were originally four books besides the *Cynthia*. Few of the poems can be dated with certainty, but those that can, with the exception of iv. 6 and 11, fall between the years 28 and 23 B.C. For ancient references to Propertius as a writer see Quint. x. 1, 93 (where it is stated that some (not Quintilian) preferred him to Tibullus), Ov. *A. A.* iii. 333; *Tr.* iii. 465, v. 1, 17; Mart. xiv. 189, viii. 73; Pliny, *loc. cit.* above, Stat. *Silv.* i. 2, 253.

There is no existing MS. of Propertius older than the 12th century. Up till the publication of Bährens's edition (1880), the oldest one, Neapolitanus (N., now at Wolfenbüttel), was universally regarded as the best, and even now critics are found to maintain its paramount claims. But the more judicious admit the value of the four MSS. collated by Bährens. Vossianus, c. 1300 (A); Laurentianus, end of 14th century (F); Ottobonian-Vaticanus, 15th century (V); Daventriensis, 15th century (D), to which has to be added the Holkhamicus, 1421 (L), collated by Postgate, *Cambridge Philological Transactions* (1894) vol. iv.

The *editio princeps* of Propertius is that of 1472 (Venice). Among later editions we may mention the following, those with explanatory or critical notes being marked with an asterisk: Scaliger (1577, &c.), *Broukhusius (2nd ed., 1577), *Passeratius (1608, with *index verborum*), *Vulpius (1755, with *index verborum*), *P. Burmann (and Santen) (1780), *Lachmann (1816), *Hertzberg (1843-1845), L. Müller (1870), Haupt-Vahlen (last ed., 1904), *Bährens (1880), *A. Palmer (1880), *Postgate (1881), selections with introduction (text with critical notes in the *Corpus poetarum latinorum*, 1894, also issued separately), *Rothstein (1898), *H. E. Butler (1905), *index verborum* (to his own text), J. S. Phillimore (1906), A. E. Housman (without publishing an edition) has done much to improve and explain the poems. For further information we may refer to F. Plessis, *Études critiques sur Propertius et ses élégies* (1886), and the sections on the poet in Teuffel's and Schanz's *Histories of Roman Literature*.

The following translations into English verse are known: G. F. Nott (1782), bk. i.; C. A. Alton, selections in his *Specimens of the Classic Poets* (1814), ii. 215 seq.; C. R. Moore (1870); J. Cranstoun (1875); F. A. Paley (1866), verse translations from bk. v. with notes; also a few translations by the poet Gray, vol. i. (Gosse, 1884); S. G. Tremenheere (1899), bk. i. Prose translations: P. J. F. Gantillon (with Nott's and Elton's versions, Bohn, 1848); J. S. Phillimore (1906). (J. P. P.)

PROPERTY, that which is peculiarly one's own, that which belongs to or is characteristic of an individual. The Latin *proprietas* (formed from *proprius*, one's own, possibly derived from *prope*, near) in post-Augustan times was extended to ownership and rights of possession. It is thus, in law, the generic term for rights of ownership and for things subject to the rights of ownership. It is "the most comprehensive of all terms which can be used, inasmuch as it is indicative and descriptive of every possible interest which the party can have" (see Langdale, M. R., in *Jones v. Skinner*, 1835, 5 L.J. Ch. 90).

In Roman law and in modern systems of law based on it, property is divided into "movables" and "immovables"; in English law, on the other hand, the division is into personal property, including chattels real, and real property (see PERSONAL PROPERTY and REAL PROPERTY). Theatrical usage has given a specific meaning to the word, that of any article used on the stage during the performance of a play.

PROPHET (προφήτης), a word taken from the vocabulary of ancient Greek religion,¹ which passed into the language of Christianity, and so into the modern tongues of Europe, because it was adopted by the Hellenistic Jews as the rendering of the Hebrew נָבִי (nābhī^a pl., *nebhūm*). The word therefore as we use it is meant to convey an idea which belongs to Hebrew and not to Hellenic belief.

That the word nābhī^a, "prophet," originally signified one who speaks or announces the divine will, is rendered highly probable by a comparison of the Assyrian nabū, meaning (a) to "call" or "name," (b) "announce" (see Delitzsch, *Handwörterbuch sub voce*). The Babylonian deity Nabū (in Old Testament Nebo) is a contraction from Na-bi-u, which thus corresponds closely with the Hebrew nābhī^a and originally signified the speaker or proclaimer of destiny. He was represented as the writer of the tablets of destiny, and was therefore regarded as the interpreter of oracles (see Zimmern, *K. A. T.*³ pp. 400, 404). Accordingly this derivation is preferable to that suggested by earlier Semitists from Gesenius to (in recent times) Kautzsch ("Religion of Israel," Hastings's *Dict. Bible*, extra vol., p. 652 footnote), and Cheyne (*Ency. Bibl.* col. 3853), which connects it with another verbal root naba, "bubble" or "gush." This Davidson ("Prophecy and Prophets," Hastings's *Dict. Bible*, p. 108 footnote) rightly rejects. While he connects it with the Arabic root naba'a, "come into prominence" (conj. II. "announce,") he ends by ascribing to it an ultimate Babylonian origin. Zimmern (*K.A.T.*³ p. 590) gives the name of a priest-official munambū (lit. "howler"), which is derived from a Piel of nabū, viz. nubbū (= numbū), "bawl" or "howl." A brief sketch will be given (1) of the history of Hebrew prophecy (in supplement to what has been already said in the article HEBREW RELIGION or is to be found in the articles devoted to individual prophets), and (2) of prophecy in the early Christian Church.

1. *The Prophets of the Old Testament.*—The author of 1 Sam. ix. 9 tells us that "beforetime in Israel, when a man went to inquire of God, thus he spake, Come and let us go to the seer; for he that is now called a prophet (nābhī^a) was beforetime called a seer." This remark is probably a later gloss. Samuel was a "seer" (ver. 11), or, as he is also called (ver. 6 seq.), a "man of God," that is one who stood in closer relations to God than ordinary men; "all that he said was sure to come to pass," so that he could be consulted with advantage even in private matters like the loss of the asses of Kish. The narrative of 1 Sam. ix. belongs, as Budde has demonstrated, to the older stratum of the narrative (called J) which

¹ According to Plato (*Timæus*, p. 72) the name προφήτης ought properly to be confined to the interpreters employed to put an intelligible sense on the dreams, visions, or enigmatic utterances of the frenzied μάντις. But in ordinary Greek usage the prophet of any god is in general any human instrument through whom the god declares himself; and the tendency was "to reserve the name for unconscious interpreters of the divine thought, and for the ministers of the oracles in general" (Bouché-Leclercq, *Hist. de la divination*, 1880, ii. 11). This probably facilitated the adoption of the term by the Hellenists of Alexandria, for, when Philo distinguishes the prophet from the spurious diviner by saying that the latter applies his own inferences to omens and the like while the true prophet, rapt in ecstasy, speaks nothing of his own, but simply repeats what is given to him by a revelation in which his reason has no part (ed. Mangey, ii. 321 seq., 343; cf. i. 510 seq.), he follows the prevalent notion of the later Jews, at least in so far as he makes the function of the prophet that of purely mechanical reproduction; cf. John xi. 51, and the whole view of revelation presupposed in the Apocalyptic literature. But in any case the Greek language hardly offered another word for an organ of revelation so colourless as προφήτης, while the condition of etymology among the ancients made it possible to interpret it as having a special reference to prediction (so Eusebius, *Dem. Ev.* v., deriving it from προφαίνω).

includes ix., x. 1-16, xi. 1-11, 15, xiii., xiv. 1-16 in which Samuel is a priest-seer of a provincial town, without the high functions of government as *Shōphēt*. We must not suppose that the word "prophet" had merely become more common in his time and supplanted an older synonym. This is clearly shown a few verses farther down, where we see that there were already in Samuel's time people known as *nebhūm*, but that they were not seers. The seer (*rōch*) appears individually, and his function was probably not so much one of speech as of the routine of close observation of the entrails of slaughtered victims, like the Assyrian *barū* (see *PRIEST*). It is in this way that the function of the seer is closely connected (as in the case of Balaam) with sacrifices. With the prophets it is quite otherwise; they appear not individually but in bands; their prophesying is a united exercise accompanied by music, and seemingly dance-music; it is marked by strong excitement, which sometimes acts contagiously, and may be so powerful that he who is seized by it is unable to stand,² and, though this condition is regarded as produced by a divine afflatus, it is matter of ironical comment when a prominent man like Saul is found to be thus affected. Samuel in his later days appears presiding over the exercises of a group of *nebhūm* at Ramah, where they seem to have had a sort of coenobium (Naioth), but he was not himself a nābhī^a—that name is never applied to him except in 1 Sam. iii. 21, where it is plainly used in the later sense for the idea which in Samuel's own time was expressed by "seer."

But again this special type of *nebhūm* seems to have been a new thing in Israel in the days of Samuel. Seers there had been of old as in other primitive nations; of the two Hebrew words literally corresponding to our *The Dervish*. seer, *rōch* and *hōzeh*, the second is found also in Arabic, and seems to belong to the primitive Semitic vocabulary.³ But the enthusiastic bands of prophets are nowhere mentioned before the time of Samuel; and in the whole previous history the word prophet occurs very rarely, never in the very oldest narratives, and always in that sense which we know to be later than the age of Samuel, so that the use of the term is due to writers of the age of the kings, who spoke of ancient things in the language of their own day. The appearance of the *nebhūm* in the time of Samuel was, it would seem, as is explained in the article HEBREW RELIGION, one manifestation of the deep pulse of suppressed indignant patriotism which began to beat in the hearts of the nation in the age of Philistine oppression, and this fact explains the influence of the movement on Saul and the interest taken in it by Samuel.

It was perhaps only in time of war, when Israel felt himself to be fighting the battles of Yahweh, that the Hebrew was stirred to the depths of his nature by emotions of a religious colour. Thus the deeper feelings of religion were embodied in warlike patriotism, and these feelings the Philistine oppression had raised to extreme tension among all who loved liberty, while yet the want of a captain to lead forth the armies of Yahweh against his foemen deprived them of their natural outlet.

In its external features the new phenomenon was exceedingly like what is still seen in the East in every *zīkr* of dervishes—the enthusiasm of the prophets expressed itself in no artificial form, but in a way natural to the Oriental temperament. Processions with pipe and hand-drum, such as that described in 1 Sam. x., were indeed a customary part of ordinary religious feasts; but there they were an outlet for natural merriment, here they have changed their character to express an emotion more sombre and more intense, by which the prophets, and often mere chance spectators too, were so overpowered that they

² 1 Sam. x. 5 seq., xix. 20 seq. In the latter passage read "they saw the fervour of the prophets as they prophesied, &c." (see Hoffmann in Stade's *Zeitschr.* 1883, p. 89), after the Syriac.

³ Hoffmann, *ut supra*, p. 92 seq. *Rōch*, however, occurs very rarely in early, i.e. pre-exilian, Hebrew, viz. in 1 Sam. ix. 9, Isa. xxx. 10. We have several in the late literature of Chronicles. Accordingly we lack the materials for determining the distinction which probably existed between the *rōch*, the *hōzeh* and the *kōsem*. Cheyne, art. "Prophetic Literature" in *Ency. Bibl.*, col. 3858, appears to identify them.

seemed to lose their old personality and to be swayed by a supernatural influence. More than this hardly lies in the expression "a divine spirit" (רוח אלהים), which is used not only of the prophetic afflatus but of the evil frenzy that afflicted Saul's later days. The Hebrews had a less narrow conception of the spiritual than we are apt to read into their records.

To give a name to this new phenomenon the Israelites, it would seem, had to borrow a word from their Canaanite neighbours. At all events the word *nābhīʾ* is neither part of the old Semitic vocabulary (in Arabic it is a late loan word) nor has it any etymology in Hebrew, the cognate words "to prophesy" and the like being derived from the noun in its technical sense. But we know that there were *nebhīim* among the Canaanites; the "prophets" of Baal appear in the history of Elijah as men who sought to attract their god by wild orgiastic rites. In fact the presence of an orgiastic character is as marked a feature in Canaanite religion as the absence of it is in the oldest religion of Israel; but the new Hebrew enthusiasts had at least an external resemblance to the devotees of the Canaanite sanctuaries and this would be enough to determine the choice of a name which in the first instance seems hardly to have been a name of honour. In admitting¹ that the name was borrowed, we are not by any means shut up to suppose that the Hebrew *nebhīim* simply copied their Canaanite neighbours. The phenomenon is perfectly intelligible without any such hypothesis. A wave of intense religious feeling passes over the land and finds its expression, according to the ordinary law of oriental life, in the formation of a sort of enthusiastic religious order. The Nazarites and the Rechabites are parallel phenomena, though of vastly inferior historical importance.

It may be assumed that the name *nābhīʾ*, while it originated from Babylonian sources, reached Israel through Canaanite channels (cf. Kautzsch, "Religion of Israel," in Hastings's *Dict. Bible* extra vol., p. 653). Some support is given to this view by (a) the statement in 1 Kings xviii. 19 that four hundred prophets of Baal and Asherah sat at Jezebel's table; (b) the fact that Deborah, Samuel, Elijah, Elisha, Micaiah ben Imlah, the most notable of the earlier representatives of prophecy, belong to northern Israel, which was more subject to Canaanite-Phoenician influence.

It is certainly probable that the *nābhīʾ* emerged by a process of continued development, of which the intermediate stages are lost, from the older *rōch*, as the explanatory gloss in 1 Sam. ix. 9 evidently intimates. Samuel himself is called a *rōch*. We may assume that like the practice of the soothsaying priest (the earlier type of priest) and of the *kōsēm* (diviner), so the procedure of the *rōch* was mechanical and magical in character. Clear indications of a primitive magical *modus operandi* appear as survivals in the narratives of the pre-exilian prophets. The wonder-working staff of Elisha (2 Kings iv. 29, 31) is one of these indications. There are likewise traces of survival in the examples of "sympathetic magic" transformed into the acted *parable of prophecy*. Students of Tallquist's *Maklū* series of incantation or of the *šurpu* series edited by Zimmern (in his *Beiträge zur Kenntniss der Babylonischen Religion*) will recollect the images over which the priest sorcerer recites his formulæ. The accompanying actions (tying knots, &c.) which he performs are assumed to work themselves out on the enemy whose evil eye or sorcery is blasting the happiness of the suppliant (see Hastings's *Dict. Bible*, "Magic," p. 209, where examples are cited). The signs or symbolic acts of the prophet probably originated in the actions of sympathetic magic. Thus in the vivid scene of 1 Kings xxii. 11 the iron horns of Zedekiah ben Kena'nah, and in 2 Kings xiii. 15-19 the magic of the arrow shot eastward and of the thrice stricken floor, are evident survivals of an older practice. The

¹ If this account of the origin of the *nebhīim* is correct (cf. Kuenen, *Prophets*, Eng. trans., p. 554 seq.), the etymological sense of the word נָבִי is comparatively unimportant. The root seems to mean "to start up," "to rise into prominence," and so "to become audible." This is based on the Arabic *naba'a*; see the remarks at the beginning of this article.

magical act passes into sign or symbol, not however without the accompanying conception that underlies it still persisting that a mysterious effectuating potency belongs to the symbolic act. The mystic power of a significant name *Mahēr shālāi hash baz* inscribed on a tablet and bestowed on a child (Isa. viii. 1-4, cf. xx. 2 sqq.), of the "thongs and bars" of Jer. xxvii. (in which contending prophets confront one another in a contest of symbols), of the linen girdle of ch. xiii. 1 sqq., and of the potter's vessel of xix. 1 sqq., are further illustrations of survivals from the old world of magic. The symbol gradually passes into mere metaphor, and we already begin to see this when we compare Ezekiel's oracles and those of the Deutero-Isaiah with the records of the words and deeds of earlier prophets.

The peculiar methods of the prophetic exercises described in 1 Sam. were of little consequence for the future development of prophecy. The heat of a first enthusiasm necessarily cooled when the political conditions that produced it passed away; and, if the prophetic associations had done no more than organize a new form of spiritual excitement, they would have only added one to the many mechanical types of hysterical religion which are found all over the East. Their real importance was that they embodied an intenser vein of feeling than was expressed in the ordinary feasts and sacrifices, and that the greater intensity was not artificial, but due to a revival of national sentiment. The worship of the local sanctuaries did nothing to promote the sense of the religious unity of Israel; Yahweh in the age of the Judges ran no small risk of being divided into a number of local Baals, givers of natural good things each to his own locality. The struggle for freedom called forth a deeper sense of the unity of the people of the one Yahweh, and in so doing raised religion to a loftier plane; for a faith which unites a nation is necessarily a higher moral force than one which only unites a township or a clan. The local worships, which subsisted unchanged during the greater part of the Hebrew kingship, gave no expression to this rise in the religious consciousness of the nation; on the contrary, we see from the prophetic books of the 8th century that they lagged more and more behind the progress of religious thought. But the prophetic societies were in their origin one symptom of that upheaval of national life of which the institution of the human sovereign reigning under the divine King was the chief fruit; they preserved the traditions of that great movement; they were, in however imperfect a way, an organ of national religious feeling, and could move forward with the movement of national life. And so, though we cannot follow the steps of the process, we are not surprised to learn that they soon had an established footing in Israel, and that the prophets came to be recognized as a standing sacred element in society. What was their precise place in Hebrew life we hardly know but they formed at least a religious class which in all its traditions represented the new national and not the old communal and particularistic life. One characteristic point which appears very early is that they felt themselves called upon to vindicate the laws of divine righteousness in national matters, and especially in the conduct of the kings, who were not answerable to human authority. The cases of Nathan and David in the matter of Uriah, of Elijah and Ahab after the judicial murder of Naboth, will occur to everyone, and from the Hebrew standpoint the action of Gad in the matter of the census taken by David belongs to the same category. Such interventions with an Eastern king demanded great moral courage, for, though to some extent protected by their sacred character, the persons of the prophets were by no means legally inviolable (1 Kings xix. 2, xxii. 27; 2 Kings vi. 31). It is far from easy to determine how far the development of the class of prophets meant the absorption into it of the old seers. Probably both coexisted for some time. At all events we know from Isa. iii. 2, 3, that in Isaiah's time the *kōsēm* still held an important place in society as well as the prophet and the magician. The functions of *rōch* and *nābhīʾ* may indeed at first have been mingled. The great prophecy of Nathan (2 Sam. vii.) is of too disputed a date to be cited in

Prophetic Societies or Guilds.

Nathan.

Elijah.

evidence,¹ but already in David's time we find that Gad the *nābhīʾ* is also the king's seer (2 Sam. xxiv. 11; cf. 1 Sam. xxii. 5), and by-and-by it comes to be clearly understood that the prophets are the appointed organ of Yahweh's communications with His people or His king. The rise of this function of the prophets is plainly parallel with the change which took place under the kings in the position of the priestly oracle; the Torah of the priests now dealt rather with permanent sacred ordinances than with the giving of new divine counsel for special occasions. Yahweh's ever-present kingship in Israel, which was the chief religious idea brought into prominence by the national revival, demanded a more continuous manifestation of His revealing spirit than was given either by the priestly lot or by the rise of occasional seers; and where could this be sought except among the prophets? It does not, of course, follow that everyone who had shared in the divine afflatus of prophetic enthusiasm gave forth oracles; but the prophets as a class stood nearer than other men to the mysterious workings of Yahweh, and it was in their circle that revelation seemed to have its natural home. A most instructive passage in this respect is 1 Kings xxii., where we find some four hundred prophets gathered together round the king, and where it is clear that Jehoshaphat was equally convinced, on the one hand, that the word of Yahweh could be found among the prophets, and on the other that it was very probable that some, or even the mass of them, might be no better than liars. And here it is to be observed that Micaiah, who proved the true prophet, does not accuse the others of conscious imposture; he admits that they speak under the influence of a spirit proceeding from Yahweh, but it is a lying spirit sent to deceive. The sublime and solitary figure of Elijah, whom we are apt to take as the typical figure of a prophet in the old kingdom, has little in common with the picture even of the true prophet which we derive from 1 Kings xxii.; and when his history is carefully and critically read it is found to give no reason to think that he stood in any close relation to the prophetic societies of his time. He is a man of God, like Moses and Samuel, a man admitted to a strange and awful intimacy with the Most High, and like them he combines functions which in later times were distributed between prophet and priest. The fundamental idea that Yahweh guides His people by the word of revelation is older than the separation of special classes of theocratic organs; Moses, indeed, is not only prophet and priest, but judge and ruler. But, as the history goes on, the prophet stands out more and more as the typical organ of revelation, the type of the man who is Yahweh's intimate, sharing His secrets (Amos iii. 7; Jer. xxiii. 22), and ministering to Israel the gracious guidance which distinguishes it from all other nations (Amos ii. 11; Hosea xii. 10, 13), and also the sentences of awful judgment by which Yahweh rebukes rebellion (Hos. vi. 5). The full development of this view seems to lie between the time of Elijah and that of Amos and Hosea—under the dynasty of Jehu, when prophecy, as represented by Elisha and Jonah, stood in the fullest harmony with the patriotic efforts of the age. This growth in the conception of the prophetic function is reflected in parts of the Pentateuch, which may be dated with probability as belonging to the period just named; the name of *nābhīʾ* is extended to the patriarchs as Yahweh's intimates (Gen. xx. 7), and Moses begins to be chiefly looked at as the greatest of prophets (Num. xi., xii.; Deut. xxxiv. 10), while Aaron and Miriam are also placed in the same class (Exod. xv. 20; Num. xii.), because they too are among the divinely favoured leaders of Israel (cf. Micah vi. 4).²

¹ Budde (*Bücher Samuelis*, p. 233) assigns Nathan's speech (2 Sam. vii.) to a late E. writer in the 7th century. Perhaps we might assign it and Jer. xxiii. 5, 6, to the earlier part of Josiah's reign.

² None of these passages belong to the very oldest thread of Pentateuchal story, and similarly Deborah is called prophetess only in the later account (Judg. iv. 4), not in the song (Judg. v.). It is characteristic that in Num. xi. the elders who receive a share in Moses' task also receive a share of his prophetic spirit (cf. the parallel 2 Kings ii. 9 seq.). In the older account (Exod. xviii.) this is not so. Again, Moses differs from all other prophets in that Yahweh speaks to him face to face, and he sees the similitude of Yahweh. This is in fact the difference between him and Elijah

Elisha, the successor of Elijah, stood in much closer relations to the prophetic societies than his great master had done. As a man of practical aims he required a circle through which to work, and he found this among the prophets, or, as they are now called, the sons of the prophets. According to Semitic idiom "sons of the prophets" most naturally means "members of a prophetic corporation,"³ which may imply that under the headship of Elisha and the favour of the dynasty of Jehu, which owed much to Elisha and his party, the prophetic societies took a more regular form than before. The accounts we have certainly point in this direction, and it is characteristic that in 2 Kings iv. 42 first-fruits are paid to Elisha. But to an institution like prophecy national recognition, royal favour and fixed organization are dangerous gifts. It has always been the evil fate of the Hebrews to destroy their own highest ideals by attempting to translate them into set forms, and the ideal of a prophetic guidance of the nation of Yahweh could not have been more effectually neutralized than by committing its realization to the kind of state Church of professional prophets, "eating bread" by their trade (Amos vii. 12),⁴ which claimed to inherit the traditions of Elijah and Elisha. The sons of the prophets appear to have been grouped round the leading sanctuaries, Gilgal, Bethel, and the like (cf. Hos. ix. 8), and to have stood in pretty close relation to the priesthood (Hos. iv. 5), though this comes out more clearly for the southern kingdom, where, down to the last days of Hebrew independence, the official prophets of Jerusalem were connected with the Temple and were under the authority of the chief priest (Jer. xxix. 26). Since the absorption of the aborigines in Israel Canaanite ideas had exercised great influence over the sanctuaries—so much so that the reforming prophets of the 8th century regarded the national religion as having become wholly heathenish; and this influence the ordinary prophets, whom a man like Micah regards as mere diviners, had certainly not escaped. They too were, at the beginning of the Assyrian period, not much more different from prophets of Baal than the priests were from priests of Baal. Their God had another name, but it was almost forgotten that He had a different character.

The rise and progress of the new school of prophecy, beginning with Amos and continued in the succession of canonical prophets, which broke through this religious stagnation, is *Amos* discussed in the article HEBREW RELIGION; for from *and his* Amos, and still more from Isaiah downwards, the *Successors*. prophets and their work made up the chief interest of Hebrew history. From this time, moreover, the prophets appear as authors; and their books, preserved in the Old Testament, form the subject of special articles (AMOS, HOSEA, &c.). A few observations of a general character will therefore suffice in this place.

Amos disclaimed all connexion with the mere professional prophets, and in this he was followed by his successors. Formerly the prophets of Yahweh had been all on the same side; their opponents were the prophets of Baal. But henceforth there were two parties among the prophets of Yahweh themselves, the new prophets accusing the old of imposture and disloyalty to Yahweh, and these retaliating with charge of disloyalty to Israel. We have learned to call the prophets of the new school "true" prophets and their adversaries "false"; and this is perfectly just if we take the appellations to mean that the true prophets maintained a higher, and therefore a truer, view of (cf. Exod. xxxiii. 8–11 with 1 Kings xix. 13), but not between him and the great prophets of the 8th century (Isa. vi. 5). That prophecy was generally given in visions, dreams and obscure sentences is true only of an early period. Amos still has frequent visions of a more or less enigmatic character, as Micaiah had, but there is little trace of this in the great prophets after him. On the psychological reasons for this see W. R. Smith, *Prophets of Israel* (1882), p. 221 seq.

³ See G. Hoffmann, *Kirchenversammlung zu Ephesus* (1873), p. 89.

⁴ Those who consulted the old seers were expected to make a present, 1 Sam. ix. 7 (Arabic *ḥolwānu-l-kāhin*; cf. Bokhari iv. 219). Similar presents were brought to the older prophets (1 Kings xiv. 3), and first-fruits were sometimes paid to a man of God; but the successors of Amos share his contempt for those who traded on their oracles (*Mic.* iii. 5 seq.).

Yahweh's character, purpose and relation to His people. But the false prophets were by no means mere common impostors; they were the accredited exponents of the common orthodoxy of their day, for the prophets who opposed Jeremiah took their stand on the ground of the prophetic traditions of Isaiah, whose doctrine of the inviolability of Yahweh's seat on Zion was the starting-point of their opposition to Jeremiah's predictions of captivity. No doubt there were many conscious hypocrites and impostors among the professional prophets, as there always will be among the professional representatives of a religious standpoint which is intrinsically untenable, and yet has on its side the prestige of tradition and popular acceptance. But on the whole the false prophets deserve that name, not for their conscious impostures, but because they were content to handle religious formulas, which they had learned by rote, as if they were intuitive principles, the fruit of direct spiritual experience, to enforce a conventional morality, shutting their eyes to glaring national sins, after the manner of professional orthodoxy, and, in brief, to treat the religious *status quo* as if it could be accepted without question as fully embodying the unchanging principles of all religion. The popular faith was full of heathenish superstition strangely blended with the higher ideas which were the inheritance left to Israel by men like Moses and Elijah; but the common prophets accepted all alike, and combined heathen arts of divination and practices of mere physical enthusiasm with a not altogether insincere pretension that through their professional oracles the ideal was being maintained of a continuous divine guidance of the people of Yahweh.

Amos and his successors accepted the old ideal of prophecy if they disowned the class which pretended to embody it. "The Lord Yahweh will do nothing, but He revealeth His secret to His servants the prophets." "By a prophet Yahweh brought Israel out of Egypt, and by a prophet" in each successive age Israel had been watched over and preserved. But in point of fact the function of the new prophecy was not to preserve but to destroy Israel, if Israel still meant the actual Hebrew nation, with its traditional national life. Till Amos (with the solitary exception of Micaiah ben Imlah, in 1 Kings xxii.) prophecy was optimist—even Elijah, if he denounced the destruction of a dynasty and the annihilation of all who had bowed the knee to Baal, never doubted of the future of the nation when only the faithful remained; but the new prophecy is pessimist—it knows that Israel is rotten to the core, and that the whole fabric of society must be dissolved before reconstruction is possible. And this it knows, not by a mere ethical judgment on the visible state of society, but because it has read Yahweh's secret written in the signs of the times and knows that He has condemned His people. To the mass these signs are unintelligible, because they deem it impossible that Yahweh should utterly cast off His chosen nation; but to those who know His absolute righteousness, and confront it with the people's sin, the impending approach of the Assyrian can have only one meaning and can point to only one issue, viz. the total ruin of the nation which has denied its divine head. It is sometimes proposed to view the canonical prophets as simple preachers of righteousness; their predictions of woe, we are told, are conditional, and tell what Israel must suffer if it does not repent. But this is an incomplete view; the peculiarity of their position is that they know that Israel as it exists is beyond repentance. Only, while they are hopeless about their nation they have absolute faith in Yahweh and His purpose. That cannot be frustrated, and, as it includes the choice of Israel as His people, it is certain that, though the present commonwealth must perish, a new and better Israel will rise from its grave. Not the reformation but the resurrection of Israel is the goal of the prophets' hope (Hos. vi. 1 seq.).

This of course is only the broadest possible statement of a position which undergoes many modifications in the hands of individual seers, but on the whole governs all prophecy from Amos to Jeremiah. The position has, we see, two sides: on the one side the prophets are heralds of an inexorable judgment based on the demands of absolute righteousness; on the other

they represent an assured conviction of Yahweh's invincible and gracious love. The current theological formula for this two-sided position is that the prophets are at once preachers of the law and forerunners of the gospel; and, as it is generally assumed that they found the law already written, their originality and real importance is made to lie wholly in their evangelical function. But in reality as has been shown in the article on HEBREW RELIGION, the prophets are older than the law, and the part of their work which was really epoch-making for Israel is just the part which is usually passed over as unimportant. By emphasizing the purely moral character of Yahweh's demands from Israel, by teaching that the mere payment of service and worship at Yahweh's shrines did not entitle Israel's sins to be treated one whit more lightly than the sins of other nations, and by enforcing these doctrines through the conception that the approach of the all-destroying empire, before which Israel must fall equally with all its neighbours, was the proof of Yahweh's impartial righteousness, they gave for the first time a really broad and rightful conception of the moral government of the whole earth by the one true God.¹

It is impossible to read the books of the older prophets, and especially of their protagonist Amos, without seeing that the new thing which they are compelled to speak is not Yahweh's grace but His inexorable and righteous wrath. That that wrath must be followed by fresh mercies is not in itself a new thought, but only the necessary expression of the inherited conviction that Yahweh whom they preach as the judge of all the earth, is nevertheless, as past history has proved, the God who has chosen Israel as His people. That this is so appears most clearly in the fact that with Amos the prophecy of restoration appears only in a few verses at the end of his book, and in the still more instructive fact that neither he nor Hosea attempts to explain how the restoration which they accept as a postulate of faith is to be historically realized.² Recent critics, however, viz. Wellhausen, Nowack, Marti and Harper, as well as others, have denied the genuineness of the concluding verses in Amos, viz. ix. 8-15. To Hosea, at least in his later prophecies, the fate of Judah does not appear separable from that of the northern realm—when Israel and Ephraim fall by their iniquity Judah must fall with them (Hos. v. 5). Thus even on this side there is no real bridge over the chasm that separates the total ruin impending over the Israel of the present from the glorious restoration of the Israel of the future. There is a unity in the divine purpose, of which judgment and mercy are the two poles, but there is as yet no conception of an historical continuity in the execution of that purpose, and therefore no foundation laid for the maintenance of a continuous community of faith in the impending fall of the nation.

From this we can see the enormous importance of the work of Isaiah as it has been exhibited in the article HEBREW RELIGION; his doctrine of the remnant, never lost to the nation in the worst times, never destroyed by the most fiery judgments, supplies the lacking element of continuity between the Israel of the present and of the future. Yahweh's kingdom cannot perish even for a time; nay, Isaiah argues that it must remain visible, and visible not merely in the circle of the like-minded whom he had gathered round him and who formed the first germ of the notion of the church, but in the political form of a kingdom also. Zion at least, the sacred hearth of Yahweh, the visible centre of His kingdom,

¹ It must not be supposed that this conception necessarily came into force as soon as it was recognized that Yahweh was the creator of the universe. That the national or tribal god is the creator is an idea often found in very low religions. To us God's sovereignty over nature often seems the hardest thing to conceive; but to primitive peoples who know nothing of laws of nature, His moral sovereignty is a much more difficult conception. In the older literature of the Hebrews, the nearest approach to the thought of Amos and Hosea is not Gen. ii., iii., but Gen. xviii. 25.

² Hosea ii. 14 seq., xi. 10 seq. are not solutions of this difficulty, as appears from their metaphorical form. They tell us that Yahweh will call His people and that they will answer; but this is only putting in another form the axiom that the gifts and calling of God are without repentance.

must remain inviolable; it can never be delivered into the hands of the Assyrian. Thus, with Isaiah in the days of Sennacherib's invasion, the prophetic word became again, as it had been in the days of the Syrian wars, "the chariots and horsemen of Israel," the stay and strength of all patriotic hope.

Yet even at this crisis the resemblance between Isaiah and Elisha, between the new prophecy and the old, is more apparent than real. Elisha still stands firmly planted on the old national conception of the religion of Yahweh; his ideals are such as do not lie beyond the range of practical politics. In doing battle against the Tyrian Baal he is content with a reformation for which the whole nation can be heartily won, because it makes no radical change in their inherited faith and practices of worship. And in stimulating resistance to Syria he is still the prophet of the old "God of the hosts of Israel"—a God who works deliverance by the thews and sinews of His earthly warriors. But Isaiah's ideal of religion was one for which he himself demands as a preliminary condition an outpouring of Yahweh's spirit on king (Isa. xi. 2) and people (Isa. xxxii. 15), working an entire moral regeneration. And so too it is not through the material organization of the Judaean kingdom that Isaiah looks for deliverance from Assyria. He sees with absolute clearness the powerlessness of the little realm against that great empire: the Assyrian must fall, and fall before Jerusalem, that Yahweh alone may appear to all the earth as the one true God, while all the idols appear as vain to help their worshippers. These conceptions break through the old particularistic idea of Yahweh and His religion at every point. Zion is now not the centre of a mere national cult, but the centre of all true religion for the whole world; and more than once the prophet indicates not obscurely that the necessary issue of the great conflict between Yahweh and the gods of the heathen must be the conversion of all nations, the disappearance of every other religion before the faith of the God of Israel. The pre-exilic origin of Isa. ii. 2-4 which announces that all foreign nations shall stream towards the exalted mountain of Yahweh's temple is maintained by Duhm but is denied by many recent critics including Cornill. But this all-conquering religion is not the popular Yahweh worship; why then can the prophet still hold that the one true God is yet the God of Israel, and that the vindication of His Godhead involves the preservation of Israel? Not because His providence is confined to Israel—it embraces all nations; not because He shows any favouritism to Israel—He judges all nations by the same strict rule. If Israel alone among nations can meet the Assyrian with the boast "with us is God," the reason is that in Zion the true God is known—not indeed to the mass, but to the prophet, and that the "holy seed"¹ or "remnant" (contained in the name *She'ar yāshūbh*) which forms the salt of the nation. The interpretation which Isaiah puts on this fact depends on the circumstance that at that date religion had never been conceived as a relation between God and individuals, or as a relation between God and a purely spiritual society, but always as a relation between a deity and some natural social group—a stock, a tribe, a nation. It was therefore only as the God of Israel that the true God could be known within Israel; and so on the one hand the little society of faith—which had not in reality the least tinge of political coherence—is thought of as yet forming the true kernel of the nation *qua* nation, while on the other hand the state of Judah profits by the prophetic religion inasmuch as the nation must be saved from destruction in order that the prophetic faith—which is still bound up with the idea of the nation—may not be dissolved. This connexion of ideas was not of course explicitly before the prophet's mind, for the distinctive features of a national religion could not be formulated so long as no other kind of religion had ever been heard of. When we put down in black and white the explicit details of what is

¹ We should be apt to say "the true idea of God," but that is a way of putting it which does not correspond with prophetic thought. To the prophets knowledge of God is concrete knowledge of the divine character as shown in acts—knowledge of a person, not of an idea.

² The last clause of Isa. vi. 13, "a holy seed is its stock," is rejected by many critics (Duhm, Cheyne, Marti and others) as a later insertion. It is omitted in the Septuagint.

involved in Isaiah's conclusion of faith we see that it has no absolute validity. True religion can exist without having a particular nation as its subject as soon as the idea of a spiritual community of faith has been realized. But till this was realized Isaiah was right in teaching that the law of continuity demanded that the nation within which Yahweh had made Himself known to His spiritual prophets must be maintained as a nation for the sake of the glory of God and the preservation of the "remnant."

The withdrawal of Sennacherib's army, in which the doctrine of the inviolability of Zion received the most striking practical confirmation, was welcomed by Isaiah and his disciples as an earnest of the speedy inbringing of the new spiritual era. But these hopes were not fulfilled. The prophetic teaching had indeed produced a profound effect; to the party of reaction, as the persecution under Manasseh shows, it seemed to threaten to subvert all society; and we can still measure the range and depth of its influence in the literary remains of the period from Isaiah to the captivity, which include Micah vi. 1-8, and that noble essay to build a complete national code on the principle of love to God, righteousness, and humanity—the legislation of Deuteronomy. Nay more, the reception of the book of Deuteronomy by king and people in the eighteenth year of Josiah shows what a hold the prophetic teaching had on the popular conscience. It was no small triumph that there was even a passing attempt to introduce such a code as the law of the land. But it was one thing to touch the conscience of the nation and another to change its heart and renew its whole life. That no code could do, and, as every practical government must adapt itself to actualities and not to a purely ideal standard, it must have appeared at once that the attempt to govern by prophetic ideas was only sewing a new piece on an old garment. The immediate result of Josiah's reformation was the complete dissolution of anything that could be called a political party of prophetic ideas; the priests and the ordinary prophets were satisfied with what had been accomplished; the old abuses began again, but the nation had received a reformed constitution and there was nothing more to be said.

Thus it was that, though beyond question there had been a real advance in the average ethical and spiritual ideas of the people since the time of Isaiah, Jeremiah found himself more isolated than Isaiah had ever been. Even in that earliest part of his book which is mainly a recapitulation of his experiences and work in the reign of Josiah, his tone is one of absolute hopelessness as to the future of the nation. But we should quite misunderstand this pessimism if we held it to mean that Jeremiah saw no signs of private morality and individual spiritual convictions among his people. To him as a prophet the question was whether Israel as a nation could be saved. In Isaiah's days the answer had been affirmative; there appeared to be at least a potentiality of national regeneration in the holy seed when once it should be cleansed from the chaff by a work of judgment. But, now a century of respite had been granted, the Chaldeans were at the gates, and there was no sign of valid national repentance. The harvest was past, the season of ripe fruits was over, and still Israel was not saved (Jer. viii. 20). The time of respite had been wasted, all attempts at national reformation had failed; how should Yahweh spare a nation which had shown no tokens of fitness to discharge the vocation of Yahweh's people? The question was not whether there was still a faithful remnant, but whether that remnant was able to save the state as a state, and this Jeremiah was forced to deny. Nay, every attempt at genuine amendment was frustrated by the dead weight of a powerful opposition, and when the first captivity came it was precisely the best elements of Judah that went into captivity and were scattered among the nations (xxiv. 5, xxiii. 2 seq.). And so the prophet was compelled to teach that the immediate future of Israel was a blank, that the state as a state was doomed. He did not even dare to intercede for such a nation (vii. 16); though Moses and Samuel stood pleading for it before Yahweh, He could not but cast it out of His sight (xv. 1). It was the death-struggle of the idea of a national religion (vi. 8);

the continuity of true faith refused to be longer bound up with the continuity of the nation. Still indeed the New-Testament idea of a purely spiritual kingdom of God, in this world but not of it, is beyond the prophet's horizon, and he can think of no other vindication of the divine purpose than that the true Israel shall be gathered again from its dispersion. But the condition of this restoration is now changed. To gather the dispersed implies a call of God to individuals, and in the restored Israel the covenant of Yahweh shall not be merely with the nation but with man one by one, and "they shall no more teach everyone his neighbour saying, Know the Lord, for all shall know Me from the least of them even to the greatest of them" (xxxi. 33 seq.). In a word, when the nation is dissolved into its individual elements the continuity and ultimate victory of true faith depends on the relation of Yahweh to individual souls, out of which the new state shall be built up (Jer iii. 14).

Thus, for the first time in the world's history, the ultimate problem of faith is based on the relation of God to the individual believer; and this problem Jeremiah is compelled to face mainly in relation to his own personality, to assure himself that his own faith is a true possession and lifts him above all the calamities that assail him, in spite of the hopeless ruin of his nation. The struggle is a sore one; his very life is bitter to him; and yet he emerges victorious. To know that God is with him is enough though all else fail him. Now as soon as the relation of God to a single soul has thus been set free from all earthly conditions the work of prophecy is really complete, for what God has done for one soul He can do for all, but only by speaking to each believer as directly as He does to Jeremiah. Henceforth revelation is not a word to the nation spoken through an individual, but a word spoken to one which is equally valid for every one who receives it with like faith. The New Testament joins on not to the post-exile prophets, who are only faint echoes of earlier seers, but to Jeremiah's great idea of the new covenant in which God's law is written on the individual heart, and the community of faith is the fellowship of all to whom He has thus spoken. The prophets of the restoration are only the last waves beating on the shore after the storm which destroyed the old nation, but created in its room a fellowship of spiritual religion, had passed over; they resemble the old prophets in the same imperfect way in which the restored community of Jerusalem resembled a real nation. It was only in so far as the community of faith still possessed certain external features of nationality that post-exile prophecy was possible at all, and very soon the care of the national or quasi-national aspects of religion passed altogether out of their hands into those of the scribes, of whom Ezekiel was the first father, and whose Torah was not the living word of prophecy but the Pentateuchal code. From the time of Jeremiah downwards the perennial interest of Old-Testament thought lies in the working out of the problems of personal religion and of the idea of a spiritual fellowship of faith transcending all national limitation; and these are the motives not only of the lyrics of the Psalter but of the greater theodiceas of Isa. xl.-lxvi. and of the book of Job. The theodiceas of the prophets is national; they see Yahweh's righteousness working itself out with unmistakable clearness in the present, and know that all that He brings upon Israel is manifestly just; but from the days of Jeremiah¹ the fortunes of Israel as a nation are no longer the one thing which religion has to explain; the greater question arises of a theory of the divine purpose which shall justify the ways of God with individual men or with His "righteous servant"—that is, with the ideal community of true faith as distinct from the natural Israel.

It will be evident even from this rapid sketch, necessarily confined to a few of the most cardinal points, that Hebrew prophecy is not a thing that can be defined and reduced to a formula, but was a living institution which can only be understood by studying its growth and observing its connexion with the historical movements with which its various manifestations were bound up. Throughout the great age of prophecy the most obvious formal character that distinguished it was that the

¹ One might say from the days of Habakkuk.

prophet did not speak in his own name but in the name of Yahweh. But the claim to speak in the name of God is one which has often been made—and made sincerely—by others than the prophets of Israel, and which is susceptible of a great variety of meanings, according to the idea of God and His relation to man which is presupposed. Every early religion seeks to realize such an intercourse with the object of worship as shall be two-sided; when the worshipper approaches the deity he desires to have an answer assuring him of acceptance and divine aid. The revelation thus looked for may be found in natural omens, in the priestly lot or some similar sacral oracle, or, finally, in the words of a seer who is held to be in closer contact with the deity than common men. Broadly speaking these methods of revelation are found in all ancient religions, but no other religion presents anything precisely analogous to prophecy. It is true that the prophets absorbed the old seers, and that the Israelites, as we see in the case of the asses of Kish, went to their seers on the same kind of occasions as sent heathen nations to seers or diviners. There is sufficient evidence that down to the last age of the Judæan monarchy practices not essentially different from divination were current in all classes of society, and were often in the hands of men who claimed to speak as prophets in the name of Yahweh. But the great prophets disallowed this claim, and the distinction which they draw between true prophecy and divination is recognized not only in the prophetic law of Deuteronomy but in earlier parts of the Pentateuch and historical books. "There is no augury in Jacob and no divination in Israel; in due time it is told to Jacob and to Israel what God doth work" (Num. xxiii. 23). The seer, in the sense in which all antiquity believed in seers, is simply a man who sees what others cannot see, no matter whether the thing seen be of public or of mere private interest; but the prophet is an organ of Yahweh's kingship over His people—he sees and tells so much of the secret purpose of Yahweh as is needful for His people to know. We have already seen how Amos and Hosea put this (*supra*, p. 2011), and it does not appear that they were introducing a conception of prophecy formally novel—the new thing was their conception of Yahweh's purpose. And so too with the following great prophets; the important thing in their work was not their moral earnestness and not their specific predictions of future events, but the clearness of spiritual insight with which they read the spiritual significance of the signs of the time and interpreted the movements of history as proofs of Yahweh's actual moral sovereignty exercised over Israel. So long as the great problems of religion could be envisaged as problems of the relation of Yahweh to Israel as a nation the prophets continued to speak and to bring forth new truths; but the ultimate result was that it became apparent that the idea of moral government involved the destruction of Israel, and then the function of prophecy was gone because it was essentially national in its objects. But meantime the relation of God to the prophet had acquired an independent significance; the inner life of Isaiah during the long years when his teaching seemed lost, or of Jeremiah through the whole course of his seemingly fruitless ministry, was rich in experiences of faith triumphing over temptations and trials, of personal converse with God sustaining the soul in the face of difficulties hopeless to the eye of sense, which formed the pattern of a new and higher stage of religion in which the relation of the individual soul to God should be set free from those limitations which had been imposed by the conception that the primary subject of religion is the nation. But the religion of the Old Testament did not become merely individualistic in becoming individual, and now the problem was to realize a new conception of the society of faith, the true Israel, the collective servant of Yahweh—in a word to form the idea of a spiritual commonwealth and to show how it was possible for faith to hold fast, in spite of all seeming contradiction, to the truth that Yahweh had chosen for himself a spiritual people, every member of which was in truth the object of His saving and unending love, and which should ultimately in very deed inherit that glory of which the carnal Israel was unworthy. This is the post-prophetic problem

which occupies the more profound of the later Old-Testament books, but first received its true solution in the gospel, when the last shreds of the old nationalism disappeared and the spiritual kingdom found its centre in the person of Christ.

Old-Testament prophecy therefore forms only one stage in a larger development, and its true significance and value can only be realized when it is looked at in this light. In this as in all other matters of transcendental truth "wisdom is justified of her children"; the conclusive vindication of the prophets as true messengers of God is that their work forms an integral part in the progress of spiritual religion, and there are many things in their teaching the profundity and importance of which are much clearer to us than they could possibly have been to their contemporaries, because they are mere flashes of spiritual insight lighting up for a moment some corner of a region on which the steady sun of the gospel had not yet risen.

A less complete but yet most powerful vindication of the spiritual prophets was furnished by the course and event of Israel's history. After the captivity it was no longer a question that the prophetic conception of Yahweh was the only possible one. Thenceforth the religion of Yahweh and the religion of the prophets are synonymous; no other reading of Israel's past was possible, and in fact the whole history of the Hebrews in Canaan, as it was finally shaped in the exile, is written from this point of view, and has come down to us, along with the remains of actual prophetic books, under the collective title of "The Prophets."

To some extent this historical vindication of the prophetic insight went on during the activity of the prophets themselves. From the time of Amos downwards the prophets spoke mainly at great historical crises, when events were moving fast and a few years were often sufficient to show that they were right and their opponents wrong in their reading of the signs of the times. And here the controversy did not turn on the exact fulfilment of detailed predictions; detailed prediction occupies a very secondary place in the writings of the prophets.

The prophets themselves required no historical verification of their word to assure them that it was indeed the word of God, nor do they for a moment admit that their contemporaries are entitled to treat its authority as unproved till such verification is offered. The word of God carries its own evidence with it in its searching force and fire: "Is not my word like as a fire, saith Yahweh, and like a hammer that breaketh the rock in pieces?" (Jer. xxiii. 29). To the prophet himself it comes with imperious force: it constrains him to speak (Amos iii. 8), seizes him with a strong hand (Isa. viii. 11), burns like a fire within his bones till it finds utterance (Jer. xx. 9); and it is this force of moral conviction which ought also to commend it to the conscience of his hearers. The word is true because it is worthy of the true God. When Deut. xviii. 21, 22 seeks the legal criterion of true prophecy in the fulfilment of prediction, the writer is no doubt guided by the remembrance of the remarkable confirmation which the doctrines of spiritual prophecy had received in history then recent, but his criterion would have appeared inadequate to the prophets themselves, and indeed this passage is one of the most striking proofs that to formulate the principles of prophetic religion in a legal code was an impossible task.

The mass of the nation, of course, was always much more struck by the "signs" and predictions of the prophets than by their spiritual ideas; we see how the idea of supernatural insight and power in everyday matters dominates the popular conception of Elijah and Elisha in the books of Kings. At a very early date the great prophets became a kind of saints or *welsh*, and the respect paid to the tombs of the prophets, which ultimately took in almost every particular the place of the old local shrines (Matt. xxiii. 29; Jerome, *Epil. Paulae*, § 13; see OBADIAH), can be traced back to the time before the exile.¹

The Hebrew prophet stands alone among divinely appointed

¹ See 2 Kings xxiii. 21, and also Deut. xxxiv. 6. So too all the old national heroes and heroines ultimately became prophets; in the case of Deborah there is even a fusion in local tradition between an old heroine and an historical seer.

and inspired men of any religion, though analogies in other religions present themselves. Ethical and religious teachers arose among other nations of antiquity whose precepts may well be compared with those of Hebrew prophecy. We might cite the maxims of Ani in the Egyptian papyrus Prisse (XIIth dynasty). But these teachers did not succeed in accomplishing a task parallel to what the Hebrew prophets achieved, namely, the complete renewal and elevation of the Hebrew religion from a local and national into a universal and ethical religion. Yet instructive parallels may be found in ancient literatures. Thus the Vedic hymns are reputed to have no human authors. The names attached to them are those of the seers who "saw" them, to whom they were revealed. They are therefore merely the channels through which the divine word is communicated to man (Professor Rapson). The Rev. C. H. W. Johns (*Interpreter*, April 1906, "The Prophets of Babylonia") thinks that longer discourses moral, and predictive, fully equal to those of the Hebrew prophets, existed in Babylonia as early as the 3rd millennium B.C. but were curtailed into the brief sentences of the omen tablets. "The so-called 'tablet of warning to kings against injustice' gives a fair specimen of connected discourse, e.g. 'If a king hearken not to law, his people shall grow feeble and his land be ravaged. If he attend not to the justice of his land, Ea, the king of fates, shall distort his lot, &c.'" Further illustrations of ethical teaching may be found in the litany or confession of a penitent cited by Mr Johns in the same paper (p. 303).

It may be here stated that Winckler's conception of the Hebrew prophet Isaiah as the mouthpiece of the Assyrian court (*K.A.T.*³ p. 172 sqq.) can be easily refuted by a reference to the Isaianic oracles. A theory that Jeremiah was similarly influenced from Babylonia might seem more plausible, though equally baseless.

After the extinction of the prophetic voice, an ever-increasing weight was not unnaturally laid on the predictive element in their writings. Their creative religious ideas had become the common property of religious-minded Jews, at least in the somewhat imperfect shape in which they were embodied in the law, and their work on this side was carried on by the great religious poets. But the restored community which was still making a sort of faint attempt to be a religious nation as well as a Church felt very painfully the want of a direct message from God in critical times such as the prophets of old had been wont to bring. And in this need men began to look at the prophetic books, mainly in the hope that there might be found in them predictions which still awaited fulfilment, and might be taken as referring to the latter days of Persian or Greek oppression. By ignoring the free poetical form of prophecy, and still more by ignoring the fact that the prophetic pictures of the ideal future of Israel could not be literally fulfilled after the fall of the ancient state had entirely changed the sphere in which the problems of true religion had to be worked out, it was possible to find a great mass of unfulfilled prophecy which might form the basis of eschatological constructions. All this was quite in the vein of later Judaism, and so at length the unfulfilled predictions of the prophets served as the raw material for the elaborate eschatology of the apocalypses (see APOCALYPTIC LITERATURE). In spite of superficial resemblances, mainly due to the unavoidable influence of current exegetical methods, the conception of prophecy as fulfilled in Christ is fundamentally different from the Jewish apocalyptic view of unfulfilled prophecy. Not external details but the spiritual ideas of the prophets find their fulfilment in the new dispensation, and they do so under forms entirely diverse from those of the old national kingdom of Yahweh.

LITERATURE.—In the ancient and medieval Church and in the dogmatic period of Protestantism there was little or no attempt at historical study of prophecy, and the prophetic books were found instructive only through the application of allegorical or typical exegesis. For details the reader may refer to Diestel, *Geschichte des Alten Testaments* (Jena 1869), and for the final form of orthodox Protestant views to Witsius, *De prophetis et prophetia*. The growing sense of the insufficiency of this treatment towards the close of the period of dogmatism showed itself in various ways. On the one hand we have the revival of apocalyptic exegesis by Cocceius and his school,

which has continued to influence certain circles down to the present day, and has led to the most varied attempts to find in prophecy a history written before the event of all the chief vicissitudes of the Christian Church down to the end of the world. On the other hand Lowth's *Lectures on Hebrew Poetry*, and the same author's *Commentary on Isaiah* (1778), show the beginnings of a tendency to look mainly at the aesthetic aspects of the prophetic books, and to view the prophets as enlightened religious poets. This tendency culminates in Eichhorn, *Die hebräischen Propheten* (1816). Neither of these methods could do much for the historical understanding of the phenomena of prophecy as a whole, and the more liberal students of the Old Testament were long blinded by the moralizing unhistorical rationalism which succeeded the old orthodoxy. The first requisite of real progress, after dogmatic prejudices had been broken through, was to get a living conception of the history in which the prophets moved; and this again called for a revision of all traditional notions as to the age of the various parts of Hebrew literature—criticism of the sources of the history, among which the prophetic books themselves take the first place. In recent times therefore advance in the understanding of the prophets has moved on *pari passu* with the higher criticism, especially the criticism of the Pentateuch, and with the general study of Hebrew history; and most works on the subject prior to Ewald must be regarded as quite antiquated except for the light they cast on detailed points of exegesis. On the prophets and their works the reader would still do well to consult Ewald's *Propheten des alten Bundes* (1st ed., 1840–1841, 2nd ed., 1867–1868, Eng. trans., 1876–1877). The subject is treated in all works on Old Testament introduction (among which Kuenen's *Onderzoek*, vol. ii., claims the first place), and on Old-Testament theology (see especially Vatke, *Religion des A.T.*, 1835). On the theology of the prophets there is a separate work by Duhm (Bonn, 1875), and Knobel's *Prophetismus der Hebräer* (1837), is a separate introduction to the prophetic books. Kuenen's *Prophets and Prophecy in Israel* (1875, Eng. trans. 1877) is in form mainly a criticism of the traditional view of prophecy, and should therefore be compared with his *Onderzoek and Godsdienst van Israel*. Most English books on the subject are more theological than historical, but a sketch of Hebrew prophecy in connexion with the history down to the close of the 8th century is given by W. R. Smith, *The Prophets of Israel* (Edinburgh, 1882). The literature of the theological questions connected with prophecy is much too copious to be cited here; lists will be found in several of the books already referred to. Among more recent works and articles should be mentioned Briggs, *Messianic Prophecy*; Giesebrecht, *Die Berufsbegabung der alttestamentlichen Propheten*; Volz, *Die vorexilische Jahwe-Prophetie u. der Messias*; Hühn, *Die messianischen Weissagungen*; R. Kittel, *Prophetie u. Weissagung*; Professor Kennett, *Pre-exilic Prophets*; W. H. Bennett, *Post-exilic Prophets* (T. and T. Clark); A. B. Davidson, "Prophecy and Prophets," in Hastings's *Dict. Bible*; also "Prophetic Literature," by Chayne and others in *Ency. Bibl.* (W. R. S.; O. C. W.)

II. *Prophets in the Primitive Church.*—The appearance of prophets in the first Christian communities is one proof of the strength of faith and hope by which these bodies were animated. An old prophecy (Joel iii. 1) has foretold that in the Messianic age the Spirit of God would be poured out on every member of the religious community, and in point of fact it was the universal conviction of those who believed in Christ that they all possessed the Spirit of God. This Spirit, manifesting His presence in a variety of ways and through a variety of gifts, was to be the only ruling authority in the Church. He raised up for Himself particular individuals, into whose mouths He put the word of God, and these were at first regarded as the true leaders of the congregations. We find accordingly that there were prophets in the oldest church, that of Jerusalem (Acts. xi. 27, xv. 32), and again that there were "prophets and teachers" in the church at Antioch (Acts xiii. 1). These were not office-bearers chosen by the congregation, but preachers raised up by the Spirit and conferred as gifts on the Church. When Paul says (1 Cor. xii. 28; cf. Eph. iv. 11), "God hath set some in the Church, first apostles, secondarily prophets, thirdly teachers," he points to a state of things which in his time prevailed in all the churches both of Jewish and heathen origin. We here learn from Paul that the prophets occupied the second position in point of dignity; and we see from another passage (1 Cor. xiv.) that they were distinguished from the teachers by their speaking under the influence of inspiration—not, however, like the "speakers in tongues," in unintelligible ejaculations and disconnected words, but in articulate, rational edifying speech. Until recently it was impossible to form any distinct idea of the Christian prophets in the post-apostolic age, not so much from want of materials as because what evidence existed was not

sufficiently clear and connected. It was understood, indeed, that they had maintained their place in the churches till the end of the 2nd century, and that the great conflict with what is known as Montanism had first proved fatal to them; but a clear conception of their position and influence in the churches was not to be had. But the discovery, by Bryennios in 1873, of the ancient Christian work called *Διδαχὴ τῶν δώδεκα ἀποστόλων* (published in 1883), has immensely extended the range of our knowledge, and has at the same time thrown a clear light on many notices in other sources which for want of proper interpretation had been previously neglected or incorrectly understood.

The most important facts known at present about the manner of life, the influence, and the history of the early Christian prophets are the following: (1) Until late in the 2nd century the prophets (or prophetesses) were regarded as an essential element in a Church possessing the Holy Ghost. Their existence was believed in, and they did actually exist, not only in the catholic congregations—if the expression may be used—but also in the Marcionite Church and the Gnostic societies. Not a few Christian prophets are known to us by name: as Agabus, Judas, and Silas in Jerusalem; Barnabas, Simon Niger, &c., in Antioch; in Asia Minor, the daughters of Philip, Quadratus, Ammia, Polycarp, Melito, Montanus, Maximilla and Priscilla; in Rome, Hermas; among the followers of Basilides, Barkabbas and Barkoph; in the community of Apelles, Philumene, &c. Lucian tells us that the impostor Peregrinus Proteus, in the time of Antoninus Pius, figured as a prophet in the Christian churches of Syria. (2) Till the middle of the 2nd century the prophets were the regular preachers of the churches, without being attached to any particular congregation. While the "apostles" (*i.e.* itinerating missionaries) were obliged to preach from place to place, the prophets were at liberty either, like the teachers, to settle in a certain church or to travel from one to another. (3) In the time of Paul the form of prophecy was reasoned exhortation in a state of inspiration; but very frequently the inspiration took the form of ecstasy—the prophet lost control of himself, so that he did not remember afterwards what he had said. In the Gentile-Christian churches, under the influence of pagan associations, ecstasy was the rule. (4) With regard to the matter of prophecy, it might embrace anything that was necessary or for the edification of the Church. The prophets not only consoled and exhorted by the recital of what God had done and by predictions of the future, but they uttered extempore thanksgivings in the congregational assemblies, and delivered special directions, which might extend to the most minute details, as, for example, the disposal of the church funds. (5) It was the duty of the prophets to follow in all respects the example of the Lord (*ἔχειν τοὺς τρόπους τοῦ Κυρίου*), and to put in practice what they preached. But an ascetic life was expected of them only when, like the apostles, they went about as missionaries, in which case the rules in Matt. x. applied to them. Whenever, on the contrary, they settled in a place they had a claim to a liberal maintenance at the hands of the congregation. The author of the *Διδαχὴ* even compares them to the High Priests of the Old Testament, and considers them entitled to the first-fruits of the Levitical law. In reality, they might justly be compared to the priests in so far as they were the mouthpieces of the congregation in public thanksgiving. (6) Since prophets were regarded as a gift of God and as moved by the Holy Spirit, the individual congregation had no right of control over them. When anyone was approved as a prophet and exhibited the "conversation of the Lord," no one was permitted to put him to the test or to criticize him. The author of the *Διδαχὴ* goes so far as to assert that whoever does this is guilty of the sin against the Holy Ghost. (7) This unique position of the prophets could only be maintained so long as the original enthusiasm remained fresh and vigorous. From three quarters primitive Christian prophecy was exposed to danger—first, from the permanent officials of the congregation, who, in the interests of order, peace and security could not but look with suspicion on the activity of excited prophets; second, from the prophets themselves, in so

far as an increasing number of dishonest characters was found amongst them, whose object was to levy contributions on the churches;¹ third, from those prophets who were filled with the stern spirit of primitive Christianity and imposed on churches, now becoming assimilated to the world, obligations which these were neither able nor willing to fulfil. It is from this point of view that we must seek to understand the so-called Montanistic crisis. Even the author of the *Διδάχη* finds it necessary to defend the prophets who practised celibacy and strict asceticism against the depreciatory criticism of church members. In Asia Minor there was already in the year 160 a party, called by Epiphanius "Alogi," who rejected all Christian prophecy. On the other hand, it was also in Asia Minor that there appeared along with Montanus those energetic prophetesses who charged the churches and their bishops and deacons with becoming secularized, and endeavoured to prevent Christianity from being naturalized in the world, and to bring the churches once more under the exclusive guidance of the Spirit and His charismata. The critical situation thus arising spread in the course of a few decades over most of the provincial churches. The necessity of resisting the inexorable demands of the prophets led to the introduction of new rules for distinguishing true and false prophets. No prophet, it was declared, could speak in ecstasy, that was devilish; further, only false prophets accepted gifts. Both canons were innovations, designed to strike a fatal blow at prophecy and the church organization re-established by the prophets in Asia—the bishops not being quite prepared to declare boldly that the Church had no further need of prophets. But the prophets would not have been suppressed by their new methods of judging them alone. A much more important circumstance was the rise of a new theory, according to which all divine revelations were summed up in the apostles or in their writings. It was now taught that prophecy in general was a peculiarity of the Old Testament ("lex et prophetæ usque ad Johannem"); that in the new covenant God had spoken only through apostles; that the whole word of God so far as binding on the Church was contained in the apostolic record—the New Testament;² and that, consequently, the Church neither required nor could acknowledge new revelations, or even instructions, through prophets. The revolution which this theory gradually brought about is shown in the transformation of the religious, enthusiastic organization of the Church into a legal and political constitution. A great many things had to be sacrificed to this, and amongst others the old prophets. The strictly enforced episcopal constitution, the creation of a clerical order, and the formation of the New Testament canon accomplished the overthrow of the prophets. Instead of the old formula, "God continually confers on the church apostles, prophets, and teachers," the word now was: "The Church is founded in the (written) word of the prophets (*i.e.* the Old Testament prophets) and the apostles (*viz.* the twelve and Paul)." After the beginning of the 3rd century there were still no doubt men under the control of the hierarchy who experienced the prophetic ecstasy, or clerics like Cyprian who professed to have received special directions from God; but prophets by vocation no longer existed and these sporadic utterances were in no sense placed on a level with the contents of the sacred Scriptures.

See Hilgenfeld, *Die Glossolalie in der alten Kirche* (1850); Bückmann, "Über die Wunderkräfte bei den ersten Christen und ihr Erlöschen," in the *Ztschr. f. d. Ges. luther. Theol. u. Kirche* (1878), pp. 216–255 (learned but utterly uncritical); Bonwetsch, "Die Prophetie im apostol. und nachapostol. Zeitalter," in the *Ztschr. f. kirchl. Wissensch. u. kirchl. Leben* (1884), pt. 8, p. 408 seq. pt. 9, p. 460 seq.; Harnack, *Die Lehre der zwölf Apostel* (1884), pp. 93–137; Haller, "Die Propheten der nachapostolischen Kirche," in the *Theol. Studien aus Württemberg* (1888), p. 36 seq.; Nardin, "Essai sur les prophètes de l'église primitive," Thesis, (Paris, 1888); Weinl, "Die Wirkungen des Geistes und der Geister im nachapostolischen Zeitalter bis auf Irenæus," (1899); Selwyn, "The Christian Prophets

and the Prophetic Apocalypse" (1900); Bénazech, "Le Prophétisme chrétienne depuis les origines jusqu'au pasteur d'Hermas," Thesis, (Paris, 1901). (A. H.A.; A. C. McG.)

PROPIOLIC ACID, $\text{CH}_2\text{C}=\text{CO}_2\text{H}$, acetylene mono-carboxylic acid, an unsaturated organic acid prepared by boiling acetylene dicarboxylic acid (obtained by the action of alcoholic potash on dibromsuccinic acid) or its acid potassium salt with water (E. v. Bandrowski, *Ber.*, 1880, 13, p. 2340). It forms silky crystals which melt at 6°C ., and boil at about 144°C . with decomposition. It is soluble in water and possesses an odour resembling that of acetic acid. Exposure to sunlight converts it into trimesic acid (benzene-1,3,5-tricarboxylic acid). Bromine converts it into dibromacrylic acid, and it gives with hydrochloric acid β -chloracrylic acid. It forms a characteristic explosive silver salt on the addition of ammoniacal silver nitrate to its aqueous solution, and an amorphous precipitate which explodes on warming with ammoniacal cuprous chloride. Its ethyl ester condenses with hydrazine to form pyrazolone (R. v. Rothenburg, *Ber.*, 1893, 26, p. 1722). *Phenylpropionic acid*, $\text{C}_6\text{H}_5\text{C}(\text{C}=\text{CO}_2\text{H})_2$, formed by the action of alcoholic potash on cinnamic acid dibromide, $\text{C}_6\text{H}_5\text{CHBr}\cdot\text{CHBr}\cdot\text{CO}_2\text{H}$, crystallizes in long needles or prisms which melt at $136\text{--}137^\circ\text{C}$. When heated with water to 120°C . it yields phenyl acetylene $\text{C}_6\text{H}_5\cdot\text{C}\equiv\text{CH}$. Chromic acid oxidizes it to benzoic acid; zinc and acetic acid reduce it to cinnamic acid, $\text{C}_6\text{H}_5\cdot\text{CH}=\text{CH}\cdot\text{CO}_2\text{H}$, whilst sodium amalgam reduces it to hydrocinnamic acid, $\text{C}_6\text{H}_5\cdot\text{CH}_2\cdot\text{CO}_2\text{H}$. *Ortho-nitrophenylpropionic acid*, $\text{NO}_2\cdot\text{C}_6\text{H}_4\cdot\text{C}(\text{C}=\text{CO}_2\text{H})_2$, prepared by the action of alcoholic potash on ortho-nitrocinnamic acid dibromide (A. v. Baeyer, *Ber.*, 1880, 13, p. 2258), crystallizes in needles which decompose when heated to $155\text{--}156^\circ\text{C}$. It is readily converted into indigo (*q.v.*).

PROPYLAEA (*Πρόπυλον, Προπίλαια*), the name given to a porch or gate-house, at the entrance of a sacred or other enclosure in Greece; such propylaea usually consisted, in their simplest form, of a porch supported by columns both without and within the actual gate. The name is especially given to the great entrance hall of the Acropolis at Athens, which was begun in 437 B.C. by Pericles, to take the place of an earlier gateway. Owing probably to political difficulties and to the outbreak of the Peloponnesian War, the building was never completed according to the original plans; but the portion that was built was among the chief glories of Athens, and afforded a model to many subsequent imitators. The architect was Mnesicles; the material Pentelic marble, with Eleusinian blackstone for dados and other details. The plan of the Propylaea consists of a large square hall, from which five steps lead up to a wall pierced by five gateways of graduated sizes, the central one giving passage to a road suitable for beasts or possibly for vehicles. On the inner side towards the Acropolis, this wall is faced with a portico of six Doric columns. At the other end of the great hall is a similar portico facing outwards; and between this and the doors the hall is divided into three aisles by rows of Ionic columns. The western or outer front is flanked on each side by a projecting wing, with a row of three smaller Doric columns between Antæ at right angles to the main portico. The north wing is completed by a square chamber which served as a picture gallery; but the south wing contains no corresponding chamber, and its plan has evidently been curtailed; its front projected beyond its covered area, and it is finished in what was evidently a provisional way on the side of the bastion before the little temple of Victory (*Νίκη*). From this and other indications Professor Dorpfeld has inferred that the original plan of Mnesicles was to complete the south wing on a plan symmetrical with that of the north wing, but opening by a portico on to the bastion to the west; and to add on the inner side of the Propylaea two great halls, faced by porticoes almost in a line with the main portico, but with smaller columns. It is probable that this larger plan had to be given up, because it would have interfered with sacred objects such as the precinct of Artemis Brauronia and the altar of Nike, and religious conservatism prevailed over the waning influence of Pericles. In addition to this, the unfinished surface of the walls and the rough bosses left on many

¹ See Lucian's story about Peregrinus, and that chapter of the *Διδάχη* where the author labours to establish criteria for distinguishing false prophets from true.

² The Apocalypse of John was received into it, not as the work of a prophet but as that of an apostle.

of the blocks show that the building was never completed. The Propylaea were approached in Greek times by a zig-zag path, terraced along the rock; this was superseded in Roman times by a broad flight of steps. In medieval times the Propylaea served

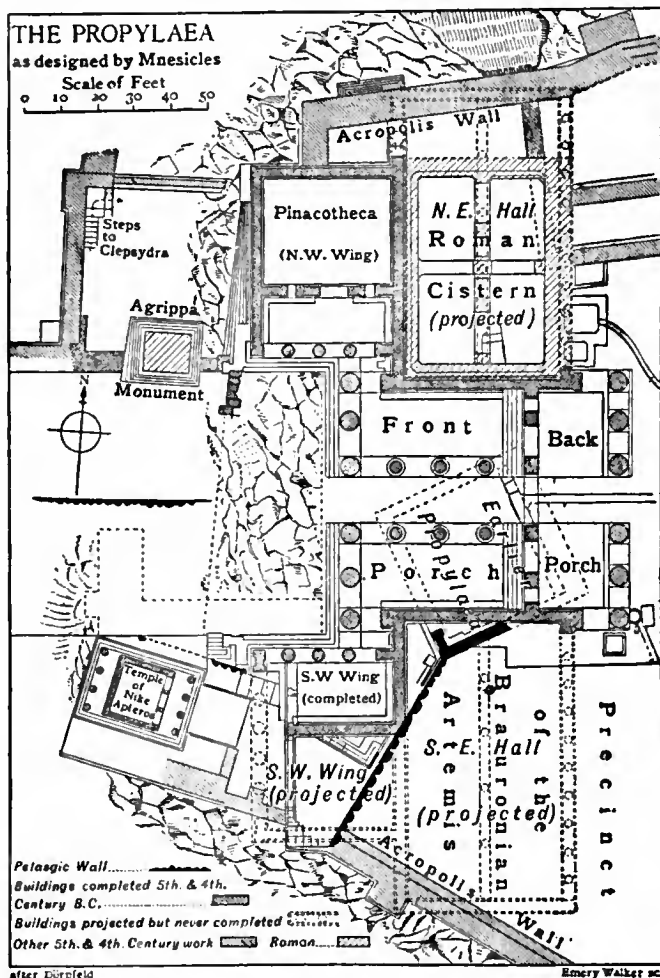

(Redrawn from the *Athenische Mittheilungen* by permission of the Kaiserliches Archaeologisches Institut.)

as the palace of the dukes of Athens; they were much damaged by the explosion of a powder magazine in 1656. The tower, of Frankish or Turkish date, that stood on the south wing, was pulled down in 1874.

See R. Böhn. *Die Propylaeen der Akropolis zu Athen* (Berlin, 1882); W. Dörpfeld, articles in *Mittheilungen d. d. Inst. Athen.* (1885) vol. x. (E. Gr.)

PROPYL ALCOHOLS (C_3H_7OH). Two compounds of this formula exist as explained in the article **ALCOHOLS**. *Normal propyl alcohol*, $CH_3CH_2CH_2OH$, was obtained in 1853 by G. C. B. Chancel, by submitting fusel oil to fractional distillation. It may be prepared by any of the methods applicable to primary alcohols. It is an agreeable-smelling liquid, boiling at $97.4^\circ C.$, and miscible with water in all proportions. It cannot be separated from water by fractional distillation, since it forms a mixture of constant boiling point (see **DISTILLATION**). Oxidation converts it into propionic acid. It is distinguished from ethyl alcohol by its insolubility in a cold saturated calcium chloride solution.

Iso-propyl alcohol ($(CH_3)_2CHOH$), was obtained by M. P. E. Berthelot in 1855 by heating the addition compound of propylene and sulphuric acid with water, and in 1862 by C. Friedel by the reduction of acetone. It is a colourless liquid boiling at $82.7^\circ C.$

PROROGATION, a postponement, specifically the termination without dissolution of a session of parliament by discontinuing the meetings until the next session. The Lat. *prorogatio* (from *prorogare*, to ask publicly) meant a prolongation or continuance of office or command, cf. *prorogatio imperii* (Liv. viii. 26), or a

putting off or deferring of an appointed time, cf. *dies ad solvendum prorogare* (Cic. *Phil.* ii. 10, 24). A prorogation of parliament affects both houses, and thus differs from an "adjournment," which does not terminate the session and is effected by each house separately by resolution. Further, at a prorogation, a bill which has not passed all of its stages must begin again *ab initio* in the next session, and all proceedings, except impeachments and appeals before the House of Lords, are quashed. A prorogation is effected by the sovereign in person, or by commission. If, at the demise of the Crown, parliament stands prorogued or adjourned, it is by 6 Anne c. 7 to sit and act at once; similarly the Crown must by proclamation order parliament to sit, if prorogued, when the militia is embodied or the reserves are called out.

PROSCENIUM (Gr. *προσκήνιον*), that part of the stage in the ancient Greek theatre which lies in front of the *σκηνή*, *scena*, the back wall; the word appears to embrace the whole stage between the *ὀρχήστρα* and the *σκηνή*. In the modern theatre the word is applied to that part of the stage which is in front of the curtain and the orchestra, and sometimes to the whole front of the stage, including the curtain and the arch containing it, which separates the stage from the auditorium.

PROSE, a word supposed to be derived from the Lat. *prorsus*, direct or straight, and signifying the plain speech of mankind, when written, or rhetorically composed, without reference to the rules of verse. It has been usual to distinguish prose very definitely from poetry (*q.v.*), and this was an early opinion. Ronsard said that his training as a poet had proved to him that prose and poetry were "mortal enemies." But "poetry" is a more or less metaphysical term, which cannot be used without danger as a distinctive one in this sense. For instance, an ill-inspired work in rhyme, or even a well-written metrical composition of a satirical or didactic kind, cannot be said to be poetry, and yet most certainly is not prose; it is a specimen of verse. On the other hand, a work of highly wrought and elaborately sustained non-metrical writing is often called a prose-poem. The fact that this phrase can be employed shows that the antithesis between prose and poetry is not complete, for no one, even in jest or hyperbole, speaks of a prose-verse.

Prose, therefore, is most safely defined as comprising all forms of careful literary expression which are not metrically versified, and hence the definition from *prorsus*, the notion being that all verse is in its nature so far artificial that it is subjected to definite and recognized rules, by which it is diverted out of the perfectly direct modes of speech. Prose, on the other hand, is straight and plain, not an artistic product, but used for stating precisely that which is true in reason or fact. The Latins called prose *sermo pedestris*, and later *oratio soluta*, thus showing their consciousness that it was not poetry, which soars on wings, and not verse, which is bound by the rules of prosodical confinement.

Prose, however, is not everything that is loosely said. It has its rules and requirements. In the earliest ages, no doubt, conversation did not exist. The rudest fragments of speech were sufficient to indicate the needs of the savage, and these blunt babblings were not prose. Later on some orator, dowered with a native persuasiveness, and desirous of making an effect upon his comrades, would link together some broken sentences, and in his heat produce with them something more coherent than a chain of ejaculations. So far as this was lucid and dignified, this would be the beginning of prose. It cannot be too often said that prose is the result of conversation, but it must at the same time be insisted upon that conversation itself is not necessarily, nor often, prose. Prose is not the negation of all laws of speech; it rejects merely those laws which depend upon metre. What the laws are upon which it does depend are not easy to enumerate or define. But this much is plain; as prose depends on the linking of successive sentences, the first requirement of it is that these sentences should be so arranged as to ensure lucidity and directness. In prose, that the meaning should be given is the primal necessity. But as it is found that a dull and clumsy, and especially a monotonous arrangement, of sentences is fatal to the attention of the listener or reader, it is

needful that to plainness should be added various attractions and ornaments. The sentences must be built up in a manner which displays variety and flexibility. It is highly desirable that there should be a harmony, and even a rhythm, in the progress of style, care being always taken that this rhythm and this harmony are not those of verse, or recognizably metrical. Again, the colour and form of adjectives, and their sufficient yet not excessive recurrence, is an important factor in the construction of prose. The omission of certain faults, too, is essential. In every language grammatical correctness is obligatory. Here we see a distinction between mere conversation, which is loose, fragmentary and often, even in the lips of highly educated persons, slightly ungrammatical; and prose, which is bound to weed away whatever is slovenly and incorrect, and to watch very closely lest merely colloquial expressions, which cannot be defended, should slip into careful speech. What is required in good prose is a moderate and reasonable elevation without bombast or bathos. Not everything that is loosely said or vaguely thought is prose, and the celebrated phrase of M. Jourdain in Molière's *Bourgeois gentilhomme*: "Par ma foi, il y a plus de quarante ans que je dis de la prose, sans que j'en susse rien," is not exactly true, although it is an amusing illustration of the truth, for all the little loose phrases which M. Jourdain had used in his life, though they were certainly not verse, were not prose either, whatever the schoolmaster might say. On the other hand, it seems that Earle goes too enthusiastically in the contrary direction when he says, "Poetry, which is the organ of Imagination, is futile without the support of Reason; Prose, which is the organ of Reason, has no vivacity or beauty or artistic value but with the favour and sympathy of the Imagination." It is better to hold to the simpler view that prose is literary expression not subjected to any species of metrical law.

Greece.—The beginnings of ancient Greek prose are very obscure. It is highly probable that they took the form of inscriptions in temples and upon monuments, and gradually developed into historical and topographical records, preserving local memories, and giving form to local legends. It seems that it was in Ionia that the art of prose was first cultivated, and a history of Miletus, composed by the half-mythical Cadmus, is appealed to as the earliest monument of Greek prose. This, however, is lost, and so are all the other *horoï* of earliest times. We come down to something definite when we reach Hecataeus, the first geographer, and Herodorus, the first natural philosopher, of the Greeks; and, although the writings of these men have disappeared, we know enough about them to see that by the 4th century B.C. the use of prose in its set modern sense had been established on a permanent basis. We even know what the character of the style of Hecataeus was, and that it was admired for its clearness, its grammatical purity, its agreeable individuality—qualities which have been valued in prose ever since. These writers were promptly succeeded by Hellanicus of Lesbos, who wrote many historical books which are lost, and by Herodotus of Halicarnassus, whose noble storehouse of chronicle and legend is the earliest monument of European prose which has come down to us. When once non-metrical language could be used with the mastery and freedom of Herodotus, it was plain that all departments of human knowledge were open to its exercise. But it is still in Ionia and the Asiatic islands that we find it cultivated by philosophers, critics and men of science. The earliest of these great masters of prose survive, not in their works, but in much later records of their opinions; in philosophy the actual writings of Thales, Anaximander, Pythagoras and Empedocles are lost, and it is more than possible that their cosmological rhapsodies were partly metrical, a mingling of ode with prose apophthegm. We come into clearer air when we cross the Aegean and reach the Athenian historians: Thucydides, whose priceless story of the Peloponnesian War has most fortunately come down to us; and Xenophon, who continued that chronicle in the spirit and under the influence of Thucydides, and who carried Greek prose to a great height of easy distinction. But it is with the practice of philosophy that prose in ancient Greece rises to its acme of ingenuity, flexibility and variety,

proving itself a vehicle for the finest human thought such as no later ingenuity of language has contrived to excel. The death of Socrates (399 B.C.) has been taken by scholars as the date when the philosophical writings of the Athenians reached their highest pitch of perfection in the art of Plato, who is the greatest prose writer of Greece, and, in the view of many who are well qualified to judge, of the world. In his celebrated dialogues—*Crito*, *Gorgias*, *Phaedo*, *Phaedrus*, the *Symposium*, most of all perhaps in the *Republic*—we see what splendour, what elasticity, what exactitude, this means of expression had in so short a time developed; how little there was for future prose-writers in any age to learn about their business. The rhetoricians were even more highly admired by the critics of antiquity than the philosophers, and it is probable that ancient opinion would have set Demosthenes higher than Plato as a composer of prose. But modern readers are no longer so much interested in the technique of rhetoric, and, although no less an authority than Professor Gilbert Murray has declared the essay-writing of the school of Isocrates to form "the final perfection of ancient prose," the works of the orators cease to move us with great enthusiasm. In Aristotle we see the conscious art of prose-writing already subordinated to the preservation and explanation of facts, and after Aristotle's day there is little to record in a hasty outline of the progress of Greek prose.

Latin.—In spite of having the experience of the Greeks to guide them, the Romans obeyed the universal law of literary history by cultivating verse long before they essayed the writing of prose. But that the example of later Greece was closely followed in Rome is proved by the fact that the earliest prose historians of whom we have definite knowledge, Q. F. Pictor and L. C. Alimetus, actually wrote in Greek. The earliest annalist who wrote in Latin was L. C. Hemina; the works of all these early historians are lost. A great deal of primitive Roman prose was occupied with jurisprudence and political oratory. By universal consent the first master of Latin prose was Cato, the loss of whose speeches and "Origines" is extremely to be deplored; we possess from his pen one practical treatise on agriculture. In the next generation we are told that the literary perfection of oratory was carried to the highest point by Marcus Antonius and Lucius Licinius Crassus—"by a happy chance their styles were exactly complementary to one another, and to hear both in one day was the highest intellectual entertainment which Rome afforded." Unfortunately none but inconsiderable fragments survive to display to us the qualities of Roman prose in its golden age. Happily, however, those qualities were concentrated in a man of the highest genius, whose best writings have come down to us; this is Cicero, whose prose exhibits the Latin language to no less advantage than Plato's does the Greek. From 70 to 60 B.C. Cicero's literary work lay mainly in the field of rhetoric; after his exile the splendour of his oratory declined, but he was occupied upon two treatises of extreme importance, the *De oratore* and the *De republica*, composed in 55 and 54-57 B.C. respectively; of the latter certain magnificent passages have been preserved. The beautiful essays of Cicero's old age are more completely known to us, and they comprise two of the masterpieces of the prose of the world, the *De amicitia* and *De senectute* (45 B.C.). It is to the collection of the wonderful private letters of Cicero, published some years after his death by Atticus and Tiro, that we owe our intimate knowledge of the age in which he lived, and these have ever since and in every language been held the models of epistolary prose. Of Cicero's greatest contemporary, Julius Caesar, much less has been preserved, and this is unfortunate because Roman critical opinion placed Caesar at the head of those who wrote Latin prose with purity and perfection. His letters, his grammars, his works of science, his speeches are lost, but we retain his famous *Commentaries on the War in Gaul*. Sallust followed Caesar as an historian, and Thucydides as a master of style. His use of prose, as we trace it in the *Jugurtha* and the *Catilina*, is hard, clear and polished. The chroniclers who succeeded Sallust neglected these qualities, and Latin prose, as the Augustan age began, became more diffuse and more rhetorical.

But it was wielded in that age by one writer of the highest genius, the historian Titus Livius. He greatly enriched the tissue of Latin prose with ornament which hitherto had been confined to poetry; this enables him, in the course of his vast annals, "to advance without flagging through the long and intricate narrative where a simpler diction must necessarily have grown monotonous" (Mackail). The periodic structure of Latin prose, which had been developed by Cicero, was carried by Livy "to an even greater complexity." The style of Pollio, who wrote a *History of the Civil Laws*, was much admired, and the loss of this work must be deplored. A different species of prose, the *plebius sermo*, or colloquial speech of the poor, is partly preserved in the invaluable fragments of a Neronian writer, Petronius Arbiter. Of the Latin prose-writers of the silver age, the elder Pliny, Quintilian and Tacitus, who adorned the last years before the decay of classical Latin, nothing need here be said.

English.—It was long supposed that the conscious use of prose in the English language was a comparatively recent thing, dating back at farthest to the middle of the 16th century, and due directly to French influences. Earle was the first to show that this was not the case, and to assert that we "possess a longer pedigree of prose literature than any other country in Europe." Though this may be held to be a somewhat violent statement, the independence of English prose is a fact which rests on a firm basis. "The Code of Laws of King's Inn" dates from the 7th century, and there are various other legal documents which may be hardly literature in themselves, but which are worded in a way that seems to denote the existence of a literary tradition. After the Danish invasion, Latin ceased to be the universal language of the educated, and translations into the vernacular began to be required. In 887, Alfred, who had collected the principal scholars of England around him, wrote with their help, in English, his *Hand-Book*; this, probably the earliest specimen of finished English prose, is unhappily lost. Alfred's preface to the English version of the *Cura pastoralis* was in Latin; this translation was probably completed in 890. Later still Alfred produced various translations from Bede, Orosius, Boethius and other classics of the latest Latin, and, in 900, closing a translation from St Augustine, we read "Here end the sayings of King Alfred." The prose of Alfred is simple, straightforward and clear, without any pretension to elegance. He had no direct followers until the time of the monastic revival, when the first name of eminence which we encounter is that of Ælfric, who, about 997, began to translate, or rather to paraphrase, certain portions of the Bible. The prose of Ælfric, however, though extremely interesting historically, has the fault that it presents too close a resemblance, in structure and movement, to the alliterative verse of the age. This is particularly true of his *Homilies*. A little later vigorous prose was put forth by Wulfstan, archbishop of York, who died in 1023. At the Norman Conquest, the progress of English prose was violently checked, and, as has been acutely said, it "was just kept alive, but only like a man in catalepsy." The *Annals* of Winchester, Worcester and Peterborough were carried on in English until 1154, when they were resumed in Latin; the chronicle which thus came to an end was the most important document in English prose written before the Norman Conquest. Except in a few remote monasteries, English now ceased to be used, even for religious purposes, and the literature became exclusively Latin or French. There was nothing in prose that was analogous to the revival of verse in the *Ormulum* or the metrical chronicles. All the pre-Norman practice in prose belongs to what used to be distinguished as Anglo-Saxon literature. The distinction has fallen into desuetude, as it has become more clearly perceived that there is no real break between the earlier and the later language. The Norman check, however, makes it fair to say that modern English prose begins with the *Testament of Love* of Thomas Usk, an imitation of the *De consolatione* of Boethius, which a certain London Lollard wrote in prison about 1584. About the same time were written a number of translations, *The Tale of Melibee* and *The Parson's Sermon* by Chaucer; the treatises

of John of Trevisa, whose style in the *Polychronicon* has a good deal of vigour; and the three versions of the *Travels of Jean à Barbe*, formerly attributed to a fabulous "Sir John Mandeville." The composite text of these last-mentioned versions really forms the earliest specimen of purely secular prose which can be said to possess genuine literary value, but again the fact, which has only lately been ascertained, that "Sir John Mandeville" was not an original English writer robs it of much of its value. The anonymous compiler-translator can no longer be styled "the father of English prose." That name seems more properly to belong to John Wyclif, who, in the course of his fierce career as a controversialist, more and more completely abandoned Latin for English as the vehicle of his tracts. The earliest English Bible was begun by Nicholas Hereford, who had carried it up to Baruch, when he abruptly dropped it in June 1382. The completion of this great work is usually attributed, but on insufficient grounds, to Wyclif himself. A new version was almost immediately started by John Purvey, another Wyclifite, who completed it in 1388. We are still among translators, but towards the middle of the 14th century Englishmen began, somewhat timidly, to use prose as the vehicle for original work. Capgrave, an Augustinian friar, wrote a chronicle of English history down to 1417; Sir John Fortescue, the eminent constitutional jurist, produced about 1475 a book on *The Governance of England*; and Reginald Pecock, bishop of Chichester, attacked the Lollards in his *Repressor of Over Much Blaming of the Clergy* (1455), which was so caustic and scandalous that it cost him his diocese. The prose of Pecock is sometimes strangely modern, and to judge what the ordinary English prose familiarly in use in the 15th century was it is more useful to turn to *The Paston Letters*. The introduction of printing into England is coeval with a sudden development of English prose, a marvellous example of which is to be seen in Caxton's 1485 edition of Sir Thomas Malory's *Morte d'Arthur*, a compilation from French sources, in which the capacities of the English language for melody and noble sweetness were for the first time displayed, although much was yet lacking in strength and conciseness. Caxton himself, Lord Berners and Lord Rivers, added an element of literary merit to their useful translations. The earliest modern historian was Robert Fabyan, whose posthumous *Chronicles* were printed in 1515. Edward Hall was a better writer, whose *Noble Families of Lancaster and York* had the honour of being studied by Shakespeare. With the advent of the Renaissance to England, prose was heightened and made more colloquial. Sir Thomas More's *Richard III.* was a work of considerable importance; his finer *Utopia* (1516) was unfortunately composed in Latin, which still held its own as a dangerous rival to the vernacular in prose. In his *Governor* (1531) Sir Thomas Elyot added moral philosophy to the gradually widening range of subjects which were thought proper for English prose. In the same year Tyndale began his famous version of the Bible, the story of which forms one of the most romantic episodes in the chronicles of literature; at Tyndale's death in 1536 the work was taken up by Miles Coverdale. The *Sermons* of Latimer (1549) introduced elements of humour, dash and vigour which had before been foreign to the stately but sluggish prose of England. The earliest biography, a book in many ways marvellously modern, was the *Life of Cardinal Wolsey*, by George Cavendish, written about 1557, but not printed (even in part) until 1641. In the closing scenes of this memorable book, which describe what Cavendish had personally experienced, we may say that the perfection of easy English style is reached for the first time. The prose of the middle of the 16th century—as we see it exemplified in the earliest English critic, Sir Thomas Wilson; the earliest English pedagogue, Roger Ascham; the distinguished humanist, Sir John Cheke—is clear, unadorned and firm, these Englishmen holding themselves bound to resist the influences coming to them from Italy and Spain, influences which were in favour of elaborate verbiage and tortured construction. Equal simplicity marked such writers as Foxe, Stow and Holinshed, who had definite information to purvey, and wished a straightforward prose in which to present it. But Hoby and North, who

translated Guevara, Castiglione and Amyot, brought with them not a few of the ingenious exotic graces of those originals, and prepared the way for the startling innovations of Lyly in his famous didactic romance of *Euphues* (1579). The extravagances and eccentricities of Lyly outdid those of his continental prototypes, and euphuism became a disturbing influence which, it may be, English prose has not, even to the present hour, entirely succeeded in throwing off. In spite of its overwhelming popularity, it was opposed in its own day, not merely by the stately sobriety of Hooker, in whom we see Latin models predominant, but by the sweetness of Sir Philip Sidney in his *Arcadia*. Raleigh wrote English prose that was perhaps more majestic than any which preceded it, but he revelled in length of sentence and in ponderosity of phrase, so that it is probable that the vast prestige of *The History of the World* on the whole delayed the emancipation of English prose more than it furthered it. The direct influence of the euphuistic eccentricity was seen for some time in the work of poets like Lodge and Greene, and divines like Lancelot Andrewes; its indirect influence in the floweriness and violence of most careful prose down to the Restoration. Bacon, whose contempt of the vernacular is with difficulty to be excused, despaired too early of our national writing. Donne cultivated a rolling and sonorous majesty of style; and Burton could use English with humour and vivacity when he gave himself the chance, but his text is a prototype of the vicious abuse of quotation which was a crowning fault of prose in the early 17th century. In spite of the skill with which, during the civil wars and the Commonwealth, certain authors (such as Jeremy Taylor, Howell, Fuller, Milton, Izaak Walton) manipulated prose, and in spite of the extraordinary magnificence of the Ciceronian periods of Sir Thomas Browne, it was not until shortly before the Restoration that English prose reached its perfection. According to Dr Johnson, Sir William Temple (1628-1699) "was the first writer who gave cadence to English prose; before his time they were careless of arrangement, and did not mind whether a sentence ended with an important word or an insignificant word, or with what part of speech it concluded." The tendency was all in favour of brevity and crispness, and in particular of shorter sentences and easier constructions. Not a little of the majesty of the earlier age was lost; but for practical purposes, and in the hands of ordinary men, prose became a far more useful and businesslike implement than it had hitherto been. The short treatises of Halifax, if we compare them with similar writings of a generation earlier, display the complete change of style; or we may contrast the clear and sarcastic sentences of South with the undulating quaintness of Joseph Hall. The range of English speech was first comprehended perhaps by Dryden, who combined dignity and even pomp of movement with an ease and laxity at occasion which gave variety to prose, removed from it its stilted and too prelatial elevation at inappropriate moments, and approximated it to the ordinary speech of cultivated persons. This then may be called the foundation of modern English prose, which has extended into no departments not recognized, at least in essence, by Bunyan, Dryden and Temple. The ensuing varieties of prose have been mainly matters of style. In the 18th century, for instance, there was a constant alternation between a quiet, rather cold elegance and precision of prose-writing, which was called the Addisonian manner, and a swelling, latinized style, full of large words and weighty periods, in which Johnson was the most famous but Gibbon perhaps the most characteristic proficient. But as far as grammatical arrangement and the rules of syntax are concerned, it cannot be said that English prose has altered essentially since about 1680. It is, however, to be noted that in the course of the 19th century the use of short sentences, and the habit of neglecting to group them into paragraphs, introduced a heresy not known before; and that, on the other hand, there has been a successful attempt made to restore the beauty and variety of early 17th-century diction, which had suffered a long decline from the Restoration onwards.

Icelandic.—The independent invention of prose by the exiled

aristocrats in the Heroic Age of Iceland is one of the most singular facts in literary history. It resulted from the fact that story-telling grew to be a recognized form of amusement in the isolated and refined life of an Icelandic household from the 9th to the 11th century. Something of the same kind had existed in the courts of Norway before the exodus, but it was in Iceland that it was reduced to an art and reached perfection. It is remarkable how suddenly the saga, as a composition, became a finished work; it was written in a prose which immediately presented, in the best examples, "a considerable choice of words, a richness of alliteration and a delicate use of syntax" (Vigfusson). The deliberate composition of sagas began about the year 1030, and it is supposed that they began to be written down soon after 1100. It is distinctly recorded that Ari Fródi (1067-1148) was the first man in Iceland who wrote down stories in the Norse tongue. Many of Ari's books are lost, but enough survive to show what Icelandic prose was in the hands of its earliest artificer, and the impress of his rich and simple style is felt on all the succeeding masterpieces of the great age of Icelandic history and biography. But the Greater Sagas, as they are called, the anonymous stories which followed the work of Ari and were completed in the 13th century, exhibit prose style in its most enchanting fullness, whether in the majesty of *Njala*, in the romantic art of *Laxdaela*, or in the hurrying garrulity of *Eyrbyggja*. There followed a vast abundance of sagas and saga-writers. The great historian, Sturla (1214-1284), is the latest of these classic writers of Iceland, and after his death there was a very rapid decline in the purity and dignity of the national prose. By the opening of the 14th century the art of writing in the old noble language had become entirely lost, and it was not until the 17th century that it began to revive as an archaeological curiosity and a plaything for scholars. "For an Icelander of the present day to write modern history in saga style is a ludicrous absurdity," and the splendid living prose of the 12th century remains unrelated, a strange and unparalleled portent in the history of European literature. Of its beneficial effect on later Scandinavian, English and even Teutonic style there can be no question.

Spain.—In Castilian Spanish, as in the other languages of Europe, verse is already far advanced before we meet with any distinct traces of prose. A didactic treatise for use in the confessional is attributed to a monk of Navarre, writing in the 13th century. Between 1220 and 1250 a chronicle of Toledo was indited. But the earliest prose-writer of whom Spain can really boast is King Alphonso the Learned (1226-1284), in whose encyclopaedic treatises "Castilian makes its first great stride in the direction of exactitude and clearness" (Fitzmaurice-Kelly). Almost all the creditable prose of the end of the 13th century is attributed to Alphonso, who was helped by a sort of committee of subsidiary authors. The king's nephew, Juan Manuel (1282-1347), author of the admirable *Conde Lucanor*, carried prose to a further point in delicacy and precision. The poet Ayala (1332-1407) was another gifted artificer of Spanish prose, which suffered a setback in the hands of his successors, Santillana and Mena. It rose once more in *The Sea of Histories* of Pérez de Guzmán (1378-1460), who has been compared to Plutarch and St Simon, and in whom the lucid and energetic purity of Castilian prose is for the first time seen in its perfection. In the 15th century the shapeless novel of chivalry was predominant, while in the age of Charles V. poetry altogether overshadowed prose. The next great writer of prose whom we meet with is Guevara, who died in 1545, and whose *Dial of Princes* exercised an influence which was not confined to Spanish, and even extended to English prose (in North's well-known version). The historians of this period, prolix and discursive, were of less value. The earliest picaresque novel, *Lazarillo de Tormes* (1554), the authorship of which is unknown, introduced a new form and exhibited Castilian prose style in a much lighter aspect than it had hitherto worn. Still greater elegance is met with in the mystical and critical writings of Juan de Valdés and in those of Luis de León; of the latter Mr Fitzmaurice-Kelly says that "his concise eloquence and his classical purity of expression rank

him among the best masters of Castilian prose." The instrument, accordingly, was polished and sharpened for the finest uses, and was ready to the hand of the supreme magician Cervantes, whose *Don Quixote* was begun a few years (about 1591) after *Los Nombres de Cristo* of Luis de León had been published (1583); these dates are significant in the history of Spanish prose. The prose of Lope de Vega is stately and clear, but of course has little importance in comparison with the verse of his huge theatre. Quevedo's style had the faults which were now invading all European writing, of violent antithesis and obscure ingenuity; but his *Visions* (1627) occupy a prominent place in the history of Castilian prose. The latest struggles of a decadent critical conscience, battling against tortuousness and affectation, are seen in Gracián (1601-1658) and in Molinos (1627-1697), who vainly endeavoured to save classic prose out of the intellectual shipwreck of the 18th century. When Spanish prose revived in the 19th century, in the person of Larra (1809-1837), the influence of French models was found to have deprived it of distinctly national character, while giving it a fresh fluidity and grace.

French.—There had long been a flourishing versified literature in the vernacular of France, before anyone thought of writing French prose. It was the desire to be exact in giving information, together with a reduced sense of the value of rhyme and rhythm, which led to a partial divergence from metre. The translator of the fabulous *Chronicle of Turpin* mentions that he writes in prose "because rhyme entails the addition of words which are not in the Latin." Thus about the year 1200 verse began to be abandoned by chroniclers who had some definite statements to impart, and who had no natural gifts as poets. They ceased to sing; they wrote, more or less easily, as those around them spoke. The earliest French prose was translated from the Latin, but Baldwin VI., who died in 1205, is said to have commissioned several scribes to compile in the vulgar tongue a history of the world. If this was ever written it is lost, but we possess a *Book of Stories* written about 1225 by a clerk at Lille, which may fairly be said to be the start-word of French prose history. When once, however, a taste for prose was admitted, the superiority of that medium over verse as material for exact history could not but be perceived, and prose soon became frequent. The earliest French prose-writer of genius was Geoffroy (or Jofroi) de Villehardouin, who put down memoirs of his life between 1198 and 1207; he left his book, which is known as *The Conquest of Constantinople*, incomplete when he died in 1213. In the history of prose, Villehardouin takes an eminent place. In his admirable style are seen many of the most precious elements of French prose, its lucidity, its force, its sobriety and its charm of address. He had been trained as an orator, and it was his merit that, as M. Langlois has said, he was content to write as he had learned to speak. Villehardouin was closely followed by other admirable writers of memoirs, by Robert of Clari, by Henri of Valenciennes, by the anonymous chronicler of Béthune, to whom we owe the famous description of the battle of Bouvines, and by the Minstrel of Reims. The last-named finished his *Récits* in 1260. These works in the new easy manner of writing were found to be as elegant and as vivacious as any preserved by the old rhetorical art of verse. They led the way directly to the eminent writer who was the earliest historian of modern Europe, to Jean de Joinville, who finished his *Histoire de St Louis* in 1300. A century later Froissart left his famous *Chroniques* unfinished in 1404, and again a hundred years passed before Philippe de Commines dropped the thread of his *Mémoires* in 1511. These are the three most illustrious names in the chronicle of French medieval prose, in whom the various characteristics of the nation are separately developed. It must be noted that these three are simply the most eminent figures in a great cloud of prose-writers, who preserved with more or less vivacity the features of French life in the later middle ages, and helped to facilitate the use of the central national language. In the 15th century, moreover, Antoine de la Salle deserves mention as practically the earliest of French novelists, and one whose skill in the manipulation of

language was long in waiting for a rival among his successors. But with the Renaissance came the infusion into France of the spirit of antiquity, and in Rabelais there was revealed an author of the very highest genius who at once defended the integrity of French syntax and enriched its vocabulary with an infinite multitude of forms. The year 1532, in which the first brief sketch of *Gargantua* appeared, was critical in French literature; for more than twenty years afterwards the structure of the great Pantagruelist romance was still being builded. Meanwhile in 1549 had appeared the *Défense et illustration de la langue française* of Joachim du Bellay, in which the foundations of the learned and brilliant literary criticism of France were firmly laid. The liberation of the language proceeded simultaneously in all directions. In 1539 it was officially decreed that all judicial acts were thenceforward to be written in vernacular prose, "en langage maternel français et non autrement." Calvin led the theologians, and his precise, transparent and sober prose, curiously deficient in colour, gave the model to a long line of sober rhetoricians. It is in the pages of Calvin that we meet for the first time with a simple French prose style, which is easily intelligible by the reader of to-day. There is some affectation of an ornamented pedantry in St François de Sales, some return to the form and spirit of medieval French in Montaigne; so that the prose of these great writers may easily seem to us more antiquated than that of Calvin. Yet the *Institution* belongs at latest to 1560, and the immortal *Essais* at earliest to 1580. We are approaching the moment when there should be nothing left for French prose to learn, and when development should merely take forms of personal brilliancy and initiative of enterprise on lines already clearly laid down. But we pause at Brantôme, in whom the broad practice of French as Froissart and the medieval chroniclers had used it was combined with the modern passion for minute detail and the close observation of the picturesque. Here the habit of memoir-writing in French prose first becomes a passion. With the beginning of the 17th century there sprang up almost an infatuation for making prose uniformly dignified and noble, for draping it in solemn robes, for avoiding all turns of speech which could remind the reader of the "barbarous" origins of the language; the earliest examples of this subjection of eloquence to purely aristocratic forms have been traced back to the *Servitude volontaire* of Montaigne's friend, La Boétie (1530-1563). In the pursuit of this dignity of speech the prose writers of the 16th century ventured to borrow not words merely but grammatical terms and peculiarities of syntax from the ancient literatures of Greece and Rome. The genius of France, however, and the necessity of remaining intelligible checked excess in this tendency, and after a few wild experiments the general result was discovered to be the widening of the capacities of the language, but at the temporary expense of some of the idiomatic richness of the old French form. In the 17th century a great stimulus was given to easy prose by the writers of romances, led by d'Urfé, and by the writers of letters, led by Balzac. In the hands of these authors French prose lost its heaviness and its solemnity; it became an instrument fit to record the sentiments of social life in an elegant balance of phrases; here was first discovered what Voltaire calls the *nombre et harmonie de la prose*. French style became capable of more than this, it achieved the noblest and the subtlest expressions of human and divine philosophy, when it was used by Descartes and by Pascal to interpret their majestic thoughts to the world. At this moment of national development, in 1637, the French Academy was founded, for the distinct purpose of purifying, embellishing and enlarging the French language; and in process of time, out of the midst of the academy, and as a primary result of its labours, arose the extremely important *Remarques* (1647) of Vaugelas, a work of grave authority, which was the earliest elaborate treatise on the science of prose in any language. Antiquated as the method of Vaugelas now seems, and little regarded in detail by modern writers, it may be said that his famous book is still the basis of all authority on the subject of French prose. In common with his colleagues of the hour, Vaugelas strove to lay down laws by which harmony of structure,

a graceful sobriety, lucidity and exactitude of expression, could be secured to every practised French writer. He was not accepted as an infallible lawgiver, even in his own age; he was immediately exposed to the searching criticism of La Mothe le Vayer, who, however, was radically at one with him regarding the basis of his definition. The great demerit of the early academicians was that they knew little and cared less about the forms of medieval French. They thrust everything aside which they regarded as barbarous, and the work of the 19th century was to recover from a past behind Rabelais elements of great value which the 17th had arbitrarily rejected as "incorrect." In the succeeding centuries there has been a vast extension of the practice of French prose into every conceivable department of experience and observation, but in spite of all neologisms, and in spite of the waves of preciosity which have periodically swept over the French language in the three hundred years which divide the age of Somaize from that of Mallarmé, the treatise of Vaugelas remains the final code in which the laws that govern French prose are preserved.

Italy.—The case of prose in the Italian language has this unique feature that, instead of gathering form obscurely and slowly, it came into sudden existence at the will of one of the greatest of writers. Latin had almost universally been used in Italy until the close of the 13th century, when Dante created a vernacular prose in the non-metrical part of his famous *Vita Nuova*, written about 1293. For a long time the prose of Dante stood practically alone, and Petrarch actually affected to despise the works which his great predecessor had written in the vulgar tongue. But about 1348 Boccaccio started the composition of his *Decameron*, which gave classic form to the prose romance of Italy. There had been stories in the vernacular before, and Boccaccio himself had written the *Filocolo* and the *Amato*, but the *Decameron* marked the lines upon which easy and graceful Italian prose was to move for the future. It should have been greatly to the advantage of Italy over the other countries of Europe, that in the hands of Dante and Boccaccio prose was born full-grown, and had not to pass through the tedious periods of uncertain development which awaited it in England, France and Spain. After this brilliant beginning, however, there was a decline in the 15th century, the writers of the next age lacking the courage to be independent of antiquity. There was a return to Latin phraseology which made many works almost macaronic in character; the famous *Hypnerotomachia* of Colonna is an instance of this. Something of the purity of Italian prose as Boccaccio had left it was recovered by Sannazaro in his *Arcadia* (1489) a pseudo-classical pastoral romance, the form of which was widely imitated throughout Europe; even Sannazaro, however, did not see how needful it was to cast off Latin constructions. At length a pair of historians, Machiavelli and Guicciardini, succeeded in releasing prose from the yoke of Rome, and in writing undiluted Tuscan. In the 16th century the prose writers of Italy became extremely prolific, with Pietro Bembo at their head. The novelists were now prominent, but, although they take a foremost place in the history of Italian literature, there was little art in their employment of language. Many of them were born out of Tuscany, and, like Bandello, never learned the exact rules of pure Italian prose. Since the 16th century Italian would seem to have undergone no radical changes as a language, and its prose has been stationary in form. At the close of the 19th century a new school of writers, with Gabriele d'Annunzio at its head, created a demand for a new prose, but it is significant that the remedy suggested by these innovators was neither more nor less than a return to the procedure of Boccaccio and Machiavelli, who remain the types of ease and dignity in Italian prose.

German.—The earliest coherent attempts at the creation of German prose belong to the age of Charlemagne, and the first example usually quoted is the *Strassburger Eidschwüre* of 842. For all literary purposes, however, metrical language was used exclusively during the *mittelhochdeutsch* period, which lasted until the end of the 13th century. What little 'prose' there was, was limited to jurisprudence and theology. David of Augsburg,

who died in 1272, is named as the earliest preacher in the vernacular, but only one of his sermons has come down to us. More important was Berthold "the Sweet" (1220-1272), whose sermons were discovered by Neander and published in 1824. Historical prose began with the Saxon Chronicle of 1248. There was little to record in the next two centuries, until prose was revived by Geiler von Kaisersburg (1445-1510) in his sermons. About the same time translations were made of the *Decameron* and of other Italian collections of novels. The development of prose in Germany is, however, negligible until we reach the Reformation, and it is Luther's Bible (New Testament, 1522), on which all classic German prose is based. This movement is due to Luther alone, since the other protagonists of reform wrote mainly in Latin. Johann Fischart composed important secular books in the vernacular, in particular the *Bienenkorb* (1579) and an imitation of *Gargantua* (1575), which is the earliest German novel. But nearly a century passes before we reach another prose work of real importance in the German vernacular, this being the curious picaresque romance of *Simplicissimus* (1669) of Grimmelshausen. But the neglect of prose by the German nation was still general, and is exemplified in the way by which men of the stamp of Leibnitz wrote in Latin and even in French, rather than in their own "barbarous" tongue. What Luther had done at the beginning of the 16th century was, however, completed and confirmed in the middle of the 18th by Lessing, who must be considered as the creator of modern German prose. The critical period in this revival was 1764 to 1768, which saw the production of *Laocoon* and the *Hamburgische Dramaturgie*. We pass on presently to Jean Paul Richter, and so to Goethe, in whose majestic hands German prose became the organ of thought and eloquence which it has been ever since.

AUTHORITIES.—John Earle, *English Prose* (London, 1890); C. Favre de Vaugelas, *Remarques sur la langue française* (Paris, 1647). *Nouvelles remarques* (Paris, 1690); T. Mundt, *Kunst der deutschen Prosa* (Berlin, 1837); J. W. Mackail, *Latin Literature* (London, 1895); James Fitzmaurice-Kelly, *History of Spanish Literature* (London, 1898); G. Vigfusson, various Prolegomena. (E. G.)

PROSECUTION, the procedure by which the law is put in motion to bring an accused person to trial (see CRIMINAL LAW; INDICTMENT; SUMMARY JURISDICTION, and TRIAL). In theory in the United Kingdom the king is in all criminal offences the prosecutor, because such offences are said to be against his peace, his crown and dignity, but in practice such prosecutions are ordinarily undertaken by the individuals who have suffered from the crime. This is a different procedure from that prevailing in Scotland, European continental countries and the United States, in all of which a public department or officer undertakes the prosecution of offences. A step towards public prosecution was taken in England by the Prosecution of Offences Act (1879), under which an officer called the "Director of Public Prosecutions" was appointed; in 1884 the Prosecution of Offences Act of that year revoked the appointment made under the act of 1879, and constituted the solicitor to the Treasury Director of Public Prosecutions. The Prosecution of Offences Act (1908) separated the two offices again, making the public prosecutor independent of the treasury, but putting him under the control of the Home Office. The duty of the public prosecutor is to institute, undertake or carry on criminal proceedings in any court and to give advice and assistance to persons concerned in such proceedings. The appointment of such an officer, according to the act of 1908, does not preclude any person from instituting or carrying on criminal proceedings, but the public prosecutor may at any stage undertake the conduct of these proceedings if he thinks fit (s. 2, par. 3).

A person to be qualified for the post of public prosecutor must be a barrister or solicitor of not less than ten years' standing, and an assistant public prosecutor, who may be appointed under the act of 1908 and who is empowered to do any act or thing which the public prosecutor is required or authorized to do, must be a barrister or solicitor of not less than seven years' standing. See also LORD ADVOCATE.

PROSELYTE (Gr. προσήλυτος), strictly one that has arrived (= Lat. *advena*), a stranger or sojourner, a term now practically restricted to converts from one religion to another. It

was originally so used of converts to Judaism, but any one who sets out to convert others to his own opinions is said to "proselytize." The word is commonly used in the Alexandrian Greek translation of the Old Testament (Septuagint) for the Hebrew word (*ger*) which is derived from a root (*gur*) denoting to sojourn. The English versions often render the word by "stranger;" but though distinguished from the home-born 'ezrah (=one rising from the soil), the person denominated *ger* became the equal of the native Israelite, and, when the meaning of *ger* passed from a mainly civil to a religious connotation, enjoyed many rights. Like the Arabic *jar* (which is philologically cognate to *ger*), the *ger* attached himself as a client to an individual or as a protected settler to the community. He shared in the Sabbath rest (Exod. xx. 10), and was liable to the same duties and privileges as Israel (see references in Oxford *Gesenius*, p. 158). The Hebrew word later came to mean what we now understand by proselyte, a term which appears in the sense of convert to Judaism in the New Testament (Matt. xxiii. 15; Acts ii. 10).

The Rabbinic law recognized two classes: (a) the full proselyte, the stranger of righteousness (*ger sedeq*), who was admitted after circumcision, baptism and the offering of a sacrifice (after the destruction of the Temple the first two ceremonies were alone possible); and (b) the limited proselyte, the resident alien (*ger tashab*) or proselyte of the gate (*ger ha-sha'ar*), who, without accepting Judaism, renounced idolatry and accepted Jewish jurisdiction, thereby acquiring limited citizenship in Palestine. Some authorities think that the "God-fearers" of some of the Psalms and of the New Testament were these limited proselytes. The Hebrew and Greek terms, however, lost the connotation of a change of residence, and both *ger* and "proselyte" came to apply to a convert without regard to his nationality.

At various periods there were proselytes to Judaism. The Maccabaeans used compulsion in some cases, but Judaism in the Diaspora was a missionary religion in the less militant sense. Heathens felt in the religion of Israel an escape from their growing scepticism, and a solution to the problem of life. Josephus testifies that there was much proselytism in Rome (Against Apion, ii. 39), and several Latin writers confirm this (Cicero, *Pro Flacco*, § 28; Juvenal xiv. 96; cf. Reinach, *Textes d'auteurs grecs et romains relatifs au Judaïsme* (1895). The well-known reference in Matt. xxv. 15 supports the view that proselytes were actively sought by the Pharisees, and the famous *Didachē* was probably in the first instance a manual for instructing proselytes in the principles of Judaism. There were, however, varying opinions as to the value to the Jewish body of these accessions. Some rabbis interpreted Israel's dispersion as divinely designed for the very purpose of proselytizing (*Pesahim* 87b.). In the Diaspora admission of converts may have been made easy, circumcision being sometimes omitted, but the conditions became gradually more severe, until they reached their present form. It is thought that the Hadrianic persecution led to this change. The Jews seem to have suffered during the war from the treachery of half-hearted friends. Again, many who had become converts to Judaism afterwards joined the new Christian communities. Moreover, in the middle ages, it was not lawful for the Jews to admit proselytes. Various church councils prohibited it, and the Code of Alfonso X. (1261) made conversion to the synagogue a capital crime. (In 1222 a Christian deacon was executed at Oxford for his apostasy to Judaism: Matthew Paris, ed. Luard, iii. 71.) Again, the pragmatic theory of Judaism, enunciated in Talmudic times, and raised almost to the dignity of a dogma by Maimonides (*On Repentance*, iii. 5, &c.), was that Judaism was not necessary for salvation, for "the pious of all nations have a share in the world to come" (*Tosephta*, Sanh. xiii. 2). If to these causes be added a certain exclusiveness, which refused to meet a would-be convert more than half-way, we find no difficulty in accounting for the reluctance which the medieval and modern synagogue has felt on the subject. Yet willing proselytes to Judaism are still freely received, provided that their bona fides are proven. In some reformed congregations in America proselytes are admitted without circumcision, and a similar policy is proposed (not yet adopted) by the Jewish Religious Union in London, though the male children of proselytes are to be required to undergo the rite. In 1896 the central conference of American Rabbis formulated as a proselyte Confession of faith these five principles: (1) God the Only One; (2) Man His Image; (3) Immortality of the Soul; (4) Retribution; and (5) Israel's Mission. Most cases of conversion to Judaism at the present time are for purposes of marriage, and female proselytes are more numerous than male. Female proselytes are admitted after the total immersion in a ritual bath, though in some Reformed congregations this rite is omitted. Proselytes are

still not allowed, in Orthodox circles, to become the wives of reputed descendants of the priestly families, but otherwise marriage with proselytes is altogether equal to marriage between born Jews.

See Schürer, *Geschichte des jüdischen Volkes*, ed. 3, iii. 102-135, Bertholet, *Die Stellung der Israeliten und der Juden zu den Fremden*, 179-349; articles in *Ency. Bib.*, *Hastings's Dict. Bib.* and the *Jewish Ency.* For the Jewish law of the admission of proselytes, see *Shulhan 'Aruch*, Yore Deah, § 268. (I. A.)

PROSERPINE (*Proserpina*), the Latin form of Persephone,¹ a Greek goddess, daughter of Zeus and the earth-goddess Demeter. In Greek mythology Demeter and Proserpine were closely associated, being known together as the two goddesses, the venerable or august goddesses, sometimes as the great goddesses. Proserpine herself was commonly known as the daughter (Core), sometimes as the first-born. As she was gathering flowers with her playmates in a meadow, the earth opened and Pluto, god of the dead, appeared and carried her off to be his queen in the world below.² This legend was localized in various places, as at Eleusis, Lerna, and "that fair field of Enna" in Sicily. Torch in hand, her sorrowing mother sought her through the wide world, and finding her not she forbade the earth to put forth its increase. So all that year not a blade of corn grew on the earth, and men would have died of hunger if Zeus had not persuaded Pluto to let Proserpine go. But before he let her go Pluto made her eat the seed of a pomegranate, and thus she could not stay away from him for ever.³ So it was arranged that she should spend two-thirds (according to later authors, one-half) of every year with her mother and the heavenly gods, and should pass the rest of the year with Pluto beneath the earth.⁴ There can be little doubt that this is a mythological expression for the growth of vegetation in spring and its disappearance in autumn. According to Theopompus there was a Western people who actually called the spring Proserpine. As wife of Pluto, she sent spectres, ruled the ghosts, and carried into effect the curses of men. The lake of Avernus, as an entrance to the infernal regions, was sacred to her. From the head of a dying person Proserpine was supposed to cut a lock of hair which had been kept sacred and unshorn through life.⁵ She was sometimes identified with Hecate. On the other hand in her character of goddess of the spring she was honoured with flower-festivals in Sicily and at Hipponium in Italy. Sicily was a favourite haunt of the two

¹ Some, however, regard *Proserpina* as a native Latin form, not borrowed from the Greek, and connected with *proserpere*, meaning the goddess who aided the germination of the seed.

² The story is reminiscent of the old form of marriage by capture.

³ The idea that persons who have made their way to the abode of the dead can return to the upper world if they have not tasted the food of the dead appears elsewhere, as in New Zealand (R. Taylor, *New Zealand*, pp. 233, 271).

⁴ Hymn to Demeter; Ovid, *Fasti*, iv. 419; *Metam.* v. 385.

⁵ *Aen.*, iv. 698 seq. It appears to have been a Greek custom to cut a lock of hair from a dead man's head, and hang it outside of the house door, in token that there was a corpse in the house. At least this seems a fair inference from Eurip. *Alc.*, 75, 76, 101-104. The lock so cut may have been that which was kept sacred to the gods and unshorn (*Elym. Mag.*, s.v. ἀπεσοκλυμμένος). For examples of hair dedicated to gods, see *Il.* xxiii. 141 seq.; *Plut.*, *Thes.* 5; *Paus.* viii. 20, 3. In Tibet a lama (priest) is called in to cut off some hairs from the head of a dying person, in order that his soul may escape through the top of his head, which is deemed an essential condition of a good transmigration (Horace de la Penna, in Bogle and Manning's *Travels in Tibet*, ed. C. R. Markham, 1876). We can hardly doubt that the intention of the Graeco-Roman custom was similar. In modern Greece the god of death, Charos, is supposed to draw the soul out of the body, and if a man resists the Arachnites believe that Charos slits open his breast (B. Schmidt, *Volk-leben der Neugriechen*, 1871, p. 228). There are other instances of incisions made in the body of a dying person to allow his soul to escape (cf. A. Bastian, *Der Mensch in der Geschichte*, 1860, ii. 342). The custom probably dates from the times when death in battle was the usual death. In the legend of Nisus and Scylla there is a trace of the custom which was still observed in classical times in the sacrifice of animals. The practice of cutting off the hair of the dead prevailed in India, though it does not appear in the Vedas (Monier-Williams, *Religious Thought and Life in India*, p. 281). We are reminded of the practice of the Pawnees and other North-American Indians, who shaved the head with the exception of one lock (the scalp-lock), which was removed by a victorious enemy (Catlin, *North American Indians*, ii. 24). The Sandwich Islanders also cut a lock from a slain foe (W. Ellis, *Polynesian Researches*, 1834, iv. 159).

goddesses, and ancient tradition affirmed that the whole island was sacred to them. The Sicilians claimed to be the first on whom Demeter had bestowed the gift of corn, and hence they honoured the two goddesses with many festivals. They celebrated the festival of Demeter when the corn began to shoot, and the descent of Proserpine when it was ripe. At Cyare, a fountain near Syracuse which Pluto made to spring up when he carried off his bride, the Syracusans held an annual festival in the course of which bulls were sacrificed by being drowned in the water. At Cyzicus also, in Asia Minor, bulls were sacrificed to Proserpine. Demeter and Proserpine were worshipped together by the Athenians at the greater and less Eleusinian festivals, held in autumn and spring respectively. In the Eleusinian mysteries Proserpine no doubt played an important part. One Greek writer, Achemachus, identified Proserpine with the Egyptian Isis.¹ At Rome Proserpine was associated with Ceres (the Roman representative of Demeter) in the festival of the Cerealia (April 12 to 19), she was represented as the wife of Dis Pater (the Roman Pluto), and was sometimes identified with the native Latin goddess Libera. The pomegranate was Proserpine's symbol, and the pigeon and cock were sacred to her. Her votaries abstained from the flesh of domestic fowls, fish, beans, pomegranates and apples. In works of art she appears with a cornucopia or with ears of corn and a cock.² The regular form of her name in Greek was Persephone, but various other forms occur: Phersephone, Persephassa, Phersephassa, Pherrephatta, &c., to explain which different etymologies were invented. Corresponding to Proserpine as goddess of the dead is the old Norse goddess *Hel* (Gothic *Halja*), whom Saxo Grammaticus calls Proserpine.

See L. Preller, *Demeter und Persephone* (1837); R. Foerster, *Der Raub und die Rückkehr der Persephone* (1874); A. Zimmermann, *De Proserpine rapta et reditu* (1882); J. A. Overbeck, "Demeter and Kore" in *Griechische Kunstmythologie*, ii. (1878). (J. G. Fr.; X.)

PROSKUROV, or PLOSKUROV, a town of Russia, in the government of Podolia, situated on the railway from Odessa to Lemberg, 62 m. N.W. of Zhmerinka junction. Pop. (1897), 22,915, more than one-half being Jews. It is poorly built, mostly of wood, on a low marshy plain surrounded by hills, at the confluence of the Ploskaya with the Bug. Its old castle has been destroyed, the site being occupied by a Roman Catholic church. The Orthodox Greek cathedral (1839) contains a very ancient and highly venerated image of the Virgin. The manufactures include oil-works and potteries; the Jewish merchants carry on an active export trade in corn and sugar, while the imports consist of salt and manufactured wares. Agriculture and market-gardening are the chief occupations of the Little-Russian inhabitants.

PROSODY (Gr. *προσῳδία*), the art of versification (see VERSE), including as its three divisions accent, breathing and quantity. Prosody is the mode in which the discipline is determined by which successive syllables are so arranged as to form verse. The Latin name for it was *accentus*.

PROSPECTUS (Lat. for view, look-out, prospect, from *prospicere*, to look forward), a written or printed preliminary announcement of some undertaking, giving the scheme or plan, the principal features, &c. In law, the term is specifically applied to the invitation issued to the public by a company to subscribe for shares in the enterprise for which the company is formed (see COMPANY).

PROSPER OF AQUITAINE, or PROSPER TIRO (c. 390–c. 465), Christian writer and disciple of St Augustine, was a native of Aquitaine, and seems to have been educated at Marseilles. In 431 he appeared in Rome to interview Pope Celestine regarding the teachings of St Augustine and then all traces of him are lost until 440, the first year of the pontificate of Leo I., who had been in Gaul and thus probably had met Prosper. In any case Prosper was soon in Rome, attached to the pope in some secretarial or notarial capacity. Gennadius (*De script. eccl.* 85)

¹ Others regarded her as originally a moon-goddess.

² As the wife of Hades she was represented with the insignia of royalty and a torch.

mentions a rumour that Prosper dictated the famous letters of Leo I. against Eutyches. The date of his death is not known, but his chronicle goes as far as 455, and the fact that Ammianus Marcellinus mentions him under the year 463 seems to indicate that his death was shortly after that date. Prosper was a layman, but he threw himself with ardour into the religious controversies of his day, defending Augustine and propagating orthodoxy. The Pelagians were attacked in a glowing polemical poem of about 1000 lines, *Adversus ingratos*, written about 430. The theme, *dogma quod . . . pestifero vomuit coluber sermone Britannus*, is relieved by a treatment not lacking in liveliness and in classical measures. After Augustine's death he wrote three series of Augustinian defences, especially against Vincent of Lerins (*Pro Augustino responsiones*). His chief work was against Cassian's *Collatio*, his *De gratia dei ut libero arbitrio* (432). He also induced Pope Celestine to publish an *Epistola ad episcopos Gallorum* against Cassian. He had earlier opened a correspondence with Augustine, along with his friends Tyro and Hilarius, and although he did not meet him personally his enthusiasm for the great theologian led him to make an abridgment of his commentary on the Psalms, as well as a collection of sentences from his works—probably the first dogmatic compilation of that class in which Peter Lombard's *Liber sententiarum* is the best-known example. He also put into elegiac metre, in 106 epigrams, some of Augustine's theological dicta.

Far more important historically than these is Prosper's *Epitoma chronicon*. It is a careless compilation from St Jerome in the earlier part, and from other writers in the later, but the lack of other sources makes it very valuable for the period from 425 to 455, which is drawn from Prosper's personal experience. There were five different editions, the last of them dating from 455, after the death of Valentinian. For a long time the *Chronicon imperiale* was also attributed to Prosper Tiro, but without the slightest justification. It is entirely independent of the real Prosper, and in parts even shows Pelagian tendencies and sympathies.

The *Chronicon* has been edited by T. Mommsen in the *Chronica minora* of the *Monumenta Germaniae historica* (1892). The complete works are in Migne's *Patrologia latina*. Tome 51. See L. Valentine, *St. Prosper d'Aquitaine* (Paris, 1900), where a complete list of previous writings on Prosper is to be found; also A. Potthast, *Bibliotheca historica* (1896).

PROSSNITZ (Czech *Prostějov*), a town of Austria, in Moravia, 50 m. N.E. of Brünn by rail. Pop. (1900), 24,054, mostly Czech. It is situated in the fertile plain of the Hanna, and is the principal commercial centre for the sale of the various produce of the region. It has important textile, malt and sugar industries, distilling, brewing and milling, manufactures of agricultural implements and lucifer matches. Prossnitz is a town of ancient origin, and in the 16th century was one of the chief seats of the Moravian Brethren.

PROSTITUTION (from Lat. *prostituere*, to expose publicly), a word which may best be defined as promiscuous unchastity for gain. In German law it is described as *Gewerbsmässige Unzucht*. It has always been distinguished in law and custom from concubinage, which is an inferior state of marriage, and from adultery and other irregular sexual relations, in which the motive is passion. Prostitution has existed in all civilized countries from the earliest times, and has always been subject to regulation by law or by custom. In Christian countries attempts have repeatedly been made to suppress it, but without success. Its ultimate basis lies in the two most elementary attributes of living things, namely, the will to live and the instinct of reproduction. The one represents the interest of the individual, the other that of the race; and the essential character of prostitution is that it utilizes the latter to satisfy the former, whereas in true sexual passion, as Schopenhauer has pointed out, the advantage of the individual is subordinated to the needs of the race. In practical language, prostitution offers, through abuse of the sexual instinct, a means of livelihood which a certain proportion of women prefer to other means. It is often assumed by philanthropic moralists that no other means are open to them. That may be so in cases in which deception or constraint

has been used, and adverse circumstances—such as lack of friends and a harsh social code—close the door to other occupations; but to suppose that such cases account for prostitution is to misapprehend the problem. The detailed investigations of various observers and the experience of rescue societies prove that the great majority of prostitutes prefer that means of livelihood to others entailing regular work, discipline and self-control. When they really cease to prefer the life, they leave it voluntarily.¹ Otherwise there is extreme difficulty in reclaiming even the few who will consent to try, and permanent success is only attained with a small proportion of them. The earliest attempt at reclamation met with the same result. It was carried out by the Roman empress Theodora, wife of Justinian, herself a prostitute in early life. She established a home for 500 women on the Bosphorus, but after a time they could not bear the restraint; some threw themselves into the sea, and eventually the scheme was abandoned. The preference is due to several causes, of which indolence is the chief. Prostitutes are drawn mainly from the lower classes; the life offers them an escape from the toil which would otherwise be their lot. Women who present themselves to the police for inscription on the continent of Europe frequently give as their reason for embracing the life, that they do not intend to work any more. Other causes are love of excitement and dislike of restraint. The same qualities make the criminal and the wastrel. In addition, a large proportion have the sexual appetite developed in an abnormal degree. Of 3505 women interrogated by M. Buis in Brussels, 1118 admitted *le goût pour l'homme*. The foregoing are primary causes. External conditions which foster any of these tendencies, or destroy the self-respect and sense of modesty which are their natural antidotes, are secondary causes of prostitution. The more important are: (1) difficulty of finding employment; (2) excessively laborious and ill-paid work; (3) harsh treatment of girls at home; (4) promiscuous and indecent mode of living among the overcrowded poor; (5) the aggregation of people together in large communities and factories, whereby the young are brought into constant contact with demoralized companions; (6) the example of luxury, self-indulgence and loose manners set by the wealthier classes; (7) demoralizing literature and amusements; (8) the arts of profligate men and their agents. Alcohol is often an aid to prostitution, but it can hardly be called a cause, for the practice flourishes even more in the most abstemious than in the most drunken countries. These observations apply to the West. In Oriental countries girls are commonly born into or brought up to the trade, and in that case have no choice.

Among the ancient nations of the East, with the exception of the Jews, prostitution appears to have been connected with religious worship, and to have been not merely tolerated but encouraged. From the Mosaic ordinances and the narrative of the Old Testament it is clear that the separation of the Jews as the chosen people, and the maintenance of their faith, were always felt by Moses and by the later prophets to be chiefly endangered by the vicious attractions of the religious rites practised around them. The code of sexual morality laid down in the Book of Leviticus is prefaced by the injunction not to do after the doings of the land of Egypt, nor after the doings of the land of Canaan, where all the abominations forbidden to the Jews were practised; and whenever the Israelites lapsed from their faith and "went a-whoring after strange gods," the transgression was always associated with licentious conduct. In Egypt, Phoenicia, Assyria, Chaldea, Canaan and Persia, the worship of Isis, Moloch, Baal, Astarte, Mylitta and other deities consisted of the most extravagant sensual orgies, and the temples were merely centres of vice. In Babylon some degree of prostitution appears to have been even compulsory and imposed upon all women in honour of the goddess Mylitta. In India the ancient connexion between religion and prostitution still sur-

¹ The number of those who do so is considerable. In Copenhagen, from 1871 to 1896, 33% of the registered prostitutes were removed from the register by marriage and by returning to their friends. Many women resort to prostitution occasionally in alternation with work.

vives; but that is not the case in China, a most licentious country, and, considering the antiquity of its civilization, and its conservatism, we may perhaps conclude that it formed an exception in this respect among the ancient nations. Among the Jews, who stood apart from the surrounding peoples, the object of the Mosaic law was clearly to preserve the purity of the race and the religion. Prostitution in itself was not forbidden, but it was to be confined to foreign women. Jewish fathers were forbidden to turn their daughters into prostitutes (Lev. xix. 29), and the daughters of Israel were forbidden to become prostitutes (Deut. xxiii. 17), but no penalty was attached to disobedience, except in the case of a priest's daughter, who was to be burnt (Lev. xxi. 9). This distinction is significant of the attitude of Moses, because the heathen "priestesses" were nothing but prostitutes. Similarly, he forbade groves, a common adjunct of heathen temples and a convenient cover for debauchery. Again, his purpose is shown by the severe penalties imposed on adultery (death) and on unchastity in a betrothed damsel (death by stoning), as contrasted with the mild prohibition of prostitution. So long as it did not touch the race or the religion, he tolerated it; and even this degree of disapproval was not maintained, for Jephthah was the son of a harlot² (Judg. xi. 1). There is abundant evidence in the Old Testament that prostitution prevailed extensively in Palestine, even in the earlier and more puritan days. The women were forbidden Jerusalem and places of worship; they infested the waysides, and there is some evidence of a distinctive dress or bearing, which was a marked feature of the trade among the Greeks and Romans. In the later period of aggrandisement that increase of licentious indulgence which Moses had foreseen took place, associated with infidelity. The people plunged into debauchery, the invariable sign of national decadence, which has always accompanied over-prosperity and security, and has always heralded national destruction. Before leaving the Jews, it may be noted as an interesting fact that the remarkable series of ordinances laid down by Moses in the interest of public health contains unmistakable recognition of venereal disease and its contagious character (Lev. xv.).

Passing on to the ancient Greeks, we find prostitution treated at Athens on a new principle. The regulations of Solon were designed to preserve public order and decency. He established houses of prostitution (*dicleria*), which were a state monopoly and confined to certain quarters. The *dicleriaes* were forbidden the superior parts of the town, and were placed under various disabilities. They were compelled to wear a distinctive dress, and, so far from being connected with religion, they were not allowed to take part in religious services. These laws do not seem to have been carried out at all effectually, and were

² Neither "harlot" nor "whore" is the Anglo-Saxon for a prostitute, for which the word is *millestre* (so in Matt. xxi. 31). "Whore" came into English from Scandinavian sources. It was not spelled with the initial *w* till the beginning of the 16th century. The earlier forms are *hore* or *hoore*. The word appears in many Teutonic languages, Dan. *hore*, Swed. *hora*, Du. *hoer*, Ger. *Hure*. The ultimate origin has been taken to be the root meaning "to love," seen in Lat. *carus*, dear. In its earliest usages the word means "adulterer" or "adulteress." It is frequent in the early version of the Bible in the sense of prostitute. "Harlot," possibly, as the *New English Dictionary* points out, as a less offensive word, is frequent in 16th-century versions.

The word "harlot" first appears without its present application and usually of men, in the sense of rogue, vagabond, sometimes even with no evil significance at all, much as we use "fellow." Thus in the prologue to the *Canterbury Tales*, 647, where the "Somonour" is called a "gentil harlot and a kynde." The word came from Fr. *arlot*, masculine, *arlotte*, feminine. Du Cange (*Glossarium*) defines med. Lat. *arlotus*, as *Helluo, ventri deditus*, and gives the Fr. *arlot* as an equivalent, with the meaning *homo nihili, fripon, coquin*. The *Catholicon anglicum* (1483) defines "harlott" as *joculator, jocularitrix, histrio, hystrix*, connecting the word with the wandering players, actors, jugglers, of the day. The ultimate origin of the Romanic word is unknown. Skeat connects it with the Teutonic word, which appears in Ger. *kerl*, Eng. "churl," which means "man," "fellow." Like "bigot" (*q.v.*), the word has been fancifully derived from the name of a person, viz. Arletta or Arlotta, the mother of William the Conqueror (William Lambarde, 1536-1601, *Perambulation of Kent*, pub. 1576).

presently relaxed. After the Persian wars more stringent regulations were again introduced. The *dicterides* were placed under police control, and were liable to prosecution for various offences, such as ruining youths, committing sacrilege and treason against the state. It is clear, however, that as time went on the Athenian authorities experienced the difficulties encountered by modern administrations in carrying out state regulation. There were grades of prostitution, socially though not legally recognized, and women of a superior order were too powerful for the law, which failed to maintain the ban against them. The Greek *hetaerae*, who were prostitutes, not "mistresses," and the most gifted and brilliant members of their class known to history, wielded great and open influence. The test case of Phryne, in which the stern attitude previously maintained by the Areopagus broke down, established their triumph over the law, deprived virtuous women of their sole advantage, and opened the door to general laxity. In later times any one could set up a *dicterion* on payment of the tax. In other Greek cities extreme licence prevailed. At Corinth, which was famous for sensual practices, a temple, with a huge staff of common prostitutes for attendants, was established in honour of Aphrodite and for the accommodation of the sailors frequenting the port. The worship of this goddess became generally debased into an excuse for sexual excesses.

The Romans united the Jewish pride of race with the Greek regard for public decency, and in addition upheld a standard of austerity all their own. In early days female virtue was highly honoured and strenuously maintained among them, of which the institution of the vestal virgins was a visible sign. Their attitude towards prostitution differed, accordingly, from that of other ancient nations. Among them, alone, it was considered disgraceful to a man to frequent the company of prostitutes; and this traditional standard of social conduct, which markedly distinguished them from the Greeks, retained sufficient force down to the later days of the Republic to furnish Cicero with a weapon of rhetorical attack against his political opponents, whom he denounced as *scortatores*. Prostitution was more severely regulated by them than by any other ancient race. They introduced the system of police registration, which is the leading feature of administration in most European countries to-day. From the earliest days of the Republic prostitutes were required to register at the aediles' office, where licences were issued to them on payment of a tax. They were placed under stringent control, had to wear a distinctive dress, dye their hair or wear yellow wigs, and were subject to various civil disabilities; but the severest feature of the system was that, once registered, their names were never erased, and consequently remained for ever under an indelible stain. As in our times, registration became ineffective, and neither law nor tradition could check the demoralizing influence of ease and luxury when once external conquest left the Romans free to devote their energies to the pursuit of pleasure. An attempt was made, by the enactment of severer laws against prostitution, to stem the rising tide of immorality, which threatened to taint the best blood in Rome with the basest elements in the later days of the Republic. Citizens were prohibited from marrying the descendants or relatives of prostitutes, daughters of equestrians were forbidden to become prostitutes, and married women who did so were liable to penalties. More stringent regulations were also imposed on prostitutes themselves, in addition to the old disabilities and police system, which remained in force. If these laws had any effect at all, it was to promote the general prevalence of immorality; they certainly did not diminish prostitution. The profligacy of imperial Rome has never been surpassed for gross and obscene sensuality.

The greatest change introduced by Christianity with regard to prostitution was the adoption of a more charitable attitude towards these social and legal outcasts. The Roman state tax, which had descended to the emperors and had been further regulated under Caligula, was partly given up in the 4th century by Theodosius, on the representations of Florentius, a wealthy patrician, who offered to make good the loss of revenue out of his

own pocket. It was fully and finally abolished by Anastasius I. in the next century, and the old registers were destroyed. Then some of the civil disabilities of prostitutes were removed by Justinian in the 6th century. Gibbon, who never gave credit for a good motive when a base one could be found, attributes Justinian's action solely to his desire to marry Theodora, whose life had been notorious; and no doubt she influenced him in the matter, but it is permissible to assume a good motive. Even Gibbon is constrained to admit her virtue after marriage, and to give her credit for "the most benevolent institution" of Justinian's reign, the rescue home for fallen women in Constantinople, which was at any rate disinterested. Though it did not succeed, it marks a turning-point in the treatment of a class which had never met with public sympathy before. At the same time procuration and connivance were severely punished, which is in keeping with the Christian attitude. The early Christian Church laid great stress on chastity, which probably suggested to its Roman persecutors the horrible punishment of forcibly prostituting Christian maidens. Such malignity enhanced the glory of martyrdom without shaking the constancy of its victims; and the triumph of purity in an age of unbounded licence was conspicuously recognized by Alaric, the Gothic conqueror, who gave strict orders in the sack of Rome that the virtue of Christian women was to be respected. The church, however, was not severe upon prostitutes, to whom the altar was open upon repentance, and some of the fathers explicitly recognized their trade as a necessary evil. Among them was St Augustine, a man of the world, who saw that its suppression would stimulate more destructive forms of immorality. Gradually charity degenerated into patronage. Rome, conquered spiritually by Christianity and materially by the northern barbarians, sapped the virtue of both. Before the middle ages the institutions and ministers of the Church became a by-word for vice. Charlemagne made an effort to suppress the prevailing disorder, but his private life was licentious, and his capitularies, which ordained the scourging of prostitutes and panders, were not inspired by any regard for morality. A period of reform followed. The rise of chivalry, with its lofty idealization of women, and the wave of Christian fervour connected with the Crusades, inspired a vigorous and high-minded campaign against an all-prevalent evil. The Church became exceedingly active in prevention and rescue work, and was assisted by a devout and zealous laity. Rescue missions were organized, convents were founded everywhere for the reception of penitents, and dowries were subscribed to procure them husbands. Fulke de Neuilly was a conspicuous figure in this work. He held missions, preached, and collected large sums for marriage dowries. Pope Innocent III. (1198-1216) pronounced it a praiseworthy act to marry a prostitute; and Gregory IX., a few years later, wrote to Germany that brothel-keepers were not to prevent prostitutes from attending missions, and that clergy and laity who drew profit from prostitution were banned. "Urge bachelors," he wrote, "to marry repentant girls, or induce the latter to enter the cloister." In spite of such efforts, and of occasional spasms of severity by individual rulers, prostitution flourished everywhere throughout the middle ages. It was not merely tolerated, but licensed and regulated by law. In London there was a row of "bordells" (brothels) or "stews" in the Borough near London Bridge. They were originally licensed by the bishops of Winchester, according to John Noorthouck, and subsequently sanctioned by parliament. Stow quotes the regulations enacted in the year 1161, during the reign of Henry II. These were rather protective than repressive, as they settled the rent which women had to pay for the rooms, and forbade their compulsory detention. The act was afterwards confirmed in the reigns of Edward III. and Richard II. In 1383 the bordells belonged to William Walworth, lord mayor of London, who farmed them out, probably on behalf of the Corporation, according to analogy in other parts of Europe. They were closed in 1506, but reopened until 1546, when they were abolished by Henry VIII. In London we get the earliest known regulations directed against the spread of venereal

disease. The act of 1161 forbade the bordell-keepers to have women suffering from the "perilous infirmity of burning"; and by an order of 1430 they were forbidden to admit men suffering from an *infirmilas nefanda*. Probably it was by virtue of this order that in 1439 two keepers were condemned to eleven days' imprisonment and banishment from the city. In 1473, again, it is recorded that bawds and strumpets were severely handled by Lord Mayor Hampton.

Elsewhere in Europe much the same state of things prevailed during the same period. Prostitution was both protected and regulated, and in many places it constituted a source of public revenue. In France prostitutes were distinguished by a badge, and forbidden to wear jewels and fine stuffs and to frequent certain parts of the town. Public brothels on a large scale were established at Toulouse, Avignon and Montpellier. At Toulouse the profits were shared between the city and the university; at Montpellier and Avignon the trade was a municipal monopoly, and farmed out to individuals; at Avignon, where the establishment was kept up during the whole period of the popes' residence, the inmates were subjected to a weekly examination. In 1254 Louis IX. issued an edict exiling prostitutes and brothel-keepers; but it was repealed two years later, though in this and the succeeding century procuration was punished with extreme severity. In some parts of France prostitutes paid a tax to the seigneur. In Germany, according to Fiducin, the public protection of *Lust-Dirnen* was a regular thing in all the large towns during the middle ages. "Frauenhäuser," similar to those in London and in France, existed in many places. They are mentioned in Hamburg in 1292; and from later records it appears that they were built by the corporation, which farmed them. So also in Ulm, where special regulations were issued in 1430. We find them existing at Regensburg in 1306, at Zürich in 1314, at Basel in 1356 and Vienna in 1384. According to Henne-am-Rhyn, admission to these houses was forbidden to married men, clergy and Jews, and on Sundays and saints' days they were closed. The laws of the emperor Frederick II. in the 13th century contain some curious provisions. Any one convicted of a criminal assault on a prostitute against her will was liable to be beheaded; if she made a false accusation she was subject to the same penalty. Any one not going to the assistance of a woman calling for help was liable to a heavy fine. In these ordinances the influence of chivalry may be detected. At the same time prostitutes were forbidden to live among respectable women or go to the baths with them. Hospitality to important guests included placing the public Frauenhäuser at their disposal. So King (afterwards Emperor) Sigismund was treated at Bern in 1414 and at Ulm in 1434, so much to his satisfaction that he publicly complimented his hosts on it. Besides the municipal Frauenhäuser, there were "Winkelhäuser," which were regarded as irregular competitors. In 1492 the licensed women of Nuremberg complained to the mayor of this unfair competition, and in 1508 they received his permission to storm the obnoxious Winkelhaus, which they actually did. In Italy and Spain the system appears to have been very much the same. At Bologna prostitutes had to wear a distinctive dress, in Venice they were forbidden to frequent the wine-shop, and in Ravenna they were compelled to leave a neighbourhood on the complaint of other residents. At Naples a court of prostitutes was established, having jurisdiction over everything connected with prostitution. It led to great abuses, was reformed in 1589, and abolished about a century later.

Such was the state of things in the middle ages. In the 15th and 16th centuries a great change took place. It was due to two very different causes: (1) fear of disease; (2) the Reformation. With regard to the first, there can be little doubt that both the slighter and graver forms of venereal disease existed in very remote times, but until the 15th century they attracted comparatively little attention. The constitutional character of syphilis was certainly not understood—which is by no means surprising, since its pathology has only recently been elucidated (see *VENEREAL DISEASES*)—but one would still have expected to find more notice taken of it by historical, moral and medical

writers in classical and medieval times. Nor is it possible to explain their reticence by prudery, in view of the unbounded literary licence permitted in those ages. One can only conclude that the evil was less widely spread or less virulent than it afterwards became. At the end of the 15th century it attracted so much notice that it was supposed to have originated then *de novo*, or to have been brought from the West Indies by Columbus—both untenable hypotheses; and, as usual, each country accused some other of bringing the contagion within its borders. To speculate on the cause of this increased prevalence would be idle; it is enough to note the fact and its consequences. It was immediately followed by the Reformation, and the two together led to a general campaign against the system of licensed prostitution. The last Frauenhaus was closed in Ulm in 1531, in Basel in 1534 and in Nuremberg in 1562. In London, as already noted, the bordells were abolished in 1546. In Paris an ordinance was issued in 1560 prohibiting these establishments, and later all prostitutes were required to leave the city within twenty-four hours. These instances will suffice to show the general character of the movement. Nor were municipal brothels ever tolerated again. It is observed by Henne-am-Rhyn—no friend of toleration—that their suppression was followed by the appearance of the crime of infanticide, by the establishment of hospitals for foundlings and for syphilis. This suggests an indictment against humanity which is hardly justified by the facts. Infanticide was no new thing, and foundling hospitals date from the beginning of the 13th century. Their marked increase and the establishment of syphilitic hospitals came a century later than the Reformation campaign against the Frauenhäuser. The suppression of the latter did not affect the prevalence of prostitution. In the 17th century another spasm of severity occurred. In 1635 an edict was issued in Paris condemning men concerned in the traffic to the galleys for life; women and girls to be whipped, shaved and banished for life, without formal trial. These ordinances were modified by Louis XIV. in 1684. The Puritan enactments in England were equally savage. Fornication was punishable by three months' imprisonment, followed by bail for good behaviour. Bawds were condemned to be whipped, pilloried, branded and imprisoned for three years; the punishment for a second offence was death. In Hamburg all brothels were pulled down and the women expelled from the town. If these measures had any effect, it was speedily lost in a greater reaction; but they have some historical interest, as the present system was gradually evolved from them.

It would be tedious and unprofitable to follow all the steps, the shifts and turns of policy, adopted in different countries during the 18th century for the suppression or control of an incurable evil. They involve no new principle, and merely represent phases in the evolution of the more settled and more systematic procedure in force at the present time. Its chief feature, as compared with the past, is the establishment of an organized police force, to which the control of prostitution is entrusted, coupled with a general determination to put the subject out of sight and ignore it as far as possible. The procedure on the continent of Europe is virtually a return to the old Roman system of registration and supervision, except that there is no state tax, and names can be removed from the register. The objects are the same, namely, public order and decency, with one important addition, which has given rise to much controversy. This is the protection of health. From what has gone before, the reader will have gathered that it is not, as frequently supposed, a new thing. Already in the middle ages the question occupied the attention of parliament in England, and a weekly examination of public women by the barber (the surgeon of that time) was instituted at Avignon. The practice was adopted in Spain from about 1500, and later in many other places. But the abolition of licensed brothels, and the consequent growth of private prostitution, rendered it a dead letter. To meet the difficulty, registration was devised. It was first suggested in France in 1765, but was not adopted until 1778. The present regulations in France are based on the ordinances of that year and of 1780 which in their turn were borrowed from

those of the 16th and 17th centuries, previously mentioned. The theory of the modern attitude towards prostitution is clearly laid down by successive ordinances issued in Berlin. Those of 1700 stated that "this traffic is not permitted, but merely tolerated"; the more precise ones of 1792 pronounced the toleration of prostitution a necessary evil, "to avoid greater disorders which are not to be restrained by any law or authority, and which take their rise from an inextinguishable natural appetite"; and the regulations of 1850 and 1876 are headed: "Polizeiliche Vorschriften zur Sicherung der Gesundheit, der öffentlichen Ordnung und des öffentlichen Anstandes." This embraces the whole theory of present administration, and if *Gesundheit* be omitted, is not less applicable to the United Kingdom than to the continent. The last attempt to suppress prostitution in Germany is worth noting, as it occurred so late as 1845. Registration was stopped and the tolerated houses were closed in Berlin, Halle and Cologne. The attempt was a complete failure, and it was abandoned in 1851 in favour of the previous system.

We proceed to state the present condition of the law in France, Germany, Austria and the United Kingdom.

France.—The French criminal law takes no cognizance of prostitution. The subject was omitted from the penal code drawn up by the first Republic, and was never restored, although many attempts were made to introduce legislation, on account of the great disorder which arose. Prostitution is to a certain extent a criminal offence. Paragraph 334 of the code forbids the exciting, favouring or facilitating habitually the debauch of girls or boys under twenty-one years of age; the penalty is imprisonment for six months to two years, and a fine of 50 to 500 francs. If the offence is committed by parents, guardians or other persons in a tutelary position, imprisonment is from two to five years, and the fine 300 to 1000 francs. The regulation of prostitution rests on the law of 1790, which entrusted the preservation of public tranquillity to the administrative authorities; these are in Paris the prefect of police, and in other communes the mayor. The Parisian regulations have been built up by the decrees of successive prefects. They are based on those of 1778, which fell into abeyance at the Revolution, were reintroduced in 1816, amended in 1823, and made more complete in 1830 and 1841. Those adopted in other towns do not differ in any essential particular. The more important points are: (1) registration of prostitutes, which is either voluntary, or compulsory after repeated arrest; (2) recognized brothels, which are of two classes—*maisons de tolérance* (residential) and *maisons de passe* (houses of call); (3) medical examination, which is weekly at the *maisons de tolérance*, while other registered prostitutes must present themselves fortnightly at the dispensary; (4) hospital treatment of those found diseased; (5) rules with regard to solicitation, the frequenting of public places, &c. A small fee is paid for examination. The penalty for infraction of regulations is imprisonment; offences are divided into two classes: (1) slight, (2) grave, and the term of imprisonment varies accordingly from fourteen days to one year. Names may be erased from the register on the following grounds: (1) marriage, (2) organic disease such as to render the calling impossible, (3) return to relations and proof of good behaviour. The whole procedure appears to rest on grounds of doubtful legality. Prostitution never comes before the courts which alone can try offences and pronounce sentence. The police have no power to do so, yet they both try and sentence these women. That is to say, the whole system depends on their doing, by some verbal quibble, what they have no power to do. The question came before the court of Reims in 1876, in the case of two women who refused to submit to medical examination, and the judge decided in their favour. He was dismissed in consequence, which does not make the situation more satisfactory.

Germany.—The German law is more explicit and more logical. Prostitution is not forbidden, but by paragraph 361 of the Imperial Code women are liable to arrest for practising prostitution without being under police control, and for contravening

regulations after they have been placed under such control. This brings the traffic completely under the police, and gives legal sanction to their regulations. These vary to some extent in different places, but their general tenor is the same. They include compulsory registration and weekly or semi-weekly medical examination, together with rules, for the most part extremely strict, with regard to public demeanour and conditions of life. In Hamburg, for instance, prostitutes are confined to certain streets or houses, forbidden to share lodgings with persons not registered, to have female servants under twenty-five years of age, to keep children after school age, to admit young men under twenty, to make a noise or quarrel, to attract attention in any way, to go out between two and five in summer, to frequent certain parts of the town, or public balls, or superior seats in the theatre, to remain out after 11 p.m. (Regulations of 1886). On proved reclamation, supervision may be relaxed or names struck off the register. Generally, the women are compelled to contribute a fixed sum to a sick fund, for defraying the cost of medical examination; and in some places also to a journey fund, which is applied to sending strangers to their homes. Brothels are absolutely illegal throughout Germany. Paragraph 180 of the Imperial Code (1876) made *Kuppelei* a penal offence. *Kuppelei* is defined as promoting prostitution, either by procuration or by providing facilities of any kind. There is (1) ordinary *Kuppelei*, or simply assisting prostitution for gain, and (2) aggravated *Kuppelei*, which includes false pretences and procuration by parents, guardians, teachers, &c. The penalty for the former is a short term of imprisonment and police supervision; for the latter, penal servitude up to five years. It is obvious that if this law were strictly enforced, it would amount to suppression, for every householder or house-owner who harboured a prostitute would be liable to prosecution. Its actual interpretation, however, is very elastic. A law passed in Prussia in 1900 has for its object the reclamation of the young. Girls under eighteen may be placed under control until they are twenty-one.

Austria.—The Austrian law goes farther than the German, and is still more inconsistent with the existing practice. By paragraph 5 of the Criminal Act of 1885 prostitution is actually forbidden, but permission is given to the police to tolerate it under conditions, and to prescribe regulations according to circumstances. Power to punish is also given to the police. Only certain cases of prostitution are liable to criminal prosecution, namely, when continued after police punishment, with disregard of regulations, when practised by persons suffering from venereal disease, and when accompanied by public scandal. Seduction of the young is punishable by imprisonment, eight days to six months; living on the prostitution of others, by eight days to three months. *Kuppelei* is a penal offence. Simple *Kuppelei* include (1) harbouring prostitutes for the purpose of pursuing their trade, (2) procuration, (3) having any connexion with the traffic—penalty, three to six months' imprisonment; qualified *Kuppelei* is (1) procuration of innocent persons (equivalent to use of false pretences), (2) procuration by parents, guardians, &c.—penalty, one to five years. The police regulations and procedure are similar to those in Germany, but less strict. In all these countries a special service of police is employed.

Great Britain.—The English law differs markedly from the foregoing. It regards prostitution solely as a public nuisance, and dates from the middle of the 18th century. The principal act (25 Geo. II.) was passed in 1755, making perpetual a previous act of 1752. It is entitled "An act for encouraging prosecutions against persons keeping bawdy-houses," and provides that two ratepayers, on giving notice to a constable, may go with him before a justice and obtain an order for proceeding against the persons in question. A further act was passed in 1763, fixing the penalties, and a third in 1818 (58 Geo. III.), enabling the overseers of the parish to take the requisite proceedings. Thus machinery was provided for dealing with brothels, but it was left to the public to put it in motion. The Vagrancy Act of 1824 enables the police to proceed against "common prostitutes

for behaving in a riotous or indecent manner," and also forbids indecent literature. This was strengthened by a special act (1839) applying to London only, for the prevention of "loitering for the purpose of prostitution or solicitation, to the annoyance of passengers or inhabitants." Other large towns have since obtained private acts for the same purpose. The penalties are fines and short terms of imprisonment. In 1847 an act was passed making it an offence for publicans to allow "common prostitutes to assemble and continue" in licensed premises. The Licensing Act of 1872 contains a provision to the same effect. The previous law for dealing with brothels by indictment was strengthened by the Criminal Law Amendment Act of 1885, which renders "any person who keeps, manages or acts or assists in the management of a brothel," and any owner or occupier who knowingly permits the same, liable to summary conviction under the Summary Jurisdiction Act; penalties for first offence, a fine up to £20, or imprisonment up to three months, increased for second offence to £40 and four months respectively. The same act also strengthened the law, which had previously been very weak, for the protection of the young and the prevention of procuration. It makes the procuration or attempted procuration of any girl or woman "to become a common prostitute" a misdemeanour punishable by two years' imprisonment, and places the following offences on the same footing: procuring defilement by threats, fraud or drugs; compulsory detention for defilement or in a brothel; procuring the defilement of girls under twenty-one; inducing them to leave the kingdom or to leave home and go to a brothel, with intent. The defilement of girls under sixteen and over thirteen years of age is also a misdemeanour, and subject to the same penalty; the defilement of girls under thirteen is felony, punishable by penal servitude from five years up to a life-sentence. Owners or occupiers of premises conniving at these offences are equally liable.

No account of the law in the United Kingdom would be complete without some reference to the partial adoption of the system of examination as employed elsewhere in Europe in 1864-1883. In 1864 a Contagious Diseases Prevention Act was passed providing for the compulsory medical examination of prostitutes, and detention in hospital of those found diseased, in the following garrison towns: Portsmouth, Plymouth, Woolwich, Chatham, Sheerness, Aldershot, Colchester, Shorncliffe, the Curragh, Cork and Queenstown. The legal machinery was a justices' order granted on sworn information that the woman named was a common prostitute. "The Act having proved very inefficacious" (judge advocate-general in House of Commons, April 1883), it was amended in 1866 and extended to Windsor. Two years later an important memorial was drawn up by the royal colleges of physicians and surgeons in favour of the acts and their extended application, and in 1869 they were further amended and applied to Canterbury, Dover, Gravesend, Maidstone, Southampton and Winchester—eighteen places in all. A popular agitation, based on humanitarian and moral grounds, and continuously carried on against the measure led to the appointment of a royal commission in 1871 and a select committee in 1879. The direct evidence was strongly in favour of the acts, alike with regard to the diminution of disease among the troops in the protected towns, the absence of complaints and the good effect on public order, to which clergymen and other residents testified. The majority of the committee reported accordingly after three years' inquiry; but in 1883 the House of Commons passed a resolution, by 182 to 110 votes, condemning the compulsory examination of women. As this would have entailed refusal to vote the money required to carry on the system, it was immediately dropped, and the officers of the metropolitan police to whom its execution had been entrusted were recalled. In 1886 the C. D. Acts were repealed.

In India the system was introduced for military cantonments in 1865, partially suspended at the end of 1884, and stopped in 1888 on account of the action of the House of Commons. A new Cantonment Act was applied in 1889, and an amending act

in 1893, by which the compulsory or periodical examination of women was prohibited. In consequence of the enormous increase of syphilis which followed, a new order was made in 1897, which gave power (1) to call on persons suffering from a contagious disease to attend the dispensary, (2) to remove brothels, (3) to prevent the residence or loitering of prostitutes near cantonments.

The foregoing summary of existing laws and regulations sufficiently indicates the present methods of dealing with prostitution. All Western nations broadly follow one or other of the systems described, though the local regulations may vary somewhat in minor details.

The French system of recognized houses, with registration, *police des mœurs*, &c., obtains in Belgium, Russia, Hungary, Spain and Portugal; Italy adopted it in 1855, but **Conditions actually existing.** Dutch towns *maisons de tolérance* are permitted with or without a *service des mœurs*; Norway has abandoned registration, except in Bergen and Trondhjem, but otherwise Scandinavia rather follows the German principle of non-recognition, with more or less vigorous policing; of the Swiss cantons, some have the French, others the German system; while the United States and the British self-governing colonies incline more to the English model of comparative freedom, without a moral police or one possessing arbitrary executive powers independent of the courts of justice. All the systems have their defects; all fail to fulfil their purpose in the great cities. The most modest aim is to preserve public order and propriety. This object is better secured on the continent of Europe than elsewhere, but at the cost of submitting to an arbitrary police rule, intolerable to a free people. There appears to be less prostitution, both visible and actual, in Italy than in other countries. Under the English system the streets can be, and sometimes are, kept orderly in provincial towns by an energetic police; but in London the mass of prostitution is so great that the police seem totally unable to cope with it. Important thoroughfares and centres are frequented by large numbers of prostitutes in broad daylight, and choked by them at night. The law with regard to loitering is a dead letter, for these women do nothing but loiter. Flagrant solicitation is to some extent repressed, but for the most part the police content themselves with preventing positive tumults, and do not always succeed in that. On the other hand the less obvious but more pernicious nuisance of the brothel prevails to a far greater extent on the continent of Europe. Under the French system it is, of course, encouraged, in preference to "surreptitious" prostitution; but under the German it is forbidden. The facts here afford a proof of the impotence of the law no less striking than the condition of the London streets. By the German and Austrian criminal law, quoted above, brothels are prohibited, yet they abound in both countries. In Austria they are recognized, and perhaps the logic of the law is saved by permissive police clauses. In Germany it is not so. Paragraph 180 absolutely disposes of the question, and in Berlin it is acted on. Elsewhere brothels not only existed, but were recognized by authority for years after the passing of the laws against *Kuppelei*. It was not until 1886 and 1889 that they were nominally abolished in Hamburg and Saxony respectively. Yet they still exist in most or all of the large towns, with the knowledge and consent, if not with the permission, of the police. In some they are even authorized. Berlin, which is more severely policed than any town outside Russia, is an exception. There brothels are not openly winked at, but the police have to deal annually with 16,000 or 17,000 charges of *Kuppelei*, and the number remains very constant, from which it may be inferred that the law, even when logically and energetically carried out, is quite ineffective. The European system of registration is still more delusive. In Russia, where the authorities have the means of knowing the movements and habits of every individual, it may be possible to compel the registration of the majority of prostitutes, but in other countries it is impossible. The police everywhere complain of the amount of "clandestine" prostitution, which they

cannot control, and which tends always to increase, under the system, while the roll of inscribed women dwindles. The numbers alone are sufficient to prove the failure of the procedure; for instance, 311 and 270 in Dresden and Munich respectively (Zehnder 1891), both capital towns and cities of pleasure containing over 300,000 inhabitants. Cologne, with only half the population, had double the number on the register at the same time. In Paris, which may be called the headquarters of Western vice, the disproportion between registered and clandestine prostitution has reduced the whole system to an absurdity. The number of women on the roll is not a tenth of the estimated number of prostitutes; nor is Berlin, with about 3000 on the register, any better off. In Bordeaux, Brest, Lille, Lyons and Marseilles the same process is going on (Reuss). It follows that the protection of health, which is the object aimed at by registration, is delusive in an equal degree. There are no means of ascertaining the amount of venereal disease existing in any town or country, except in Norway, and consequently, no data for comparing one period or one place with another; but we know that all forms of such disease are still very prevalent in all large European towns, in spite of the system. The only exact figures available are the military returns, which are of some value. It is in garrison towns of moderate size that compulsory registration is likely to be most efficiently carried out and to produce the most decided results, because the women with whom soldiers consort are by their character and habits least able to elude the vigilance of the police. The following table gives the proportion of admissions to hospital from all forms of venereal disease in the German, French, Austrian and British forces for twenty years from 1876. It may be added that the proportion in the Russian army is almost identical with the French, while the Italian figures are slightly higher than the Austrian. It is therefore unnecessary to give them:—

Admissions per 1000 in European Armies.

Year.	German.	French.	Austrian.	British (Home).	British (India).
1876	28.8	57.0	65.8	146.5	203.5
1877	30.0	57.8	66.9	153.2	224.4
1878	36.0	59.7	75.4	175.5	291.6
1879	38.5	63.7	81.4	179.5	253.3
1880	34.9	65.8	75.7	245.9	249.0
1881	39.2	60.6	79.0	245.5	259.6
1882	41.0	62.0	73.7	246.0	265.5
1883	38.2	58.9	73.3	260.0	271.3
1884	34.5	52.1	73.5	270.7	293.5
1885	32.6	50.7	69.0	275.4	342.6
1886	29.7	49.6	65.8	267.1	385.8
1887	28.6	51.6	64.4	252.9	361.4
1888	26.3	46.7	65.4	224.5	372.2
1889	26.7	45.8	65.3	212.1	481.5
1890	26.7	43.8	65.4	212.4	503.6
1891	27.2	43.7	63.7	197.4	400.7
1892	27.9	44.0	61.6	201.2	409.9
1893	—	42.8	64.5	194.6	466.0
1894	—	40.9	64.8	182.4	511.4
1895	—	—	—	173.8	522.3

The most striking thing in this table is the enormous difference between the continental and the British figures. To make the comparison more complete, we will add the following, which gives the average admissions per 1000 for the three years 1890-1892:—

German.	French.	Russian.	Austrian.	Italian.	U.S.A.	British (Home).	British (India).	Dutch (Indies).
27.2	43.6	43.0	63.5	71.3	77.4	203.6	438.0	455.6

It is clear at once that troops in the East stand upon an entirely different footing from those in the West, the Dutch figures being even higher than the British; we may therefore put them aside for the moment. Comparing the rest, we notice that not only are the British figures enormously higher than the other European, but the latter also show very large discrepancies; and since all the foreign troops are under the same protective system, we may conclude that other factors must be taken into account. The

discipline maintained, the character of the soldiers themselves, and the procedure with regard to admission into hospital, no doubt all affect the returns. Further, a sort of epidemic rise and fall is to be noted. All the returns given in the first table show a simultaneous rise for several years, beginning with 1876; and having reached a maximum, each shows a progressive fall, likewise lasting over several years. This points to another disturbing factor. It is convincingly shown by the figures for the protected districts in the United Kingdom before, during, and after the period of protection. In 1864—that is, just before the first Contagious Diseases Act came into operation—the proportional figure was 260; ten years later it had fallen to 126; but in 1883 it had risen again to 234, in spite of the protection. Then, protection being removed, it rose to 276, but afterwards fell again progressively to 191 in 1895, without any protection. It is therefore evident that in interpreting the statistics allowance must be made for large fluctuations due to causes quite independent of the protective system. The margin of difference, however, between the British and European returns is so large that, when all allowances have been made, it is impossible to doubt that a considerable degree of real protection is afforded to soldiers by the system. This conclusion is confirmed by the comparatively high returns for the army of the United States, and still more by the Indian statistics. They rose gradually, it is true, during the cantonment system, but when that was dropped disease increased with shocking rapidity. Between 1887 and 1895 the admissions for primary syphilis rose from 75.5 to 174.1 per 1000, and those for secondary syphilis from 29.4 to 84.9.

The broad conclusion is that under special conditions, and when rigidly enforced, registration and medical examination do to a considerable extent fulfil the purpose of protecting health. Their failure to do so among the population at large and under the ordinary conditions of life is not surprising when we regard the amount of venereal disease which still occurs even among soldiers protected by the most rigorous measures and under the most favourable conditions.

A general view of the whole subject suggests no pleasant or hopeful conclusions. Prostitution appears to be inseparable from human society in large communities. In different countries and ages it has in turn been patronized and prohibited, ignored and recognized, tolerated and condemned, regulated and let alone, flaunted and concealed. Christianity, the greatest moral force in the history of mankind, has repeatedly and systematically attacked it with a scourge in one hand and balm in the other; but the effect has been trifling or transient. Nor have all the social and administrative resources of modern civilization availed to exercise an effective control. The elementary laws on which prostitution rests are stronger than the artificial codes imposed by moral teaching, conventional standards or legislatures; and attempts at repression only lead to a change of form, not of substance. It survives all treatment; and though it may coexist with national vigour, its extravagant development is one of the signs of a rotten and decaying civilization. In Western communities the traffic is not carried on so openly as in the East, nor is it exploited for purposes of public revenue, as among the ancients and in the middle ages; a veil of reticence and secrecy, for the most part of a transparently flimsy character, is thrown over it; but whatever is gained in public decency is counterbalanced by other attendant evils. Two, in particular, are fostered by the policing of prostitutes. One is the system of blackmail levied by the executive. The scandal has been most notorious in the United States, but it exists everywhere, and is a constant source of profound corruption. The other is the growth of the most degraded class that ever disgraced the name of man—the creatures who live upon the earnings of individual prostitutes, with whom they cohabit. They are called *souteneurs* in France, *louis* in Germany, *cadets* in New York, and by various slang names in Great Britain. They are all criminals. They flourish chiefly on the continent of Europe, where they exist in large and ever-increasing numbers; but they find their way everywhere, and are a dangerous

menace to society. They are not altogether new. The Elizabethan drama is full of references to men who took toll of prostitutes in return for protective services in the old days of persecution; but they have been greatly fostered by the modern system, under which women find it necessary or convenient to have the cover of a man, who can pass for a husband and baffle the police. Thus the law is evaded on the one hand by the corruption of those who administer it, and on the other by the appearance of a class of criminal idlers more degraded than any other—both greater evils than the traffic which the law is intended, but fails, to control. There are no data for comparing the extent of profligacy at present existing in Western communities with that in other countries or in former times, but the unmentionable facts which come constantly to the knowledge of the *police des mœurs*, and less frequently to the ears of doctors, and lawyers, leave no doubt that in intensity of vice the great centres of modern civilization have nothing whatever to learn from Corinth, imperial Rome, ancient Egypt or modern China. The classical obscenities dug up and relegated to museums are far surpassed by the photographic abominations prepared to-day in Paris or in Amsterdam. The gross perversion and abuse of the sexual instinct implied by these excesses may be a passing phase, but it is a phase which has always marked the decadence of great nations. It is undoubtedly accompanied by a general tendency towards increase of the volume of prostitution. Improvement in the conditions of life among the poor ought to tend in the opposite direction, by removing one of the most potent causes of the traffic, but it is more than counterbalanced by the rising standard of luxury and comfort which accompanies it, by the aggregation of the people more and more into great cities, and by their craving for amusement. The growth of prostitution has already left its marks on the marriage- and birth-rates of the most highly civilized Western communities.

In 1900 the Prussian Government made an attempt, with the co-operation of the medical corporations, to ascertain the amount of venereal disease prevalent in the kingdom. Circular questions were addressed to all members of the medical profession requesting them to report the number of patients suffering from those disorders in their practice at the date of the 1st of April. Answers were sent in by 63%, and the aggregate number of patients was 40,902. From this datum it is calculated that the number of persons attacked in the course of a year is at the very least 500,000 in Prussia alone (vide *Hygienische Rundschau*, April 1902).

AUTHORITIES.—W. F. Amos, *State Regulation of Vice*; Committee of Fifteen (New York), *The Social Evil* (1902); Conférence Internationale (Brussels, 1899), *Comptes rendus*; Fiaux, *La Prostitution en Belgique*; Gibbon, *Decline and Fall of the Roman Empire*; Henne-am-Rhyn, *Die Gebrechen der Sitten-polizei*; Parent-Duchâtelet, *De la prostitution dans la ville de Paris*; Reuss, *La Prostitution*; Von Raumer, *Geschichte der Hohenstaufen*; Sangar, *History of Prostitution*; Schlegel, *Histoire de la prostitution en Chine*; Schrank, *Die Prostitution in Wien*; Stürmer, *Die Prostitution in Russland*; Tarnowsky, *La Prostitution*; Zehnder, *Die Gefahren der Prostitution*. (A. S.L.)

PROSTYLE (Gr. πρό, before, and στῦλος, a column), in architecture, a portico in which the columns project from the building to which it is attached.

PROTAGORAS (c. 481–411 B.C.), Greek philosopher, was born at Abdera. He is known as the first of the Sophists (*q.v.*), i.e. he was the first to teach for payment. It is said that he received nearly £400 from a single pupil. He learned philosophy in the Ionian school, and was perhaps a pupil of Democritus, though this is doubtful on chronological grounds. He was an older contemporary of Socrates. He was so highly esteemed by Pericles that he was entrusted with the task of framing laws for the new colony of Thurii (Plut. *Pericles*, 36). At the age of seventy, having been accused by Pythodorus, and convicted of atheism, Protagoras fled from Athens, and on his way to Sicily was lost at sea. According to Plato (*Prot.*, 318 E), he endeavoured to communicate “prudence” (*εὐβουλία*) to his pupils, “which should fit them to manage their households, and to take part by word and deed in civic affairs.” The education which he provided consisted of rhetoric, grammar, style and the interpretation of the poets. His formal lectures were supplemented by discussions amongst his pupils. He left behind him several treatises, of which only a few fragments have

survived. In *Truth*, by way of justifying his rejection of philosophy or science, he maintained that “man is the measure of all things—of what is, that it is, and of what is not, that it is not.” Besides *Truth*, and the book *Of the Gods* which caused his condemnation at Athens, Diogenes Laërtius attributes to him treatises on political, ethical, educational and rhetorical subjects. Protagoras was the first to systematize grammar, distinguishing the parts of speech, the tenses and the moods.

AUTHORITIES.—Diog. Laërt., ix. 8, &c.; the very different representations in Plato's *Protagoras* and *Theaetetus*; the fragments in Johannes Frei, *Quaestiones Protagoreae* (Bonn, 1845), and A. J. Vitringa, *Disquisitio de Protagorae vita et Philosophia* (Gröningen, 1852); for the Thurian legislation, M. H. E. Meier, *Opuscula*, i. 222, and Gomperz in Franz Hoffmann's *Beiträge zur Gesch. des griech. und röm. Rechts* (1870). On Protagoras' philosophy see the histories of philosophy, e.g. Gomperz, *Greek Thinkers* (Eng. trans., 1901) i. 438–475 and 586–592, Zeller, Ueberweg, Erdmann, and works quoted under **SOPHISTS**.

PROTECTION, in economics a system of commercial policy and a body of doctrine, which in their modern forms are the outgrowth of the commercial and industrial development of the 19th century. The common definition of protection as a policy is the attempt to develop a manufacturing industry by a system of discriminating duties upon manufactured goods imported from foreign countries. But this is far too narrow a definition to suit the modern use of the term, though the notion of discriminating tariffs is common and, we may say, basal to all definitions. Protection as a policy includes not only discriminating tariffs, but also a large number of other features supplementary to this fundamental one and designed to emphasize its purpose. Thus a scheme of bounties and premiums, of rebates and drawbacks, is everywhere considered an essential element of the protective system. Nor is it any longer limited to the encouragement of manufactures, but includes as well the protection of agriculture, forestry, mining, fishing, shipping, &c. In short, one cannot give a comprehensive and satisfactory definition of protection to-day without giving it a much wider scope than that of a system of protective duties upon manufacturing industry.

Many of its advocates claim, and with some show of reason, that the term protection, as now used to describe the commercial policy of a nation, should be so defined as to include all the means by which a country undertakes **National Policy.** to secure through the positive efforts of the government the complete industrial and commercial development of all its resources and of all its parts. As its object is thus comprehensive, its justification is to be found in a series of arguments based upon political, economic, and social considerations. From this point of view the protective policy embraces not merely the system of discriminating import duties in favour of home products—industrial, agricultural and mining, with which the policy began in the United States, for example—but also the system of bounties offered for the introduction and establishment of new industries; the policy of restricted immigration of the less desirable classes of labourers, combined with the positive inducements to the skilled labour of other countries to transfer itself to the one in question; the system of discriminating or prohibitive tonnage duties, known as Navigation Acts; the system of developing foreign markets by an active policy directed towards securing advantages for home products in foreign countries—in a word, all those pecuniary or other sacrifices which a country may make in order to develop its material resources and establish, develop and foster industry and commerce. In this wide sense the comprehensive policy adopted by the United States, for example, includes the making of a careful geological and botanical survey of the whole country in order to discover and open up the vast natural wealth of its domain in its mines, forests and fields; the establishment of experiment stations to test the usefulness of new crops or means of making old crops more valuable; the stocking of its rivers with fish and the afforesting of its mountains; the introduction of new or more valuable breeds of livestock; the building of railways and canals, and the offering of inducements to private parties to undertake similar enterprises; the deepening of its

rivers and harbours, &c.; and, finally, the development, at public expense, of a scheme of technical and commercial education—lower and higher—adapted to discover and train all the talent in the community available for developing the industry and commerce of the country.

If such an account of the features of a protective policy is objected to on the ground that free trade countries like Great Britain have also adopted some of them, it may be replied that in so far as they have done so they have adopted the principle of protection, namely, that government shall adopt a positive policy looking towards the development, by government aid if necessary, of new branches of commerce and industry and the firmer establishment of old branches. It may further be pointed out that the countries which have adopted the protective policy most fully—the United States, France, Germany and Russia—have most consistently followed out the policy here indicated, and in all these countries it has been the so-called protectionist party which has identified itself most fully with the comprehensive policy here suggested.

As a doctrine, protection is the set of principles by which this policy of government aid to industry is justified, and these principles have been elaborated hand in hand with the development of the so-called protective policy sometimes outrunning its actual application and advocating its further extension, more often lagging behind and seeking for means of explaining and defending what had already been done. The present development of the system and theory of protection is a result of the growing predominance of capitalism in modern society, combined with the tendency of modern politics towards the organization and development of great national states, with the resulting desire to secure their industrial as well as their political independence. It has been further favoured in certain ways by the fact that the financial needs of modern states require a resort to indirect taxation, thus making it easier for the capitalistic forces to exploit the tax system for their own benefit; while the wars of the 19th century have favoured in many ways the tendency towards the adoption of special means, like high discriminating duties, to accomplish this end. Hand in hand with this has gone a steady tendency to see in the state a powerful means of promoting the development of trade and industry, and a growing disbelief in the more extreme forms of the free trade doctrine, such as the type known as the Manchester School, the theory of the *laissez faire, laissez passer* school of economics and politics.

Protection, both as a doctrine and policy, can be best understood by examining the course of its development in those countries adopting it most consistently. Germany and the United States offer the two striking examples of great modern nations adopting a system of protection and developing under its influence. They may in a certain sense serve as types of the kind of state which in the 19th century accepted and defended, in its politics at any rate, the so-called protective system. In both cases the high protective system was associated with the development of nationality, of industry, of capitalism, and of a financial system which favoured the growth of certain elements of the protective policy.

The protective system in the United States began with the adoption of the Constitution in 1789, and found its first formal defence in the celebrated report of Alexander Hamilton on manufactures. The argument and the movement were largely academic. As there was no strong manufacturing interest in existence, so there was no organized capitalistic effort to secure manipulation of the tariff duties in the interest of special industries. There was general agreement, however, that it would be desirable to develop a manufacturing industry in the colonies if it were practicable. A high degree of natural protection was already afforded by the cost of transportation. It was felt, therefore, that a small duty on manufactures would probably serve the purpose, since the development of the manufactures would favour the production of raw material, which would therefore need no special encouragement. It was also felt that a small duty, continued for

a few years, would result in the establishment of the industry on such a firm basis that all duties might be abolished. The introduction of this form of protection, *i.e.* discriminating duties upon imported goods, was greatly assisted, if not originally caused, by the fact that the new government needed money which could most easily be obtained by customs duties. Thus all those parties which were opposed to direct taxes joined their efforts with those interested in securing protective duties, in order to commit the government to the policy of basing its revenue system on a tariff on imports. To these considerations must be added the further one that the country had just thrown off political dependence on Europe, and felt that it must now become industrially independent also, if it were to be a great nation. These influences, then, namely, firstly, the desire of the statesmen of the time to create a revenue system for the Federal government which would make it absolutely independent of the states; secondly, the wish to develop an industry which would serve the needs of the new country while it promoted its complete independence of the Old World, conspired to commit the Federal government from the beginning to a policy of protection based upon a system of discriminating duties. At the same time a system of discriminating tonnage dues and prohibitory regulations relating to foreign shipping in the coasting trade was adopted to promote and foster the shipping interest.

Industry and commerce began to thrive as never before, largely because of the absolute free trade which the Constitution had secured among the states of the Union. The long struggle between France and Great Britain, extending from 1806 to 1812, for the possession of the commerce and the trade of the world, combined with the retaliatory measures of the American government itself, practically destroyed American commerce for a time, and finally led to the British-American War of 1812, which closed in 1815. The financial system of the Federal government during this war was based on getting the largest returns from the customs, so that the duties were screwed up still higher. The ten years period of non-intercourse, while it had seriously injured American commerce, had fostered the growth of American manufacturing; and when the close of the War of 1812 brought with it an enormous influx of foreign goods, particularly from the plethoric warehouses and factories of England, it looked for a time as though the new American industries were destined to vanish as rapidly as they had grown up. And now for the first time appeared a strong, well-developed, capitalistic party, which was, in spite of some drawbacks, destined to grow until it became one of the most characteristic features of the politics of the republic.

The manufacturers of the country determined the tariff policy of the country, and with few reverses pursued a steadily advancing course of victory down to the close of the 19th century. They secured the maintenance of high duties at the close of the war of 1812, and managed to increase them steadily until the reaction of 1830–1833, when they were forced to content themselves with a lower rate, which continued, with a slight interruption in 1842–1846, until the outbreak of the Civil War in 1861. This was an opportunity which they knew how to utilize to the greatest advantage. During the war, when the government was forced to exploit every possible source of revenue, the protectionist party knew how to turn the necessities of the government to its advantage. The rate of duties was pressed ever higher; and when the war closed, and the taxes could again be lowered, the protectionist managers knew how to lower or remit altogether the non-protective duties, and thus keep high, and even advance to a still higher point, the duties which protected them from foreign competition.

In the meantime the country was turning from agriculture to manufactures at an unprecedented rate. The manufacturing party was becoming ever stronger and more aggressive. As it had also been the national party, it profited by the enormous development of the nationalist sentiment during and after the war. It now became patriotic to favour the development of a national industry. It was treason to advocate free trade—that had been the policy of the slave-holders' party, and the Slave-

**Economic
Doctrine.**

**United
States.**

holders' Rebellion, as the Civil War was called, had drawn its strength largely from the free-trade sentiment. The policy of the protectionist party had expanded with the growth of the country and the necessity of coming to terms with the antagonistic elements. Thus at first the platform of the protectionists had been one of reasonably low duties on manufactured commodities, low duties on half-manufactured and no duties at all on raw material. But as the country advanced, and it was seen how the interests of manufacturing had been quickened by the policy of discrimination, those engaged in producing raw materials and half-manufactured commodities demanded that they too should be considered. As this concession had to be made by the manufacturers, they were compelled to justify it by other arguments than those used at first. The infant-industry argument gave place to the proposition, that as long as the prices of raw materials and labour were higher in America than abroad, it would be necessary to maintain countervailing duties at least equal to this difference, in order to protect American industry. One branch after another of manufacturing or agriculture was included and given the benefit of protection. In order to have satisfactory theoretical basis for such a policy, the theory was advanced that foreign trade was a necessary evil, to be diminished as much as possible. The ideas were advanced and spread throughout the country: that the home market should be reserved for home products; that the labourers should be protected against the influx of foreign cheap labour (Chinese Exclusion Acts; restrictive immigration laws); that prices should be kept high, so as to enable employers to pay high wages; that shipping should be encouraged by subsidies, the sugar industries by bounties; that the nation should become ever more independent of foreign nations for all its industrial products, and capable of holding its own against the world in industry as well as in arms.

The protective party has been the national party during a time when the greatest question before the American people was whether it was to be one nation, or two, or twenty, and it naturally profited by the inevitable victory of nationalism; it has always stood for honest payment of national and state debts, if not in the standard according to which they were contracted, in a still better one, and it has profited naturally by this attitude in a country where the development of trade and industry was rapidly and steadily towards a capitalistic state of society in which such policy is favoured; it has stood for a vigorous and active independence in the field of world politics, and it has naturally profited by this fact in a country which was rapidly forging ahead to take its place among the greatest of existing nations, and with an ever-increasing self-consciousness was ready to assert itself among the nations of the world; it has stood for free labour against slave labour, and consequently profited here again in a country whose greatest conflict turned upon the question whether the system of slave labour should be extended or not; it has stood for high wages for American labourers, and in words at any rate has advocated a policy directed to protecting them against competition with the "pauper labour" of the Old World. It has stood for government activity in the direction of developing railways and canals; of establishing education upon national lines, making it free, in all grades from the kindergarten to the university, to all citizens of the republic, and it has profited by this association in a country where all influences were telling in favour of this tendency. In short, whatever one may think of the wisdom or folly of trying to develop national industry by a system of discriminating duties, the protective party as such in the United States has been on the progressive side of so many of the deep questions of national importance that it has obtained and kept the allegiance of thousands of men who would have been glad to see a change, or indeed a reversal, in the tariff policy of the party.

The history of the tariff policy in Germany had been very similar to that of the United States. Beginning with the establishment of absolute free trade among the various

Germany.

German states in the earlier customs union, it extended this policy, by the establishment of the North German

Confederation and the new German Empire, to all the states now included in the federation. The long-wished-for political union meant political independence, and when political independence was once achieved, industrial and commercial independence were next desired. Within the empire itself it was necessary, if the new organization were to be strong and vigorous, that the central government should become independent of the individual states; and this could be best effected by giving it a revenue system based upon import duties, which in the long run has enabled the central government to subsidize the state governments, and thus bring them still further under its influence. To develop this system the political support of some strong party was needed. This party was found in the protectionist elements, which have thus again become the national party in a state which was being rapidly nationalized; the industrial party in a society which was rapidly passing from the agricultural to the industrial condition; the capitalistic party in a society which was rapidly becoming capitalistic in all its tendencies. It stood for industrial and commercial, as well as political, independence of other countries, and thus satisfied the longing for national unity and independence of a people which had suffered for centuries from disunion and dependence.

These two examples may serve to explain how the two most powerful industrial nations next to Great Britain became and remained highly protectionist in sentiment and in action, and how they both opened the 20th century with a more openly declared and a more fully developed system of protection than ever before.

Protection as a theory or doctrine is to a certain extent an outgrowth or modification of the old doctrines of mercantilism. In its modern form, however, it dates really from *Modern* the celebrated report on manufactures made by *Advocates and Critics*. Alexander Hamilton when secretary of the U.S. Treasury in the year 1791. The views there advanced have been further developed by Friedrich List and Henry C. Carey, and have in later years been carried along somewhat different lines to their logical conclusions by Simon N. Patten and George Gunton. Starting from an argument in favour of temporary duties on manufactured goods imported from abroad until such time as the infant industry might take firm root, the development proceeded through List, who favoured the maintenance of such duties until the country had passed into the manufacturing stage as a whole, and then through Carey to Patten and Gunton, who maintain that a protective policy, extended to cover agriculture, trade and mining, should be preserved as the permanent policy of the country until the entire world is one nation, or all nations have reached the same level of political, economic and social efficiency. The protective policy, which a century ago was to be, in the view of its advocates, temporary and partial, has become to-day, in the arguments of its apologists, permanent and comprehensive. We must content ourselves here with a brief statement of the arguments of the leading and most successful defenders of modern protectionism.

Alexander Hamilton, at that time secretary of the treasury, submitted his celebrated report on manufactures to the Congress of the United States on the 5th of December 1791. It *Hamilton* is in a certain sense the first formulation of the modern doctrine of protection, and all later developments start from it as a basis. It is a positive argument directed to proving that the existence of manufacturing is necessary to the highest development of a nation, and that it may be wisely promoted by various means, of which the most important is a system of discriminating duties upon foreign imports. Among the objects to be attained by the development of a flourishing manufacturing industry are mentioned: (1) Independence of foreign nations for military and other essential supplies. (2) A positive augmentation of the produce and revenue of society, growing out of (a) division of labour, (b) extensive use of machinery, (c) additional employment to classes of the community not ordinarily engaged in business. (3) An increase in the immigration of skilled labourers from foreign countries. (4) A greater scope for the diversity

of talents and dispositions which discriminate men from each other. (5) A more ample and various field for enterprise. (6) In many cases a new, and in all a more certain and steady demand for the surplus produce of the soil. (7) A more lucrative and prosperous trade than if the country were solely agricultural.

Among the feasible means of promoting the development of such an industry he mentions the following: (1) Protective duties, or duties on foreign articles which are the rivals of the domestic ones, to be encouraged. (2) Prohibition of rival articles or duties equivalent to prohibition. (3) Prohibition of the exportation of the materials of manufactures. (4) Pecuniary bounties. (5) Premiums. (6) Exemption of the materials of manufactures from duty. (7) Drawbacks of the duties which are imposed on the materials of manufactures. (8) The encouragement of new inventions and discoveries at home, and the introduction into the United States of such as may have been made in other countries; particularly those which relate to machinery. (9) Judicious regulations for the inspection of manufactured commodities. (10) The facilitating of the pecuniary remittances from place to place.

The above suggestions contain the outline of a comprehensive scheme for developing the manufacturing resources of the country, and the United States has subsequently adopted, in one form or another, almost all of these propositions. Hamilton considered that the duties, &c., would not have to be very high or very long continued in order to accomplish their legitimate ends, after which they would become unnecessary, and would naturally be abolished. He conceded that, generally speaking, import duties were taxes on the customer, and therefore burdens—but burdens which might well be temporarily borne for the sake of the ultimate advantage arising from cheaper goods and diversified industries. He emphasized also the advantage of a home market for agricultural products, and seemed to think that the United States had to pay the cost of transportation both on the agricultural products it exported and the manufactured goods it imported. This report remained the armoury from which the protectionists drew their weapons of offence and defence for two generations, and it has not yet ceased to be the centre around which the theoretical contest is waged even to-day in Germany and France as well as in the United States.

The next great theorist in this field was the German, Friedrich List, who, while an exile in the United States, became imbued with protectionist ideas, and after doing substantial service for them in the country of his adoption, returned to Germany to do battle for them there. He published his *National System of Political Economy* in Germany in the year 1841. It had great and immediate success, and has exercised a wide influence in Europe on theoretical discussion as well as on practical politics. List, like Hamilton, looked on protection as a temporary system designed to facilitate the passage of a country from an agricultural to a manufacturing state. He accepted free trade as generally and permanently true, but suited for actual adoption only in that cosmopolitan era towards which the world is progressing. But in order to prepare for this cosmopolitan period it is first necessary for each nation to develop its own resources in a complete and harmonious manner. A comprehensive group of national economies is the fundamental condition of a desirable world economy; otherwise there would be a predominance of one or of a few nations, which would of itself constitute an imperfect civilization. Protection is a means of educating a nation, of advancing it from a lower to a higher state. He admits that it may involve a loss, but only in the sense that money expended for an education or an educational system is a loss, or that money spent for seed corn is a loss. To the cosmopolitan system of Adam Smith, List opposes the national system as a preliminary and necessary stage. He favours the imposition of duties as the most efficient means of effecting the protection which he has in mind. Agriculture will be sufficiently protected by the constant demand for its products. The essence of his larger work is contained in a pamphlet published in Philadelphia in 1827, entitled *Outlines of American Political Economy*. It is, in fact, a series of letters advocating

the further development of the protective system already adopted in the United States.

The third great name in the history of protection is that of Henry C. Carey, an American, in some ways the most distinguished and most influential of the followers of Hamilton and Carey: List. He was at first a strong free trader, then a Patten. protectionist who believed in protection as a preparation for free trade, and finally an uncompromising advocate of protection in all circumstances and for all nations. In him and in Simon M. Patten, the last, and in many respects the ablest, of the apologists for protection, we have the theoretical development corresponding to the practical outcome of protection as a comprehensive all-embracing scheme extending protection to all branches of industry alike—agriculture, manufacturing and mining—and aiming to be permanent in its form and policy. As Patten expresses it: "Protection now changes from a temporary expedient to gain specific ends (such as the establishment of manufactures), to a consistent endeavour to keep society dynamic and progressive. Protection has become part of a fixed national policy to increase the value of labour with the increase of productive power, and to aid in the spread of knowledge and skill, and in the adjustment of a people to its environment." The object of protection has now become, in the view of the theoretical American protectionist, not an approximation to European industrial conditions, but as great a differentiation from them as possible. Carey's works were translated into the leading European languages, and contributed doubtless to the spread of protectionist ideas, though the extreme form in which his views were expressed, and the rambling illogical method of exposition, repelled many who might otherwise have been attracted by the course of his thought.

Economists of other schools, with the exception of the more rigid British free traders, have allowed a relative validity to the doctrines of List; and even among older British economists, Mill and some of his disciples conceded the logical possibility of quickening the development of an industry by import duties in such a way as to result in more good than harm, though they have hardly been willing to acknowledge that it is practically possible. The modern historical school of political economists have generally admitted the reasonableness of protective policies at certain times and places, though usually finding the justification in political and social considerations rather than in economic. And while the British objections to protectionism in any form have been widely upheld by the more conservative economists in England, the new political school of "tariff-reform and colonial preference" has found strong support at the hands of such British authorities on economics as Professors Cunningham, Ashley and Hewins, or the authors of *Compatriots' Club Essays* 1906 (J. L. Garvin and others), whose advocacy of a national policy recalls the work of Hamilton and List. (E. J. J.)

AUTHORITIES.—P. Ashley, *Modern Tariff History* (London, 1904); W. J. Ashley, *The Tariff Problem* (London, 1904); A. J. Balfour, *Economic Notes on Insular Free Trade* (London, 1903); G. Blondel, *La Politique protectioniste en Angleterre* (Paris, 1904); F. Bowen, *American Political Economy* (New York, 1875); B. Braude, *Die Grundlagen und die Grenzen des Chamberlainismus: Studien zur Tarifreformbewegung im gegenwärtigen England* (Zurich, 1905); J. B. Byles, *Sophisms of Free Trade* (London, 1903); G. Byng, *Protection* (London, 1901); H. C. Carey, *Principles of Social Science* (3 vols., Philadelphia, 1858-1859). *Harmony of Interests—Agricultural, Manufacturing and Commercial* (Philadelphia, 1873); C. H. Chomley, *Protection in Canada and Australasia* (London, 1904); W. Cunningham, *The Rise and Decline of the Free Trade Movement* (London, 1904); G. B. Curtiss, *Protection and Prosperity: an Account of Tariff Legislation and its Effect in Europe and America* (1896); W. H. Dawson, *Protection in Germany* (London, 1904); E. Dühring, *Kritische Grundlegung der Volkswirtschaftslehre* (1886); *Kursus der National- und Socialökonomie* (1873); Dumesnil-Marigny, *Les Libre-échangistes et les protectionnistes conciliés* (1860); Ganilh, *Théorie de l'économie politique* (1822); G. Gunton, *Wealth and Progress* (New York, 1887); *Principles of Social Economics* (New York, 1891); Alexander Hamilton, *Report on the Subject of Manufactures, communicated to the House of Representatives, 5th December 1791*; H. M. Hoyt, *Protection v. Free Trade, the scientific validity and economic operation of defensive duties in the United States* (New York, 1886); E. J. James, *Studien über den amerikanischen Zolltarif* (Jena, 1887); F. List, *Das nationale System der politischen Oekonomie* (Eng. trans.

by S. Lloyd, London, 1904); A. M. Low, *Protection in the United States* (London, 1904); H. O. Mercedith, *Protection in France* (London, 1904); S. N. Patten, *Economic Basis of Protection* (Philadelphia, 1890); Ugo Rabbeno, *American Commercial Policy* (London, 1895); Ellis H. Roberts, *Government Revenue, especially the American System*, an argument for industrial freedom against the fallacies of free trade (Boston, 1884); R. E. Thompson, *Protection to Home Industries* (New York, 1886); E. E. Williams, *The Case for Protection* (London, 1895); J. P. Young, *Protection and Progress: a Study of the Economic Bases of the American Protective System* (Chicago, 1900).

PROTECTOR, a Latin word (formed from *prolegere*, to cover in front) adopted into English. In post-classical Latin the *protectores* were the body-guards of the emperors, and of the Praetorian prefects until, under Constantine the Great (306-337), they ceased to exercise military functions. The *protectores*, with the *domestici*, continued to form the body-guard and household troops of the emperor. They were veterans selected from the legions, and were capable of being appointed to high commands. In the Roman curia the *protectores regnorum* are cardinals who take charge of the affairs of the "province" to which they are named which come before the Sacred College, and to present them for consideration. In England "protector" was used first for the regent during a minority (e.g. the Protector Somerset, and then by Oliver Cromwell when he assumed the government in 1653). The name thus acquired a revolutionary significance, and has not since been officially used in England. In Spanish America the bishops were officially protectors of the Indians. The title is convenient for a ruler who wishes to exercise control outside the limits of his direct sovereignty. Thus Napoleon called himself protector of the Confederation of the Rhine. The kings of France, and the governments which have arisen out of the Revolution, were protectors of the Latin Christians in the Turkish Empire, while the tsars of Russia have claimed the same position towards the Orthodox Christians.

See App. B. to vol. ii. of Bury's edition of the *Decline and Fall* (London, 1896); Du Cange, *Glossarium lat.*; Sorel, *L'Europe et la révolution française*, vol. vii. (Paris, 1904).

PROTECTORATE, in international law, now a common term to describe the relation between two states, one of which exercises control, great or small, direct or indirect, over the other. It is significant of the rare use of the term until recent times that the word does not occur in Sir G. C. Lewis's book on *The Government of Dependencies*. Yet the relation is very ancient. There have always been states which dominated their neighbours, but which did not think fit to annex them formally. It has always been politic for powerful states to facilitate and hide schemes of aggrandizement under euphemistic expressions; to cloak subjection or dependence by describing it in words inoffensive or strictly applicable to other relations. A common problem has been how to reduce a state to submission or subordination while ostensibly preserving its independence or existence; to obtain power while escaping responsibility and the expenditure attending the establishment of a regular administration. Engelhardt (*Les Protectorats anciens et modernes*) and other writers on the subject have collected a large number of instances in antiquity in which a true protectorate existed, even though the name was not used. Thus the Hegemony of Athens as it existed about 467 B.C., was a form of protectorate; though the subject states were termed allies, the so-called "allies" in all important legal matters had to resort to Athens (Meyer, *Geschichte des Alterthums*, vol. iii. § 274).

In dealing with dependent nations Rome used terms which veiled subjection (Gairal, *Les Protectorats internationaux*, p. 26). Thus the relationship of subject or dependent cities to the dominant power was described as that of *clientes* to the *patronus* (Marquardt, *Römische Staatsverwaltung*, 2nd ed., vol. i. p. 80). Such cities might also be described as *civitates foederatae* or *civitates liberae*. Another expression of the same fact was that certain communities had come under the power of the Roman people; *in deditionem* or *in fidem populi romani venire* (Marquardt, *Römische Staatsverwaltung*, i. 73, 81). The kingdoms of Numidia, Macedonia, Syria and Pergamum were examples of protected states, their rulers being termed *inservientes*.

The Romans drew a distinction between *foedera aequa* and *foedera iniqua*. The latter created a form of protectorate. But the protected state remained free. This is explained in a passage of the Digest 49. 15. 7: "Liber autem populus est is, qui nullius alterius populi potestati est subjectus, sive is foederatus est; item sive aequo foedere in amicitiam venit, sive foedere comprehensum est, ut is populus alterius populi majestatem comiter conservaret. Hoc enim adjicitur, ut intelligatur alterum populum superiorem esse: non ut intelligatur alterum non esse liberum" (Marquardt, *Römische Staatsverwaltung*, 2nd ed., vol. i. p. 46, Mommsen, *Römisches Staatsrecht*, vol. iii. pt. 1, p. 645, and the instances collected by Pufendorf, 8 c. 9. 4).

In medieval times this relation existed, and the term "protection" was in use. But the relation of subordination of one state to another was generally expressed in terms of feudal law. One state was deemed the vassal of another; the ruler of one did homage to the ruler of another. In his book *De la République* Bodin treats of *ceux qui sont en protection* (i. c. 7), or, as the Latin text has it, *de patrocinio et clientela*. In Bodin's view such states retain their sovereignty (i. c. 8). Discussing the question whether a prince who becomes a *cliens* of another loses his *majestas*, he concludes that, unlike the true vassal, the *cliens* is not deprived of sovereignty: "Nihilominus in foederibus et pacis actionibus, quae inter principes aut populos societate et amicitia conjunctissimos sancientur; eam vim habet ut nec alter alteri pareat, nec imperet: sed ut alter alterius majestatem observare, sine ulla majestatis minutione teneatur. Itaque jus illud clientelare seu protectionis omnium maximum ac pulcherrimum inter principes censetur" (i. c. 7). Elsewhere Bodin remarks, "le mot de protection est special et n'emporte aucune subjection de celui qui est en protection." He distinguishes the relation of *seigneur* and vassal from that of *protecteur* and *adherent*. As to whether the protected state or prince is sovereign, he remarks, "je tiens qu'il demeure souverain, et n'est point subject." He makes clear this conception of protection by adding "l'advoué ou adherent doit estre exempt de la puissance du protecteur s'il contrevient aux traictes de protection. Voila donc la plus grande sureté de la protection, c'est empescher s'il est possible que les protecteurs ne soyent saisis des fortresses" &c. (p. 549, ed. 1580). Sometimes letters of protection were granted by a prince to a weak state, as e.g. by Louis XIII. in 1641 to the prince of Monaco (Gairal, p. 81).

Reverting to the distinction in Roman law, Grotius and Pufendorf, with many others, treat protection as an instance of unequal treaties; that is, "when either the promises are unequal, or when either of the parties is obliged to harder conditions" (*De jure belli et pacis*, i. c. 13. 21; *De jure naturae*, 8. c. 9).

The following are some definitions of "protectorate": "Principis privilegium, quo ne alicui vis inferatur, cavetur, eumque in protectionem suscipit." Du Cange: "La situation d'un état à l'égard d'un autre moins puissant auquel il a promis son appui d'une manière permanente" (Gairal, *Definitions of Protectorate*, p. 52); a definition applicable only to certain simple forms of this relation. "Pour le protégé, une condition de souveraineté substituée à la pleine indépendance que comporte le régime de simple protection" (p. 58). "La situation respective de deux états de puissance inégale, dont l'un contracte l'obligation permanente de défendre l'autre, et en outre de le diriger" (p. 62). "Unter einem Protektorat versteht man ein Schutzverhältnis zwischen zwei Staaten des Inhalts dass der eine Staat, der Oberstaat oder schutzherrliche Staat, zum dauernden Schutz des anderen Staates—des Schutzstaates oder Unterstaates—verpflichtet ist; wofür ihm ein mehr oder weniger weitergehender Einfluss auf die auswärtigen Angelegenheiten desselben und theilweise auch auf dessen innere Verhältnisse eingeräumt ist" (von Stengel, *Die deutschen Schutzgebiete*, 11). "Das Verhältniss von zwei (oder mehreren) Staaten, das in materieller Beziehung auf dem dauernden Bedürfniss des Schutzes eines schwächeren Staates durch einen stärkeren beruht" (Ullmann, s. 26).

"The one common element in Protectorates is the prohibition of all foreign relations except those permitted by the protecting state. What the idea of a protectorate excludes, and the idea of annexation, on the other hand, would include, is that absolute ownership which was signified by the word *dominium* in Roman law, and which, though not quite satisfactorily, is sometimes described as 'territorial sovereignty.' The protected country remains, in regard to the protecting state, a foreign country; and

this being so, the inhabitants of the protectorate, whether native-born or immigrant settlers, do not by virtue of the relationship between the protecting and the protected state become subjects of the protecting state" (Lord Justice Kennedy, *Rex v. Crewe*, 1910, 79, *L.J.*, p. 802). "The mark of a protected state or people, whether civilized or uncivilized, is that it cannot maintain political intercourse with foreign powers except through or by permission of the protecting state" (Hall, *Foreign Jurisdiction of the British Crown*, p. 218). "A British protectorate is a country which is not within British dominions, but as regards its foreign relations is under the exclusive control of the King, so that its government cannot hold direct communication with any other foreign power, nor a foreign power with that Government" (Jenkyns, *British Rule and Jurisdiction beyond the Seas*, p. 165; Reinsch, *Colonial Government*, p. 109; Payne, *Colonies and Colonial Federations*, p. 194).

The term is used very loosely. Often it designates a relation which it is deemed politic to leave indefinite: a state desires to obtain the reality of conquest without the responsibilities attaching thereto. Protectorate may mean no more than what it says: "One state agrees to protect or guarantee the safety of another." The term is also employed to describe any relation of a political superior to an inferior state. It is also used as the equivalent of suzerainty. As appears from the article SUZERAINTY, the terms are distinguishable. But both imply a desire to carry out changes without friction and not to break up ancient forms; both proceed on the plan of securing to the stronger state the substance of power while allowing the weaker state a semblance of its old constitution. It is a form of empire or state building which appears when a powerful, expanding state comes in contact with feebler political organizations, or when a state falls into decay, and disintegration sets in. The creation of a protectorate is convenient for the superior and the inferior; it relieves the former from the full responsibilities incident to annexation; it spares to some extent the feelings of the latter.

Certain protectorates originate in treaties; others have been imposed by force. Some are accompanied by occupation, in which case it is difficult to distinguish them from annexation. Thus the treaty of May 1881, art. 2, between France and Tunis, provides for the occupation of strategical points by the protecting state (A. Devaulx, *Les Protectorats de la France*, p. 21).

The establishment of a protectorate may be akin to a guarantee. Generally, however, the former implies a closer relation than a guarantee; and the two relations may be widely different, as may be seen by comparing treaties of guarantee with the treaty establishing the protectorate of Tunis.

Strictly speaking, a protectorate cannot exist over a domain uninhabited or ruled by no organized state; in such cases the elements of the true protectorates are wanting. But the distinction is not adhered to. The difficulty of defining the relations between the protected and the protecting states is greater, because a protectorate may imply a condition of transition: a contractual or limited relation of state to state, more or less rapidly changing into true union.

It has been the policy of the British government in India to establish on the frontiers, as elsewhere, protectorates. The political advantages of the system are pointed out in Sir A. Lyall's *Rise and Expansion of the British Dominion in India*. It is a system "whereby the great conquering or commercial peoples masked, so to speak, their irresistible advance"; it was much practised by the Romans in Africa and

Asia; it has been chiefly applied in modern times in India (p. 326). The Indian states are sometimes described as "Feudatory States," sometimes "Independent and Protected States" (Twiss), sometimes "Mediatized States" (Chesney), sometimes "Half-Sovereign," sometimes as in a position of "subordinate alliance" (Lord Salisbury, *Parliamentary Papers*, 1897 [c. 8700]. § 27). The Interpretation Act, 1889 (52 & 53 Vic. c. 63, s. 18), refers to the Indian native princes as under the "suzerainty" of the British Crown. These states are really *sui generis*, and their precise position can be understood only by a private examination of the treaties affecting them. The following are the chief points as to which Indian states are subject to English law: (1) the governor-general is empowered to make laws for servants of the British government and European and native Indian subjects of his majesty; (2) British laws are in force in certain parts of the native states e.g. in cantonments; (3) native princes have adopted certain British laws, e.g. the Indian Penal Code; (4) they have no external relations with foreign states; (5) the king is the donor of honours; (6) acts of parliament affect them indirectly by

directly affecting the British agent; (7) they receive advice, which may be akin to commands. (See also Ilbert's *Government of India*, 2nd ed. p. 140).

Among the chief British protectorates are: The African groups, consisting of the western group—Gambia; Sierra Leone; Ashanti (northern territory); Northern Nigeria; Southern Nigeria (with which is amalgamated Lagos). The southern group—Bechuanaland; Southern Rhodesia; Swaziland. The central group—North-east Rhodesia and North-west Rhodesia; Nyasaland. The eastern group—British East Africa; Uganda; Zanzibar and Pemba (sometimes described as "a sphere of influence"); Somaliland; and the Sudan.

There is a group of protectorates near Aden, including the island of Sokotra. There are also the Bahrein Islands in the Persian Gulf. Jurisdiction over these protectorates is, generally speaking, exercised under orders in council made under the Foreign Jurisdiction Act 1890 (Burge's *Colonial and Foreign Law*, 2nd ed. p. 320). There is also the Malay group, consisting of the Malay States in the Borneo peninsula and in Borneo, the protectorates of North Borneo, Brunei and Sarawak. Protectorates also exist in the Western Pacific group of islands (including the Friendly Islands, the Ellice and Gilbert group, and the British Solomon Islands).

There is the interesting case of Papua (formerly British New Guinea), over which a protectorate was established in 1884, but which became in 1906 a territory of the Australian Commonwealth. There are also dependencies, or protectorates, attached to India, Baluchistan, Sikkim and Andaman Islands.

France possesses several protectorates, of which the chief are Tunis, Annam and Tongking. Her policy has been until lately to transform them into French territory. Such change has taken place as to Tahiti and Madagascar, and such in effect is the position of the Indo-China protectorates (Devaulx, *Les Protectorats de la France*; Report by Mr Lister, *Parl. Papers* 1908, Cd. 3883).

The chief German protectorates are South-west Africa, Togoland and Cameroon, German East Africa, Kaiser Wilhelm Land, Bismarck Archipelago, Solomon Islands, and Kiaochow—under lease from China—(*Zeitschrift für Kolonialrecht*, 1907, p. 311). Russia has the protectorates of Khiva and Bokhara; and China exercises or claims rights as protector of certain dependencies.

There are two principal classes of protectorates; the first being those exercised generally by treaty over civilized countries. Of the first, the chief are: (a) that of Cracow, which was recognized by the Treaty of Vienna as an independent state, and placed under the protection of Russia: it was incorporated with Austria in 1846; (b) Andorra, protected by Spain and France as successors of the counts of Foix (See ANDORRA); (c) the Ionian Islands, placed under the protection of Great Britain by the Treaty of Paris of 1815.

The second class of protectorates consists of those exercised by one civilized state over an uncivilized people, sometimes called a "Colonial Protectorate" or "pseudo-protectorate," and usually the preparatory step to annexation. These have become common, especially in Africa, since 1878. The second class may be subdivided into two groups: (a) protectorates exercised over countries with organized governments and under recognized sovereigns, such as the Malay States; and (b) those exercised over countries possessing no stable or definite governments and rulers. The territories of chartered companies, when not within the dominion of the protecting state, may also for some purposes be regarded as protectorates.

Attempts have been made to define the reciprocal rights and duties of protecting and protected states. Sometimes the treaty creating the relation defines the obligations. Thus in the treaty with respect to Sarawak the latter is described as an "independent state under the protection of Great Britain." "Such protection shall confer no right on his Majesty's government to interfere with the internal administration of that state further than is herein provided." The British consular officers are to receive exequaturs in the name of the government of Sarawak. Foreign relations are to be conducted by that government, and the raja cannot cede or alienate any part of the territory without the consent of the British government (Hertslet, 18. 227). In the treaty creating a protectorate over the territories of the king and chief of Opopo (Hertslet, 17. 130) the sovereign undertakes to extend to them, and to the territory under their authority and jurisdiction, his favour and protection. They promise not to

Existing
Protectorates.

Rights and
Duties of
Protecting
and
Protected
States.

Indian Pro-
tectorates.

enter into "any correspondence, agreement or treaty with any foreign nation or power, except with the knowledge and sanction of his Majesty's government." Some treaties establishing protectorates provide for direct interference with internal affairs; for example, the treaty of 1847 creating a French protectorate over Tahiti, and that of 1883 as to Tunis. Sometimes the *Oberstaat*—to use a convenient expression—is content to insist upon the presence of a resident, who guides the policy of the native ruler. In the case of protectorates over uncivilized countries it is usual to stipulate against alienation of territory without consent of the *Oberstaat*.

The legal position of protectorates is still somewhat undetermined; there are an old view and also a new view of their nature. The relation may be one of international law, two states having entered into obligations by treaty. Or the relation may be one of public law; one of two states has become subordinate to, and incorporated with, the other. The general rule is that the protected state does not cease to be a sovereign state, if such was its previous status. Its head is still entitled to the immunities and dignity of a sovereign ruler. Further, the establishment of a protectorate does not necessarily rescind treaties made between the protected state and other states, at all events when it is not in reality conquest or cession, or when any modification would be to the injury of third parties (*Parl. Papers*, Madagascar, 1897 [c. 8700]; Trione, 187). Nor does the new relation make any change as to the nationality of the subjects of the two states, though in some countries facilities are afforded to the subjects of the *Unterstaat* to transfer their allegiance; and they owe a certain ill-defined degree of obedience to the protecting state. Nor, speaking generally, does the territory of the protected state become part of the territory of the *Oberstaat*; in this respect is it unlike a colony, which may be regarded as an extension or outlying province of the country. At the same time, the question whether a particular protectorate forms part of the "dominion" or "territory" of the Crown for any purposes or within the meaning of any statute cannot be regarded as wholly free from doubt; its terms and intention must be examined. In *Rex v. Crewe* (1910, 79, L. J. 874) the Court of Appeal decided that the Bechuanaland Protectorate was not part of the dominion of the Crown, but was foreign territory. Several writers propose this distinction—the protected country is to be considered a part of the territory as to certain important sovereign rights, and as to other matters not. In one view, for the purpose of municipal law, the territory of a protectorate is not, but for the purposes of international law is, within the territory of the protecting state. In another view, such territory is foreign only in the sense that it is not within the purview of the majority of statutes (see Hall's *International Law*, 6th ed., 126, Heilborn, 535; Tupper's *Indian Protectorates*, 336; Laband, 2, § 70).

The older view of the position of a protectorate according to international law is contained in the decision of Dr Lushington in the case of the "Leucade" (8 S.T., n.s., 432), to the effect that, the declaration of war by Great Britain against Russia notwithstanding, the Ionian Islands, which were then under the protectorate of Great Britain, remained neutral. The king of Great Britain had the right of declaring peace and war. "Such a right is inseparable from protection." But the Ionian states did not become necessarily enemies of the state with which Great Britain was at war. According to one view, the protected state is implicated in the wars to which the protecting state is a party only when the latter has acquired a right of military occupation over the territory of the former. "Cette solution a été reconnue par la France en 1870, à propos de la guerre contre l'Allemagne pour les îles Taïti alors soumises à notre protectorat; elle s'imposerait pour la Tunisie, l'Annam et Tonkin, et pour le Cambodge, où les traités nous confèrent le droit d'occupation militaire" (M. Despagnet). In the event of hostilities between the protecting and protected states, such hostilities would be regarded not as of the nature of an insurrection, but as a regular war (Trione, 149).

By the General Act of the Berlin Conference it was agreed that the acquisition of a protectorate should be notified to the signatories to the agreement (art. 34), and it has been the practice to give such notice. It was proposed by some of the powers

represented that effective occupation should be a condition to the creation of a protectorate on the coast of Africa. But this was opposed by England, and was not adopted (Laband, ii. 680).

Many writers adhere to the doctrine that there is no impairment of sovereignty of the weaker state by the establishment of a protectorate. They also allege that it is *res inter alios acta*, an arrangement which concerns only parties to it. But the trend of recent policy and purport of much recent legislation are against this view. The distinct tendency, especially as to protectorates over uncivilized countries, is to treat, for purposes of international law, the territory of a protectorate as if it belonged to the protecting state. If France, for example, permitted in Tunis or other protectorates operations of an unfriendly character to any power, the injured power would no doubt look to France for redress. This view would probably be strongly pressed in the case of protectorates over countries having no well-defined or stable government. The probability is that in such cases governments and courts applying international law would probably be guided not by technical facts—such, to take the case of British possessions, as the fact that an order in council permitted appeals to the Judicial Committee—but would look to the facts of the case. "Any state which undertakes to protect another assumes towards the rest of the world responsibility for its good behaviour—the more complete protection the more extensive the responsibility—and this responsibility involves a duty to interfere if need be" (Coolidge, *United States as a World Power*, p. 167; and to the same effect Liszt, *Völkerrecht*, p. 31; and Zorn, *Völkerrecht*, p. 45). The tendency is for protecting states to assert jurisdiction over foreigners within the territories of the protected states (Westlake, 187; Jenkyns, p. 176; Ilbert, 2nd ed., 393, 434). Mr Hall remarks (*International Law*, 6th ed., p. 126 n.) that "all the states represented at the Berlin Conference of 1884–1885, with the exception of Great Britain, maintained that the normal jurisdiction of a protectorate includes the right of administering justice over the subjects of other civilized states." The General Act contemplated measures which are scarcely compatible with the exemption of European traders and adventurers from the local civilized jurisdiction. He points out that Great Britain—which until lately took the view that a protected state possesses only delegated powers, and that an Eastern state cannot grant jurisdiction over persons who are neither its own subjects nor subjects of the country to which the powers are delegated—had by the Pacific Order in Council of 1893 and the South African Orders in Council of 1891–1894 asserted jurisdiction over natives and foreign subjects. "The Orders show a gradual increase of the assumption of internal sovereignty" (Jenkyns, 193). A similar process is observable in the German protectorates, which are treated for some purposes as "inland," and not foreign territory (*Der koloniale Inlands- und Auslandsbegriff*, *Zeitschrift für Kolonialrecht*, 1907, p. 311). The fact is that in the case of protectorates over uncivilized or semi-civilized countries a development is inevitable: control quickly hardens into conquest, and international law more and more takes note of this fact.

AUTHORITIES.—Bodin, *Les Six livres de la République* (Lyons, 1580); *De republica libri sex* (Paris, 1586); Stengel, *Die Staats- und völkerrechtliche Stellung der deutschen Colonien* (1886); Heimbürger, *Der Erwerb der Gebietshoheit* (1888); D'Orgeval, *Les Protectorats allemands; annales de l'École des Sciences Politiques* (1890); Wilhelm, *Théorie juridique des protectorats* (1890); Despagnet, *Essai sur les protectorats* (1896); Heilborn, *Das völkerrechtliche Protectorat* (1891); Hall, *The Foreign Jurisdiction of the British Crown* (1894); Stengel, *Die deutschen Schutzgebiete* (1895); Gairal, *Les Protectorats internationaux; l'ézè, Étude théorique, &c., sur l'occupation, &c.* (1896); Trione, *Gli stati civili nei loro rapporti giuridici coi popoli barbari e semibarbari* (1889); Ilbert, *The Government of India* (1898); Jenkyns, *British Rule and Jurisdiction beyond the Seas* (1902); Laband, *Das Staatsrecht des deutschen Reiches* (1876–1882), *Revue de droit international, civilisés, et barbares*, xvii. 1, xviii. 188; Stengel, *Die Rechtsverhältnisse der deutschen Schutzgebiete* (1901); Devaulx, *Les Protectorats de la France* (1903) article "Protectorates" in the *Encyclopaedia of the Laws of England*, 2nd ed., vol. xi.; Baty, *International Law* (1909); Ullmann, *Völkerrecht*, § 26 (1908); *Rex v. Crewe* (1910) 79, L. J. 874; Von Stengel in *Zeitschrift für Kolonialrecht* (1909), p. 258; Sir W. Lee-Warner, *Protected States of India* (1910). (J. M.)

PROTEOMYXA, a name given by E. Ray Lankester (*Ency. Brit.*, 9th ed., 1885, art. "Protozoa,") to a group of Protozoa Sarcodina. The group was really recognized as distinct by Cienkowski and by Zopf, receiving the name of Monadinea from

"Monera" of Haeckel, supposed (erroneously in most if not all species adequately studied) to possess no nucleus in the protoplasm. The following are the characteristics of the group. Pseudopods usually granular, fine flexible, tapering generally, not freely branching; reproducing sometimes by simple fission, but more frequently by multiple fission in a brood-cyst whose walls may be multiple. Plasmodium formation occasional, but never leading to the formation of a massive fructification: other syngamic processes unknown, and probably non-existent. Encystment, or at least a resting stage at full growth, is very characteristic, and frequently an excretion of granules takes place into the first-formed cyst, whereupon a second inner cyst is formed which may be followed by a third. These brood-cysts, in which multiple fission takes place, may be of two kinds, ordinary and resting, the latter being distinguished by a firm, and usually ornamented and cuticularized cell-wall, and only producing its zoospores after an interval. Besides, an individual at any age may under unfavourable conditions surround itself with a "hypnocyte," to pass the time until matters are more suitable to active life, when it emerges unchanged.

From the initial character of the brood-cell on leaving the sporocyst the dividing character of the two orders is taken.

1. Zoosporeae, Zopf. The brood-cells leave the cyst as "Monads" (with one or two flagella). Genera: *Pseudospora*, Cienk.; *Protomonas*, Cienk.; *Diplophysalis*, Zopf.; *Gymnococcus*, Z.; *Aphelidium*, Z.; *Pseudosporidium*, Z.; *Plasmodiophora*, Woronin; *Tetramyxa*, Goebel.

2. Azoosporeae, Zopf. Genera: *Endyonema*, Z.; *Vampyrella*, Cienk. (figs. 1, 2, 3); *Leptophrys*, Hertw. and Less.; *Bursulla*, Sorokin; *Protogenes*, Haeck. (fig. 8); *Archerina*, Lank. (figs. 4-7); *Serosporidium*, L. Pfeiffer; *Lymphosporidium*, Calkins.

Many of the species are endoparasites in living cells, mostly of Algae or Fungi, but not exclusively. At least two species of *Pseudospora* have been taken for reproductive stages in the life history of their hosts—whence indeed the generic name. *Plasmodiophora brassicae* gives rise to the disease known as "Hamburries" or "fingers and toes" in Cruciferae; *Lymphosporidium* causes a virulent epidemic among the American brook-trout, *Salvelinus fontinalis*. *Archerina boltoni* is remarkable for containing a pair of chlorophyll corpuscles in each cell; no nucleus has been made out, but the chlorophyll bodies divide previous to fission. It is a fresh-water form. The cells of this species form loose aggregates or filoplasmodia, like those of *Mikrogromia* (Foraminifera, q.v.) or *Leydenia* (Labyrinthuloidea, q.v.), &c.

Vampyrella (figs. 1-3) and *Enteromyxa* also form a compact plasmodium which separates into 1-nucleate cells, which then encyst and divide into a brood of four.

BIBLIOGRAPHY.—F. Cienkowski in *Archiv für mikroskopische Anatomie* (1865); Haeckel, "Die Moneren," in *Jenaische Zeitschr.* (1868), vol. iv.; W. Zopf, "Die Monadineen," in *Schenk's Handbuch der Botanik* (1887), vol. iii. pt. ii., and *Beiträge zur Physiologie und Morphologie niederer Organismen* (1890); Delage and E. Hérouard, *Traité de zoologie concrète*, vol. i.; *La Cellule et les protozoaires* (1896); Marcus Hartog, *Cambridge Natural History* (1906), vol. i.

(M. HA.)

PROTESILAUS, in Greek legend, son of Iphiclus, and husband of Laodameia. In command of the Greek contingent from Phylace in Thessaly, he was the first to spring ashore on Trojan soil, although he knew it meant instant death. His wife besought the gods below that he might be permitted to return to earth for the space of three hours. Her prayer was granted, and on the expiration of the time allotted she returned with him to the nether world. According to Hyginus (*Fab.* 103, 104), Laodameia made a waxen image of her husband. A slave, having detected her in the act of embracing it and supposing it to be a lover, informed her father, who ordered her to burn the image; whereupon she threw herself with it into the flames. In another account (Conon, *Narrationes*, 13) Protesilaus survived the fall of Troy and carried off Aethilla, the sister of Priam. During a halt on the peninsula of Pallene, Aethilla and the other captive women set fire to the ships. Protesilaus, unable to continue his voyage, remained and built the city of Scione. His tomb and temple were to be seen near Eleus in the Thracian Chersonese. Nymphs had planted elm-trees, facing towards Troy, which withered away as soon as they had grown high enough to see the captured city. Protesilaus was the subject of a tragedy by Euripides, of which some fragments remain.

Iliad, ii. 698; Lucian, *Dial. mort.* xxiii. 1; Ovid, *Heroides*, xiii.; Philostratus, *Heroica*, iii.

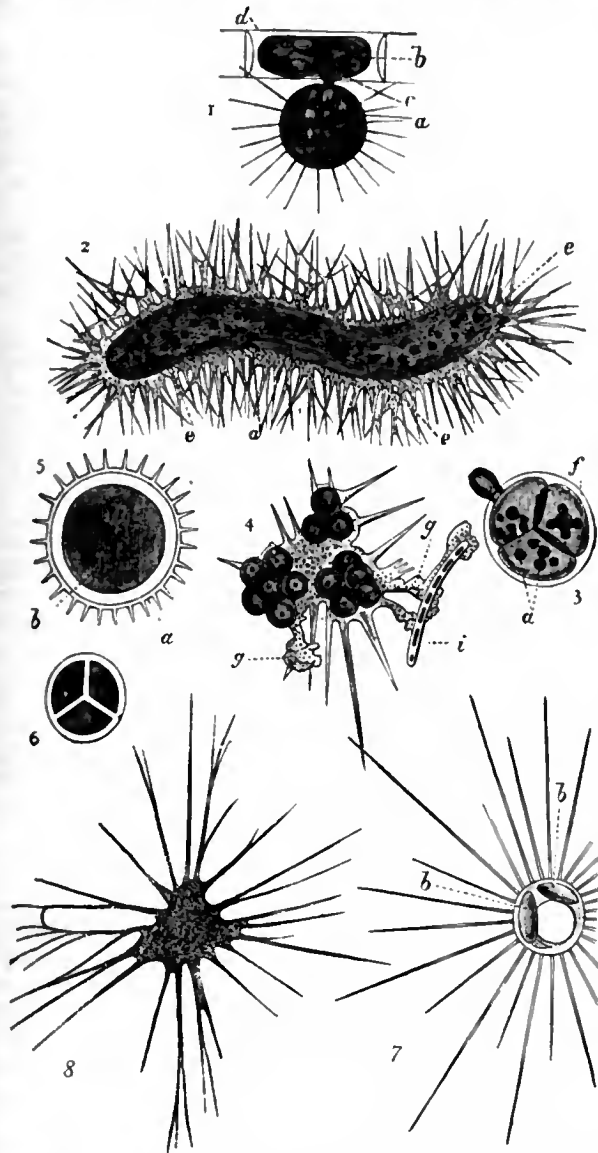

- 1, *Vampyrella spirogyrae*, Cienk., amoeba phase penetrating a cell of *Spirogyra b*, by a process of its protoplasm *c*, and taking up the substance of the *Spirogyra* cell, some of which is seen within the *Vampyrella a*.
- 2, Large individual of *Vampyrella*, showing pseudopodia *e*, and food particles *a*. The nucleus (though present) is not shown in this drawing.
- 3, Cyst phase of *Vampyrella*. The contents of the cyst have divided into four equal parts, of which three are visible. One is commencing to break its way through the cyst-wall *f*; *a*, food particles.
- 4, *Archerina boltoni*, Lankester, showing lobose and filamentous protoplasm, and three groups of chlorophyll corpuscles. The protoplasm *g* is engulfing a Bacterium *i*.
- 5, Cyst phase of *Archerina*: *a*, spinous cyst-wall; *b*, green-coloured contents.
- 6, Chlorophyll corpuscle of *Archerina* showing tetraschistic division.
- 7, Actinophryd form of *Archerina*: *b*, chlorophyll corpuscles.
- 8, *Protogenes primordialialis*, Haeckel (*Amoeba porrecta*, M. Schultze), from Schultze's figure.

the former; but as this name had been usually applied to Flagellates and even the zoospores are not always provided with flagella, Lankester's name has become more suitable, and has been adopted by Delage and Hérouard (1896) and by Hartog (1906). The group entered to a considerable extent into the

PROTESTANT, the generic name for an adherent of those Churches which base their teaching on the principles of the Reformation (*q.v.*). The name is derived from the formal *Protestatio* handed in by the evangelical states of the empire, including some of the more important princes and 14 imperial cities, against the *recess* of the diet of Spires (1529), which decreed that the religious *status quo* was to be preserved, that no innovations were to be introduced in those states which had not hitherto made them, and that the mass was everywhere to be tolerated. The name Protestant seems to have been first applied to the protesting princes by their opponents, and it soon came to be used indiscriminately of all the adherents of the reformed religion. Its use appears to have spread more rapidly outside Germany than in Germany itself, one cause of its popularity being that it was negative and colourless, and could thus be applied by adherents of the "old religion" to those of the "new religion," without giving offence, on occasions when it was expedient to avoid abusive language. The designation was moreover grateful to the Reformers as connoting a certain boldness of attitude; and Professor Kattenbusch (*Herzog-Hauck, Realencyklopädie*, 3rd ed., xvi. p. 136, 15) points out with great truth how, from this point of view, the name "Protestantism" has survived as embodying for many the conception of liberty, of the right of private judgment, of toleration for every progressive idea in religion, as opposed to the Roman Catholic principles of authority and tradition; so that many even of those who do not "profess and call themselves Christians" yet glory in the name of "Protestant."

As the designation of a Church, "Protestant" was unknown during the Reformation period and for a long while after. In Germany the Reformers called themselves usually *evangelici*, and avoided special designations for their communities, which they conceived only as part of the true Catholic Church; "Calvinists," "Lutherans," "Zwinglians" were, in the main, terms of abuse intended to stamp them as followers of one or other heretical leader, like Arians or Hussites. It was not until the period of the Thirty Years' War that the two main schools of the reformed or evangelical Churches marked their definitive separation: the Calvinists describing themselves as the "Reformed Church," the Lutherans as the "Lutheran Church." In France, in England, in Holland the evangelicals continued to describe their churches as *ecclesiae reformatae*, without the *arrière pensée* which in Germany had confined the designation "Reformed" to the followers of a particular church order and doctrine. As to the word "Protestant," it was never applied to the Church of England or to any other, save unofficially and in the wide sense above indicated, until the style "Protestant Episcopal Church" (see below) was assumed by the Anglican communion in the United States. Even in the Bill of Rights the phrase "Protestant religion" occurs, but not "Protestant Church," and it was reserved for the Liberal government, in the original draft (afterwards changed) of the Accession Declaration Bill introduced in 1910, to suggest "Protestant Reformed Church of England" as a new title for the Established Church.

The style "Protestant" had, however, during the 19th century assumed a variety of new shades of meaning which necessarily made its particular application a somewhat hazardous proceeding. In Germany it had, for a while, been assumed by the Lutherans as against the Calvinists, and when in 1817 King Frederick William III. of Prussia forcibly amalgamated the Lutheran and Reformed Churches in the new "Evangelical Church" its public use was forbidden in the Prussian dominions. It survived, however, in spite of royal decrees, but in an altered sense. It became—to quote Professor Kattenbusch—the "secular" designation of the adherents of the Reformation, the shibboleth of the "liberal" ecclesiastical and theological tendencies. Finally, in opposition to the ultramontane movement in the Roman Catholic Church, it came once more into fashion in something of its original sense among the evangelicals.

In the Church of England, on the other hand, the name "Protestant" has, under the influence of the High Church reaction, been repudiated by an increasingly large number of

the clergy and laity, and is even sometimes used by them in a derogatory sense as applied to their fellow churchmen who still uphold in their integrity the principles of the Reformation. Among the latter, on the other hand, "Protestantism" is used as exclusive of a good many of the doctrines and practices which in the Lutheran Church were at one time "Protestant" as opposed to "Reformed," e.g. the doctrine of the real Presence, auricular confession, the use of ceremonial lights and vestments. By many churchmen, too, the name of "Protestant" is accepted in what they take to be the old sense as implying repudiation of the claims of Rome, but as not necessarily involving a denial of "Catholic" doctrine or any confusion of the Church of England with non-episcopal churches at home or abroad.

In contradistinction to all these somewhat refined meanings, the term "Protestant" is in common parlance applied to all Christians who do not belong to the Roman Catholic Church, or to one or other of the ancient Churches of the East.

PROTESTANTENVEREIN is the name of a society in Germany the general object of which is to promote the union (*Verein*) and progress of the various established Protestant Churches of the country in harmony with the advance of culture and on the basis of Christianity. It was founded at Frankfort-on-the-Main in 1863 by a number of distinguished clergymen and laymen of liberal tendencies, representing the freer parties of the Lutheran and Reformed Churches of the various German states, amongst whom were the statesmen Bluntschli and Von Bennigsen and the professors R. Rothe, H. Ewald, D. Schenkel, A. Hilgenfeld and F. Hitzig. The more special objects of the association are the following: the development of the Churches on the basis of a representative parochial and synodal system of government in which the laity shall enjoy their full rights; the promotion of a federation of all the Churches in one national Church; resistance to all hierarchical tendencies both within and without the Protestant Churches; the promotion of Christian toleration and mutual respect amongst the various confessions; the rousing and nurture of the Christian life and of all Christian works necessary for the moral strength and prosperity of the nation. These objects include opposition to the claims of Rome and to autocratic interference with the Church on the part of either political or ecclesiastical authorities, efforts to induce the laity to claim and exercise their privileges as members of the Church, the assertion of the right of the clergy, laity and both lay and clerical professors to search for and proclaim freely the truth in independence of the creeds and the letter of Scripture. Membership in the association is open to all Germans who are Protestants and declare their willingness to co-operate in promoting its objects. The means used to promote these objects are mainly (1) the formation of local branch associations throughout the country, the duty of which is by lectures, meetings and the distribution of suitable literature to make known and advocate its principles, and (2) the holding of great annual or biennial meetings of the whole association, at which its objects and principles are expounded and applied to the circumstances of the Church at the moment. The "theses" accepted by the general meetings of the association as the result of the discussions on the papers read indicate the theological position of its members. The following may serve as illustrations:—

The creeds of the Protestant Church shut the doors on the past only, but open them for advance in the future; it is immoral and contrary to true Protestantism to require subscription to them. The limits of the freedom of teaching are not prescribed by the letter of Scripture, but a fundamental requirement of Protestantism is free inquiry in and about the Scriptures. The attempt to limit the freedom of theological inquiry and teaching in the universities is a violation of the vital principle of Protestantism. Only such conceptions of the person of Jesus can satisfy the religious necessities of this age as fully recognize the idea of his humanity and place in history. The higher reason only has unconditional authority, and the Bible must justify itself before its tribunal; we find the history of divine revelation and its fulfilment in the Bible alone, and reason bids us regard the Bible as the only authority and canon in matters of religious belief.

The formation of the association at once provoked fierce and determined opposition on the part of the orthodox sections

of the Church, particularly in Berlin. Attempts more or less successful have been made from the first to exclude clergymen and professors identified with it from the pulpits and chairs of Berlin and elsewhere, though membership in it involves no legal disqualification for either. One of the objects of the association was to some extent obtained by their organization of the Prussian Church when Dr Falk was cultus minister, on the basis of parochial and synodal representation, which came into full operation in 1879. But the election for the general synod turned out very unfavourable to the liberal party, and the large orthodox majority endeavoured to use their power against the principles and the members of the association. In 1882 the position of the association was rendered still more difficult by the agitation in Berlin of Dr Kalthoff and other members of it in favour of a "people's church" on purely dissenting and extremely advanced theological principles. This difficulty has continued, and the extreme rationalist position taken up by some leaders has alienated the sympathy not only of the obscurantists but of those who were prepared to go some distance in the direction of a liberal theology. There are now about 25,000 members in the 20 branches of the Verein.

See D. Schenkel, *Der deutsche Protestantenverein und seine Bedeutung für die Gegenwart* (Wiesbaden, 1868, 2nd ed. 1871); *Der deutsche Protestantenverein in seinen Statuten und den Thesen seiner Hauptversammlungen 1865-1882* (Berlin, 1883); P. Wehlhorn in Herzog-Hauck's *Realencyk. für prot. Theol. u. Kirche*; H. Weinl, "Religious Life and Thought in Germany To-day," *Hibbert Journal* (July 1909).

PROTESTANT EPISCOPAL CHURCH, in the United States, a part of the Anglican Communion, organized after the War of Independence by the scattered parishes of the Church of England which survived the war. It inherits from the Church of England, with which it is in communion, its liturgy, polity and spiritual traditions, though it has entire independence in legislation. While the clergy of both Churches are cordially received in their respective countries, there is no formal connexion between them except in fellowship and in advisory council as at the Lambeth Conference. The Church in the United States is therefore an independent national Church which has adapted itself to the conditions of American life.

With many likenesses, the Protestant Episcopal Church is different from the Church of England in its organization and representative form of government. It has the three orders of bishops, priests and deacons, and uses an almost identical liturgy; but it is a democratic institution in which the laity have practically as much power as the clergy, and they are represented in all legislative bodies. The constitution of the Church follows in many particulars the constitution of the United States. As the separate states of the Union are made up of different townships, so the diocese is composed of separate parishes; and as the nation is a union of the states, so the Church is a union of the dioceses. The American plan of representative government is consistently adhered to. The Church in America is thus a part of the Catholic Church of Christ, with its roots deep in the past and yet a living body with a life of its own, standing for the truth of the Christian religion in the great Republic. It is now firmly established in every state and Territory of the United States, and in all the dependencies, with also vigorous missions in foreign lands.

Services of the Church of England were held by the chaplains of exploring expeditions in various parts of North America before a settlement was established: on Hudson Bay, in 1578, and on the shores of the Pacific with Drake in 1579; but the first permanent foothold of the Church was in Jamestown, Virginia, in 1607, when a colony was founded and a church built. This fact is recognized in the proposed preamble to the constitution, in which it is stated that this American Church was "first planted in Virginia in the year of Our Lord 1607, by representatives of the ancient Church of England." Parishes were later founded in Maryland in 1676; in Massachusetts in 1686; in New York about 1693; in Connecticut in 1706; and in the other colonies during the 17th and 18th centuries. The growth of these colonial churches was largely promoted by the Society for the Propagation of the Gospel in Foreign Parts,

founded in 1701, through the efforts of the Rev. Thomas Bray, a missionary in Maryland. These churches scattered throughout the different colonies up to the American War of Independence were missions of the Church of England. They were under the jurisdiction of the Bishop of London, there being no bishop in America. The Bishop of London superintended these distant parishes by means of commissaries. Many of the clergy came from England; and when young men in America desired to be ordained, it was necessary for them to go to England for this purpose. The Church during the colonial period was incomplete in organization, and without the power of expansion. It was confined principally to the more settled parts of the country, though it had extended itself into all the colonies. During this period a few educational institutions were founded: the College of William and Mary in 1693, in Virginia; the Public Academy of Philadelphia, in 1749, now the university of Pennsylvania; and King's College, in 1754, in New York, now Columbia University. The clergy also frequently taught in parochial schools, and trained boys and girls in their homes.

When the war broke out and independence was declared, a number of the clergy went back to England, leaving their parishes vacant, but many, especially in the southern states, remained and upheld the American cause. A large majority of the laymen were patriots. Two-thirds of the signers of the Declaration of Independence were Episcopalians. The churches, having their support largely withdrawn by the Venerable Society, became very weak. In Massachusetts during the war only two churches were kept open.

After the war it was very soon recognized that if the Church was to survive, there must be organization and co-operation among the fragments left. Rev. William White (1748-1836) of Philadelphia, who had been chaplain of the Continental Congress, was a leader in the plan of organization. Rev. Samuel Seabury (1729-1796) of Connecticut was also an important factor in continuing the life of the Church. He was elected bishop by the clergy of Connecticut, and after being refused in England, was consecrated bishop of Connecticut by the Scotch non-juror bishops in Aberdeen on the 14th of November 1784. Later, William White of Pennsylvania and Samuel Provoost (1742-1815) of New York were consecrated bishops in the chapel at Lambeth Palace on the 4th of February 1787, by the archbishops of Canterbury and York and others. Rev. James Madison (1740-1812) of Virginia was also consecrated bishop in England, on the 10th of September 1790. An important meeting or general convention of laymen, clergy and bishops was held in 1784, and another in 1780, for the purpose of consolidating and uniting the Church. Certain fundamental principles were adopted which were the basis of organization: that the Episcopal Church be independent of all foreign authority; that it have full and exclusive power to regulate the concerns of its own communion; that the doctrines be maintained as in the Church of England; that bishops, priests and deacons be required; that the canons and laws be made by a more representative body of clergy and laity conjointly. At the general convention of 1780 a constitution and canons were finally adopted, and the book of Common Prayer was set forth.

The Church thus being fully organized, it was prepared to develop and extend. There was a long period, however, when little was done save retain what had already been gained. Owing in a measure to the popular prejudice against anything that savoured of England, and to the difficulty of adapting the newly formed institution to the conditions of American life, the Church hardly held its own from 1780 to 1811. The general convention of 1811 was attended by only five clergymen and four laymen more than that of 1780. The Church in Virginia especially suffered a decline, but in the North it maintained itself. After 1811 a new spirit manifested itself in the consecration of three important men to the episcopate. John Henry Hobart, a man of great zeal and devotion, became bishop of New York in 1811; Alexander Viets Griswold (1766-1843), a man of piety and force, became bishop of the eastern diocese of New England in 1811; and Richard Channing Moore (1762-1841), a

strong preacher and vigorous personality, was consecrated bishop of Virginia in 1814. Both Hobart and Moore became interested in theological education; and their efforts to train clergymen resulted in the establishment of the General Theological Seminary in New York in 1819, and the Theological Seminary in Virginia, opened in Alexandria in 1824. The *Churchman's Magazine* was started. Another evidence of expansion was the consecration in 1819 of Philander Chase (1775-1852), who became pioneer bishop of the West, first in Ohio where he laid the foundations (1824) of the "Theological Seminary of the Protestant Episcopal Church in the Diocese of Ohio," afterward called Kenyon College, at Gambier, and then in Illinois where he organized a church and founded Jubilee College. The Domestic and Foreign Missionary Society was started in 1821. This centralized the mission work, and became the great agency in the growth and extension of the Church. Bishop Jackson Kemper (1789-1870) in the North-west, and Bishop James Hervey Otey (1800-1863) in the South-west, did important pioneer work.

The period between 1835 and 1865 was characterized by further expansion of the episcopate and the formation of new dioceses. Bishop William Ingraham Kip (1811-1893) went to the miners of California in 1853. The dioceses of Oregon and Iowa were founded in 1854; and Bishop Henry Benjamin Whipple (1822-1901) was sent to Minnesota in 1859. The Church found its way into Indiana, Texas, Arkansas, Florida, Nebraska and Colorado. In 1835 there were 763 clergymen; in 1850 the number had increased to 1558; and even in 1865 there were 2450. The number of communicants also grew from 1835, when there were 36,000; to 1850, when there were 80,000; and to 1865, when there were 150,000. During this period some beautiful church buildings were erected, notably Trinity church and Grace church, New York. The services were richer; stained glass was used; stalls for the clergy and choir were introduced, and the lectern was substituted for the old-time reading-desk. Other educational institutions were founded: Nashotah, Wisconsin, in 1842; Bexley Hall at Gambier in 1839; Racine College, at Racine, Wisconsin; and Griswold College in Iowa.

When the Civil War broke out in 1861 the Church in the South met and formed a separate organization called "The Protestant Episcopal Church in the Confederate States," but the Church in the North did not recognize the secession; at the meeting of the general convention in New York in 1862, the roll of the Southern dioceses was called, and though absent, they were still considered a part of the Church in the United States. This brotherliness was an important factor in bringing about a complete union between the Northern and Southern Churches after the Civil War; so the Church in the Confederate States had but a temporary existence.

Since the Civil War the Church has grown with the expansion of national life. It has become strong in great centres, and has reached out into every part of the United States and its dependencies, and has maintained missionary stations in foreign lands. There are bishops and missionary dioceses in Alaska, Hawaii, the Philippine Islands, Porto Rico and Cuba; two bishops in China and two in Japan; and bishops in Liberia, Haiti, and Brazil.

Institutions of learning, schools, colleges and theological seminaries, have been founded. Prominent among the schools are St Paul's, at Concord, New Hampshire; St Mark's, at Southboro, Massachusetts; Groton School, at Groton, Massachusetts; St Mary's, at Garden City, Long Island; St Agnes's, at Albany, New York; St Mary's, at Burlington, New Jersey; the Cathedral School, at Washington D.C.; and St. George's School, at Newport, Rhode Island. In addition to the colleges already referred to, there should be included: Trinity College, at Hartford, Connecticut; St Stephen's, at Annandale, New York; the University of the South, at Sewanee, Tennessee; and Hobart College, at Geneva, New York. The theological seminaries, besides the general seminary in New York and the Virginia Seminary, are: the Divinity School, in Philadelphia; the Berkeley Divinity School, at Middletown, Connecticut; the Seabury Divinity School, at Faribault, Minnesota; Western Theological Seminary, in Chicago; Nashotah House, at Nashotah, Wisconsin; Bexley Hall, Gambier, Ohio; the Church Divinity School of the Pacific, San Mateo, California; and the Episcopal Theological School in Cambridge, Massachusetts.

Cathedrals have been built or were in process of construction in 1910 in many cities. Among them are: All Saints Cathedral, Milwaukee; the Cathedral of All Saints, Albany; the Cathedral of the Incarnation, Garden City, Long Island; the Cathedral Church of St Luke, Portland, Maine; St John the Divine, New York; and also those in Dallas, Texas, Washington, D.C., Davenport, Iowa, and Cleveland, Ohio.

The institutional life of the Church is constantly increasing. Among the numerous organizations founded for distinct purposes are: the Woman's Auxiliary to the Board of Missions; the American Church Building Fund Commission; the American Church Missionary Society; the General Clergy Relief Fund; the Assyrian Mission Committee; the American Church Institute for Negroes; the Brotherhood of St Andrew; the Girls' Friendly Society; the Church Students' Missionary Association; the Church Laymen's Union; the Seabury Society of New York; the Church Mission to Deaf Mutes; the Conference of Church Workers among the Colored People; the Society for the Increase of the Ministry; the Church Association for the Advancement of the Interests of Labor; the Church Temperance Society; the Church Unity Society; the Confraternity of the Blessed Sacrament; the Guild of the Holy Cross; the Guild of St Barnabas for Nurses; the Church Congress in the United States. In addition there are Sunday School commissions and institutes in almost every diocese. Among the religious orders may be mentioned the Society of Mission Priests of St John the Evangelist; the Order of the Holy Cross; the Community of St Mary; the Sisterhood of St Margaret; the All Saints Sisters of the Poor; the Sisterhood of St John Baptist; and others. There are also training schools for deaconesses, including the New York Training School for Deaconesses; and the Church Training and Deaconess House of the Diocese of Pennsylvania.

The Protestant Episcopal Church in the United States is governed according to the constitutions and canons adopted in 1789, and from time to time amended by the General **Govern-ment**. Convention, which meets every three years. The **Govern-ment**. General Convention consists of the House of Bishops, having as members all the bishops of the Church, and a House of Deputies, composed of four presbyters and four laymen elected by each diocese in union with the Convention; also one clerical and one lay deputy from each missionary district within the boundaries of the United States, and one clerical and one lay deputy chosen by the Convocation of the American Churches in Europe. The voting is by both houses acting separately and concurring. In the House of Deputies the vote is taken by orders, the clerical and lay deputies voting separately; and they must concur for a resolution to pass. This representative body legislates for the whole Church. Each diocese also has its own constitution and canons, by which it regulates its internal affairs, having also an annual diocesan convention, in which the clergy and laity are represented. A bishop is elected by the diocese, subject to confirmation by a majority of the bishops and standing committees of the different dioceses. Missionary bishops are elected by the House of Bishops and confirmed by the House of Deputies if the General Convention is in session; if not in session, by a majority of the standing committees. The presiding bishop of the Church was the senior bishop in order of consecration, until 1910, when an amendment to the constitution was adopted providing for his election by the General Convention. A special feature of the government of the Church is the power given to the laymen. In the parishes they elect their own clergyman; and they have votes in the diocesan convention and in the General Convention, and are thus an integral part of the legislative machinery of the Church.

The worship of the Church is conducted in accordance with the Book of Common Prayer, set forth in 1789, but changed from time to time as need has arisen. The preface states that "this Church is far from intending to depart from the Church of England in any essential part of doctrine, discipline or worship, or further than local circumstances require." This principle guided the Church in the early days, and continues in force. However, changes have been made in the direction of omission and addition. The Athanasian Creed is omitted, as well as all reference to the king and royal family. The Communion Service has been dropped. In the *Te Deum*, in place of "Thou didst not abhor the Virgin's womb," is substituted "Thou didst humble Thyself to be born of a Virgin." Many verbal

changes have been made. "Our Father which art in Heaven" is changed to "Who art in Heaven"; "Them that trespass" is changed to "Those who trespass." The Ornaments Rubric and the Black Rubric are omitted. The Communion Office is more like the Scottish office, having the Oblation and Invocation. Instead of the Commandments may be said our Lord's summary of the law. Special prayers and thanksgiving have been added, to be used upon several occasions. A form of the consecration of a church has been introduced, as well as an office for the institution of a minister and an office for the visitation of prisoners. The last revision of the American Prayer Book was in 1892; gospels for the Festival of the Transfiguration and for the early celebration of the Holy Communion on Christmas Day and Easter Day were added; and a greater flexibility in the use of the Prayer Book was permitted.

The statistics as reported by the General Convention of 1907 are as follows: the whole number of clergy, 5329; deacons ordained, 483; priests ordained, 471; candidates for holy orders, 469; postulants, 323; lay readers, 2464; baptisms, 197,203; persons confirmed, 158,931; communicants, 871,862; Sunday School officers and teachers, 47,871; pupils, 446,367; parishes and missions, 7615; church edifices, 7028; rectories, 2530; church hospitals, 72; orphan asylums, 57; homes, 84; academic institutions, 22; collegiate, 17; theological, 23; other institutions, 79; total contributions for all purposes, \$52,257,519; episcopal fund, \$3,499,838; hospitals and other institutions, \$17,509,085.

AUTHORITIES.—J. S. M. Anderson, *History of the Church of England in the Colonies* (3 vols., 2nd ed., London, 1856); Leighton Coleman, *The Church in America* (New York, 1895); A. L. Cross, *The Anglican Episcopate and the American Colonies* (New York, 1902); H. W. Foote, *Annals of King's Chapel* (2 vols., Boston, 1882-1887); George Hodges, *Three Hundred Years of the Episcopal Church in America* (Philadelphia, 1906); W. S. Perry, *History of the American Episcopal Church, 1587-1883, with Monographs* (2 vols., Boston, 1885); W. S. Perry, *Historical Collections Relating to the Episcopal Colonial Church, covering Virginia, Pennsylvania, Massachusetts, Maryland and Delaware* (4 vols., Hartford, 1870); S. D. McConnell, *History of the American Episcopal Church* (New York, 1890); D. D. Addison, *The Episcopalians* (New York, 1902); C. C. Tiffany, *A History of the Protestant Episcopal Church* (New York, 1905). (D. D. A.)

PROTEUS, in Greek mythology, a prophetic old man of the sea. According to Homer, his resting-place was the island of Pharos, near the mouth of the Nile; in Virgil his home is the island of Carpathus, between Crete and Rhodes. He knew all things past, present and future, and was loth to tell what he knew. Those who would consult him had first to surprise and bind him during his noonday slumber in a cave by the sea, where he was wont to pass the heat of the day surrounded by his seals. Even when caught he would try to escape by assuming all sorts of shapes: now he was a lion, now a serpent, a leopard, a boar, a tree, fire, water. But if his captor held him fast the god at last returned to his proper shape, gave the wished-for answer, and then plunged into the sea. He was subject to Poseidon, and acted as shepherd to his "flocks." In post-Homeric times the story ran that Proteus was the son of Poseidon and a king of Egypt, to whose court Helen was taken by Hermes after she had been carried off, Paris being accompanied to Troy by a phantom substituted for her. This is the story followed by Herodotus (ii. 112, 118), who got it from Egyptian priests, and by Euripides in the *Helena*. From his power of assuming whatever shape he pleased Proteus came to be regarded, especially by the Orphic mystics, as a symbol of the original matter from which the world was created. Rather he is typical of the ever-changing aspect of the sea (Homer, *Odyssey*, iv. 351; Virgil, *Georgics*, iv. 386).

PROTEUS (*Proteus anguinus*), in zoology, a blind perenni-branchiate tailed Batrachian, inhabiting the subterranean waters of the limestone caves to the east of the Adriatic from Carniola to Herzegovina. It was long supposed to be the sole representative of the Batrachians in the cave fauna, but other examples have been added in recent years. It is a small eel-like animal, with minute limbs, the anterior of which are tridactyle, the posterior didactyle, with a strongly compressed tail, a narrow head, with flat truncate snout, minute rudimentary eyes hidden under the skin, which is usually colourless, or rather flesh-coloured, with the short, plume-like external gills blood-

red; the jaws and palate are toothed. This extraordinary Batrachian has been found in a great number of different caves, but rather sporadically, and it is believed that its real home is in deeper subterranean waters, whence it is expelled at times of floods. It is often kept in aquariums, where it may turn almost black, and has bred in captivity. *Proteus* forms with *Necturus* (*Menobranchnus*) the family Proteidae. The second genus, which is widely distributed in eastern North America, is more generalized in its structure, having better developed limbs, with four digits, and is adapted to live in the light. But the two are closely allied, and *Necturus* gives us a very exact idea of what sort of a type *Proteus* must be derived from.

In 1896 a Proteus-like Batrachian was discovered in Texas during the operation of boring an artesian well 188 ft. deep, when it was shot out with a number of remarkable and unknown Crustaceans.

Typhlomolge rathbuni (see fig.), as this creature was called, agrees with *Proteus* in the shape of the head, in the absence of functional eyes, in the presence of external gills, and in the unpigmented skin. It differs in the very short body and the long slender limbs with four to five digits. It was first placed in the same family as *Proteus*, but the anatomical investigations of Ellen J. Emerson have led this author to believe that the real affinities are with the larval form of the lungless salamander *Spelerpes*, not with *Necturus* and *Proteus*. Whilst *Proteus* has lungs in addition to the gills, *Typhlomolge* lacks the lungs, and with them the trachea and larynx. It is therefore probable that *Typhlomolge* is a permanent larva derived from *Spelerpes*, whilst we are quite unable to assign any direct ancestor to *Necturus*.



Typhlomolge rathbuni.

Another blind Urodele has recently been described as *Typhlotriton spelaeus*, from caves in the Mississippi Valley. It has neither gills nor lungs in the adult, and is found under rocks in or out of the water. It is not allied to *Proteus*. The eyes are apparently normal in the larva, but in the adult they have undergone marked degeneration.

See P. Configliachi and M. Rusconi, *Del Proteo anguino* (Pavia, 1819), 4; J. de Bedriaga, *Lurchsauna Europas* (1897), ii. 28; E. Zeller, *Über die Fortpflanzung des Proteus anguinus*, *Jahresh. ver. Nat. Württemb.* (1889), p. 131; L. Steiner, "New Genus and Species of Blind Cave Salamanders from North America," *P. U.S. Nat. Mus.* (1892), xv. 115; idem, "New Genus and Species of Blind, Tailed Batrachians from the Subterranean Waters of Texas," *op. cit.* (1896), xviii. 619; Ellen J. Emerson, "General Anatomy of *Typhlomolge rathbuni*," *P. Boston Soc. N.H.* (1905), xxxii. 43.

PROTHESIS (Gr. πρόθεσις, a setting forth, from προτίθηναί, to set forward or before), in the liturgy of the Orthodox Eastern Church, the name given to the act of "setting forth" the oblation, i.e. the arranging of the bread on the paten, the signing of the cross (σφραγίζεω) on the bread with the sacred spear, the mixing of the chalice, and the veiling of the paten and chalice (see F. E. Brightman, *Liturgies Eastern and Western*, 1896). The term is also used, architecturally, for the place in which this ceremony takes place, a chamber on the north side of the central apse in a Greek church, with a small table. During the reign of Justin II. (565-574) this chamber was located in an apse, and another apse was added on the south side for the diaconicon (q.v.), so that from his time the Greek church was triapsal. In the churches in central Syria the ritual was apparently not the same, as both prothesis and diaconica are generally rectangular, and the former, according to De Vogué, constituted a chamber for the deposit of offerings by the faithful. Consequently it is sometimes placed on the south side, if when so placed it was more accessible to the pilgrims. There is always a much wider doorway to the prothesis than to the diaconicon, and there are cases where a side doorway from the

central apse leads direct to the diaconicon, but never to the prothesis.

PROTISTA, a name invented by Ernst Haeckel (*Generelle Morphologie der Organismen*, 1866) to denote a group of organisms supposed to be intermediate between the animal and vegetable kingdoms. As knowledge advanced the precise limits of the group shifted, and Haeckel himself, in successive publications, placed different sets of organisms within it, at one time proposing to include all unicellular animals and plants, making it a third kingdom equivalent to the animal and vegetable kingdoms. Partly because the term represented an interpretation rather than an objective set of facts, the word Protista has not been generally accepted for use in classification, and, whilst recognizing that the limits of the animal and plant kingdoms are not sharply defined, modern systematists refrain from associating these doubtfully placed organisms simply because of the dubiety of their position. (See PROTOZOA.)

PROTOCOL (Fr. *protocole*, Late Lat. *protocollum*, from Gr. *πρῶτος*, first, and *κολλᾶν*, to glue, *i.e.* originally the first sheet of a papyrus roll), in diplomacy, the name given to a variety of written instruments. The *protocollum* was under the late Roman Empire a volume of leaves, bound together with glue, in which public acts were recorded, so as to guard against fraud or error on the part of those responsible for preparing them; and in later usage it came to be applied to the original drafts of such acts. Thus, too, the word *prothocollare* was devised for the process of drawing up public acts in authentic form (Du Cange, *Glossarium lat. s.v. Protocollum*). The use of the word *protocollum* for the introductory and other formulae in the medieval diploma (see DIPLOMATIC) thus explains itself as implying a recorded usage in such matters.

In the language of modern diplomacy the name of "protocol" is given to the minutes (*procès-verbaux*) of the several sittings of a conference or congress; these, though signed by the plenipotentiaries present, have only the force of verbal engagements (see CONGRESS). The name of "protocols" is also given to certain diplomatic instruments in which, without the form of a treaty or convention being adopted, are recorded the principles or the matters of detail on which an agreement has been reached, *e.g.* making special arrangements for carrying out the objects of previous treaties, defining these objects more clearly, interpreting the exact sense of a doubtful clause in a treaty (*protocoles interprétatifs*) and the like. Thus the famous Troppau protocol, which annunciated the right and duty of the European powers to intervene in the internal affairs of a state threatened with revolution, was from the point of view of its signatories merely a logical application of the principles contained in the treaty of the 20th of November 1815 (see TROPPAU). Occasionally also an agreement between two or more powers takes the form of a protocol, rather than a treaty, when the intention is to proclaim a community of views or aims without binding them to eventual common action in support of those views or aims; thus the settlement of the question of the Danish succession was recognized by the powers in conference at London, by the protocol of 1852 (see SCHLESWIG-HOLSTEIN QUESTION).

Finally, "the protocol" (*protocole diplomatique, protocole de chancellerie*) is the body of ceremonial rules to be observed in all written or personal official intercourse between the heads of different states or their ministers. Thus the protocol lays down in great detail the styles and titles to be given to states, their heads, and their public ministers, and the honours to be paid to them; it also indicates the forms and customary courtesies to be observed in all international acts. "It is," says M. Pradier-Fodéré, "the code of international politeness."

See P. Pradier-Fodéré, *Cours de droit diplomatique* (Paris, 1899), ii. 499.

PROTOGENES, a Greek painter, born in Caunus, on the coast of Caria, but resident in Rhodes during the latter half of the 4th century B.C. He was celebrated for the minute and laborious finish which he bestowed on his pictures, both in drawing and in colour. Apelles, his great rival, standing astonished in presence of one of these works, could only console himself by

saying that it was wanting in charm. On one picture, the "Ialysus," he spent seven years; on another, the "Satyr," he worked continuously during the siege of Rhodes by Demetrius Poliorcetes (305-304 B.C.) notwithstanding that the garden in which he painted was in the middle of the enemy's camp. Demetrius, unsolicited, took measures for his safety; more than that, when told that the "Ialysus" just mentioned was in a part of the town exposed to assault, Demetrius changed his plan of operations. Ialysus was a local hero, the founder of the town of the same name in the island of Rhodes, and probably he was represented as a huntsman. This picture was still in Rhodes in the time of Cicero, but was afterwards removed to Rome, where it perished in the burning of the Temple of Peace. The picture painted during the siege of Rhodes consisted of a satyr leaning idly against a pillar on which was a figure of a partridge, so life-like that ordinary spectators saw nothing but it. Enraged on this account, the painter wiped out the partridge. The "Satyr" must have been one of his last works. He would then be about seventy years of age, and had enjoyed for about twenty years a reputation next only to that of Apelles, his friend and benefactor. Both were finished colourists so far as the fresco-painting of their day permitted, and both were laborious in the practice of drawing, doubtless with the view to obtaining bold effects of perspective as well as fineness of outline. It was an illustration of this practice when Apelles, finding in the house of Protogenes a large panel ready prepared for a picture, drew upon it with a brush a very fine line which he said would tell sufficiently who had called. Protogenes on his return home took a brush with a different colour and drew a still finer line along that of Apelles dividing it in two. Apelles called again; and, thus challenged, drew with a third colour another line within that of Protogenes, who then admitted himself surpassed. This panel was seen by Pliny (*N.H.* xxxv. 83) in Rome, where it was much admired, and where it perished by fire. In the gallery of the Propylaea at Athens was to be seen a panel by Protogenes. The subject consisted of two figures representing personifications of the coast of Attica, Paralus and Hammonias. For the council chamber at Athens he painted figures of the Thesmothetæ, but in what form or character is not known. Probably these works were executed in Athens, and it may have been then that he met Aristotle, who recommended him to take for subjects the deeds of Alexander the Great. In his "Alexander and Pan" he may have followed that advice in the idealizing spirit to which he was accustomed. To this spirit must be traced also his "Cydippe" and "Tlepolemus," legendary personages of Rhodes. Among his portraits are mentioned those of the mother of Aristotle, Philiscus the tragic poet, and King Antigonus. But Protogenes was also a sculptor to some extent, and made several bronze statues of athletes, armed figures, huntsmen and persons in the act of offering sacrifices.

PROTOGENES (E. Haeckel), a little-known genus of Foraminifera (*q.v.*), marine organisms, forming a naked flat disk with numerous long radiating pseudopodia; nucleus and contractile vacuole not seen, and reproduction unknown.

PROTOMYXA (E. Haeckel), a genus of Foraminifera (*q.v.*), marine organisms, of orange colour, naked and reproducing in a broad-cyst which liberates 1-flagellate zoospores.

PROTOPLASM, the name given in modern biology to a substance composing, wholly or in part, all living cells, tissues or organisms of any kind, and hence regarded as the primary living substance, the physical and material basis of life. The term "protoplasma," from *πρῶτος*, first, and *πλάσμα*, formed substance, was coined by the botanist Hugo von Mohl, in 1846, for the "tough, slimy, granular, semi-fluid" constituent of plant cells, which he distinguished from the cell-wall, nucleus and cell-sap. This was not, however, the first recognition of the true living substance as such, since this step had been achieved in 1835 by the French naturalist F. Dujardin, who in his studies on Foraminifera had proposed the term "sarcode" for the living material of their bodies in the following words: "Je propose de nommer ainsi ce que d'autres observateurs ont appelé une gelée vivante, cette substance glutineuse,

diaphane, insoluble dans l'eau, se contractant en masses globuleuses, s'attachant aux aiguilles de dissection, et se laissant étirer comme du mucus, enfin se trouvant dans tous les animaux inférieurs interposée aux autres éléments de structure." To the French naturalist belongs, therefore, the real credit of the discovery of protoplasm, or rather, to be more accurate, of the first recognition of its true nature as the material basis of vital phenomena. Neither Dujardin nor von Mohl, however, had any conception of the universal occurrence and fundamental similarity of protoplasm in all living things, whether animal or vegetable, and it was not till 1861 that the identity of animal sarcodite and vegetable protoplasm was proclaimed by Max Schultze, whose name stands out as the framer, if not the founder, of the modern notions concerning the nature of the living substance. From this time onwards the term "protoplasm" was used for the living substance of all classes of organisms, although it would have been more in accordance with the custom of priority in nomenclature to have made use of Dujardin's term "sarcodite."

A living organism, of any kind whatsoever, may be regarded as composed of (1) protoplasm, (2) substances or structures produced by the protoplasm, either by differentiation or modification of the protoplasm itself, or by the excretory or secretory activity of the living substance. The protoplasm of a given organism may be in a single individual mass, or may be aggregated into a number of masses or units, discontinuous but not disconnected, termed *cells* (see CYTOLOGY). Thus living organisms may be distinguished, in a general way, as unicellular or multicellular. An instance of a unicellular organism is well seen in an *Amoeba*, or in one of the Foraminifera, classic examples for the study of undifferentiated protoplasm, which here composes the greater part of the body, while products of the formative activity of the protoplasm are seen in the external shell and in various internal granules and structures. As an example of a multicellular organism we may take the human body, built up of an immense number of living cells which produce, singly or in co-operation, a variety of substances and structures, each contributing to the functions of the body. This, without attempting to enter into details, the horny epidermis covering the body, the hairs, nails, teeth, skeleton, connective tissue, &c., are all of them products formed by the metabolic activity of the living substance and existing in intimate connexion with it, though not themselves to be regarded as living. In addition to metabolic products of this kind, special modifications of the living substance itself are connected with specializations or exaggerations, as it were, of a particular vital function; such are the contractile substance of muscular tissue, and the various mechanisms seen in nervous and sensory tissue. It is necessary, therefore, in a living body of any kind, to distinguish clearly between simple protoplasm, its differentiations and its products.

Protoplasm from whatever source, whether studied in a cell of the human body, in an *Amoeba* or Foraminifer, or in a vegetable organism, is essentially uniform and similar in appearance and properties. Its appearance, graphically described by Dujardin in the passage quoted above, is that of a greyish, viscid, slimy, semi-transparent and semi-fluid substance. Its properties are those of living things generally, and the most salient and obvious manifestation of life is the power of automatic movement exhibited by living protoplasm. When free and not limited by firm envelopes, the movements take the character known generally as amoeboid, well shown in the common *Amoeba* or in the white corpuscles of the blood. When confined by rigid envelopes, as in plant-cells, the protoplasm exhibits streaming movements of various kinds. Even more essentially characteristic of the living matter than the power of movement is the property of metabolism—that is to say, the capacity of assimilating substances different from itself, of building them up into its own substance (anabolism), and of again decomposing these complex molecules into simpler ones (katabolism) with production of energy in the form of heat, movement and electrical phenomena. An important part of the metabolic process is respiration, i.e. the absorption of oxygen from the surrounding

medium and oxidation of carbon atoms to form carbonic acid gas and other simple chemical compounds; in ordinary plant and animal protoplasm the process of respiration seems to be of universal occurrence, but some Bacteria constitute apparently an exception to the rule. Metabolism results not only in the generation of energy, but also, if anabolism be in excess of katabolism, in increase of bulk, and consequent growth and reproduction.

Living protoplasm is, therefore, considered from a chemical standpoint, in a state of continual flux and instability, and it follows that if protoplasm be a definite chemical substance or mixture of substances (see below), a given sample of protoplasm cannot be pure, or at least cannot remain so for any length of time so long as its power of metabolism is being exerted, but will contain particles either about to be built up by anabolism into its substance, or resulting from katabolic disintegration of its complex molecules. Hence it is convenient to distinguish the living substance from its *metaplastic products* of anabolism and katabolism. Such products are to be recognized invariably in protoplasm and take the form generally of *granules* and *vacuoles*. Granules vary in size from very minute to relatively large, coarse grains of matter, usually of a firm and solid nature. To the presence of innumerable granules is due the greyish, semi-transparent appearance of protoplasm, which in parts free from granules appears hyaline and transparent. Different samples of protoplasm may vary greatly in the number and coarseness of the granulations. Vacuoles are fluid drops of more watery consistence, which, when relatively small, assume a spherical form, as the result of surface tension acting upon a drop of fluid suspended in another fluid. When vacuoles are numerous and large, however, they may assume various forms from mutual pressure, like air-bubbles in a foam. A good example of frothy protoplasm, due to the presence of numerous vacuoles, is seen in the common "sun-animalcule" (*Actinosphaerium*). Or when the cell is confined by an envelope, and becomes very vacuolated, the vacuoles may become confluent to form a cell-sap contained in a protoplasmic lining or "primordial utricle," and traversed by strands of protoplasm, as in the ordinary cells of plant-tissues. In many unicellular organisms, so-called contractile vacuoles are continually being formed as an act of excretion and expelled from the body when they reach a certain size.

While the majority of protoplasmic granules are probably to be regarded as metaplastic in nature, there is one class of granulations of which this is certainly not true, namely the grains of *chromatin*, so named from their peculiar affinity for certain dyes, such as carmine, logwood and various aniline stains. These grains may occur as *chromidia*, scattered through the protoplasm, or they may be concentrated at one or more spots to form a definite *nucleus* or *nuclei*, which may or may not be limited from the remaining protoplasm by a definite membrane, and may undergo further differentiations of structure which cannot be considered further here (see CYTOLOGY). The protoplasm of an ordinary cell is thus specialized into nucleus and cytoplasm. It was formerly thought that the most primitive forms of life, the Monera of E. Haeckel, consisted of pure protoplasm without a nucleus. It must be borne in mind, however, that chromatin can be present without being concentrated to form a definite nucleus, and that with imperfect technique the chromatin may easily escape observation. It seems justifiable at present to believe, until the contrary has been proved, that all organisms, however primitive, contain chromatin in some form: first, because this substance has always been found when suitable methods for its detection have been employed; secondly, because it has been shown experimentally, by cutting up small organisms, such as *Amoeba*, that enucleated fragments of protoplasm are unable to maintain their continued existence as living bodies; and, thirdly, because modern research has shown the chromatin to be of very great, perhaps fundamental, importance in regulating the vital processes of the cell and so determining the specific characters of the organism, a property which enables the chromatin to act

as the vehicle of heredity and to transmit the characters of parent to offspring. In the present state of our knowledge, therefore, the peculiar chromatin-granules must be regarded as an integral part, perhaps even the most essentially and primarily important portion, of the living substance. At the same time it must be borne in mind that the term "chromatin" does not denote a definite chemical substance, to be recognized universally by hard and fast chemical tests. The chromatin of different organisms or cells may behave quite differently in relation to stains or other reactions; and if it be true that it is the chromatin which determines the nature and activities of the cell, it follows that no two cells which differ from one another in any way can have their chromatin exactly similar. The conception of chromatin is one based upon its relations to the vital activities and life cycle, as a whole, of the organism or cell, and not upon any definable material, that is chemical and physical, properties.

The importance of protoplasm, as the physical and material basis of life, has caused it to be the subject in recent years of much minute and laborious research. It seems obvious that matter so peculiarly endowed must possess a complexity of structure and organization far exceeding that which at first sight meets the eye. Some biologists have attacked the problem of the ultimate constitution of protoplasm from a purely theoretical standpoint, and have framed hypotheses of an ultramicroscopic constitution sufficient, in their opinion, to explain, or at least to throw light upon, the vital activities of the living substance. Others, proceeding by more empirical methods, have attempted to lay bare the structure of protoplasm by means of the refinements of modern microscopical technique, or to solve the question of its constitution by means of chemical and physiological investigation. Hence a convenient distinction, not always easy, however, to maintain in practice, is drawn between *speculative* and *empirical* theories of protoplasm.

1. *Speculative theories* have come with the greatest frequency from those who have attempted to find a material explanation for the phenomena of heredity (*q.v.*). As instances may be mentioned more particularly the "gemmules" of Darwin, the "pangenes" of de Vries, the "plastidules" of Haeckel, and the "biophores" of Weismann. These theories have been ably brought together and discussed by Delage, who has included them all under the term "micromerism," since they agree in the assumption that the living substance contains, or consists of, a vast number of excessively minute particles—*i.e.* aggregates or combinations of molecules, which give to the protoplasm its specific properties and tendencies ("idioplasm" of Nägeli). In other cases the assumption of invisible protoplasmic units has been inspired by a desire either to explain the general vital and assimilative powers of protoplasm, as, for example, the "micellae" of Nägeli and the "plasomes" of Wiesner, or to elucidate the mechanism of some one function, such as the "inotagmas" of Engelmann, assumed to be the agents of contractility. In general, it may be said of all these speculations either that they can only be extended to all vital phenomena by the help of so many subordinate hypotheses and assumptions that they become unworkable and unintelligible, or that they only carry the difficulties a step further back, and really explain nothing. Thus it is postulated for Wiesner's hypothetical plasomes that they possess the power of assimilation, growth and reproduction by division; in other words, that they are endowed with just those properties which constitute the unexplained mystery of living matter.

2. *Empirical theories of protoplasm* differ according as their authors seek to find one universal type of structure or constitution common to all conditions or differentiations of the living substance, or, on the contrary, are of opinion that it may vary fundamentally in different places or at different times. From these two points of view protoplasm may be regarded either as *monomorphic* or *polymorphic* (Fischer). The microscopical investigation of protoplasm reveals at the first glance a viscid, slimy or mucilaginous substance, in which is embedded an immense number of granules, for the most part very tiny. Very rarely are these granules absent, and then only from a portion

of the protoplasm, and only temporarily. Hence many authorities have regarded the minute granules—the "microsomes" of Hanstein—as themselves the ultimate living units of protoplasm, in opposition to those who would regard them merely as "metaplastic" substances, *i.e.* as the heterogeneous by-products of metabolism and vital activity. The *granular theory*, as this conception of the living substance is called, has received its extreme elaboration at the hands of Altmann, whose standpoint may be taken as typical of this class of theories. After demonstrating the universal occurrence of granules in protoplasm, Altmann has compared each individual granule to a free-living bacterium, and thus regards a cell as a colony of minute organisms, namely the granules or *bioblasts*, as he has termed them, living embedded in a common matrix, like a zoogloea colony of bacteria. Of this theory it may be remarked, firstly, that it brings us no nearer to an explanation of vital phenomena than do the plasomes of Wiesner; secondly, that to consider bacteria as equivalent, not to cells, but to cell granules, is to assume for this class of organisms a position with regard to the cell theory which is, to say the least, doubtful; and, thirdly, that the observations of the vast majority of competent microscopists furnish abundant support for the statement that granules of protoplasm do not lie free in a structureless matrix, but are embedded in the substance of a minute and delicate framework or *morphoplasm*, which in its turn is bathed by a watery fluid or *enchylema* permeating the whole substance. The upholders of the granular theory deny the existence of the framework, or explain it as due to an arrangement of the granules, or as an optical effect produced by the matrix between the granules. Amongst those, on the other hand, who assert the existence of a framework distinct from granules and enchylema, the utmost diversity of opinion prevails with regard to the true structural relations of these three parts and the rôle played by each in the exercise of vital functions. Some have regarded the framework as made up of a tangle of separate fibrillae (*filar theory*)—a view more especially connected with the name of Flemming—but most are agreed that it represents the appearance of a *reticulum* or network with excessively fine meshes, usually from $\frac{1}{2}$ to 1μ in diameter. The reticulum carries the granules at its nodal points, and is bathed everywhere by the enchylema. Even with so much in common, however, opinions are still greatly at variance. In the first place, the majority of observers interpret the reticulum as the expression of an actual spongy framework, a network of minute fibrillae ramifying in all planes. While, however, Heitzmann, following the speculations of Brücke, considered the framework itself to be actively contractile and the seat of all protoplasmic movement, an opposite point of view is represented by the writings of Leydig, Schäfer and others, who regard the reticulum merely as a kind of supporting framework or *spongioplasm*, in which is lodged the enchylema or *hyaloplasm*, considered to be itself the primary motile and living substance. Bütschli, on the other hand, has pointed out the grave difficulties that attend the interpretation of the reticulum as a fibrillar framework, in view of the distinctly fluid consistence of, at any rate, most samples of protoplasm. For if the substance of the framework be assumed to be of a firm, solid nature, then the protoplasm as a whole could not behave as a fluid, any more than could a sponge soaked in water. On the other hand, the hypothesis of a fluid fibrillar framework leads to a physical impossibility, since one liquid cannot be permanently suspended in another in the form of a network. Bütschli therefore interprets the universally present reticulum as a meshwork of minute lamellae, forming a honeycombed or *alveolar* structure, similar to the arrangement of fluid lamellae in a fine foam or lather, in which the interstices are filled, not with air but with another fluid; in other words, the structure of protoplasm is that of an exceedingly fine emulsion of two liquids not miscible with one another.

It may be claimed for the *alveolar theory* of Bütschli that it throws light upon many known facts relating to protoplasm. It interprets the reticulum as the optical section of a minute foam-like structure, and permits the formation of protoplasmic striations and of apparent fibrillae as the result of linear or radiating dispositions of the alveolar

framework; it reconciles with the laws of physics the combination of a framework with a fluid or semi-fluid aggregate condition, while variations in the fluidity of the framework are compatible with a stiffening of the protoplasm almost to the pitch of rigidity, as seen, for example, in nervous tissue; and, finally, it explains many characteristic structural peculiarities of protoplasm, such as the superficial layer of radiately arranged alveoli, the spherical form of vacuoles, the continuous wall or pellicle which limits both the vacuoles and the protoplasm as a whole, and many other points not intelligible on the theory of a sponge-like structure. Bütschli has succeeded, moreover, in producing artificial foams of minute structure, which not only mimic the appearance of protoplasm, but can be made to exhibit streaming and amoeboid movements very similar to those of simple protoplasmic organisms. Incidentally these experiments have shown that many of the apparent granulations and "microsomes" are an optical effect produced by the nodes of the minute framework. In his most recent works Bütschli has extended his theory of alveolar structure to many other substances, and has tried to prove that it is a universal characteristic of colloid bodies, a view strongly combated, however, by Fischer. While it cannot be claimed that Bütschli's theory furnishes in any way a complete explanation of life, leaving untouched, as it does, the fundamental question of assimilation and metabolism, he at least draws attention to a very important class of facts, which, if demonstrated to be of universal occurrence, must be reckoned with in future treatment of the protoplasm question, and would form an indispensable preliminary to all speculations upon the mechanism of the living substance.

In opposition to the above-mentioned monomorphic theories of protoplasm, all of which agree in assuming the existence of some fundamental type of structure in all living substance, attempts have been made at various times to show that the structural appearances seen in protoplasm are in reality artificial products, due to precipitation or coagulation caused by reagents used in the study or preparation of living objects. These views have been developed by Fischer, who by experimenting upon various proteids with histological fixatives, has shown that it is possible to produce in them a granular, reticular or alveolar structure, according to treatment, and, further, that granules so produced may be differentially stained according to their size and absorptive powers. Fischer therefore suggests that many structural appearances seen in protoplasm may be purely artificial, but does not extend this view to all such structures, which would indeed be impossible, in view of the frequency with which reticular or alveolar structures have been observed during life. He suggests, however, that such structures may be temporary results of *vital precipitation* of proteids within the organism, and that protoplasm may have at different times a granular reticular or alveolar structure, or may be homogeneous. Fischer's conception of living protoplasm is therefore that of a polymorphic substance, and a similar view is held at the present time by Flemming, Wilson and others. Strassburger also regards protoplasm as composed of two portions: a motile *kinoplasm* which is fibrillar, and a nutritive *trophoplasm* which is alveolar, in structure.

The chemical investigation of protoplasm labours at the outset under the disadvantage that it cannot deal with the living substance as a whole, since no analysis can be performed upon it without destroying the life. Protoplasm consists, to the extent of about 60% of its total mass, of a mixture of various *nucleo-proteids*—that is to say, of those substances which, in molecular structure and chemical composition, are the most complex bodies known. In association with them are always found varying amounts of fats, carbohydrates, and other bodies, and such compounds are always present in the living substance to a greater or less degree as products of both upward and downward metabolism. Protoplasm also contains a large but variable percentage of water, the amount of which present in any given case affects largely its fluid or viscid aggregate condition. Especial interest attaches to the remarkable class of bodies known as *ferments* or *enzymes*, which when prepared and isolated from the living body are capable of effecting in other substances chemical changes of a kind regarded as specifically vital. It is from their study, and from that of the complex proteids found in the living body, that the greatest advances towards an explanation of the properties of living matter may be expected at the present time.

The question may be raised how far it is probable that there is one universal living substance which could conceivably be isolated or prepared in a pure state, and which would then exhibit the phenomena characteristic of vital activity. It is sufficiently obvious, in the first place, that protoplasm, as we know it, exhibits infinite diversity of character, and that no two samples of protoplasm are absolutely similar in all respects. Chemical differences must be assumed to exist not only between the vital fabrics of allied species of organisms, but even between those of individuals of the same species. Kassowitz regards this variability as compatible with the assumption of a gigantic protoplasmic molecule in which endless variations arise by changes in the combinations of a vast number of atoms and atom complexes. It is difficult to conceive, however, of any single substance, however complex in its chemical constitution, which could perform all the functions of life. To postulate a universal living substance is to proceed along a path which leads inevitably to the assumption of biophores, plastidules or other similar units, since the ultimate living particles must then be imagined as endowed at the outset with many, if not all, of the fundamental properties and characteristic actions of living bodies. Such a conception has as its logical result a vitalistic standpoint, which may or may not embody the correct mental attitude with regard to the study of life, but which at any rate tends to check any further advance towards an explanation or analysis of elementary vital phenomena. We may rather, with Köffiker, Verworn and others, ascribe the activities of protoplasm to the mutual interaction of many substances, no single one of which can be considered as living in itself, but only in so far as it forms an indispensable constituent of a living body. From this point of view life is to be regarded, not as the property of a single definite substance, but as the expression of the ever-changing relations existing between the many substances which make up the complex and variable congeries known to us as protoplasm.

AUTHORITIES.—For exhaustive historical summaries of the protoplasm question, with full bibliographical references, the reader may be referred to the following works, especially the first five: Bütschli, *Investigations on Microscopic Foams and Protoplasm* (London, 1894); *Untersuchungen über Strukturen* (Leipzig, 1898); "Meine Ansicht über die Struktur des Protoplasmas und einige ihrer Kritiker," *Arch. f. Entwicklungsmechanik d. Org.* (1901); xi. 499-584, pl. xx.; Delage, *La Structure du protoplasme et les théories sur l'hérédité* (Paris, 1895); Wilson, *The Cell* (2nd ed., London, 1900); Fischer, *Fixierung, Färbung, und Bau des Protoplasmas* (Leipzig, 1899); Kassowitz, *Allgemeine Biologie* (Vienna, 1899); G. Mann, *Protoplasm, its Definition, Chemistry and Structure* (Oxford, 1906), p. 59. (E. A. M.)

PROTOZOA (Gr. *πρῶτος*, first, and *ζῶον*, living thing), the name given by modern zoologists to the animalcules, for the most part microscopic, which were termed by the older naturalists Infusoria, from the manner in which they appear in infusions containing decaying animal and vegetable matter. The name Infusoria is now, however, restricted to one of the four classes which comprise the Protozoa proper. The name Protozoa was coined as far back as 1820 as an equivalent for the German word *Urthiere*, meaning animals of primitive or archaic nature, the forms of animal life which may be supposed to have been the first that appeared upon our globe. The great naturalist C. T. von Siebold was, however, the first to give a scientific definition to the group. Von Siebold pointed out that in the Protozoa the individual was always a single vital unit or *cell*, in contrast with the higher division of the animal kingdom, the Metazoa, in which the body is generally, though not universally, regarded as composed of many such units. To put the matter briefly and somewhat technically: the Protozoa are unicellular animals, the Metazoa multicellular animals; in the Protozoa the cell is complete in itself, both morphologically and physiologically, and is capable of maintaining a separate and independent existence in suitable surroundings, like any other organism; in the Metazoa the cells are differentiated for the performance of distinct functions and combined together to form the various tissues of which the body is built up, and the individual cells of the Metazoan body are not capable of maintaining a separate existence apart from their fellows. This is the sense in which the term Protozoa is used by zoologists, whereby certain forms of animal life, which were formerly ranked as Protozoa, such as sponges and rotifers, are now definitely excluded from the group and classed as Metazoa.

The animal kingdom may be divided, therefore, into two sub-kingdoms, the Protozoa and the Metazoa, the first-named characterized by their essentially unicellular nature. This is a criterion by which it is easy to define the Protozoa from a purely

zoological standpoint, but which becomes less satisfactory when we take into consideration the whole range of microscopic unicellular organisms. Besides the true Protozoa, which, *ex hypothesi*, are organisms of animal nature, there are many other organisms of equally simple organization, including the Bacteria and the unicellular plants. The Bacteria stand sharply apart from the other forms of life, not only, in many cases, by their divergent methods of metabolism, but by morphological characteristics, such as the definite body-form limited by a distinct envelope, the absence of organs for locomotion other than the peculiar flagella, and, above all, by the lack of any differentiation of the body-protoplasm into nucleus and cytoplasm, as in all true cells of either animal or vegetable nature. On the other hand, to separate by hard-and-fast definitions the unicellular plants from the unicellular animals is not only difficult but practically impossible. The essential difference between plant and animal is a physiological one, a difference in the method of nutrition. A typical green plant is able to live independently of other organisms and to build up its substance from simple gases in the air and inorganic salts in the soil or water, provided that certain conditions of light and moisture be present in its environment; this is the so-called holophytic method of nutrition. A typical animal, on the other hand, while practically independent of sunlight, is not able to exist apart from other living organisms, since it is not able to build up its substance from simple chemical constituents like a plant, but must be supplied with ready-made proteids in its food, for which it requires other organisms, either plants or animals; this is the so-called holozoic method of nutrition. Intermediate between these two habits of life is the so-called saprophytic habit, exemplified by the fungi amongst plants; in this method of nutrition the organism cannot build up its substance entirely from inorganic substances, but absorbs the organic substances present in solutions containing organic salts or decaying animal or vegetable matter.

If we regard the organisms termed collectively Protozoa from the point of view of their methods of nutrition (considering for the present only free-living, non-parasitic forms), we find in one class, the Flagellata, examples of the three methods mentioned above, the holozoic, holophytic and saprophytic habit of life, not only in species closely allied to each other, but even combined in one and the same species at different periods of its life or in different surroundings. An individual of a given species may contain chlorophyll, with which it decomposes carbonic acid gas in the sunlight, like a plant, while possessing a definite mouth-aperture, by means of which it can ingest solid food, like an animal. Such instances show clearly that in the simplest forms of life the difference between plant and animal is but a difference of habit and of mode of nutrition, to which the organism is not at first irrevocably committed, and which are not at first accompanied by distinctive morphological characteristics. Only when the organism becomes specialized for one or the other mode of life exclusively does it acquire such definite morphological characters that the difference between plant and animal can be used for the purpose of a natural classification, as in the higher forms of life. In the lowest forms it is not possible to base natural subdivisions on their vegetable or animal nature. For this reason it has been proposed by E. Haeckel to unite all the primitive forms of life in which the body is morphologically equivalent to a single cell into one group, the Protista, irrespective of their animal or vegetable nature. In this method of dealing with the problem the Protista are regarded as a distinct kingdom (*Reich*), more or less intermediate between, but distinct from, the animal and vegetable kingdoms, and representing the ancestral stock from which both animals and plants have sprung. Many authorities have followed Haeckel's lead in the matter, and the science of Protistology or *Protistenkunde* has already a special journal devoted to the publication of researches upon it. But though it may be more scientific, from a theoretical point of view, to group all these primitive organisms together in the way suggested by Haeckel, in practice it is inconvenient, on account of the

vast number of forms of life to be comprised as Protista, their diversity in habit of life and organization, and, above all, the difference in the technical methods required for their study, which becomes too complicated for a single worker. Hence Protistology becomes split up in practice by its own mass into three sciences: the Bacteria are the objects of the science of bacteriology; botanists deal with the unicellular plants; and the zoologists with those Protista which are more distinctly animal in their characters.

Hence the Protozoa are to be regarded as a convenient rather than a natural group, and may be characterized generally as follows: Organisms in which the individual is a single cell, that is to say, consists of a single undivided mass of protoplasm which is capable of independent existence in a suitable environment; if many such individuals be combined together to form a colony, as frequently occurs, there is no differentiation of the individuals except for reproductive purposes, and never for tissue-formation as in the Metazoa. The body always contains chromatin or nuclear substance, which may be disposed in various ways, but usually forms one or more concentrated masses termed nuclei, which can be distinguished sharply from the general body-protoplasm or cytoplasm. The protoplasmic body may be naked at the surface, or may be limited and enclosed by a distinct envelope or cell-membrane, which is not usually of the nature of cellulose, except in holophytic forms. Organs serving for locomotion and for the capture and assimilation of solid food are usually present, but may be wanting altogether when the mode of nutrition is other than holozoic; chlorophyll, on the other hand, is only found as a constituent of the body-substance in the holophytic Flagellata.¹ To these characters it may be added that reproduction is effected by some form of fission, or division of the body into smaller portions, and that in the vast majority of Protozoa, if not in all, a process of conjugation or *syngamy* occurs at some period in the life-cycle, the essential feature of the process being fusion of nuclear matter from distinct individuals. The foregoing definition does not distinguish the Protozoa sharply from the primitive forms of plant-life, with which, as stated above, they are connected by many transitions; but the differentiation of the body-substance into nucleus and cytoplasm separates them at once from the Bacteria, in which the chromatin is distributed evenly through the body-protoplasm.

Protozoa and Disease.—The study of the Protozoa has acquired great practical importance from the fact that many of them live as parasites of other animals, and as such may be the cause of dangerous diseases and epidemics in the higher forms of animal life and in man (see PARASITIC DISEASES). Examples of parasitic forms are to be found in all the four classes into which, as will be stated below, the Protozoa are divided, and one class, the Sporozoa, is composed entirely of endoparasitic forms. Hence Protozoology, as it is termed, is rapidly assuming an importance in medical and veterinary science almost equal to that of bacteriology, although the recognition of Protozoa as agents in the production of disease is hardly older than a decade. The most striking instances of Protozoa well established as pathogenic agents are the malarial parasites, the species of *Piroplasma* causing haemoglobinuria of cattle and other animals, the trypanosomes causing tsetse-fly disease, surra, sleeping sickness, and other maladies, the species of *Leishmania* causing kala azar and oriental sore, and the *Amoeba* responsible for the so-called amoebic dysentery. Other diseases referred, but as yet doubtfully, to the agency of Protozoa are syphilis, small-pox, hydrophobia, yellow fever, and even cancer.

It is only possible here to discuss briefly in a general way the relations of these parasites to their hosts. When two organisms stand habitually in the relation of host and parasite, an equilibrium tends to become established gradually between them, so

¹ Many Protozoa contain symbiotic green organisms, so-called zoochlorellae or zooxanthellae, in their body-protoplasm; for instance, Radiolaria, and Ciliata such as *Paramecium bursaria*, &c. This condition must be carefully distinguished from chlorophyll occurring as a cell-constituent.

that a condition is brought about in which, after many generations, the host becomes "tolerant" of the parasite, and the parasite is not lethal to the host, though perhaps capable of setting up considerable disturbance in its vital functions. Many animals are found to contain almost constantly certain internal parasites without being, apparently, in the least affected by them; and it should be borne in mind that in most cases it is not to the interest of the parasite to destroy the host or to overtax its resources. But when the parasite is transferred naturally or artificially to a species or race of host which does not ordinarily harbour it, and which therefore has not acquired powers of resisting its attacks, the parasites may be most deadly in their effects. Thus the white traveller in the tropics is exposed to far greater dangers from the indigenous disease-producing organisms than are the natives of those climes.

In some cases two organisms have become mutually adapted to each other as host and parasite to such an extent that the parasite is not capable of flourishing in any other host. An instance of this is *Trypanosoma lewisi* of the rat, which cannot live in any other species of animal but a rat, and which is not as a rule lethal to a rat, at least not to one otherwise healthy. Contrasting in an instructive manner with this species is *Trypanosoma brucei*, which occurs as a natural parasite of buffaloes and other big game in Africa, and is, apparently, harmless to them, but which is capable of being transferred to other animals by inoculation. The transference may take place naturally, by the bite of a tsetse-fly, or may be effected artificially; in either case *T. brucei* is extremely lethal to certain animals, such as imported cattle, horses and dogs, or to rats and guinea-pigs. Other animals, however, may be quite "repellent" to this parasite, that is to say, if it be inoculated into their blood it dies out without producing ill effects, just as *T. lewisi* does when injected into an animal other than a rat. Thus it is seen that *T. brucei*, when introduced into the blood of an animal which is specifically or racially distinct from its natural hosts in the region where it is indigenous, is either unable to maintain itself in its new host, or flourishes in it to such an extent as to be the cause of its death.

We may assume, therefore, at least as a working hypothesis, that a lethal parasite is one that is new to its host, and that a harmless parasite is one long established. Since all parasites must have been new to their proper hosts at some period, recent or remote, in the history of the species, it would follow that the first commencement of parasitism would be in almost all cases a life and death struggle, as it were, between the two organisms concerned, and it is quite conceivable that the host might succumb in the struggle and so be exterminated. Ray Lankester has suggested that the extinction of many species of animals in the past may have been due, in some cases, to their having been attacked by a species of parasite to which they did not succeed in becoming adapted, and by which they became, in consequence, exterminated entirely.

Organization of the Protozoa.—The body-form may be constant or inconstant in the Protozoa, according as the body-substance is or is not limited at the surface by a firm envelope or cuticle. When the surface of the protoplasm is naked, as in the common amoeba and allied organisms, the movements of the animal bring about continual changes of form. The protoplasm flows out at any point into processes termed *pseudopodia*, which are being continually retracted and formed anew. Such movements are known as amoeboid, and may be seen in the cells of Metazoa as well as in Protozoa. The pseudopodia serve both for locomotion and for the capture of food. If equally developed on all sides of the body, the animal as a whole remains stationary, but if formed more on one side than the other, the mass of the body shifts its position in that direction, but the movement of translation is generally slow. If the animal remains perfectly quiescent and inactive, the laws of surface-tension acting upon the semi-fluid protoplasmic body cause it to assume a simple spherical

form, which is also the type of body-form generally characteristic of Protozoa of floating habit (*Radiolaria*, *Heliozoa*, &c.).

In the majority of Protozoa, however, the protoplasm is limited at the surface by a firm membrane or cuticle, and in consequence the body has a definite form, which varies greatly in different species, according to the habit of life. As a general rule those forms that are fixed and sedentary in habit tend towards a radially symmetrical structure; those that are free-swimming approach to an ovoid form, with the longest axis of the body placed in the direction of movement; and those that creep upon a firm substratum have the lower side of the body flattened, so that dorsal and ventral surfaces can be distinguished; it is very rare, however, to find a bilaterally symmetrical type of body-structure amongst these organisms. In some cases the cuticle may be too thin to check completely the changes of form due to the movements of the underlying protoplasm; instances of this are seen amongst the so-called "metabolic" Flagellata, in which the body exhibits continually changes of form, termed by Lankester "euglenoid" movements, due to the activity of the superficial contractile layer of the body manifesting itself in ring-like contractions passing down the body in a manner similar to the peristaltic movements of the intestine.

The body-substance of the Protozoa is protoplasm, or, as it was originally termed by Dujardin, sarcode, which is finely alveolar in structure, the diameter of the alveoli varying generally between $\frac{1}{2}$ and 1μ . At the surface of the body the alveoli may take on a definite honeycomb-like arrangement, forming a special "alveolar layer" which in optical section appears radially striated. Besides the minute protoplasmic alveoli, the protoplasm often shows a coarse vacuolation throughout the whole or a part of its substance, giving the body a frothy structure. When such vacuoles are present they must be carefully distinguished from the contractile vacuoles and food-vacuoles described below; from the former they differ by their non-contractile nature, and from the latter by not containing food-substances.

In many Protozoa and especially in those forms in which there is no cuticle, the body may be supported by a skeleton. The material of the skeleton differs greatly in different cases, and may be wholly of an organic nature, or may be impregnated with, or almost entirely composed of, inorganic mineral salts, in which case the skeletal substance is usually either silica or carbonate of lime. From the morphological point of view the skeletons of Protozoa may be divided into two principal classes, according as they are formed internal to, or external to, the body in each case. Instances of internal skeletons are best seen in the spherical floating forms comprised in the orders *Radiolaria* and *Heliozoa*; such skeletons usually take the form of spicules, radiating from the centre to the circumference, and often further strengthened by the formation of tangential bars, producing by their union a lattice-work, which in species of relatively large size may be formed periodically at the surface as the animal grows so that the entire skeleton takes the form of concentric hollow spheres held together by radiating beams. The architectural types of these skeletons show, however, an almost infinite diversity, and cannot be summarized briefly. External skeletons have usually the form of a shell or house, into which the body can be retracted for protection, and from which the protoplasm can issue forth during the animal's phases of activity. Shells of this kind, which must be carefully distinguished from cuticles or other membranes that invest the body closely, are well seen in the order Foraminifera; in the simplest cases they are monaxon in architecture, that is to say, with one principal axis round which the shell is radially symmetrical, and at one pole is a large aperture through which the protoplasm can creep out. In addition to the principal aperture, the shell may or may not be pierced all over by numerous fine pores, through which also the protoplasm can pass out. For further details concerning these shells and their very numerous varieties of structure the reader is referred to the article FORAMINIFERA.

¹The use of the terms "tolerant" and "repellent" is taken from the excellent article on "Sleeping Sickness," by E. Ray Lankester, in the *Quarterly Review* (July 1904), No. 399, pp. 113-138.

The protoplasmic body of the Protozoa is frequently differentiated into two zones or regions: a more external, termed the ectoplasm or ectosarc, and a more internal, termed the endoplasm or endosarc. The ectosarc is distinguished by being more clear and hyaline in appearance, and more tough and viscid in consistence; the endoplasm, on the other hand, is more granular and opaque, and of a more fluid nature. The ectoplasm is the protective layer of the body, and is also the portion most concerned in movement, in excretion, and perhaps also in sensation and in functions similar to those performed by the nervous systems of higher animals. The endoplasm, on the other hand, is the chief seat of digestive and reproductive functions.

As the protective layer of the body, the ectoplasm forms the envelopes or membranes which invest the surface of the body, and which are differentiations of the outermost layer of the ectoplasm. Thus in most Flagellata the ectoplasm is represented only by the more or less firm outer covering or *periplast*. Even when such envelopes are absent, however, the ectoplasm can still be seen to exert a protective function; as, for instance, in those Myxosporidia which are parasitic in the gall-bladders or urinary bladders of their hosts, and which can resist the action of the juices in which they live so long as the ectoplasm is intact, but succumb to the action of the medium if the ectoplasm be injured. In many Infusoria the ectoplasm contains special organs of offence termed trichocysts, each a minute ovoid body from which, on stimulation, a thread is shot out, in a manner similar to the nematocysts of Coelenterata. Similar organs are seen also in the spores of Myxosporidia, as the so-called polar capsules; but in this case the organs are not specially ectoplasmic, and appear to serve for adhesion and attachment, rather than for offence.

The connexion of the ectoplasm with movement is seen in the simplest forms, such as *Amoeba*, by the fact that all pseudopodia arise from it in the first instance. In forms with a definite cuticle, on the other hand, the ectoplasm usually contains contractile fibres or myonemes, forming, as it were, the muscular system of the organism. The dependence of the motility of the animal upon the development of the ectoplasm is well seen in Gregarines, in which other organs of locomotion are absent; in forms endowed with active powers of locomotion a distinct ectoplasmic layer is present below the cuticle; in those Gregarines incapable of active movement, on the other hand, the ectoplasm is absent or scarcely recognizable.

From the ectoplasm arise the special organs of locomotion, which, when present, take the form of pseudopodia, flagella or cilia. Pseudopodia, as already explained, are temporary protoplasmic organs which can be extruded or retracted at any point; they fall naturally into two principal types, between which, however, transitions are to be found: first, slender, filamentous or *filose* pseudopodia, composed of ectoplasm alone, which may remain separate from one another, or may anastomose to form networks, and are then termed *reticulose*; secondly, thick, blunt, so-called *lobose* pseudopodia, which are composed of ectoplasm with a core of endoplasm, and never form networks. In forms showing active locomotor powers the pseudopodia are usually more lobose in type; filose pseudopodia, on the other hand, are more adapted for the function of capturing food.

Flagella are long, slender, vibratile filaments, generally few in number when present, and usually placed at the pole of the body which is anterior in progression. Each flagellum performs peculiar lashing movements which cause the body, if free, to be dragged along after the flagellum in jerks or leaps; if, however, the body be fixed, the action of the flagellum or flagella causes a current towards it, by which means the animal obtains its food-supply. A flagellum which is anterior in movement has been distinguished by Lankester by the convenient term *tractellum*; sometimes, however, the flagellum is posterior in movement and acts as a propeller, like the tail of a fish; for this type Lankester has proposed the term *pulsellum*. The flagellum appears to arise in all cases from a distinct basal granule, and in some cases, as in the genus *Trypanosoma*, there is a portion

of the nuclear apparatus set apart as a distinct kinetic nucleus, with the function, apparently, of governing the activities of the flagellum.

Cilia are minute, hair-like extensions of the ectoplasm, which pierce the cuticle and form typically a furry covering to the body. Though perhaps primitively derived from flagella, cilia, in their usual form, are distinguished from flagella by being of smaller size, by being present, as a rule, in much greater numbers, and above all by the character of their movements. In the place of the complicated lashing movements of the flagella, each cilium performs a simple stroke in one direction, becoming first bowed on one side, by an act of contraction, and then straightened out again when relaxed. The movements of the cilia are co-ordinated and they act in concert, though not absolutely in unison, each one contracting just before or after its neighbour, so that waves of movement pass over a ciliated surface in a given direction, similar to what may be seen in a cornfield when the wind is blowing over it. Primitively coating the whole surface of the body evenly, the cilia may become modified and specialized in various ways, which cannot be described in detail here (see INFUSORIA).

Besides the organs of locomotion already mentioned, there may be present so-called undulating membranes, in the form of thin sheets of ectoplasm which are capable of performing sinuous, undulating movements by their inherent contractility. In some cases distinct contractile threads or myonemes have been described in these membranes. Undulating membranes appear to be formed either by the fusion together of a row of cilia, side by side, or by the attachment of a flagellum to the body by means of an ectoplasmic web, in which case the flagellum forms the free edge of the membrane, as in the genus *Trypanosoma*.

Returning to the ectoplasm, the excretory function exerted by this layer is seen by the formation in it of the peculiar contractile vacuoles found in most free-living Protozoa. A contractile vacuole is a spherical drop of watery fluid which makes its appearance periodically at some particular spot near the surface of the animal's body, or, if more than one such vacuole is present, at several definite and constant places. Each vacuole grows to a certain size, and when it has reached the limit of its growth it discharges its contents to the exterior by a sudden and rapid contraction. There is, apparently, in most if not in all cases, a definite pore through which the contractile vacuole empties itself to the exterior. On account of the relatively large size which the contractile vacuole attains it bulges inwards beyond the limits of the ectoplasm and comes to lie chiefly in the endoplasm, to which it is sometimes, but erroneously, ascribed. In the most highly differentiated Protozoa, for instance, the Ciliata, the ectoplasm contains an apparatus of excretory channels, situated in its deeper layers, and forming as it were a drainage-system, from which the contractile vacuoles are fed. The fluid discharged by the contractile vacuoles appears to be chiefly water which has been absorbed at the surface of the protoplasmic body, and which has filtered through the protoplasm, taking up the soluble waste nitrogenous products of the metabolism and the gaseous products of respiration; hence the contractile vacuoles may be compared in a general way to the urinary and respiratory organs of the Metazoa.

One of the first consequences of the parasitic habit of life is the disappearance of the contractile vacuoles, which are hardly ever found in truly parasitic Protozoa, that is to say, in forms which live in the interior of other animals and nourish themselves at their expense. They are also very frequently absent in marine forms.

Mechanisms of a nervous nature are very seldom found in Protozoa, but in some Ciliata special tactile bristles are found, and it is possible that flagella, and perhaps even pseudopodia, may be sometimes tactile rather than locomotor in function. Pigment-spots, apparently sensitive to light, may also occur in some Flagellata.

The endoplasm, as already stated, is the chief seat of nutritive and reproductive processes. In many Flagellata the ectoplasm

is represented only by the thin envelope or periplast, so that the whole body is practically endoplasm. When the two layers are well differentiated the endoplasm is more fluid and coarsely granular, and contains various organs, chief amongst them in importance being the nucleus, which must be considered specially and may be put aside for the present.

In considering the functions of ingestion and assimilation of food a distinction must be drawn between those Protozoa which absorb solid food-particles, that is to say, which are holozoic in habit, and those which, being holophytic, saprophytic or parasitic in habit, absorb their nourishment in a state of solution. Only in holozoic forms is a special apparatus found for ingestion or digestion of food; in all other forms nutriment is absorbed by osmosis through the body-wall, presumably at any point of the surface. In holozoic forms we must distinguish further those in which the protoplasm is naked at the surface from those in which the body is clothed by a firm cuticle or cell-membrane. In naked forms food-particles are taken in at any point of the body-surface, either by means of the pseudopodia, or by the action of flagella causing them to impinge upon the surface of the body. In either case the food is absorbed by the protoplasm simply flowing round it and engulfing it, and the food passes into the interior of the body in a tiny droplet of water forming what is termed a food-vacuole. Into the food-vacuole the surrounding protoplasm secretes digestive enzymes, so that each such vacuole represents a minute digestive cavity, in which the food is slowly digested, rendered soluble, and absorbed by the surrounding protoplasm. The insoluble residue of the food is finally rejected by expelling the food-vacuole and its contents from the surface of the body at any convenient point.

The simple process of food-absorption described above for the more primitive naked forms is necessarily modified in detail, though not in principle, in corticate Protozoa, that is to say, in forms provided with a cuticle. In the first place, it becomes necessary to have a special aperture for the ingestion of food, a cell-mouth or *cytostome*. Primitively the cytostome is a simple pore or interruption of the cuticle, but in forms more highly evolved the aperture is prolonged inwards in the form of a tube lined by ectosarc and cuticle, forming a gullet or oesophagus which ends in the endoplasm. Food-particles are forced by the action of cilia or flagella down the oesophagus and collect at the bottom of it in a droplet of water which, after reaching a certain size, passes into the endoplasm as a food-vacuole in which the food is digested. For rejection of the insoluble residue of the food-vacuoles, a special pore or cell-anus (*cytopyge*) may be present. In the Ciliata there is often a distinct anal tube visible at all times, but as a rule the anus is only visible at the moment that faecal matter is being ejected from it, though fine sections show that the pore is a constant one. In the higher Flagellata, on the other hand, the oesophageal ingrowth forms commonly a sort of cloacal cavity, into which the contractile vacuole or vacuoles discharge themselves, and into which also the food-vacuoles evacuate their residues.

Besides the food-vacuoles already described, and the nuclear apparatus presently to be dealt with, the endoplasm may contain various metaplastic products, that is to say, bodies to be regarded as stages in the upward or downward metabolism of the protoplasmic substance. Such substances may take the form of coarse granules of various kinds, crystals, vacuoles or droplets of fatty or oily nature, pigment-grains, and other bodies. In the holophytic Flagellata the endoplasm contains also various organs proper to the vegetable cell, such as chlorophyll-bodies (chromatophores), pyrenoids, grains of a starchy nature (paramylum), and so forth, which need not be described here in detail.

The nucleus in Protozoa is usually a compact, fairly conspicuous structure, composed of chromatin combined in various ways with an achromatic substance or substances. Sometimes the chromatin is distributed in smaller masses through the nucleus, producing a granular type of nucleus; more often the chromatin is more or less concentrated in a central mass forming a so-called

karyosome, consisting of an achromatic plastinoid substance impregnated with chromatin. If the karyosome is large and there is very little chromatin between it and the nuclear membrane, the nucleus is of the type termed vesicular. A nuclear membrane is not, however, always present, and true nucleoli, of the type found in the nuclei of metazoan cells, are not found in Protozoa.

A given individual may have more than one nucleus, and the number present may amount to many thousands, as in the plasmodia of Mycetozoa. In such cases the nuclei may be all of one kind, that is to say, not markedly different in size, structure or function, so far as can be seen; or there may be a pronounced morphological differentiation of the nuclei correlated with a difference of function. Thus in the class Infusoria two nuclei are found in each individual; a macronucleus which is somatic in function, that is to say, which regulates the metabolism and vital processes of the body generally, and the micronucleus, which is generative in function, that is to say, which remains in reserve during the ordinary, "vegetative" life of the organism and becomes active during the act of syngamy, after which the effete macronucleus is absorbed or cast out and a new somatic nucleus is formed from portions of the micronuclei which have undergone fusion in the sexual act. Thus the micronucleus of the Infusoria can be compared in a general way with the germ-plasm of the Metazoa, like which it remains inactive until the sexual union. On the other hand, in some Flagellata a differentiation of the nucleus of quite a different type is seen, a smaller, kinetic nucleus being separated off from the larger, trophic or principal nucleus. The kinetic nucleus has the function, apparently, of controlling the locomotor apparatus, so that the specialization of these two nuclei is of a kind quite different from that seen in the Infusoria.

Besides the nuclear substance which is concentrated to form the principal nucleus or nuclei, there may be present also extranuclear granules of chromatin, so-called chromidia, scattered throughout the whole or some part of the protoplasmic body. Chromidia may be normally present in addition to the principal nucleus, or may be formed from the principal nucleus during certain phases of the life-cycle. In some cases the entire nucleus may become resolved temporarily into chromidia, from which a new nucleus may be formed again later by condensation and concentration of the scattered granules. When the chromidia are numerous and closely packed they may form a so-called chromidial network (*Chromidial-Netz*). Recent observations on the reproduction of some Sarcodina have shown that the chromidia may possess great importance in the life-cycle as representing generative chromatin which, like the micronucleus of the Infusoria mentioned above, remains in reserve until, by the process of syngamy, the nuclear apparatus is renewed; while the principal nuclei represent, like the macronuclei, somatic or vegetative chromatin which becomes effete and is cast off or absorbed when syngamy takes place. These questions will be discussed further below.

It was formerly supposed that the lowest Protozoa were entirely without a nucleus, and on this supposition E. Haeckel attempted to establish a class named by him Monera, defined as Protozoa consisting of protoplasm alone, in which a nucleus was not differentiated. To this class were referred various organisms whose alleged archaic nature was expressed by such names as *Protozoen primordialis*, organisms which, like so many other of the primitive forms of animal life described by Haeckel, have been seen by that naturalist alone up to the present. In all Protozoa that have been examined by modern methods a nucleus in some form has been demonstrated to exist, and it must be supposed, until proof to the contrary be forthcoming, that in the case of the so-called Monera either the nucleus was overlooked owing to defective technique, or it had been temporarily resolved into chromidia.

The nuclear apparatus may be supplemented by other bodies of which the nature is not always clear. Such is the so-called "Nebenkern" of *Paramoeba cilhardi*, apparently of the nature of a centrosome. Sometimes the karyosome acts like a

centrosome during the division of the nucleus, and sometimes true centrosomes are present. Flagella also commonly arise from basal granules of a centrosomic nature, blepharoplasts in the correct sense of the term;¹ these blepharoplasts are always in connexion with the nucleus, or with the kinetic nucleus if there is one distinct from the trophic nucleus, as in the genus *Trypanosoma* and allied forms.

Reproduction of the Protozoa.—The mode of reproduction in these organisms is the same as that of the cell generally, and takes always the form of fission of some kind; that is to say, of division of the body into smaller portions, each of which represents a young individual. The division of the body is preceded by that of the nucleus, if single, or of each nucleus in the cases where there are two different nuclei; if, however, more than one nucleus of the same kind be present, the nuclei may be simply shared amongst the daughter-individuals, this mode of division being known as plasmotomy. Other organs of the body may either, like the nucleus, undergo fission, or may be formed afresh in the daughter-individuals.

The division of the nucleus in Protozoa may take place by the direct method or by means of mitosis. Direct division, without mitosis, is of very common occurrence; the division may be simple or multiple, that is to say, into only two parts, or into a number of fragments formed simultaneously. An extreme case of multiple fission is seen in the formation of the microgametes of *Coccidium schubergi*, where the nucleus breaks up into a great number of chromidia, which become concentrated in patches to form the several daughter-nuclei. In some cases, on the other hand, multiple daughter-nuclei are formed by rapidly repeated simple division of the parent nucleus. The mode of division may be different in different nuclei of the same individual; thus in the Infusoria the macronucleus divides by direct division, the micronucleus by mitosis.

The mitosis of the Protozoa is far from being of the uniform stereotyped pattern seen in the Metazoa, but, as might have been expected, often shows a much simpler and more primitive condition. Centrosomes are often absent, and their place may be taken, as stated above, by other bodies. The nuclear membrane may be retained throughout the mitosis. Definite chromosomes can, as a rule, be made out, but the chromosomes are often very numerous and minute, without definite form, and divide irregularly. Much remains to be done in studying the mitosis of the Protozoa, but it is probable that wider knowledge will show many conditions intermediate between direct division and perfect mitosis.

The simplest method of fission in Protozoa is that termed binary, where the body divides into two halves, which may be equal and similar, so that the result is two sister-individuals impossible to distinguish as parent and offspring. In many cases of binary fission, however, the resulting daughter-individuals may be markedly unequal in size, so that one may be distinguished as the parent, the other as the offspring. If the daughter-individual be relatively very small, and formed in a more or less imperfect condition at first, the process is termed gemmation or budding. The buds formed in this way may be either external, formed on the surface of the body, or internal, that is, formed in special internal cavities, from which the offspring are later set free, as in many Acinetaria. Gemmation may be correlated with multiple nuclear fission in such a way that buds are formed over the whole body surface of the organism, which thereby undergoes a process of simultaneous multiple fission into numerous daughter-individuals. Rapid multiple fission of this kind is termed sporulation, and is a form of reproduction which is of common occurrence, especially in parasitic forms. Usually the central portion of the parent body remains over as a residual body (*Restkörper*), but sometimes the parent organism is entirely resolved into the daughter-individuals, which are termed spores

¹ The kinetic nucleus of *Trypanosoma* is sometimes, but in the writer's opinion wrongly, named centrosome or blepharoplast; the bodies to which cytologists give these names are achromatic bodies; the kinetic nucleus is a true chromatic nucleus. The question of the centrosome in Protozoa is discussed by R. Goldschmidt and M. Popoff.

in a general way, but can be given special names in special cases (see GREGARINES, COCCIDIA, &c.).

Life-cycles of the Protozoa.—It is probable that in all Protozoa, as in the Metazoa, the life-history takes its course in a series of recurrent cycles of greater or less extent, a fixed point, as it were, in the cycle being marked by the act of syngamy, or conjugation, which represents, apparently, a process for recuperation of the waning vital powers of the organism. It is true that in many types of Protozoa syngamy is not known as yet to occur, but in all species which have been thoroughly investigated syngamy in some form has been observed, and there is nothing to lead to the belief that the sexual process is not of universal occurrence in the Protozoa.

The life-cycle of a given species may be very simple or it may be extremely complex, the organism occurring under many different forms at different phases or periods of its development. The polymorphism of the Protozoa is best considered under three categories, according to the three main causes to which it is due, namely, first, polymorphism due to adaptation to different conditions of existence; secondly, polymorphism due to differences of size and structure during growth; thirdly, polymorphism due to the differentiation of individuals in connexion with the process of syngamy or sexual conjugation.

1. **Polymorphism in Relation to Life-conditions.**—As a protection against unfavourable conditions, or for other reasons, most Protozoa have the power of passing into a resting condition, during which the vital functions may be wholly or in part suspended. In the resting phase the animal usually becomes enveloped in a resistant membrane or *cyst* secreted by it, and is then said to be encysted. The formation of a cyst may be a response to conditions of various kinds. Very commonly it is formed to protect the organism against a change of medium, as in the case of freshwater forms liable to desiccation, or of parasites about to pass out of the bodies of their hosts. In other cases the organism passes into the resting state in order to absorb ingested nutriment or in order to enter upon reproductive phases.

As a preparation for encystment, organs of locomotion, if present, are retracted or cast off; contractile vacuoles cease to be formed; and the food-vacuoles disappear, usually by digestion of their contents and rejection of the waste residue. The body becomes rounded off and more or less spherical in form, and the protoplasm becomes denser, that is, less fluid and more opaque, but at the same time of diminished specific gravity, by loss of water. The cyst is then secreted at the surface as a layer of varying thickness and toughness. In the encysted condition many Protozoa are capable of being transported by the wind, a fact which explains their appearance in infusions and liquids exposed to the air. In favourable conditions the cysts germinate, that is to say, the envelope is dissolved and the contained organism or organisms are set free to enter upon the strenuous life once more.

In the Mycetozoa, organisms adapted to a semi-terrestrial life in moist surroundings, the protoplasm is capable, when desiccated, of passing into a tough condition resembling sealing-wax, which, when moistened, assumes again its normal appearance and active condition.

Resting phases, analogous to encystment, are seen in the spores of various forms, especially those of parasitic habit, which are commonly enclosed in tough, resistant envelopes or sporocysts, and enveloped as a protection against change of medium or of host. Within the sporocyst multiplication of the sporoplasm may take place to form more or fewer sporozoites. The sporocysts usually show definite symmetry and structure, infinitely variable in different species. In a suitable medium the spores germinate by rupture of the sporocysts and escape of the contents.

2. **Polymorphism in Relation to Growth and Development.**—In many species of Protozoa there is hardly any difference to be observed between different individuals during their active phases except in size. Those individuals about to multiply by fission are slightly above the normal in dimensions; on the

other hand, those resulting from recent fission will be smaller than the average; and such differences are, it need hardly be said, more pronounced when the fission is of the unequal binary type, or in cases of gemmation or multiple fission. In cases also where a given strain of a species is becoming senile, it is sometimes observed that the individuals are markedly undersized on the average.

On the other hand, it is often the case that the young individuals resulting from a recent act of multiplication may differ from adult individuals of the species, not merely in size, but in structural characters, to such an extent that their relationship to the adult forms could not be determined by simple inspection without other evidence. This is especially true of those species in which multiplication by sporulation occurs, giving rise to numerous small spores which may at first be in a resting condition, enveloped in protective sporocysts, but which sooner or later become free, motile individuals known technically as swarm-spores. Thus in many Sarcodina the adult is a large amoeboid organism which produces by sporulation a great number of relatively minute swarm-spores. These may be either, as in the common *Amoeba proteus*, amoeboid organisms, so-called amoebulae or pseudopodiospores, or, as in the Foraminifera and Radiolaria, flagellated organisms, so-called flagellulae or flagellispores. Sometimes, as in many Mycetozoa, amoeboid and flagellated phases may succeed each other rapidly in the development of the swarm-spores. The familiar *Noctiluca miliaris* is another instance of a species which produces by sporulation numerous tiny swarm-spores quite different from the parent form in their characters. Such instances could be multiplied indefinitely amongst the Protozoa.

When the young individuals differ greatly from the adults in structure and appearance they may be regarded as larval forms, and it is interesting to note that such forms appear to be just as much recapitulative, in the phylogenetic sense, as are the larvae of many Metazoa. A striking instance is that of the Acinetaria, in which the swarm-spores produced by gemmation are ciliated, and thus betray affinities with the Ciliata which could hardly be suspected from a study of the adult forms alone. Similarly, in the genus *Trypanosoma*, the young forms often show a *Herpetomonas*-like structure which is probably of phyletic significance. The swarm-spores of Sarcodina and of *Noctiluca* mentioned above can, perhaps, be regarded in the same light. On the other hand, many larval forms cannot be considered as exhibiting recapitulative characters, but merely as adaptations to environment or other special life-conditions. This is especially true, as in Metazoa, of parasitic forms, subject as they are to great vicissitudes, to cope with which the most finely adjusted adaptations are necessary on the part of the organism.

3. *Polymorphism in Relation to Sex.*—In all Protozoa of which the life-cycle has been made known in its entire course, a process of syngamy or sexual union has been found to occur. There are still many forms in which syngamy remains to be discovered: this is true even of some groups of considerable extent. It is quite possible, therefore, that Protozoa exist in which syngamy does not occur. In view, however, of the widespread occurrence of sexual processes amongst unicellular organisms, both of animal and vegetable nature, and the fact that extended observation continually brings to light new instances of this kind, it is safer, in cases amongst the Protozoa in which syngamy is not known to occur, to explain its apparent absence by the imperfections of the present state of our knowledge, than to suppose that in such forms sexual phenomena are entirely lacking in the life-cycle.¹

The process of syngamy, though greatly diversified in different forms, consists essentially of one and the same process in all cases; namely, the fusion of nuclear matter from two distinct individuals. *Plus ça change, plus c'est la même chose!* Hence true syngamy may be distinguished as karyogamy from the process of plastogamy, or fusion of the protoplasmic bodies,

of frequent occurrence in many forms of Protozoa. The individuals whose nuclei undergo fusion are termed *gametes*. They may be in no way different from each other or from ordinary individuals of the species, or, on the other hand, they may be highly differentiated in size, form and structure. The two gametes may undergo complete fusion into one body, thus giving rise to an individual termed generally a zygote or copula, but which may bear special names in special cases (*e.g.* vermicle or oökinete of the malarial parasites, &c.); such a process is termed sometimes copulation. On the other hand, the bodies of the two gametes may remain distinct, and portions of the nucleus of each be exchanged between them; to this condition the term conjugation is sometimes specially applied. The act of syngamy may be performed in the free condition, or in the resting state, within a cyst.

The significance of syngamy has been much discussed, and it is very difficult to make positive statements upon this point. By comparing the life-cycles of different forms it is found that syngamy sometimes precedes, sometimes follows, a period of great reproductive activity on the part of the organism. Thus in such a form as *Noctiluca*, syngamy between two full-grown individuals is followed by rapid sporulation and the production of a swarm of young individuals; on the other hand, in Foraminifera and Radiolaria, rapid sporulation of adult individuals produces a numerous progeny of young forms which may go through the process of syngamy and produce zygotes that simply grow into the adult form. Comparing these two types of development, instances of which might be greatly multiplied, it is seen that in one case syngamy follows a period of growth and precedes a period of proliferation in the life-cycle, and that in the other case exactly the reverse is true. Hence it follows that syngamy must not be regarded as in any way specially connected with reproduction, but must be considered in its relation to the life-cycle as a whole, and in those instances in which syngamy is followed by increased reproductive activity the explanation must be sought in the general physiological effects of the sexual process upon the vital powers of the organism.

In the Metazoa the sexual process is always related to the production of a new individual, that is to say, of a multicellular organism for which there is no analogy amongst the Protozoa, although an approach to the Metazoan condition is seen in colony-forming Flagellata, such as *Volvox* and its allies. The reproduction of Protozoa is analogous to the ordinary process of cell-division and multiplication which is going on at all times in the bodies of the Metazoa, and which can be observed in the production of the gametes; that is to say, in the period of the life-cycle immediately preceding the sexual process in the Metazoa, just as much as in the developmental phases which follow syngamy and result in the building up of a new Metazoan individual. Hence, so far as the Protozoa are concerned, the phrase "sexual reproduction" is an incongruous combination of words; reproduction and sex are two distinct things, not necessarily related or in any direct causal connexion; and in order to arrive at any theory of sex it is necessary first of all to clear away all misconceptions or preconceived notions arising from analogies with the multicellular Metazoan individual.

Many observations indicate that the vital powers of the Protozoa become gradually weakened, and the individual tends to become senile and effete, unless the process of syngamy intervenes. The immediate result of the sexual union is a renewal of the vitality, a rejuvenescence, which manifests itself in enhanced powers of metabolism, growth and reproduction. These facts have been most studied in the Ciliata. It is observed that if these organisms be prevented from conjugating with others of their kind they become senile and finally die off. It has been found by G. N. Calkins, however, that if the senile individuals be given a change of medium and nourishment, their vigour may be renewed and their life prolonged for a time, though not indefinitely; there comes a period when artificial methods fail and only the natural process of syngamy can enable them to prolong their existence. The results obtained by Calkins are of great interest, as indicating that under special conditions

¹ It will be shown below, however, that in some species syngamy may perhaps be *secondarily* in abeyance.

of the environment the necessity for the sexual process may be diminished and the event may be deferred for a long time, if not indefinitely. Hence it is quite possible that in many Protozoa the process of syngamy may be in abeyance, just as there are plants which can be propagated indefinitely by suckers or cuttings without ever setting seed; and it is possible that the inoculative or artificial transmission of parasitic Protozoa from one host to another, as in the case of pathogenic trypanosomes, without any apparent diminution in their vital powers, is an instance of this kind.

As a general rule, in order that syngamy may be attended by beneficial results to the organism, it is necessary that the two conjugating individuals should be from different strains, that is to say, they should not be nearly related by descent and parentage. Thus F. Schaudinn found that in order to observe the sexual union of the gametes of Foraminifera it was necessary to bring together gametes of distinct parentage. On the other hand it has been observed that in many Protozoa, especially in parasitic forms, syngamy takes place between individuals of common parentage. Thus in *Amoeba coli*, according to F. Schaudinn, a single individual becomes encysted and its nucleus divides into two; after each nucleus has undergone certain maturative changes they give rise to pronuclei which conjugate and initiate a new developmental cycle. Syngamy between sister individuals, or autogamy, as it has been termed, is not, however, confined to parasitic Protozoa; it has been observed in *Actinosphaerium* by R. Hertwig. The benefit to the organism, if any, arising from autogamy can only be supposed to result from the rearrangement and reconstitution of the nuclear apparatus. The frequent occurrence of autogamy suggests that in many Protozoa the nature of the environment diminishes the importance of the sexual process, at least so far as the mixture of nuclear material from distinct sources is concerned; and, since autogamy is most common in parasitic forms, this result may, in the light of G. N. Calkins's experiments, be ascribed in great part to the frequent changes of environment and nutrition to which parasitic forms, above all, are subject.

True syngamy consists, as has been said, of nuclear fusion or karyogamy. It rarely, if ever, happens, however, that such fusion takes place without the conjugating nuclei having undergone some process of reduction by elimination of a portion of the nuclear substance, in a manner analogous to the maturation of the germ-cells in the Metazoa. The chromatin thus eliminated may be cast out from the body of the organism as one or more so-called polar bodies; or may be absorbed in the cytoplasm; or may remain in the cytoplasm and be left over in the residual protoplasm in cases where syngamy is followed by a process of rapid multiplication by sporulation; but in all cases the chromatin removed from the nucleus is rejected in some way or other and plays no part in the subsequent development of the organism. The nuclei of the gametes which have completed this process of *épuration nucléaire* are then ripe for syngamic fusion and are termed pronuclei; the union of two pronuclei produces a single nucleus termed a synkaryon.

It is certain that in many, if not in all, cases the nuclear substance that is rejected as a preliminary to syngamy consists of somatic or vegetative chromatin; that is to say, of chromatin that has been functional in regulating the ordinary vital functions, metabolism, growth, reproduction, &c., during previous generations, and has become effete; while on the other hand the chromatin that persists to form the pronuclei is generative chromatin which has remained in reserve for the sexual act and has retained its peculiar powers and properties unimpaired. The truth of this explanation is extremely obvious in such forms as the Infusoria, where somatic and generative chromatin are concentrated into two distinct and entirely separate nuclei. In some Rhizopoda also the body contains one or more principal nuclei and a mass of chromidia, and it has been observed that as a preparation for syngamy the principal nuclei are eliminated and the pronuclei are formed from the chromidia; in such cases, therefore, it is reasonable to regard the principal nuclei as representing somatic chromatin, the chromidia as generative chroma-

tin. In other cases, however, for example *Actinosphaerium*, the chromidia must be interpreted, from their behaviour, as somatic chromatin, and the principal nuclei as generative chromatin; hence R. Goldschmidt has proposed the special term *sporidia* for those chromidia which represent reserve generative chromatin. In the majority of Protozoa, however, the nuclear substance is not differentiated in such a way that it can be distinguished by any visible peculiarities into somatic and generative chromatin.

The process of reduction is not limited, apparently, to the elimination of somatic chromatin, but a portion of the generative chromatin is also cast off. Thus in the Infusoria not only the somatic macronucleus, but also a considerable portion of the generative micronucleus, is absorbed at each act of conjugation. The elimination of generative chromatin is perhaps of importance as a factor in heredity and the production of variations, or possibly for sex determination, as will be discussed below; it is difficult to suggest any other explanations for it, unless it be supposed that during the exercise of ordinary vital functions a portion of the generative chromatin be rendered effete as well as the somatic chromatin.

From the considerations set forth in the foregoing paragraphs it must be supposed that the synkaryon, the fusion-product of the two pronuclei in syngamy, consists at first purely of generative chromatin, which must speedily become differentiated into the regulative somatic chromatin of the ensuing generations and the generative chromatin held in reserve for the next act of syngamy. Such a differentiation can be actually observed in the Infusoria, where immediately after conjugation the synkaryon divides into one or more pairs of nuclei, each pair becoming the two unequally sized nuclei of an ordinary individual, sometimes with, even at this stage, an apparently wanton elimination of nuclear substance. Thus the somatic and generative chromatin of the Protozoa offer a certain analogy with the soma and germ-plasm of Metazoa; but in making such comparisons the distinction between a physiological analogy and a morphological homology should be borne clearly in mind.

It has been stated above that the two gametes of a given species of Protozoa may be perfectly similar and indistinguishable, or may be very different one from the other. The condition with similar gametes is termed isogamy, that with differentiated gametes anisogamy. Every transition can be found from complete isogamy and pronounced anisogamy in the Protozoa; in tracing, however, the evolution of specialized gametes it must be remembered that we are dealing only with visible morphological differences mainly of an adaptive nature, without prejudice to the question of the possible existence of a fundamental sexual antithesis in all gametes, present even when not perceptible. The sex philosopher O. Weininger has urged that sex is a fundamental attribute of living things, and that the living substance, protoplasm, consists of arrhenoplasm and thelyplasm united in varying proportions. Certain observations of F. Schaudinn tend to support this view; in *Trypanosoma noctuae*, for example, Schaudinn found that the process of reduction in one gamete took an opposite course to that which it took in the other gamete. In one gamete certain portions of the nucleus were retained and certain other portions rejected; in the maturation of the other gamete the portions rejected and the portions retained were the reverse. Hence Schaudinn was led to regard the indifferent individuals as essentially hermaphrodite in nature, and therefore capable of giving rise to gametes of either order by elimination of one or the other set of sexual elements; a theory which throws further light on the elimination of generative chromatin mentioned above. It is possible, therefore, that the gametes of Protozoa may possess sexual characters intrinsically different even when perfectly similar so far as can be perceived. It is very probable, for instance, that the isogamy in Gregarines is a state of things derived secondarily from a primitive condition of anisogamy (see GREGARINES).

The simplest possible condition of the gametes is seen in the free-swimming Ciliata, forms which in other respects are the

most highly organized of Protozoa; here the individuals which conjugate are only distinguished from ordinary individuals of the species by the fact that their nuclei have undergone very complicated processes of reduction and nuclear elimination. In these forms there is also no difference between young and adult individuals, beyond scarcely perceptible differences of size between individuals about to divide and those that are the products of recent division, so that these species are practically monomorphic in the active condition. In forms, however, which, like *Vorticella*, are of sessile habit, small free-swimming individuals are liberated which seek out and conjugate with the ordinary sessile individuals. Here we have an instance of a morphological differentiation of the gametes which is clearly adaptive to the life-conditions of the species. In other Protozoa there may be, as already stated, differences, more or less pronounced, between young and adult individuals, and syngamy may take place either between young individuals (microgamy) or between adults (macrogamy); the gametes may be in either case ordinary individuals of the species, not specially differentiated in any way, or on the other hand they may be differentiated from ordinary individuals, while still similar and isogamic amongst themselves; or, finally, they may be anisogamic; that is to say, differentiated into two distinct types. Thus in the Radiolaria, for example, an adult individual breaks up by a process of sporulation into numerous minute flagellated swarm-spores; these may be all of one kind, termed isospores, which develop directly without undergoing syngamy; or they may be of two kinds, termed anisospores, both different in their character from the isospores, and incapable of development without syngamy.

When the gametes are differentiated the divergence between them almost always follows parallel paths. One gamete is distinguished by its smaller size, its greater activity, and its comparative poverty in granules of reserve food-material; hence it is termed the microgamete. The other gamete is distinguished by its greater bulk, its pronounced sluggishness and inertness, and its tendency to form and store up in the cytoplasm reserve nutriment of one kind or another; hence it is termed the macrogamete, or, as some prefer to write it, the megagamete (better megadogamete). When these differences are very pronounced, as, for instance, in the Coccidia and other Sporozoa, a condition is reached which is practically indistinguishable from that seen in the sperm and ova of the Metazoa. Hence the microgamete is generally regarded as male, the macrogamete as female; and these terms may be conveniently used, although they do not in themselves imply more than would the words positive and negative, or any other pair of terms expressive of a fundamental contrast. The microgamete may become reduced to a mere thread of chromatin, which may possess one or two flagella for purposes of locomotion, as in Coccidia, &c., or may move by serpentine movements of the whole body, which resembles in its entirety a flagellum, and is often wrongly so termed. In contrast with the microgamete, its correlative, the macrogamete, tends to become a bulky, inert body, often with great resemblance to an ovum, its cytoplasm dense and granular, packed with reserve food-materials as an egg contains yolk, and without organs of locomotion or capacity for movement of any kind. Hence the macrogamete is the passive element in syngamy, which requires to be sought out and "fertilized" by the active microgamete, a division of labour perfectly analogous to that seen in the male and female gametes of Metazoa. In those cases where syngamy takes place by interchange of nuclear substance between two gametes which remain separate from one another, as in the Infusoria, each gamete forms two pronuclei, which are distinguished by their behaviour as the active and passive pronuclei respectively. The active pronucleus of each gamete passes over into the body of the other and fuses with its passive pronucleus to form a synkaryon. A similar method of procedure occurs also in *Amoeba coli*, according to F. Schaudinn.

When gametes are not very highly specialized they may still retain the power of multiplication by division possessed by

ordinary individuals, so long as they have not undergone the process of nuclear reduction preliminary to syngamy. If, however, the gametes are highly specialized they may forfeit the power of multiplication. In this respect the microgametes are worse off than the other sex; on account of the great reduction of the body-protoplasm, and the entire absence of any reserve materials, they must either fulfil their destiny as gametes or die off. The macrogametes, on the other hand, with their great reserves of cytoplasm and nutriment, are more hardy than any other forms of the species, and are able to maintain their existence in periods of famine and starvation when all other forms are killed off. Moreover they may regain the power of multiplication by a process of parthenogenesis, a term originally applied in the Metazoa to cases where a germ-cell of definitely female character, that is to say an ovum, acquires the power of reproduction without fertilization by syngamy. A macrogamete multiplying by parthenogenesis first goes through certain nuclear changes whereby it is set back, as it were, from the female to the indifferent condition, and it is then able to multiply by fission like any ordinary, non-sexual individual of the species. Parthenogenesis has been described by F. Schaudinn in the malarial parasites and in *Trypanosoma noctuae*. In both cases the female forms are able to persist under adverse conditions after all other forms have perished, and then by parthenogenesis they may multiply when conditions are more favourable, overrun the host again, and cause a relapse of the disease of which they are the cause. S. v. Prowazek has described in *Herpetomonas muscae-domesticae* an analogous process of multiplication on the part of male individuals, and has coined the term thetogenesis for this process, but the statement needs confirmation, and as a general rule the microgamete is quite incapable of independent reproduction under any circumstances.

It is often found that not only are the gametes differentiated, but that their immediate progenitors may also exhibit characters which mark them off from the ordinary or indifferent individuals of the species. In such cases the parent-forms of the gametes are termed gametocytes, and they may differ amongst themselves in characters which render it possible to distinguish those destined to produce microgametes from those which will produce the other sex. The parent-individuals of the microgametes, or microgametocytes, are distinguished as a general rule by clearer protoplasm, free from coarse granulations, and a larger nucleus, more rich in chromatin. The macrogametocytes, on the other hand, usually have coarsely granular cytoplasm, rich in reserve food-stuffs, and a relatively small nucleus. The gametocytes produce the gametes by methods that vary according to the degree of specialization of the gametes. In isogamous forms, of which good examples are furnished by many Gregarines (*q.v.*), the gametes are produced by a process of sporulation on the part of the gametocytes, a certain amount of residual protoplasm being left over. In forms with pronounced anisogamy, for instance, Coccidia or Haemosporidia, the microgametes are produced by sporulation in which almost the whole mass of the body of the gametocyte may be left over as residual protoplasm, together with some portion of the nucleus; in the other sex, however, the process of sporulation may be altogether in abeyance, and the macrogametocyte becomes simply converted into the macrogamete after going through a process of nuclear reduction.

The gametocytes may, however, possess the power of multiplication without change of character for many generations; or, to put the matter in other words, the sexual differentiation may be apparent not merely in the generation immediately preceding the gametes, but in many generations prior to this. Thus a given species may consist of three different types of adult individuals, male, female and indifferent, each multiplying in its own line. Complicated alternations of generations are the result, and if at the same time there is a well-marked difference between young and adult forms of the species the height of polymorphism is reached. Very commonly a double series of generations occurs, the non-sexual or indifferent forms multiplying apart from the sexually differentiated individuals and the generations immediately descended from them; in such cases the

series of non-sexual generations is termed schizogony, the series of sexual generations gametogony or sporogony. Schizogony and sporogony usually occur as adaptations to, or at least in relation with, distinct conditions of life. Thus in parasitic forms, as well illustrated by the Coccidia, the organisms multiply by schizogony when overrunning the host, that is to say, when nutriment is abundant; sporogony begins as a preparation for passing into the outer world, in order to infect new hosts. In the Haemosporidia, in which transmission from one vertebrate host to another is effected by means of blood-sucking ectoparasites (Diptera, ticks, leeches, &c.), the schizogony goes on in the vertebrate host, the sporogony in the invertebrate host. In free-living, non-parasitic forms, schizogony may go on under ordinary conditions, while sporogony supervenes as a preparation for a marked change in the life-conditions; for instance, a change of medium, or at the approach of winter. It is interesting to note that, as a general rule, the differentiation of sexual forms seems to be a preliminary to the production of more resistant forms capable of braving adverse conditions or violent changes in the conditions of life; a phenomenon which is in support of the hypothesis that syngamy has a strengthening effect on the vitality of the species.

Classification of the Protozoa.

Various attempts have been made to separate the Protozoa into two primary subdivisions. E. Ray Lankester divided them into two main groups, the Gymnomyxa, with naked protoplasm and indefinite form, and the Corticata, with the protoplasm limited by a firm membrane, and consequently with a definite body-form. In many of the corticate groups, however, there must be placed amoeboid, non-corticate forms, such as *Mastigamoeba* amongst the Flagellata, or the malarial parasites amongst the Sporozoa. Hence if Lankester's classification be used, it must be without a hard and fast verbal definition. F. Doflein, on the other hand, has divided the Protozoa into Plasmodroma, with organs of locomotion derived from protoplasmic processes, *i.e.* pseudopodia or flagella, and Ciliophora, with locomotion by cilia. It may be doubted, however, if the distinction between flagella and cilia is so fundamental and sharply defined as this mode of classification would imply. W. H. Jackson has proposed to unite the forms bearing flagella and cilia into one section, Plegepoda, and distinguishes two other sections, Rhizopoda (= Sarcodina) and Endoparasita (= Sporozoa).

Four main groups of Protozoa, of the rank of classes, are universally recognized, however they may be combined into larger categories; these are the Sarcodina, Mastigophora, Sporozoa and Infusoria.

The Sarcodina are characterized by the body being composed of naked protoplasm, not covered by any limiting cuticle, although in many cases a house or shell is secreted into which the protoplasm can be partly or entirely withdrawn. No special organs of locomotion, either flagella or cilia, are ever present in the adult, and locomotion and capture of food are effected in the manner named *amoeboid*, by more or less temporary extrusions or outflow of the protoplasm which are termed pseudopodia, as in *Amoeba*.

The Mastigophora are so named because organs of locomotion are always present in the adult in the form of one or more flagella, each flagellum (Gr. *μάστιξ*, whip) a delicate, thread-like extension of the protoplasm, endowed with a special contractility which enables it to perform lashing, whip-like movements. The body protoplasm is sometimes naked, in which case it may be amoeboid, but is more usually limited by a cuticle, varying in thickness in different types.

The Sporozoa, with the exception of a few forms of dubious position, are exclusively internal parasites of Metazoa, absorbing their food from the internal juices and secretions of their hosts, and never exhibiting in their trophic phases any organs of locomotion or for the ingestion and digestion of solid food. The body-protoplasm may be naked and amoeboid or limited by a cuticle. The reproduction is specialized in correlation with the parasitic habit, and results typically in the formation of a

number of minute germs or spores, by which the infection of fresh hosts is effected. It must not be supposed, however, that spore-formation is confined to this class of Protozoa.

The Infusoria, a name originally of much wider application, is now restricted to denote those Protozoa in which locomotion or capture of food is effected by means of special organs termed *cilia*, minute hair-like contractile extensions of the protoplasm differing from flagella not only in their usually smaller size and greater number, but also in the mode of contraction and movement. The cilia may be present throughout life or only in an early stage of the individual. The body is always limited by a cuticle and the nucleus seems to be invariably double, being divided into two parts specialized in function and differing in size, termed respectively macronucleus and micronucleus.

Comparing these four subdivisions with one another, it may be said at once that the Sporozoa and Infusoria are highly specialized classes, each well marked off from the other subdivisions. The Sarcodina and Mastigophora, on the other hand, include the most primitive types of Protozoa and are delimited from one another by a somewhat arbitrary character, the presence or absence of a flagellum in the adult. Thus *Mastigamoeba* is a form which unites the characters of the Sarcodina and Mastigophora, having an amoeboid body which bears a flagellum, and it is classed among the Mastigophora merely because the flagellum is retained throughout life; if the flagellum were absent in the adult condition it would be placed among the Sarcodina, many of which have flagella in their young stages but lack them when adult. Hence Bütschli considered the Rhizomastigina (*i.e.* *Mastigamoeba* and its allies) as the most primitive group of Protozoa, representing the common ancestral form of all the classes; and on this view the flagellated young stages of many Sarcodina would represent recapitulative larval stages.

Bütschli's theory of Protozoan phylogeny implies that a flagellum is an organ of most primitive nature, possessed perhaps by the earliest forms of life; and it must be remembered that flagella are borne by many Bacteria. On the other hand, one would imagine, from general considerations, that living beings possessing a flagellum would have been preceded in evolution by others that did not bear so definite an organ. The flagellum itself is generally regarded as a vibratile process or extension of the protoplasm, comparable in its nature to a slender pseudopodium endowed with peculiar powers of movement. More knowledge with regard to the nature and formation of the flagellum is needed in order to decide this point, and particularly with regard to the question whether the flagella of Bacteria are of the same nature as those of Protozoa.

It has been much debated whether the earliest forms of life were of the nature of plants or animals. Many authors consider the question settled beyond all debate by a process of trenchant deductive reasoning. It is argued that animals require other organisms for their nutriment, and that plants, that is to say green plants, do not; therefore plants must have preceded animals. On the other hand, the morphologist will urge that green plants derive their peculiar powers of metabolism from the possession of very definite cell-organs, namely chromatophores containing chlorophyll; and will argue that living things without such organs must have preceded in evolution those possessing them. The whole dispute is based on the assumption that plant and animal represent the two fundamental modes of metabolism; whereas the study of the Bacteria shows the possibility of many other modes of life. Many Bacteria exhibit processes of metabolism totally different from those generally laid down in textbooks as characteristic of living matter; some are killed by free oxygen; others can absorb free nitrogen, and various other "abnormal" properties are manifested by them. Hence the primitive organisms may have been neither plant nor animal in their nature, but may have possessed, like the Bacteria at present, many different methods of metabolism from which plant and animal are two divergent paths of evolution.

The origin of life is veiled in a mist which biological knowledge

in its present state is unable to dispel; and speculations with regard to the nature of the earliest form of life are as yet premature and futile.

The following references are either general treatises on the Protozoa, or memoirs dealing with special points in a general manner.

BIBLIOGRAPHY.—O. Bütschli, "Protozoa," in *Bronn's Klassen und Ordnungen des Thierreichs*, Bd. 1. (1881-1886); idem., "Investigations on Microscopic Forms and Protoplasm," translated by E. A. Minchin (London, A. & C. Black, 1894); G. N. Calkins, "Studies on the Life History of the Protozoa, IV." (and other memoirs cited therein), *Journ. Exp. Zool.*, i. 423-461, 3 plates, 3 text-figs.; idem., "The Protozoa," *Columbia University Biological Series*, vi. pp. xvi. +347, 153 text-figs.; Y. Delage and E. Hérouard, *Traité de Zoologie Concrète, I. La Cellule et les protozoaires* (Paris, 1896); F. Doflein, *Die Protozoen als parasiten und Krankheitserreger* (Jena, Gustav Fischer, 1901); idem., "Das System der Protozoen," *Arch. f. Protistenkunde*, i. 169-192, 3 text-figs.; R. Goldschmidt, "Die Chromidien der Protozoen," *Arch. f. Protistenkunde*, (1904), v. 126-144, 1 fig.; R. Goldschmidt and M. Popoff, "Die Karyokinen der Protozoen und der Chromidialapparat der Protozoen—und Metazoenzelle," *Arch. f. Protistenkunde* (1907), viii., pp. 321-343, 6 text-figs.; M. Hartog, "Protozoa," *Cambridge Natural History*, vol. i. (London, 1906); R. Hertwig, "Ueber Wesen und Bedeutung der Befruchtung," *SB. Akad. München* (1902), xxxii., pp. 57-73; idem., "Die Protozoen und die Zelltheorie," *Arch. f. Protistenkunde*, (1902), pp. 1-40; W. H. Jackson, "Protozoa" in *Rolliston's Forms of Animal Life*, (rev. ed., pp. 818-922, Oxford, 1888); A. Lang, *Lehrbuch der vergleichenden Anatomie der wirbellosen Tiere*, Bd. I. Abt. II. Lief. 2, "Protozoa" (Jena, 1901); E. R. Lankester, article "Protozoa" in *Ency. Brit.* 9th ed.; idem. (edited by). *A Treatise on Zoology* by various authors: "Protozoa" in part I., fasc. 2 (1903), and fasc. 1 to be published shortly (London, A. and C. Black); E. A. Minchin, "Protozoa" in *Allbutt and Rolliston's A System of Medicine*, rev. ed., vol. ii. pt. 2 (London, 1907); F. Schaudinn, "Neuere Forschungen über die Befruchtung der Protozoen," *Verh. deutsch. zool. Ges.* (1905), xv. 16-35, 1 diagram; H. M. Woodcock, "Protozoa" in *Zool. Record* (1902-1905), vols. xxxix.-xlii. (E. A. M.)

PROUDHON, PIERRE JOSEPH (1809-1865), French socialist and political writer, was born on the 15th of January 1809 at Besançon, France, the native place also of the socialist Fourier. His origin was of the humblest, his father being a brewer's cooper; and the boy herded cows and followed other simple pursuits of a like nature. But he was not entirely self-educated; at sixteen he entered the college of his native place, though his family was so poor that he could not procure the necessary books, and had to borrow them from his mates in order to copy the lessons. At nineteen he became a working compositor; afterwards he rose to be a corrector for the press, reading proofs of ecclesiastical works, and thereby acquiring a very competent knowledge of theology. In this way also he came to learn Hebrew, and to compare it with Greek, Latin and French; and it was the first proof of his intellectual audacity that on the strength of this he wrote an *Essai de grammaire générale*. As Proudhon knew nothing whatever of the true principles of philology, his treatise was of no value. In 1838 he obtained the *pension Suard*, a bursary of 1500 francs a year for three years, for the encouragement of young men of promise, which was in the gift of the academy of Besançon.

In 1839 he wrote a treatise *L'Utilité de la célébration dudimanche* which contained the germs of his revolutionary ideas. About this time he went to Paris, where he lived a poor, ascetic and studious life—making acquaintance, however, with the socialistic ideas which were then fomenting in the capital. In 1840 he published his first work *Qu'est-ce que la propriété?* His famous answer to this question, "La propriété, c'est le vol" (property is theft), naturally did not please the academy of Besançon, and there was some talk of withdrawing his *pension*; but he held it for the regular period. For his third memoir on property, which took the shape of a letter to the Fourierist, M. Considérant, he was tried at Besançon but was acquitted. In 1846 he published his greatest work, the *Système des contradictions économiques ou philosophie de la misère*. For some time Proudhon carried on a small printing establishment at Besançon, but without success; afterwards he became connected as a kind of manager with a commercial firm at Lyons. In 1847 he left this employment, and finally settled in Paris, where he was now

becoming celebrated as a leader of innovation. He regretted the sudden outbreak of the revolution of February (1848), because it found the social reformers unprepared. But he threw himself with ardour into the conflict of opinion, and soon gained a national notoriety. He was the moving spirit of the *Représentant du peuple* and other journals, in which the most advanced theories were advocated in the strongest language; and as member of assembly for the Seine department he brought forward his celebrated proposal of exacting an impost of one-third on interest and rent, which of course was rejected. His attempt to found a bank which should operate by granting gratuitous credit was also a complete failure; of the five million francs which he required only seventeen thousand were offered. The violence of his utterances led to an imprisonment at Paris for three years, during which he married a young working woman. As Proudhon aimed at economic rather than political innovation, he had no special quarrel with the second empire, and he lived in comparative quiet under it till the publication of his work, *De la Justice dans la révolution et dans l'église*, (1858) in which he attacked the Church and other existing institutions with unusual fury. This time he fled to Brussels to escape imprisonment. On his return to France his health broke down, though he continued to write. He died at Passy on the 16th of January 1865.

Personally Proudhon was one of the most remarkable figures of modern France. His life was marked by the severest simplicity and even Puritanism; he was affectionate in his domestic relations, a most loyal friend, and strictly upright in conduct. He was strongly opposed to the prevailing French socialism of his time because of its utopianism and immorality; and, though he uttered all manner of wild paradox and vehement invective against the dominant ideas and institutions, he was remarkably free from feelings of personal hate. In all that he said and did he was the son of the people, who had not been broken to the usual social and academic discipline; hence his roughness, his one-sidedness, and his exaggerations; but he is always vigorous, and often brilliant and original.

It would of course be impossible to reduce the ideas of such an irregular thinker to systematic form. In later years Proudhon himself confessed that "the great part of his publications formed only a work of dissection and ventilation, so to speak, by means of which he slowly makes his way towards a superior conception of political and economic laws." Yet the groundwork of his teaching is clear and firm; no one could insist with greater emphasis on the demonstrative character of economic principles as understood by himself. He strongly believed in the absolute truth of a few moral ideas, with which it was the aim of his teaching to mould and suffuse political economy. Of these fundamental ideas, justice, liberty and equality were the chief. What he desiderated, for instance, in an ideal society was the most perfect equality of remuneration. It was his principle that service pays service, that a day's labour balances a day's labour—in other words, that the duration of labour is the just measure of value. He did not shrink from any of the consequences of this theory, for he would give the same remuneration to the worst mason as to a Phidias; but he looks forward also to a period in human development when the present inequality in the talent and capacity of men would be reduced to an inappreciable minimum. From the great principle of service as the equivalent of service is derived his axiom that property is the right of *aubaine*. The *aubain* was a stranger not naturalized; and the right of *aubaine* was the right in virtue of which the sovereign, from the earliest monarchy, claimed the goods of such a stranger who had died in his territory.¹ Property is a right of the same nature, with a like power of appropriation in the form of rent, interest, &c. It reaps without labour, consumes without producing, and enjoys without exertion. Proudhon's aim, therefore, was to realize a science of society resting on principles of justice, liberty and equality thus understood; "a science absolute, rigorous, based on the nature of man and of his faculties,

¹ The *droit d'aubaine* was abolished in 1790, revived by Napoleon, and ended in 1819.

and on their mutual relations; a science which we have not to invent, but to discover." But he saw clearly that such ideas with their necessary accompaniments could only be realized through a long and laborious process of social transformation. He strongly detested the purient immorality of the schools of Saint-Simon and Fourier. He attacked them not less bitterly for thinking that society could be changed off-hand by a ready-made and complete scheme of reform. It was "the most accursed lie," he said, "that could be offered to mankind." In social change he distinguishes between the transition and the perfection or achievement. With regard to the transition he advocated the progressive abolition of the right of *aubaine*, by reducing interest, rent, &c. For the goal he professed only to give the general principles; he had no ready-made scheme, no utopia. The positive organization of the new society in its details was a labour that would require fifty Montesquieus. The organization he desired was one on collective principles, a free association which would take account of the division of labour, and which would maintain the personality both of the man and the citizen. With his strong and fervid feeling for human dignity and liberty, Proudhon could not have tolerated any theory of social change that did not give full scope for the free development of man. Connected with this was his famous paradox of *anarchy*, as the goal of the free development of society, by which he meant that through the ethical progress of men government should become unnecessary. "Government of man by man in every form," he says, "is oppression. The highest perfection of society is found in the union of order and *anarchy*." Proudhon, indeed, was the first to use the word *anarchy*, not in its revolutionary sense, as we understand it now, but as he himself says, to express the highest perfection of social organization.

Proudhon's theory of property as the right of *aubaine* is substantially the same as the theory of capital held by Marx and most of the later socialists. Marx, however, always greatly detested Proudhon and his doctrines, and attacked him violently in his *Misère de la philosophie*. Property and capital are defined and treated by Proudhon as the power of exploiting the labour of other men, of claiming the results of labour without giving an equivalent. Proudhon's famous paradox, "La propriété, c'est le vol," is merely a trenchant expression of this general principle. As slavery is assassination inasmuch as it destroys all that is valuable and desirable in human personality, so property is theft inasmuch as it appropriates the value produced by the labour of others without rendering an equivalent. For property Proudhon would substitute individual possession, the right of occupation being equal for all men.

A complete edition of Proudhon's works, including his posthumous writings, was published at Paris (1875). See also *P. J. Proudhon, sa vie et sa correspondance*, by Sainte-Beuve (Paris, 1875); Beauchéry, *Économie sociale de P. J. Proudhon* (Lille, 1867); Spoll, *P. J. Proudhon, étude biographique* (Paris, 1867); Marchegay, *Silhouette de Proudhon* (Paris, 1868); Pultitz, *P. J. Proudhon, sein Leben und seine positiven Ideen* (Berlin, 1881); Diehl, *P. J. Proudhon, seine Lehre und sein Leben* (Jena, 1888-1889); Mülberger, *Studien über Proudhon* (Stuttgart, 1891); Desjardins, *P. J. Proudhon, sa vie, ses œuvres et sa doctrine* (Paris, 1896); Mülberger, *P. J. Proudhon* (Stuttgart, 1899).

PROUST, ANTONIN (1832-1905), French journalist and politician, was born at Niort on the 15th of March 1832. He founded in 1864 an anti-imperial journal, *La Semaine hebdomadaire* which appeared at Brussels. He was war correspondent to *Le Temps* in the early days of the Franco-German War, but after Sedan he returned to Paris, where he became secretary to Gambetta and superintended the refugees in Paris. He entered the Chamber as deputy for his native town in 1876, taking his seat on the left. In Gambetta's cabinet (1881-1882) he was minister of the fine arts, and in the Chamber of Deputies he was regularly commissioned to draw up the budget for the fine arts, after the separate department had ceased to exist. Prosecuted in connexion with the Panama scandals, he was acquitted in 1893. From this time he lived in the closest retirement. On the 20th of March 1905 he shot himself in the head, dying of the wound two days later.

PROUST, JOSEPH LOUIS (1754-1826), French chemist, was born on the 26th of September 1754 at Angers, where his father was an apothecary. After beginning the study of chemistry in his father's shop he came to Paris and gained the appointment of apothecary in chief to the Salpêtrière, also lecturing on chemistry at the *musée* of the aeronaut J. F. Pilâtre de Rozier, whom he accompanied in a balloon ascent in 1784. Next, at the instance of Charles IV., he went to Spain, where he taught chemistry first at the artillery school of Segovia, and then at Salamanca, finally becoming in 1789 director of the royal laboratory at Madrid. In 1808 he lost both his position and his money by the fall of his patron, and retired first to Craon in Mayenne and then to Angers, where he died on the 5th of July 1826. His name is best known in connexion with a long controversy with C. L. Berthollet. The latter chemist was led by his doctrine of mass-action to deny that substances always combine in constant and definite proportions. Proust, on the other hand, maintained that compounds always contain definite quantities of their constituent elements, and that in cases where two or more elements unite to form more than one compound, the proportions in which they are present vary *per saltum*, not gradually. In 1799 he proved that carbonate of copper, whether natural or artificial, always has the same composition, and later he showed that the two oxides of tin and the two sulphides of iron always contain the same relative weights of their components and that no intermediate indeterminate compounds exist. His analytical skill enabled him to demonstrate the inaccuracy of the researches by which Berthollet attempted to support the opposite view, and to show among other things that some of the compounds which Berthollet treated as oxides were in reality hydrates containing chemically combined water, and the upshot was that by 1808 he had fully vindicated his position. Proust also investigated the varieties of sugar that occur in sweet vegetable juices, distinguishing three kinds, and he showed that the sugar in grapes, of which he announced the existence to his classes at Madrid in 1799, is identical with that obtained from honey by the Russian chemist J. T. Lowitz (1757-1804).

Besides papers in scientific periodicals he published *Indagaciones sobre el estado de cobre, la vajilla de estaño y el vidriado* (1803); *Mémoire sur le sucre de raisins* (1808); *Recueil des mémoires relatifs à la poudre à canon* (1815); and *Essai sur une des causes qui peuvent amener la formation du calcul* (1824).

PROUSTITE, a mineral consisting of silver sulpharsenite, AgAsS_3 , known also as light red silver ore, and an important source of the metal. It is closely allied to the corresponding sulphantimonite; pyrargyrite, from which it was distinguished by the chemical analyses of J. L. Proust in 1804, after whom the mineral received its name. Many of the characters being so similar to those of pyrargyrite (*q.v.*) they are mentioned under that species. The prismatic crystals are often terminated by the scalenohedron {201} and the obtuse rhombohedron {110}, thus resembling calcite (dog-tooth-spar) in habit. The colour is scarlet-vermilion and the lustre adamantine; crystals are transparent and very brilliant, but on exposure to light they soon become dull black and opaque. The streak is scarlet, the hardness $2\frac{1}{2}$, and the specific gravity 5.57. The mode of occurrence is the same as that of pyrargyrite, and the two minerals are sometimes found together. Magnificent groups of large crystals have been found at Chañarillo in Chile; other localities which have yielded fine specimens are Freiberg and Marienberg in Saxony, Joachimsthal in Bohemia and Markirch in Alsace. (L. J. S.)

PROUT, SAMUEL (1783-1852), English water-colour painter, was born at Plymouth on the 17th of September 1783. He spent whole summer days, in company with the ill-fated Haydon, in drawing the quiet cottages, rustic bridges and romantic water-mills of the beautiful valleys of Devon. He even made a journey through Cornwall to try his hand in furnishing sketches for Britton's *Beauties of England*. On his removal in 1803 to London, which became his headquarters after 1812, a new scene of activity opened up before Prout. He now endeavoured to

correct and improve his style by the study of the works of the rising school of landscape. To gain a living he painted marine pieces for Palser the printseller, received pupils, and published many drawing books for learners. He was likewise one of the first who turned to account in his profession the newly-invented art of lithography. It was not however until about 1818 that Prout discovered his proper sphere. Happening at that time to make his first visit to the Continent, and to study the quaint streets and market-places of continental cities, he suddenly found himself in a new and enchanting province of art. All his faculties, having found their congenial element, sprung into unwonted power and activity. His eye readily caught the picturesque features of the architecture, and his hand recorded them with unsurpassed felicity and fine selection of line. The composition of his drawings was exquisitely natural; their colour exhibited "the truest and happiest association in sun and shade"; the picturesque remnants of ancient architecture were rendered with the happiest breadth and largeness, with the heartiest perception and enjoyment of their time-worn ruggedness; and the solemnity of great cathedrals was brought out with striking effect. At the time of his death, on the 10th of February 1852, there was scarcely a nook in France, Germany, Italy and the Netherlands where his quiet, benevolent, observant face had not been seen searching for antique gables and sculptured pieces of stone. In Venice especially there was hardly a pillar which his eye had not lovingly studied and his pencil had not dexterously copied.

See a memoir of Prout, by John Ruskin, in *Art Journal* for 1849, and the same author's *Notes on the Fine Art Society's Loan Collection of Drawings by Samuel Prout and William Hunt* (1879-1880).

PROUT, WILLIAM (1785-1850), English chemist and physician, was born at Horton, Gloucestershire, on the 15th of January 1785, and died in London on the 9th of April 1850. His life was spent as a practising physician in London, but he also occupied himself with chemical research. He was an active worker in physiological chemistry, and carried out many analyses of the products of living organisms, among them being one of the gastric juice which, at the end of 1823, resulted in the notable discovery that the acid contents of the stomach contain hydrochloric acid which is separable by distillation. In 1815 he published anonymously in the *Annals of Philosophy* a paper "On the relation between the specific gravities of bodies in their gaseous state and the weights of their atoms," in which he calculated that the atomic weights of a number of the elements are multiples of that of hydrogen; and in a second paper published in the same periodical the following year he suggested that the $\pi\acute{o}\tau\eta$ ὕλη of the ancients is realized in hydrogen, from which the other elements are formed by some process of condensation or grouping. This view, generally known as "Prout's hypothesis," at least had the merit of stimulating inquiry, and many of the most careful determinations of atomic weights undertaken since its promulgation have been provoked by the desire to test its validity.

PROVENÇAL LANGUAGE. The name Provençal is used to comprehend all the varieties of Romanic speech formerly spoken and written, and still generally used by country people in the south of France. The geographical limits of this infinitely varied idiom cannot be defined with precision, because it is conterminous on the north, south and east with idioms of the same family, with which almost at every point it blends by insensible gradations. Roughly speaking it may be said to be contained between the Atlantic on the west, the Pyrenees and Mediterranean on the south, and the Alps on the east, and to be bounded on the north by a line proceeding from the Gironde to the Alps, and passing through the departments of Gironde, Dordogne, Haute Vienne, Creuse, Allier, Loire, Rhone, Isère and Savoie. These limits are to some extent conventional. True, they are fixed in accordance with the mean of linguistic characters; but it is self-evident that according to the importance attached to one character or another they may be determined differently.

1. *Different Names.*—Though the name Provençal is generally

adopted to designate the Romanic idiom of this region, it must not be supposed that this name has been imposed by general consensus, or that it rests upon any very firm historical basis. In the southern part of Gaul, Romanic developed itself, so to say, in the natural state of language. Contrary to what took place in other Romanic countries, no local variety here raised itself to the rank of the literary idiom *par excellence*. While in Italy the Florentine, in France the French dialect proper (that is to say, the dialect of the Île de France), succeeded little by little in monopolizing literary use, to the exclusion of the other dialects, we do not find that either the Marseillais or the Toulousain idiom was ever spoken or written outside of Marseilles or Toulouse. In consequence of this circumstance, no name originally designating the language of a town or of a small district came to be employed to designate the language of the whole of southern France; and on the other hand the geographical region described above, having never had any special name, was not able to give one to the idiom.

In the middle ages the idiom was spoken of under various appellations: *Romans* or *lenga romana* was that most generally used. The name was employed by the authors of the *Leys d'amors*, a treatise on grammar, poetry and rhetoric, composed at Toulouse in the 14th century. But while it is capable of being applied and in fact, has been applied, to each of the Romanic languages individually, the term is too general to be retained in a particular case; though it was revived in the beginning of the 19th century by Raynouard, the author of the *Lexique roman*. *Roman* or *langue romane* is no longer in use among scholars to design the Romanic language of the south of France. In the 13th century a poet born in Catalonia, on the southern slope of the Pyrenees, Raimon Vidal of Besalù, introduced the name of *Limousin* language, probably on account of the great reputation of some Limousin troubadours; but he took care to define the expression, which he extended beyond its original meaning, by saying that in speaking of *Limousin* he must be understood to include Saintonge, Quercy, Auvergne, &c. (*Rasos de trobar*, ed. Stengel, p. 70). This expression found favour in Spain, and especially in Catalonia, where the little treatise of Raimon Vidal was extensively read. The most ancient lyric poetry of the Catalans (13th and 14th centuries), composed on the model of the poetry of the troubadours, was often styled in Spain *poesta lemosina*, and in the same country *lengua lemosina*, long designated at once the Provençal and the old literary Catalan.

The name Provençal as applied to language is hardly met with in the middle ages, except in the restricted sense of the language of Provence proper, *i.e.* of the region lying south of Dauphiné on the eastern side of the Rhone. Raimon Ferant, who composed about 1300, a versified life of St Honorat, uses it, but he was himself a native of Provence. We can also cite the title of a grammar, the *Donatz proensals*, by Hugh Faidit (about 1250); but this work was composed in north Italy, and we may conceive that the Italians living next to Provence employed the name Provençal somewhat vaguely without inquiring into the geographical limits of the idiom so called. In fact, the name Provençal became traditional in Italy, and in the beginning of the 16th century Bembo could write, "Era per tutto il Ponente la favella *Provenzale*, ne tempi ne quali ella fiori, in prezzo et in istima molta, et tra tutti gli altri idiomi di quelle parti, di gran lunga primiera. Conciosiacosa che ciascuno, o Francese, o Fiamingo, o Guascone, o Borgognone, o altramente di quelle nationi che egli si fosse, il quale bene scrivere e specialmente verseggiar volesse, quantunque egli Provenzale non fosse, lo faceva Provenzalmente" (*Prose*, ed. 1520, fol. viii.).¹ This passage, in which the primacy of the Provençal tongue is manifestly exaggerated, is interesting as showing the name Provençal employed, though with little precision, in the sense in which we now apply it.

¹ "The Provençal speech in the times in which it flourished was prized and held in great esteem all over the West, and among all the other idioms of that region was by far the foremost; and so that every one, whether Frenchman, Fleming, Gascon, Burgundian, or of what nation soever, who wished to write and versify well, although he was not a Provençal, did it in the Provençal language."

Another designation, which is supported by the great authority of Dante, is that of *lingua d'oco* (*langue d'oc*). In his treatise, *De vulgari eloquio* (bk. i. chs. viii. and ix.), Dante divides the languages of Latin origin into three idioms, which he characterizes by the affirmative particles used in each, *oc. oïl, si*; "nam alii *oc*, alii *oïl*, alii *si*, affirmando loquuntur, ut puta Hispani, Franci, et Latini." As is seen, he attributes the affirmation *oc* to the Spaniards, which is of course erroneous; but there is no doubt that to the Spaniards he joined more correctly the inhabitants of southern France, for in the *Vita nuova*, ch. xxv., and in the *Convivio*, I. x., he speaks of the *lingua d'oco* as having been long celebrated for its poets, which can apply only to the language of the troubadours. The name *langue d'oc* occurs also as early as the end of the 13th century, in public acts, but with a different sense, that of the province of Languedoc, as constituted after the union of the county of Toulouse to the French king's dominion in 1271. In the royal acts of the end of the 13th and of the 14th century *partes lingue occitanæ* or *pays de langue d'oc* designates the union of the five seneschalates of Périgieux, Carcassone, Beaucaire, Toulouse and Rodez; that is to say, the province of Languedoc, such as it existed till 1790. Some scholars, following the example of Dante, still actually use the term *langue d'oc* in opposition to *langue d'oui*; but these names have the inconvenience that they take such a secondary fact as the form of the affirmative particle as an essential character. Moreover, it can hardly help to distinguish the other Romanic languages, as *langue de si* would cause a confusion between Italian and Spanish. Provençal, without being entirely satisfactory, since in principle it applies solely to the language of Provence, is, notwithstanding, the least objectionable name that can be adopted. In addition to its being in some sort consecrated by the use made of it by the Italians, who were the first after the Renaissance to study the works of the troubadours, it must not be forgotten that, just as the Roman *provincia*, in which the name originated, extended across the south of Gaul from the Alps to Toulouse and the Pyrenees, so still in the middle ages *provincia*, *provinciales*, were understood in a very wide sense to designate not only Provence strictly so called, i.e. the present departments of Alpes Maritimes, Basses Alpes, Var, Bouches du Rhône, but also a very considerable part of Languedoc and the adjacent countries. Thus in the 12th century the chronicler Albert of Aix-la-Chapelle (Albertus Aquensis) places the town of Puy (Haute Loire) in *Provincia*.

2. *General Characters of the Language in its Ancient State.*—The Provençal language, within the limits above indicated, cannot be said to have any general characters really peculiar to it. Such of its characters as are found in all the varieties of the language are met with also in neighbouring idioms; such as are not found elsewhere are not general characters, that is to say, are manifested only in certain varieties of Provençal. In reality "Provençal language" does not designate, properly speaking, a linguistic unity; it is merely a geographical expression.

Tonic or Accented Vowels.—Latin *a* is preserved in an open syllable *a m ā r e*, *amar*, *a m ā t u m*, *amat*, as well as in a closed syllable *c a r n e m*, *carn*. This character is common also to the Romanic of Spain and Italy; but it is one of the best distinguishing marks between Provençal and French, for, to the north, this *a*, when in an open syllable, does not pass beyond a line which would run approximately through Blaye, Coutras (Gironde), Ribérac, Nontron (Dordogne), Bellac (Haute Vienne), Boussac (Creuse), Montluçon, Gannat (Allier), Montbrison (Loire). Starting eastward from Lyons or thereabouts, there appears a notable linguistic fact which is observable in varied proportions in the departments of Ain, Isère and Savoie, and in Romanic Switzerland. This is, that accented Latin *a* in an open syllable, when preceded by a *mouillure* or palatalization (whatever the origin of this), becomes *e*; on the contrary, when there is no *mouillure*, it remains *a*. Thus we find in the *Meditations* of Marguerite d'Oingt (Lyons, c. 1300) *enseigneur*, *deleitier*, as against *desirrar*, *recontar*, *regardar*. Of these two endings, the former, *-ier*, is that which is found regularly in French, the second that which is regular in Pr. Pure Pr. would have *-ar* in both cases (*ensenhar*, *deleitar*, *desirrar*, &c.); Fr. would have *-ier* (*enseigner*, *déleitier*) and *-er* (*desirer*). G. I. Ascoli has given the name of *Franco-provençal* (*franco-provenzale*) to the varieties of Romanic in which we find this duality of treatment in Latin *a*, according as it was or was

not preceded by a palatalized sound. Lat. *ē, ĭ* become close *e* (Ital. *e chiuso*; Fr. *ê*): *h a b ē r e*, *aver*, *c r ē d ĩ t*, *cre*, *m ē (n) s e m*, *mes*, *f ĩ d e m*, *fe*, *p ĩ l u m*, *pel*. This character is not only common to Italian and Spanish, but also extends over the French domain on its western side as far as Brittany. Certain exceptions noticed in French do not occur in Pr.: thus *m e r c ĩ d e m*, *c ě r a*, *p r (c) h e (n) s u m*, *v e n ě n u m*, which give in Fr. *merci*, *cire*, *pris*, *venin*, where we should have expected *mercei*, *ceire*, *preis*, *venein*, give regularly in Pr. *merce*, *cera*, *pres*, *vere*. Lat. *ĕ* preserves, as in Italy, the sound of open *e* (Ital. *e aperto*): *p ě d e m*, *pe*, *l ě v a t*, *leva*, *l ě p o r e m*, *lebre*. In certain determinate cases, this *e*, from about the 13th century onwards, may diphthongize to *ie*: *ĕ g o*, *eu*, then *ieu*, *h ě r i*, *er*, *ier*, *f ě r i o*, *fer*, *fier*. Lat. *ī* is preserved, as in all the Romanic languages: *a m ĩ c u m*, *ami*, *r ĩ p a*, *riba*. Lat. *ĩ* is treated like *ĩ* long when it precedes (with hiatus) another vowel: *p ĩ u m*, *p ĩ a*, *p ĩ u*, *p ĩ a*, *v ĩ a*, *v ĩ a*, *l ĩ g a t*, *lia*. Lat. *ō, ū* result in one and the same sound, that of Ital. *u*, Fr. *ou* (Eng. *oo*). The same phenomenon takes place in the north of Italy and in the Romanic of Switzerland. This sound, which is styled by the *Donat Proensal* the *o estreit* (close *o*), is usually symbolized in the early texts by simple *o*, and is thus confounded in spelling, though not in pronunciation, with the open *o* (*o larc* of the *Donat Proensal*), which comes from Lat. *ō*. Lat. *ū* becomes *ü* (i.e. Fr. *u*), as all over France, and also in part of north Italy: *m ū r u m*, *mur* (=mür), *d ū r u m*, *dur* (=dür). Lat. *au* is rigorously preserved over the whole extent of the Pr. domain: *a u r u m*, *aur*, *a l a u d a*, *alauza*, *p a u p e r e m*, *paubre*. At present the preservation of Lat. *au* does not extend much outside the Prov. domain; it is, however, found in certain parts of the Ladina zone in Switzerland (upper Rhine valley), and in Friuli, and it is to be supposed to have been once general over the whole of that zone. It is attested as late as the 16th century in the Vaudois valleys of Piedmont, and there are also examples of it in old Catalan. Elsewhere the diphthong has regularly become open *o* (*a u r u m*, Ital. and Span. *oro*, Fr. *or*, &c.).

Atonic Vowels.—The atonic vowels (i.e. vowels of the unaccented syllables) which precede the accented syllable present no very characteristic phenomenon; but it is otherwise with those that follow the accented syllable, the *post-tonic* vowels. The Pr. is one of the Romanic idioms which, like the French, but unlike the Castilian and many dialects of Italy, admit of only one syllable after the accent. But the rules are not quite the same as in French, and in some exceptional cases real proparoxytones seem to have been preserved by ancient documents. In French the only vowel which can stand after the accented syllable is "e feminine," otherwise called "e mute." In Prov. *a* and *e* are the most frequent vowels in this position, but *i* and *o* also occur. In French the first of the two post-tonic vowels of a Latin proparoxytone always disappears; in Prov. it tends to be preserved, when followed by one of the consonants *n*, *r*, *l*, *d*: *t e r m ĩ n u m*, *te-rmen*, *h o m ĩ n e m*, *omen*, *a n g e l u m*, *angel*, *s e c a l e m*, *se-quel*, *c r e s c e r e*, *crei-sser*, *t e p ĩ d u m*, *te-be*. We have some instances of two syllables being retained after the tonic in the extreme south and south-east: *d ĩ m e n e g u e* (dies dominica), *c a n o n e g u e* (canonicus), *m o n e g u e*, *m o n e g a* (monachus, monaca), *m a n e g a* (manica, a handle), *c a n e b e* (cannabis), later *d ĩ m e r g u e*, *c a n o r g u e*, *m o r g u e*, *m o r g a*, *m a r g a*, *c a r b e*; however, when such apparently proparoxytonic forms appear in poetry, the ending *-egue*, *-ega*, *-ebe* counts only as one syllable, from which it appears that the copyist, not the author, is responsible for them. Again, names of places ending in *-anicus*, *-onicus*, as *Colonicus*, *De-Athanicus*, *Dominitanicus*, &c., now *Colorgues*, *Dassargues*, *Domessargues*, in department Gard, appear in the 12th and 13th centuries as *Colonegues*, *Dazanegues*, *Domensenegues*. Moreover Prov. presents in certain words coming from Latin proparoxytones the trace of forms which (like Italian) admitted two atonic vowels after the accented syllable: thus we have *po-rte-que* and *po-rgue* (porticum), *Fabre-ga*, a place name, and *fa-rga* (fabrica), *perle-ga* and *pe-rga* (pertica), *feme-na* and *fem-na* (femina). We have also *lagre-ma* (lacryma), but a form accented like Fr. *larne* does not exist. There seems to be no doubt that these forms, in which a displacement of the Latin accent is observed, were at an earlier period pronounced as proparoxytones (*po-ri-que*, *fa.brega*, *pe.rte-ga*, *la.grema*).

Consonants.—The boundary usually recognized between Prov. and French is founded upon linguistic characters furnished by the vowels, especially *a*; if it had been determined by characters furnished by the consonants, the line of demarcation would have to be drawn farther south, because the consonantal system which is regarded as proper to French really extends in its main features over the northern zone of the Provençal region as defined above. As with the vowels, only a few of the salient facts can here be indicated. *C* initial, or second consonant of a group, before *a* (*c a b a l l u m*, *m e r c ā t u m*), preserves its Latin sound (=k) in the greater part of the Prov. region. But in the northern zone it takes the sound of *tch* (Eng. *ch* in *chin*) as in Old French, and this sound is still pretty well preserved, although there is here and there a tendency to the present sound of *ch* in Fr. (=sh Eng.). The place names *Castellum*, *Castanētum*, *Casale* give *Chastel*, *Chastanel*, *Chazal*, in Dordogne, Haute Vienne, Corrèze, Puy de Dôme, Cantal, Haute Loire, the north of Lozère, of Ardèche, of

Drome, of Isère, and of Hautes Alpes, and *Castel, Castanet, Cazal*, farther to the south. Analogously, *g* initial, or second consonant of a group, followed by *a*, becomes *j* (i.e. *dzh*=O. Fr. and Eng. *j* in *jam*) in the same zone; *Garrica* is *Jarrija, Jarrja* in Dordogne, Corrèze, Cantal, Haute Loire, Isère, and *Garriga* farther south. Between two vowels *t* becomes *d*; *edat, emperador, nadal, amada aetatem, imperatorem, natale, amata*. This was also the case in O. Fr. until about the 10th or 11th century (*honurede, emperedur, lavadures, &c.*, in the *Life of St Alexis*). But in the northern zone this *d*, representing a Latin *t*, fell away as early as in French. In an 11th-century text from the environs of Valence we read *muraor, coroa* (**muratorem, corogata*), Fr. *corvée* (P. Meyer, *Recueil d'anciens textes*, Provençal section, No. 40). In the south, Latin *d* between two vowels was preserved almost everywhere until about the middle of the 12th century, when it became *s* (as in Fr. and Eng. *zero*): *cruzel, azorar, auzir, vezer* (*crudèle m, a dorare, audire, videre*). In the 14th and 15th centuries *s*, like every *z* or *s* soft of whatever origin, was liable to become *r* (lingual, not uvular): *aurir, veren* (*audire, videre*). In Béarn and Gascony *d* remained; but in the northern zone Latin *d*, instead of changing into *z, r*, disappeared as in French and quite as early. The poem of Boethius, of which the MS. is of the 11th century, shows in this respect great hesitation: e.g. *d* preserved in *chaden, credet, tradar, veder* (*cadentem, *crededit, *tradare, videre*); *d* fallen away in *creessen, feeltat, traazo, veül, fiar* (**credessent, fidelitatem, *tradationem, *vidutum, p. pl. of videre, fidare*). One of the most general facts in Pr. is the habit of rejecting Latin final *t*, of which examples to any number are presented by the verbs. In French this *t* was formerly retained when it followed a vowel which remained, *aimet, entret* (*amat, intrat*), and still remains (in writing at least) when, in Latin, it follows a consonant, *aiment, fait, vit* (*amant, facit, *fact, vivit, *vivit*); but in Pr. the *t* is dropped in all cases, even in the most ancient texts: *aman, fai, viu*. Yet in the northern zone we find the *t* retained in the 3rd per. pl. of verbs, *-ant, -ont* (Lat. *-ant, -unt*). *It* has gone completely (or at least only appears through orthographic tradition, and very intermittently, (*herba, honor, humil, &c.*), not only in words of Latin origin, which is the case in Old French, but even in Teutonic words (*anta, ardit, arenc, ausberg, elm, Fr. honte, hardi, hareng, haubert, heaume, with h aspirated*). By this feature, the northern limits of which are not yet well determined, the Provençal attaches itself to the Romanic of the southern countries. *N* final, or standing in Latin between two vowels of which the second is to be dropped, disappears in the whole central part of the Pr. domain: *gran gra, ben be, en e, ven ve, fin fi, un u* (*granum, bene, in, venit, finem, unum*). The forms with *n* belong to the eastern part (left of the Rhone), the western part (Gascony, but not Béarn), and the region of the Pyrenees. It is possible that this loss of *n* went along with a lengthening of final vowel; at least, in Béarnese when the *n* falls away the vowel is doubled: *caperaa, besii, boo* (*capellānum, vicinū, bonū*), &c.

These are the most important characteristics of the consonants in relation to the extent of space over which they prevail. Others, which appear only within a more limited area, are perhaps more curious on account of their strangeness. It will suffice to mention a few which belong to the district bounded on the west and south by the Atlantic, the Basque provinces and the Pyrenees, and which extends northward and eastward towards the Garonne and its affluents, as far as the Gironde. (This includes Béarn, Bigorre and Gascony.) Here the sound *v* no longer exists, being replaced generally by *b*; between two vowels, in Gascony, by *u* with the sound of English *u*. Initial *r* assumes a prosthetic *a*: *arram, arre, Arrobert* (*rāmum, rem, Robertum*). *Ll* between two vowels becomes *r*: *aperar, caperan*, or (Béarn) *caperaa, bera, era* (*apellare, capellānum, bella, illa*). On the contrary, at the end of words (viz. in Romanic) *ll* becomes *g* or *t, d*; the former change seems to belong rather to Hautes and Basses Pyrénées, Landes, the latter to Gironde, Lot et Garonne, Gers: *eg, ed, et* (*ille, arrasteg, -ed, -el* (*rastellum*), *casteg, -ed, -el* (*castellum*), *capdeg, -ed, -el* (*capitellum*), whence Fr. *cadet* (in 16th century *capdel*, originally a Gascon word). For further details upon the consonants in this region of south-west France see *Romania*, iii, 435-438, v. 368-369.

Flexion.—Old Provençal has, like Old French, a declension consisting of two cases for each number, derived from the Latin nominative and accusative. In certain respects this declension is more in conformity with etymology in Provençal than in Old French, having been less influenced by analogy. The following are the types of this declension, taking them in the order of the Latin declensions. (1) Words in *-a* coming from Latin 1st decl., increased by certain words coming from Latin neuter plurals treated in Prov. as feminine singulars; one form only for each number: sing. *causa*, pl. *causas*. (2) Words of the Latin 2nd decl., with a few from the 4th; two forms for each number: sing. subject *cavals* (*caballus*), object *caval* (*caballum*); pl. subject *caval* (*caballi*), object *cavals* (*caballo*s). (3) Words of Latin 3rd decl. Here there are three Latin types to be considered. The first type presents the same theme and the same accentuation in all the cases, e.g. *cānis*. The second

presents the same accentuation in the nominative singular and in the other cases, but the theme differs: *cōmes, cōmitēm*. In the third type the accentuation changes: *peccator, peccatōrem*. The first type is naturally confounded with nouns of the 2nd decl.: sing. subj. *cans* or *cas*, obj. *can* or *ca*. The second and third types are sometimes followed in their original variety; thus *comis* answers to *cōmes*, and *cōmie* to *cōmitēm*. But it has often happened that already in vulgar Latin the theme of the nominative singular had been refashioned after the theme of the oblique cases. They said in the nom. sing. *heredis, parentis, principis*, for *heres, parens, princeps*. Consequently the difference both of theme and of accentuation which existed in Latin between nominative and accusative has disappeared in Pr. This reconstruction of the nominative singular after the theme of the other cases takes place in all Latin words in *-as* (except *abbas*), in those in *-io*, in the greater part of those in *-or*, at least in all those which have an abstract meaning. Thus we obtain *bontatz* (*bonitatis* for *bonitas*) and *bontat* (*bonitatem*), *ciutatz* (*civitatis* for *civitas*) and *ciutat* (*civitatem*), *amors* (*amoris* for *amor*) and *amor* (*amore*). All present participles in the subject case singular are formed in this way upon refashioned Latin nominatives: *amans* (*amantis* for *amans*), *amant* (*amante* m). It is to be remarked that in regard to feminine nouns Pr. is more etymological than French. In the latter feminine nouns have generally only one form for each number: *bonté* for the subj. as well as for the obj. case, and not *bontés* and *bonté*; in Pr. on the contrary *bontatz* and *bontat*. Still, in a large number of nouns the original difference of accentuation between the nominative singular and the other cases has been maintained, whence there result two very distinct forms for the subjunctive and objective cases. Of these words it is impossible to give a full list here; we confine ourselves to the exhibition of a few types, remarking that these words are above all such as designate persons: *a-bas aba-t, pa-stre pasto-r, sor soro-r, cantai-re cantado-r* (*cantator, -orem*), *emperai-re emperad-or, bar baro-*, *compa-nh companho-, lai-re lairo-* (*latro, -onem*). To this class belong various proper names: *E-ble Eblo-, Gui Guio-, Uc Ugo-*. A few have even come from the 2nd decl., thus *Pei-res Peiro-, Pons Ponso-, Carles, Carlo*, the vulgar Latin types being *Petrus, -onem, Pontius, -onem, Carolus, -onem*. (On this peculiarity of the vulgar Latin declension, see Philippon, in *Romania*, xxxi. 213-228.) We may mention also geographical adjectives, such as *Bret Breto-, Bergo-nhz Bergonho-, Gasc Gasco-, &c.* The plural of the 3rd decl. is like that of the second: subj. *aba-t, soro-r, cantado-r, emperado-r, baro-, companha-, lairo-*; obj. *aba-tz, soro-rs, cantado-rs, emperado-rs, baro-s, companho-s, lairo-s*, as if the Latin nominative pl. had been a *b b ā t i, s o r ō r i, c a n t a t ō r i, &c.* It is barely possible that such forms actually existed in vulgar Latin; no trace of them, however, is found in the texts, save in the glosses of Cassel (8th century), *sapientis* for *sapientes*, and in a great many ancient charters *parentorum*, which implies a nominative *parenti*. The words of the 4th and 5th declensions present no points requiring mention here.

This declension of two cases is a notable character of the whole Romanic of Gaul, north as well as south, i.e. French as well as Provençal. It must be noted, however, that in the south-west it existed only in a very restricted measure. In the old texts of Gascony it is no longer general in the 13th century. In Béarn it appears to have been completely unknown, the nouns and adjectives having only one form, usually that of the objective case. In Catalan poetry its application is often laid down in the 13th century, but as the charters and documents free from literary influence show no trace of it, its introduction into the poetry of this country may be assumed to be an artificial fact. In the region where it is best observed, i.e. in the centre and north of the Provençal territory, it tends to disappear from ordinary use already in the 13th century. The poet-grammarian Raimon Vidal of Besalú, who flourished about the middle of the century, points out in various troubadours transgressions of the rules of declension, and recognizes that in colloquial speech they are no longer observed. The general tendency was to retain only a single form, that of the objective case. For certain words, however, it was the subjunctive form which survived. Thus in modern Pr. the words in the ending *-ai-re* (answering to Lat. *-ator*) are as frequent as those in *-adou-* (repr. *-atorum*). But there is a slight difference of meaning between these two suffixes.

Adjectives, generally speaking, agree in flexion with the nouns. But there is one fact particular to adjectives and past participles which is observed with more or less regularity in certain 12th and 13th-century texts. There is a tendency to mark more clearly than in the substantives the flexion of the subj. pl., chiefly when the adjective or participle is employed predicatively. This is marked by the addition of an *i*, placed, according to the district, either after the final consonant, or else after the last vowel so as to form a diphthong with it. The following are examples from an ancient translation of the New Testament (MS. in library of the Palais Saint-Pierre, Lyons, end of 13th century): "Die a vos que no siatz *consirosi*" (*ne solliciti sitis*, Matt. vi. 25); "que siatz *visiti* d'els" (*ut videamini ab eis*, Matt. vi. 1); "e davant los reis els princeps seretz *menadi*" (*et ad praesides et ad reges ducemini*, Matt. x. 18). In charters of

the 12th and 13th centuries we find in the subj. case pl., and especially in this predicative use, *pagaig, certifiain, acossailhaih*, representing *pagati, certificati, adconsiliati*.

A similar peculiarity is noticeable also in masculine substantives, but appears only in a very limited number of texts; so *auzil, auzellh* [Lat. *aviceilli*] (see A. Thomas, in *Romania*, xxxiv. 353).

It is in the verbs that the individuality of the different Romanic idioms manifests itself most distinctly. At a very early date the etymological data were crossed, in various directions and divers manners according to the country, by analogical tendencies. The local varieties became little by little so numerous in the Romanic conjugation that it is not easy to discover any very characteristic features observed over a territory so vast as that of which the limits have been indicated at the commencement of this article. The following are, however, a few.

The infinitives are in *-ar, -ér, -re, -ir*, corresponding to the Lat. *-āre, -ēre, -ere, -ire*, respectively; as in the whole Romanic domain, the conjugation in *-ar* is the most numerous. The table of verbs, which forms part of the Pr. grammar called the *Donatz Proensals* (13th century), contains 473 verbs in *-ar*, 101 in *-ér* and *-re*, 115 in *-ir*. In the *-ar* conjugation we remark one verb from another conjugation: *far* (cf. Ital. *fare*) from *facere*. The conjugations in *-ér* and *-re* encroach each upon the territory of the other. The three Lat. verbs *cadēre, capēre, sapēre* have become *-ér* verbs (*caze-r, cabe-r, sabe-r*) as in Fr. *cheoir, -cevoir* (*recevoir*), *savoir*; and several other verbs waver between the two: *crede-r, crec-r, and crei-re* (*cre-dēre*), *quere-r and que-rr-e* (*qua-ere*). This fluctuation is most frequent in the case of verbs which belonged originally to the *-ēre* conjugation: *arde-r and a-rdre, plaze-r and plai-re, taze-r and tai-re* (*ardēre, placēre, tacēre*). Next to the *-ar* conjugation, that in *-ir* is the one which has preserved most formative power. As in the other Romanic languages, it has welcomed a large number of German verbs, and has attracted several verbs which etymologically ought to have belonged to the conjugations in *-ér* and *-re*: *emplir* (*im-plēre*), *jauzir* (*gaudēre*), *cosir* (*consuēre*), *erebir* (*cri-pēre*), *fugir* (*fugēre*), *seguir* (**sequēre=sequi*) also *segre*.

Except in the *-ar* conjugation, the ending of the infinitive does not determine in a regular manner the mode of forming the different tenses. The present participles are divided into two series: those in *-an* (obj. sing.) for the first conj., those in *-en* for the others. In this the Pr. distinguishes itself very clearly from the French, in which all present participles have *-ant*. There is also in Pr. a participial form or verbal adjective which is not met with in any other Romanic language, except Rumanian, where, moreover, it is employed in a different sense; this is a form in *-dor, -doi-ra*, which supposes a Latin type *-tōrius, or -tūrius*; the sense is that of a future participle, active for the intransitive verbs, passive for the transitive: *endevenido-r, -doi-ra*, "that is to happen"; *fazedo-r, -doi-ra*, "that is to be done"; *punido-r, -doi-ra*, "to be punished." In conjugation properly so called we may remark the almost complete disappearance of the Lat. preterite in *-āvi*, of which traces are found only in texts written in the neighbourhood of the French-speaking region, and in Béarn. In return, a preterite which seems to have been suggested by the Latin *dēdi, stēti*, has increased and become the type of the tense almost everywhere in the *-ar* conjugation, and in many verbs in *-ér* and *-re*: *amei-, ame-st, ame-t, ame-m, ame-tz, ame-ron*. In French there is a form like this, or at least having the same origin, only in a small number of verbs, none of which belong to the first conjugation, and in these only in the 3rd pers. sing. and pl. (*perdiét, perdierent; entendiét, entendierent, &c.*). It is well known that reduplicated preterites had greatly multiplied in vulgar Latin: there have been recovered such forms as *scēndiderat, ostēndedit, pandiderunt, adtēndedit, indēndiderat, &c.* (see Schuchardt, *Vokalismus des Vulgarlateins*, i. 35, iii. 10; cf. *Romania*, ii. 477). But, in order to explain the Pr. form *-ei, -est, -et* (with open *è*), we must suppose a termination not in *-īdi or -ēdi*, but in *-ēdi*. In the western region the 3rd pers. sing. is generally in *-ec*, probably by analogy with preterites like *bec, dec, sec*, formed after the Latin type in *-u-i*. Another notable peculiarity, of which Old French shows only rare traces, in texts of a very remote period, is the preservation of a preterite in *-ara or -era*, derived from the Latin pluperfect, *ama-ra or ame-ra*, "I loved." The former, which is rare, comes directly from Lat. *amāram*, the latter has been influenced by the ordinary preterite in *-ei*. This preterite is used with the sense of a simple past, not of a pluperfect, and consequently is an exact doublet of the ordinary preterite, which explains how it was at length eliminated almost everywhere by the latter, of which it was a mere synonym. But it remained in general use with the sense of a past conditional: *ama-ra or ame-ra*, "I should have loved," *fora*, "I should have been."

3. *Modern Provençal*.—In consequence of political circumstances the Provençal ceased to be used for administrative as well as literary purposes about the 15th century, in some places a little sooner, in others later (notably in Béarn, where it continued to be written as the language of ordinary use till the 17th, and even in some places till the 18th century). The poems in local

dialect composed and printed in the 16th century, and on to our own day, have no link with the literature of the preceding period. Reduced to the condition of a *patois*, or popular dialect simply, the idiom experienced somewhat rapid modifications. Any one who should compare the poems of Goudelin of Toulouse (1579-1649) with those of a Toulousain troubadour of the 13th century would be astonished at the changes which the language has undergone. Yet this impression would probably be exaggerated. In order to make a rigorously accurate comparison of the language at the two epochs, it would have to be written in the two cases with the same orthographic system, which it is not. The first writers of Provençal, about the 10th and 11th century, applied to the language the Latin orthography, preserving to each letter, as far as possible, the value given to it in the contemporary pronunciation of Latin. To express certain sounds which did not exist in Latin, or which were not there clearly enough noted, there were introduced little by little, and without regular system, various conventional symbolizations such as *lh* and *nh* to symbolize the sound of *l* and *n* mouillées. From this method of proceeding there resulted an orthographic system somewhat wanting in fixity, but which from its very instability lent itself fairly well to the variations which the pronunciation underwent in time and locality. But, the tradition having been interrupted about the 15th century, those who afterwards by way of pastime attempted composition in the *patois* formed, each for himself apart, an orthography of which many elements were borrowed from French usage. It is evident that differences already considerable must be exaggerated by the use of two very distinct orthographical systems. Nevertheless, even if we get quit of the illusion which makes us at first sight suppose differences of sound where there are merely different ways of spelling the same sound, we find that between the 14th and 16th centuries the language underwent everywhere, Béarn excepted, great modifications both in vocabulary and grammar. The Provençal literature having gradually died out during the 14th century, the vocabulary lost rapidly the greater part of the terms expressing general ideas or abstract conceptions. To supply the place of these, the authors who have written in the *patois* of the south during the last few centuries have been obliged to borrow from French, modifying at the same time their form, a multitude of vocables which naturally have remained for the most part unintelligible to people who know only the *patois*. In this case the adoption of foreign words was excusable; but it did not stop here. Little by little, as primary instruction (now compulsory) was diffused, and introduced, first in the towns and afterwards in the villages, certain knowledge of French, words purely French, have been introduced into use in place of the corresponding dialect words. Thus, one hears constantly in Provence *pè-ro, mè-ro, frè-ro*, forms adapted from French, instead of *paire, maire, fraire, cacha* (*calsha*=Fr. *cacher*) instead of *escoundre, &c.*

In the phonology, the modifications are of the natural order, and so have nothing revolutionary. The language has developed locally tendencies which certainly already existed during the flourishing period, although the ancient orthography did not recognize them. Of the vowels, *a* tonic is generally preserved; *an* in an open syllable becomes *ò* (open) in part of the departments of Aveyron, Lot, Dordogne, Corrèze, Cantal and south of Haute Loire: *gro* (*grānum*), *mo* (*mānum*), *po* (*pānem*). This nasalized *a* must have had a particular sound already in O. Pr., for it is qualified in the *Donatz Proensals* (ed. Stengel, p. 49) as *a estreil* (= close or narrow *a*). A feature almost general is the passage of post-tonic *a* into *o*: *terro, amavo, amado* (*terra, mābat, māta*). In many places, particularly in the east, examples of this change occur as early as the end of the 15th century. But even yet there are a few cantons, notably Montpellier and its neighbourhood, and also Nice, where the ancient post-tonic *a* is preserved. It is remarkable that the Latin diphthong *au*, which had become simple *o* in almost all Romanic lands at the date of the most ancient texts, is to this day preserved with a very distinct diphthongal sound everywhere in the south of France.

In the morphology, the leading feature of modern Provençal is the ever greater simplification of grammatical forms. Not only have the two forms (nominative and objective) in each number, in nouns and adjectives, been reduced to one—this reduction manifested itself in ordinary use already in the 14th century—but in many places there no longer remains any distinction between the singular and

the plural. In a great part of the south *ieu* (e g o) does duty as an objective, *me* or *mi* being very restricted in use. In part of Drôme it is the other way, *mi* being substituted in the nominative for *ieu*, which it has completely displaced. It is perhaps in conjugation that the greatest changes from the older form of the language are seen. Analogy, basing itself upon one or another much used form, has acted with immense force, tending to make general in the whole conjugation, without any regard to the original classes to which the various verbs belonged, certain terminations, chiefly those which were accented, and thus appeared to the popular instinct to have more significance. The result, if the tendency were carried the full length, would be the reduction of all the three conjugations to one. Perhaps before this point is reached the *patois* of the south will themselves have disappeared. As the endless modifications which the language undergoes, in vocabulary and grammar alike, develop themselves in different directions, and each over an area differently circumscribed, the general aspect of the language becomes more and more confused, without the possibility of grouping the endless varieties within dialectal divisions, there being hardly any case in which a certain number of phonetic or morphological facts present themselves within the same geographical limits. The custom has been adopted of roughly designating these varieties by the name of the ancient provinces in which they appear. *Limousin* (divided into *High* and *Low Limousin*), *Marchese*, *Auverguese*, *Gascon*, *Béarnese*, *Rouergat*, *Languedocian*, *Provençal*, &c.; but these divisions, though convenient in use, correspond to no actualities. Nîmes and Montpellier are in Languedoc, and Arles and Tarascon are in Provence; nevertheless the dialect of Nîmes resembles that of Arles and Tarascon more than that of Montpellier.

Texts.—For the history of the Provençal in all its varieties there are many more materials than for any other Romanic language, not excepting even Italian or French. The literary texts go back to the 10th or 11th century (see below). For phonetic purposes many of these texts are of secondary value, because the MSS. in which they have reached us, and several of which, especially for the poetry of the troubadours, are of Italian origin, have altered the original forms to an extent which it is not easy to determine; but we possess a countless number of charters, *coutumes*, regulations, accounts, registers of taxation, which are worthy of absolute confidence—first, because these documents are in most cases original, and, secondly, because, none of the dialectal varieties having raised itself to the rank of the literary language, as happened in France with the central (Parisian) variety and in Italy with the Florentine, writers never had the temptation to abandon their own idiom for another. For a selection of that kind of documents see P. Meyer, *Documents linguistiques du midi de la France* (vol. i., 1909, in 8vo, containing the documents of Ain, Basses Alpes, Hautes Alpes, Alpes Maritimes). It is proper to add that Provençal possesses two ancient grammars of the 13th century (the earliest compiled for any Romanic idiom)—the *Donatz proensals* and *Razos de trobar* (see below, PROVENÇAL LITERATURE). Although very short, especially the second, which is a collection of detached observations, they furnish valuable data. The 14th-century *Leys d'amors* presents the language in a somewhat artificial state—the written rather than the spoken language.

BIBLIOGRAPHY: 1. *Ancient Condition*.—There does not exist any comprehensive work upon the Provençal whence to obtain a precise idea of the history of the language at its different epochs. Diez's *Grammatik der romanischen Sprachen* is still the groundwork. It gives, especially in the 3rd ed. (1869–1872), the last revised by the author, the results of extensive researches conveniently arranged. But Diez had only a slender knowledge of the language in its present state, and in his time phonology had made little progress. The French translation of MM. G. Paris, A. Brachet and Morel-Fatio (Paris, 1873–1876) was to be completed by a supplementary volume, but this expedient had to be abandoned, it having been recognized that what was wanted was not a supplement but a general recast. Meyer-Lübke's *Grammatik der romanischen Sprachen* (Leipzig, 1890–1899; Fr. trans., with indexes, 1890–1906), though representing a more advanced state of Romance philology, is marred by an unusual number of inaccuracies, and is of little use for the study of Provençal. The "Recherches philologiques sur la langue romane," and "Résumé de la grammaire romane," published by Raynouard at the beginning of vol. i. of his *Lexique roman* (1838), are entirely out of date. The "Tableau sommaire des flexions provençales," published by K. Bartsch, in the *Chrestomathie provençale*, though much improved in later editions, is incomplete and often erroneous. Better is the *introduzione grammaticale* to V. Crescini's *Manuale provençale* (2nd ed., 1905). Grandgent's *Outline of the Phonology and Morphology of Old Provençal* (Boston, 1905) is also to be recommended. But the actual state of our knowledge of ancient Provençal must be sought in a great number of scattered dissertations or monographs, which will be found especially in the *Romania*, the *Revue de la société pour l'étude des langues romanes*, and other periodicals, to which may be added some academic dissertations published mainly in Germany, and the special studies upon the language of particular texts prefixed to editions of these. As to dictionaries, the *Lexique roman, ou dictionnaire de la langue des troubadours*, by Raynouard (6 vols. 8vo, Paris, 1836–1844), can always be used with advantage. It has been largely supplemented

by Professor E. Levy in his *Provenzalisches Supplement-Wörterbuch* (5 vols., Leipzig, 1892–1910, stops actually at letter P). The numerous special vocabularies appended by editors to texts published by them cannot be neglected. These yield a considerable number of words, either wanting or wrongly explained in the *Lexique roman*.

2. *Modern Form*.—The most useful grammatical works (all done with insufficient knowledge of phonology, and under the preconceived idea that there exist dialects with definite circumscription) are J. B. Andrews, *Essai de grammaire du dialecte mentonais* [Menton] (Nice, 1878), see also his "Phonétique mentonnaise," in *Romania*, xii. 394; Cantagrel, "Notes sur l'orthographe et la prononciation languedocienne," prefixed to *La Canson de la Lauseto*, by A. Mir (Montpellier, 1876); Chabaneau, *Grammaire limousine* (Paris, 1876), referring especially to the variety of Nontron, in the north of Périgord (Dordogne); Constans, *Essai sur l'histoire du sous-dialecte du Rouergue* (Montpellier and Paris, 1880); Lespy, *Grammaire béarnaise* (2nd ed., Paris, 1880); A. Luchaire, *Études sur les idiomes pyrénéens de la région française* (Paris, 1879); Moutier, *Grammaire dauphinoise, dialecte de la vallée de la Drôme* (Montelimar, 1882); Ruben, "Étude sur le patois du Haut Limousin," prefixed to *Poems* by J. Foucaud, in the *Limousin patois* (Limoges, 1866). Far superior in every respect are Alfred Dauzat's essays on the language of North Auvergne: *Phonétique historique du patois de Vinzelles* (Paris, 1897), *Morphologie du patois de Vinzelles* (Paris, 1900), *Géographie phonétique d'une région de la Basse Auvergne* (Paris, 1906). As to dictionaries, we may mention, among others, Andrews, *Vocabulaire français-mentonais* (Nice, 1877); Azais, *Dictionnaire des idiomes romans du midi de la France* (3 vols. 8vo, Montpellier, 1877), taking for its basis the dialect of Béziers; Chabrand and De Rochas d'Aiglun, *Patois des Alpes Cottiennes et en particulier du Queyras* (Grenoble and Paris, 1877); Couzinié, *Dictionnaire de la langue romane-castraise* (Castres, 1850); Garcin, *Nouveau dictionnaire provençal-français* (2 vols., Draguignan, 1841); Honnorat, *Dictionnaire provençal-français* (2 vols. 4to, Digne, 1846–1847), De Sauvages, *Dictionnaire languedocien-français* (new ed., 2 vols., Alais, 1820); Vayssier, *Dictionnaire patois-français du département de l'Aveyron* (Rodez, 1879). F. Mistral's *Tresor dou Felibrige, ou dictionnaire provençal-français* (2 vols. 4to, 1880–1888) is the most complete of all. This dictionary takes as its basis the variety of Maillane (in the north of Bouches-du-Rhône), the author's native district, but gives, as far as possible, all the forms used in the south of France. It is by far the best of all the dictionaries of the southern dialects which have yet been published, and, to a great extent, will enable the student to dispense with all the others. (P. M.)

PROVENÇAL LITERATURE. Provençal literature is much more easily defined than the language in which it is expressed. Starting in the 11th and 12th centuries in several centres it thence gradually spread out, first over the greater portion, though not the whole of southern France, and then into the north of Italy and Spain. It never felt the influence of the neighbouring literatures. At the time of its highest development (12th century) the art of composing in the vulgar tongue did not exist, or was only beginning to exist, to the south of the Alps and the Pyrenees. In the north, in the country of French speech, vernacular poetry was in full bloom; but between the districts in which it had developed—Champagne, Île de France, Picardy and Normandy—and the region in which Provençal literature had sprung up, there seems to have been an intermediate zone formed by Burgundy, Bourbonnais, Berry, Touraine and Anjou which, far on in the middle ages, appears to have remained almost barren of vernacular literature. In its rise Provençal literature stands completely by itself, and in its development it long continued to be absolutely original. It presents at several points genuine analogies with the sister-literature of northern France; but these analogies are due principally to certain primary elements common to both and only in a slight degree to mutual reaction.

It must be inquired, however, what amount of originality could belong to any, even the most original, Romantic literature in the middle ages. In all Romanic countries compositions in the vernacular began to appear while the custom of writing in Latin was still preserved by uninterrupted tradition. Even during the most barbarous periods, when intellectual life was at its lowest, it was in Latin that sermons, lives of saints more or less apocryphal, accounts of miracles designed to attract pilgrims to certain shrines, monastic annals, legal documents, and contracts of all kinds were composed. When learning began to revive, as was the case in northern and central France under the influence of Charlemagne and later in the 11th century, it was Latin literature which naturally received increased attention, and the Latin language was more than ever employed

in writing. Slowly and gradually the Romanic languages, especially those of France, came to occupy part of the ground formerly occupied by Latin, but even after the middle ages had passed away the parent tongue retained no small portions of its original empire. Consequently Romanic literatures in general (and this is especially true of Provençal, as it does not extend beyond the medieval period) afford only an incomplete representation of the intellectual development of each country. Those literatures even which are most truly national, as having been subjected to no external influence, are only to a limited extent capable of teaching us what the nation was. They were, in short, created in the interests of the illiterate part of the people, and to a considerable degree by men themselves almost devoid of literary learning. But that does not make them less interesting.

Origin.—It was in the 11th century, and at several places in the extensive territory whose limits have been described in the foregoing account of the Provençal language, that Provençal literature first made its appearance. It took poetic form; and its oldest monuments show a relative perfection and a variety from which it may be concluded that poetry had already received a considerable development. The oldest poetic text, of which the date and origin are not surely determined, is said to be a Provençal burden (*Fr. refrain*) attached to a Latin poem which has been published (*Zeitschrift für deutsche Philologie*, 1881, p. 335) from a Vatican MS., written, it is asserted, in the 10th century. But it is useless to linger over these few words, the text of which seems corrupt, or at least has not yet been satisfactorily interpreted. The honour of being the oldest literary monument of the Provençal language must be assigned to a fragment of two hundred and fifty-seven decasyllabic verses preserved in an Orleans MS. and frequently edited and annotated since it was first printed by Raynouard in 1817 in his *Choix des poésies originales des troubadours*. The writing of the MS. is of the first half of the 11th century. The peculiarities of the language point to the north of the Provençal region, probably Limousin or Marche. It is the beginning of a poem in which the unknown author, taking Boethius's treatise *De consolatione philosophiae* as the groundwork of his composition, adopts and develops its ideas and gives them a Christian colouring of which there is no trace in the original. Thus from some verses in which Boethius contrasts his happy youth with his afflicted old age he draws a lengthy homily on the necessity of laying up from early years a treasure of good works. The poem is consequently a didactic piece composed by a "clerk" knowing Latin. He doubtless preferred the poetic form to prose because his illiterate contemporaries were accustomed to poetry in the vulgar tongue, and because this form was better adapted to recitation; and thus his work, while a product of erudition in as far as it was an adaptation of a Latin treatise, shows that at the time when it was composed a vernacular poetry was in existence. A little later, at the close of the same century, we have the poems of William IX., count of Poitiers, duke of Guienne. They consist of eleven very diverse strophic pieces, and were consequently meant to be sung. Several are love songs; one relates a *bonne fortune* in very gross terms; and the most important of all—the only one which can be approximately dated, being composed at the time when William was setting out for Spain to fight the Saracens (about 1119)—expresses in touching and often noble words the writer's regret for the frivolity of his past life and the apprehensions which oppressed him as he bade farewell, perhaps for ever, to his country and his young son. We also know from Ordericus Vitalis that William IX. had composed various poems on the incidents of his ill-fated expedition to the Holy Land in 1101. And it must further be mentioned that in one of his pieces (*Ben voil que sapchon li plusor*) he makes a very clear allusion to a kind of poetry which we know only by the specimens of later date, the *partimen*, or, as it is called in France, the *jeu parti*. William IX. was born in 1071 and died in 1127. There is no doubt that the most prolific period of his literary activity was his youth. On the other hand there is no reason to believe that he

created the type of poetry of which he is to us the oldest representative. It is easy to understand how his high social rank saved some of his productions from oblivion whilst the poems of his predecessors and contemporaries disappeared with the generations who heard and sang them; and in the contrast in form and subject between the Boethius poem and the stanzas of William IX. we find evidence that by the 11th century Provençal poetry was being rapidly developed in various directions. Whence came this poetry? How and by whose work was it formed? That it has no connexion whatever with Latin poetry is generally admitted. There is absolutely nothing in common either in form or ideas between the last productions of classical Latinity, as they appear in Sidonius Apollinaris or Fortunatus, and the first poetic compositions in Romanic. The view which seems to meet with general acceptance, though it has not been distinctly formulated by any one, is that Romanic poetry sprang out of a popular poetry quietly holding its place from the Roman times, no specimen of which has survived—just as the Romanic languages are only continuations with local modifications of vulgar Latin. There are both truth and error in this opinion. The question is really a very complex one. First as to the form Romanic versification, as it appears in the Boethius poem and the verses of William IX., and a little farther north in the poem of the *Passion* and the *Life of St Leger* (10th or 11th century), has with all its variety some general and permanent characteristics; it is rhymed, and it is composed of a definite number of syllables certain of which have the syllabic accent. This form has evident affinity with the rhythmic Latin versification, of which specimens exist from the close of the Roman Empire in ecclesiastical poetry. The exact type of Romanic verse is not found, however, in this ecclesiastical Latin poetry; the latter was not popular. However, it may be assumed that there was a popular variety of rhythmic poetry from which Romanic verse is derived.

Again, as regards the substance, the poetic material, we find nothing in the earliest Provençal which is strictly popular. The extremely personal compositions of William IX. have nothing in common with folk-lore. They are subjective poetry addressed to a very limited and probably rather aristocratic audience. The same may be said of the Boethius poem, though it belongs to the quite different species of edifying literature; at any rate it is not popular poetry. Vernacular compositions seem to have been at first produced for the amusement, or in the case of religious poetry, for the edification, of that part of lay society which had leisure and lands, and reckoned intellectual pastime among the good things of life. Gradually this class, intelligent, but with no Latin education, enlarged the circle of its ideas. In the 12th century, and still more in the 13th, historical works and popular treatises on contemporary science were composed for its use in the only language it understood; and vernacular literature continued gradually to develop partly on original lines and partly by borrowing from the literature of the "clerks." But in the 11th century vernacular poetry was still rather limited, and has hardly any higher object than the amusement or the edification of the upper classes. An aristocratic poetry, such as it appears in the oldest Provençal compositions, cannot be the production of shepherds and husbandmen; and there is no probability that it was invented or even very notably improved by William IX.

From what class of persons then did it proceed? Latin chroniclers of the middle ages mention as *joculares*, *joculatores*, men of a class not very highly esteemed whose profession consisted in amusing their audience either by what we still call jugglers' tricks, by exhibiting performing animals, or by recitation and song. They are called *joglars* in Provençal, *jouglers* or *jougleors* in French. A certain Barnaldus, styled *joglaris*, appears as witness in 1058 in a charter of the chartulary of St Victor at Marseilles. In 1106 the act of foundation of a *salva terra* in Rouergue specifies that neither knight nor man-at-arms nor *joculator* is to reside in the village about to be created. These individuals—successors of the *mimi* and the *thymelici* of antiquity, who were professional amusers of the public—were

the first authors of poetry in the vernacular both in the south and in the north of France. To the upper classes who welcomed them to their castles they supplied that sort of entertainment now sought at the theatre or in books of light literature. There were certain of them who, leaving buffoonery to the ruder and less intelligent members of the profession, devoted themselves to the composition of pieces intended for singing, and consequently in verse. In the north, where manners were not so refined and where the taste for warlike adventure prevailed, the jongleurs produced *chansons de geste* full of tales of battle and combat. In the courts of the southern nobles, where wealth was more abundant and a life of ease and pleasure was consequently indulged in, they produced love songs. There is probably a large amount of truth in the remark made by Dante in ch. xxv. of his *Vita nuova*, that the first to compose in the vulgar tongue did so because he wished to be understood by a lady who would have found it difficult to follow Latin verses.¹ And in fact there are love songs among the pieces by William of Poitiers; and the same type preponderates among the compositions of the troubadours who came immediately after him. But it is worthy of note that in all this vast body of love poetry there is no epithalamium nor any address to a marriageable lady. The social conditions of the south of France in the feudal period explain in great measure the powerful development of this kind of poetry, and also its peculiar characteristics—the profound respect, the extreme deference of the poet towards the lady whom he addresses. Rich heiresses were married young, often when hardly out of their girlhood, and most frequently without their fancy being consulted. But they seem after marriage to have enjoyed great liberty. Eager for pleasure and greedy of praise, the fair ladies of the castle became the natural patronesses of the *mesnie* or household of men-at-arms and jongleurs whom their husbands maintained in their castles. Songs of love addressed to them soon became an accepted and almost conventional form of literature; and, as in social position the authors were generally far below those to whom they directed their amorous plaints, this kind of poetry was always distinguished by great reserve and an essentially respectful style. From the beginning the sentiments, real or assumed, of the poets are expressed in such a refined and guarded style that some historians, over-estimating the virtue of the ladies of that time, have been misled to the belief that the love of the troubadour for the mistress of his thoughts was generally platonic and conventional.

The conditions under which Romanic poetry arose in the south of France being thus determined as accurately as the scarcity of documents allows, we now proceed to give a survey of the various forms of Provençal literature, chronological order being followed in each division. By this arrangement the wealth of each form will be better displayed; and, as it is rare in the south of France for the same person to distinguish himself in more than one of them, there will be generally no occasion to introduce the same author in different sections.

Poetry of the Troubadours.—Though he was certainly not the creator of the lyric poetry of southern France, William, count of Poitiers, by personally cultivating it gave it a position of honour, and indirectly contributed in a very powerful degree to ensure its development and preservation. Shortly after him centres of poetic activity make their appearance in various places—first in Limousin and Gascony. In the former province lived a viscount of Ventadour, Eble, who during the second part of William of Poitiers's life seems to have been brought into relation with him, and according to a contemporary historian, Geffrei, prior of Vigeois, *erat valde graciosus in cantilenis*. We possess none of his compositions; but under his influence Bernart of Ventadour was trained to poetry, who, though only the son of one of the serving-men of the castle, managed to gain the love of the lady of Ventadour, and when on the discovery of their amour he had to depart elsewhere, received a gracious

welcome from Eleanor of Guienne, consort (from 1152) of Henry II. of England. Of Bernart's compositions we possess about fifty songs of elegant simplicity, some of which may be taken as the most perfect specimens of love poetry Provençal literature has ever produced. Bernart must therefore have been in repute before the middle of the 12th century; and his poetic career extended well on towards its close. At the same period, or probably a little earlier, flourished Cercamon, a poet certainly inferior to Bernart, to judge by the few pieces he has left us, but nevertheless of genuine importance among the troubadours both because of his early date and because definite information regarding him has been preserved. He was a Gascon, and composed, says his old biographer, "pastorals" according to the ancient custom (*pastorelas a la uzansa antiga*). This is the record of the appearance in the south of France of a poetic form which ultimately acquired large development. The period at which Cercamon lived is determined by a piece where he alludes very clearly to the approaching marriage of the king of France, Louis VII., with Eleanor of Guienne (1137). Among the earliest troubadours may also be reckoned Marcabrun, a pupil of Cercamon's, from whose pen we have about forty pieces, those which can be approximately dated ranging from 1135 to 1148 or thereabout. This poet has great originality of thought and style. His songs, several of which are historical, are free from the commonplaces of their class, and contain curious strictures on the corruptions of the time.

We cannot here do more than enumerate the leading troubadours and briefly indicate in what conditions their poetry was developed and through what circumstances it fell into decay and finally disappeared: Peter of Auvergne (Peire d'Alvernha), who in certain respects must be classed with Marcabrun; Arnaut Daniel, remarkable for his complicated versification, the inventor of the *sestina*, a poetic form for which Dante and Petrarch express an admiration difficult for us to understand; Arnaut of Mareuil, who, while less famous than Arnaut Daniel, certainly surpasses him in elegant simplicity of form and delicacy of sentiment; Bertran de Born, now the most generally known of all the troubadours on account of the part he is said to have played both by his sword and his *sirventes* in the struggle between Henry II. of England and his rebel sons, though the importance of his part in the events of the time seems to have been greatly exaggerated; Peire Vidal of Toulouse, a poet of varied inspiration who grew rich with gifts bestowed on him by the greatest nobles of his time; Guiraut de Bornel, *lo maestre dels trobadors*, and at any rate master in the art of the so-called "close" style (*trobar clus*), though he has also left us some songs of charming simplicity; Gaucelm Faidit, from whom we have a touching lament (*planh*) on the death of Richard Cœur de Lion; Folquet of Marseilles, the most powerful thinker among the poets of the south, who from being a troubadour became first a monk, then an abbot, and finally bishop of Toulouse (d. 1231).

It is not without interest to discover from what class of society the troubadours came. Many of them, there is no doubt, had a very humble origin. Bernart of Ventadour's father was a servant, Peire Vidal's a maker of furred garments, Perdigon's a fisher. Others belonged to the bourgeoisie: Peire d'Alvernha, for example, Peire Raimon of Toulouse, Elias Fonsalada. More rarely we see traders' sons becoming troubadours; this was the case with Folquet of Marseilles and Aimeric de Pegulhan. A great many were clerics, or at least studied for the Church, for instance, Arnaut of Mareuil, Hugh of Saint Circq (Uc de Saint Circ), Aimeric de Belenoi, Hugh Brunet, Peire Cardinal; some had even taken orders: the monk of Montaudon, the monk Gaubert of Puicibot. Ecclesiastical authority did not always tolerate this breach of discipline. Gui d'Ussel, canon and troubadour, was obliged by the injunction of the pontifical legate to give up his song-making. One point is particularly striking, the number of nobles (usually poor knights whose incomes were insufficient to support their rank) who became troubadours, or even, by an inferior descent, jongleurs: Raimon de Miraval, Pons de Capdoill, Guillem Azemar, Cadenet, Peirol, Raimbaut de Vacqueiras, and many more.

¹ "E lo primo che comenciò a dire sicome poeta volgare si mosse però che volle fare intendere le sue parole a donna alla quale era malagevole ad intendere i versi latini."

There is no doubt they betook themselves to poetry not merely for their own pleasure, but for the sake of the gifts to be obtained from the nobles whose courts they frequented. A very different position was occupied by such important persons as William of Poitiers, Raimbaut of Orange, the viscount of Saint Antonin, William of Berga and Blacatz, who made poetry for their own amusement, but contributed not a little, by thus becoming troubadours, to raise the profession.

The profession itself was entirely dependent on the existence and prosperity of the feudal courts. The troubadours could hardly expect to obtain a livelihood from any other quarter than the generosity of the great. It will consequently be well to mention the more important at least of those princes who are known to have been patrons and some of them practisers of the poetic art. They are arranged approximately in geographical order, and after each are inserted the names of those troubadours with whom they were connected.

France.—ELEANOR OF GUIENNE, Bernart de Ventadour (Ventadorn); HENRY CURTMANTLE, son of Henry II. of England, Bertran de Born (?); RICHARD CŒUR DE LION, Arnaut Daniel, Peire Vidal, Folquet of Marseilles, Gaucelm Faidit; ERMENGARDE OF NARBONNE (1143-1192), Bernart de Ventadour, Peire Rogier, Peire d'Alvernia; RAIMON V., count of Toulouse (1143-1194), Bernart de Ventadour, Peire Rogier, Peire Raimon, Hugh Brunet, Peire Vidal, Folquet of Marseilles, Bernart de Durfort; RAIMON VI., count of Toulouse (1194-1222), Raimon de Miraval, Aimeric de Pegulhan, Aimeric de Belenoi, Ademar lo Negre; ALPHONSE II., count of Provence (1185-1209), Elias de Barjols; RAIMON BERENGER IV., count of Provence (1209-1245), Sordel; BARRAL, viscount of Marseilles (d. c. 1192), Peire Vidal, Folquet de Marseilles; WILLIAM VIII., lord of Montpellier (1172-1204), Peire Raimon, Arnaut de Mareuil, Folquet de Marseilles, Guiraut de Calanson, Aimeric de Sarlat; ROBERT, dauphin of Auvergne (1169-1234), Peirol, Perdigon, Pierre de Maensac, Gaucelm Faidit; GUILLAUME DU BAUS, prince of Orange (1182-1218), Raimbaut de Vacqueiras, Perdigon; SAVARIC DE MAULÉON (1200-1230), Gaucelm de Puicibot, Hugh de Saint Cirq; BLACATZ, a Provençal noble (1200?-1236), Cadenet, Joan d'Aubusson, Sordel, Guillem Figueira; HENRY I., count of Rodez (1208-1222?), Hugh de Saint Cirq; perhaps HUGU IV., count of Rodez (1222?-1274) and HENRY II., count of Rodez (1274-1302), Guiraut Riquier, Folquet de Lunel, Serveri de Gironne, Bertran Carbonel; NUNYO SANCHEZ, count of Roussillon (d. 1241), Aimeric de Belenoi; BERNARD IV., count of Astarac (1249-1291), Guiraut Riquier, Amanieu de Sescas.

Spain.—ALPHONSE II., king of Aragon (1162-1196), Peire Rogier, Peire Raimon, Peire Vidal, Cadenet, Guiraut de Cabreira, Elias de Barjols, the monk of Montaudon, Hugh Brunet; PETER II., king of Aragon (1196-1213), Raimon de Miraval, Aimeric de Pegulhan, Perdigon, Ademar lo Negre, Hugh de Saint Cirq; JAMES I., king of Aragon (1213-1276), Peire Cardinal, Bernart Sicart de Maruejols, Guiraut Riquier, At de Mons; PETER III., king of Aragon (1276-1285), Paulet of Marseilles, Guiraut Riquier, Serveri de Gironne; ALPHONSO IX., king of Leon (1138-1214), Peire Rogier, Guiraut de Borneil, Aimeric de Pegulhan, Hugh de Saint Cirq; ALPHONSO X., king of Castile (1252-1284), Bertran de Lamanon, Bonifaci Calvo, Guiraut Riquier, Folquet de Lunel, Arnaut Plages, Bertran Carbonel.

Italy.—BONIFACE II., marquis of Montferrat (1192-1207), Peire Vidal, Raimbaut de Vacqueiras, Elias Cairel, Gaucelm Faidit (?); FREDERICK II., emperor (1215-1250), Jean d'Aubusson, Aimeric de Pegulhan, Guillem Figueira; AZZO VI., marquis of Este (1196-1212), Aimeric de Pegulhan, Rambertin de Buvallesi; AZZO VIII., marquis of Este (1215-1264), Aimeric de Pegulhan.

The first thing that strikes one in this list is that, while the troubadours find protectors in Spain and Italy, they do not seem to have been welcomed in French-speaking countries. This, however, must not be taken too absolutely. Provençal poetry was appreciated in the north of France. There is reason to believe that when Constance, daughter of one of the counts of Arles, was married in 998 to Robert, king of France, she brought along with her Provençal jongleurs. Poems by troubadours are quoted in the French romances of the beginning of the 13th century; some of them are transcribed in the old collections of French songs, and the preacher Robert de Sorbon informs us in a curious passage that one day a jongleur sang a poem by Folquet of Marseilles at the court of the king of France. But in any case it is easy to understand that, the countries of the *langue d'oui* having a full developed literature of their own suited to the taste of the people, the troubadours generally

preferred to go to regions where they had less to fear in the way of competition.

The decline and fall of troubadour poetry was mainly due to political causes. When about the beginning of the 13th century the Albigensian War had ruined a large number of the nobles and reduced to lasting poverty a part of the south of France, the profession of troubadour ceased to be lucrative. It was then that many of those poets went to spend their last days in the north of Spain and Italy, where Provençal poetry had for more than one generation been highly esteemed. Following their example, other poets who were not natives of the south of France began to compose in Provençal, and this fashion continued till, about the middle of the 13th century, they gradually abandoned the foreign tongue in northern Italy, and somewhat later in Catalonia, and took to singing the same airs in the local dialects. About the same time in the Provençal region the flame of poetry had died out save in a few places—Narbonne, Rodez, Foix and Astarac—where it kept burning feebly for a little longer. In the 14th century composition in the language of the country was still practised; but the productions of this period are mainly works for instruction and edification, translations from Latin or sometimes even from French, with an occasional romance. As for the poetry of the troubadours, it was dead for ever.

Form.—Originally the poems of the troubadours were intended to be sung. The poet usually composed the music as well as the words; and in several cases he owed his fame more to his musical than to his literary ability. Two manuscripts preserve specimens of the music of the troubadours, but, though the subject has been recently investigated, we are hardly able to form a clear opinion of the originality and of the merits of these musical compositions. The following are the principal poetic forms which the troubadours employed. The oldest and most usual generic term is *vers*, by which is understood any composition intended to be sung, no matter what the subject. At the close of the 12th century it became customary to call all verse treating of love *canso*—the name *vers* being then more generally reserved for poems on other themes. The *sirventesc* differs from the *vers* and the *canso* only by its subject, being for the most part devoted to moral and political topics. Peire Cardinal is celebrated for the *sirventescs* he composed against the clergy of his time. The political poems of Bertran de Born are *sirventescs*. There is reason to believe that originally this word meant simply a poem composed by a *servent* (Lat. *serviens*) or man-at-arms. The *sirventesc* is very frequently composed in the form, sometimes even with rhymes, of a love song having acquired some popularity, so that it might be sung to the same air. The *tenson* is a debate between two interlocutors, each of whom has a stanza in turn. The *partimen* (Fr. *jeu parti*) is also a poetic debate, but it differs from the *tenson* in so far that the range of debate is limited. In the first stanza one of the partners proposes two alternatives; the other partner chooses one of them and defends it, the opposite side remaining to be defended by the original propounder. Often in a final couplet a judge or arbiter is appointed to decide between the parties. This poetic game is mentioned by William, count of Poitiers, at the end of the 11th century. The *pastorela*, afterwards *pastorela*, is in general an account of the love adventures of a knight with a shepherdess. All these classes have one form capable of endless variations: five or more stanzas and one or two envois. The *dansa* and *balada*, intended to mark the time in dancing, are pieces with a refrain. The *alba*, which has also a refrain, is, as the name indicates, a waking or morning song at the dawning of the day. All these classes are in stanzas. The *descort* is not thus divided, and consequently it must be set to music right through. Its name is derived from the fact that, its component parts not being equal, there is a kind of "discord" between them. It is generally reserved for themes of love. Other kinds of lyric poems, sometimes with nothing new about them except the name, were developed in the south of France; but those here mentioned are the more important.

Narrative Poetry.—Although the strictly lyric poetry of the troubadours forms the most original part of Provençal literature, it must not be supposed that the remainder is of trifling importance. Narrative poetry, especially, received in the south of France a great development, and, thanks to recent discoveries, a considerable body of it has already become known. Several classes must be distinguished: the *chanson de geste*, legendary or apparently historical, the romance of adventure and the novel. Northern France remains emphatically the native country of the *chanson de geste*; but, although in the south different social conditions, a more delicate taste, and a higher state of civilization prevented a similar profusion of tales of war and heroic deeds, Provençal literature has some highly important specimens of this class. The first place belongs to *Girart de Roussillon*, a poem of ten thousand verses, which relates the struggles of Charles Martel with his powerful

vassal the Burgundian Gerard of Roussillon. It is a literary production of rare excellence and of exceptional interest for the history of civilization in the 11th and 12th centuries. *Girart de Roussillon* belongs only within certain limits to the literature of southern France. The recension which we possess appears to have been made on the borders of Limousin and Poitou; but it is clearly no more than a recast of an older poem no longer extant, probably either of French or at least Burgundian origin. To Limousin also seems to belong the poem of *Aigar and Maurin* (end of the 12th century), of which we have unfortunately only a fragment so short that the subject cannot be clearly made out. Of less heroic character is the poem of *Daurel and Beton* (first half of the 13th century), connected with the cycle of Charlemagne, but by the romantic character of the events more like a regular romance of adventure. We cannot, however, form a complete judgment in regard to it, as the only MS. in which it has been preserved is defective at the close, and that to an amount there is no means of ascertaining. Midway between legend and history may be classified the Provençal *Chanson of Antioch*, a mere fragment of which, 700 verses in extent, has been recovered in Madrid and published in *Archives de l'Orient latin*, vol. ii. This poem, which seems to have been composed by a certain Gregoire Bechada, mentioned in a 12th-century chronicle and written in Limousin (see G. Paris, in *Romania*, xxii. 358), is one of the sources of the Spanish compilation *La gran conquista de Ultramar*. To history proper belongs the *Chanson of the crusade against the Albigensians*, which, in its present state, is composed of two poems one tacked to the other; the first, containing the events from the beginning of the crusade till 1213, is the work of a cleric named William of Tudela, a moderate supporter of the crusaders; the second, from 1213 to 1218, is by a vehement opponent of the enterprise. The language and style of the two parts are no less different than the opinions. Finally, about 1280, Guillaume Anelier, a native of Toulouse, composed, in the *chanson de geste* form, a poem on the war carried on in Navarre by the French in 1276 and 1277. It is an historical work of little literary merit. All these poems are in the form of *chansons de geste*, viz. in stanzas of indefinite length, with a single rhyme. *Gerard of Roussillon*, *Aigar and Maurin* and *Daurel and Beton* are in verses of ten, the others in verses of twelve syllables. The peculiarity of the versification in *Gerard* is that the pause in the line occurs after the sixth syllable, and not, as is usual, after the fourth.

Like the *chanson de geste*, the romance of adventure is but slightly represented in the south; but it is to be borne in mind that many works of this class must have perished, as is rendered evident by the mere fact that, with few exceptions, the narrative poems which have come down to us are each known by a single manuscript only. We possess but three Provençal romances of adventure: *Jaufré* (composed in the middle of the 13th century and dedicated to a king of Aragon, possibly James I.), *Blandin of Cornwall* and *Guillem de la Barra*. The first two are connected with the Arthurian cycle: *Jaufré* is an elegant and ingenious work; *Blandin of Cornwall* the dullest and most insipid one can well imagine. The romance of *Guillem de la Barra* tells a strange story also found in Boccaccio's *Decameron* (2nd Day, viii.). It is rather a poor poem; but as a contribution to literary history it has the advantage of being dated. It was finished in 1318, and is dedicated to a noble of Languedoc called Sicart de Montaut. Connected with the romance of adventure is the novel (in Provençal *novas*, always in the plural), which is originally an account of an event "newly" happened. The novel must have been at first in the south what, as we see by the *Decameron*, it was in Italy, a society pastime—the wits in turn relating anecdotes, true or imaginary, which they think likely to amuse their auditors. But before long this kind of production was treated in verse, the form adopted being that of the romances of adventure—octosyllabic verses rhyming in pairs. Some of those novels which have come down to us may be ranked with the most graceful works in Provençal literature; two are from the pen of the Catalan author Raimon Vidal de Besalú. One, the *Castia-gilos* (the Chastisement of the Jealous Man), is a treatment, not easily matched for elegance, of a frequently-handled theme—the story of the husband who, in order to entrap his wife, takes the disguise of the lover whom she is expecting and receives with satisfaction blows intended, as he thinks, for him whose part he is playing; the other, *The Judgment of Love*, is the recital of a question of the law of love, departing considerably from the subjects usually treated in the novels. Mention may also be made of the novel of *The Parrot* by Arnaut de Carcassonne, in which the principal character is a parrot of great eloquence and ability, who succeeds marvelously in securing the success of the amorous enterprises of his master. Novels came to be extended to the proportions of a long romance. *Flamenca*, which belongs to the novel type, has still over eight thousand verses, though the only MS. of it has lost some leaves both at the beginning and at the end. This poem, composed in all probability in 1234, is the story of a lady who by very ingenious devices, not unlike those employed in the *Miles gloriosus* of Plautus, succeeds in eluding the vigilance of her jealous husband. No analysis can be given here of a work the action of which is highly complicated; suffice it to remark that there is no book in medieval literature which betokens so much quickness of intellect and is so instructive in regard to the manners and usages of polite

society in the 13th century. We know that novels were in great favour in the south of France, although the specimens preserved are not very numerous. Statements made by Francesco da Barberino (early part of 14th century), and recently brought to light, give us a glimpse of several works of this class which have been lost. From the south of France the novel spread into Catalonia, where we find in the 14th century a number of novels in verse very similar to the Provençal ones, and into Italy, where in general the prose form has been adopted.

Didactic and Religious Poetry.—Compositions intended for instruction, correction and edification were very numerous in the south of France as well as elsewhere, and, in spite of the enormous losses sustained by Provençal literature, much of this kind still remains. But it is seldom that such works have much originality or literary value. Originality was naturally absent, as the aim of the writers was mainly to bring the teachings contained in Latin works within the reach of lay hearers or readers. Literary value was not of course excluded by the lack of originality, but by an unfortunate chance the greater part of those who sought to instruct or edify, and attempted to substitute moral works for secular productions in favour with the people, were, with a few exceptions, persons of limited ability. It would be out of question to enumerate here all the didactic treatises, all the lives of saints, all the treatises of popular theology and morals, all the books of devotion, all the pious canticles, composed in Provençal verse during the middle ages; still some of these poems may be singled out. Daude de Prades (early 13th century), a canon of Maguelone, and at the same time a troubadour, has left a poem, the *Auzels cassadors*, which is one of the best sources for the study of falconry. Raimon d'Avignon, otherwise unknown, translated in verses, about the year 1200, Rogier of Parme's "Surgery" (*Romania*, x. 63 and 496). We may mention also a poem on astrology by a certain G. (Guilhem?), and another, anonymous, on geomancy, both written about the end of the 13th century (*Romania*, xxvi. 825). As to moral compositions, we have to recall the Boethius poem (unfortunately a mere fragment) already mentioned as one of the oldest documents of the language, and really a remarkable work; and to notice an early (12th century?) metrical translation of the famous *Disticha de moribus* of Dionysius Cato (*Romania*, xxv. 98, and xxix. 445). More original are some compositions of an educational character known under the name of *ensenhamenz*, and, in some respects, comparable to the English nurture-books. The most interesting are those of Garin le Brun (12th century), Arnaut de Mareuil, Arnaut Guilhem de Marsan, Amanieu de Sescas. Their general object is the education of ladies of rank. Of metrical lives of saints we possess about a dozen (see *Histoire littéraire de la France*, vol. xxxii.), among which two or three deserve a particular attention: the Life of Sancta Fides, recently discovered and printed *Romania*, xxxi.), written early in the 12th century; the Life of St Enimia (13th century), by Bertran of Marseilles, and that of St Honorat of Lerins by Raimon Feraud (about 1300), which is distinguished by variety and elegance of versification, but it is almost entirely a translation from Latin. Lives of saints (St Andrew, St Thomas the Apostle, St John the Evangelist) form a part of a poem, strictly didactic, which stands out by reason of its great extent (nearly thirty-five thousand verses) and the somewhat original conception of its scheme—the *Breviari d'amor*, a vast encyclopaedia, on a theological basis, composed by the Minorite friar Matfre Ermengaut of Béziers between 1288 and 1300 or thereabout.

Drama.—The dramatic literature of southern France belongs entirely to the religious class, and shows little originality. It consists of mysteries and miracle plays seldom exceeding two or three thousand lines, which never developed into the enormous dramas of northern France, whose acting required several consecutive days. Comic plays, so plentiful in medieval French literature (*farces, sotties*), do not seem to have found favour in the south. Specimens which we possess of Provençal drama are comparatively few; but researches in local archives, especially in old account books, have brought to light a considerable number of entries concerning the acting, at public expense, of religious plays, called, in Latin documents, *ludus, historia, moralitas*, most of which seem to be irretrievably lost. As all the Provençal plays, sometimes mere fragments, which have escaped destruction, are preserved in about a dozen manuscripts, unearthed within the last forty or fifty years, there is hope that new texts of that sort may some day be published. Generally those plays belong to the 15th century or to the 16th. Still, a few are more ancient and may be ascribed to the 14th century or even to the end of the 13th. The oldest appears to be the *Mystery of St Agnes* (edited by Bartsch, 1869), written in Arles. Somewhat more recent, but not later than the beginning of the 14th century, is a Passion of Christ (not yet printed) and a mystery of the Marriage of the Virgin, which is partly adapted from a French poem of the 13th century, (see *Romania* xvi. 71). A manuscript, discovered in private archives (printed by Jeanroy and Teulié, 1893), contains not less than sixteen short mysteries, three founded on the Old Testament, thirteen on the New. They were written in Rouergue and are partly imitated from French mysteries. At Manosque (Basses Alpes) was found a fragment of a *Ludus sancti Jacobi*, inserted in a register of notarial deeds (printed by C. Arnaud.

Marseilles, 1858). The region comprised between the Rhone and the Var seems to have been particularly fond of representations of this sort, to judge by the entries in the local records (see *Romania* xxvii. 400). At the close of the 15th and the beginning of the 16th centuries many mysteries were played in that part of Dauphiné which corresponds to the present department of Hautes-Alpes. Five mysteries of this district, composed and played somewhere about 1500 (the mysteries of St Eustace, of St Andrew, of St Pons, of SS Peter and Paul and of St Anthony of Vienne), have come down to us, and have been edited by Abbé Fazy (1883), the four others by Canon P. Guillaume (1883-1888). The influence of the contemporary French sacred drama may to some extent be traced in them.

Prose.—Prose composition in the south of France belongs to a comparatively late stage of literary development; and the same remark applies to the other Romanic countries, particularly to northern France, where prose hardly comes into fashion till the beginning of the 13th century, the prose of the preceding century being little else than translations of the books of the Bible (especially the Psalter).

As early as the 12th century we find in Languedoc sermons, whose importance is more linguistic than literary (*Sermons du XII^e siècle en vieux provençal*, ed. by F. Armitage, Heilbronn, 1884). About the same time, in Limousin, were translated chapters xiii.-xvii. of St John's Gospel (Bartsch, *Chrestomathie provençale*). Various translations of the New Testament and of some parts of the Old have been done in Languedoc and Provence during the 13th and 14th centuries (see S. Berger, "Les Bibles provençales et vaudoises," *Romania* xviii. 353; and "Nouvelles recherches sur les Bibles provençales et catalanes," *ibid.* xix. 505). The Provençal prose rendering of some lives of saints made in the early part of the 13th century (*Revue des langues romanes*, 1890) is more interesting from a purely linguistic than from a literary point of view. To the 13th century belong certain lives of the troubadours intended to be prefixed to, and to explain, their poems. Many of them were written before 1250, when the first anthologies of troubadour poetry were compiled; and some are the work of the troubadour Hugh of Saint Cirac. Some were composed in the north of Italy, at a time when the troubadours found more favour east of the Alps, than in their own country. Considered as historical documents these biographies are of a very doubtful value. Most of them are mere works of fiction, written by men who had no data except such informations as they derived from the songs they had to explain and which they often misunderstood. To the same period must be assigned *Las Razos de trobar* of the troubadour Raimon Vidal de Besalú (an elegant little treatise touching on various points of grammar and the poetic art), and also the *Donatz proensals* of Hugh Faidit, a writer otherwise unknown, who drew up his purely grammatical work at the request of two natives of northern Italy. A remarkable work, both in style and thought, is the *Life of St Douceline*, who died in 1274, near Marseilles, and founded an order of Beguines. In the 14th century compositions in prose grew more numerous. Some rare local chronicles may be mentioned, the most interesting being that of Mascaro, which contains the annals of the town of Béziers from 1338 to 1390. Theological treatises and pious legends translated from Latin and French also increase in number. The leading prose-work of this period is the treatise on grammar, poetry and rhetoric known by the name of *Leys d'amors*. It was composed in Toulouse, shortly before 1350, by a group of scholars, and was intended to fix the rules of the language with a view to the promotion of a poetical renaissance. For this purpose an academy was founded which awarded prizes in the shape of flowers to the best compositions in verse. We still possess the collection of the pieces crowned by this academy during the 14th century, and a large part of the 15th (*Flors del gay saber*). Unfortunately they are rather academic than poetic. The *Leys d'amors*, which was to be the starting-point and rule of the new poetry, is the best production of this abortive renaissance. The decay of Provençal literature, caused by political circumstances, arrived too soon to allow of a full development of prose. This accounts, in some measure for the complete absence of historical compositions. There is nothing to compare with Villehardouin or Joinville in northern France, or with Ramon Muntaner in Catalonia. The 14th and 15th centuries were in no respect a prosperous period for literature in the south of France. In the 15th century people began to write French both in verse and prose; and from that time Provençal literature became a thing of the past. From the 16th century such poetry as is written in the vernacular of southern France (Auger Gaillard, *La Bellaudiera*, Goudelin, d'Astros, &c.), is entirely dependent on French influence. The connexion with ancient Provençal literature is entirely broken.

BIBLIOGRAPHY.—Fauriel, *Histoire de la poésie provençale* (Paris, 1846, 3 vols. 8vo), is quite antiquated. Not only are three-fourths of the works in Provençal poetry ignored, but the very idea of the book is vitiated by the author's system (now abandoned), based on the supposition that in the south of France there was an immense epic literature. The articles on the troubadours in the *Histoire littéraire de la France*, by Ginguené, E. David, &c., must be consulted with extreme caution. F. Diez's *Die Poesie der Troubadours* (Zwickau, 1827, 8vo; new ed. by Bartsch, 1883) and his *Leben und*

Werke der Troubadours (Zwickau, 1829, 8vo; new ed. by Bartsch, 1882) are of great excellence for the time at which they appeared. A. Restori's *Letteratura provençale* (Milan, Hoepli, 1891), though very short and not free from oversights, gives a generally correct view of the subject. For the history of Provençal literature in Spain, see Milá y Fontanals, *De los Trovadores en España* (Barcelona, 1861, 8vo); for Italy, Cavedoni, *Ricerche storiche intorno ai trovatori provenzali* (Modena, 1844, 8vo); A. Thomas, *Francesco Barberino et la littérature provençale en Italie* (Paris, 1883, 8vo); O. Schultz, "Die Lebensverhältnisse der italienischen Trobadours," in *Zeits. für romanische Philologie* (1883). For the bibliography consult especially Bartsch, *Grundriss zur Geschichte der provenzalischen Literatur* (Elberfeld, 1872, 8vo). For texts the reader may be referred to Raynouard, *Choix de poésies originales des Troubadours* (1816-1821, 6 vols. 8vo), and *Lexique roman, ou dict. de la langue des troubadours*, of which vol. i. (1838) is entirely taken up with texts; and Rochegude, *Parnasse occitanien* (Toulouse, 1819, 8vo). All the pieces published by Raynouard and Rochegude have been reprinted without amendment by Mahn, *Die Werke der Troubadours in provenz. Sprache* (Berlin, 8vo, vol. i. 1846, ii. 1855-1864, iii. 1880; vol. iv. contains an edition of the troubadour Guiraut Riquier, 1853). The same editor's *Gedichte der Troubadours* (Berlin, 1856-1873) is a collection conspicuous for its want of order and of accuracy (see *Romania* iii. 303). Among editions of individual troubadours may be mentioned: *Peire Vidal's Lieder*, by Karl Bartsch (Berlin, 1857, 12mo.); *Les Derniers troubadours de la Provence*, by Paul Meyer (Paris, 1871, 8vo); *Der Troubadour Jaufre Rudel, sein Leben und seine Werke*, by A. Stimming (Kiel, 1873, 8vo); *Bertran de Born, sein Leben und seine Werke*, by A. Stimming (Halle, 1879, 8vo; revised and abridged edition, Halle, 1892); another edition, by A. Thomas (Toulouse, 1888, 8vo); *Guilhem Figuera, ein provenzalischer Troubadour*, by E. Levy (Berlin, 1880, 8vo); *Das Leben und die Lieder des Troubadours Peire Rogier*, by Carl Appel (Berlin, 1882, 8vo); *La vita e le opere del trovatore Arnaldo Daniello*, by U. A. Canello (Halle, 1883, 8vo); O. Schultz, *Die Briefe des Trobadours Raimbaut de Vaqueiras an Bonifaz I., Markgrafen von Monferrat* (Halle a. S., 1893); Italian edition (Florence, 1898); Cesare de Lollis, *Vita e poesie di Sordello di Goito* (Halle a. S., 1896); J. Coulet, *Le Troubadour Guilhem Montanhagol* (Toulouse, 1898); R. Zenker, *Die Lieder von Peires von Auvergne* (Erlangen, 1900); J. J. Salverda De Groot, *Le Troubadour Bertran d'Alamanon* (Toulouse, 1902); G. Beroni, *I Trovatori minori di Genova* (Dresden, 1903); and *Rambertino Buvaletti, trovatore bolognese* (Dresden, 1908, 8vo); A. Jeanroy, "Les Poésies de Gavandan" in *Romania*, vol. xxxiv. (Paris, 1905). Concerning the music of the Troubadours, see J. B. Beck, *Die Melodien der Troubadours* (Strasbourg, 1908). Among editions of Provençal works of a miscellaneous kind are: Bartsch, *Denkmäler der provenzalischen Literatur* (Stuttgart, 1856, 8vo); H. Suchier, *Denkmäler der provenz. Literatur und Sprache*, vol. i. 8vo (Halle, 1883); Paul Meyer, *La Chanson de la croisade contre les Albigeois* (2 vols. 8vo, Paris, 1875-1879); *idem*, *Daurel et Belon, chanson de geste provençale* (Paris, 1880, 8vo); *idem*, *Le Roman de Flamenca* (Paris, 1865, 8vo; 2nd ed., 1901); *idem*, *Guillaume de la Barre, roman d'aventures par Arnaut Vidal de Castelnaudari* (Paris, 1895, 8vo); E. Stengel, *Die beiden ältesten provenzal. Grammatiken, Lo Donatz proensals und Las Razos de trobar* (Marburg, 1878, 8vo); *Le Brevairi d'amor de Matfre Ermengaud*, published by the Archaeological Society of Béziers (2 vols. 8vo, Béziers, 1862-1880); A. L. Sardou, *La Vida de Sant Honorat, légende en vers provençaux par Raymond Feraud* (Nice, 1875, 8vo); Noulet and Chabaneau, *Deux manuscrits provençaux du XIV^e siècle* (Montpellier, 1888, 8vo); Albanès, *La Vie de Sainte Douceline* (Marseilles, 1879, 8vo). Documents and dissertations on various points of Provençal literature will be found in almost all the volumes of *Romania* (Paris, in progress since 1872, 8vo), and the *Revue des langues romanes* (Montpellier, in progress since 1870, 8vo). See also the other journals devoted in Germany and Italy to the Romanic languages, *passim*. (P. M.)

MODERN PROVENÇAL LITERATURE.¹—Literature in the south of France never died out entirely. Indeed, we have a link which, though too much importance may easily be attached to it, yet undoubtedly connects the products of the troubadours with the Provençal poetry of the present day. The Academy of Toulouse, founded in 1324, was flourishing in the 14th century, and, after many vicissitudes, is flourishing still. [The poets crowned by this body between 1324 and 1498 stand in the same relation to the troubadours as the *Meistersinger* do to the *Minnesänger*: academic correctness takes the place of inspiration. The institution flourished, even to the extent of establishing branches in Catalonia and Majorca; and in 1484, when its prosperity was threatened, a semi-fabulous person, Clémence Isaure, is said to have brought about a revival by instituting fresh prizes. The town of Toulouse never ceased to supply funds

¹ In accordance with general usage, we are employing the term Provençal for the whole of the south of France, save where special reservation is made.

of some kind. In 1513 French poems were first admitted in the competitions, and under Louis XIV. (from 1679) these were alone held eligible. This unfair arrangement, by which some of the leading poets of northern France profited, held good till 1893, when the town very properly transferred its patronage to a new *Escolo moundino*,¹ but very soon restored its support to the older institution, on learning that Provençal poetry was again to be encouraged.] In the two centuries that followed the glorious medieval period we have a succession of works, chiefly of a didactic and edifying character, which scarcely belong to the realm of literature proper, but at least served to keep alive some kind of literary tradition. This dreary interval was relieved by a number of religious mystery plays, which, though dull to us, probably gave keen enjoyment to the people, and represent a more popular genre; the latest that have come down to us may be placed between the years 1450-1515. Not only did the literature deteriorate during this period, but dialects took the place of the uniform literary language employed by the troubadours, while the spoken tongue yielded more and more to French. In 1539 François I. forbade the use of Provençal in official documents—a fact that is worthy of note only as being significant in itself, not as an important factor in the decadence of Provençal letters.

On the contrary, just about this time there are signs of a revival. In 1565 the Gascon, Pey de Garros, translated the Psalms into his dialect, and two years later published a volume of poems. His love for his native tongue is genuine, and his command over it considerable; he deplores its neglect, and urges others to follow his example. Auger Gaillard (c. 1530-1595) does infinitely less credit to his province: the popularity of his light pieces was probably due to their obscenity. More in the spirit of Garros is the charming trilingual *Salut* composed by the famous du Bartas in honour of a visit of Marguerite de Valois to Nérac (1579): three nymphs dispute as to whether she should be welcomed in Latin, French, or Gascon, and the last, of course, wins the day. Provence proper gave birth to a poet of considerable importance in Louis Bellaud de la Bellaudière (1532-1588), of Grasse, who, after studying at Aix, enlisted in the royal armies, and was made a prisoner at Moulins in 1572. During his captivity he wrote poems inspired by real love of liberty and of his native country (*Don-Don internal*, 1584 or 1585). At Aix Bellaud subsequently became the centre of a literary circle which included most of the local celebrities; all of these paid their tribute to the poet's memory in the edition of his works published by his uncle, Pierre Paul, himself the author of pieces of small value, included in the same volume (*Lous Passatens, obroes et rimos*, &c., Marseilles, 1595). Even when Bellaud is wholly frivolous, and intent on worldly pleasures only, his work has interest as reflecting the merry, careless life of the time.

A writer very popular in Provence for the light-hearted productions of his youth was Claude Brueys (1570-1650), remarkable chiefly for comedies that deal largely with duped husbands (*Jardin deys musos provensalos*, not published till 1628). There is a certain charm, too, in the comedies of Claude's disciple, Gaspard Zerbin (*La Perlo deys musos et coumedies provensalos*, 1655); and those critics who have read the plays of Jean de Cabanes (1653-1712) and of Seguin (of Tarascon, c. 1640), still in MS., speak highly of them. The most consistently popular form of poetry in the south of France was always the *noël*. There has been no limit to the production of these; but very rarely does the author deserve special mention. An exception must be made in the case of Nicholas Saboly (1614-1675), who produced the best pieces of this class, both as regards beauty of language and the devotion they breathe. They have deservedly maintained their popularity to the present day. In Languedoc four poets have been cited as the best of the age—Goudelin, Michel, Sage and Bonnet. This is certainly so in the case of Pierre Goudelin (province Goudouli, 1579-1649), of Toulouse, the most distinguished name in south French literature

¹ *Moundino*, i.e. of Toulouse; a common designation, derived from Raymond, the familiar name of the counts of Toulouse.

between the period of the troubadours and that of Jasmin. He had a good classical education, traces of which appear in all his poetry, his language and his manner being always admirable, even where his matter is lacking in depth. He is often called "the Malherbe of the South," but resembles that writer only in form: his poetry, taken as a whole, has far more sap. Goudelin essayed and was successful in almost every short genre (*Lou Ramelet Moundi*, 1617, republished with additions till 1678), the piece of his which is most generally admired being the stanzas to Henri IV., though others will prefer him in his gayer moods. He enjoyed enormous popularity (extending to Spain and Italy), but never prostituted his art to cheap effects. His influence, especially but not exclusively in Provence, has been deep and lasting. The fame of Jean Michel, of Nîmes, rests on the *Embarras de la foire de Beaucaire*, a poem of astonishing vigour, but deficient in taste. Daniel Sage, of Montpellier (*Las Foulies*, 1650), was a man of loose morals, which are reflected in nearly all his works: his moments of genuine inspiration from other causes are rare. More worthy of being bracketed with Goudelin is the *avocat* Bonnet, author of the best among the open air plays that were annually performed at Béziers on Ascension Day: a number of these (dated 1616-1657) were subsequently collected, but none can compare with the opening one, Bonnet's *Jugement de Paris*. Another very charming poet is Nicolas Fizes, of Frontignan, whose vaudeville, the *Opéra de Frontignan* (1670), dealing with a slight love intrigue, and an idyllic poem on the fountain of Frontignan, show a real poetic gift. A number of Toulouse poets, mostly *lauréats* of the Academy, may be termed followers of Goudelin: of these François Boudet deserves mention, who composed an ode, *Le Trinfe del Moundi* (1678), in honour of his native dialect. The classical revival that may be noted about this time is also generally ascribed to Goudelin's influence. Its most distinguished representative was Jean de Valès, of Montech, who made excellent translations from Virgil and Persius, and wrote a brilliant burlesque of the former in the manner of Scarron (*Virgile deguisat*, 1648; only four books published). He also composed a pastoral idyll, which, though too long and inclined to obscenity, contains much tender description. The greatest of the pastoral poets was François de Cortete (1571-1655), of Prades, whose comedies, *Ramounet* and *Miramoundo* (published, unfortunately with alterations, by his son in 1684), are written with such true feeling and in so pure a style that they can be read with real pleasure. A comedy of his dealing with Sancho Panza in the palace of the Duke has been edited. It is difficult to understand the enormous popularity of Daubasse (1664-1727), of Quercy, who belonged to the working classes; he was patronized by the nobility in exchange for panegyrics. Gascony produced two typical works in the 17th century: Ader's *Gentil-homme gasconn* (1610) and Dastros's *Trinfe de la langue gascoune* (1642). The former depicts a regular boasting Gascon who distinguishes himself in everything; while the latter is a plea in favour of the Gascon tongue, inspired by a genuine love of country. Gabriel Bedout (*Parterre gasconn*, 1642) is chiefly noted for his amorous *solitari*, called forth by the sufferings he endured from a hardhearted mistress. Louis Baron (b. 1612), living peacefully in his native village of Pouyloubriin, celebrated it with great tenderness.

In the 18th century the number of authors is much larger, but the bulk of good work produced is not equally great in proportion. The priests are mainly responsible for the literary output of Languedoc. Claude Peyrot (1709-1795) one of them, celebrates his county with true rural spirit in the *Printemps rouergat* and *Quartre sossous*. But the chief of the band is the Abbé Favre (1727-1783), the prior of Celleneuve, whose *Sermoun de moussu sistre*, delivered by a drunken priest against intemperance, is a masterpiece. He also wrote a successful mock-heroic poem (*Siège de Caderousse*) travesties of Homer and Virgil, a prose novel depicting the country manners of the time (*Histoire de Jean l'ont pris*), and two comedies, which likewise give a vivid picture of the village life he knew so well. Two genuine poets are the brothers Rigaud of Montpellier: Auguste's (1760-1835)

description of a vintage is deservedly famous; and Cyrille (1750-1824) produced an equally delightful poem in the *Amours de Mounpèie*. Pierre Hellies of Toulouse (d. 1724) a poet of the people, whose vicious life finds an echo in his works, has a certain rude charm, at times distantly recalling Villon. In the Province Toussaint Gros (1698-1748), of Lyons, holds undisputed sway. His style and language are admirable, but unfortunately he wasted his gifts largely on trivial *pièces d'occasion*. Coye's (1711-1777) comedy, the *Fiancé paré*, is bright and still popular, while Germain's description of a visit paid by the ancient gods to Marseilles (*La Bourrido dei Diou*s, 1760) has considerable humour. In Gascony the greatest poet is Cyrien Despourrins (1698-1755), whose pastoral idylls and mournful chansons, which he himself set to music, are imbued with tenderness and charm (most of them were collected at Pau, in 1828).

The Revolution produced a large body of literature, but nothing of lasting interest. However, it gave an impetus to thought in the south of France, as elsewhere; and there, as elsewhere, it called forth a spirit of independence that was all in favour of a literary revival. Scholars of the stamp of Raynouard (1761-1863), of Aix, occupied themselves with the brilliant literary traditions of the middle ages; newspapers sprang up (the Provençal *Bouil-Abaisso*, started by Désanat, and the bilingual *Lou Tambourin et le menestrel*, edited by Bellot, both in 1841); poets banded together and collected their pieces in volume form (thus, the nine *troubaire* who published *Lou Bouquet prouvençau* in 1823). Much has been written about the *précurseurs de Félibrige*, and critics are sorely at variance as to the writers that most deserve this appellation. We shall not go far wrong if we include in the list Hyacinthe Morel (1756-1829), of Avignon, whose collection of poems, *Lou Saboulet*, has been republished by Mistral; Louis Aubanel (1758-1842), of Nîmes, the successful translator of Anacreon's Odes; Auguste Tandon, "the troubadour of Montpellier," who wrote *Fables, contes et autres pièces en vers* (1800); Fabre d'Olivet (1767-1825), the versatile *littérateur* who in 1803 published *Le Troubadour: Poésies occitaniques*, which, in order to secure their success, he gave out as the work of some medieval poet Dioulouf (1771-1840), who wrote a didactic poem, in the manner of Virgil, relating to silkworm-breeding (*Leis magnans*); Jacques Azaïs (1778-1856), author of satires, fables, &c.; D'Astros (1780-1863), a writer of fables in Lafontaine's manner; Castil-Blaze (1784-1857), who found time, amidst his musical pursuits, to compose Provençal poems, intended to be set to music; the Marquis de Fare-Alais (1791-1846), author of some light satirical tales (*Las Castagnados*). While these writers were all more or less academic, and appealed to the cultured few, four poets of the people addressed a far wider public: Verdié (1779-1820), of Bordeaux, who wrote comic and satirical pieces; Jean Reboul (1796-1864), the baker of Nîmes, who never surpassed his first effort, *L'Ange et l'enfant* (1828);¹ Victor Gelu (1806-1885), relentless and brutal, but undeniably powerful of his kind (*Fenian et Grouman; dix chansons provençales*, 1840); and, greatest of them all, the true and acknowledged forerunner of the *félibres*, Jacques Jasmin (1798-1864), the hairdresser of Agen, whose poems, both lyrical and narrative, continue to find favour with men of the highest culture and literary attainments, as with the villagers for whom they were primarily intended.

While much of this literature was still in the making, an event took place which was destined to eclipse in importance any that had gone before. In 1845 Joseph Roumanille (1818-1891), a gardener's son, of Saint-Remy (Bouches-du-Rhône), became usher in a small school at Avignon, which was attended by Frédéric Mistral (*q.v.*), a native of the same district, then fifteen years of age. The former, feeling the germs of poetry within him, had composed some pieces in French; but, finding that his old mother could not understand them, he was greatly distressed,

and determined thenceforth to write in his native dialect only. These poems revealed a new world to young Mistral, and spurred him on to the resolve that became the one purpose of his life—*de remettre en lumière et conscience de sa gloire cette noble race qu'en plein '89 Mirabeau nomme encore la nation provençale*. There is no doubt that Mistral's is the more puissant personality, and that his finest work towers above that of his fellows; but in studying the Provençal renaissance, Roumanille's great claims should not be overlooked, and they have never been put forward with more force than by Mistral himself (in the preface to his *Isclou d'oro*). Roumanille's secular verse cannot fail to appeal to every lover of pure and sincere poetry (*Li Margaritudo*, 1836-1847; *Li Sounjarello*, 1852; *Li Flour de Sauvi*, 1850-1859, &c.), his *noëls* are second only to those of Saboly, his prose works (such as *Lou mege de Cucugnan*, 1863) sparkling with delightful humour. He it was who in 1852 collected and published *Li Prouvençalo*, an anthology in which all the names yet to become famous, and most of those famous already (such as Jasmin), are represented. In 1853 he was one of the enthusiastic circle that had gathered round J. B. Gaut at Aix, and whose literary output is contained in the *Roumanagi dei Troubaire* and in the shortlived journal *Lou gay saber* (1854). At the same time the first attempt at regulating the orthography of Provençal was made by him (in the introduction to his play, *La Part dou bon Dieu*, 1853). And in 1854 he was one of the seven poets who, on the 21st of May, foregathered at the castle of Fontségugne, near Avignon, and founded the *Félibrige*. [The etymology of this word has given rise to much speculation: the one thing certain about the word is that Mistral came across it in an old Provençal poem, which tells how the Virgin meets Jesus in the Temple, among the seven *félibres* of the law. The outlines of the constitution, as finally settled in 1876, are as follows: The region of the *Félibrige* is divided into four *mantenengo* (Provence, Languedoc, Aquitaine and Catalonia²). At the head of all is a *consistori* of fifty (called *majourau*), presided over by the *Capouliè*, who is chief of the entire *Félibrige*. The head of each *mantenengo* is called *sendj* (who is at the same time a *majourau*); and at the head of each "school" (as the subdivisions of the *mantenengo* are called) is a *cabiscou*. The ordinary members, unlimited in number, are *mantenèire*. Annual meetings and *fêtes* are organized. The most widely read of the *Félibrige* publications is the *Armana prouvençau*, which has appeared annually since 1855, maintaining all the while its original scope and purpose; and though unpretentious in form, it contains much of the best work of the school.³ The other six were Mistral, Aubanel, A. Mathieu (a schoolfellow of Mistral's at Avignon), E. Garcin, A. Tavan and P. Giera (owner of the castle). Of these, Théodore Aubanel (1829-1886, of Avignon, son of a printer and following the same calling) has alone proved himself worthy to rank with Mistral and Roumanille. "Zani," the girl of his youthful and passionate love, took the veil; and this event cast a shadow over his whole life, and determined the character of all his poetry (*Lou miògrano entre-duberto*, 1860; *Li Fihò d'Avignoun*, 1883). His is, without a doubt, the deepest nature and temperament among the *félibres*, and his lyrics are the most poignant. He has a keen sense of physical beauty in woman, and his verse is replete with suppressed passion, but he never sinks to sensuality. His powerful love drama *Lou pau dou peccat* was received with enthusiasm at Montpellier in 1878, and successfully produced (some years later in Arène's version) by Antoine at his Théâtre Libre—no mean criterion. It is the only play of real consequence that the school has yet produced.

We need not do more than glance at the work of the fourth of the group of poets who alone, amidst the numerous writers of lyrics and other works that attain a high level of excellence.

² One of the most pleasing features of the movement is the spirit of fraternity maintained by the *félibres* with the poets and literary men of northern France, Spain, Italy, Rumania, Germany and other countries.

³ In common with so many other productions of the *Félibrige*, this Almanac is published by the firm J. Roumanille, Libraire-Éditour, Avignon.

¹ One of his chief titles to fame is that, together with Alphonse Dumas, he drew the attention of Lamartine to Mistral's *Mirèio*. Roumanille and Mistral showed their gratitude by republishing the best pieces of these two *précurseurs*, together with those of Castil-Blaze and others, in *Un Liame de Rasin* (1865).

appear to us to have so far secured permanent fame by the magnitude of their achievement. Félix Gras (1844-1891) settled at Avignon in his youth. His rustic epic, *Li Carboundé* (1876) is full of elemental passion and abounds in fine descriptions of scenery, but it lacks proportion. The heroic *geste* of *Tolosa* (1882), in which Simon de Montfort's invasion of the south is depicted with unbounded vigour and intensity, shows a great advance in art. *Li Roumancero provençal* (1887) is a collection of poems instinct with Provençal lore, and in *Li Papalino* (1891) we have some charming prose tales that bring to life again the Avignon of the popes. Finally, the poet gave us three tales dealing with the period of the Revolution (*Li Rouge dou miejour*, &c.); their realism and literary art called forth general admiration.¹

A few lines must suffice for some of the general aspects of the movement. It goes without saying that all is not perfect harmony; but, on the whole, the differences are differences of detail only, not of principle. While Mistral and many of the best *félibres* employ the dialect of the Bouches-du-Rhône, others, who have since seceded as the *Félibrige latin* (headed by Roque-Ferrier), prefer to use the dialect of Montpellier, owing to its central position. A third class favour the dialect of Limousin, as having been the literary vehicle of the troubadours; but their claim is of the slenderest, for the *félibres* are in no sense of the word the direct successors of the troubadours. Nearly all the leaders of the *Félibrige* are Legitimists and Catholics, their faith being the simple faith of the people, undisturbed by philosophic doubts. There are exceptions, however, chief among them the Protestant Gras, whose *Tolosa* clearly reflects his sympathy with the Albigenses. Yet this did not stand in the way of his election as *Capoulidè*—a proof, if proof were needed, that literary merit outweighs all other considerations in this artistic body of men. Finally, it may be noted that the *félibres* have often been accused of lack of patriotism towards northern France, of schemes of decentralization, and other heresies; but none of these charges holds good. The spirit of the movement, as represented by its leaders, has never been expressed with greater terseness, force and truth than in the three verses set by Félix Gras at the head of his *Carboundé*: "I love my village more than thy village; I love my Provence more than thy province; I love France more than all."

AUTHORITÉS.—*Las Joyas del gay saber*, edited by Noulet (vol. iv. of Gatién-Arnoult's *Monumens de la littérature romane*, &c., Toulouse, 1849); Noulet, *Essai sur l'histoire littéraire des patois du midi de la France aux XVI^e et XVII^e siècles* (Paris, 1859) and . . . *au XVIII^e siècle* (Paris, 1877); Gaut, "Étude sur la littérature et la poésie provençales" (*Mémoires de l'Académie des sciences*, &c., d'Aix, tome ix. pp. 247-344, Aix, 1867); Mary-Lafon, *Histoire littéraire du midi de la France* (Paris, 1882); Restori, *Letteratura provençale*, pp. 200-214 (Milano, 1891); Mariéton's articles on *Provençal* and *Félibrige* in the *Grande encyclopédie*; Donnadieu, *Les Précurseurs des félibres 1800-1855*; (Paris, 1888); Jourdanne, *Histoire du Félibrige, 1854-1806* (Avignon, 1897); Hennion, *Les Fleurs félibresques* (Paris, 1883); Portal, *La letteratura provençale moderna* (Palermo, 1893); Koschwitz, *Ueber die provençalischen Félibre und ihre Vorgänger* (Berlin, 1894); Mariéton, *La Terre provençale* (Paris, 1894). (H. O.)

PROVENCE (*Provincia, Proenza*), a province in the south-east of ancient France, bounded on the N. by the Dauphiné, on the E. by the Rhône and Languedoc, on the W. by the Alps and Italy, and on the S. by the Mediterranean. The coast, originally inhabited by Ligurians, was from an early date the home of some Phœnician merchants. About 600 B.C., according to tradition, some traders from Phœacia founded the Greek colony of *Massalia* (Marseilles) and the colonists had great difficulty in resisting the Cavares and the Salyes, *i.e.* the Ligurian peoples in the vicinity. Other colonies in the neighbourhood, such as Antibes, Agde, Nice, originated in this settlement. During the wars which followed, the inhabitants of Massalia asked assistance from the Romans, who thus made their first entry into Gaul (125 B.C.), and, after a campaign which lasted several years under the

direction of the pro-consul C. Sextius Calvinus, conquered the territories between the Alps, the sea and the Rhône (with the province of Narbonne on the right bank of this river). These lands formed the *Provincia romana*, and the name was retained by Provence. The town of Aix (*Aquæ Sextiæ*) was founded to form the capital of this conquered land. In consequence of the conquest of Gaul by Caesar (50 B.C.) and the administrative reforms introduced by Augustus, the territory of the former *Provincia* was divided into the new provinces of Narbonensis II., of the Maritime Alps and of Viennois, but it still remained an important centre of Roman learning and civilization. Marseilles, which for some time had a prosperous Greek school, and also Aix now became of secondary importance, and Arles was made the chief town of the province, becoming after the capture of Trèves by the barbarians (A.D. 418) the capital of Gaul. Christianity spread fairly early into Provence, although the legend that this country was evangelized by Mary Magdalene and some of the apostles cannot be traced farther back than the 12th century. Trophimus established a church at Arles in the 3rd century, and during the two centuries which followed bishoprics were founded in all the cities of Provence.

At the beginning of the 5th century, Provence was attacked by the Visigoths. In 425 the Visigothic king Theodoric I. was defeated by Actius under the walls of Arles, but the part taken by the Goths in the election of the emperor Avitus did not put a stop to their attacks (450). In 480 Arles was captured by Euric I., and the southern part of Provence, *i.e.* the country south of the Durance, thus came definitely under Visigothic rule. The more northern cities, such as Orange, Apt, Trois-Châteaux, &c., were again joined to the kingdom of Burgundy. Towards 510 Visigothic Provence was ceded to Theodoric, king of the Italian Ostrogoths, by Alaric II. as a mark of his gratitude for the support given to him during the war against the Franks. In addition to this, about 523, the Ostrogoths took advantage of the wars between the Franks and the Burgundians to extend their lands in the north as far as Gap and Embrun. Vitiges, king of the Ostrogoths, ceded Provence to the kings of the Franks about 537, when it was divided in a peculiar manner: the northern cities and those on the coast (Arles, Marseilles, Toulon, Antibes, Nice) were given back to Burgundy, whilst a narrow strip of territory with Avignon, Apt, Cavaillon, Rièz, &c., extending from the west to the east as far as the Alps, was added to the kingdom of Austrasia, and from that time followed the fortunes of Auvergne, which, as is known, was generally dependent on Austrasia. Provence was united under one ruler during the reigns of Clotaire II. and Dagobert I., but at the death of the latter in 639 was divided again, only to be reunited under the successors of Dagobert II. (679). At this period the name of Provence was restricted to the southern cities, which had passed from the Gothic to the Frankish rule; it did not regain its original signification and denote the country extending as far as Lyonnais till the end of the 8th and the beginning of the 9th centuries.

At the beginning of the 8th century, some Arabs from Spain, who had crossed the Pyrenees and settled down in Septimania, attacked Provence, in 735 took the town of Arles and in 737 captured Avignon, thus becoming masters of one part of the country. Charles Martel who had already made two expeditions against them, in 736 and 737, with the help of the Lombards of Italy, succeeded in expelling them, and brought the country definitely under Frankish rule. Austrasian counts were given authority in the cities, and under Charlemagne and Louis the Pious the history of Provence became incorporated with that of the rest of the empire. At the time of the partition of Verdun (843) Provence fell to the share of the emperor Lothair I., who joined it to the duchy of Lyons in 855 to form a kingdom for his youngest son, Charles. On the death of the latter in 863 his inheritance was divided between his two brothers, when Lothair II., king of Lorraine, received the northern part, Lyonnais and Viennois, and to the other, the emperor Louis II., king of Italy, was given Provence. At his death in 875 Provence passed into the hands of Charles the Bald, and he entrusted

¹ Gras was *Capoulidè* from 1891 till 1901, succeeding his brother-in-law, Roumanille, who held the office from 1888 till 1891. The first *Capoulidè* was, of course, Mistral (1876-1888). Gras's successor was Pierre Devoluy, of Die (appointed in April 1901).

the government to his brother-in-law, Duke Boso, who, taking advantage of the struggles between the Frankish princes which followed the death of Charles the Bald, reconstituted the former kingdom of Charles, the son of Lothair, and in 879 was acknowledged as its sovereign at Mantaille in Viennois. This is the kingdom of Provence (Provence, Viennois, Lyonnais and Vivarais), sometimes, but improperly, called Cisjuran Burgundy.

Boso died in 887, having succeeded in maintaining his independence against the united Frankish princes. His widow Ermengarde, daughter of Louis II., with the assistance of the emperor Arnulf, had her son Louis acknowledged king at an assembly held at Valence in 890. Louis attempted to seize the crown of Italy in 900, and in 901 was even crowned emperor at Rome by Pope Benedict IV.; but in 905 he was surprised at Verona by his rival Berengar, who captured him, put out his eyes, and forced him to give up Italy and return to Provence; he lived here till his death in 928, leaving an illegitimate son, Charles Constantine. The principal figure in the country at this time was Hugo (Hugues) "of Arles," count, or duke, of Viennois and marquis of Provence, who had been king of Italy since 926. In order to retain possession of this country, he gave the kingdom of Louis the Blind to Rudolph II., king of Burgundy (*q.v.*), and thus the kingdom of Burgundy extended from the source of the Aar to the Mediterranean. But the sovereignty of Rudolph II. and his successors, Conrad (937-993) and Rudolph III. (993-1032), over Provence was almost purely nominal, and things were in much the same condition when, on the death of Rudolph III., the kingdom of Burgundy passed into the hands of the German kings, who now bore the title of kings of Arles, but very rarely exercised their authority in the country.

At the beginning of the 10th century Provence was in a state of complete disorganization, a result of the invasions of the Saracens, who, coming from Spain, took up their quarters in the neighbourhood of Fraxinetum (La Garde-Freinet in the department of Var) and ravaged the country pitilessly, the Christians being unable to oust them from their strongholds. All the real power was in the hands of the counts of the country. It is probable that from the 9th century several of the Provençal countships were united under one count, and that the count of Arles had the title of duke, or marquis, and exercised authority over the others. In the middle of the 10th century the countship of Provence was in the hands of a certain Boso, of unknown origin, who left it to his two sons William and Roubaud (Rotbold). These two profited by the commotion caused by the capture of the famous abbot of Cluny, St Maiolus (Mayeul), in 973, who had fallen into the hands of the Saracens, and marched against the Mussulmans, definitely expelling them from Fraxinetum. About the same period the marquiseate seems to have been re-established in favour of Count William, who died in 993, and from that time the descendants of the two brothers, without making any partition, ruled over the different countships of Provence, only one of them, however, bearing the title of marquis. The counts of Provence had, from about the middle of the 11th century, a tendency to add the name of their usual residence after their title, and thus the lordships, known later under the names of the countships of Arles (or more properly Provence), of Nice, and of Venaissin, grew up. Roubaud had one son named William, who died without children, about 1043, and one daughter, Emma, who married William, count of Toulouse, by whom she had a son, Pons (1030-1063), the father of Raymund of Saint-Gilles (1063-1105). William also had a son of the same name. This William II. had three sons by his wife Gerberge—Fulk, Geoffrey and William. The last-mentioned had a son, William Bertrand (1044-1067), whose daughter Adelaide married, first, Ermengaud, count of Urgel, and then Raimbaud of Nice. Geoffrey was the father of Gerberge, who married Gilbert, count of Gévaudan, and he had a daughter Douce, who in 1112 married Raymund-Bérenger, count of Barcelona; by this marriage, Provence, in the correct sense of the word, passed over to the house of Barcelona. At the beginning of the 12th century the various marriages of the Provençal heiresses, of whom mention has just been made, led

to the land being divided up among the different branches of the ancient countly family (1105, 1125 and 1149), and thus the countships of Provence, Venaissin and Forcalquier were definitely formed.

Under the command of Raymund of Saint-Gilles the Provençals took an important part in the first crusade, and the use of the term "Provençal" to denote the inhabitants of southern France, their language and their literature, seems to date from this period.

The history of the princes of the house of Barcelona, Raymund-Bérenger I. (1113-1131), Raymund-Bérenger II. (1131-1144) and Raymund-Bérenger III. (1144-1166), is full of accounts of their struggles with the powerful feudal house of Baux, which had extensive property in Provence; in 1146 one of the representatives of this house, Raymund, obtained from the emperor the investiture, though only in theory, of the whole countship of Provence. After the death of Raymund-Bérenger III., who was killed at the siege of Nice (1166), his cousin Alphonso II., king of Aragon, claimed his inheritance and took the title of the count of Provence. But his succession was disputed by the count of Toulouse, Raymund V., a marriage having been previously arranged between Raymund-Bérenger's daughter and his son, and he himself hastening to marry the widow Richilde, niece of the emperor Frederick I. The majority of the lay and ecclesiastical lords of Provence recognized Alphonso, who in 1176 signed a treaty with his competitor, by which Raymund V. gave up his rights to the king of Aragon in consideration of a sum of money. Alphonso was represented in Provence by his brothers Raymund-Bérenger and Sancho in turn, and in 1193 by his son Alphonso, who succeeded him. This Alphonso gave Aragon and Catalonia to his brother Peter (Pedro), and kept only Provence for himself, but on the death of his father-in-law, Count William II., in 1208, whose son had been disinherited, he added to it the county of Forcalquier. He was able to protect Provence from the consequences of the war of the Albigenses, and it was not until after his death (1209), during the minority of his son Raymund-Bérenger IV., who succeeded him under the regency of his uncle, Peter of Aragon, and later of his mother Gersende, that Provence was involved in the struggle of the count of Toulouse against Simon de Montfort, when the part played by the city of Avignon in the Albigensian movement finally led to Louis VIII.'s expedition against the town. William of Baux took advantage of the troubles caused by Raymund-Bérenger's minority to have the kingdom of Arles conferred upon himself by Frederick II.; this led, however, to no practical result. Raymund-Bérenger had also to fight against Raymund VII., count of Toulouse, the emperor having ceded to this latter in 1230 the countship of Forcalquier, and showed another mark of his favour in 1238, when, in consequence of some difficulties with the city of Arles, Raymund-Bérenger drove the imperial vicar from the town. The intervention of St Louis, who in 1234 had married Margaret, the eldest daughter of the count of Provence (the second, Eleanor, married Henry III. of England in 1236), put an end to the designs of the count of Toulouse. Raymund-Bérenger died in 1245, leaving a will by which he named as his heiress his fourth daughter, Beatrice, who shortly afterwards, in 1246, married the celebrated Charles of Anjou (see CHARLES I., king of Naples), brother of the king of France. After her death, in 1267, Charles still maintained his rights in Provence. The countship of Venaissin was left to him by his sister-in-law, Jeanne, countess of Toulouse, but in 1272 King Philip the Bold took possession of it, giving it up in 1274 to Pope Gregory X., who had claimed it for the Roman Church in pursuance of the treaty of 1229 between Raymund VII. of Toulouse and St Louis. Almost all the time and energy of Charles of Anjou were taken up with expeditions and wars concerning the kingdom of Naples, which he had gained by his victories over Manfred and Conradin in 1266 and 1268. His government of Provence was marked by his struggles with the towns. The movement which resulted in the emancipation of these had its origin fairly far back. In the first part of the 12th century the towns of Provence, no

doubt following the example of those in Italy, began to form municipal administrations and consulates, independent of the viscounts, who in theory represented the authority of the count in the towns. This movement was occasionally interrupted by home disturbances, such as struggles against the civil and ecclesiastical authorities; nevertheless Marseilles, Arles, Tarascon, Avignon (whose consulate laws date from the 12th century), Brignoles and Grasse were self-governing and elected their magistrates, sometimes negotiating with the count, as a power with a power, and concluding political or commercial treaties without consulting him. The city of Nice, which was joined to Provence in 1176, had retained its freedom. This state of affairs was in direct opposition to the authoritative government of Charles of Anjou, who tried to bring back the most independent of these towns under his sway. In 1251 he seized Arles and Avignon and placed them under a *viguier* (vicar) nominated by himself. In 1257 Marseilles was also subdued, and ministers nominated by the court performed their duties side by side with the municipal officials.

The successors of Charles of Anjou also showed great interest in maintaining their rights over the kingdom of Naples, and only occasionally do they appear in the history of Provence. Charles II. (1285-1309), after failing in several attacks on the house of Aragon in southern Italy, lived in the country during the latter years of his reign as duke, and tried to reform some of the abuses which had grown up in the administration of justice and finance. Robert of Calabria (1309-1343), his son and successor, was forced to sustain a long siege in Genoa, whither he had been called by the Ghibelline party: a siege which cost a large number of lives to the Provençal navy. Robert was succeeded by his granddaughter Joanna, widow of Andrew of Hungary, who sold her rights over the city of Avignon to Pope Clement VI. in 1348, in order to raise funds to enable her to continue the struggle against the house of Aragon in her Neapolitan states. The political situation of the country was not much changed by Charles IV.'s residence in Provence, nor by the empty ceremony of his coronation as king of Arles (1365). Charles IV. gave up his rights, or his claims, to Louis, duke of Anjou, brother of Charles V., but the expedition which this prince made to take possession of Provence only resulted in the seizure of Tarascon, and failed before Arles (1368). Joanna had nominated as her heir Charles of Anjou-Gravina, duke of Duras, who had married her niece Margaret, but to provide herself with a protector from Louis of Hungary, who accused her of murdering her first husband Andrew and wished to dispute her right to the kingdom of Naples, she married again and became the wife of Otto of Brunswick. Charles of Duras, discontented with this marriage, took part against her, and she in her turn disinherited him and named Louis of Anjou as her eventual successor (1380). The duke of Anjou took possession of Provence, whilst Charles of Duras made the queen prisoner at Naples and gave orders for her to be put to death (1382). Louis of Anjou also made an expedition to Naples, but did not arrive till after her death, and he died in 1384. His son Louis II. (1384-1417) banished the viscount of Turenne from Provence, because he had taken advantage of his sovereign's absence to ravage the country. He did not live in Provence till the last years of his life; in 1415 he established a parlement. The following year the country was devastated by a terrible plague. The wars carried on by his successor Louis III. (1417-34) against the kings of Aragon, his rivals at Naples, were the cause of the complete ruin of Marseilles by the Aragonese fleet. The town, however, regained its former state comparatively quickly. Although Louis III. had centred almost all his attention on the expeditions in Italy, he managed to secure the lands belonging to the house of Baux on the death of the last of the family, the Baroness Alix (1426). René, duke of Lorraine (*q.v.*), Louis's brother and successor, after an unsuccessful attack on Naples (1460-1461), went to live on his property in France, and after 1471 was principally in Provence, where he built the castle of Tarascon and interested himself in art, literature, and pastoral amusements. He left his territories

(Anjou, Lorraine, Provence) to his nephew Charles, count of Maine, by his will in 1474. Louis XI., king of France, protested at first in the name of the rights of the Crown, and even seized René's duchies. In consequence, however, of an interview between René and the king at Lyons, the former obtained a withdrawal of the seizure and ended his days peacefully in Provence (1480). The rights of his successor, Charles, were disputed by René II., duke of Lorraine, but, with the support of Louis XI., his attack on Provence was defeated. On the other hand, Louis had corrupted some of Charles's advisers, especially Palamède de Forbin, with the result that, at Charles's death in 1482, he left Provence to the king of France in his will. René of Lorraine protested in vain; Louis claimed the possession of the disputed territory, but Provence was not definitely annexed to France till 1486, under Charles VIII., and even then it preserved a certain individuality. In laws relating to this country the sovereigns added to their title of king of France "and count of Provence and of Forcalquier," and Provence always preserved a separate administrative organization.

In the 16th century Provence took part in a war between France and the imperialists. The constable de Bourbon, who had received the investiture of Provence from the emperor Charles V., crossed the Var in 1524 with an army, but was defeated at Marseilles. The expedition under Charles V. and the duke of Savoy in 1536 had no more definite result than the coronation of the emperor at Aix as king of Arles. About the same time the first signs of the Reformation became evident in Provence, at first in the country of the ancient Vaudois at Cabrières and at Mérindol in the county of Venaissin. A sentence passed in 1540 by the parlement of Provence against these heretics was carried out with great severity in 1545 by the president d'Oppède and the baron de la Garde, who burned the villages and massacred the inhabitants. Protestantism did not take a great hold on Provence, but drew a fair number of followers from the ranks of the lesser nobles, who, with Paul de Mauvans at their head, began the struggle against the Catholics under the comte de Carces. Charles IX.'s journey in Provence in 1567, followed by the establishment in the parlement at Aix of a court (*chambre*) in which Catholics and Protestants had an equal number of seats, led to a momentary cessation of hostilities. These were resumed between the *Carcistes* (Roman Catholics) and *Razats* (Protestants), and again interrupted by the peace of 1576, which gave some guarantees to the Protestants, with La Seyne as a place of security, and also by the plague of 1579, which affected the whole country. The league, on the other hand, made rapid progress in Provence under the direction of the comte de Sault and Hubert de la Garde, seigneur of Vins, and the governors of Épernon and La Valette vainly tried to pacify the country. La Valette and the political party or *Bigarrats* were finally more or less reconciled to the Protestants, and, at the time of the death of Henry III., the struggle was no more than a question of district politics. Weakened by the division between the comtesse de Sault and the young comte de Carces, the league applied to the duke of Savoy, who was besieging Marseilles. Carces and the other heads of the league submitted one after the other to the new governor Lesdiguières, who was succeeded by the duke of Guise in 1595, and in 1596 the religious wars in Provence were definitely ended by the capitulation of Marseilles.

During the reign of Henry IV. the country was comparatively peaceful; but under Richelieu the restriction of local freedom and the creation of new offices led to the insurrection of the *Cascazeous* (small bells, a name derived from their rallying sign), which Condé came to suppress in 1630-1631. At the time of the Fronde additional taxes were levied by the parlement at Aix, and the struggle began between the *Canivets* (Mazarins) and the *Sabreurs* (prince's party), who captured the governor, the comte d'Alais, for a short time. The duke of Mercoeur calmed the country down. Louis XIV.'s tour in Provence (1666) was marked by an insurrection at Marseilles, which brought about the abolition of the last remaining municipal liberties of the town. Provence was severely tried by the

imperialist invasions of 1706 and 1746, and the great plague of 1720. Towards the end of the *ancien régime* the movement which resulted in the revolution of 1789 made itself felt in Provence, and was most apparent in the double election at Aix and at Marseilles of Mirabeau as deputy for the states-general.

Provence, with its own special language and its law so closely related to Roman law, has always been quite separate from the other French provinces. Theoretically it retained its provincial estates, the origin of which has been traced to the assemblages of the 12th century. They met annually, and included representatives of three orders: for the clergy, the archbishop of Aix, president *ex officio* of the estates, the other bishops of Provence, the abbots of St Victor at Marseilles, of Montmajour and of Thoronet; for the nobility, all the men of noble birth (*gentilhommes*) until 1623, when this privilege was restricted to actual holders of fiefs; for the third, the members of the twenty-two chief towns of the *vigueries*¹ and fifteen other privileged places, among which were Arles and Marseilles. There were theoretically no taxes, but only supplies given freely by the estates and assessed by them. However, this assembly did not meet after 1639. The administrative divisions of Provence were constantly changing. In 1307 Charles II. divided it into two *sénéchaussées*, Aix and Forcalquier, comprising twenty-two *vigueries*. At the end of the *ancien régime* the government (*gouvernement*) of Provence, which corresponded to the *généralité* of Aix, was made up of eight *sénéchaussées*, those of Lower Provence—Aix, Arles, Marseilles, Brignoles, Hyères, Grasse, Draguignan, Toulon; and four of Upper Provence—Digne, Sisteron, Forcalquier, Castellane. From a judicial point of view the parlement of Aix had replaced the former *conseil eminent* or *cour souveraine*. There was a *chambre des comptes* at Aix, and also a *cour des aides*. A decree, dated the 22nd of December 1789, divided Provence into the three departments of Bouche du Rhône, Basses-Alpes and Var, and in 1793 Vaucluse, the former county (*comtal*) of Venaissin, which belonged to the pope, was added to these. The boundaries of the department of Var were modified in 1860 after the annexation, when the department of the Alpes Maritimes was formed.

AUTHORITIES.—There is no good general history of Provence. For a complete work consult the ancient works of H. Bouche, *Chorographie et histoire chronologique de Provence* (2 vols. in fol., Aix, 1664); Papon, *Histoire générale de Provence* (4 vols. in 4to, Paris, 1777–1786); L. Méry, *Histoire de Provence* (3 vols. in 8vo, Marseilles, 1830–1837). For special periods of history see F. Kiener, *Verfassungsgeschichte der Provence, 510–1200* (8vo, Leipzig, 1900); R. Poupardin, *Le Royaume de Provence sous les Carolingiens* (in 8vo, Paris, 1901); G. de Manteyer, *La Provence du 4^e à xii^e siècle* (in 8vo, Paris, 1907); Lambert, *Essai sur le régime municipal et l'affranchissement des communes en Provence* (in 8vo, Toulon, 1882); *Les Guerres religieuses en Provence* (2 vols. in 8vo, 1870); Cabasson, *Essai historique sur le parlement de Provence* (3 vols. in 8vo, Aix, 1826). (R. Po.)

PROVERB (Lat. *proverbium*, from *pro*, forth, publicly, *verbum*, word; the Greek equivalent is *παροιμία*, from *παρά*, alongside, and *ὄμιλος*, way, road, *i.e.* a wayside saying; Ger. *Spruchwort*), a form of folk-literature, or its later imitation, expressing, in the form of a simple, homely sentence, a pungent criticism of life. Many definitions have been attempted of a "proverb," of which none has met with universal acceptance. J. Howell's (d. 1666) three essentials, "shortness, sense and salt," omit the chief characteristic, popularity or general acceptance, and the definition of Erasmus—*Celebre dictum scita quapiam novitate insignit*—suits a good proverb rather than proverbs in general. Lord Russell's "The wisdom of many and the wit of one" is familiar.

For a general survey of the subject of proverbs, Archbishop Trench's *Proverbs and their Lessons* (new ed., 1905, by A. Smythe-Palmer, with additions and notes) is useful; it contains a fairly comprehensive bibliography, ancient and modern. Bohn's *Handbook of Proverbs*, and *Polyglot of Foreign Proverbs* (1857), based on

the collections of John Ray (1670) and David Ferguson (1641), are very full. V. Stuckey Lean's *Collectanea* (5 vols.) 1902 is a storehouse of English proverbs, classified in various ways; *Notes and Queries*, 9th series (1898), vol. ii., contains a bibliography of English works. The principal foreign works are G. Strafforello, *La Sapienza del mondo* (3 vols., 1883) and Reinsberg and Düringsfeld, *Die Sprichwörter der germanischen und romanischen Sprachen* (2 vols., 1872–1875). There are many popular handbooks giving full collections of proverbs, English and foreign.

PROVERBS, BOOK OF (Heb. *Mishlê Shelomoh*, "Proverbs of Solomon," abridged by the later Jews to *Mishlê*; Septuagint, *παροιμιαί* or *II. Σαλ.*; Lat. Vulg. *Parabolæ sal.* and *Liber proverbiorum*), one of the Wisdom books of the Old Testament (see WISDOM LITERATURE) and the principal representative in the Old Testament of gnomic thought. This sort of thought, which appears very early in Egypt (2000 B.C. or earlier), and relatively early among the Greeks (in the sayings of Thales and Solon as reported by Diogenes Laertius), was of late growth among the Hebrews. Doubtless they, like other peoples, had their simple proverbs, embodying their general observations of life; a couple of these have been preserved in the Old Testament: "Is Saul also among the Prophets?" (1 Sam. x. 12); "The fathers eat sour grapes, and the children's teeth are set on edge" (Jer. xxxi. 29; Ezek. xviii. 2). It is possible that Solomon uttered or collected a number of such sayings, based in part on observation of the habits of beasts and plants (1 Kings iv. 32 seq. [Heb. v. 12 seq.]; cf. Jotham's apologue, Judg. ix. 8 sqq., and Samson's riddle, Judg. xiv. 14). The Hebrew word *masal*, commonly rendered "proverb," is a general term for didactic and elegiac poetry (as distinguished from the descriptive and the liturgical), its form being that of the couplet with parallelism of clauses; in the Old Testament it signifies a folk-saying (Ezek. xii. 22, xviii. 2), an allegory (Ezek. xvii. 2), an enigmatical saying (Ezek. xxi. 5), a byword (Jer. xxiv. 9; Deut. xxviii. 37), a taunting speech (Isa. xiv. 4; Hab. ii. 6), a lament (Mic. ii. 4), a visional or apocalyptic discourse (Num. xxiii. 7; xxiv. 15), a didactic discourse (Ps. xlix., lxxviii.), an argument or plea (Job xxix. 1). In the book of Proverbs it is either an aphorism (x.–xxii.) or a discourse (i.–ix., xxiii. 29–35, xxvii. 32–27).

The uses of the term being so various, its special signification in any case must be determined by the character of the passage in which it occurs; and an examination of the contents of Proverbs shows that the thought of the book differs widely from that of the literature prior to the 5th century B.C. The book appears on its face to be a compilation, various authors being mentioned in the titles: Solomon in x. 1 and xxv. 1; the "sages" in xxii. 17 and xxiv. 23; Agur in xxx. 2; the mother of King Lemuel in xxxi. 2; xxxi. 10–31 and, probably, xxx. 5–33 are anonymous; the ascription in i. 1 to Solomon may refer to i.–ix or to the whole book. Apart from the titles (which are not authoritative) the difference of style in the various sections indicates difference of authorship. There is, indeed, a certain unity of thought in the book; throughout it inculcates cardinal social virtues, such as industry, thrift, discretion, truthfulness, honesty, chastity, and in general it assumes wisdom to be the guiding principle of life. But the sections differ in form and tone. While chs. x.–xxix. and part of xxx. consist of aphorisms chs. i.–ix., xxxi. are composed of more or less elaborate discourses. In the aphoristic sections also there is variety; there are couplets (x. i.–xxii. 16; xxv.–xxxix.), quatrains (xxii.–xxiv.) and tetrads and other numerical arrangements (xxx. 7–33). Compilatory character is indicated by repetitions; there are identical lines (x. 1 and xxix. 3; xi. 14 and xxiv. 6; xiii. 9 and xxiv. 20; xiv. 1 and xxiv. 3; xv. 18 and xxix. 22; xvii. 3 and xxvii. 21; xix. 13 and xxvii. 15; xx. 22 and xxiv. 29; xxiv. 23 and xxviii. 21) and identical couplets (xviii. 8 and xxvi. 22; xix. 1 and xxvii. 6; xix. 24 and xxvi. 15; xx. 16 and xxvii. 13; xxi. 9 and xxv. 34; xxii. 3 and xxvii. 12).

The dates of the various parts of the book must be determined by the character of the contents, there being no decisive external data. The fact that it stands in the third division of the Hebrew Canon, the Writings or Hagiographa, along with such late works as Job, Psalms, Chronicles, Daniel, Ecclesiastes and

¹ The *viguerie* was the jurisdiction of a *viguiet*, *i.e.* "vicar," a name given at various times and places in the south of France to very different feudal-officials. The *viguerie* in the 17th and 18th centuries as an administrative subdivision in Provence corresponded to the *prévôté* elsewhere.

Esther, must be allowed weight; the presumption is that the arrangers of the Canonical books regarded it as being in general later than the Prophetical books. No help can be got from the titles. Examination of titles in the Prophets and the Psalms (to say nothing of Ecclesiastes and Wisdom of Solomon) makes it evident that these have been added by late editors who were governed by vague traditions or fanciful associations or caprice, and there is no reason to suppose the titles in Proverbs to be exceptions to the general rule. The ascription of parts of Proverbs to Solomon (i. 1, x. 1, xxv. 1) means nothing for us except that there was a disposition among the later Jews to refer their books to great names of the past, Enoch, Daniel, Job, Moses, David, Solomon, Ezra; as also, outside of Jewry, works were ascribed to Homer, Plato, Aristotle, Tacitus and others that were not composed by these authors. The supposition of a Solomonic authorship for Proverbs is excluded by the whole colouring of the book, in which monotheism and monogamy are assumed, without discussion, to be generally accepted, while in Solomon's time and by Solomon's self the worship of many gods and the taking of more than one wife were freely practised, without rebuke from priest or prophet. The high ethical conception of the kingly office in Proverbs is out of keeping with the despotic character of Solomon's government. It is supposed, indeed, by some modern writers that the notice in xxv. 1 ("These are proverbs of Solomon, that the men of Hezekiah king of Judah transcribed") is too circumstantial to be merely a late tradition or scribal guess. But similarly definite titles are prefixed elsewhere, for example, to Ps. li.-lx., where they cannot possibly be correct. Hezekiah's time may have been selected by the author of the title (or by the tradition which he represents) as being the next great literary period in Judah after Solomon, the time of Micah and Isaiah, or the selection may have been suggested by the military glory of the period (the repulse of the Assyrian army) and by the fame of Hezekiah as a pious monarch and a vigorous reformer of the national religion. But to regard Hezekiah as a Jewish Pisistratus is to ascribe to the time a literary spirit of which the extant documents give no hint; the literature of the age was wholly occupied with the past history, the religious conditions and the political fortunes of the nation, subjects alien to the book of Proverbs.

The objections to the Solomonic age as the time of origination of the book apply also to the period extending from Solomon through the 6th century. But there are considerations that lead us to put its origin still later. One of these is the non-national character of the thought. The historical and prophetic books and the Pentateuch are wholly concerned with the nation. For them Israel is the centre of the world, the point around which all other things revolve—every other people derives its claim to consideration from its relation to Israel—the only subject deserving attention is the extent of the Jewish nation's obedience or disobedience to its divinely given law, on which depends its prosperity or its adversity. In Proverbs there is a notable absence of this point of view. The name Israel and the terms temple, prophet, priest, covenant, do not occur in the book. The "vision" (that is, prophetic vision) in the Hebrew text of xxix. 18 ("Where there is no vision, people throw off restraint") is an error of text. No writer who was acquainted with Hebrew history could suppose that there was any relation between the national morality and the abundance of prophetic visions; the period in which such visions were most numerous is precisely that in which the corruption of morals is painted by the prophets in the darkest colours and, on the other hand, the people are said (in Pss. xlv. and lxxiv.) to have been obedient at a time when there was no prophet. Moreover, this reading supplies no antithesis in the couplet, the second line of which is: "But he who obeys instruction (or law), happy is he"; we should expect the first line to read: "Where there is no guidance people throw off restraint," as in xi. 14: "Where there is no guidance, a people falls, but in the multitude of counsellors there is safety." Prophets play so great a part in the early history that the ignoring of them here is significant. The decadence of prophecy is indicated in two passages that belong

probably to the Greek period: in Zech. xiii. 2 sqq. prophecy is identified with the "unclean spirit," the pretender to visions is threatened with death by his parents, and, so great is the general contempt for the class, protests that he is no prophet but a tiller of the ground, accounting for the wounds on his person (such as these charlatans used to inflict on themselves) by declaring that they were received in the house of his friends (that is, apparently, in a drunken quarrel); from a very different point of view Joel ii. 28 seq. (Heb. iii. 1 seq.) predicts that in the latter times (in the ideal restoration of the people) all persons, free and bond, male and female, shall have the spirit of prophecy—that is, the old order shall be set aside and a new religious constitution established. Proverbs belongs to the time when prophecy, as a helpful institution, had disappeared, and wisdom had taken its place. So also the term law had here taken on a new meaning. It is no longer the law of Moses or that of the prophetic revelation—it is the standard of rightdoing resident in every man's mind, the creation of wise reflection; such a conception lies outside the point of view that forms the very substance of Hebrew thought in the period prior to the 5th century. It is true that the nationalistic tinge is found in late writings (Chronicles, Psalms), and that its absence, therefore, is not merely a matter of date; but it is hardly conceivable that an author of any time before the 5th century could have ignored the nationalistic point of view so completely as Proverbs does.

Another noteworthy feature of the book is the picture it gives of social life. The organization of the family is treated much more fully than in the Law and the Prophets, and has a more modern aspect. In Deut. xxi. 18 sqq. (of the 7th century) a disobedient son, complained of by his parents, is to be stoned to death by the men of the city; in Proverbs (xiii. 24, xxii. 15, xxxiii. 13 seq., xxix. 15, 17) a bad child is to be chastised, and much is said of the training of children by instruction. The impression made by a number of passages (i. 8, xxiii. 22 *al.*) is that a regular system of family education existed, more definitely ethical than that indicated in Deut. vi. 7, which merely enjoins teaching children the details of the national law. In addition to this parental instruction we find hints of a sort of academic training, particularly in chs. i.-ix., in which the sage appears to address a circle of youths. If we may credit the Talmudic tract *Pirke Aboth* (ch. i.), Jewish academies under the charge of great teachers existed early in the 2nd century B.C., and the beginnings of such institutions may go back a century; they would probably be suggested by the Greek schools of philosophy, which early sprang up in Western Asia and Egypt under Alexander's successors.

Monogamy, as is remarked above, is assumed in Proverbs to be the recognized custom. Polygamy was legal and usual in the 7th century (Deut. xxi. 15) and the 6th (Lev. xviii. 17, 18), and doubtless continued to be practised some time after by the Jews, though on this point we have no definite information; Herod, who was a despot, and was not a Jew, cannot be taken as an illustration of Jewish custom; the obscure passage, Mal. ii. 10 sqq. (450-400 B.C.) may have monogamy in mind, but its position on this point is not clear. What is certain is that the definite assumption of monogamy is found only in such late books as Ben-Sira (Ecclesiasticus), Tobit and Judith. In regard to punishment for the violation of a husband's rights Proverbs shows a marked advance on the old usage. The Pentateuchal law (Lev. xx. 10) prescribes death as the punishment for adultery; Proverbs (v., vi. 27 sqq., vii.) treats the offence as a sin against the offender himself, an act of suicidal folly, the punishment coming sometimes from the jealous husband, but chiefly in the way of the physical deprivation and social ignominy that befall the adulterer. This change of punishment imports not a falling off in the moral standard but rather the conviction that a crime of this sort is best dealt with by public opinion; in any case it means a change in the constitution of society.

The experiences described in Proverbs belong especially to city life. Something is said here and there bearing on agricultural pursuits, and there is a paragraph (xxvii. 23 sqq.)—a little treatise it may be called—enjoining on the landowner the

necessity of paying special attention to his cattle, large and small; these, says the writer, are the real sources of wealth to the rural landowner. Possibly he means to insist on the advantages of country life over life in the city; if this be so, the paragraph bears witness to the prominence of the latter. Whether or not this is his design, advice to cattle-owners is natural in a manual of conduct. The Jews were mainly country-folk from the time of their settlement in Canaan to their final expulsion from the land by Titus and Hadrian, and the soil of Israelitish Palestine was better adapted to the raising of sheep and oxen than to the production of grain. Doubtless much attention was paid to this industry, but the composition of a little book on the subject, indicating a scientific interest in bovine culture, points to a comparatively late period; the Greek and Roman works of this sort, by Aristotle, Theophrastus, Virgil and others, were late. This little treatise stands almost alone in Proverbs; the great mass of its aphorisms relate to vices and faults which, though possible in any tolerably well-organized community, were specially prominent in the cities in which the Jews dwelt after the conquests of Alexander. They are malicious gossip, greed of money, giving security, nocturnal robbery, murder, unchastity. Much space is given to the last-named vice throughout the book, and especially in chs. i. and ix.—obviously it is regarded as a notorious social evil. Comparatively little is said of it in the Pentateuch and the prophetic and historical books. That there were harlots and adulteresses in Israel from an early time is shown by such passages as Judg. xi. 1 (Jepthah's mother), 1 Kings iii. 16 (the judgment of Solomon), Hos. iii. 1 (Hosea's wife), by the denunciations of the crime and the laws against it, and by the employment of the terms harlotry and adultery as designations of religious unfaithfulness. Yet, apart from the references to cultic prostitution (which was adopted by the Israelites from the Canaanites), the mention of the vice in question is not frequent; in a polygamous society and in a country without great cities it was not likely to grow to great proportions. The case was different when the Jews were dispersed through the new Greek kingdoms, and lived in cities like Jerusalem and Alexandria, centres of wealth and luxury, inhabited by mixed populations; this form of debauchery then became commoner and better organized. Hetairae flocked to the cities. Naukratis in the Egyptian Delta was famous under the Ptolemies for its brilliant venal women. The temptations of Alexandria and the loose morals of the time (latter part of the 3rd century) are illustrated by the story told by Josephus (*Ant.* xii. 4, 6) of Joseph the son of Tobias. The picture of society given in *Bcn-Sira* (ix. 3-9, xix. 2, xxiii. 16-26, xxv. 16-26, xxvi. 8-12, xlii. 9-14), based on life in Jerusalem and Alexandria in the 2nd and 3rd centuries B.C. agrees in substance with the descriptions of the Book of Proverbs. The tone of these descriptions throughout the book, but particularly in chs. i.-ix., is modern. A point of interest is that the exhortations to chastity are addressed to men only; the man is regarded as the victim, the woman as the temptress—women are never warned against men or against the general seductions of society. This silence may be due in part to a current opinion that women were more hedged in and guarded by social arrangements and less exposed to temptation than men; but it is chiefly the result of the fact that the Old Testament (like most ancient and modern works on practical ethics) addresses itself almost exclusively to men (certain classes of women are denounced in Amos iv. 1-3; Isa. iii. 16-iv. 1; Ezek. xiii. 17-23); the moral independence of women is not distinctly recognized. In this regard Ecclesiasticus agrees with Proverbs—it has no word of advice for women. The temptress in Proverbs appears to be a married woman; she is certainly such in chs. vi. and vii., and probably also throughout the book. The term "strange woman" (ii. 16 *al.*) means not a foreigner, but one who is alien to the man's family circle, the wife of another man. Such women may sometimes have been foreigners, but the sage's concern is with the man's violation of the marriage obligation, be the woman Jew or Gentile. In the earlier time marriages between Jewish men and Canaanite women seem to have been not uncommon; whether (outside of Herod's family)

there were marriages with foreigners in the Greek period we have no means of determining.

Proverbs is remarkable for the attention it gives to kings. The prophets have nothing to say of them as a class. One passage in the Pentateuch (Deut. xvii. 15-20) prescribes that the Israelite king shall be the opposite of Solomon—he shall not accumulate horses, wives, silver and gold, and shall study the law. In the Psalter he is considered merely as a servant of Yahweh. Proverbs treats the king, in a quite modern way, as a member of society. He is described ideally as ruling by the might of wisdom (viii. 15, 16), and as controlled in his administration by truth, kindness and justice (xx. 8, 26, 28)—the wicked ruler who oppresses the poor is condemned as not reaching the ideal standard (xxviii. 3, 5, 16). Three manuals of conduct are devoted to him (xvi. 10-15, xxv. 2-7, xxxi. 2-9). His power is recognized—he is the source of life and death (xvi. 14, 15)—but he is treated as a human being who must be governed by the ordinary laws of right. It is especially illustrative of the times that instruction in table manners is offered to the guests of kings—they must be modest in their bearing, not putting themselves forward (xxv. 6, 7; cf. Luke xiv. 8, 11), and they must control their appetites (xxiii. 1, 2). The reference here must be to the numerous non-Jewish kings of the Greek period, and perhaps also to the Maccabean princes; the manners of the time are set forth in Josephus's account of Ptolemy's dinner, at which the Jew Hyrcanus was a guest (*Ant.* xii. 4, 9). The mingling of despotism and good-natured familiarity there described (and the spirit is doubtless correctly given by Josephus, whether or not his details are historical) agrees with the picture in Proverbs.

Finally, a late date for Proverbs is indicated by what may be called its philosophical element—a feature that it has in common with the other Wisdom books (see WISDOM LITERATURE). This element is recognizable throughout the book, but is most distinct in chs. i.-ix., in which wisdom is personified as the power regulating the affairs of human life (iii. 13-18, viii. 1-21). The portraiture approaches hypostatization in the cosmogonic ode (viii. 22-31), especially if the first line of v. 30 be rendered: "I was at his side as a master-workman"; but the Hebrew word (*amon*) rendered "master-workman" is of doubtful meaning, and the connexion rather calls for some such sense as "nursling, ward"; Yahweh himself is represented as the architect, and wisdom, the first of his works, is his companion, sporting in his presence like a beloved child. The whole passage (v. 22-31) was early employed by Christian theologians (Irenaeus, Athanasius, Augustine and others) in the controversies respecting the nature of the Second Person of the Trinity, particularly in connexion with the idea of eternal generation; the argument turned in part on the question whether the verb in v. 22 was to be translated by "created" or by "possessed." Ecclesiasticus xxiv. and Wisdom of Solomon vii. should be compared with the Proverbs ode. In the remainder of the book (chs. x.-xxx.) "wisdom" is sometimes common sense or sagacity, sometimes the reflective habit of mind and largeness of outlook, sometimes the recognition of the ideal standard of living. Contrasted with the wise are fools, and on these the sages vent their scorn abundantly (xii. 15, 16, xvii. 12, xviii. 6, 7, xxiii. 9 *al.*); xxvi. 1, 3-12 is a "book of fools." The conception of the good life is that of philosophically ordered rectitude. The religious element is prominent in x. 1-xxiii. 16, but it is blended with the reflective. The philosophy of the book is practical, not speculative.

Comparison of Proverbs with Ecclesiasticus, Ecclesiastes and Wisdom of Solomon shows that it belongs, in its main features, in the same category as these. Its thought, differing so widely from that of the prophets and the Pentateuch, is most naturally referred to the period when the Jews came into intimate intellectual contact with the non-Semitic world, and particularly with the Greeks (philosophical influence is not to be looked for from Persia).

While the general period in which the book belongs may thus be determined with fair probability, it is less easy to fix the dates of its several parts. The earliest of the groups of which the book

is composed seems to be x. 1-xxii. 16, xxv.-xxix. which consists of simple aphorisms relating to everyday affairs. This group, however, is itself composite; we may distinguish a collection of antithetic couplets (x.-xv. and most of xxviii., xxix.), and one made up of comparisons and single sentences (xvi. 1-xxii. 16, xxv.-xxvii., and some verses in xxviii., xxix.). Of these two the first, on account of its simpler form, appears to be the earlier, though they cannot stand far apart in time; and by combining them an editor formed the section as we now have it. These may have been severally made from current collections, a number of which were probably in existence. A general preface exhorting the pupil to give heed to the instruction of the sages (xxii. 17-21), introduces a group of quatrains in two sub-groups (xxii. 22-xxiv. 22 and xxiv. 23-34) characterized by a wide range of thought and by ethical depth. Probably later than these are the elaborate discourses of i.-ix. (excluding vi. 1-5, 6-11, 12-19 and ix. 7-12, misplaced paragraphs) containing praise of ideal wisdom and warnings against unchastity. Chs. xxx., xxxi., made up of various pieces, form a sort of appendix to the book; some of the pieces are artificial in form (xxx. 11-31), one is a full picture of a good housewife's home life (xxx. 10-31), two are ascribed to the unknown persons Agur (xxx. 2-4) and King Lemuel's mother (xxx. 2-9). Agur's dictum is one of pious agnosticism directed, apparently, against certain theologians who talked as if they were well acquainted with the ways of God. Agur's word, breathing the spirit of scepticism, falls into the category represented by Ecclesiastes, and we may probably set the year 200 (or possibly 150) B.C. as the lower limit of the Book of Proverbs; allowing a century for the collection and combination of the various parts, we shall have the year 300 B.C. as the date of its earliest section. Some of the material may have existed in aphoristic form before, but the composition of the present book may be put approximately in the century 300-200 B.C. Even its simplest maxims have a certain academic form.

In its general ethical code Proverbs represents the best standard of the times; the sages are at one with the more enlightened moralists of the Western world. All the ordinary social virtues such as truthfulness, honesty, kindness, chastity are emphasized and a great stress is laid on care for the poor (a social necessity at a time when there were no well organized public charities). But Proverbs seems not to go the length of identifying righteousness with almsgiving, as is done in Dan. iv. 27 (24), Matt. v. 1, and substantially in Ecclus. iii. 30, xxix. 12 and Tobit iv. 10, xii. 9; in x. 2, "righteousness delivers from death," the word "righteousness" is probably to be taken in its ordinary ethical sense. The above-named virtues are all recognized in the earlier Hebrew writings, the prophets and the law, but in certain points Proverbs goes beyond these, notably in its prohibition of exultation over a fallen enemy (xxiv. 17) and of retaliation for injury received (xxiv. 29), and in its inculcation of kindness to enemies (xxv. 21). The injunction in Lev. xix. 18, "Thou shalt love thy neighbour as thyself," refers only to Israelite fellow-citizens, not to enemies (cf. the interpretation given in Matt. v. 43), and the command in Exod. xxiii. 4 seq., to care for one's enemy's ox or ass likewise refers to Israelites; Proverbs conceives the principle in a higher way and extends it beyond the limits of the nation. Slavery is recognized as a lawful institution, but little is said of it. There is no suggestion of moral training of the slave; he is to be taught not by words (xxix. 19) but by the rod, like the child (v. 15), and it is intimated (v. 21) that it is a mistake to bring up a servant delicately. This was doubtless the general view of the time; Ben-Sira frankly regards the servant as a chattel (Ecclus. xxxiii. 24-31). Proverbs greatly disapproves of the elevation of slaves to the position of rulers (xix. 10)—an occurrence not uncommon in those days. The estimate of woman as wife and mother, and especially as housewife, is high (xviii. 22, xix. 14, xxxi. 10-31). In vi. 20 the mother is spoken of, along with the father, as teacher of the children, and it is assumed, therefore, that she is competent; but nothing is said of the education of women—in xxxi. 26 the "wisdom" of the good wife (not "virtuous

woman") is good sense, practical sagacity in housekeeping. The equality of all men as creatures of God, silently assumed in the earlier literature, is definitely expressed in Proverbs (xxii. 2, cf. Job xxxiv. 19, Ecclus. xi. 14). Humility, as the opposite of insolent pride, is recognized as a virtue (xviii. 12, cf. xvi. 18)—it is a modest estimate of one's worth, refusal to claim too great honour for one's self. In general it is the simple homely virtues that are enjoined on men in Proverbs—there is no mention of courage, fortitude, intellectual truthfulness, and no recognition of beauty as an element of life; the ethical type is Semitic, not Hellenic, and the sages emphasize only those qualities that seemed to them to be most effective in the struggle of life; their insistence on the practical, not the heroic, side of character is perhaps in part the consequence of the position of the Jewish people at that time, as also the silence respecting international ethics belongs to the thought of the times. The ground of moral judgments in the book is both external (the law of God) and internal (the conscience of man); these two are fused into one, and both go back ultimately to current customs and ideas. The motive assigned for right doing is individualistic utilitarian—the advantage accruing to the man either through the laws of society or through the rewards dispensed by God. This motive, which is the one assumed throughout the Old Testament, is effective for the mass of men, and becomes ethically high when the advantage had in view is of an elevated moral character. Proverbs does not offer the good of society as an aim of action, though it takes for granted that good conduct will promote the happiness of all. Assuming human freedom it at the same time assumes that the ills of life may be overcome by a wise employment of man's resources, and it silently regards universal happiness on earth as the goal of human development.

Its religious scheme is the simplest form of theism; religion is reverence for God and obedience to His laws. Though the sages doubtless recognized the temple-cult as of divine appointment and obligatory, they lay no stress upon it; for them the essence of religion is something else; right living, they say (xxi. 3), is more acceptable to God than sacrifice, and sacrifice without ethical feeling is abominable to Him (xv. 8). Subordinate supernatural beings (angels and demons), though of course accepted as real, are ignored as having no importance for life. There is no reference or allusion to national Messianic hopes (certainly none in xvi. 10-15); neither the political situation in the 3rd century B.C., nor the sages' point of view was friendly to such hopes. The view of the future life is the old Hebrew one: death is practically the end-all, Sheol is the negation of happy activity, and from it no one returns; in v. 23, vii. 27, ix. 18, x. 2, the reference is to premature death on earth. The aim of the sages is to make earthly life strong and happy. They lay no claim to divine inspiration—they speak simply as ordinary human thinkers, though they are convinced that they have eternal truth.

The reception of Proverbs into the Hebrew Canon was for a time opposed on the ground of a supposed contradiction between two aphorisms (xxvi. 4, 5), and (vii. 7, 20) of too highly coloured descriptions (*Shabbath*, 30b, *Aboth Nathan*, cap. i.); these difficulties were got over, and the book was finally declared canonical. It is quoted over twenty times in the New Testament, and has always been highly valued as a manual of conduct.

Of the ancient versions the Septuagint is the only one that is of great service for the criticism of the Hebrew text of Proverbs. The Latin, the Peshitta Syriac and the Targum occasionally offer suggestions; the Hexaplar Syriac and the Coptic are of value for the determination of the text of the Septuagint.

BIBLIOGRAPHY.—The Hebrew text is discussed in all recent commentaries; see also Dyserinch, in *Theol. Tijdschrift* (1883); Oort, *ibid.* (1885), and *Text. hebr. emendationes* (1900); Bickell, in *Wiener Zeitschr. f. d. Kunde d. Morgenlandes* (1891); Chajes, *Proverb-Studien* (1889); Müller and Kautzsch, in *Haupt's Sacred Books of the Old Test.* (1901). The Greek versions are treated by de Lagarde, *Anmerkungen* (1863); Baumgartner, *Étude critique* (1890). For the Syriac see Pinkuss in *Zeitschr. f. Alltest. Wissenschaft* (1894). Compare also Nestle's article "Bibelübersetzungen" in the third edition

of Herzog-Hauck's *Realencyklopädie*. Among commentators and translators may be mentioned: Ewald (1837, 1867); Noyes (1836); Stuart (1852); Hitzig (1858); Zöckler, in Lange's *Bibelwerk* (1866, Eng. trans., 1870); Delitzsch (1873, Eng. trans., 1875); Reuss, in *La Bible* (1878, Germ. ed., 1894); Nowack (revision of Bertheau) in *Kurzgefasst exeg. Handbuch* z. A. T. (1883); Strack in *Strack u. Zöckler's kurzgef. Comm.* z. A. T. (1888, 2nd ed., 1899); Horton, in *Expositor's Bible* (1891); Wildeboer, in Marti's *Kurz. Hand-Comm.* z. A. T. (1897); Frankenberg, in Nowack's *Handkomm.* z. A. T. (1898); Toy, in *Internat. crit. Comm.* (1898); Kautzsch, *Die heil. Schrift. d. A. T.* (2nd ed., 1896); Oort, *Het Oude Test.* (1898-1900). See also Bois, *La Poésie gnominique chez 1. Heb. &c.* (1886); Cheyne, *Job and Solomon* (1887); id., in *Sem. Studies* (ed. Kohut, 1897); id., *Jew. Relig. Life* (1898); Montefiore in *Jew. Quart. Review* (1889-1890). On Proverbs of Other Ancient Peoples: Egyptian—Griffith, art. "Egypt Lit." in *Libr. of World's Best Lit.* (1897), vol. xiii.; Assyrian: Halévy, *Mélanges* (1883); Jäger, in *Beitr. z. Assyriologie* (1892); Hindu: Monier-Williams, *Indian Wisdom* (1875); Arabic: Jacob, *Alt arab. Parallelen* z. A. T. (1897); Fleischer's ed. of *Ali* (1837); Freytag, *Arabum proverbia* (1838). A general collection has been made by Malan, *Orig. Notes on the Book of Proverbs* (1889; 1893). (C. H. T.*)

PROVIDENCE, the second largest city of New England, capital of Rhode Island, U.S.A., the county-seat of Providence county, and a port of entry, situated at the head of Providence river (the N. arm of Narragansett Bay) and at the influx of the Seekonk (or Blackstone), Moshassuck and Woonasquatucket rivers, about 35 m. from the Atlantic ocean, 45 m. by rail S.S.W. of Boston, and 188 m. E.N.E. of New York. Pop. (1890), 132,146; (1900), 175,597; (1905, state census), 198,635, of whom 65,746 were foreign-born, including 17,155 Irish, 12,114 Italians, 9795 English, 4221 English Canadians, 4005 French Canadians, 3685 Russians, 3347 Swedes, 2211 Germans, 2173 Portuguese (including some Bravas from the Cape Verde Islands), and 1930 Scotsmen. The figure for 1910 was 224,326. Providence is served by the New York, New Haven & Hartford railway and by steamboat lines to Newport, New York, Philadelphia, Baltimore and Norfolk. It extends over an area of more than 18 sq. m., and is irregularly laid out. The Seekonk and Providence rivers mark the eastern boundary, the Providence and Moshassuck rivers divide the middle and northern portion of the city into the east and west sides, and the Woonasquatucket river divides the west side into the northern and southern parts. The west side is a level or gently rolling plain only a few feet above the sea, but on the eastern side are a plateau and hills rising to a maximum height of about 200 ft. The larger and newer portion of the business district is along the western bank of the Providence, and some of the best business houses are on made land. The part of the city which has most historic interest is on the east side, where are the most attractive residences. Most of the manufactories are along the banks of the Woonasquatucket and Moshassuck. The names of streets—Pound, Sovereign, Shilling, Dollar, Doubloon, Benevolent, Benefit, Hope, Friendship, Peace, &c., reflect the early commercial importance of the city and its strong Quaker element.

The principal building is the large State House, completed in 1902, of Georgia marble and white granite, surmounted by a central dome of marble, 235 ft. high, and standing on a rise of ground (Capitol Hill) about $\frac{1}{2}$ m. north by west of the steamboat landing at the head of Providence river; in the state chamber is a full length portrait of George Washington by Gilbert Stuart. The old State House on Benefit Street, on the east side, is now used as the 6th district (Providence and North Providence) court-house. Near the centre of the city (in Exchange Place) is the city-hall (1878), a handsome structure of granite; on its façade is a medallion of Roger Williams. Across Exchange Place from the city-hall is the Federal Building (1908), which houses the post-office, custom-house, U.S. courts, &c. The county court-house (1877) is the only other prominent government building. The Arcade (1828), 225 ft. long, with six massive Ionic columns at each entrance, the Butler Exchange, and a few other fine buildings fronting on Westminster Street are among the more prominent business buildings. In Cranston Street, between Waterloo and Dexter, is an Armory, with the largest hall in New England. A handsome public library building, opened in 1900, lying between Fountain, Greene and Washington

Streets, houses a good collection of 140,000 vols. (in 1909); other libraries are the State Library (30,000 volumes), the State Law Library (50,000 volumes) in the Providence county court-house, the Providence Athenaeum (the Providence Library, established in 1753, united in 1836 with the Providence Athenaeum, established in 1831; in 1909 it had 73,000 volumes), the library of the Rhode Island Historical Society (established 1822; with 30,000 volumes and 50,000 pamphlets in 1909), and the libraries of Brown University. The meeting-house of the First Baptist Church, founded by Roger Williams, the oldest organization of this sect in the United States, was built in 1775 and was designed to resemble St Martin's-in-the-Fields, London. Its bell still rings the curfew at nine o'clock every evening; and the commencements of Brown University are held here. The Friends' meeting-house, another interesting old building, was erected in 1759. The Beneficent Church (Congregational, 1809-1810) is in the Colonial style, with a rounded dome. The Church of the Blessed Sacrament (Roman Catholic), in Academy Street, was designed by John La Farge. The Roman Catholic Cathedral of SS. Peter and Paul (1878) is of brown stone and has excellent interior decorations. Providence is the see of a Protestant Episcopal bishop. In Cathedral Square is a statue (1889) by Henry Hudson Kitson of Thomas A. Doyle, mayor of the city (1864-1869, 1870-1881, and from 1884 until his death in 1886). There is an equestrian statue (1887) by Launt Thompson of General A. E. Burnside in City Hall Park. In front of the post-office are two allegorical groups ("Providence" and "the United States") by J. Massey Rhind. In Columbus Park is a replica of Bartholdi's "Columbus," which was cast in silver by Providence metal workers for the Columbian Exposition in Chicago. Other statues are Hippolyte Hubert's Ebenezer Knight Dexter (erected 1894), George Thomas Brewster's bronze "Genius of Religious Liberty" on the dome of the State House, Franklin Simmons's Roger Williams (1877) in Roger Williams Park, a Hellenic bronze "Pancreatiast" (1900, presented to the city by Paul Bajnotti of Turin) also in Roger Williams Park, and a Hellenistic statue of Augustus on the campus of Brown University. Two fountains also are worth mention: the Bajnotti Memorial Fountain in City Hall Park, a memorial to the wife of Paul Bajnotti, representing "The Struggle of Life" and designed by Enid Yandell; and the Elisha Dyer Memorial Fountain, a bronze athlete, by H. H. Kitson. There are art collections in Brown University and in the Annmary Brown Memorial (given to the city as a memorial to his wife, a daughter of Nicholas Brown, by Rush C. Hawkins, b. 1831). Among interesting old houses of the 18th century are the Admiral Hopkins House, in Hopkins Park, the Stephen Hopkins House (1742; 9 Hopkins St.), the John Carter Brown House (1791; 357 Benefit St.), and the John Brown House (1786; 52 Power St.). There are many colonial houses, red brick with marble trimmings, set well back from the street, with an occasional walled garden. There are many musical societies in Providence, including the Chopin Club (1879), the Arion Club (1880); the Einklang Singing Society (1890; German), the Verdandi Swedish Singing Society (1894), and the Providence Musical Association (1904). Other clubs are the Brown Union, University Club, a cricket and a polo club, golf clubs, yacht clubs and canoe clubs, the Handicraft Club, the Providence Art Club, the Hope Club and the Deutsche Gesellschaft.

Under the municipal park commissioners there are 33 public parks with a total area of 644.38 acres, and the city supports summer playgrounds; the state board of metropolitan park commissioners controls a large park system in the metropolitan park district, and a system of boulevards, connecting the several parks and other public reservations; there are nine metropolitan reservations, containing 677 acres, the largest being Lincoln Woods, of 460 acres, 4 m. north of the State House. Other metropolitan reservations are: Woonasquatucket Reservation (53 acres; $2\frac{1}{2}$ m. west of the State House); Edgewood Beach ($2\frac{1}{2}$ m. south of the State House); and the Ten Mile River Reservation (100 acres; $4\frac{3}{4}$ m. north-east of the State House) on both sides of Ten Mile River. The finest municipal reservation is Roger

Williams Park (432 acres, of which 140 are water), with 9 m. of drives and boulevards, in the southern part of the city, 2½ m. from the State House. It was a part of the original tract ceded to Roger Williams by Miantonomo; 107 acres were a farm which Betsy Williams (d. 1871), a lineal descendant of Roger Williams, left to the city by will. In the park are a chain of lakes with a shore front of 7½ m., a boat-house, a casino, a speedway and athletic grounds, a municipal natural history museum, and the Betsy Williams Cottage (1775). Other municipal parks are: Neutaconkanut (40½ acres; 2½ m. west of the State House) on high land commanding a view to the east and south; Davis Park (38½ acres) with amusement grounds; Blackstone Park (43 acres, 1½ m. east of the State House) along the Seekonk river; Hopkins Park (¾ m. north of the State House), comprising the estate of Esek Hopkins (1718-1802), commander of the American Navy in the War of Independence, with a historical museum in the Admiral Hopkins House; and City Hall Park. Blackstone Boulevard is 1½ m. long; and Pleasant Valley Parkway is 1¼ m. long. Enclosed by a railing near the eastern end of Power Street, on the bank of the Seekonk, is What Cheer Slate¹ Rock, according to tradition the first landing place of Roger Williams. In the North Burial Ground are the remains of Stephen Hopkins (1707-1785), a citizen of Providence, a delegate to the Albany convention of 1754, a colonial governor of Rhode Island (1755-1757, 1758-1762, 1763-1765, and 1767-1768), a member of the Continental Congress in 1774-1780 and a signer of the Declaration of Independence; of William Barton (1748-1831), who in the War of Independence captured General Richard Prescott near Newport on the 10th of July 1777; of Francis Wayland; and of Nicholas Brown, who was a patron of Brown University and one of the founders of the Providence Athenaeum and of the Butler Hospital for the Insane.

On the steep slope of College Hill (or Prospect Hill) in the east side near the business district, is Brown University (1764)—one of the eight colleges in the United States founded before 1776—closely connected with the history of Providence, Rhode Island, and the Baptist Church in America. It has an undergraduate department for men, with courses, largely elective, leading to the degrees of A.B. and Ph.B., and courses, almost wholly prescribed, in civil, mechanical and electrical engineering. It includes, besides "The Women's College in Brown University," a separate college for women, and a graduate department open to both men and women. The campus is shaded by some fine old elms and is surrounded by an iron fence with beautiful memorial gates. In 1910 there were twenty-two buildings, including the following: University Hall (erected in 1770 and used during the War of Independence as barracks and hospital by American and French soldiers); Sayles Memorial Hall (1881), containing the chapel, lecture halls and seminary rooms; three library buildings, the John Hay Library (which occupies the site of the old President's House), the old University Library (1878) and the John Carter Brown Library (1904); the Ladd Astronomical Observatory, with a 12-in. equatorial and much other valuable equipment; Rhode Island Hall (1840), containing a biological laboratory and a natural history museum; Manning Hall (1834), containing an art museum; Wilson Hall (1891), containing a physical and a psychological laboratory; Rogers Hall (1862), a chemical laboratory; an engineering building (1903); the Lyman gymnasium (1891) and Colgate Hoyt swimming pool (1904); an administration building (1902); the Sayles gymnasium (1906) for women; Rockefeller Hall (1903), occupied by the Brown Union, a students' organization and the Young Men's Christian Association; the residence halls: University Hall (1770, remodelled 1883), Hope College (1822 and 1891), Slater Hall (1879), Maxey Hall (1895), and Caswell Hall (1903); and the Carrie (clock) Tower, erected in 1904 by Paul Bajnotti, of Turin, Italy, as a memorial to his wife, Carrie Mathilde Brown, of Providence. Besides the general library, containing (1909) about 164,000 volumes, the university owns the separately housed John Carter Brown Library of 20,000 volumes, one of

the best collections in the world of material on early American history (especially of books printed before 1800), which, with an endowment of \$500,000, was presented to the university in 1901 in accordance with the will of John Nicholas Brown, the son of John Carter Brown (1797-1874) a prominent Providence merchant, who began the collection. In 1909 the university had an endowment fund of \$3,416,744, 90 instructors and 993 students, of whom 88 were graduates; of the undergraduates 179 were enrolled in the Women's College. The charter of the institution requires that it shall be governed by a board of thirty-six trustees, of whom twenty-two shall be Baptists, five Friends, four Congregationalists, and five Episcopalians, and by twelve fellows (including the president) of whom eight (including the president) shall be Baptists, "and the rest indifferently of any or all denominations." At the time it was framed the charter was considered extraordinarily liberal. Only two provisions are included regarding the character of instruction to be offered: first that "the public teaching shall in general respect the sciences," and second, that "into this liberal and catholic institution shall never be admitted any religious tests, but on the contrary all the members hereof shall forever enjoy full, free, absolute and uninterrupted liberty of conscience." The government has always been largely non-sectarian in spirit, and a movement was on foot in 1910 to abolish the denominational requirements for trustees and fellows.

Brown University, the first institution for higher education established by American Baptists, was incorporated in 1764, and although still under its original charter was known for the first forty years as Rhode Island College. The Latin or preparatory school was opened at Warren in 1764 and the college was started there in 1766, but in 1770 the institution was removed to Providence. Although its work was interrupted by the War of Independence, the institution was reopened in 1782 and ten years later it began to receive aid from Nicholas Brown (1769-1841), a wealthy merchant who graduated from the Rhode Island College in 1786; it was named in his honour in 1804, and up to the time of his death his gifts amounted to about \$160,000. Dr Francis Wayland, the most eminent of its presidents, began his administration in 1827 and in twenty-eight years of service as its head he established the elective system and greatly raised the standard of scholarship. Brown actually became a university under Elisha Benjamin Andrews, who was president in 1889-1898, who developed the graduate school and undergraduate instruction in history and social and political science, and who was succeeded in 1899 by William Herbert Perry Faunce (b. 1859), who graduated at Brown in 1880. In 1900 and 1901 more than \$2,000,000 was added to the endowment of the university. The Women's College was founded in 1891, and in 1897 it was accepted by the corporation as a department of the university. Among distinguished alumni of Brown are Henry Wheaton (1785-1848), John Hay, Richard Olney, James Burrill Angell (b. 1829) Adoniram Judson, William Learned Marcy, Wilbur Fisk, Horace Mann, Samuel Gridley Howe, Barnas Sears, Edwards Amasa Park, Samuel Sullivan Cox, George Park Fisher, George Dana Boardman, Alexander Lyman Holley, and Albert Harkness.

In Providence are the Rhode Island Normal School (in the north part of the city, in Gaspee St.; established in 1854; discontinued in 1857; re-established in 1871), which has a fine building (1898), the Rhode Island Institute for the Deaf (1876), and the Rhode Island School of Design (1877; partially supported by the state, since 1882, and by the city), affiliated with Brown University. The following secondary schools are in the city: four high schools, one of which is technical, La Salle Academy (1871; Roman Catholic, under the Brothers of the Christian Schools), Saint Xavier's Academy (Roman Catholic), the Academy of the Sacred Heart (Roman Catholic), Moses Brown School (Friends; at Portsmouth in 1784-1788; re-established in Providence in 1814), the Brown school for boys (non-sectarian), Fielden-Chace school for girls (non-sectarian), and the Lincoln School (non-sectarian). The public school system has benefited by the presence of Brown University, whose faculty has been largely represented on the school committee; by an agreement with the university its professor of the theory and practice of education is director of the training department in the high schools, and there are other schemes of co-operation. Transition classes between the kindergarten and primary were

¹ So called because Roger Williams was greeted here by Indians, who said "What cheer, Netop?" ("Netop" meaning friend).

long peculiar to the Providence public schools. In 1908 a "Sunshine School" was established, with sun and fresh-air treatment for invalid pupils.

The *Providence Journal* (Independent, daily, 1829), the most important newspaper published in the state, and the *Evening Bulletin* (Independent, 1863) are controlled by the same company.

The charitable institutions include the Rhode Island Hospital (1863, private), the Prisoners' Aid Association (1872), the Providence Rescue Home and Mission (1896), the Bethany Home of Rhode Island (1892), a temporary home for women; the House of the Good Shepherd (1904), the Lying-In Hospital (1884), Saint Joseph's Hospital (1892; Sisters of St Francis), two dispensaries, a City Hospital for the Treatment of Contagious Diseases (1909) on Capitol Hill; the Butler Hospital for the Insane, which is one of the oldest institutions of its kind in the country, was established by a bequest of \$30,000 left in 1841 by Nicholas Brown, and has about 120 acres of beautiful grounds on the western bank of the Seekonk; the Dexter Asylum for the Poor (endowed with the Dexter Fund and limited to those who have a legal settlement in Providence, *i.e.* have paid taxes on \$200 worth of property for five years; and hence a charity of little practical use); a home for aged men (1875), a home for aged women (1856), St Elizabeth's Home (1882, Protestant Episcopal) for incurable and convalescent women; a home for aged coloured women (1890), five temporary homes, the Rhode Island Catholic Orphan Asylum (1851, Sisters of Mercy), St Vincent de Paul's Infant Asylum (1892, Sisters of Divine Providence), St Mary's Orphanage (1873, Protestant Episcopal), the State Home and School (1885) for indigent and neglected children, Providence Children's Friend Society (1835), other homes for children, day nurseries, and the Providence Society for organizing charity (1892). Jewish charities are prominent. The St Vincent de Paul Society is the organized charity of the Roman Catholic churches.

The harbour of Providence and its approaches have been much improved since the middle of the 19th century by the Federal and state governments. Between 1853 and 1873 the low-water depth of the channel was increased from 4½ ft. to 12 ft., at a cost of \$59,000; from 1878 to 1895 the depth of the channel was further increased to 25 ft., and anchorage basins were created with a minimum depth of 20 ft. for a width of 600 ft., with a minimum depth of 18 ft. for a width of 725 ft., with a minimum depth of 12 ft. for a width of 940 ft., and with a minimum depth of 6 ft. for a width of 1060 ft. Between 1896 and 1906 the channel from Sassafras Point to the ocean was widened to 400 ft. and by 1909 the anchorage area, having a depth of 25 ft., was further increased to about 288 acres. Between 1867 and 1909 the channel of the Seekonk river was dredged to a depth of 16 ft. as far as Pawtucket at the head of navigation. In 1908 the commerce, largely coastwise, of Providence Harbor, amounted to 3,379,594 tons, chiefly coal, general merchandise and fish, valued at \$93,309,495. In 1909 the value of the foreign imports, chiefly salt from Turks Island and lumber from Nova Scotia, amounted to \$1,893,551, and the value of the exports to \$12,517. Of greater importance to Providence than its commerce are its manufactures, the value of which in 1905 was \$91,980,963, or 16.9% more than in 1900. Its factory products were valued at 45.5% of the state's total; its wage earners were 40.9% of the state's total; and nearly one-half of the worsted goods and more than one-fourth of all the textiles made in the state were manufactured here, as were four-fifths of the rubber and elastic goods, nine-tenths of the foundry and machine-shop products, and all the gold and silver refined, not from the ore. The Gorham Company engage here in the manufacture of gold, silver and bronze works of art; the American Screw Company, the Brown & Sharpe Manufacturing Company, and the Nicholson File Company have factories here; and here the famous Corliss engines were first made about 1847. In 1905 Rhode Island ranked first among the states and Territories of the Union in the value of jewelry manufactured and more than 99% of this was made in Providence, which produced 26.6% (by value) of all the jewelry made in the United States. The value of the jewelry made in Providence in 1905 was \$14,317,050, being 15.6% of the value of the city's entire factory product. Closely allied with this manufacture were the reducing and refining of gold and silver sweepings, &c. (none from ore), with a product value in 1905 of \$4,260,698, and silversmithing and the manufacture of silver-ware with products in 1905 valued at

\$5,323,264. Actually the largest industry in 1905 was the manufacture of worsted goods, valued at \$21,020,892. Other important manufactures are foundry and machine-shop products (1905, \$9,358,687), woollen goods (\$2,080,658), cotton goods (\$1,025,264) and cotton small wares (\$1,967,298), dyeing and finishing textiles (\$2,254,074), rubber and elastic goods (\$2,167,983), and malt liquors (\$1,427,246).

Providence is governed under a city charter of 1832, subsequently amended. A town meeting is still held annually for the administration of the fund (referred to above) called the Dexter donation. Under the city charter only citizens who pay a tax on \$134 worth of real property or \$200 worth of personal property may vote for members of the city council. Until 1842 there was the further requirements that every voter should be the eldest son of a freeholder. The city council is composed of: a board of aldermen, one from each of the ten wards, which may redistrict the city every five years, and until 1895 acted as a returning board, and which is presided over by the mayor; and a common council of four members from each ward, elected in open ward-meeting by the qualified freeholders of the ward. Elections are annual. The aldermen and common council meet together to organize and to elect municipal officers, not otherwise provided for. The greater size of the common council gives it the power in joint sessions; and although the vote of the city for mayor is normally Democratic, the vote of the qualified freeholders (which is only about 40% of the total vote) for common-councilmen and aldermen is always Republican.

The two houses acted before 1895 as a board of registration; the council now chooses a board of three members with a term of three years. The city council and a school committee of 33 members (3 *ex officio*; 30 elected by wards, one each year from each ward for a three-year term) control the public schools. The mayor has had the veto power only since 1854; and until 1866 his veto could be overridden by a majority vote; a three-fifths vote of each chamber is now necessary. The mayor was at the head of the police department until 1901, when a commission of three was created; until 1906 these police commissioners were appointed by the governor of the state, but they are now chosen by the mayor with the approval of the board of aldermen. In the same way the mayor appoints a commissioner of public works for a term of three years. The three commissioners of the fire department and the three members of the board for the assessment of taxes are chosen by the city council. The city treasurer (since 1858) and the overseer of the poor and the harbour-master (since 1866) are elected by popular vote. The municipality owns and operates the waterworks and there are municipal bath-houses.

Providence was founded in 1636 by Roger Williams, an exile from Massachusetts, and its early history is closely bound up with the early history of Rhode Island, it being one of the four towns out of which this commonwealth was formed. Having agreed with Canonicus and Miantonomo, the Narraganset sachems, for the purchase of a considerable tract of land, Williams built his house about 50 ft. east of what is now North Main Street and nearly opposite the confluence of the Moshassuck and Woonasquatucket rivers, and he named the place Providence in recognition of his divine guidance hither. He and a few companions who had accompanied him into exile immediately established a town government with monthly town meetings, and in the next year, 1637, after the arrival of a few more settlers, a plantation covenant was adopted which laid the basis of the future commonwealth on a new principle—the complete separation of religious and civil affairs. In 1644 Williams secured a charter uniting Providence, Aquidneck (Portsmouth), and Newport, as "The Incorporation of Providence Plantations in the Narraganset Bay in New England"; these three towns (and Warwick) organized in Providence in May 1647 under this government. The charter of the 24th of November 1663, to the Governor and Company of the English Colony of Rhode Island and Providence Plantations, perpetuated the name Providence Plantations, which still remains a part of the legal title of the state. Providence was incorporated as a town by

the Colonial Assembly in 1649; in 1730-1731, when the area of Providence was 370 sq. m., Scituate (including Foster), Gloucester (including Burrillville), and Smithfield (including North Smithfield and Lincoln) were set off; in the next thirty years the area of the township was reduced to 5½ sq. m. by the separation of Cranston, Johnston and North Providence, parts of which have been re-annexed since 1860. Providence was chartered as a city in 1832. During King Philip's War, in 1676, the town was attacked by Indians and the northern half was burned. In June 1772, a British schooner, the "Gaspee," while chasing a Providence packet-boat ran aground at what has since become known as Gaspee Point, whereupon its capture was planned by John Brown (1736-1828), a Providence merchant, and the plan—including the burning of the vessel—was carried out under the command of Abraham Whipple (1733-1819). During the war much privateering was carried on from Providence. The British occupation of Newport during the War of Independence caused the transfer of the important foreign commerce of that city to Providence, but as a consequence of their superior railway facilities most of this went to New York and Boston before the middle of the 19th century. In September 1815 Providence was visited by a gale which did about \$1,000,000 damage to its shipping and other property. In 1830 Providence had ceased to be a great port and had begun to be a textile manufacturing place. Until 1900 Providence was one of the two capitals of the state, Newport being the other; since 1900 it has been the sole capital.

See H. C. Dorr, "The Planting and Growth of Providence," in the *Rhode Island Historical Tracts* (Providence, 1882); W. A. Greene and others, *The Providence Plantations for Two Hundred and Fifty Years* (Providence, 1886); W. R. Staples, *Annals of the Town of Providence* (Providence, 1843); W. B. Weeden, "Providence, the Colony of Hope," in L. P. Powell's *Historic Towns of New England* (New York, 1898); H. K. Stokes, "Finances and Administration of Providence" (Baltimore, 1903) in *Johns Hopkins University Studies in Historical and Political Science*; and William Kirk and others, *A Modern City: Providence, Rhode Island, and Its Activities* (Chicago, 1909).

PROVINCE (Lat. *provincia*; perhaps a contraction of *providentia*), a term originally applied, in ancient Rome, to the department or sphere of duty assigned to one of the higher magistrates, the consuls and praetors.¹ When, with the spread of the Roman arms, the government of conquered countries grew to be one of the most important duties of the higher magistrates, the term province, from designating the government of a conquered country as one particular duty of a Roman magistrate, came to be used generally as a designation of the country itself. Thus in later days it was applied to analogous territorial subdivisions of a country, as opposed to the centre of government; and apart from any territorial signification, the term is used generally for a sphere of duty.

It is to the older sense of the term as a subject territory lying outside of Italy and governed by Roman magistrates that the following historical remarks apply:—

As distinguished from Italy, the provinces paid tribute to Rome, for, at least from the time of the Gracchi, it was a recognized constitutional principle that the provinces were the estates of the Roman people and were to be managed for its benefit. Under the republic the constitution of a province was drawn up by the victorious Roman general assisted by ten commissioners appointed by the senate from its own body, and the province was henceforth governed on the lines laid down in this constitution or charter (*lex provinciae*). For administrative purposes the province was divided into districts, each with its capital, the magistrates and council of which were responsible for the collection of the district taxes. For judicial purposes the province was divided into circuits (*conventus*), and in the chief town of each circuit the governor of the province regularly held assizes.

¹Only those magistrates who had *imperium* (military power) had a province. When the province of a quaestor is mentioned it refers to the province of the consul or praetor to whom the quaestor is subordinate. In familiar language any business was called a province.

Cities taken by the sword were destroyed, and their lands were turned into Roman domains and were let out by the censors at Rome to private persons, who undertook to pay a certain proportion of the produce. Royal domains, such as those of Syracuse, Macedonia, Pergamum, Bithynia and Cyrene were also confiscated. On the other hand communities which surrendered without offering an obstinate resistance were usually allowed to retain their personal freedom and private property, and their chief town was left in the enjoyment of its territory and civil rights; but all the lands were subjected to a tax, consisting either of a payment in kind (*vectigal*) or of a fixed sum of money (*tributum, stipendium*), and in some cases a custom-duty (*portorium*) was levied. It is to this latter class of communities (the *civitates vectigales* or *stipendiariae*) that the large majority of the provincial states belonged. In a better position were those states whose freedom was guaranteed by Rome on the ground of old alliances or special loyalty. Their freedom was recognized either by a treaty or by a decree of the Roman people or senate. As a decree of the people or senate could at any time be recalled, the position of the free states without a treaty was more precarious than that of the treaty states (*civitates foederatae*). The latter, though not allowed to meddle in foreign politics, enjoyed a certain amount of internal freedom, retained their lands, paid no taxes, and were bound to render those services only which were expressly stipulated for in the original treaty, such as furnishing ships and troops, supplying corn at a certain price and receiving Roman officials and soldiers *en route*. Amongst these treaty states were Massilia (Marseilles), Athens, Rhodes and Tyre. The privileges of the free but not treaty states were somewhat similar, but, as stated, more precarious. All political distinctions, save that between slave and freeman, disappeared when Caracalla bestowed the Roman franchise on the whole empire.

Provincial Diets.—Apart from the government by Roman officials, every province appears to have had, at least under the empire, a provincial assembly or Diet of its own (*concilium* or *commune*), and these Diets are interesting as the first attempts at representative assemblies. The Diet met annually, and was composed of deputies (*legati*), from the provincial districts. It arranged for the celebration of religious rites and games, especially (under the empire) for the worship of the emperor, the neglect of which was severely punished. The actual celebration was under the conduct of the high priest of the province, a person of much dignity and importance, perhaps the forerunner of the Christian bishop. The Diet also decreed the erection of statues and monuments; it passed votes of thanks to the outgoing governor, or forwarded complaints against him to Rome; and it had the right of sending embassies direct to the senate or the emperor.

The Provincial Governor.—The provinces were administered by governors sent direct from Rome, who held office for a year. From the formation of the first provinces in 227 B.C. down to the time of Sulla (82 B.C.) the governors were praetors (see *PRÆTOR*); from the time of Sulla to that of Augustus the praetors remained in Rome during their year of office, and at the end of it assumed the government of a province with the title of propraetor. This applies, however, only to provinces which were in a settled state and could consequently be administered without a large military force. A province which was the seat of war, or was at least in a disturbed state, was committed to the care either of one of the consuls for the year or of a commander specially appointed for the purpose with the title of proconsul, who might be one of the consuls of the preceding or of a previous year, or else a former praetor, or even, in rare cases, a private individual who had held neither consulship nor praetorship. Thus the distinction between consular (or proconsular) and praetorial (or propraetorial) provinces varied from year to year with the military exigencies of different parts of the empire. At the close of the republic, however, we find even such a peaceful province as Asia administered by a proconsul. In the earlier period of the republic the senate either before or after the elections determined which provinces were to be governed by consuls and which by praetors, and after their election the consuls arranged themselves by lot or otherwise which of the provinces nominated by the senate each should have, and similarly with the praetors. But in order to guard against partiality the Sempronian law of 123 B.C. provided that the senate should yearly nominate the two consular provinces before the election of the

consuls, and that the consuls should after their election but before their entry on office arrange between themselves which of the two provinces each should have. The Pompeian law of 53 B.C. enacted that no one should hold the governorship of a province till at least five years after his consulship or praetorship. This law was repealed by Caesar after the battle of Pharsalia, but was re-enacted under Augustus; it severed the connexion which had previously existed between an urban magistracy and the governorship of a province, and turned the latter, from the mere prolongation of a Roman magistracy, into an independent office. Like magistracies at Rome a provincial governorship was regularly held for one year; but, unlike them, it could be prolonged, formerly by a vote of the people, later by a decree of the senate. The Julian law of Caesar (46 B.C.) enacted that the governorship of a consular province should be held for two, that of a praetorian province for one year. The necessary supplies of men and money were voted to the governor by the senate. His staff consisted of one or more lieutenants (*legati*), a quaestor (*q.v.*) and numerous subordinates. The lieutenants were nominated by the senate from men of senatorial rank; if they proved incompetent, the governor dismissed them; if they showed ability, he entrusted them with military or judicial functions. Besides these the governor took with him from Rome a number of young men of the upper classes to assist him in the government. These were known as the companions (*comites*) or suite of the governor, sometimes, but incorrectly, as the praetorian cohort (see PRAETORIANS). These members of his suite were chosen by the governor himself, who was responsible for them, but they were maintained at the expense of the state, and under the empire received regular pay. In addition there was a crowd of beadles, clerks, couriers, criers, doctors, dragomans, &c., not to speak of freedmen and slaves for the personal service of the governor. Under the republic the governor was not allowed to take his wife with him to his province; under the empire he might do so, but he was answerable for her conduct. Before setting out for his province the governor, clad in the purple military robe of his office, offered sacrifice on the Capitol; then immediately after receiving the *imperium* or military command he marched out of the city (for the *imperium* could only be exercised outside of Rome and was forfeited by staying in the city), preceded by his sergeants (*lictors*), and accompanied by his suite. He was bound to travel direct to his province; the means of transport were supplied partly by the state, partly by the provinces through which he travelled. His year of office began from the day he set foot in his province, but the time of arrival varied with the length and difficulty of the route. In the hands of the governor all powers military and civil were united. He commanded all the troops in the province, and had power to raise levies of Roman citizens as well as of provincials, and to make requisitions of war material. He possessed both criminal and civil jurisdiction; as criminal judge he had the power of life and death, and from his sentence none but Roman citizens could appeal; as civil judge he was guided partly by the charter of the province (*lex provinciae*), partly by the edict which it was customary for him to issue before his entrance on office (compare PRAETOR), partly by the original laws of the country so far as their validity was acknowledged by the charter or by the governor's own edict. Under the empire Gaius wrote a commentary on the provincial edict, and it is usually supposed that this was a general edict drawn up for use in all the provinces and superseding all separate edicts for the different provinces. Mommsen, however, is of opinion that Gaius only commented on the edict of a particular province.

Condition of the Provinces under the Republic.—Under the republic the Roman people regarded the provinces as so many estates from which they were to derive revenue. The weal or woe of the provincials was of no moment, but the development of the material resources of the provinces was of great moment. Hence agriculture and commerce were encouraged, settlements were made, roads and aqueducts were constructed; in short, the Roman aimed at exploiting his empire by a system of prudent economy as far as possible removed from the blind rapacity which has turned the empire of the Turk from a garden into a wilderness. But the Roman governors were too apt to look on their provinces as their own peculiar prey; they had usually bought their way to office at vast expense, and they now sought in the provinces the means of reimbursing themselves for the expenditure they had incurred at Rome. The annual change of governor was thus a frightful calamity to the provincials, for every year brought a repetition of the same extravagant demands to be met by the same or, as the province became exhausted, still heavier sacrifices. Redress was to be had originally by a complaint to the senate; after 149 B.C. there was a regular court established at Rome for the trial of cases of extortion (*repetundae*) by provincial governors. But, even when after much trouble and expense the provincials had arraigned their oppressor, it was difficult to secure his condemnation at the hands of juries composed (as they usually were) of men who had a fellow-feeling for the offender because they had themselves committed or hoped for means of committing similar offences. Besides the governor, two classes of harpies joined in wringing the uttermost farthing from the unhappy provincials. These were the *publicani* or farmers of the taxes, and the money-lenders (*negotiatores*), who supplied a temporary accommodation at ruinous rates of interest. Both these

classes were recruited from the ranks of the Roman knights, and, since from the legislation of Gaius Gracchus (122 B.C.) the juries were drawn at first exclusively and after Sulla's time (81 B.C.) partially from the knightly order,¹ the provincial governor could not check the excesses of those blood-suckers without risking a condemnation at the hands of their brethren. Accordingly he generally made common cause with them, backing their exactions when needful by military force.

The Provinces under the Empire.—Under the empire the provinces fared much better. The monarchy tended to obliterate the distinction between Romans and provincials by reducing both to a common level of subjection to the emperor, who meted out equal justice to all his subjects. The first centuries of the Christian era were probably for some of the countries included in the Roman Empire the happiest of their history; Gibbon indeed fixed on the period from the death of Domitian to the accession of Commodus (96–180 A.D.) as the happiest age of the world.

Augustus, in 27 B.C., divided the provinces into imperial and senatorial. Those which, from their proximity to the frontier or the turbulence of their population, required the presence of an army were placed under the direct control of the emperor; those which needed no troops were left to be administered by the senate. (1) The senatorial provinces were ruled by an annual governor as under the republic. Of these provinces Augustus ordained that Africa and Asia should be consular, the rest praetorian; but all the governors of the senatorial provinces were now called proconsuls. Their powers and dignities were much the same as they had been under the republic, except that they had now no troops, or only a handful to maintain order. (2) The imperial provinces were governed by imperial lieutenants (*legati Caesaris*), who were nominated by the emperor and held office at his pleasure; all of them had the power of the sword (*jus gladii*). For the administration of the finances these lieutenants had procurators under them, while the governors of the senatorial provinces continued to have quaestors as under the republic. Another class of imperial provinces consisted of those which from the physical nature of the country (as the Alpine districts) or the backward state of civilization (as Mauretania and Thrace) or the stubborn character of the people (as Judaea and Egypt) were not adapted to receive a regular provincial constitution. These were regarded as domains of the emperor, and were managed by a procurator (in the case of Egypt by a praefect, see PRAEFECT) nominated by and responsible to the emperor.

Under the empire all provincial governors received a fixed salary. Complaints against them were brought before the senate, and the accusers were allowed a senator to act as their advocate. The lengthened periods during which the governors, at least in the imperial provinces, held office, together with the oversight exercised by the emperor, alleviated materially the position of the provincials under the empire. In order to keep himself well informed of what was passing in the empire, Augustus established a post whereby official despatches were forwarded by couriers and official persons were conveyed by coaches. The post, however, was only for the use of the government; no private person was allowed, unless by an exceptional concession, to avail himself of it. (J. G. FR.; X.)

AUTHORITIES.—The most exhaustive account of the Roman provinces and their administration will be found in Marquardt, *Römische Staatsverwaltung* (1881), vol. i. See also W. T. Arnold, *Roman Provincial Administration* (1879); Mommsen, *Roman Provinces under the Empire* (1884); C. Halgan, *L'Administration des provinces senatoriales sous l'empire*, with full bibliography of the subject; and T. M. Taylor, *Constitutional and Political History of Rome* (1899).

PROVINCETOWN, a township at the N. end of Cape Cod, in Barnstable county, Massachusetts, U.S.A. Pop. (1890), 4642; (1900), 4247; (1910 U.S. census) 4369. Area about 9½ sq. m. The township is served by the New York, New Haven & Hartford railway, and by a steamship line to Boston. The harbour, which is important as a harbour of refuge, is protected on the east by land, and the Federal government has strengthened this protection by dikes and groins and other sand-catching devices; it has five lighthouses. There is a magnificent beach stretching 30 m. from Provincetown village to Eastham. The village is a summer resort. Through many generations the inhabitants have gained their living chiefly from the sea; the township's fisheries, however, have greatly decreased in importance (the invested capital diminishing 67.1% in 1885–1895). The prosperity it retains is not a little due to Portuguese from the Cape Verde Islands and the Azores, and to British Americans. Provincetown village was long second only to Gloucester in the cod fisheries, which low prices and the introduction of larger vessels and correspondingly costlier fittings have greatly

¹ Sulla excluded the equites from the list; the *lex Aurelia* (70) reinstated them.

handicapped. Whaling retains a remnant of its old importance, and there are also mackerel and shore fisheries, oil-works, cold storage establishments for preserving fish for food and bait, and canning works for herring. The first settlement here was made about 1680; it became a "district" or precinct of Truro in 1714, and was established as a township with its present name in 1727. Provincetown harbour was possibly visited by Gaspar Cortereal in 1501; Gosnold explored it and its vicinity in 1602, and John Smith was here in 1614. It was in this harbour that the "Mayflower" compact (see MASSACHUSETTS) was drawn up and signed by the Pilgrims before they proceeded to Plymouth, in 1620; here John Carver was chosen the first governor of Plymouth Colony, and Provincetown was the first landing place (on Saturday the 11th [o.s.] of November) of the Pilgrims in the New World. A memorial of the "compact," of polished Acton granite, 6 ft. high, with two bronze tablets, was erected before the town-hall by the Old Colony Commission, and on High Pole Hill on the 20th of August 1907 the cornerstone of a second memorial (completed in 1909, dedicated Aug. 5, 1910), a granite tower, 252 ft. high, was laid, addresses being delivered by President Roosevelt, James Bryce and H. C. Lodge. In Provincetown harbour, on the 1st of January 1862, James M. Mason and John Slidell, the envoys of the Confederate States to Great Britain and France respectively, who had been taken by a Federal vessel from the British ship "Trent," were restored by the Federal authorities to H.B.M.S. "Rinaldo," after their detention in Fort Warren in Boston harbour.

PROVINS, a town of northern France, capital of an arrondissement of the department of Seine-et-Marne, at the junction of the Durtain with the Voulzie (an affluent of the Seine), 59 m. E.S.E. of Paris by rail. Pop. (1906), 7546. The town enjoys a certain reputation for its mineral waters (which contain iron, lime, and carbonic acid, and are used for bathing and drinking), and is also known from its trade in roses, but it derives a higher interest from numerous remains of its medieval prosperity. Provins is divided into two quarters—the ville-haute and the less ancient ville-basse—which in the 13th century were surrounded by fortifications. There still remains a great part of these fortifications, which made a circuit of about 4 m., strengthened at intervals by towers, generally round, and now, being bordered with fine trees, form the principal promenade of the town. The large tower situated within this line, and variously known as the king's, Caesar's or the prisoners' tower, is one of the most curious of the 12th century keeps now extant. The base is surrounded by a thick mound of masonry added by the English in the 15th century when they were masters of the town. The tower serves as belfry to the church of St Quiriace, which dates its foundation from the 12th century. These two buildings in the ville-haute rise picturesquely from the crest of a steep wooded hill above the ville-basse. The church preserves among its treasures the pontifical ornaments of St Edmund of Canterbury (d. 1242). The interior is plain, but very beautifully proportioned. The appearance of the exterior suffers from an inappropriate dome erected above the crossing. The palace of the counts of Champagne, some fragments of which also belong to the 12th century, is occupied by the communal college. The old tithe-barn is a building of the 13th century with two fine vaulted chambers, one of which is below ground. The church of St Ayoul dates from the 12th to the 16th centuries, the transept being the oldest part; it is in a state of great dilapidation, and the choir is used as a storehouse. St Croix belongs partially to the 13th century. Extensive cellars, used as warehouses in the middle ages, extend beneath portions of the town. On Mont Ste Catherine, opposite Provins, the general hospital occupies the site of an old convent of St Clare, of which there remains a cloister of the 14th century. The sub-prefecture, tribunals of first instance and of commerce are among the public institutions. There is an active trade in grain, livestock and wool, and the industries include flour-milling, nursery-gardening, brickmaking, and the manufacture of porcelain, pianos, gas and petrol engines, agricultural implements and sugar.

Provins began to figure in history in the 9th century. Passing from the counts of Vermandois to the counts of Champagne, it rapidly attained a high degree of prosperity. Cloth and leather were its staple manufactures, and its fairs, attended by traders from all parts of Europe, were of as much account as those of Beaucaire, while its money had currency throughout Europe. In the 13th century the population of the town is said to have reached 60,000; but the plague of 1348 and the famine of 1349 proved disastrous. The Hundred Years' War, during which Provins was captured and recaptured, completed the ruin of the town. During the religious wars it sided with the Catholic party and the League, and Henry IV. obtained possession of it in 1592 only after thirteen days' siege.

See Felix Bourquelot, *Histoire de Provins* (2 vols., Provins, 1839-1840).

PROVISION (Lat. *provisio*), a term meaning strictly the act of providing, or anything provided, especially in respect of food (provisions) or other necessaries. In constitutional law it signifies the act by which an ecclesiastical office or benefice is conferred by a person having competent authority for the purpose; and the word is specially used of appointments made by the pope in derogation of the rights of ecclesiastical patrons. Innocent III. (1198-1216) seems to have been the first pope who directed prelates to collate his nominees to canonries and other benefices, but it was during the pontificate of Innocent IV. (1243-1254) that the practice first assumed alarming proportions. Vigorous protests were then made in England and France against the large number of papal provisions in favour of non-resident Italian clerks. These protests were not without effect for a while; but the popes, finding it impossible to carry on the work of government without this means of rewarding their servants, soon began to show little regard to national protests. The English parliament held at Carlisle in 1307 petitioned the king for a remedy against this abuse, but though he promised redress nothing was done. Meanwhile the popes had been asserting claims to appoint bishops in certain events on their own initiative, and at last Clement V. (1305-1313) reserved to himself the right of appointment in all cases. After his time there is scarcely an instance of an English bishop being elected in accordance with the older procedure by the cathedral chapter. If an election were made the pope usually either overrode it by another appointment or, ignoring the election, appointed the elected clerk by a bull of provision. The Hundred Years' War caused an outburst of indignation against the use of papal provisions, whether to the canonries and collative offices or to bishoprics. The popes had taken up their residence at Avignon and had become mere creatures of the kings of France. The English nobility and gentry were bitter at seeing vast sums of money pass out of the country into the hands of their enemies. To remedy the evil the first Statute of Provisors was enacted in 1351. It declared that the free elections of bishops and other dignitaries should take place in accordance with the ancient practice; that bishops and ecclesiastics should have free presentations to benefices and offices in their gift; that in the event of any provision being made by the pope the king should have the same right of collation as his progenitors had before they granted free election; and similarly where the pope provided to a benefice or office in the gift of secular or regular clergy the king was to have the collation for that occasion. Provisors who interfered with the rights of the king or patron were liable to arrest and imprisonment on conviction. The act was supplemented in 1353 by the first Statute of Praemunire, by which appeals outside the realm were prohibited and persons who offended were made liable to outlawry. This legislation against papal provisions was anti-clerical rather than anti-papal. There are no signs that it was promoted by the English clergy, who seem to have accepted the claim of the popes to control their patronage. In spite of the statutes the popes still continued, as the papal registers show, to make provisions to English benefices and offices, and it is evident that the statutes were not enforced. The Statute of Provisors was confirmed by a second statute in 1364, but this again seems to have had little effect. Attempts were made to

establish a concordat on the subject between the king and pope; its terms, however, were all in favour of the latter. At last, in 1380, a third Statute of Provisors was enacted which provided that the statute of 1351 should be firmly holden for ever and "put in due execution from time to time in all manner of points." The new statute was carried into effect as regards canonries and benefices; but, until the Reformation, bishops were nominally appointed by a papal bull of provision. The person appointed, however, was usually nominated by the king, and the bull was not issued without his consent.

AUTHORITIES.—*Statutes of the Realm; Calendar of Papal Registers; J. Le Neve, Fasti ecclesiae anglicanae; Rolls of Parliament; F. W. Maitland, Canon Law in the Church of England; W. Stubbs, Constitutional History of England; Anglia sacra.* (G. J. T.)

PROVISIONAL ORDER, a method of procedure followed by several government departments in England, authorizing action on the part of local authorities under various acts of parliament. Procedure by provisional order is a substitute for the more expensive course of private bill legislation; it is usually employed for such purposes as alteration of areas, compulsory purchase of land, building of light railways, &c. A preliminary local inquiry is first held in public by an inspector of the department to whom application has been made to issue it. Upon the report of the inspector and other information the department decides whether or not to issue the order. The order when issued has no force until it is confirmed by parliament. For this purpose it is included with other orders in a confirming bill, introduced by the minister at the head of the department concerned. In both houses of parliament all provisional order bills are referred to examiners for compliance with standing orders. In the House of Lords, if a provisional order bill is opposed, it is referred to a select committee and then to a committee of the whole house; if not opposed, it goes, after second reading, to a committee of the whole house, and in both cases then proceeds as a public bill. In the House of Commons, the bill goes after second reading to the committee of selection or to the general committee on railway and canal bills; if unopposed it is treated as an unopposed private bill; if opposed it goes to a private bill committee, which hears evidence for and against.

PROVO, a city and the county-seat of Utah county, Utah, U.S.A., on the Provo river, 3 m. E. of Utah Lake, and about 45 m. S. by E. of Salt Lake City. Pop. (1890), 5159; (1900), 6185 (1176 foreign-born); (1910) 8925. Provo is served by the Rio Grande Western and the San Pedro, Los Angeles & Salt Lake railways. It is situated at an altitude of about 4530 ft., in a region of fine scenery, Provo Cañon, Bridal Veil Falls and Utah Lake being of especial interest. The city has a general hospital and is the seat of the state mental hospital and of Brigham Young University (a Mormon institution), founded by Brigham Young in 1875, opened as an academy in 1876, and incorporated in 1896; it comprises a college and high commercial, music, arts and trades, agricultural and preparatory schools. Provo has various manufactures, including woollen goods, lime, pottery and bricks, and the city is a shipping point for a fertile agricultural and fruit-producing region. Within a radius of forty or fifty miles of Provo are a number of important mines. Provo was settled in 1849 and was chartered as a city in 1851.

PROVOST (through O. Fr. *prevost*, mod. *prévôt*, Lat. *praepositus*, set over, from *praepone*, to place in front), a title attached to various ecclesiastical and secular offices. In ecclesiastical usage the word *praepositus* was at first applied by the Church fathers to any ecclesiastical ruler or dignitary. It early, however, gained a more specific sense as applied to the official next in dignity to the abbot of a monastery, or to the superior of a single cell. Thus in the rule of St Benedict the provost (*praepositus*) is the superior of the monastery immediately subordinate to the abbot, the dean (*decanus*) being associated with him. From the Benedictine rule this arrangement was taken over by Chrodegang of Metz when he introduced the monastic organization of cathedral chapters. In these the provostship (*praepositura*) was normally held by the archdeacon, while the office of dean fell to the archpriest. In many cathedrals the temporal

duties of the archdeacons made it impossible for them to fulfil those of the provostship, and the headship of the chapter thus fell to the dean. In England the title "provost" has thus everywhere given way to that of "dean"; in Germany, on the other hand, "*Probst*" is still the style of the heads of certain chapters. The title has also been preserved in certain dioceses of the German Evangelical Church as the equivalent of *Superintendent*, and both the Roman Catholic and Protestant chaplains-general of the forces have sometimes, e.g. in Prussia, the title *Feldprobst*. The heads of Augustinian and Dominican friaries are termed "provost or prior" (*praepositus vel prior*), those of Cistercian monasteries "provost or warden" (*praepositus vel custos*). Finally the name *praepositus* was sometimes used for the secular *advocatus* of a monastery. With the ecclesiastical use of the title is connected its English application to the heads of certain colleges; "provost" is still the style of the principals of Queen's, Oriel and Worcester Colleges at Oxford, of King's College at Cambridge, of Trinity College at Dublin and of Eton College.¹

As a secular title *praepositus* is also very old; we need only instance the *praepositus sacri cubiculi* of the late Roman Empire, and the *praepositus palatii* of the Carolingian court. The important developments of the title in France are dealt with below. From France the title found its way into Scotland, where it survives in the style (provost) of the principal magistrates of the royal boroughs ("lord provost" in Edinburgh, Glasgow, Aberdeen, Perth and Dundee), and into England, where it is applied to certain officers charged with the maintenance of military discipline. A provost-marshal is an officer of the army appointed when troops are on service abroad for the prompt repression of all offences. He may at any time arrest and detain for trial persons subject to military law committing offences, and may also carry into execution any punishments to be inflicted in pursuance of a court martial (Army Act 1881, § 74). A provost-sergeant is an officer responsible for the maintenance of order when soldiers are in the United Kingdom. A provost-sergeant may be either garrison or regimental, and he has under his superintendence the garrison or regimental police.

(W. A. P.)

The Provost in France.—The word *prévôt* (provost) in old French law had many applications. In conformity with its etymology (*praepositus*) it could be applied to any person placed at the head of a branch of the public service, a position which, according to the old principles, habitually carried with it a right of jurisdiction. It is thus that there was at Paris the "provost of Paris," who was a royal judge, and the "provost of the merchants" (*prévôt des marchands*), the head of the Paris municipality.² There were besides—to mention only the principal provosts—the "provosts of the marshals of France" (*prévôts des maréchaux de France*), of whom more below; the "provost of the royal palace" (*prévôt de l'hôtel du roi*) or "grand provost of France" (*grand prévôt de France*), and the "provost general" (*prévôt général*) or "grand provost of the mint" (*grand prévôt des monnaies*). But the most important and best known provosts, who formed part of a general and comprehensive organization, were the "royal provosts" (*prévôts royaux*), the lower category of the royal judges. It must be borne in mind, however, that the magistrates belonging to the inferior category of royal judges (*juges subalternes*) had different designations in many parts of France. In Normandy and Burgundy they were called *châtelains*, and elsewhere—especially in the south—*viguiers*. These were titles which had established themselves in the great fiefs before their reunion with the Crown and had survived this. The royal provosts, on the other hand, were a creation of the Capetian monarchy.

The date of this creation is uncertain, but was without doubt some time in the 11th century. The provosts replaced the viscounts wherever the viscounty had not become a fief, and

¹ Where, however, the head-master, though technically subordinate to the provost, is the effective head of the school.

² Thus in a register of the Châtelet of Paris in the 14th century, we read: "à Paris est la prévôté de Paris et celle des marchands."

it is possible that in creating them the Crown was imitating the ecclesiastical organization in which the provost figured, notably in the chapters. The royal provosts had at first a double character. In the first place they fulfilled all the functions which answered locally to the royal power. They collected all the revenues of the domain and all the taxes and dues payable to the king within the limits of their jurisdiction. Doubtless, too, they had certain military functions, being charged with the duty of calling out certain contingents for the royal service; they survived until the end of the *ancien régime* certain military provosts *prévôts d'épée* (provosts of the sword) who were replaced in the administration of justice by a lieutenant. Finally, the provosts administered justice, though certainly their competence in this matter was restricted. They had no jurisdiction over noblemen, or over feudal tenants (*hommes de fief*), who claimed the jurisdiction of the court of their over-lord, where they were judged by their peers—the other vassals of the same lord. Neither had they jurisdiction over the open country, the *plat pays*, where this belonged to local *seigneurs*; and even in the towns over which they were set their jurisdiction was often limited by that of the municipal courts established for the benefit of the burgesses. The second characteristic of the old provosts was that their office was farmed for a limited time to the highest bidder. It was simply an application of the system of farming the taxes. The provost thus received the speculative right to collect the revenues of the royal domain in the district under his jurisdiction; this was his principal concern, and his judicial functions were merely accessory. By these short appointments the Crown guaranteed itself against another danger: the possible conversion by the functionary of the function into a property. Very early, however, certain provostships were bestowed *en garde*, i.e. the provost had to account to the king for all he collected. The *prévôts en ferme* were naturally a source of abuses and oppression, the former seeking to make the most of the concession he had bought. Naturally, too, the people complained. From Joinville we learn how under St Louis the provostship of Paris became a *prévôté en garde*. At the death of Louis XI. the *prévôts en ferme* were still numerous and provoked a remonstrance from the States-general of 1484. Their suppression was promised by Charles VIII. in 1493, but they are again referred to in the *grande ordonnance* of 1498. They disappeared in the 16th century, by which time the provosts become regular officials, their office being purchasable.

Other transformations had previously taken place. The creation of the royal *baillis* reduced the provosts to a subaltern rank. Each *bailli* had in his district a certain number of provosts, who became his inferiors in the official hierarchy. When appeals were instituted (and this was one of the earliest instances of their introduction) the provost, the sphere of whose competency was limited, was subject to an appeal to the *bailli*, though his judgment had hitherto been without appeal. Moreover, in the 14th century they had ceased to collect the revenues of the royal domain, except where the *prévôté* was *en ferme*, and royal collectors (*receveurs royaux*) had been appointed for this purpose. The summoning of the feudal contingents, the *ban* and *arrière-ban*, had passed into the hands of the *baillis*. Thus the provosts were left for their sole function as inferior judges for non-nobles, the appeals from their sentences going to the *baillis*, who also had jurisdiction in the first instance over actions brought against nobles and in cases reserved for the crown judges (*cas royaux*). This corresponded to a principle which had also applied in the chief feudal courts in the 13th and 14th centuries, where a distinction was made between judicial acts which could be performed *en prévôté*, and those which had to be performed in a solemn assize (*assise*); this did not, however, always imply the existence of a superior and an inferior official, a provost and a *bailli*.

The provost in the exercise of his legal functions sat alone as judge, and he alone exercised the judicial authority at his tribunal; but he had to consult with certain lawyers (*avocats* or *procureurs*) chosen by himself, whom, to use the technical phrase, he "summoned to his council" (*appelait à son conseil*). In 1578 official counsellors (*conseillers-magistrats*) were created, but

were suppressed by the *ordonnance* of Blois of 1579. The office was restored in 1600 by a simple decree of the royal council, but it was opposed by the parlements, and it seems to have been conferred in but few cases.

The "provosts of the marshals of France," mentioned above, were non-legal officials (*officiers de la robe courte*) forming part of the body of the *maréchaussée* which was under the *ancien régime* what the *gendarmérie* was after the Revolution. Their original function was to judge offences committed by persons following the army, but in the course of the 14th and 15th centuries they acquired the right of judging certain crimes and misdemeanours, by whomsoever committed. They became stationary, with fixed spheres of authority, and the offences falling within their competency came to be called *cas prévôtaux*. These were, the worst crimes of violence, and all crimes and misdemeanours committed by old offenders (*repris de justice*), who were familiarly known as the *gibier des prévôts des maréchaux* (gaol-birds). Theirs was really a kind of military jurisdiction, from which there was no appeal; but the provost was bound to associate with himself a certain number of ordinary judges or graduates in law. The provost of the marshals did not himself judge what was a *cas prévôtal*; this had in each case to be decided by the nearest *bailliage* or presidial court. The presidial judges also dealt with *cas prévôtaux* in concurrence with the provosts of the marshals.

(J. P. E.)

PROW, the fore-part of a ship, the stem and its surrounding parts, hence used like "keel," by metonymy, of the ship itself. It was in old naval parlance applied to the battery of guns placed in the fore gun-deck. The Fr. *proue* and cognate forms (Ital. *prua*, Port. and Span. *proa*, of which the English is an adaptation) represent Lat. *prora*, itself adapted from Gr. *πρόρα*, formed from *πρό*, before, in front. From this word must be distinguished an obsolete "prow," brave, valiant, now only surviving in "prowess," and representing O. Fr. *prou*, mod. *preux*, from the first part of Lat. *prodesse*, to be profitable; the same source gives "proud."

PROXY (short for "procuracy"), a term denoting either (1) a person who is authorized to stand in place of another, (2) the legal instrument by which the authority is conferred. Proxies are now principally employed for certain voting purposes. A proxy may in law be either general or special. A general proxy authorizes the person to whom it is entrusted to exercise a general discretion throughout the matter in hand, while a special proxy limits the authority to some special proposal or resolution. Formerly a peer could give his vote in the British parliament by proxy, by getting another peer to vote for him in his absence, temporal peers only being privileged to vote for temporal, and spiritual peers for spiritual. This voting by proxy in the House of Lords was an ancient custom, often abused. In Charles II.'s reign the duke of Buckingham used to bring twenty proxies in his pocket, and the result was that it was ordered that no peer should bring more than two. In 1830 to 1867 inclusive proxies were only called seventy-three times; and on the 31st of March 1868, on the recommendation of a committee, a new standing order was adopted by which the practice of calling for proxies on a division was discontinued. In English bankruptcy proceedings creditors may vote by proxy, and every instrument of proxy, which may be either general or special, is issued either by the official receiver or trustee. Under the Bankruptcy Act of 1869 very great abuses of the system of proxies arose (see BANKRUPTCY), and were investigated by a select committee of the House of Commons. The committee recommended the abolition of general proxies; and though their recommendation was not carried out, the Bankruptcy Acts of 1883 and 1890 put considerable restrictions on the use of general proxies. A shareholder in a limited liability company may vote by proxy, and regulations to that effect prescribing the requirements, are usually embodied in the articles of association. A proxy to vote at a meeting must, by the Stamp Act 1870, bear a penny stamp. In the United States, proxies are further used for voting purposes in political conventions.

In the early practice of the admiralty courts in England a

proxy was the authority by which the proctor or advocate appeared for either party to a suit. In the ecclesiastical courts a proxy is the warrant empowering a proctor to act for the party to a suit. Two proxies are usually executed, one authorizing the proctor to institute, the other to withdraw, proceedings. They are signed by the parties, attested by two witnesses, and deposited in the registry of the court (Phillimore, *Ecclesiastical Law*). In the convocations of the Church of England those who are absent are allowed to vote by proxy. "Proxies," or "procurations," were also by the canon law certain sums of money paid yearly by parish priests to the bishops or archdeacons *ratione visitationis*; originally the visitor demanded a proportion of meat and drink for his refreshment, and afterwards this was turned into a money "procuration"—*ad procurandum cibum et potum*. Marriage by proxy or deputy was a custom recognized either for reasons of state or ceremonial.

PRUDENTIUS, AURELIUS CLEMENS (348-c. 410), the most remarkable of the earlier Christian poets in the West, was probably born at Tarraco, though Saragossa and Calagurris have also been claimed as his birthplace. The meagre autobiographical preface, which he affixed to the complete edition of his works when he was fifty-seven years old, makes it clear that he received a liberal education—being of noble family—practised as a lawyer and entered official life, and finally held some high office under Theodosius. At the age of fifty-seven he retired to a monastery, but died shortly afterwards.

Bentley calls Prudentius "the Horace and Virgil of the Christians," but his diction is stilted and his metre often faulty. The list of his works given in the preface mentions the hymns, poems against the Priscillianists and against Symmachus and *Peristephanon*. The *Diptychon* or *Dittochaon* is not mentioned. The twelve hymns of the *Cathemerinon liber* ("Daily Round") consist of six for daily use, five for festivals, and one intended for every hour of the day. Prudentius shows Ambrose as his master here, but gives to Ambrose's mystic symbolism much clearer expression. The *Apotheosis* and *Hamartigenia* are polemic, the first against the disclaimers of the divinity of Christ, the latter against the gnostic dualism of Marcion and his followers. In them Tertullian is the source of inspiration. Of more historical interest are the two books *Contra Symmachum*, of 658 and 1131 hexameter verses respectively, the first attacking the pagan gods, the second directed against the petition of Symmachus to the emperor for the restoration of the altar and statue of Victory which Gratian had cast down. The *Peristephanon* consists of fourteen hymns to martyrs. These were mostly Spanish, but some were suggested to Prudentius by sacred images in churches or by the inscriptions of Damasus. This book, with the *Cathemerinon liber* and the *Psychomachia*, was among the most widely read books of the middle ages. Its influence on the iconography of medieval art was great. The *Psychomachia* is aesthetically inferior, but had the greatest influence of all of Prudentius's writings. In it he depicts the struggle of Christendom with paganism under the allegory of a struggle between the Christian virtues and the pagan vices. The *Dittochaon* is a series of quatrains, probably intended to explain forty-nine pictures of a basilica. The work is more interesting for archaeology than for literature.

Prudentius's works were published by Giselin at Antwerp in 1564, and by F. Arevalo at Rome in 1788, with complete commentary. This last is the edition reprinted in J. P. Migne's *Patrologia Latina*, vols. lix.-lx. (Paris, 1847). More recent editions are by Obbarius (Tübingen, 1845) and A. Dressel (Leipzig, 1886), while a critical edition has been undertaken by J. Bergmann.

See also J. Bergmann, *Lexicon prudentianum*, fasc. i. [a-ascendo] (Upsala, 1894); M. Schanz, *Gesch. d. röm. Lit.* (Munich, 1904); A. Ebert, *Allgem. Gesch. d. Lit. des Mittelalters*, vol. i. 2nd ed. Leipzig, 1889); M. Manitius, *Gesch. d. christl. lat. Poesie* (Stuttgart, 1891); T. R. Glover, *Life and Letters in the Fourth Century* (Cambridge, 1901); C. Brockhaus, *Aur. Prud. Clem. in seiner Bedeutung f. d. Kirche seiner Zeit* (Leipzig, 1872); A. Pnec, *Prudence; étude sur la poésie latine chrét. au IV^e siècle* (Paris, 1888); F. St John Thackeray, *Translations from Prudentius* (London, 1890); F. Maigret, *Le Poète chrétien Prudentius* (Paris, 1903); E. O. Winstedt, "The Double Recension in the Poems of Prudentius," *The Classical Review*, vol. xvii. (1903).

PRUD'HON, PIERRE (1758-1823), French painter, born at Cluny on the 4th of April 1758, was the third son of a mason. The monks of the abbey undertook his education, and by the aid of the bishop of Mâcon he was placed with Devosges, director of the art school at Dijon. In 1778 Prud'hon went to Paris armed with a letter to Wille, the celebrated engraver, and three years later he obtained the triennial prize of the states of Burgundy, which enabled him to go to Rome, where he became intimate with Canova. He returned to Paris in 1787, and led for some time a precarious existence. The illustrations which he executed for the *Daphnis and Chloe* published by Didot brought him into notice, and his reputation was extended by the success of his decorations in the Hôtel de Landry (now Rothschild), his ceiling painting of "Truth and Wisdom" for Versailles (Louvre), and of "Diana and Jupiter" for the Gallery of Antiquities in the Louvre. In 1808 he exhibited "Crime pursued by Vengeance and Justice" (Louvre, engraved by Royer which had been commissioned for the assize courts, and "Psyche carried off by Zephyrs" (engraved by Massard). These two remarkable compositions brought Prud'hon the Legion of Honour; and in 1816 he entered the Institute. Easy as to fortune, and consoled for the misery of his marriage by the devoted care of his excellent and charming pupil, Mlle Mayer, Prud'hon's situation seemed enviable; but Mlle Mayer's tragical suicide on the 26th of May 1821 brought ruin to his home, and two years later (Feb. 16, 1823) Prud'hon followed her to the grave. Mlle Mayer (1778-1821) was his ablest pupil. Her "Abandoned Mother" and "Happy Mother" are in the Louvre.

Voiart, "Notice historique de la vie et œuvres de P. Prud'hon," in *Arch. de l'art français*; Qu. de Quincy, *Discours prononcé sur la tombe de Prud'hon*, Fév. 1823; Eugène Delacroix, *Rev. des deux mondes*, 1846; Charles Blanc, *Hist. des peintres français*.

PRUNE (adapted in various forms, e.g. *prunne*, *proyne*, &c., from Fr. *prune*, Med. Lat. *pruna*, Lat. *prunum*, Gr. *πρόνιον*, earlier *πρόνιον*, plum), the name generally given to the fruit of various species of plums, dried, and used either stewed as a dish or plain as a dessert fruit. The finest dessert prunes, known as "French plums," are produced from the St Julien plum-tree and are dried and exported from the valley of the Loire in France. California now produces a fine quality of "prune." In scientific nomenclature, *Prunus* is the name of a genus of rosaceous trees, the type of the tribe *prunaceae*, of which the plum, apricot, peach, cherry, &c., are species (see further under PLUM). From this word must be distinguished "to prune," (1) to cut or trim superfluous growth from a shrub or tree in order to encourage fresh growth and bring into regular form, &c., and (2) to trim or dress the feathers with the bill, used of a bird "preening" itself. In the first sense the word is an adaptation (16th century) of the Old French *proigner*, the second sense appears in the end of the 14th century but is not found in French.

PRURITUS, an ailment characterized by intense itching of the surface of the body. It may occur in connexion with other morbid conditions, such as jaundice, diabetes, digestive disorders, &c., or as the result of the irritation produced by skin parasites. The most serious form is *pruritus senilis*, which affects old persons, and is often a cause of great suffering, depriving the patient of sleep. In such cases it is probably due to atrophic changes in the skin. No eruption is visible, except such marks as are produced by scratching. The treatment consists in the removal of any apparent cause, and measures to strengthen the system, such as the use of quinine, iron, &c. Soothing lotions composed of solutions of alkalis conjoined with chloral, opium, hydrocyanic acid, &c., may be applied to the affected skin at bedtime.

PRUSSIA (Ger. *Preussen*; Lat. *Borussia*), a kingdom of Germany, and the largest, most populous and most important state of the German Empire. (For map see GERMANY.) It is bounded on the N. by the Baltic, Mecklenburg, Denmark and the North Sea, on the E. by Russia, on the S. by Austria, the kingdom of Saxony, the Thuringian states, Bavaria and

Hesse-Darmstadt, on the W. by Alsace-Lorraine, Luxemburg, Belgium and the Netherlands. Its frontiers have a circuit of about 4750 m., and with the exception of the enclaves Oldenburg, Mecklenburg, Brunswick and other small German states, and certain small appurtenances, such as Hohenzollern, in the south of Württemberg, it forms a tolerably compact mass of territory, and occupies almost the whole of northern Germany. Its longest axis is from S.W. to N.E. With the exception of the sea on the north and the mountain-barrier on the south-east, the frontiers are political rather than geographical. The total area of the monarchy is 134,622 sq. m. and comprises almost two-thirds of the entire extent of the German Empire. Its kernel is the mark of Brandenburg, round which the rest of the state has been gradually built up.

Physical Features.—Fully three-fifths of Prussia belong to the great north European plain and may be generally characterized as lowlands. The plain is much wider on the east, where only the southern margin of Prussia is mountainous, than on the west, where the Hanoverian hills approach to within less than 100 m. of the sea. A line drawn from Düsseldorf through Halle to Breslau would, roughly speaking, divide the flat part of the country from the hilly districts. In the south-east Prussia is separated from Austria and Bohemia by the Sudetic chain, which begins at the valley of the Oder and extends thence towards the north-west. This chain includes the Riesen Gebirge, with the highest mountain in Prussia (Schneekoppe), and subsides gradually in the hills of Lusatia. The Harz Mountains, however, beyond the Saxon plain, follow the same general direction and may be regarded as a detached continuation of the system. To the south of the Harz the Prussian frontier intersects the northern part of the Thuringian Forest, which is also prolonged towards the north-west by the Weser Gebirge and the Teutoburger Wald. The south-west of Prussia is occupied by the plateau of the lower Rhine, including on the left bank the Hunsrück and the Eifel, and on the right the Taunus, the Westerwald and the Sauerland. Between the lower Rhenish and Thuringian systems are interposed the Vogelsberg, the Rhön, and other hills belonging to the Triassic system of the upper Rhine. The Silesian Mountains are composed chiefly of granite, gneiss and schists, while the Harz and the lower Rhenish plateau are mainly of Devonian and Silurian formation. To the north of the Sauerland is the important carboniferous system of the Ruhr, and there are also extensive coalfields in Silesia. With the exception of the Danube Prussia is traversed by all the chief rivers of Germany, comprising almost the entire course of the Oder and the Weser. Nearly the whole of the German coast-line belongs to Prussia, and it possesses all the important seaports (see also GERMANY) except Hamburg, Bremen and Lübeck.

Climate.—The climate of Prussia may be described as moderate, and is generally healthy. The greatest extremes of temperature are found between the east and west, the mean annual temperature in the bleak and exposed provinces of the north-east being about 44° F., while that of the sheltered valley of the Rhine is 6° higher. In winter the respective means are 26° and 35°; in summer the difference is not above 2° to 4°. In Prussia as a whole the thermometer ranges from 100° to 130°, but these extremes are rarely reached. The average annual rainfall is about 21 in.; it is highest in the hilly district on the west (34 in.) and on the north-west coast (30 to 32 in.), and lowest (16 in.) in the inland parts of the eastern provinces.

Population.—The following schedule shows the area and population of the whole kingdom and of each of its fourteen provinces on the 1st of December 1900, and the 31st of December 1905.

Provinces.	Area in Eng. sq. m.	Pop., 1900.	Pop., 1905.
East Prussia	14,284	1,996,626	2,030,176
West Prussia	9,859	1,563,658	1,641,746
Berlin	29	1,888,848	2,040,148
Brandenburg	15,382	3,108,554	3,531,906
Pomerania	11,620	1,634,832	1,684,326
Silesia	15,568	4,668,857	4,942,611
Posen	11,186	1,887,275	1,986,637
Saxony	9,751	2,832,616	2,979,221
Schleswig-Holstein	7,338	1,387,968	1,504,248
Hanover	14,870	2,590,939	2,759,544
Westphalia	7,803	3,187,777	3,618,090
Hesse Nassau	6,062	1,897,981	2,070,052
Rhineland	10,423	5,759,798	6,436,337
Hohenzollern	441	66,780	68,282
	134,616	34,472,509	37,293,324

¹ Including Heligoland.

The increase of population proceeds most rapidly, as would be expected, in Berlin, and next follow Westphalia, the Rhineland, Brandenburg and Saxony, while it is weakest in Hohenzollern, Pomerania and East Prussia. The population is densest in the mining and manufacturing district of the Rhine, which is closely followed by the coal regions of Silesia and parts of Saxony and Westphalia. Both the birth-rate and the death-rate show a tendency to diminish. (For statistical tables under this head, see GERMANY.) In Prussia, the annual increase in the urban population is about seven times as great as that in the rural communities. In 1905 Prussia contained twenty-two towns each with upwards of 100,000 inhabitants. The annual rate of suicide in Prussia is high, and among German states is only exceeded in the kingdom of Saxony. Divided according to nationalities (by speech), the population of Prussia includes roughly 31,000,000 Germans, over 3,000,000 Poles (in the eastern provinces), 107,000 Lithuanians (in the north-east), 137,000 Danes (in Schleswig-Holstein), 65,000 Wends (in Brandenburg and Silesia), 25,000 Czechs (in Silesia) and 78,000 Walloons (near the Belgian frontier). In the rural districts of Posen and in parts of Silesia the Poles form the predominant element of the population.

Communication.—With most internal means of communication Prussia is well provided. Hardly any of its excellent highroads existed in the time of Frederick the Great, and many of them date from the Napoleonic era. The first Prussian railway was laid in 1838, but the railway system did not receive its full development until the events of 1866 removed the obstacles placed in the way by Hanover. Most of the lines were laid by private companies, and the government confined itself to establishing lines in districts not likely to attract private capital. In 1879, however, a measure was passed authorizing the acquisition by the state of the private railways, and in 1884 nine-tenths of the 13,800 m. of railway in Prussia were in the hands of government. The proportion of railway mileage in Prussia (5 m. per 10,000 inhabitants) is nearly as high as in Great Britain, but the traffic is much less. Between 1880 and 1886 the state-owned lines of railway increased by 9240 m., the increase being principally due to the policy of buying up private lines; and since 1886 there has been a further increase. In 1903 the state lines amounted to a total of 18,520 m., and the private lines to 1248 m. The former total includes lines in Hesse-Darmstadt, the railways of this grand duchy having been incorporated with the Prussian railways in 1896. The building of the railways in Prussia has in almost every case been influenced by military requirements; and this applies also to the making of private lines. The most important trunk line of Prussia is that which enters the western frontier at Herbesthal, and runs through Cologne, Düsseldorf, Hanover, Berlin, Dirschau and Königsberg, and leaves the eastern boundary at Eydtkuhnen for St Petersburg. Generally speaking, the principal lines of the country either radiate from Berlin or run alongside the frontiers and boundaries. To the former category belong the lines which connect the capital with Hamburg and Kiel, with Stettin, with Danzig and Königsberg, with Posen and Breslau (dividing at Frankfort-on-Oder), with Dresden, with Leipzig and Bavaria, with Frankfort-on-Main via Halle and Erfurt, with Coblenz via Cassel, and with Cologne via Magdeburg and Brunswick. The second category embraces lines from Hamburg to Stettin, from Stettin to Posen and Breslau, and from Breslau to Halle; the ring is again taken up at Frankfort-on-Main, and continues up the Rhine (on both banks) to Cologne, and thence through Münster and Bremen to Hamburg. Besides these there are two other important lines, one connecting Hamburg with Frankfort-on-Main via Hanover and Cassel, the other linking Hanover with Halle.

Prussia possesses also an extensive system of natural and artificial waterways. In the period 1880–1893 the Prussian Government spent no less than £11,677,750 upon the maintenance and construction of locks, canals, canal buildings, bridges, roadways, &c. Besides this there was a special vote of £6,197,600 for the construction of the Dortmund-Ems Canal and the improvement of the navigation of the Oder, Vistula, Spree and other waterways in Brandenburg. The most important of the canals are the North Sea and Baltic Canal (officially the Kaiser Wilhelm Canal), the Elbe-Trave Canal (to give Lübeck access to the Elbe), and the Dortmund-Ems Canal, and its continuation, the Dortmund-Rhine Canal (see further, GERMANY). The largest ship-owning ports are Flensburg, Stettin, Kiel, Rostock and Danzig; and Geestemünde owns the largest deep-sea fishing fleet.

Agriculture.—Of the total area of cultivable land in the German Empire fully 66% belongs to Prussia. About 29% of the soil of Prussia consists of good loam or clay, 32% is mediocre or of loam and sand mixed, 31% is predominantly sandy, and 6% is occupied by bogs and marshes. The north-eastern provinces contain a high proportion of poor soil, and in the north-west occur large tracts of heath and moor. The reclaimed marshlands in both districts, as well as the soil in the neighbourhood of the rivers, are usually very fertile, and tracts of fruitful ground are found in the valleys of the Rhine and its affluents and in the plain around Magdeburg, the so-called *Böhrde*. The most fertile Prussian province is Saxony, while the least productive are East and West

Prussia. The principal crop in Prussia is rye, of which the ordinary bread of the country is made; it grows in all parts of the kingdom, especially in the north and east, and occupies about one-fourth of the whole tilled surface. Oats occupy an area equal to about half that devoted to rye, and are also grown most extensively in the north-eastern districts. Wheat, which is chiefly cultivated in the south and west, does not cover more than a fourth as much ground as rye. Barley is most largely grown in Saxony and Silesia. Other grain crops are spelt (chiefly on the Rhine), buckwheat (Hanover and Schleswig-Holstein) and millet; maize is grown for fodder in some districts. The produce of grain does not cover the consumption and is supplemented by imports of rye and other cereals from Russia and Holland. Potatoes, used both as food and for the distillation of spirits, are cultivated over nearly as large an area as rye and are especially predominant in the eastern provinces. The common beet is extensively grown for the production of sugar in the provinces of Saxony, Hanover, Silesia, Pomerania and Brandenburg. Flax and hemp occupy considerable areas in East Prussia, Silesia and Hanover, while hops are raised chiefly in Posen and Saxony. The cultivation of rape-seed for oil has fallen off since the use of petroleum has become general. The tobacco of Silesia, Brandenburg, Hanover and the Rhine province is inferior to that of Germany; the annual value of Prussian-grown tobacco is about £500,000, or one-fourth of the total produce of the empire. Of the total cultivated area less than 5% is divided into farms of less than 5 acres each, about 33% amongst farms ranging from 5 to 50 acres, 32.01% amongst farms ranging from 50 to 250 acres, and the rest amongst farms exceeding 250 acres. The provinces in which large estates (up to 2500 acres and more) are the rule, are Pomerania, Posen, Silesia, East Prussia, Brandenburg, West Prussia and Saxony, in the order named. The estates of the old landed gentry (*Rittergüter*) of Prussia, taking the estates above 500 acres each, aggregate in all some 13,400,000 acres. Small estates (peasant holdings) prevail principally in the Rhine province, Hesse-Nassau and Westphalia, and to some extent also in Hanover, Silesia and Saxony, but large peasant holdings (50 to 250 acres) exist only in Schleswig-Holstein, Hanover, East Prussia, Westphalia, Saxony and Brandenburg. Notwithstanding the continuous decline in prices, and other drawbacks from which agriculture has suffered throughout Europe, the Prussian farmers have on the whole fairly well maintained their position, owing mainly to the fact that they have been both eager and skilful in availing themselves of the opportunities offered by the progress of agricultural knowledge. One of the latest departures in this field has been the establishment of central stations for the distribution of electric power to the estates in its neighbourhood, the power to be used for driving both fixed and movable machinery (mills, chaff-cutters, threshing-machines, ploughs, &c.), for lighting buildings and houses, for cooking and heating, and on large estates for giving signals and conveying orders. The cultivation of the beetroot for sugar has had a far-reaching effect upon Prussian agriculture, especially in the provinces of Saxony, Silesia, Posen, Hanover, West Prussia, Pomerania, Brandenburg, the Rhine province, and other parts of the kingdom, where the beetroot is extensively cultivated. Owing to the deep cultivation of the soil and the incessant hoeing which the beet crop requires, the three or four crops which follow it are invariably good, and the liability to failure of the immediately succeeding crop is reduced to a minimum. Moreover, the fiscal policy of the Prussian government has been of first-rate assistance to the Prussian farmer. Hand in hand with the cultivation of the beetroot has gone the cultivation of barley and chicory, crops of scarcely inferior value from the cultivator's point of view. Barley is grown on more than 11½ million acres. The Prussian province of Saxony produces one-half of the total quantity of chicory yielded every year throughout the empire; the principal centres for its manufacture in Prussia are Magdeburg, Berlin and Breslau.

Livestock.—The province of East Prussia, with the principal government stud of Trakehnen, is the headquarters of horse-rearing, and contains the greatest number of horses both relatively and absolutely. The horses bred there are generally suitable for the lighter kind of work only, and are in great request for military purposes. Horses of a stouter type are bred in Schleswig-Holstein and on the Rhine, but heavy draught horses have to be imported from France, Holland, Belgium and Denmark. The best cattle are reared in the maritime provinces, whence, as from the marshy lowlands of Hanover, they are exported in large numbers to England.

In the matter of freights the government renders material assistance to the Prussian farmer. As the state owns the railways, it carries agricultural produce, especially such as is destined for export, at lower preferential rates.

Forests.—Prussia contains a greater proportion of woodland (23%) than any other large country in the south or west of Europe (France 17%, Italy 12%, Great Britain 3%), though not so large a proportion as Russia, Austria and some of the minor German states. The most extensive forests are in East and West Prussia, Silesia, and Brandenburg, where coniferous trees prevail, and in the Rhenish and Hessian districts, where oaks and beeches are the most prominent growths. The north-west is almost entirely destitute of timber, and peat is there used universally as fuel. The

government forests cover about 6,000,000 acres, or upwards of one-fourth of the whole, and are admirably managed, bringing in an annual revenue of 1¼ millions sterling. The state also controls the management of forests in private possession, and exerts itself to secure the planting of waste lands.

Viticulture.—The principal wine-growing districts of Prussia are the Rheingau and the Rhine provinces, though wine is also produced in Silesia, Westphalia and a few other districts. The valleys of the Nahe, Saar, Moselle and Ahr all produce excellent wine. The Prussian state owns several vineyards in the Rhine district. German vine-growers have suffered, in common with vine-growers in other countries of Europe, from the *Oidium tuckeri* and the *Phylloxera*, and the government has spent large sums of money in endeavouring to arrest the ravages caused.

Fisheries.—The fisheries on the Baltic Sea and its haffs, and on the North Sea, are important. In the former the take consists mainly of herrings, flat fish, salmon, mackerel and eels, while the chief objects of the latter are cod and oysters. Inland fishery has been encouraged by the foundation of numerous piscicultural establishments and by the enactment of close-time laws. Carp, perch, pike and salmon, the last-named especially in the Rhine, are the principal varieties; sturgeon are taken in the Elbe and Oder, and the lakes of East Prussia swarm with bream and lampreys. Game of various kinds abounds in different parts of Prussia, and the lakes are frequented by large flocks of waterfowl.

Mining and Metal Industries.—Prussia is the largest producer of coal, zinc, salt, lead and copper amongst the states of the German Empire, though in respect of iron she comes second to Alsace-Lorraine. Of the aggregate German output of coal Prussia supplies over 93%, viz. the huge total of 101,966,158 tons, valued at £43,912,500 in 1900, as compared with some 47,000,000 tons in 1882, representing an increase of about 117%, and of this the province of Westphalia produces the largest quantity. Next comes the Rhine province, that is, the Saar, Aachen, Düsseldorf and Roer coal-fields; then Silesia. An extremely important rôle is played in the coal industry of Prussia by the Rhenish-Westphalian Coal Syndicate, which has its headquarters at Essen, and which from the bulk of its output (about 40% of the total German output) has succeeded in regulating the production and price of the coalfields generally. Out of a total output of lignite for the entire German Empire of 40,498,019 tons in 1900, Prussia yielded no less than 84%, or a total of 34,007,542 tons, valued at £4,012,900, showing an annual increase of over 24 million tons and of 3½ millions sterling since 1882. Almost all the zinc produced in Germany comes out of the Silesian mines. The chief iron-producing regions are the Rhine province, Westphalia, Hesse-Nassau and Silesia. But in the production of lead and manganese Prussia enjoys almost an unchallenged monopoly. Salt is mined principally in the province of Saxony (Stassfurt, Aschersleben, Erfurt, Halle, Merseburg, Sangerhausen), the kali salts near Magdeburg and Glauber salts in the Rhine province and Hesse-Nassau. Iron is worked principally in the districts of Arnsberg, Düsseldorf, Oppeln in Silesia, Treves and Coblenz, and zinc for the most part near Oppeln in Silesia; lead and silver near Aachen, Oppeln and Wiesbaden, and sulphuric acid in all the mining districts, as well as near Potsdam, Breslau, Magdeburg and Merseburg. Petroleum is extracted to a limited extent at a couple of places in the province of Hanover. Down to 1899, in which year the monopoly was bought out by the Prussian government, 150 to 250 tons of amber were mined in East Prussia. A little is also collected on the coast near Pillau.

Industrial Development.—During the last quarter of the 19th century Prussia developed into a great manufacturing country. Among the causes which have been mainly instrumental in fostering the industrial development in Prussia are the fostering care of the government (at once energetic, comprehensive and watchful), co-operation and organization, which has been immensely facilitated by the habits of prompt obedience and order learnt in the course of the military training; the generally high intellectual level and technical and artistic skill of the workmen, due in part to the enforcement of sound elementary education and in part to the excellent technical high schools, trades "continuation schools," and hosts of special schools in which the arts and crafts are thoroughly and systematically taught; the use made of scientific discoveries and the power of taking advantage of scientific progress generally; the national aptitude for giving conscientious attention to minutiae, and for thoroughness and mastery of detail; the extensive employment of commercial travellers, having command of languages, in all parts of the world; and an earnest desire to find out and meet the wants and tastes of customers. Moreover, the social and economic conditions of the people have been in their favour. Wages have on the whole been lower than, for example, in England, though since 1896 they have shown a strong upward tendency, and the standard of comfort, and even in many cases the standard of living, has been lower. Litigation, too, is more expeditious and less costly. But the Prussian manufacturer has derived no small measure of advantage from the fact that he came into the field somewhat later than his foreign rivals. He has been enabled to utilize their experience, to profit from their drawbacks, faults and deficiencies, and to make a clean start in the light of this valuable acquired knowledge. His interests have also been materially

promoted by the commercial and fiscal policies of his government. The chief industrial districts are, of course, those which yield coal, with, in addition, the great cities—Berlin, Magdeburg, Hanover, Breslau, Görlitz, Stettin, Essen, Dortmund, Elberfeld-Barmen, Düsseldorf, Cologne, Aix-la-Chapelle, Crefeld, Halle, Hanover, Frankfurt-on-Main, Saarbrücken, Höchst, Solingen, Remscheid, Hagen, Königsberg, Danzig and many others. The iron and metal industries, especially the making of machinery, electrical plant, tramway plant, and the production of articles in wrought copper and brass, rank in the forefront. In these branches Berlin, and more lately its suburbs, as well as Magdeburg and Cologne, have played an active rôle, though the old centres of the metallurgical and iron and steel industries in the Rhine province and Westphalia have also expanded in an extraordinary degree. The growth of the chemical industries, which are essentially a German speciality, must also be mentioned in the front rank. The branches in which this supremacy stands unrivalled are those which produce aniline dyes, artificial indigo, illuminants (acetylene gas, Welsbach mantles, &c.), explosives, various chemical salts, pharmaceutical preparations, cellulose, glycerine, artificial (chemical) manures, and perfumes.¹ A third branch of industry in which German genius has won triumphs of the highest kind is shipbuilding.

Constitution.—The present constitution of Prussia was framed by the government of King Frederick William IV., with the co-operation of a constituent assembly, and was proclaimed on the 31st of January 1850. It consists of an hereditary monarchy with two houses of parliament and was subsequently modified by various enactments, notably that of the 12th of October 1854, reconstituting the upper chamber. The constitution affirms the legal equality of all citizens in the eye of the law, provides for universal military service, and guarantees the personal liberty of the subject, the security of property, immunity from domiciliary visits, the inviolability of letters, toleration of religious sects, freedom of the press, the right of association and public meetings, and liberty of migration.

The monarchy is hereditary in the male line of the house of Hohenzollern, and follows the custom of primogeniture. The king alone exercises the executive power, has the supreme command of the army, and is head of the Church, but shares the legislative power with his parliament. He appoints and discharges the ministers and other officials of the Crown, summons and dissolves parliament, possesses the right of pardon and mitigation of punishment, declares war and concludes peace, confers orders and titles and conducts the foreign policy of the country, though this prerogative has now, constitutionally speaking, passed from the king of Prussia to the German emperor. He is held to be irresponsible for his public actions, and his decrees require the countersign of a minister, whose responsibility, however, is not very clearly defined. The national tradition and feeling lend the Crown considerable power not formulated in the constitution, and the king is permitted to bring his personal influence to bear upon parliament in a way quite at variance with the English conception of a constitutional monarch. The annual civil list of the king of Prussia amounts to £770,554.

The legislative assembly or *Landtag*, consists of two chambers, which are convoked annually at the same time but meet separately. The right of proposing new measures belongs equally to the king and each of the chambers, but the consent of all three is necessary before a measure can pass into law. The chambers have control of the finances and possess the right of voting or refusing taxes. Financial questions are first discussed in the lower house, and the upper house can accept or reject the annual budget only *en bloc*. All measures are passed by an absolute majority, but those affecting the constitution must be submitted to a second vote after an interval of at least twenty-one days. Members may not be called to account for their parliamentary utterances except by the chamber in which they sit. No one may at the same time be a member of both chambers. The ministers of the Crown have access to both chambers and may speak at any time, but they do not vote unless they are actually members. The sittings of both chambers are public.

The general scheme of government, though constitutional, is not exactly "parliamentary" in the English sense of the word, as the ministers are independent of party and need not necessarily represent the opinions of the parliamentary majority. The *Herrenhaus*, or house of peers, contains two classes of members, the hereditary and non-hereditary. The former consists of the adult princes of the house of Hohenzollern, the mediatised princes and counts of the old imperial nobility, and the heads of the great territorial nobility. The non-hereditary members are chosen for life by the king from the ranks of the rich landowners, manufacturers and men of general eminence, and representatives "presented" for the king's approval by the landowners of the eight old provinces, by the larger towns and by the universities. Every member of the *Herrenhaus* must be specially summoned by the king. The *Abgeordnetenhaus* or chamber of deputies, consists of 433 members, elected

for periods of five years by indirect suffrage, exercised by all male citizens who have reached the age of twenty-five and have not forfeited their communal rights. The original electors are arranged in three classes, according to the rate of taxes paid by them, in such a way that the gross amount of taxation is equal in each class. The country is accordingly divided into electoral districts, with the electors grouped in three categories, each of which selects a *Wahlmann* or electoral proxy, who exercises the direct suffrage. Members of the lower house must be thirty years old and in full possession of their civic rights. They receive a daily allowance (*Diäten*) of fifteen shillings during the sitting of the house, and travelling expenses.

The king exercises his executive functions through an irresponsible *Staatsrat*, or privy council, revived in 1884 after thirty years of inactivity, and by a nominally responsible cabinet or council of ministers (*Staats-Ministerium*). The latter consists of the president and minister of foreign affairs, and ministers of war, justice, finance, the interior, public worship and instruction, industry and commerce, public works and agriculture, domains and forests. Ministers conduct the affairs of their special departments independently, but meet in council for the discussion of general questions. They represent the executive in the houses of parliament and introduce the measures proposed by the Crown, but do not need to belong to either chamber. The affairs of the royal household and privy purse are entrusted to a special minister, who is not a member of the cabinet.

The Prussian governmental system is somewhat complicated by its relation to that of the empire. The king of Prussia is at the same time German emperor, and his prime minister is also the imperial chancellor. The ministries of war and foreign affairs practically coincide with those of the empire, and the custom-dues and the postal and telegraph service have also been transferred to the imperial government. Prussia has only seventeen votes in the federal council, or less than a third of the total number, but its influence is practically assured by the fact that the small northern states almost invariably vote with it. To the *Reichstag* Prussia sends more than half the members. The double parliamentary system works in some respects inconveniently, as the *Reichstag* and Prussian *Landtag* are often in session at the same time, and many persons are members of both. Where imperial and Prussian legislation come into conflict the latter must give way.

Local Government.—For administrative purposes Prussia is divided into fourteen *Provinzen* or provinces, *Regierungsbezirke* or governmental departments, *Stadtkreise* or urban districts (circles), and *Landkreise* or rural districts. The city of Berlin and the district of Hohenzollern form provinces by themselves. Recent legislation has aimed at the encouragement of local government and the decentralization of administrative authority by admitting lay or popularly elected members to a share in the administration alongside of the government officials. Certain branches of administration, such as the care of roads and the poor, have been handed over entirely to local authorities, while a share is allowed them in all. In the province the government is represented by the *Oberpräsident*, whose jurisdiction extends over all matters affecting more than one department. He is assisted by a council (*Provinzialrat*) consisting, besides himself as chairman, of one member appointed by government and five members elected by the provincial committee (*Provinzialausschuss*). The latter forms the permanent executive of the provincial diet (*Provinzial-Landtag*), which consists of deputies elected by the *kreise* or circles, and forms the chief provincial organ of local government. The *Regierungsbezirk* is solely a government division and is only indirectly represented in the scheme of local administration. The government authorities are the *Regierungs-Präsident*, who is at the head of the general internal administration of the department, and the *Regierung* or government board, which supervises ecclesiastical and educational affairs and exercises the function of the state in regard to the direct taxes and the domains and forests. The departmental president is also assisted by a *Bezirksrat* or district council, consisting of one official member and four others selected from inhabitants of the department by the provincial committee. Each *Landkreis* has a *Landrat*, an office which existed in the mark of Brandenburg as early as the 16th century. He is aided by the *Kreisausschuss*, or executive committee of the *Kreistag* (the diet of the circle). The *Landkreise* include towns having less than 25,000 inhabitants, rural communes (*Landgemeinden*) and manors (*Gutsbezirke*). *Stadtkreise* are towns with more than 25,000 inhabitants; they have each a town council (*Stadtverordnetenversammlung*) elected on a three-class property suffrage. The practical executive is entrusted to the magistracy (*Magistrat*), which usually consists of a burgomaster, a deputy burgomaster (both paid officials), several unpaid members, and, where necessary, a few other paid members. The unpaid members hold office for six years; the paid members are elected for twelve years, and their election requires ratification from the state.

Justice.—Down to the 1st of January 1900 (when the German civil code—*Bürgerliches Gesetzbuch*—was introduced) a threefold system of civil law had prevailed in Prussia, viz. the common law of Prussia (*Landrecht*), codified in 1794, in eastern and central

¹ See Dr Frederick Rose, *Chemical Instruction and Chemical Industries in Germany* (1901-1902), being Nos. 561 and 573 of the "Miscellaneous Series of British Diplomatic and Consular Reports."

Prussia, the German common law (*Gemeines deutsches Recht*) in Schleswig-Holstein, Hanover, and parts of the Rhine provinces, and the *Code Napoléon* generally on the Rhine and in Alsace-Lorraine. The *bürgerliches Gesetzbuch* has now put an end to the former anomalies. The criminal law was unified by the penal code (*Strafgesetzbuch*) of 1871 and the military penal code (*militär. Strafgesetzbuch*) of 1872. A new penal code, promulgated in 1850, did away with the old patrimonial or seigniorial jurisdiction, and the administration of justice is now wholly in the hands of government. The courts of lowest instance are the *Amtsgerichte*, in which sits a single judge, accompanied in penal cases by two *Schöffen* or lay assessors (a kind of jurymen, who vote with the judge). Cases of more importance are decided by the *Landgerichte* or county courts, in which the usual number of judges is three, while in important criminal cases a jury of twelve persons is generally empanelled. From the *Landgerichte* appeals may be made to the *Oberlandesgerichte* or provincial courts. The *Oberlandesgericht* at Berlin is named the *Kammergericht* and forms the final instance for summary convictions in Prussia, while all other cases may be taken to the supreme imperial court at Leipzig. The judges (*Richter*) are appointed and paid by the state, and hold office for life. After finishing his university career the student of law who wishes to become a judge or to practise as qualified counsel (*Rechtsanwalt*, barrister and solicitor in one) passes a government examination and becomes a *Referendarius*. He then spends at least four years in the practical work of his profession, after which he passes a second examination, and, if he has chosen the bench instead of the bar, becomes an *Assessor* and is eligible for the position of judge. A lawyer who has passed the necessary examinations may at any time quit the bar for the bench, and a judge is also at liberty to resign his position and enter upon private practice. In all criminal cases the prosecution is undertaken by government, which acts through *Staatsanwälte*, or directors of prosecutions, in the pay of the state.

Army.—The military organization of the monarchy dates from 1814 and provides that every man capable of bearing arms shall serve in the army for a certain number of years. The peace strength of the Prussian contingent of the imperial German army consisted, in 1905, of 20,646 officers (including surgeons), 448,365 men and 82,786 horses. There were also 2196 farriers and shoemiths. (For *Navy*, see GERMANY.)

Religion.—The centre of the kingdom is solidly Protestant, the proportion of Roman Catholics increasing towards east and west and reaching its maximum on the Rhine and in the Slavonic provinces. East Prussia, however, with the exception of Ermeland, is Protestant. The Roman Catholics greatly outnumber the Protestants in the Rhine provinces (3 to 1), Posen, Silesia and West Prussia. All religious bodies are granted freedom of worship, and civil rights are not conditional upon religious confession.

The Evangelical or Protestant State Church of Prussia consists as it now stands of a union of the Lutherans and Calvinists, effected under royal pressure in 1817. According to the king this was not a fusion of two faiths but an external union for mutual admission to the Eucharist and for the convenience of using the same liturgy, prepared under the royal superintendence. Those who were unable from conscientious scruples to join the union became Separatist or Old Lutherans and Old Calvinists, but their numbers were and are insignificant. The king is "summus episcopus" or supreme pontiff of the Church, and is represented in the exercise of his ecclesiastical functions by the minister of public worship and instruction. The highest authority for the ordinary management of the Church is the *Oberkirchenrat* or supreme church council at Berlin, which acts through provincial consistories and superintendents appointed by the Crown. Recent legislation has made an effort to encourage self-government and give a congregational character to the Church by the granting of a presbyterial constitution, with parish, diocesan, provincial and general synods. The clergy are appointed by the Crown, by the consistories, by private or municipal patronage, or by congregational election.

The hierarchy of the Roman Catholic Church in Prussia consists of two archbishops (Cologne, Gnesen-Posen) and ten bishops. The prince-bishop of Breslau and the bishops of Ermeland, Hildesheim and Osnabrück are directly under the pope, and the bishoprics of Fulda and Limburg are in the archiepiscopal diocese of Freiburg in Baden. The higher ecclesiastics receive payment from the state, and the annual appropriation appearing in the budget for the Roman Catholic Church is as high as that made for the State Church. All the Roman Catholic religious orders in Prussia have been suppressed except those occupied with attendance on the sick.

The relations of the state with the dissenting Christian sects, such as the Baptists, Mennonites and Moravian Brethren, are practically confined to granting them charters of incorporation which ensure them toleration. The Mennonites were formerly allowed to pay an extra tax in lieu of military service, which is inconsistent with their belief, but this privilege has been withdrawn. The Old Catholics number about 30,000, but do not seem to be increasing.

The Jews belong mainly to the urban population and form 20 to 30% of the inhabitants in some of the towns in the Slavonic

provinces. (For more exact details of the various religious creeds, see GERMANY.)

Education.—In Prussia education is compulsory, and the general level attained is very high. Every town or community must maintain a school, supported by local rates and under the supervision of the state. By the constitution of 1850, all persons are permitted to instruct, or to found teaching establishments, provided they can produce to the authorities satisfactory proofs of their moral, scientific and technical qualifications. Both public and private educational establishments are under the surveillance of the minister of public instruction, and all public teachers are regarded as servants of the state (*Staatsbeamte*). No compulsion exists in reference to a higher educational institution than primary schools. All children must attend school from their sixth to their fourteenth year. At the head of the administration stands the minister of public instruction and ecclesiastical affairs, to whom also the universities are directly subordinated. The higher (secondary) schools are supervised by provincial *Schulcollegia* or school boards, appointed by government, while the management of the elementary and private schools falls within the jurisdiction of the ordinary *Regierungen* or civil government. This is carried out through qualified school inspectors, frequently chosen from among the clergy.

The expenses of the primary schools (*Volksschulen*) are borne by the communes (*Gemeinden*), aided when necessary by subsidies from the state. The subjects of instruction are theology, reading, writing, spelling, arithmetic, the elements of geometry, history, geography and natural science, singing, drawing, sewing and gymnastics. All fees in the elementary schools are abolished. The number of illiterate recruits among those called upon each year to serve in the army affords a good test of the universality of elementary education. In 1899 the proportion of *Analphabeten*, or men unable to read or write, among the recruits levied was only 0.12%. The teachers for the elementary schools are trained in normal seminaries or colleges established and supervised by the state, and much has been done of late years to improve their position. In most of the larger towns the elementary schools are supplemented by middle schools (*Bürgerschulen*, *Städtischen*), which carry on the pupil to a somewhat more advanced stage, and are partly intended to draw off the unsuitable elements from the higher schools.

The secondary schools of Prussia may be roughly divided into classical and modern, though there are comparatively few in which Latin is quite omitted. The classical schools proper consist of *Gymnasien* and *Progymnasien*, the latter being simply gymnasias wanting the higher classes. In these boys are prepared for the universities and the learned professions, and the full course lasts for nine years. In the modern schools, which are divided in the same way into *Realgymnasien* and *Realprogymnasien*, and also have a nine years' course, Latin is taught, but not Greek, and greater stress is laid upon modern languages, mathematics and natural science. The three lower classes are practically identical with those of the gymnasias, while in the upper classes the thoroughness of training is assimilated as closely as possible to that of the classical schools, though the subjects are somewhat altered. Ranking with the realgymnasias are the *Oberrealschulen*, which differ only in the fact that Latin is entirely omitted, and the time thus gained devoted to modern languages. The *Höhere* (or upper) *Bürgerschulen*, in which the course is six years, rank with the middle schools above mentioned, and are intended mainly for those boys who wish to enter business life immediately on leaving school. All these secondary schools possess the right of granting certificates entitling the holders, who must have attained a certain standing in the school, to serve in the army as one-year volunteers. The gymnasial "certificate of ripeness" (*Maturitätszeugnis*), indicating that the holder has passed satisfactorily through the highest class, enables a student to enroll himself in any faculty at the university, but that of the realgymnasium qualifies only for the general or "philosophical" faculty, and does not open the way to medicine, the Church or the bar. Considerable efforts are, however, now being made to have the realgymnasium certificate recognized as a sufficient qualification for the study of medicine at least. At any of these schools a thoroughly good education may be obtained at a cost seldom exceeding, in the highest classes, £5 per annum. The teachers are men of scholarship and ability, who have passed stringent government examinations and been submitted to a year of probation. The great majority of the secondary schools have been established and endowed by municipal corporations.

Prussia possesses ten of the twenty German universities (not including the lyceum at Braunsberg and the Roman Catholic seminary at Münster). The largest Prussian university is that of Berlin, while Breslau, Bonn, Göttingen and Halle are the next in size. The oldest is the university of Greifswald, founded in 1456. Like the schools the universities are state institutions, and the professors are appointed and paid by government, which also makes liberal annual grants for apparatus and equipment. The full obligatory course of study extends over three, and in the case of medicine, four years. It is, however, not unusual for non-medical students also to spend four years at the university, and there is an agitation to make this compulsory. Students qualifying for

The Growth of PRUSSIA 1415-1910

English Miles
0 10 20 30 40 50 100

North Sea

Heligoland 1801

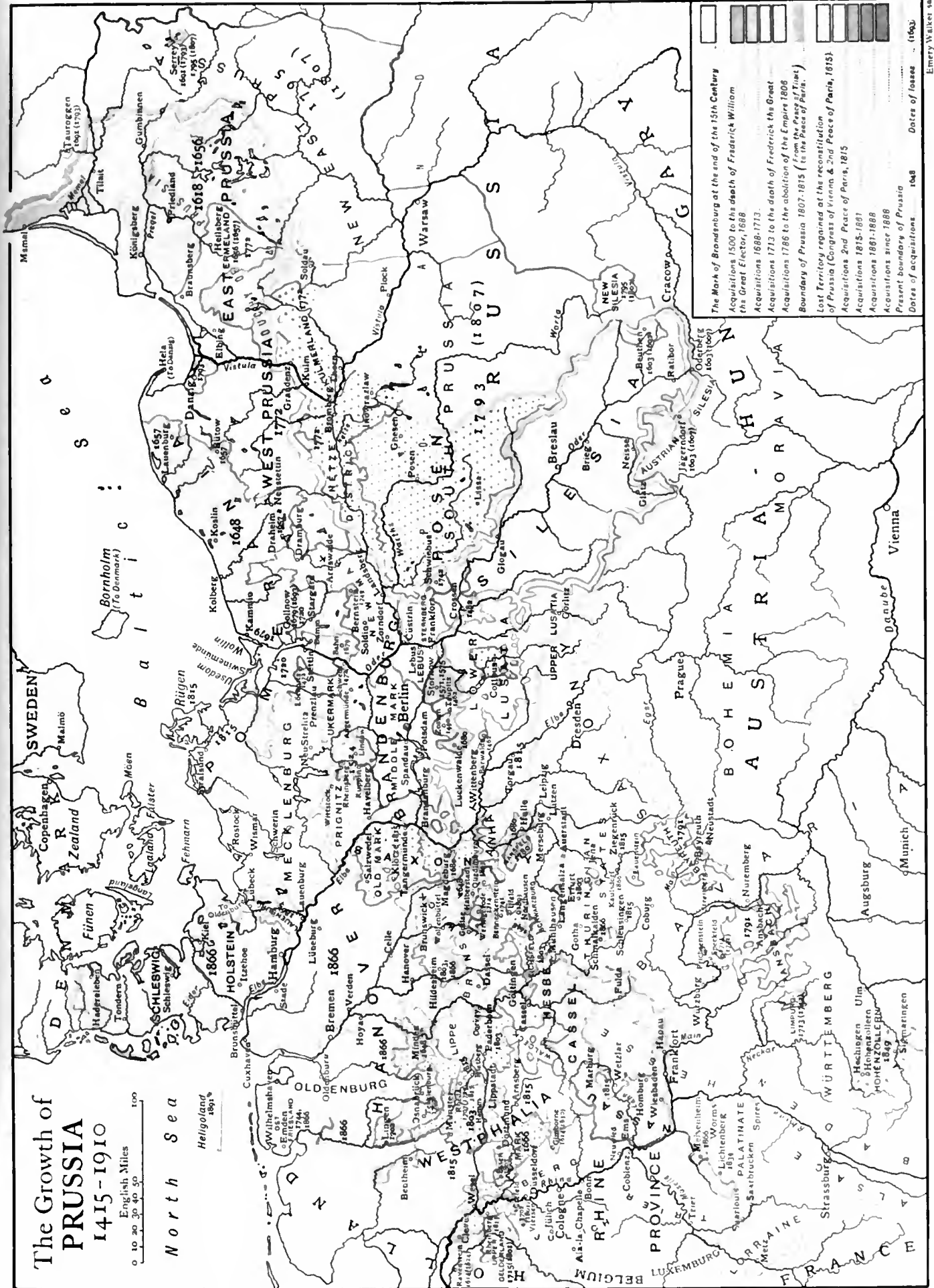

The Mark of Brandenburg at the end of the 15th Century

Acquisitions 1500 to the death of Frederick William the Great Elector, 1688

Acquisitions 1688-1713

Acquisitions 1713 to the death of Frederick the Great

Acquisitions 1786 to the abolition of the Empire 1806

Boundary of Prussia 1807-1815 (to the Peace of Paris)

Lost Territory regained at the reconstitution of Prussia (Congress of Vienna & 2nd Peace of Paris, 1815)

Acquisitions 1815-1891

Acquisitions 1891-1888

Acquisitions since 1888

Present boundaries of Prussia

Dates of losses ... (1600)

Dates of losses ... (1600)



a Prussian government appointment are required to spend at least three terms or half-years (*Semester*) at a Prussian university.

Ranking with the universities are the large technical high schools at Berlin, Hanover, Aix-la-Chapelle and Danzig, the mining academies of Berlin and Klausthal, and the academies of forestry at Eberswalde and Münden; the agricultural high schools of Berlin and Poppelsdorf (Bonn) and the two veterinary high schools of Berlin and Hanover. Music is taught at several *conservatoria*, the best known of which are at Berlin and Frankfort-on-Main.

The science and art of Prussia find their most conspicuous external expression in the academies of science and art at Berlin, both founded by Frederick I.; and each town of any size throughout the kingdom has its antiquarian, artistic and scientific societies. Recognized schools of painting exist at Berlin and Düsseldorf, and both these towns, as well as Cassel, contain excellent picture galleries. The scientific and archaeological collections of Berlin are also of great importance. Besides the university collections, there are numerous large public libraries, the chief of which is the royal library at Berlin (1,000,000 volumes).

Finance.—As in all civilized countries, the national accounts of Prussia expand by leaps and bounds, and they do this in spite of the advantage which the state derives from the possession of valuable revenue-yielding properties. Of these the most important are the railways. Next in point of revenue come the mines and salines. Then follow the state forests and the landed domains, though the income from this source is rapidly decreasing as agriculture declines. For 1905-1906 the public revenue and expenditure were estimated at £135,914,080. The principal sources of revenue are the railways, £81,268,493; domains and forests, £5,982,911; state lottery, £4,840,665; mines, &c., £10,585,875; direct taxes (principally income-tax), £11,505,365; indirect taxes, £4,789,965; administrative receipts, £8,410,684; and from the general financial control, £8,356,636. The chief items of the expenditure consist of payments for religion and education, £8,201,632; for justice, £6,260,330; working expenses, including £50,280,525 for working the state railways, £69,626,542; interest, &c., on public debt, £12,375,380; the ministry of finance, £6,585,722, and the ministry of the interior, £4,313,780. The public debt grew from £64,363,000 in 1872 to £360,447,654 in 1905. The greater part of this debt has been incurred in the purchase of the state railways.

See *Jahrbuch für die amtliche Statistik des preussischen Staats*, the *Statistisches Jahrbuch für das deutsche Reich*, and other publications of the statistical offices of Prussia and Germany. Good general accounts of the natural, social and political features of the country are given in Eiselen's *Der preussische Staat* (Berlin, 1862) and in Daniel's *Handbuch der Geographie* (several editions). The Prussian constitution and administrative system are concisely described in the *Handbuch der Verfassung und Verwaltung in Preussen*, by Graf Huë de Grais, and are treated at length in Von Rönne's *Staatsrecht der preussischen Monarchie* (4th ed., 1881-1884), and in Arndt, *Verfassungs-Urkunde für den preussischen Staat* (Berlin, 1900). In addition, see *Landeskunde Preussens* (Berlin, 1901), edited by Buermann. Various volumes of *Forschungen zur deutschen Landes- und Volkskunde*, edited by Kirchhoff; *British Diplomatic and Consular Reports*; and James Baker, *Report on Technical and Commercial Education in East Prussia*, &c. (London, 1900).

History.—The name of Prussia is derived from the dukedom of Prussia (the present province of East Prussia), which was raised into a kingdom by the emperor in favour of Frederick III., elector of Brandenburg, on the 18th of January 1701. The title "king of Prussia"¹ applied at the outset only to Prussia proper, which formed no part of the Empire; in respect of his other dominions the king continued to bear titles (margrave, duke, &c.) which implied feudal subordination to the emperor. The extension of the style "kingdom of Prussia" so as to cover the whole of the territories, by whatever title held, of the electors of Brandenburg, was not, however, an empty assumption, but symbolized a new fact of first-class historic importance: the rise in Germany and in Europe of a new great power. The consolidation of this power had been the work of the Great Elector, the work of whose reign (1640-1688) laid the foundations of the modern Prussian state (see FREDERICK WILLIAM I., elector of Brandenburg, and BRANDENBURG: *History*).

The Great Elector's son Elector Frederick III. was an ostentatious and somewhat frivolous prince, who hazarded the acquisitions of his father by looking on his position as assured

¹ Strictly speaking, the title assumed was "king in Prussia" (König in Preussen), this apparently being meant to indicate that there was still a Prussia (West Prussia) of which he was not king, though it has also been otherwise explained.

and by aiming rather at external tokens of his dignity than at a further consolidation of the basis on which it rested. The Brandenburg troops fought in the war of the second coalition against Louis XIV. and in that of Frederick I., 1688-1713. the Spanish Succession; but neither the peace of Ryswick (1697) nor that of Utrecht (1713) brought the country any very tangible advantage. Brandenburg soldiers also helped the emperor in his wars with the Turks, and it was Frederick's action in covering the Dutch frontier with 6000 troops which left William of Orange free scope in his expedition to England. The most notable incident in Frederick's reign was, however, his acquisition of the title of king of Prussia, which had long formed the principal object of his policy. The emperor's consent was finally purchased by the promise of a contingent of 8000 men to aid him in the War of the Spanish Succession, and on the 18th of January 1701 Frederick crowned himself at Königsberg with accompanying ceremonies of somewhat inflated grandeur. Elector Frederick III. of Brandenburg became henceforth King Frederick I. of Prussia.² Superficial as this incident may at first sight appear, it added considerably to the moral and political momentum of the country, if only by giving to the subjects of the Prussian crown a common name, and its advantages were reaped by Frederick's two vigorous successors. About the same time (1697) the elector of Saxony also acquired the kingly dignity by his election to the throne of Poland, but in doing so he had to become a Roman Catholic, and thus left the Hohenzollerns without a rival among the Protestant dynasties of Germany. Frederick was extravagant; but he also did much for the intellectual life of the country, patronizing learned men, and founding the university of Halle (1694) and at Berlin the Academy of Arts (1699) and the Academy of Sciences (1700). Moreover, even under this improvident king the territory of Prussia increased. From Saxony the king bought the hereditary advocateship (*Erbovogtei*) of the *Reichsstift* of Quedlinburg, as well as the imperial city of Nordhausen, the bailiwick of Petersberg and the countship of Tecklenburg, while in 1702 from William III. of Orange he inherited Lingen, Mörs and Neunburg.

The court of Vienna consoled itself for the growing power of Prussia under the Great Elector by the reflection that it was probably temporary and due mainly to the vigorous individuality of that prince. The events of Frederick I.'s reign seemed to justify this view. At his accession Prussia might fairly claim to rank as the second state of Germany, but before the death of Frederick, Bavaria, Saxony and Hanover all raised themselves to at least a level with Prussia. Frederick's preoccupation in the western wars had allowed Sweden to reassert her pre-eminence in northern Europe, and it was Russia, and not Prussia, that now impeded her progress. The internal soundness of the country had also suffered: the finances were in a state of complete disorganization, and the burden of taxation was almost insupportable. If Frederick's son and successor had not been a man of vigorous character the downhill progress might have continued until it had removed Prussia altogether from the list of important states.

The accession, on the 25th of February 1713, of Frederick William I. produced at once a complete change of system. The new king, whose literary education had been Frederick neglected, shared none of his father's artistic tastes William I., 1713-1740. and had a complete contempt for the trappings of royalty. On the other hand, he possessed administrative talents of no mean order and was singularly painstaking, industrious and determined in carrying out his plans. By carefully husbanding his finances Frederick William filled his treasury and was able to keep on foot one of the largest and best disciplined armies in Europe, thereby securing for Prussia an influence in European councils altogether disproportionate to its size and population. In internal management he made Prussia the model

² By the treaty of Utrecht, to which King Frederick William I. acceded on the 15th of May 1713, Prussia received upper Gelderland in exchange for the principality of Orange, and the king's title was acknowledged by the European powers.

state of Europe, though his administration was of a purely arbitrary type, in which the estates were never consulted and his ministers were merely clerks to register his decrees. His first act was to reform the expensive institutions of the court; and the annual allowance for the salaries and pensions of the chief court officials and civil servants was at once reduced from 276,000 to 55,000 thalers. The peace of Utrecht (1713) left Frederick William free to turn his attention to the northern war then raging between Sweden on the one side and Russia, Poland, and Denmark on the other. Though at first disposed to be friendly to Sweden, he was forced by circumstances to take up arms against it. In September 1713 Stettin was captured by the allies and handed over to the custody of Frederick William, who paid the expenses of the siege and undertook to retain possession of the town until the end of the war. But Charles XII. refused to recognize this arrangement and returned from his exile in Turkey to demand the immediate restitution of the town. With this demand the king of Prussia naturally declined to comply, unless the money he had advanced was reimbursed; and the upshot was the outbreak of the only war in which Frederick William ever engaged. The struggle was of short duration, and was practically ended in 1715 by the capture of Stralsund by the united Prussians, Saxons and Danes under the command of the king of Prussia. The Swedes were driven from Pomerania, and at the peace of 1720 Frederick William received the greater part of Swedish Pomerania, including the important seaport of Stettin. Sweden now disappeared from the ranks of the Great Powers, and Prussia was left without a rival in northern Germany.

A detailed history of Frederick William's reign would necessitate the recital of a long and tedious series of diplomatic proceedings, centring in the question of the succession to the duchies of Jülich and Berg. The treaty of Wusterhausen between Austria and Prussia was concluded in 1726, and was confirmed with some modifications by the treaty of Berlin in 1728. Frederick William engaged to recognize the Pragmatic Sanction, while the emperor on his side undertook to support Prussia's claims to Jülich and Berg. The policy of the latter, however, was far from straightforward, as he had already entered into a similar compact with the count palatine of Sulzbach, who was a Roman Catholic and therefore a more sympathetic ally. Frederick William's intervention in the matter of the succession to the throne of Poland, rendered vacant by the death of Augustus II. in 1733, proved barren of advantage to Prussia and failed to secure the hoped-for reversion of the duchy of Courland. A Prussian contingent took part none the less in the ensuing war between Austria and France, but Austria concluded peace in 1735 without consulting her ally. In 1737 the king withstood the pressure brought to bear upon him by England, France, Holland and Austria to induce him to submit to their settlement of the Jülich-Berg question; and in 1739, convinced at least of the confirmed duplicity of the emperor, he turned to his hereditary enemy for help and concluded a defensive alliance with France. The rivalry between Austria and Prussia had begun, which for the rest of the century formed the pivot on which the politics of Europe mainly turned.

If the external history of Frederick William's reign is not especially glorious, and if in diplomacy he was worsted by the emperor, the country at least enjoyed the benefits of a twenty-five years' peace and efficient government. During this reign the revenues of Prussia were doubled, and the king left at his death an accumulated treasure of 9,000,000 thalers and an army of 85,000 men. Though not ranking higher than twelfth among the European states in extent and population, Prussia occupied the fourth place in point of military power. The king himself took the greatest interest in the management of his army, in which the discipline was of the strictest; and he carried the habits of the military martinet into all departments of the administration. His chief innovation was the abolition of the distinction between the military and the civil funds, and the assignment of the entire financial management of the country to a general directory of finance, war and domains. The directory was instructed to pay for everything out of a common fund, and so to regulate the expenditure that there should invariably be a surplus at the end of the year. As the army absorbed five-sevenths of the revenue, the civil administration had to be conducted with

the greatest economy. The king himself set the example of the frugality which he expected from his officials, and contented himself with a civil list of 52,000 thalers (£7800). The domains were now managed so as to yield a greater income than ever before, and important reforms were made in the system of taxation. By the substitution of a payment in money for the obsolete military tenure the nobles were deprived of their practical exemption from taxation, and they were also required to pay taxes for all the peasant holdings they had absorbed. Attempts were made to better the condition of the peasants, and the worst features of villeinage were abolished in the Crown domains. The military system of cantonment, according to which each regiment was allotted a district in which to recruit, was of constitutional as well as military importance, since it brought the peasants into direct contact with the royal officials. The collection of the taxes of the peasantry was removed from the hands of the landowners. The duties of the state officials were laid down with great detail, and their performance was exacted with great severity. Justice seems to have been administered in an upright manner, though the frequent and often arbitrary infliction of the penalty of death by the king strikes us with astonishment. The agricultural and industrial interests of the country were fostered with great zeal. The most important industrial undertaking was the introduction of the manufacture of woollen cloth, the royal factory at Berlin supplying uniforms for the entire army. The commercial regulations, conceived in a spirit of rigid protection, were less successful. In the ecclesiastical sphere the king was able to secure toleration for the Protestants in other parts of Germany by reprisals on his own Roman Catholic subjects, and he also gave welcome to numerous Protestant refugees, including 18,000 exiled peasants from Salzburg (1732). He has the credit of founding the common-school system of Prussia and of making elementary education compulsory.

On the 31st of May 1740 Frederick William died, and was succeeded by his son as Frederick II., known in history as Frederick the Great. The young king at once resolved to use the well-filled treasury and well-disciplined army left to him by his father for the purpose of increasing the position of Prussia in Europe. The death of the emperor Charles VI., the last of the male line of the house of Habsburg, on the 20th of October 1740, gave him his opportunity, by raising the question of Maria Theresa's right to succeed under the Pragmatic Sanction (see Charles VI., emperor; MARIA THERESA; AUSTRIA-HUNGARY: *History*). Austrian duplicity in the matter of Jülich gave him a colourable pretext for his hostile attitude in reviving the long dormant claims of Prussia to the Silesian duchies. Within a year of his accession he had embarked on the Silesian War, and this was closely followed by the second, which ended in 1745, leaving Frederick in undisputed possession of almost the whole of Silesia, with the frontier that still exists. East Friesland, the Prussian claim to which dated from the time of the Great Elector, was absorbed in 1744 on the death without issue of the last duke. The two Silesian Wars completely exhausted the stores left by Frederick William, both of grenadiers and thalers, and Frederick gladly welcomed the interval of peace to amass new treasures and allow his subjects time to recover from their exertions. When the Seven Years' War broke out in 1756 he had an army of 150,000 men at his command, representing about one-seventh of the available male population of his little kingdom. He had also a fund of 11,000,000 thalers in his treasury, though this would have gone but a small way had he not been assisted by the subsidies of England and able to make the fertile plains of Saxony his chief basis of supply. (See SEVEN YEARS' WAR.)

Though without gain in extent or population, Prussia emerged from the war as an undoubted power of the first rank, and henceforth completely eclipsed Saxony, Bavaria and Hanover, while it was plain that Austria would no longer stand without a rival for the hegemony of the German Empire. The glorious victories over the French and Russians also awakened a spirit of German patriotism that had hitherto been almost unknown. But the price paid for these results was enormous. Of the 850,000 soldiers who, as is estimated, perished during the war about 180,000 fell in the service of Prussia, and the gross population of the kingdom had decreased in seven years to the extent of half a million souls. The misery and poverty indirectly attendant on the war were incalculable. The development of the country was thrown back for many years, which were almost a repetition of the period succeeding the Thirty Years' War. But while nearly a century elapsed before the traces of that struggle disappeared, Frederick repaired most of the ravages of the Seven

**Prussia
under
Frederick
William I.**

**Prussia
under
Frederick II.**

Years' War in a tenth of the time. By great dexterity in the management of his finances he had kept clear of debt, and was soon able to advance large sums to the most impoverished districts. Foreign colonists were invited to repeople the deserted villages; taxes were in several instances remitted for a series of years; the horses of the army were employed in farm labour; and individual effort in every department was liberally supported by the government. By 1770 nearly all the ruined villages had been rebuilt; the ground was again under cultivation; order had been restored; the vacant offices had been filled; and the debased currency had been called in. Throughout the kingdom agriculture was encouraged by the drainage of marshy districts; industry was extended by the introduction of new manufactures, by bounties and by monopolies; and commerce was fostered by measures of protection. Frederick's methods of administration did not greatly differ from those of his predecessor, though the unrelenting severity of Frederick William was relaxed and the peculiarities of his system toned down. Frederick's own personal supervision extended to every department, and his idea of his position and duties made him his own first minister in the widest and most exacting sense of the term. His efforts to improve the administration and the bureaucracy were unceasing, and he succeeded in training a body of admirable public servants. One of his most sweeping reforms was in the department of law, where, with the able aid of the jurist Samuel von Cocceji (1679-1755), he carried out a complete revolution in procedure and personnel. One of the king's first acts was to abolish legal torture, and he rarely sanctioned capital punishment except in cases of murder. The application of the *privilegium de non appellando* (1746) freed Prussia from all relations with the imperial courts and paved the way for a codification of the common law of the land, which was begun under Frederick but not completed till the end of the century. In matters of religion Frederick not only exercised the greatest toleration, remarking that each of his subjects might go to heaven after his own fashion, but distinctly disclaimed the connexion of the state with any one confession. Equal liberty was granted in speaking and writing. Though his finances did not allow him to do much directly for education, his example and his patronage of men of letters exercised a most salutary effect. The old system of rigid social privilege was, however, still maintained, and unsurmountable barriers separated the noble from the citizen and the citizen from the peasant. The paramount defect of Frederick's administration, as future events proved, was the neglect of any effort to encourage independence and power of self-government among the people. Every measure emanated from the king himself, and the country learned to rely on him alone for help in every emergency.

In 1772 Prussia and Austria, in order to prevent an overweening growth of Russia, joined in the first partition of Poland. Frederick's share consisted of West Prussia and the Netze district, which filled up the gap between the great mass of his territories and the isolated district of East Prussia. It had also this advantage over later acquisitions at Poland's expense, that it was a thoroughly German land, having formed part of the colonizations of the Teutonic Order. In 1778 Prussia found herself once more in opposition to Austria on the question of the Bavarian succession, but the difficulty was adjusted without much bloodshed (see POTATO WAR). The same question elicited the last action of importance in which Frederick engaged—the formation of a "Fürstenbund," or league of German princes under Prussian supremacy, to resist the encroachments of Austria. The importance of this union was soon obscured by the momentous events of the French Revolution, but it was a significant foreshadowing of the duel of Austria and Prussia for the pre-eminence in Germany. Frederick died on the 17th of August 1786, having increased his territories to an area of 75,000 sq. m., with a population of five and a half millions. The revenue also had immensely increased and now amounted to about twenty million thalers annually, of which, however, thirteen were spent on the army. The treasury contained a fund of sixty million thalers, and the country was free of debt. (See FREDERICK II., KING OF PRUSSIA.)

A continuation of the personal despotism under which Prussia had now existed for seventy years, as well as of its disproportionate influence in Europe, would have required a Frederick William II., ruler with something of the iron will and ability of 1786-1797. Frederick the Great. Unfortunately Frederick's nephew and successor, Frederick William II., had neither the energy nor the insight that his position demanded. He was too undecided to adhere to the vigorous external policy of his predecessor, nor did he on the other hand make any attempt

to meet the growing discontent by an internal movement of liberal reform. The rule of absolutism continued, though the power now lay more in the hands of a "camarilla" or cabinet than in those of the monarch; and the statesmen who now came to the front were singularly short-sighted and inefficient. The freedom of religion and the press left by Frederick the Great was abrogated in 1788 by royal ordinance. In 1787 the army engaged in an expensive and useless campaign against Holland. The abandonment of Frederick's policy was shown in a tendency to follow the lead of Austria, which culminated in an alliance with that power against revolutionary France. But in 1795 Prussia, suspicious of the Polish plans of Russia and Austria, concluded the separate peace of Basel, almost the only redeeming feature of which was the stipulation that all north German states beyond a certain line of demarcation should participate in its benefits. This practically divided Germany into two camps and inflicted a severe blow on the imperial system. The indifference with which Prussia relinquished to France German lands on the left bank of the Rhine, compared with her eagerness to increase her Slavonic territories on the east, was certainly one of the great blunders of the reign. Prussia's share in the second and third partitions of Poland (1783 and 1795) nearly doubled her extent, but added little or nothing to her real power. The twelve years following the peace of Basel form one of the most sombre periods of the history of Prussia. Her prestige was lost by her persistent and ill-timed neutrality in the struggle with France; the old virtues of economy, order and justice disappeared from the bureaucracy; the army was gradually losing its excellence and was weakened rather than strengthened by the hordes of disaffected Polish recruits; the treasury was exhausted and a large debt incurred; the newly awakened feeling of German patriotism had died away, especially among the upper classes. (See FREDERICK WILLIAM II., KING OF PRUSSIA.)

Frederick William III. possessed many virtues that did him credit in his private capacity, but he lacked the vigour that was at this juncture imperatively required from a ruler Frederick of Prussia, while he was unfortunately surrounded William III. by counsellors who had as little conception as him-1797-1840. self of Prussia's proper rôle. Not even the high-handed occupation of Hanover by the French in 1803 could arouse him; and the last shred of self-respect seemed to have been parted with in 1805 when Prussia consented to receive Hanover, the property of its ally England, from the hands of France. The formation of the Confederation of the Rhine in 1806 and the intelligence that France had agreed to restore Hanover to England at last convinced Frederick William of what he had to fear from Napoleon; while Napoleon on his side, being now free of his other antagonists, Prussia and Napoleon. was only too glad of an opportunity to destroy his tool. Prussia declared war on the 9th of October 1806; and the short campaign that ensued showed that the army of Frederick the Great had lost its virtue, and that Prussia, single-handed, was no match for the great French commander. On the 14th of October the Prussian armies were overthrown at Jena and Auerstädt, and a total collapse set in. Disgraceful capitulations of troops and fortresses without a struggle followed one another in rapid succession; the court fled to East Prussia; and Napoleon entered Berlin in triumph. At the Peace of Tilsit (July 9, 1807) Frederick William lost half his kingdom, including all that had been acquired at the second and third partitions of Poland and the whole of the territory west of the Elbe. An enormous war indemnity was also demanded, and the Prussian fortresses were occupied by the French until this should be paid.

The next half-dozen years form a period of the greatest significance in the history of Prussia, embracing, as they do, the turning-point in the moral regeneration of the country. The disasters of 1806 elicited a strong spirit of patriotism, which was fanned by the exertions of the "Tugendbund," or League of Virtue, and by the writings of men like Fichte and Arndt. The credit of the reformation belongs mainly to the great minister Stein, and in the second place to the chancellor Hardenberg.

The condition on which Stein based his acceptance of office was itself of immense importance; he insisted that the system of governing through irresponsible cabinet councillors, which had gradually become customary, should cease, and that the responsible ministers of departments should be at once the confidential advisers and the executive agents of the king. Stein's edict of 1807 abolished serfdom and obliterated the legal distinction of classes by establishing freedom of exchange in land and free choice of occupation.¹ The "Städteordnung" of 1808 reformed the municipalities and granted them important rights of self-government. His administrative reforms amounted to a complete reconstruction of the ministerial departments and the machinery of provincial government, and practically established the system now in force. In 1810 Hardenberg, with a precipitancy which Stein would scarcely have approved, continued the reform in the condition of the peasants by making them absolute owners of part of their holdings, the landlords obtaining the rest as an indemnity for their lost dues.² The army was also reorganized by Napoleon that it should not exceed 42,000 men was practically evaded by replacing each body of men by another as soon as it was fairly versed in military exercises. The educational reforms of Wilhelm von Humboldt established the school system of Prussia on its present basis, and the university of Berlin was founded in 1809 (see STEIN, H. F. C. FREIHERR VON; HARDENBERG, K. A. VON).

Frederick William hesitated to take part in the Austrian rising in 1809, but his opportunity came in 1813, when Napoleon fled from Russia. General York, commander of the corps that Prussia had been obliged to contribute to the French expedition, anticipated the formal declaration of war by joining the Russians with his troops on his own responsibility (Dec. 30, 1812). On the outbreak of the war the people rose *en masse* and with the utmost enthusiasm. A treaty of alliance between Russia and Prussia was concluded at Kalisch, and Austria, after some hesitation, also joined the league against Napoleon. In the struggle that followed (see NAPOLEONIC CAMPAIGNS), Prussia played one of the most prominent parts, and her general Blücher was the driving force of the allied armies. Between 1813 and the battle of Waterloo Prussia lost 140,000 men, and strained her financial resources to the utmost. As compensation she received at the Congress of Vienna

Accessions in 1815.

the northern half of Saxony, her old possessions west of the Elbe, Swedish Pomerania, the duchies of Berg and Jülich, and other districts in Westphalia and on the Rhine. The acquisitions of the last partition of Poland, with the exception of the grand-duchy of Posen, were resigned to Russia; Friesland went to Hanover, and Bavaria was allowed to retain Baireuth and Ansbach, which had come into her hands in 1806. This arrangement of the map did not wholly restore Prussia to its former extent, as its area was now only 108,000 sq. m. compared with 122,000 sq. m. at the beginning of 1806, but the substitution of German for Slav territory and the shifting of the centre of gravity towards the west more than made up for any slight loss in size. Hanover still formed a huge wedge splitting Prussia completely in two, and the western frontier was very ragged. Prussia's position required caution, but forced upon it a national German policy; and the situation of the new lands was vastly more effectual in determining the future leader of Germany than was Austria's aggrandisement in Italy.

The task that confronted Frederick William III. in 1815—that of welding together the heterogeneous elements assembled under his crown by the great congress—was one that would have taxed the statesmanship of a stronger man than he. The population of Prussia had been more than doubled, and contained, besides 2,000,000 Slavs, people of every German

¹ Previous to this measure the distinction between "noble," "burgher," and "peasant" land and occupations was strictly observed, and no transition of property or employment from one class to another was possible.

² The patrimonial jurisdiction of the landowners was not taken away till 1848.

race; and, as an additional problem, the annexation of the Rhine provinces had raised the number of Roman Catholic subjects of the most Protestant of the German monarchies to some two-fifths of the whole. On the 3rd of June 1814 the king had issued a cabinet order promising on his return to give a decision as to a national constitution, and this promise had been repeated in proclamations at Danzig and Posen (May 1815) and in the patent addressed to the new Saxon provinces on the 22nd of May: in addition to the provincial estates there was to be a national Diet for the whole country. When, however, the work of drawing up the constitution was put in hand, it soon became clear that it would meet with extraordinary difficulties. Liberalism was as yet a force only in the professional classes; the provinces, proud of their traditions, were loth to be merged in a common organization (Pomeranians and Silesians are described in contemporary documents as "nations"); above all, there was the fundamental antagonism, by no means extinct even now, between the old eastern provinces, with their strong feudal spirit, and the new western provinces, in which the ideas of the Revolution had gained a permanent ascendancy; and of all these conflicting tendencies, one only was organized into a compact body of opinion: the ultra-conservative feudal landowners (*Junker*) of the mark of Brandenburg, "heartless, wooden, half-educated people," as Stein called them, "fit only to be turned into corporals or calculating machines," but for all that the very backbone of the traditional Prussian monarchy.

In spite of all the king would probably have granted a constitution, but for the ill-timed alarms and excursions of the Liberal *Turnvereine* and *Burschenschaften*. The trials and humiliations he had passed through during the revolutionary epoch had left him in a condition of nervous apprehension, which the Wartburg festival of October 1818 (Kamptz's *Police Laws*, an uhlan's stays and a corporal's cane—symbols of Prussian methods—had been committed to the flames) and the murder of Kotzebue turned into reactionary panic. Metternich, who had never ceased to warn the king of the peril to the Prussian monarchy which would result from a central representative system, seized the opportunity; under his influence in October 1819, Frederick William by signing the Carlsbad Decrees (*q.v.*) definitely committed himself to the Austrian system of "stability." It was not, however, till the 11th of June 1821 that the king finally decided to postpone the constitution, and to summon a commission to organize a system of provincial estates, which were created by royal patent on the 5th of June 1823. For the rest, the question of a constitution was not again raised during the king's reign, and for years the Prussian police engaged in the congenial task of "demagogue hunting" (*Demagogenhetzei*), popular heroes like Jahn and Arndt being haled to prison on frivolous charges, and even Gneisenau and Scharnhorst surrounded with spies.

Meanwhile, by an ordinance of the 20th of April 1814 the kingdom had been divided into eight provinces, each province into government districts (*Regierungsbezirke*), and these again into "circles" administered by a *Landrat* (*landräthliche Kreise*). At the head of each *Regierungsbezirk* was a government board responsible to the *Oberpräsident*, who was responsible in his turn to the ministry under the chancellor. On the 20th of March 1817 was created a council of state (*Staatsrat*) consisting of the royal princes, high officials and a certain number of members nominated by the king, whose function was to supervise the administration and discuss projects of legislation. Its immediate tasks were to bring the new provinces into harmony with the Prussian system and to set order into the disorganized finances. Both problems were solved in a manner that did credit to the Prussian bureaucracy. By 1820, in spite of the damage caused by the war and of the exhaustion of the country, the financial situation was satisfactory, the king having contributed to this result by surrendering the Crown domains to the state, reserving only a charge of 2,500,000 thalers, the so-called *Kronfideikommissfonds*. The reconciliation of the new provinces to the new order was a matter of even more difficulty, notably in the case of the population of the Rhine districts, which had been accustomed to the easy-going methods and light taxation of the ecclesiastical princes. They were, however, to a certain extent reconciled by the wise liberality which left to them many of their peculiar institutions, *e.g.* the Code Napoléon in the Rhine provinces. Most burdensome of all was the law of the 3rd of September 1814 introducing universal military service and organizing the *Landwehr*; but it was precisely this which was to be the strongest factor in welding Prussia together and making her supreme in Germany.

Of all the reforms the most far-reaching was the creation, on the 1st of January 1834, of the famous customs union or *Zollverein*, which was to become the material basis of Prussia's influence in Germany. (For details see GERMANV: *History*, xi. 865.)

In educational matters also the government achieved results of lasting value. The university of Bonn was founded, the others were reorganized; numerous *Gymnasien* were built and above all

Question of a Constitution.

Pan-German Agitation. Reaction in Prussia.

Administrative Reorganization.

The New Provinces.

The Zollverein.

elementary education was made universal and compulsory. Less happy was Frederick William's attempt to adjust the religious differences of his subjects with the corporal's cane. In 1817, the tercentenary of the Reformation, a royal decree announced that henceforth Lutherans and Reformed were to unite in one "Evangelical Church," the public use of the name "Protestant" being officially forbidden. The so-called Old Lutherans, who refused to conform, were forbidden to found a separate community, and refractory pastors were dragooned and imprisoned. A quarrel also broke out with the Roman Catholic Church on the question of "mixed marriages," which culminated in 1837 in the imprisonment of Baron Droste zu Vischering (*q.v.*), archbishop of Cologne, and of the archbishop of Posen.

In foreign politics, too, Prussia played but a secondary rôle after 1815. The king either attended, or was represented at, the various congresses up to that of Verona in 1822, but his sole idea was to support the views of Metternich, and later, those of the emperor Nicholas I. of Russia. (See EUROPE: *History*.)

Frederick William III. died on the 7th of June 1840. In spite of his faults, he had accomplished great things for Prussia, and his kindness of heart, his devotion to duty and the memory of his sufferings maintained his personal popularity to the last (see FREDERICK WILLIAM III., KING OF PRUSSIA). Of his son and successor, Frederick William IV., great things were expected, since his talents were undeniable (1840-1861), and he had gained as crown prince a reputation for Liberalism. One of his first acts was to liberate Jahn and the imprisoned archbishops, to reinstate Arndt in office and to issue a general amnesty (Aug. 10, 1840). Five years later he allowed the Old Lutherans liberty to set up a Church of their own. But in spite of these promising beginnings, it was soon clear that the king was wholly out of touch with the ideas of modern Liberalism. In spite of the warnings of the emperor Nicholas I. and of Metternich, he sought to satisfy the cry for a constitution by issuing on the 13th of February 1847 a patent summoning the "united Diet" for Prussia—that is to say, a mere "concentration" of the provincial Diets. The story of the contest that followed between the Crown and the people is outlined elsewhere (see GERMANY). It is only necessary to give here some account of the constitutional development in Prussia itself.

The most important landmark in this respect was the law promulgated after the dissolution of the lower house of the revolutionary National Assembly on the 27th of April 1849. This law, which was only slightly modified by the electoral reform law of 1910, divided the parliamentary electors into three classes, their voting power being determined by property qualifications or by official and professional position. In the elections that followed, the disgusted democrats took no part, with the result that the chambers that met on the 7th of August 1849 were strongly Conservative and made no difficulty about revising the democratic constitution of 1848 in accordance with the royal wishes. The constitution, thus amended, was proclaimed on the 31st of January 1851, and has remained substantially that of Prussia ever since. Its immediate effect was an extraordinary series of reactionary measures, *e.g.* the restoration of the old manorial courts and of the provincial estates (1850). The actual constitution of the parliament as consisting of a House of Lords (*Herrenhaus*) and House of Delegates (*Abgeordnetenhaus*) was fixed in 1854, and in this assembly the dominant element continued to be that of the Prussian *Junkertum* or squirearchy, which supported the king and his government in all their reactionary efforts.

So far as the internal history of Prussia is concerned, little was altered by the substitution of William as regent for his brother, now hopelessly mad, in 1858. The new ruler, who became king in 1861, shared to the full his predecessor's views as to the divine right of the Prussian crown. He was prepared to accept the established constitutional forms, but he was not prepared to sacrifice to them what he firmly believed to be the divinely appointed mission of Prussia in Germany. Bismarck, who became prime minister in 1862, fully shared his master's views. He realized,

what the lower house did not, that the German question could only be settled as the result of a trial of strength between Prussia and Austria and that therefore it was necessary for Prussia to spend money on armaments; and, since he could not give his real reasons to the parliament and the parliament refused to accept the reasons he did give, he raised the necessary funds in defiance of the votes of the House of Delegates. The result justified him in the eyes of the Prussian people. Bismarck's policy, culminating in the war of 1866, left Prussia the undisputed mistress of Germany (see SCHLESWIG-HOLSTEIN QUESTION; and GERMANY: *History*). By the Treaty of Prague (Aug. 23, 1866) Prussia acquired Hanover, Hesse-Cassel, Hesse-Nassau, Frankfurt and the duchies of Schleswig-Holstein and Lauenburg; her territory had been increased by one-fifth and became for the first time satisfactorily rounded off and compacted; by the acquisition of the Elbe duchies, too, she laid the foundations of her future sea-power. In 1871 as the result of the German victory over France the king of Prussia became German Emperor.

From 1867 onward Prussia has had from the point of view of international politics no existence apart from the North German Federation and the German Empire; and even in internal affairs her preponderance and influence in Germany have been overwhelming. For all practical purposes the German Empire has been Prussia and, however much the still surviving particularist feeling of the lesser states has resented the process, the "Prussification," in greater or less degree, of all Germany was inevitable from the moment that the great imperial departments—army, customs, posts, railways—were placed under Prussian authority or conformed to the Prussian model. With this particular expansion of Prussia, however, we are not concerned, but solely with the internal development of the Prussian kingdom itself. The main tasks that lay before the government after 1870 were the assimilation of the new provinces, the reorganization of the administration, the economic development of the country, the settlement of the questions arising out of the attitude of the Roman Catholics on the one hand and the Social Democrats on the other. On the whole the new German provinces accepted their fate with equanimity, though in Hanover especially the deposed dynasty continued to command a considerable following of which the ablest spokesman was Windthorst (*q.v.*). Since the dispossessed princes refused to resign their claims, the large sum of money which had been assigned to them by the Prussian parliament was, so early as March 1868, sequestered, and, under the name of the Guelph Fund (*Welfenfonds*), formed a secret service supply highly convenient for Bismarck's purposes. More difficult was the task, rashly undertaken by the government, of germanizing the Danish parts of Schleswig-Holstein and the Polish districts in the eastern provinces, a task which after thirty years of effort shows but very small results (see SCHLESWIG-HOLSTEIN QUESTION, *ad fin.*; and POSEN).

Closely connected with the Polish question was the quarrel with the Roman Catholic Church, known as the *Kulturkampf*, of which Prussia was the focus (see GERMANY: *History*, xi. 880 seq.). The anti-Vatican policy, associated especially with the name of the minister Falk, necessitated an alliance of the government with the Liberals, and this led to a policy of at least administrative reform. The present administrative system (*Kreisordnung*) of Prussia was introduced in 1872 for certain provinces, but not extended to the whole kingdom until 1888, when it was applied to Posen. The Liberalism of the Prussian parliament was, however, of a very lukewarm temper; and when in 1878-1879 Bismarck decided to reverse the fiscal policy of the country and to pass repressive legislation against the Social Democrats, the Liberals were not strong enough to offer an effective resistance. In 1879 the moderate Liberal ministry resigned, and was succeeded by a Conservative cabinet, in which the most conspicuous figure was Robert von Puttkammer (*q.v.*). Henceforth the government depended for parliamentary support on a union of the National Liberals and Conservatives or of the Conservatives and Ultramontanes. An eventual understanding with the Holy See was inevitable, though the *Kulturkampf* was not actually settled until 1888, when the Prussian government, assisted by the diplomatic attitude of Pope Leo XIII., came to terms with Rome. Meanwhile in 1879 the era of Bismarck's experiments in state socialism had begun by the purchase by the state of three of the great railways, thus laying the foundation of the present system of state railways in Prussia.

On the 9th of March 1888 William I. died. His successor,

Bismarck.

Treaty of Prague, 1866.

Prussia in the German Empire.

Prussian Problems after 1870.

The Kulturkampf.

Influence of Social Democracy: Reaction.

State Socialism.

Frederick III., only lived till the 15th of June, the sole important act of his reign being the dismissal of Puttkammer. Under his successor William II. the development of Prussian affairs continued on the lines laid down under

Frederick III., 1888.

William I., the main difference being that, after the fall of Bismarck (March 20, 1890), the old antagonism between the unrepresented masses and the government tended to

William II., 1888. change into one between these masses and the Crown. For while in the unreformed parliament the squirearchy was still disproportionately represented,¹

Socialism—denounced by the king-emperor as treason against himself and the country—spread rapidly among the unrepresented population. Discontent grew apace, and the trouble culminated in 1908 and 1909. In 1906 a bill raising the number of members of the Diet from 433

to 443 and effecting an unimportant redistribution of seats had been passed, but a Radical amendment in favour of direct and universal suffrage and the secret ballot had been rejected by a large majority. In 1907 the elections for the Reichstag resulted in a remarkable defeat of the Socialist forces, and this had its effect in Prussia also. In 1908 a resolution in favour of universal suffrage was again brought forward. It was opposed by Prince Bülow, the German chancellor, and was rejected by a large majority. Riots followed in Berlin and demonstrations in favour of reform throughout the country, and at the new elections in June seven Socialist members were returned—a portentous phenomenon under the actual franchise. In the session of 1909 the reform resolution was again brought forward, and again thrown out by the Conservative majority.

Demonstrations and collisions with the police followed in most of the large Prussian towns, and in October four of the Socialist members returned in 1908 who had been unseated on technical grounds were re-elected. It became clear to the government that some sop must be thrown to popular opinion, and accordingly in the speech from the throne delivered on the 11th of January 1910 the king-emperor announced a measure of franchise reform. The agitation, however, continued, and the terms of the bill when it was introduced by Herr von Bethmann-Hollweg on the 10th of February were not such as to conciliate opposition. The chancellor and minister-president adhered to the principles enunciated by his predecessor;² the bill retained the triple class division of voters, public voting and plural votes; the voting, however, was to be direct and certain changes were suggested giving less to the moneyed interest and more to the professional classes. A furious agitation at once arose all over the country, culminating in a series of Socialist demonstrations on the 14th in Berlin and elsewhere; owing to the elaborate police precautions there was, however, no serious disturbance; but on the evening of the 18th there was street fighting between rioters and police in Frankfurt. Meanwhile, on the 13th, the bill had been referred to a committee of the Diet. No party was satisfied with it; the Berlin municipality petitioned for its entire rejection; but its fate was ultimately determined by an agreement between the representatives of the Conservative and Catholic Centre parties on the committee, the latter agreeing to support the retention of indirect voting on condition of the former declaring in favour of the secret ballot (Feb. 22). In this sense the committee ultimately reported, in spite of the government's efforts to retain public voting and to concede direct election, and on the 14th of March the bill in this shape passed its second reading. On the 16th the third reading was carried, all the parties except the Conservatives and the Centre voting against it; Herr von Bethmann-Hollweg accepted the bill on behalf of the government, merely reserving the right to amend it in matters of

Reform Bill of 1910.

¹ Prince Schönaich-Carolath pointed out in 1908 that 314,000 Socialist voters were entirely unrepresented, while 324,000 Conservative voters returned 143 members, and that the propertied and agrarian section of the community returned over 300 members, the remainder only some 130 (*Annual Register*, 1908, p. 280).

² His speech is reported in *The Times* of the 11th of February 1910.

detail. Demonstrations and riots in various centres showed how far this result was from satisfying the popular demands.

Thus Prussia retained, in contradistinction to the South German states, its traditional character, as a land ruled from above, the monarchy and the bureaucracy basing their authority not on the will of the people, but partly on divine right and partly on the middle-class terror of the social revolution, while as its ultimate sanction there remained the tremendous power of the king of Prussia as supreme "war lord" of Germany. It remained to be seen how long these conditions could last in a country which, during the tremendous material expansion of the period following the war, had developed an immense industrial population which saw, or thought it saw, its interests sacrificed to the agricultural classes, with their traditional feudalism and inherited loyalty to the Prussian system.

BIBLIOGRAPHY.—For sources see K. Kletke, *Quellenkunde der Gesch. des preuss. Staates* (Berlin, 1858–1861): Bd. i. *Schriftsteller*, Bd. ii. *Urkunden-Repertorium*; and F. Zurbonsen, *Quellenbuch zur Brandenburg-preuss. Gesch.* (Berlin, 1889), *Zeitschr. für preussische Gesch.* (ibid. 1864–1883), *Forschungen zur . . . preuss. Gesch.* (Leipzig, 1888 sqq.). Records of the Prussian government in the 18th century are being published under the title of *Acta borussica* (Berlin, 1892 sqq.). Among important general works may be mentioned Ranke, *Zwölf Bücher preussischer Gesch.*, 5 vols. to 1745 (2nd ed., Leipzig, 1878); Droysen, *Gesch. der preussischen Politik*, 5 parts in 15 vols. to 1756 (Berlin and Leipzig, 1855–1885); H. G. Prutz, *Preussische Geschichte*, 4 vols. to 1888 (Stuttgart, 1900–1902); and for constitutional history, C. Bornhak, *Preussische Staats- und Rechtsgeschichte* (Berlin, 1903). Of the many works devoted to special periods Treitschke's *Deutsche Geschichte im 19. Jahrhundert* (Leipzig, 1879–1894), in spite of its strong Prussian bias, is especially valuable for the period up to 1848, when it breaks off. See also the lists of books attached to the biographies of the various Prussian kings and statesmen.

PRUSSIA, in the original and narrower sense of the word, a territory of Germany, in the kingdom of Prussia, stretching along the Baltic coast for about 220 m., and occupying an area of 24,083 sq. m. The eastern part of this territory formed the duchy of Prussia, which was conquered and colonized by the Teutonic Order and was acquired by the elector of Brandenburg in 1618, furnishing his successor with his regal title in 1701. The western part, which had been severed from the eastern half and assigned to Poland in 1466, was not annexed to Prussia until the partition of Poland in 1772, while the towns of Danzig and Thorn remained Polish down to 1793. The two districts were united in 1824 to form a single province. But, as might have been expected, the union did not work well, and it was dissolved in 1878, its place being taken by the modern provinces of East and West Prussia. (See EAST PRUSSIA and WEST PRUSSIA.)

PRUSSIC ACID, or HYDROCYANIC ACID, HCN, an organic acid first prepared in 1782–1783 by C. Scheele and subsequently examined by J. Gay-Lussac. It is present in varying amounts in certain plants, being a product of the hydrolysis of the cyanogenetic glucosides, e.g. amygdalin (*q.v.*). It may be prepared by heating a mixture of cyanogen and hydrogen to 500°–550° C. (M. Berthelot, *Ann. chim. phys.*, 1879 (5), 18, p. 380); by passing induction sparks through a mixture of acetylene and nitrogen; by the dry distillation of ammonium formate; by the decomposition of the simple cyanides with mineral acids; and by distilling potassium ferrocyanide with dilute sulphuric acid (F. Wöhler, *Ann.*, 1850, 73, p. 219), the anhydrous acid being obtained by fractional distillation of the aqueous distillate, special precautions being necessary owing to the excessively poisonous nature of the free acid:

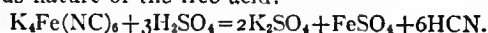

The free acid is a colourless liquid with a smell resembling bitter almonds; it boils at 26.1° C., and may be solidified, in which condition it melts at -14° C. It burns with a blue flame, and is readily soluble in water, but the solution is unstable and decomposes on standing, giving amorphous insoluble substances, and ammonium formate, oxalic acid, &c. An aqueous solution of hydrogen peroxide converts it into oxamide, (CONH₂)₂, and reduction by zinc and hydrochloric acid gives methylamine. The anhydrous acid combines with hydrochloric, hydrobromic and hydriodic acids to form crystalline addition products, which

are decomposed by water with the formation of the corresponding ammonium salt and formic acid. It combines with aldehydes and ketones to form the nitriles of oxy-acids, for example, $\text{CH}_3\text{CHO} + \text{HCN} = \text{CH}_3\text{CH}(\text{OH})(\text{CN})$. It is a very weak monobasic acid, and the aqueous solution has a very low electric conductivity.

Cyanides.—The salts of this acid, known as cyanides, may be prepared by the action of cyanogen or of gaseous hydrocyanic acid on a metal; by heating the carbonates or hydroxides of the alkali metals in a current of hydrocyanic acid; by heating alkaline carbonates with carbon in the presence of free nitrogen: $\text{BaCO}_3 + 4\text{C} + \text{N}_2 = \text{Ba}(\text{NC})_2 + 3\text{CO}$; by ignition of nitrogenous organic substances in the presence of alkaline carbonates or hydroxides; or by processes of double decomposition. The alkali and alkaline earth cyanides are soluble in water and in alcohol, and their aqueous solution, owing to hydrolytic dissociation, possesses an alkaline character. When heated in contact with air they undergo a certain amount of oxidation, being converted to some extent into the corresponding cyanate. The cyanides of other metals are decomposed by heat, frequently with liberation of cyanogen. The cyanides are usually reducing agents. Those of the heavy metals are mostly insoluble in water, but are soluble in a solution of potassium cyanide, forming more or less stable double salts, for example $\text{KAg}(\text{NC})_2$, $\text{KAu}(\text{NC})_2$. Lead cyanide, $\text{Pb}(\text{NC})_2$, however, does not form such a salt, and is insoluble in potassium cyanide solution.

Ammonium cyanide, NH_4NC , a white solid found to some slight extent in illuminating gas, is easily soluble in water and alcohol, and is very poisonous. Its vapour is inflammable. It is obtained by passing ammonia gas over hot coal; by subliming a mixture of ammonium chloride and potassium cyanide; by passing a mixture of ammonia gas and chloroform vapour through a red hot tube; and by heating a mixture of ammonia and carbon monoxide: $\text{CO} + 2\text{NH}_3 = \text{NH}_4\text{NC} + \text{H}_2\text{O}$. **Barium cyanide**, $\text{Ba}(\text{NC})_2$, prepared by the action of potassium cyanide on baryta, or by passing air over a heated mixture of barium carbonate and coal, is a white solid, which when heated with water to 300°C . loses the whole of its nitrogen in the form of ammonia. **Mercuric cyanide**, $\text{Hg}(\text{NC})_2$, is a sparingly soluble salt formed by dissolving precipitated mercuric oxide in hydrocyanic acid, or by boiling potassium ferrocyanide with mercuric sulphate and water: $2\text{K}_4\text{Fe}(\text{NC})_6 + 3\text{HgSO}_4 = 3\text{Hg}(\text{NC})_2 + 3\text{K}_2\text{SO}_4 + \text{K}_2\text{Fe}(\text{NC})_6$. Its aqueous solution is not an electrolyte, and consequently does not give the reactions of the mercury and cyanogen ions. When heated it yields mercury, cyanogen and paracyanogen. **Silver cyanide**, AgNC , is formed as a white precipitate by adding potassium cyanide to silver nitrate solution; or better, by adding silver nitrate to potassium silver cyanide, $\text{KAg}(\text{NC})_2$, this double cyanide being obtained by the addition of one molecular proportion of potassium cyanide to one molecular proportion of silver nitrate, the white precipitate so formed being then dissolved by adding a second equivalent of potassium cyanide. On concentration the double salt separates as hexagonal tables. Dilute mineral acids decompose it with the formation of insoluble silver cyanide and hydrocyanic acid: $\text{KNC} \cdot \text{AgNC} + \text{HNO}_3 = \text{HCN} + \text{KNO}_3 + \text{AgNC}$. A boiling solution of potassium chloride with the double cyanide gives silver chloride and potassium cyanide.

Potassium cyanide, KNC , and **sodium cyanide**, NaNC , are two of the most important of the salts of hydrocyanic acid, the former being manufactured in large quantities for consumption in the extraction of gold (*q.v.*). Potassium cyanide may be obtained by fusing potassium ferrocyanide either alone— $\text{K}_4\text{Fe}(\text{NC})_6 = 4\text{KNC} + \text{FeC}_2 + \text{N}_2$ —or with potassium carbonate [V. Alder, English patent 1353 (1900)]; in the latter case the chief reaction probably is: $\text{K}_4\text{Fe}(\text{NC})_6 + \text{K}_2\text{CO}_3 = 4\text{KNC} + 2\text{KOCN} + \text{CO} + \text{Fe}$; more potassium ferrocyanide is occasionally added in small quantities, in order to decompose the cyanate formed; $2\text{KOCN} + 2\text{K}_4\text{Fe}(\text{NC})_6 = 10\text{KNC} + 2\text{FeO} + 4\text{C} + 2\text{N}_2$; $2\text{FeO} + 2\text{C} = 2\text{CO} + 2\text{Fe}$. The reaction is accompanied by much frothing, and the whole is filtered when in a state of tranquil fusion. Rossler and Hasslacher prepare the double potassium sodium cyanide by fusing potassium ferrocyanide with sodium, the product of fusion being extracted with water and the solution evaporated: $\text{K}_4\text{Fe}(\text{NC})_6 + 2\text{Na} = \text{Fe} + 4\text{KNC} \cdot 2\text{NaNC}$. This process gives a product free from cyanate, which was always formed in the older fusion processes.

Many other processes have been devised. D. T. Playfair [Eng. pat. 7764 (1890)] decomposes sulphocyanides by fusing with zinc: the zinc is heated with a small quantity of carbon and when completely fused potassium sulphocyanide is added, the mass being well stirred and heated until it thickens and begins to turn red; finally it is allowed to cool out of contact with air, lixiviated with water, the solution decanted, and evaporated to a paste *in vacuo*. The potassium sulphocyanide is obtained from ammonium sulphocyanide, which is formed by washing crude coal gas with water

containing suspended sulphur. Various processes involving the use of atmospheric nitrogen have been devised, but in most cases they do not yield good results. More successful results are obtained by the use of ammonia. The Stassfurter Chem. Fabrik [Eng. pat. 9350-2 (1900)] pass ammonia over a mixture of alkali or alkaline carbonate and charcoal, first at a dull red heat and then at a bright red heat: $\text{KHO} + \text{NH}_3 + \text{C} = \text{KNC} + \text{H}_2\text{O} + \text{H}_2$. H. Y. Castner [Fr. pat. 242938 (1894)] passes anhydrous ammonia over heated sodium to form sodamide, which is then brought in a molten condition into contact with carbon: $\text{NaNH}_2 + \text{C} = \text{NaNC} + \text{H}_2$. The Deutsche Gold und Silber Scheide Anstalt [Eng. pat. 3328, 3329 (1901)] prepare sodium cyanamide by melting sodium with carbons or some hydrocarbon, and passing ammonia over the melt at from 400° – 600°C . The temperature is then raised to 700° – 800°C ., and the sodium cyanamide in contact with the residual carbon forms sodium cyanide. H. W. Crowther and E. C. Rossiter (*Journ. Soc. Chem. Ind.*, 1893, 13, p. 887) digest carbon bisulphide with ammonia and lime in quantities slightly in excess of those demanded by the following equation: $2\text{CS}_2 + 2\text{NH}_3 + 2\text{Ca}(\text{OH})_2 = \text{Ca}(\text{SCN})_2 + \text{Ca}(\text{SH})_2 + 4\text{H}_2\text{O}$; the product is then treated with a current of carbon dioxide, calcium carbonate being precipitated, sulphuretted hydrogen escaping, and calcium sulphocyanide remaining in solution. The sulphocyanide is converted into the potassium salt by adding potassium sulphate, and finally desulphurized by lead, zinc, or iron.

Potassium cyanide is an excessively poisonous, colourless, deliquescent solid; it is readily soluble in water, but almost insoluble in absolute alcohol. It is stable in dry air, but is easily oxidized when fused, in which condition it is a powerful reducing agent. It dissolves gold (*q.v.*) in the presence of water and atmospheric oxygen. It is also largely used by the jeweler, electroplater and photographer.

Double Cyanides.—The double cyanides formed by the solution of the cyanide of a heavy metal in a solution of potassium cyanide are decomposed by mineral acids with liberation of hydrocyanic acid and formation of the cyanide of the heavy metal. Besides these, other double cyanides are known which do not suffer such decomposition, the heavy metal present being combined with the cyanogen radical in the form of a complex. The most important members of these classes are the ferro- and ferri-cyanides and the nitroprussides.

Potassium ferrocyanide, $\text{K}_4\text{Fe}(\text{NC})_6$, (yellow prussiate of potash), was first obtained by decomposing Prussian blue with caustic potash: $\text{Fe}_3[\text{Fe}(\text{NC})_6]_4 + 12\text{KHO} = 3\text{K}_4\text{Fe}(\text{NC})_6 + 4\text{Fe}(\text{OH})_3$; it may be also obtained by warming a solution of ferrous sulphate with an excess of potassium cyanide: $\text{FeSO}_4 + 6\text{KNC} = \text{K}_4\text{Fe}(\text{NC})_6 + \text{K}_2\text{SO}_4$. The older processes for the commercial preparation of this salt, which were based on the ignition of nitrogenous substances with an alkaline carbonate and carbon, have almost all been abandoned, since it is more profitable to prepare the salt from the by-products obtained in the manufacture of illuminating gas. W. Fowles [Eng. pat. 9474 (1892)] passes the gas (after freeing it from ammonia) through a solution of potassium carbonate containing ferric oxide or ferrous carbonate (actually ferrous sulphate and potassium carbonate) in suspension; the sulphuretted hydrogen in the gas probably converts the iron salts into ferrous sulphide which then, in the presence of the hydrocyanic acid in the gas, and the alkaline carbonate, forms the ferrocyanide, thus: $\text{FeS} + 6\text{HCN} + 2\text{K}_2\text{CO}_3 = \text{K}_4\text{Fe}(\text{NC})_6 + \text{H}_2\text{S} + 2\text{CO}_2 + 2\text{H}_2\text{O}$. The salt is recovered by crystallization. The process is not very efficient, since the solutions are too dilute and large quantities of liquid have to be handled. A large quantity of the salt is now prepared from the "spent oxide" of the gas works, the cyanogen compounds formed in the manufacture of the gas combining with the ferric oxide in the purifiers to form insoluble iron ferrocyanides. The soluble salts are removed by lixiviation, and the residue is boiled with lime to form the soluble calcium ferrocyanide, which is finally converted into the potassium salt by potassium chloride or carbonate.

The salt crystallizes in large yellow plates, containing three molecules of water of crystallization. It is soluble in water, but insoluble in alcohol. It is not poisonous. When fused with potassium carbonate it yields potassium cyanide; warmed with dilute sulphuric acid it yields hydrocyanic acid, but with concentrated sulphuric acid it yields carbon monoxide: $6\text{H}_2\text{O} + \text{K}_4\text{Fe}(\text{NC})_6 + 6\text{H}_2\text{SO}_4 = 2\text{K}_2\text{SO}_4 + \text{FeSO}_4 + 3(\text{NH}_4)_2\text{SO}_4 + 6\text{CO}$. Oxidizing agents (Cl, Br, H_2O_2 , &c.) convert it into potassium ferricyanide (see below), a similar result being attained by the electrolysis of its aqueous solution: $2\text{K}_4\text{Fe}(\text{NC})_6 + 2\text{H}_2\text{O} = 2\text{KOH} + \text{H}_2 + 2\text{K}_2\text{Fe}(\text{NC})_6$. Potassium ferrocyanide may be estimated quantitatively in acid solution by oxidation to ferricyanide by potassium permanganate (in absence of other reducing agents): $5\text{K}_4\text{Fe}(\text{NC})_6 + \text{KMnO}_4 + 4\text{H}_2\text{SO}_4 = 5\text{K}_3\text{Fe}(\text{NC})_6 + 3\text{K}_2\text{SO}_4 + \text{MnSO}_4 + 4\text{H}_2\text{O}$.

Hydroferrocyanic acid, $\text{H}_4\text{Fe}(\text{NC})_6$, is best obtained by decomposing the lead salt with sulphuretted hydrogen under water, or by passing hydrochloric acid gas into a concentrated ether solution of the potassium salt. In the latter case the precipitate is dissolved in water, reprecipitated by ether, and washed with ether-alcohol.

It is a tetrabasic acid, of markedly acid character, and readily decomposes carbonates and acetates. It dissolves unchanged in concentrated sulphuric acid, and oxidizes readily in moist air, forming Prussian blue.

Prussian blue, $\text{Fe}_7(\text{NC})_{18}$ or $\text{Fe}_4[\text{Fe}(\text{NC})_6]_3$, ferric ferrocyanide, was discovered in 1710 by a German manufacturer named Diesbach, who obtained it by the action of fused alkali and iron salts on nitrogenous organic matter (e.g. blood). It is now prepared from the calcium ferrocyanide formed in gas purifiers (see above) by decomposition with ferrous sulphate. J. Bueb (Congress of German Gas Industries, March 1900) brings gas (free from tar) into intimate contact with a saturated solution of ferrous sulphate, when a "cyanogen mud" is obtained. This is heated to boiling, and the residue after filtration contains about 30% of Prussian blue. On the small scale it may be prepared by adding an acid solution of a ferrous salt to a solution of potassium ferrocyanide. The grey precipitate first formed is allowed to stand for some hours, well washed, and then oxidised by a warm solution of ferric chloride: $6\text{K}_2\text{Fe}[\text{Fe}(\text{NC})_6] + 3\text{O} = \text{Fe}_7(\text{NC})_{18} + 3\text{K}_4\text{Fe}(\text{NC})_6 + \text{Fe}_2\text{O}_3$. It is a dark blue powder with a marked coppery lustre. It is insoluble in water and is not decomposed by acids.

Soluble Prussian blue, $\text{K}_2\text{Fe}_2[\text{Fe}(\text{NC})_6]_2$, potassium ferric ferrocyanide, is formed when a solution of potassium ferrocyanide is added to an insufficiency of a solution of a ferric salt (1), or when potassium ferrocyanide is added to a ferrous salt (2):

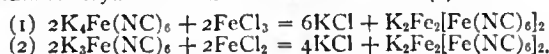

It is soluble in water, but is insoluble in salt solutions.

Potassium ferricyanide, $\text{K}_3\text{Fe}(\text{NC})_6$, red prussiate of potash, is obtained by oxidizing potassium ferrocyanide with chlorine, bromine, &c., $2\text{K}_4\text{Fe}(\text{NC})_6 + \text{Cl}_2 = 2\text{K}_3\text{Fe}(\text{NC})_6 + 2\text{KCl}$. G. Kassner (*Chem. Zeit.*, 1889, 13, p. 1701; 17, p. 1712) adds calcium plumbate to a solution of potassium ferrocyanide and passes carbon dioxide through the mixture: $2\text{K}_4\text{Fe}(\text{NC})_6 + \text{Ca}_2\text{PbO}_4 + 4\text{CO}_2 = 2\text{K}_3\text{Fe}(\text{NC})_6 + \text{K}_2\text{CO}_3 + \text{PbCO}_3 + 2\text{CaCO}_3$. The mixture of calcium and lead carbonates is filtered off and roasted at a low red heat in order to regenerate the calcium plumbate. It crystallizes in dark red monoclinic prisms which are readily soluble in water. The solution decomposes on standing, and in the presence of an alkali acts as an oxidizing agent: $2\text{K}_3\text{Fe}(\text{NC})_6 + 2\text{KHO} = 2\text{K}_4\text{Fe}(\text{NC})_6 + \text{H}_2\text{O} + \text{O}$. With silver nitrate it gives an orange red precipitate of silver ferrocyanide, $\text{Ag}_2\text{Fe}(\text{NC})_6$. With a pure ferric salt it only gives a brown coloration. It can be estimated quantitatively by mixing a dilute solution with potassium iodide and hydrochloric acid in excess, adding excess of zinc sulphate, neutralizing the excess of free acid with sodium bicarbonate, and determining the amount of free iodine by a standard solution of sodium thiosulphate. The zinc sulphate is added in order to remove the ferrocyanide formed as an insoluble zinc salt: $2\text{K}_4\text{Fe}(\text{NC})_6 + 2\text{KI} = 2\text{K}_3\text{Fe}(\text{NC})_6 + \text{I}_2$. As an alternative method it may be decomposed by hydrogen peroxide in alkaline solution and the amount of evolved oxygen measured: $2\text{K}_3\text{Fe}(\text{NC})_6 + 2\text{KHO} + \text{H}_2\text{O}_2 = 2\text{K}_4\text{Fe}(\text{NC})_6 + 2\text{H}_2\text{O} + \text{O}_2$.

Turnbull's blue, $\text{Fe}_2(\text{NC})_{12}$ or $\text{Fe}_3[\text{Fe}(\text{NC})_6]_2$, ferrous ferrocyanide, is best obtained by adding a hot solution of potassium ferricyanide to a ferrous salt, and allowing the mixture to stand some time in the presence of an iron salt: $2\text{K}_3\text{Fe}(\text{NC})_6 + 3\text{FeSO}_4 = \text{Fe}_3[\text{Fe}(\text{NC})_6]_2 + 3\text{K}_2\text{SO}_4$. It is insoluble in dilute acids.

Hydroferricyanic acid, $\text{H}_3\text{Fe}(\text{NC})_6$, obtained by adding concentrated hydrochloric acid to a cold saturated solution of potassium ferricyanide, crystallizes in brown needles, and is easily decomposed.

Nitroprussides.—The nitroprussides are salts of the type $\text{M}_2\text{Fe}(\text{NC})_5\text{NO}$. The free acid forms dark red deliquescent crystals and is obtained by decomposing the silver salt with hydrochloric acid, or the barium salt with dilute sulphuric acid.

Sodium nitroprusside, $\text{Na}_2\text{Fe}(\text{NC})_5\text{NO}_2\text{H}_2\text{O}$, is the commonest salt. It is prepared by oxidizing potassium ferrocyanide with a diluted nitric acid. The solution is evaporated, separated from potassium nitrate, the free acid neutralized with soda, and the solution concentrated. It crystallizes in dark red prisms which are readily soluble in water; it is a valuable reagent for the detection of sulphur, this element when in the form of an alkaline sulphide giving a characteristic purple blue coloration with the nitroprusside. The **potassium salt** may be prepared by adding potassium cyanide to ferrous sulphate solution, the brown precipitate so formed being then heated with potassium nitrite:

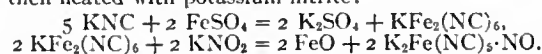

Other complex cyanides are known which may be regarded as derived from the acids $\text{H}_2\text{X}(\text{CN})_4$, $\text{X} = \text{Ni}, \text{Pd}, \text{Pt}$; $\text{H}_3\text{X}(\text{CN})_6$, $\text{X} = \text{Fe}, \text{Co}, \text{Ru}$; $\text{H}_3\text{X}(\text{CN})_6$, $\text{X} = \text{Fe}, \text{Co}, \text{Rh}$; and $\text{H}_2\text{R}(\text{CN})_6$ (see Abegg, *Anorganischen Chemie*).

Organic Cyanides or Nitriles.—Hydrocyanic acid forms two series of derivatives by the exchange of its hydrogen atom for alkyl or aryl groups; namely the **nitriles**, of type $\text{R}\cdot\text{CN}$, and the **isonitriles**, of type $\text{R}\cdot\text{NC}$. The latter compounds may be

considered as derivatives of the as yet unknown isohydrocyanic acid HNC.

Nitriles.—These substances were first isolated in 1834 by J. Pélouze (*Ann.*, 1834, 10, p. 249). They may be prepared by heating the alkyl iodides with potassium cyanide; by heating sulphuric acid esters with potassium cyanide; by distilling the acid-amides with phosphorus pentoxide; and by distilling amines (containing more than five atoms of carbon) with bromine and potash (A. W. Hofmann), for example



In addition to these methods, the nitriles of the aromatic series may be prepared by distilling the aromatic acids with potassium sulphocyanide: $\text{C}_6\text{H}_5\text{CO}_2\text{H} + \text{KCNS} = \text{HCNS} + \text{C}_6\text{H}_5\text{CO}_2\text{K}$, $\text{C}_6\text{H}_5\text{CO}_2\text{H} + \text{HCNS} = \text{C}_6\text{H}_5\text{CN} + \text{H}_2\text{S} + \text{CO}_2$; from the primary aromatic amines by converting them into diazonium salts, which are then decomposed by boiling with potassium cyanide and copper sulphate; by fusing the potassium salts of the sulphonic acids with potassium cyanide; by leading cyanogen gas into a boiling hydrocarbon in the presence of aluminium chloride (A. Desgrex, *Bull. soc. chim.*, 1895, (3) 13, p. 735); and from the syn-aldoximes by the action of acetyl chloride or acetic anhydride.

They are mostly colourless liquids which boil without decomposition, or solids of low melting point. The lower members of the series are somewhat soluble in water. They behave in most respects as unsaturated compounds; they combine with hydrogen to form amines; with water to form acidamides; with sulphuretted hydrogen to form thio-amides; with alcohols, in the presence of acids, to form imido-ethers $\text{R}\cdot\text{C}(\text{NH})\cdot\text{OR}'$; with ammonia and primary amines to form amidines $\text{R}\cdot\text{C}(\text{NH})\cdot\text{NH}_2$; and with hydroxylamine to form amidoximes, $\text{R}\cdot\text{C}(\text{OH})\cdot\text{NH}_2$. When heated with sodium they frequently polymerize. Heated with acids or alkalis they hydrolyse to acids: $\text{RCN} + \text{HCl} + 2\text{H}_2\text{O} = \text{R}\cdot\text{COOH} + \text{NH}_4\text{Cl}$. This reaction shows that the alkyl or aryl group is attached to the carbon atom in the nitrile.

Acetonitrile boils at $81\cdot6^\circ\text{C}$., and is readily miscible with water. **Propionitrile** boils at 97°C .; it is somewhat easily soluble in water, but is thrown out of solution by calcium chloride. It was obtained by E. Frankl and C. C. Graham (*Journ. Chem. Soc.*, 1880, 37, p. 740) by the action of cyanogen gas on zinc ethyl. **Allyl cyanide** boils at 119°C . **Benzonitrile** boils at $190\cdot6^\circ\text{C}$. When solidified it melts at -17°C . It is easily soluble in alcohol and ether.

The **isonitriles** (isocyanides or carbylamines) were first prepared in 1866 by A. Gautier (*Ann.*, 1869, 151, p. 239) by the action of alkyl iodides on silver cyanide, and the distillation of the resulting compound with potassium cyanide in concentrated aqueous solution: $\text{RI} \rightarrow \text{R}\cdot\text{Ag}(\text{NC})_2 \rightarrow \text{R}\cdot\text{NC} + \text{KAg}(\text{NC})_2$. They may also be obtained by distilling a primary amine with alcoholic potash and chloroform: $\text{R}\cdot\text{NH}_2 + \text{HCl} + 3\text{KHO} = 3\text{KCl} + 3\text{H}_2\text{O} + \text{R}\cdot\text{NC}$ (A. W. Hofmann, *Ann.*, 1868, 146, p. 107). They are colourless liquids, readily soluble in alcohol and in ether, but insoluble in water. They possess an exceedingly unpleasant smell and are poisonous. They boil at temperatures somewhat lower than those of the corresponding nitriles; and are stable towards alkalis, but in the presence of mineral acids they readily hydrolyse, forming primary amines and formic acid: $\text{RNC} + 2\text{H}_2\text{O} = \text{RNH}_2 + \text{H}_2\text{CO}_2$. This reaction shows that the alkyl or aryl group is linked to the nitrogen atom. The carbon atom in the isonitriles is assumed by J. U. Nef to be divalent, since these substances readily form addition compounds, such addition taking place on the carbon atom, as is shown by the products of hydrolysis; for example with ethyl carbylamine:—



This view was confirmed by J. Wade (*Journ. Chem. Soc.*, 1902, 81, p. 1596) who showed that the products obtained by the action of alkyl iodides on the isonitriles in alcoholic solution at 100°C . yield amine hydroiodides and formic acid when hydrolysed. Such a reaction can only take place if the addition of the alkyl group takes place on the nitrogen atom of the isonitrile, from which it follows that the nitrogen atom must be trivalent and consequently the carbon atom divalent. The reactions may probably be represented as follows:—

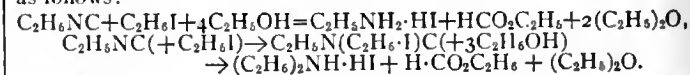

The isonitriles dissolve silver cyanide readily, forming a soluble silver salt (cf. KNC). At 200°C . the isonitriles are converted into nitriles.

Constitution of Metallic Cyanides.—Considerable discussion has taken place as to the structure of the metallic cyanides, since potassium cyanide and silver cyanide react with alkyl iodides to form nitriles and isonitriles respectively, thus apparently pointing to the fact that these two compounds possess the formulae KCN and AgNC. The metallic cyanides are analogous to the alkyl isocyanides, since they form soluble double silver salts, and the fact that ethyl ferrocyanide on distillation yields ethyl isocyanide also points to their isocyanide structure. J. Wade (*loc. cit.*) explains

the formation of nitriles from potassium cyanide, and of isonitriles from silver cyanide by the assumption that unstable addition products are formed, the nature of which depends on the relative state of unsaturation of the carbon and nitrogen atoms under the varying conditions:—

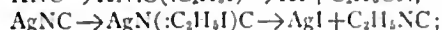

that is, when the metal is highly electro-positive the carbon atom is the more unsaturated, the addition takes place on the carbon atom, and nitriles are produced. The same type of reaction occurs when the metal is relatively electro-positive to the added radical, for example, with ethyl isocyanide and acetyl chloride (see above); compare also $\text{AgNC} \rightarrow \text{AgN}(\text{:Cl}\cdot\text{COCH}_3)_2 \rightarrow \text{AgCl} + \text{Cl}_2\text{COCN}$. On the other hand, when there is but little electro-chemical difference between the radical of the cyanide and that of the reacting compound then the nitrogen atom is the more unsaturated element and isonitriles are produced. This explanation also accounts for the formation of nitriles by the diazo reaction, thus:—

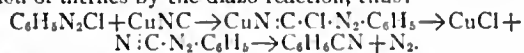

Detection.—The metallic cyanides may be detected by adding ferrous sulphate, ferric chloride, and hydrochloric acid to their solution, when a precipitate of Prussian blue is produced; if the original solution contains free acid it must be neutralized by caustic potash before the reagents are added. As an alternative test the cyanide may be decomposed by dilute hydrochloric acid, and the liberated hydrocyanic acid absorbed in a little yellow ammonium sulphide. The excess of reagent is removed by evaporation and a small quantity of a ferric salt added, when a deep red colour is produced. Silver nitrate gives a white precipitate with cyanides, soluble in excess of potassium cyanide. The amount of hydrocyanic acid in a solution may be determined by adding excess of caustic potash and a small quantity of an alkaline chloride, and running into the dilute solution standard silver nitrate until a faint permanent turbidity (of silver chloride) is produced, that is, until the reaction, $2\text{KNC} + \text{AgNO}_3 = \text{KAg}(\text{NC})_2 + \text{KNO}_3$, is completed.

See R. Robine and M. Lengler, *The Cyanide Industry*, 1906 (Eng. trans. by J. A. Le Clerc); W. Bertelsmann, *Die Technologie der Cyanverbindungen*, 1906.

Pharmacology, Therapeutics and Toxicology of Hydrocyanic Acid.—The pharmacopoeial preparations of this acid are a 2% solution, which is given in doses of from two to six minims, the *tinctura chloroformi et morphinae composita*, which contains a half-minim of this solution in each ten minims, and the *aqua laurocerasi*, which owes its virtues to the presence of this acid, and is of inconstant strength, besides being superfluous. The acid is also the active ingredient of the preparations of Virginian Prune, to which the same strictures apply.

The simple cyanides share the properties of the acid, except those of platinum and iron. With these exceptions, the simple cyanides are readily decomposed even by carbonic acid, free prussic acid being liberated. The double cyanides are innocuous. Hydrocyanic acid is a protoplasmic poison, directly lethal to all living tissues, whether in a plant or an animal. It is by no means the most powerful poison known, for such an alkaloid as pseudaconitine, which is lethal in dose of about 1/200 of a grain, is some hundreds of times more toxic, but prussic acid is by far the most rapid poison known, a single inhalation of it producing absolutely instantaneous death. The acid is capable of passing through the unbroken skin, whereupon it instantly paralyses the sensory nerves. It is very rapidly absorbed from raw surfaces and may thereby cause fatal consequences. It is naturally an antiseptic.

The therapeutic applications of the drug are based entirely upon its anaesthetic or anodyne power. A lotion containing ten minims of the dilute acid to an ounce of water and glycerin will relieve itching due to any cause; and is useful in some forms of neuralgia. It must never be employed when the skin is abraded. The diluted acid is used internally to relieve vomiting or gastric pain. It is also added to cough mixtures, when the cough is of the dry, painful kind, which serves no purpose, as nothing is expectorated. Such a cough is relieved by the sedative action on the central nervous system.

Toxicology.—Instantaneous death results from taking the pure acid. The diluted form, in toxic quantities, will cause symptoms usually within a few seconds. The patient is quite unconscious, the eyes are motionless, the pupils dilated, the skin cold and moist, the limbs relaxed, the pulse is slow and barely perceptible, the respirations very slow and convulsive. *Post mortem*, the body is livid, and the blood very dark. There may be an odour of prussic acid, but this soon disappears.

Treatment is only rarely of use, owing to the rapidity of the toxic action. The patient who survives half-an-hour will probably recover, as the volatile acid is rapidly excreted by the lungs. The drug kills by paralysing the nervous arrangements of the heart and respiration. The appropriate drug is therefore atropine, which stimulates the respiration and prevents the paralysis of the heart.

One-fiftieth of a grain must be immediately injected subcutaneously. The stomach must be washed out and large doses of emetics given as soon as possible. Every second is of consequence. Ammonia should be given by inhalation, and artificial respiration must never be forgotten, as by it the paralysed breathing may be compensated for and the poison excreted. The use of chemical antidotes, such as iron salts, is futile, as the drug has escaped into the blood from the stomach long before they can be administered.

PRUTZ, HANS (1843–), German historian, son of Robert Eduard Prutz (1816–1872), the essayist and historian; was born at Jena on the 20th of May 1843, and was educated at the universities of Jena and Berlin. In 1865 appeared his monograph on Henry the Lion, duke of Saxony and Bavaria, which was followed by three volumes on the emperor Frederick Barbarossa (*Kaiser Friedrich I.*, Danzig, 1871–1874). Meanwhile from 1863 to 1873 he was teaching in secondary schools. In 1874 he received a government commission to undertake explorations in Syria, particularly at Tyre, and as a result he published in 1876 *Aus Phönicien*, a collection of historical and geographical sketches. In the same year appeared his first work on the Crusades, *Quellenbeiträge zur Geschichte der Kreuzzüge*, and a series of monographs on the same subject culminated in 1883 in the notable *Kulturgeschichte der Kreuzzüge*. Then turning to a wider theme Prutz contributed to Oncken's university history the two volumes on the political history of Europe during the middle ages (*Staatengeschichte des Abendlandes im Mittelalter*, Berlin, 1885–1887). In 1888 he reverted to a subject which he had touched upon in his *Geheimlehre und Geheimstatuten des Tempelherrenordens* (Danzig, 1879), and wrote the history of the rise and fall of the Templars (*Entwicklung und Untergang des Tempelherrenordens*), which is noticed in the article **TEMPLARS**. His *Preussische Geschichte* (4 vols., Stuttgart, 1899–1902), which is perhaps his most notable work, is an attempt to apply scientific rather than patriotic canons to a subject which has been mainly in the hands of historians with a patriotic bias. He also wrote *Aus des Grossen Kurfürsten letzten Jahren* (Berlin, 1897) and *Bismarcks Bildung, ihre Quellen und ihre Äusserungen* (Berlin, 1904). In 1902 Prutz resigned the chair of history in the university of Königsberg, which he had held since 1877, and took up his residence at Munich.

PRUTZ, ROBERT EDUARD (1816–1872), German poet and prose writer, was born at Stettin on the 30th of May 1816. He studied philology, philosophy and history at Berlin, Breslau and Halle, and in the last-named became associated, after taking his degree, with Arnold Ruge in the publication of the *Hallesche Jahrbücher*. Subjected on account of his advanced political views to police surveillance, he removed to Jena, where, on the strength of an excellent monograph, *Der Göttinger Dichterbund* (1841), he hoped to obtain an academic appointment. He was, however, expelled from the town for offending against the press laws, and it was not until 1846 that he received permission to lecture in Berlin. From 1849 to 1859 he was extraordinary professor of literature at Halle, but retired in 1859 to Stettin, where he died on the 21st of June 1872.

Prutz belonged to the group of political poets who dominated German literature between 1841 and 1848; his poems are more conspicuous for their liberal tendency than their poetry. Among them may be mentioned *Ein Märchen* (1841); *Gedichte* (1841); *Aus der Heimat* (1858); *Neue Gedichte* (1860); *Herbstrosen* (1865); *Buch der Liebe* (1869). Among his novels are noteworthy, *Das Engelchen* (1851) and *Der Musikantenturm* (1855). Much more important are his contributions to literary history and criticism. *Vorlesungen über die Geschichte des deutschen Theaters* (1847); *Ludwig Holberg* (1857); *Die deutsche Literatur der Gegenwart* (1859), and *Menschen und Bücher* (1862). Prutz also wrote some dramas of little merit.

See R. von Gottschall, in *Unsere Zeit* (1872).

PRYNNE, WILLIAM (1600–1660), English parliamentarian, son of Thomas Prynne by Marie Sherston, was born at Swainswick near Bath in 1600. He was educated at Bath Grammar School, matriculated at Oriel College, Oxford, in 1618, obtained his B.A. in 1621, was admitted a student of Lincoln's Inn the same year, and was called to the Bar in 1628. He was Puritan

to the core, with a tenacious memory, a strength of will bordering upon obstinacy, and a want of sympathy with human nature. His first book, *The Perpetuity of a Regenerate Man's Estate* (1627), defended one of the main Calvinistic positions, and *The Unloveliness of Love-locks and Health's Sickness* (1628) attacked prevailing fashions without any sense of proportion, treating follies on the same footing as scandalous vices.

In 1629 Prynne came forward as the assailant of Arminianism in doctrine and of ceremonialism in practice, and thus drew down upon himself the anger of Laud. *Histrion-mastix*, published in 1633, was a violent attack upon stage plays in general, in which the author pointed out that kings and emperors who had favoured the drama had been carried off by violent deaths, which assertion might easily be interpreted as a warning to the king, and applied a disgraceful epithet to actresses, which, as Henrietta Maria was taking part in the rehearsal of a ballet, was supposed to apply to the queen. After a year's imprisonment in the Tower Prynne was sentenced by the star chamber on the 17th of February 1634 to be imprisoned for life, and also to be fined £5000, expelled from Lincoln's Inn, rendered incapable of returning to his profession, degraded from his degree in the university of Oxford, and set in the pillory, where he was to lose both his ears. The latter portion of the sentence was carried out on the 7th of May, and the rest of his punishment inflicted except the exaction of the fine. There is no reason to suppose that his punishment was unpopular. In 1637 he was once more in the star chamber, together with Bastwick and Burton. In *A Divine Tragedy lately acted* he had attacked the Declaration of Sports, and in *News from Ipswich* he had assailed Wren and the bishops generally. On the 30th of June a fresh sentence, that had been delivered on the 14th, was executed. The stumps of Prynne's ears were shorn off in the pillory, and he was branded on the cheeks with the letters S.L., meaning "seditious libeller," which Prynne, however, interpreted as "*stigmata laudis*." He was removed to Carnarvon Castle, and thence to Mont Orgueil Castle in Jersey, where he occupied himself in writing against popery.

Immediately upon the meeting of the Long Parliament in 1640 Prynne was liberated. On the 28th of November he entered London in triumph, and on the 2nd of March 1641, reparation was voted by the Commons, at the expense of his persecutors. Prynne now attacked the bishops and the Roman Catholics and defended the taking up of arms by the parliament. The words "Touch not mine anointed," he declared in the *Vindication of Psalm cv. ver. 15* (1642), only commanded kings not to oppress their subjects. In 1643 he took an active part in the proceedings against Nathaniel Fiennes for the surrender of Bristol, and showed a vindictive energy in the prosecution of Archbishop Laud. He manipulated the evidence against him, and having been entrusted with the search of Laud's papers, he published a garbled edition of the archbishop's private "Diary," entitled *A Breviate of the Life of Archbishop Laud*. He also published *Hidden Works of Darkness brought to Light* in order to prejudice the archbishop's case, and after his execution, *Canterbury's Doom* . . . an unfinished account of the trial commissioned by the House of Commons. Prynne supported a national church controlled by the state, and issued a series of tracts against independency, including in his attacks Henry Burton his former fellow sufferer in the pillory, John Lilburne and John Goodwin [e.g. *Independence Examined* (1644); *Brief Animadversions on Mr John Goodwin's Theomachia* (1644), &c.]. He denounced Milton's *Divorce at Pleasure*, was answered in the *Colasterion*, and contemptuously referred to in the sonnet "On the Forcers of Conscience." He also opposed violently the Presbyterian system, and denied the right of any Church to excommunicate except by leave of the state [e.g. *Four Short Questions* (1645); *A Vindication of Four Serious Questions* (1645)]. He was throughout an enemy of individual freedom in religion.

Prynne took the side of the parliament against the army in 1647, supported the cause of the eleven impeached members, and visited the university of Oxford as one of the parliamentary

commissioners. On the 7th of November 1648 Prynne was returned as member for Newport in Cornwall. He at once took part against those who called for the execution of Charles, and on the 6th of December delivered a speech of enormous length in favour of conciliating the king. The result was his inclusion in "Pride's Purge" on the morning of the 6th, when, having resisted to military violence, he was imprisoned. After recovering his liberty Prynne retired to Swainswick. On the 7th of June 1649 he was assessed to the monthly contribution laid on the country by parliament. He not only refused to pay, but published *A Legal Vindication of the Liberties of England*, arguing that no tax could be raised without the consent of the two houses. In the same year he began a long account of ancient parliaments, intended to reflect on the one in existence, and in June 1650 he was imprisoned in Dunster Castle, afterwards at Taunton, and in June 1651 at Pendennis Castle. He was at last offered his discharge on giving a bond of £1000 to do nothing to the prejudice of the commonwealth. This he refused, and an unconditional order for his release was given on the 18th of February 1653. After his release Prynne further expressed his feelings in defence of advowsons and patrons, an attack on the Quakers (1655), and in a pamphlet against the admission of the Jews to England (*A Short Demurrer to the Jews*) issued in 1656. On the occasion of the offer of the crown to Cromwell he issued *King Richard the Third Revived* (1657), and on the creation of the new House of Lords *A Plea for the Lords* (1658).

On the restoration of the Rump Parliament by the army of the 7th of May 1659 fourteen of the secluded members, with Prynne among them, claimed admittance. The claim was refused, but on the 9th, through the inadvertence of the door-keepers, Prynne, Annesly and Hungerford succeeded in taking their seats. When they were observed the house purposely adjourned for dinner. In the afternoon the doors were found guarded; the secluded members were not permitted to pass, and a vote was at once taken that they should not again be allowed to enter the house. Wrathful at the failure of his protest and at the continuance of the republican government, Prynne attacked his adversaries fiercely in print. In *England's Confusion*, published on the 30th of May 1659, in the *True and Full Narrative*, and in *The Brief Necessary Vindication*, he gave long accounts of the attempt to enter the house and of his ejection, while in the *Curtaine Drawne* he held up the claims of the Rump to derision. In *Shuffling, Cutting and Dealing*, 26th of May, he rejoiced at the quarrels which he saw arising, for "if you all complain I hope I shall win at last." *Concordia discors* pointed out the absurdity of the constant tendency to multiply oaths, while "remonstrances," "narratives," "queries," "prescriptions," "vindications," "declarations" and "statements" were scattered broadcast. Upon the cry of the "good old cause" he is especially sarcastic and severe in *The True Good Old Cause Rightly Stated* and other pamphlets. *Loyalty Banished* explains itself. His activity and fearlessness in attacking those in power during this eventful year were remarkable, and an ironical petition was circulated in Westminster Hall and the London streets complaining of his indefatigable scribbling. On the 27th of December Prynne made another fruitless attempt to take his seat. In obedience to the popular voice, however, on the 21st of February 1660, the ejected members of 1648, led in triumph by Prynne, wearing a basket-hilt sword, re-entered the house. He supported the Restoration in this parliament, and in the Convention Parliament, which met on the 25th of April 1660, and in which he sat for Bath, he urged severe measures against the regicides, and the exclusion of several individuals from the Act of Indemnity. He was foremost in support of the claims of the Presbyterians and against the bishops; advocated the indiscriminate infliction of penalties, and demanded that the officials of the commonwealth should be compelled to refund their salaries. He was nominated a commissioner for disbanding the army, and was appointed keeper of the records in the Tower, a post in which he performed useful services.

Prynne was again returned as member for Bath on the 8th of

May 1661, in spite of the vehement efforts of the Royalists headed by Sir T. Bridge. This parliament was bent upon the humiliation of the Presbyterians, and Prynne appears in his familiar character of protester. On the 18th of this month he moved that the Engagement, with the Solemn League and Covenant, should be burned by the hangman. About the same time he published a pamphlet advocating the reform of the Prayer Book, while a tract issued on the 15th of July, *Sundry reasons against the new intended Bill for governing and reforming Corporations*, was declared illegal, false, scandalous and seditious; Prynne being censured, and only escaping punishment by submission. The continued attacks upon the Presbyterians led him to publish his *Short, Sober, Pacific Examination of Exuberances in the Common Prayer*, as well as the *Apology for Tender Consciences touching Not Bowing at the Name of Jesus*. In 1662 there appeared also the *Brevia parliamentaria rediviva*, possibly a portion of the *Brief Register of Parliamentary Writs*, of which the fourth and concluding volume was published in 1664. During 1663 he served constantly on committees, and was chairman of the committee of supply in July, and again in April 1664.

In the third session Prynne was once more, on the 13th of May 1664, censured for altering the draft of a bill relating to public-houses after commitment, but the house again, upon his submission remitted the offence, and he again appears on the committee of privileges in November and afterwards. In 1665 and 1666 he published the second and first volumes respectively of the *Exact Chronological Vindication and Historical Demonstration of the supreme ecclesiastical jurisdiction exercised by the English kings from the original planting of Christianity to the death of Richard I*. In the latter year especially he was very-busy with his pen against the Jesuits. In January 1667 he was one of three appointed to manage the evidence at the hearing of the impeachment of Lord Mordaunt, and in November of the same year spoke in defence of Clarendon, so far as the sale of Dunkirk was concerned, and opposed his banishment, and this appears to have been the last time that he addressed the house. In 1668 was published his *Aurum reginae or Records concerning Queen-gold*, the *Brief Animadversions on Coke's Institutes* in 1669, and the *History of King John, Henry III. and Edward I.*, in which the power of the Crown over ecclesiastics was maintained, in 1670. The date of the *Abridgment of the Records of the Tower of London*, published 1680, is doubtful, though the preface is dated 1656-1657. Prynne died unmarried, in his lodgings at Lincoln's Inn, on the 24th of October 1669, and was buried in the walk under the chapel there. He left one portion of his books to Lincoln's Inn and another to Oriel College. His works number about 200 and occupy, together with the replies which they excited, twenty-four columns in the catalogue of the British Museum. Lists of them are given in Wood's *Athnae Oxonienses* (ed. P. Bliss), vol. iii., and in *Documents relating to the Proceedings against William Prynne*.

BIBLIOGRAPHY.—Article by C. H. Frith in the *Dict. of Nat. Biography*; Life of Prynne, in Wood's *Ath. Oxon.*, ed. by Bliss, iii. 844; *Documents relating to the Proceedings against Prynne*, ed. by S. R. Gardiner for the Camden Society (1877); *Hist. of Swainswick*, by R. E. M. Peach; Gardiner's *Hist. of England, of the Civil War and of the Commonwealth*; *Notes and Queries*, 8th series, vol. viii. p. 361 ("Letter to Charles II., May 2, 1660"), 9th series, vol. ii. p. 336. (S. R. G.; P. C. Y.)

PRYOR, ROGER ATKINSON (1828—), American jurist and politician, was born near Petersburg, Virginia, on the 10th of July 1828. He graduated at Hampden-Sidney College in 1845 and at the law school of the university of Virginia in 1848, and in 1849 was admitted to the bar, but devoted himself for some years to journalism. He served as a Democrat in the National House of Representatives from December 1859 to March 1861, and was re-elected for the succeeding term, but owing to the secession of Virginia did not take his seat. He served in the provisional Confederate congress (1861) and also in the first regular congress (1862) of the Confederate constitution. He entered the Confederate army as a colonel, became a brigadier-general (April 16, 1862), and took part in the battles of Williamsburg, Seven Pines, second Bull Run and Antietam. Owing to a

disagreement with President Davis he resigned his commission in 1863, but entered General Fitzhugh Lee's cavalry as a private in August of that year. He was taken prisoner on the 28th of November 1864, but was released on parole by order of the president. In 1865 he removed to New York City, where he practised law. He was judge of the New York court of common pleas in 1890-1894, and of the New York supreme court in 1894-1899. His wife, Sara Agnes (Rice) Pryor (b. 1830), published *The Mother of Washington and her Times* (1903), *Reminiscences of Peace and War* (1904), *The Birth of the Nation* (1907), and *My Day: Reminiscences of a Long Life* (1909).

PRYTANEUM and **PRYTANIS** (Gr. root *πρo*, first or chief).

1. In general in ancient Greece, each state, city or village possessed its own central hearth and sacred fire, representing the unity and vitality of the community. The fire (cf. at Rome the fire in the temple of Vesta) was kept alight continuously, tended by the king or members of his family (cf. at Rome the vestal virgins, originally perhaps the daughters of the king). The building in which this fire was kept was the Prytaneum, and the chieftain (the king or prytanis) probably made it his residence. The word Prytanis (plur. *Prytanis*) is generally applied specially to those who, after the abolition of absolute monarchy, held the chief office in the state. Rulers of this name are found at Rhodes as late as the 1st century B.C. The Prytaneum was regarded as the religious and political centre of the community and was thus the nucleus of all government, and the official "home" of the whole people. When members of the state went forth to found a new colony they took with them a brand from the Prytaneum altar to kindle the new fire in the colony;¹ the fatherless daughters of Aristides, who were regarded as children of the state at Athens, were married from the Prytaneum as from their home; Thucydides informs us (ii. 15) that in the Synoecism of Theseus (see **ATHENS**) the Prytanica of all the separate communities were joined in the central Prytaneum of Athens as a symbol of the union; foreign ambassadors and citizens who had deserved especially well of the state were entertained in the Prytaneum as public guests. In Achaea, this central hall was called the Leiton (town-hall), and a similar building is known to have existed at Elis. This site of the Prytaneum at Athens cannot be definitely fixed; it is generally supposed that in the course of time several buildings bore the name. The Prytaneum, mentioned by Pausanias, and probably the original centre of the ancient city, was situated somewhere east of the northern cliff of the Acropolis. Hence the frequent confusion with the Tholos which was near the council chamber and was the residence of the Prytanis (see below) of the council. Curtius places the original Prytaneum south of the Acropolis in the Old Agora, speaks of a second identical with the Tholos in the Cerameicus, and regards that of Pausanias as a building of Roman times (*Stadtgeschichte*, p. 302). Wachsmuth holds the former view and regards the Tholos as merely a dining-room for the Prytanis in the old democratic period. Many authorities hold that the original Prytaneum of the Cecropian city must have been on the Acropolis. From Aristotle's *Constitution of Athens* (ch. 3) we know that the Prytaneum was the official residence of the Archons, but, when the new Agora was constructed (by Peisistratus?), they took their meals in the Thesmothetium for the sake of convenience. There was also a court of justice called the court of the Prytaneum; all that is known of this court is that it tried murderers who could not be found, and inanimate objects which had caused death. Judging from its rather fanciful functions and from its name, it is probably a relic of the pre-historic jurisdiction of the patriarch-king.

2. For the **PRYTANEIS** of the Boulē and of the Naucrarias, see **BOULÉ** and **NAUCRARY**.

3. **PRYTANEA** were court-fees paid when the prosecutor was claiming a part of the penalty which the defendant would be called upon to pay if he lost.

4. **PRYTANIS** was also the name of a legendary king of Sparta of the Eurypontid or Proclid line. He was the son of Eurypon and fourth in descent from Procles.

¹ Cf. Indian tribes of North America.

BIBLIOGRAPHY.—On the Prytanum as the centre of an ancient state see article FIRE, and references in a paper (s.v.) by Frazer (*Journal of Philology*, 1885, xiv. 28). For the site of the Athenian P. see E. Curtius, *Attische Studien*, and an article by Schöll (*Hermes*, v. 340); also general histories of Greece.

PRZEMYŚL, a town of Austria, in Galicia, 60 m. W. of Lemberg by rail. Pop. (1900), 46,295, mostly Polish. It is situated on the river San and is one of the strongest fortresses in Galicia. Przemyśl is the seat of a Roman Catholic and of a Greek uniat bishop, and has a Roman Catholic cathedral, begun in 1460. The industries comprise the manufacture of machinery, liqueurs and spodium or tutty, the refining of naphtha, corn-milling and the sawing of timber. The trade is chiefly in timber, corn, leather and linen. On the hill above the town are the ruins of an old castle, said to have been founded by Casimir the Great.

Przemyśl, one of the oldest towns in Galicia, claims to have been founded in the 8th century, and was at one time capital of a large independent principality. Casimir the Great and other Polish princes endowed it with privileges similar to those of Cracow, and it attained a high degree of prosperity. In the 17th century its importance was destroyed by inroads of Tatars, Cossacks and Swedes.

PRZEVALSK, formerly Karakol (renamed in 1889), a town of Russian Turkestan, in the province of Semiryechensk, 8 m. S.E. of Lake Issyk-kul. Nikolai Przevalsky (Przevalsky *q.v.*), the Russian explorer in Central Asia, died here in 1889, and a monument has been erected to his memory. It is a growing town, and had in 1897 a population of 7985.

PSALM (from the Gr. word ψάλλειν, to play the harp), the name used to designate the religious poems of the Hebrews, which are contained in the Psalter (see PSALMS, BOOK OF). Modern collections of religious poetry sometimes bear the title of *Psalms and Hymns*, but these are always more or less directly connected with the actual Psalms of David. Longfellow wrote "A Psalm of Life" (1839), which was an intimate confession of the religious aspirations of the author. The *Psaumes* of Clément Marot (1538) were curious adaptations of Hebrew ideas to French forms of the epigram and the madrigal. But it is doubtful whether the psalm, as distinguished from the Hebrew *Psalter*, can be said to have any independent existence. It is loosely used to describe any exalted strain of devotional melody. (See also HYMNS.)

PSALMANAZAR, GEORGE (c. 1679–1763), French adventurer, was born about 1679, probably in Languedoc. According to his own account he was sent in his seventh year to a free school taught by two Franciscan monks, after which he was educated in a Jesuit college "in an archiepiscopal city." On leaving college he became a private tutor. He assumed personations in order to obtain money, his first being that of a pilgrim to Rome. Afterwards he travelled through Germany, Brabant and Flanders in the character of a Japanese convert. At Liège he enlisted in the Dutch service, shortly after which he posed as an unconverted Japanese. At Sluys he made the acquaintance of a Scottish chaplain, by whom he was brought over to England and introduced to the bishop of London. Having undergone conversion to Christianity, he was employed by the bishop to translate the Church catechism into what was supposed to be the Japanese language. In 1704 he published a fictitious *Historical and Geographical Description of Formosa*, and was shortly afterwards sent to Oxford. In 1707 he published *Dialogue between a Japanese and a Formosan*. There also appeared, without date, *An Inquiry into the Objections against George Psalmanazar of Formosa, with George Psalmanazar's Answer*. His pretensions were from the beginning doubted by many, and when exposure was inevitable he made a full confession. Throughout the rest of his life he exhibited, according to Dr Samuel Johnson, as reported by Mrs Piozzi, "a piety, penitence, and virtue exceeding almost what we read as wonderful in the lives of the saints." Psalmanazar published *Essays on Scriptural Subjects* (1753), contributed various articles to the *Ancient Universal History*, and completed Palmer's *History of Printing*. He died in London on the 3rd of May 1763. His memoirs appeared in 1764 under the title, *Memoirs of . . . commonly known by the name of George*

Psalmanazar, but do not disclose his real name or the place of his birth.

PSALMS, BOOK OF, or PSALTER, the first book of the Hagiographa in the Hebrew Bible.

Title and Traditional Authorship.—The Hebrew title of the book is שְׁמִינִי, *šēminī*, or שְׁמִינִי דָּוִד "the book of hymns," or rather "songs of praise."¹ The singular שְׁמִינִי is properly the infinitive or *nomen verbi* of שָׁמַע, a verb employed in the technical language of the Temple service for the execution of a jubilant song of praise to the accompaniment of music and the blare of the priestly trumpets (1 Chron. xvi. 4 seq., xxv. 3; 2 Chron. v. 12 seq.). The name is not therefore equally applicable to all psalms, and in the later Jewish ritual the synonym *Hallel* specially designates two series of psalms, cxiii–cxviii. and cxlvi.–cl., of which the former was sung at the three great feasts—the encaenia, and the new moon, and the latter at the daily morning prayer. That the whole book is named "praises" is clearly due to the fact that it was the manual of the Temple service of song, in which praise was the leading feature. But for an individual psalm the usual name is שִׁיר (in the Bible only in titles of psalms), which is applicable to any piece designed to be sung to a musical accompaniment. Of this word ψαλμός, "psalm," is a translation, and in the Greek Bible the whole book is called ψαλμοί or ψαλτήριον.² The title ψαλμοί or βιβλὸς ψαλμῶν is used in the New Testament (Luke xx. 42, xxiv. 44; Acts i. 20), but in Heb. iv. 7 we find another title, namely "David." Hippolytus tells us that in his time most Christians said "the Psalms of David," and believed the whole book to be his; but this title and belief are both of Jewish origin, for in 2 Macc. ii. 13 τὰ τοῦ Δαυὶδ means the Psalter, and the title of the apocryphal "Psalter of Solomon" implies that the previously existing Psalter was ascribed to David. Jewish tradition does not make David the author of all the psalms; but as he was regarded as the founder and legislator of the Temple psalmody (1 Chron., *ut supra*; Ezra iii. 10; Neh. xii. 36, 45 seq.; Ecclus. xlvii. 8 seq.), so also he was held to have completed and arranged the whole book, though according to Talmudic tradition³ he incorporated psalms by ten other authors, Adam, Melchizedek, Abraham, Moses, Heman, Jeduthun, Asaph, and the three sons of Korah. With this it agrees that the titles of the psalms name no one later than Solomon, and even he is not recognized as a psalmist by the most ancient tradition, that of the LXX., which omits him from the title of Ps. cxxvii. and makes Ps. lxxii. be written not by him but of him. The details of the tradition of authorship show considerable variation; according to the Talmudic view Adam is author of the Sabbath psalm, xcii., and Melchizedek of Ps. cx., while Abraham is identified with Ethan the Ezrahite (Ps. lxxxix.). But, according to older Jewish tradition attested by Origen,⁴ Ps. xcii. is by Moses, to whom are assigned Ps. xc.–c. inclusive, according to a general rule that all anonymous pieces are by the same hand with the nearest preceding psalm whose author is named; and Ps. cx., which by its title is Davidic, seems to have been given to Melchizedek to avoid the dilemma of Matt. xxii. 41 seq. Origen's rule accounts for all the psalms except i. and ii., which were sometimes reckoned as one poem (Acts xiii. 33 in the Western text; Origen; *B. Berakhoth*, f. 9b.), and appear to have been ascribed to David (Acts iv. 25).

The opinion of Jerome (*Praef. in ps. heb.*) and other Christian writers that the collector of the Psalter was Ezra does not seem to rest on Jewish tradition.

Nature and Origin of the Collection.—Whatever may be the value of the titles to individual psalms, there can be no question that the tradition that the Psalter was collected by David is not historical;

¹ Hippol., ed. Lag., p. 188; Euseb. *H.E.* vi. 25, 2; Epiph. *Mens et Pond.* § 23; Jerome's preface to *Psalt. juxta Hebraeos*.

² Similarly in the Syriac Bible the title is *mazmōrē*.

³ The passages are collected in Kimhi's preface to his commentary on the Psalms, ed. Schiller-Szinessy, Cambridge (1883).

⁴ *Opp.* ii. 514 seq., ed. Rue; cf. Hippol. *ut supra*; Jerome, *Ep.* cxi. (ed. Cypr.), and *Praef. in Mal.*

for no one doubts that some of the psalms date from after the Babylonian exile. The truth that underlies the tradition is that the collection is essentially the hymn-book of the second Temple,¹ and it was therefore ascribed to David, because it was assumed, as we see clearly from Chronicles, that the order of worship in the second temple was the same as in the first, and had David as its father: as Moses completed the law of Israel for all time before the people entered Canaan, so David completed the theory and contents of the Temple psalmody before the Temple itself was built. When we thus understand its origin, the tradition becomes really instructive, and may be translated into a statement which throws light on a number of points connected with the book, namely, that the Psalter was (finally, at least) collected with a liturgical purpose. Thus, though the psalms represent a great range of individual religious experience, they avoid such situations and expressions as are too unique to be used in acts of public devotion. Many of the psalms are doxologies or the like, expressly written for the Temple; others are made up of extracts from older poems in a way perfectly natural in a hymn-book, but otherwise hardly intelligible. Such ancient hymns as Exod. xv. 1 sqq., Judges v., 1 Sam. ii. 1 sqq., are not included in the collection, though motives from them are embodied in more modern psalms: the interest of the collector, we see, was not historical but liturgical.

The question now arises: Was the collection a single act or is the Psalter made up of several older collections? And here we have first to observe that in the Hebrew text the Psalter is divided into five books, each of which closes with a doxology. The scheme of the whole is as follows:—

Book I., Ps. i.—xli.; all these are ascribed to David except i., ii., x. (which is really part of ix.), xxxiii. (ascribed to David in LXX.); doxology, xli. 13. Book II., Ps. xlii.—lxxii.: of these xlii.—xlix. are ascribed to the Korahites (xliii. being part of xlii.), l. to Asaph, li.—lxxi. to David (except lxvi., lxvii., lxxi. anonymous; in LXX. the last two bear David's name), lxxii. to Solomon; doxology, lxxii. 18, 19 followed by the subscription "The prayers of David the son of Jesse are ended." Book III., Ps. lxxiii.—lxxxix.; here lxxiii.—lxxxiii. bear the name of Asaph, lxxxiv., lxxxv., lxxxvii., lxxxviii. that of the Korahites, lxxxvi. of David, lxxxviii. of Heman, lxxxix. of Ethan; doxology, lxxxix. 52. Book IV., Ps. xc.—cvi.: all are anonymous except xc. (Moses), ci., ciii. (David).—LXX. gives also civ. to David; here the doxology is peculiar, "Blessed be Jehovah God of Israel from everlasting and to everlasting. And let all the people say Amen, Hallelujah." Book V., Ps. cvii.—cl.: of these cviii.—cx., cxvii., cxviii., cxviii., cxviii.—cxlv. are ascribed to David and cxvii. to Solomon, and cxv.—cxviii. are pilgrimage psalms, LXX. varies considerably from the Hebrew as to the psalms to be ascribed to David; the book closes with a group of doxological psalms.

The division into five books was known to Hippolytus, but a closer examination of the doxologies shows that it does not represent the original scheme of the Psalter; for, while the doxologies to the first three books are no part of the psalms to which they are attached, but really mark the end of a book in a pious fashion not uncommon in Eastern literature, that to book IV., with its rubric addressed to the people, plainly belongs to the psalm, or rather to its liturgical execution, and does not therefore really mark the close of a collection once separate. In point of fact books IV. and V. have so many common characters that there is every reason to regard them as a single great group. Again, the main part of books II. and III. (Ps. xlii.—lxxxiii.) is distinguished from the rest of the Psalter by habitually avoiding the name Jehovah (the Lord) and using Elohim (God) instead, even in cases like Ps. l. 7, where "I am Jehovah thy God" of Exod. xx. 2 is quoted but changed very awkwardly to "I am God thy God." This is not due to the authors of the individual psalms, but to an editor; for Ps. liii. is only another recension of Ps. xiv., and Ps. lxx. repeats part of Ps. xl., and here Jehovah is six times changed to Elohim, while the opposite change happens but once. The Elohim psalms, then, have undergone a common editorial treatment, distinguishing them from the rest of the Psalter. And they make up the mass of books II. and III., the remaining psalms, lxxxiv.—lxxxix., appearing to be a sort of appendix. But when we look at the Elohim psalms more nearly, we see that they contain two distinct elements, Davidic psalms and psalms ascribed to the Levitical choirs (sons of Korah, Asaph). The Davidic collection as we have it splits the Levitical psalms into two groups and actually divides the Asaphic Ps. l. from the main Asaphic collection, lxxiii.—lxxxiii. This order can hardly be original, especially as the Davidic Elohim psalms have a separate subscription (Ps. lxxii. 20). But if we remove them we get a continuous body of Levitical Elohim psalms, or rather two collections, the first Korahitic and the second Asaphic, to which there have been added by way of appendix by a non-Elohistic editor a supplementary group of Korahite psalms and one psalm (certainly late) ascribed to David. The formation of books IV. and V. is certainly later than the Elohistic redaction of books II. and III., for Ps. cviii. is made up of two Elohim psalms (lvii. 7–11, lx. 5–12) in the Elohistic form, though the last two books of the Psalter are generally

Jehovistic. We can thus distinguish the following steps in the redaction: (a) the formation of a Davidic collection (book I.) with a closing doxology; (b) a second Davidic collection (li.—lxxii.) with doxology and subscription; (c) a twofold Levitical collection (xlii.—xlix.; l., lxxiii.—lxxxiii.); (d) an Elohistic redaction and combination of (b) and (c); (e) the addition of a non-Elohistic supplement to (d) with a doxology; (f) a collection later than (d), consisting of books IV. and V. And finally the anonymous psalms i., ii., which as anonymous were hardly an original part of book I., may have been prefixed after the whole Psalter was completed. We see, too, that it is only in the latest collection (books IV., V.) that anonymity is the rule, and titles, especially titles with names, occur only sporadically. Elsewhere the titles run in series and correspond to the limits of older collections.

Date of the Collection.—An inferior limit for the final collection is given by the Septuagint translation. But this translation was not written all at once, and its history is obscure; we only know from the prologue to Ecclesiasticus that the *Italographa*, and doubtless therefore the Psalter, were read in Greek in Egypt about 130 n.c. or somewhat later.¹ And the Greek Psalter, though it contains one apocryphal psalm at the close, is essentially the same as the Hebrew; there is nothing to suggest that the Greek was first translated from a less complete Psalter and afterwards extended to agree with the extant Hebrew. It is therefore reasonable to hold that the Hebrew Psalter was completed and recognized as an authoritative collection long enough before 130 b.c. to allow of its passing to the Greek-speaking Jews in Alexandria. Beyond this the external evidence for the completion of the collection does not carry us.

(W. R. S.)

But there is absolutely no necessity for supposing that when the grandson of Ben Sira reached Egypt the Psalter had been translated into Greek for any considerable time. Indeed it is at least equally probable that it was the recent translation of some of the poetical books of the Old Testament which fired him with a desire to translate his grandfather's book, and perhaps add the work of a member of the family to the Bible of the Egyptian Jews. It appears indeed from 1 Chron. xvi., 2 Chron. vi. 41, 42, that various psalms belonging to books IV. and V. were current in the time of the Chronicler. Unfortunately however it is impossible to date the book of Chronicles with certainty. The argument that the Chronicler must have been contemporary with the last persons named in his book is by no means convincing and on the other hand his account of the Temple services, in which he seems to be describing the Temple of his own days, harmonizes far better with a date at the end of the third, or even in the second, century b.c. than with the close of the Persian or the beginning of the Greek period. For the impression which we get from Nehemiah's memoirs is that in his days the community at Jerusalem was in the main poverty-stricken, while Malachi's exhortations to the people to pay their dues to the priests implies that in the middle of the fifth century b.c. the Temple was by no means wealthy. But in the comparative peace and freedom of the 3rd century b.c. the condition of Jerusalem was greatly ameliorated. Wealth accumulated to such a degree that Simon the son of Oniah was enabled practically to rebuild the Temple, and to maintain its services with a grandeur of ritual which they had probably never known before. It must be admitted that the gorgeousness of ritual described by the Chronicler is far more in harmony with the days of Simon than with any previous post-exilic period. How late the Chronicler wrote cannot perhaps be determined; but it is, at all events, impossible to prove that the author of Ecclesiasticus was acquainted with his work. Ben Sira indeed in his list of worthies mentions Zerubbabel, Joshua and Nehemiah; but Zerubbabel and Joshua he must have known from the books of Haggai and Zechariah, and he may well have been acquainted with that document relating to Nehemiah which the Chronicler incorporated with his book. Ben Sira's omission of the name of Ezra rather militates against the supposition that he had the Chronicler's book before him when he wrote. The conflict between Saduceism and the *sopherim* was hardly so intense in his days as to warrant the supposition that he omitted the name of Ezra intentionally. Moreover, it is not certain that the psalms that the Chronicler quotes (xcvi., cv., cvi., cxxxii.)

¹ The text of the passage is obscure and in part corrupt, but the Latin "cum multum temporis ibi fuisset" probably expresses the author's meaning. A friend has written to the author that for *συγγραφίας* we ought perhaps to read *συχνόν ἐγγραφίας*.

¹ This must be understood of the whole collection as completed, not of all its component parts. (R. H. K.)

already existed in their place in our Psalter, or that Ps. cvii. even existed in its present form.

Other evidence of date is to be found in the Levitical psalms of the Elohist collection. These, as we have seen, form two groups, referred to the sons of Korah and to Asaph. In Nehemiah xii. 46 Asaph is taken to be a contemporary of David and chief of the singers of his time, and in 1 Chron. xxv. 1 seq. one of the three chief singers belonging to the three great Levitical houses. But the older history knows nothing of an individual Asaph; in Ezra ii. 41 the gild of singers as a whole is called Bnē Asaph, as it was apparently in the time of Nehemiah (Neh. xi. 22, Heb.).¹ The singers or Asaphites are at this time still distinguished from the Levites; the oldest attempt to incorporate them with that tribe appears in Exod. vi. 24, where Abiasaph—that is, the eponym of the gild of Asaphites—is made one of the three sons of Korah. But when singers and Levites were fused the Asaphites ceased to be the only singers, and ultimately, as we see in Chronicles, they were distinguished from the Korahites and reckoned to Gershon (1 Chron. vi.), while the head of the Korahites is Heman, as in the title of Ps. lxxxviii. It is only in the appendix to the Elohist psalm-book that we find Heman and Ethan side by side with Asaph, as in the Chronicles; but this does not necessarily prove that the body of the collection originated when there were only two guilds of singers.

But here it becomes necessary to ask what is the precise meaning which we are to assign to the phrases, "to David," "to Asaph," "to the sons of Korah." We certainly need not suppose that the Davidic, Asaphic and Korahite psalms severally once existed as separate books, for, if this had been the case, it is probable that the ascription would not have been prefixed to each separate psalm, but rather to the head of each collection (cf. Prov. i. 1, x. 1, xxv. 1), together with some such note at the end as is found in Job. xxxi. 40, Ps. lxxii. 20; moreover we should be compelled to assent to the view expressed in the Oxford Dictionary that those psalms which have the heading לְדָוִד (A. V. "to"—R. V. "for"—"the chief Musician") also originally formed a separate collection. But against this explanation of the heading לְדָוִד there is an almost insuperable objection; for, since both the first and second books contain psalms with this heading, it is clear that the "Chief Musician's—or Director's—Psalter" must have been in existence before either of these books; in which case, apart from the difficulty of the antiquity which we should be compelled to assign to this earliest Psalter, it is impossible to understand on what principle the first book of Psalms was formed. If the compiler of the first book aimed simply at making a collection of Davidic psalms from a major Psalter compiled by the "Director," why should he have deliberately rejected a number of Davidic psalms (Ps. li. sqq.) which, *ex hypothesi*, lay before him in this Psalter? It is surely as difficult to suppose that the Davidic psalms of the first book are a selection made from a greater collection of such psalms contained in the "Director's Psalter" as it is to imagine that St Mark's Gospel is an abridgment of St Matthew's. It is true that the preposition "to" (לְ) may denote authorship, as it does apparently in Isaiah xxxviii. 9, Hab. iii. 1, but it certainly has a much wider meaning; and indeed in some cases the idea of authorship is out of the question, for the psalms ascribed to the Korahites can scarcely have been supposed to be the joint composition of that body. Moreover, it is very doubtful whether the word לְדָוִד can be translated "Director." In 1 Chron. xv. 21 the verb of which לְדָוִד is the participle is used of the duty which was discharged by Mattithiah, Eliphehu, Mikneiah, Obed-edom, Jeiel and Azaziah (and perhaps, if verse 20 is to be taken in close connexion with verse 21, by Zechariah, Aziel, Shemiramoth, Jeiel, Unni, Eliab, Maaseiah and Benaiah also) *on one definite occasion*. Unfortunately the exact nature of these men's performances is not quite clear, for it is said to have been connected with "harps set to the sheminith," or according to another interpretation, with "harps over the tenors." But whatever the obscure expression לְדָוִד may mean, לְדָוִד cannot here mean to "direct," for a choir with six "directors" would have been a veritable bear-garden. Obviously the word לְדָוִד must refer to something in the music; and inasmuch as the cymbals were for the purpose of producing a volume of sound (לְדָוִד), it is reasonable to suppose that the

musicians with treble lutes and with harps an octave lower (or with lutes and harps over the sopranos and tenors respectively) were to lead the singers in giving out the melody. If this explanation be correct—and it certainly accords best with the meaning of לְדָוִד in 1 Chron. xv. 21—the לְדָוִד will be that part of the orchestra which played the melody to be sung, virtually corresponding, *mutatis mutandis*, to what we now call the *choir organ*, and we need not complicate the compilation of the Psalter by postulating an altogether unnecessary "Director's Psalter." Now we have seen that the לְדָוִד prefixed to לְדָוִד cannot refer to authorship; we seem therefore shut up to one of two alternatives, either the psalms inscribed לְדָוִד belonged to the *répertoire* of the Korahites, or they were intended to be sung in the Korahite style. It is indeed possible that each division of the Levitical singers had its own collection; but this is hardly probable unless we are to suppose that they never officiated simultaneously, in which case we should certainly have expected that the psalm quoted by the Chronicler (1 Chron. xvi.) would be included in the Asaphic collection. But there is no difficulty in supposing that each division of the Levitical musicians had its own traditional music, certain instruments being peculiar to the one and certain to the other, in which case the assignment of a psalm to the Asaphites or Korahites will merely denote the sort of music to which it is set. In like manner it is not improbable that לְדָוִד meant originally "to be sung in the Davidic mode";² that is, perhaps, "with harp accompaniment" (cf. 1 Sam. xvi. 16), or, since the Chronicler ascribes to David the initiation of the Temple music, "in the oldest traditional mode." Under such circumstances, however, a confusion would easily arise between the composer of the tune and the author; and when once the idea had arisen that David was the *author* of psalms, it would be natural to endeavour to discover in the story of his life suitable occasions for their composition.

The interpretation of the titles here suggested removes an objection brought against the assumption of a Maccabean date for certain psalms, which lays stress on the fact that some of them, e.g. Ps. xlii., are written in a time of the deepest dejection, and yet are psalms of the Temple choirs; whereas, when the Temple was re-opened for worship, after its profanation by Antiochus, the Jews were victorious, and a much more joyful tone was appropriate. For if the titles לְדָוִד , לְאֶסָפִי , &c., do not denote that the psalms so inscribed were collected by the Temple choirs, there is no evidence that these psalms were *originally* sung in the Temple. The earlier collections of psalms may well have been used first in synagogues, and only adapted to the Temple worship when they had become part of the devotional life of the people. It is noteworthy that the psalms quoted by the Chronicler belong to the last collection, books IV. and V., which, as a whole, is far more suitable for liturgical use.

Since, then, the existence of separate books of psalms anterior to the present divisions of the Psalter is very doubtful, we must look for other evidences of date. Now, both the Korahite and Asaphic groups of psalms are remarkable that they hardly contain any recognition of present sin on the part of the community of Jewish faith—though they do confess the sin of Israel in the past—but are exercised with the observation that prosperity does not follow righteousness either in the case of the individual (xlix., lxxiii.) or in that of the nation, which suffers notwithstanding its loyalty to God, or even on account thereof (xliv., lxxix.). Now the rise of the problems of individual faith is the mark of the age that followed Jeremiah, while the confident assertion of national righteousness under misfortune is a characteristic mark of pious Judaism after Ezra, in the period of the law but not earlier. Malachi, Ezra and Nehemiah, like Haggai and Zechariah, are still very far from holding that the sin of Israel lies all in the past. Again, a considerable number of these psalms (xliv., lxxiv., lxxix., lxxx.) point to an historical situation which can be very definitely realized. They are post-exilic in their whole tone and belong to a time when prophecy had ceased and the synagogue worship was fully established (lxxiv. 8, 9). But the Jews are no longer the obedient slaves of the oppressing power; there has been a national rising and armies have gone forth to battle. Yet God has not gone forth with them: the heathen have been victorious, blood has flowed like water round Jerusalem, the Temple has been defiled, and these disasters assume the character of a religious persecution. These details would fit the time of religious persecution under Antiochus, to which indeed Ps. lxxiv. is referred (as a prophecy) in 1 Macc. vii. 16. It is contended by those who, like the late Professor W. Robertson Smith, are opposed to the dating of any psalms of the second collection in the Maccabean period, that, since they are post-exilic, there is one and only one time in the Persian period to which they can be referred, viz. that of the great civil wars under Artaxerxes III. Ochus (middle of 4th

¹ The threefold division of the singers appears in the same list according to the Hebrew text of verse 17, but the occurrence of Jeduthun as a proper name instead of a musical note is suspicious, and makes the text of LXX. preferable. The first clear trace of the triple choir is therefore in Neh. xii. 24.

² Some confirmation of this explanation of the titles may be found in the fact that in place of לְדָוִד (Ps. xxxix. 1) we find in lxii. 1, lxxvii. 1, לְדָוִד , the latter expression being apparently an abbreviation of לְדָוִד .

century, B.C.). But there is no evidence that the Jews were involved in these; for the account which Josephus gives of Bagoses' oppression of the Jews represents the trouble as having arisen originally from internal dissensions, and does not hint at anything of the nature of a rebellion against Persia. Moreover the statement of Eusebius (*Chron. anno 1658 Abr.*) that Artaxerxes Ochus in the course of his campaign against Egypt transported a detachment of Jews to Hyrcania does not prove that Judaea as a whole had revolted. There is nothing even to connect these Jews with Palestine; they may have formed a part of the very considerable Jewish community which we know to have been settled in Egypt as early as the 5th century B.C. On the other hand, it is extremely improbable that the Jews of Judaea, whom Nehemiah had entirely detached from their immediate neighbours, would have taken part in any general rising against Persia. Between them and the Samaritans on the north and the Edomites on the south there was the most implacable hostility, which would probably be sufficient in itself to keep them from joining in the revolts in which other parts of Syria were involved. Moreover, even if the Jews had revolted, it cannot fairly be maintained that such a revolt must necessarily have had a religious character. Even Josephus does not say that the Persians tried to interfere with the Jews in the exercise of their religion; and nothing less than this would satisfy the language of Ps. xlv. 22: "Yea, for thy sake are we killed all the day long," &c. On the other hand, not only is the atmosphere of the second collection of psalms as a whole the atmosphere of godly Judaism in the 2nd century B.C., but it may fairly be claimed that this collection contains many psalms which may naturally be interpreted in the light of the history of that period, of which no satisfactory explanation (in their details) can be given if they are assigned to any other time. Thus, for example, Ps. xlv., with its description of the sufferings of the righteous for God's sake, would be perfectly appropriate in the mouth of one of the "godly" (*Hasidim*) about 167 B.C. Ps. xlv., though the unsoundness of the text in certain parts makes it difficult to speak with certainty, would suit the marriage of Alexander Balas at Ptolemais in 150 B.C., at which the high priest Jonathan was present as an honoured guest. In this connexion verse 10 is particularly appropriate as addressed to an Egyptian princess whose forefathers, though their rule had not on the whole been tyrannical, had been regarded by the Jews as heathen oppressors. Again, Ps. lx., with its ideal description of Jehovah's kingdom as including Gilead, Samaria, Moab, Edom and Philistia, though the ideal was not realized till the days of John Hyrcanus, would be quite appropriate in the mouth of a Maccabean patriot. The author of Ps. lxxviii. would seem to have been inspired by the sight or the description of the never-to-be-forgotten procession of the victorious Maccabees in 164 B.C. to rededicate the desecrated Temple. Hence the taunt to Bashan, the stronghold of the Seleucid government; hence the mention of Judah and Benjamin with the two Galilean tribes Zebulun and Naphtali (as in Isaiah ix. 1—a passage which on independent grounds has been assigned to the time of Simon Maccabaeus), while schismatic Samaria is completely ignored. The historical background of Ps. lxxix. is apparently the same as that of Ps. xlv. Again, Ps. lxxvii. would seem to date from a time when the Jews, having won freedom to worship God, were able to look forward to the conversion of their former oppressors (cf. Isaiah xi., xix.). That this psalm was composed at least as late as the 3rd century B.C. is made probable by the name here given to Egypt, *Rahab*. Having regard to Job. ix. 13, xxvi. 12, Isaiah li. 9, there can be little doubt that *Rahab* is the (? Palestinian) name of *Tiamat* the dragon of the abyss, the natural symbol of the power of darkness, or of the kingdom of the world as opposed to the kingdom of the people of the saints of the Most High God. It is extremely improbable that such a name was applied to Egypt simply because Egypt possessed the crocodile. The origin of its application must be sought in a time when Egypt was regarded as hostile to the people of the Lord—that is to say, during the Ptolemaic rule over Palestine. These considerations, in addition to numerous phrases and expressions which cannot here be noticed, of which the full force can only be felt by those who have specially studied the Maccabean period and those other portions of the Old Testament, such as Zechariah ix.-xiv., which may plausibly be assigned to it, make it almost certain that the second collection of psalms was made not earlier than the time of Jonathan or even of Simon.

Now books IV. and V. are, as we have seen, later than the Elohist redaction of books II. and III., so that the collection of the last part of the Psalter must, if our argument up to this point is sound, fall within the second half of the 2nd century B.C. And here it is to be noted that though no part of the Psalter shows clearer marks of a liturgical purpose, we find that in books IV. and V. the musical titles have entirely disappeared. This does not necessarily prove that "the technical terms of the Temple music had gone out of use, presumably because they were already become unintelligible, as they were when the Septuagint version was made"; for it does not follow that technical musical terms which had originated in the Temple at Jerusalem and were intelligible in Palestine would have been understood in Egypt. The absence of the musical titles, however, may be taken as an indication that the last collection of psalms was formed in a different place from that in which the earlier

collections had arisen; and if, as seems probable, we may identify this place with the Temple at Jerusalem, the absence of musical titles is easily explained, for the number of skilled musicians who there ministered, and who would, of course, possess the tradition of the various modes and tones, would make precise musical directions superfluous. On the other hand, in a collection intended for synagogue use—and the second collection of psalms is as a whole far more suitable to a synagogue than to the Temple—where there would not be a large choir and orchestra of skilled musicians, it would obviously be desirable to state whether the psalm was to be sung to a Davidic, Asaphic or Korahite tone, or to give the name of a melody appropriate to it. Again, the general tone of large parts of this collection is much more cheerful than that of the Elohist psalm-book. It begins with a psalm (xc.) ascribed in the title to Moses, and seemingly designed to express feelings appropriate to a situation analogous to that of the Israelites when, after the weary march through the wilderness, they stood on the borders of the promised land. It looks back on a time of great trouble and forward to a brighter future. In some of the following psalms there are still references to deeds of oppression and violence, but more generally Israel appears as happy under the law. The problems of divine justice are no longer burning questions, the righteousness of God is seen in the peaceful felicity of the pious (xci., xcii., &c.). Israel, indeed, is still scattered and not triumphant over the heathen, but even in the dispersion the Jews are under a mild rule (cvi. 46), and the commercial activity of the nation has begun to develop beyond the seas (cvii. 26 seq.). But some of the psalms refer to a time of struggle and victory. In Ps. cxviii. Israel, led by the house of Aaron—this is a notable point—has emerged triumphant from a desperate conflict, and celebrates at the Temple a great day of rejoicing for the unhopd-for victory: in Ps. cxlix. the saints are pictured with the praises of God in their throat and a sharp sword in their hands to take vengeance on the heathen, to bind their kings and nobles, and exercise against them the judgment written in prophecy. Such an enthusiasm of militant piety, plainly based on actual successes of Israel and the house of Aaron, can only be referred to the first victories of the Maccabees, culminating in the purification of the Temple in 164 B.C. This restoration of the worship of the national sanctuary, under circumstances that inspired religious feelings very different from those of any other generation since the return from Babylon, might most naturally be followed by an extension of the Temple psalmody; it certainly was followed by some liturgical innovations, for the solemn service of dedication on the 25th day of Chislew was made the pattern of a new annual feast (that mentioned in John x. 22). In later times the psalms for the encaenia or feast of dedication embraced Ps. xxx. and the *hallel* Ps. cxliii.-cxlviii.; and though Ps. xxx. may have been adapted from a collection already existing, there is every reason to think that the *hallel*, which especially in its closing part contains allusions that fit no other time so well, was first arranged for the same ceremony. The course of the subsequent history makes it very intelligible that the Psalter was finally closed, as we have seen from the date of the Greek version that it must have been, within a few years at most after this great event.¹ From the time of Hyrcanus downwards the ideal of the princely high priests became more and more divergent from the ideal of the pious in Israel, and in the Psalter of Solomon we see religious poetry turned against the lords of the Temple and its worship.

All this does not, of course, imply that there are not in books IV. and V. any pieces older than the completion of books II. and III., for the composition of a poem and its acceptance as part of the Levitical liturgy are not necessarily coincident in date, except in psalms written with a direct liturgical purpose. In the fifteen "songs of degrees" (Ps. cxx.-cxxxiv.) we have a case in point. According to the Mishna (*Middoth*. ii. 5) and other Jewish traditions, these psalms were sung by the Levites at the Feast of Tabernacles on the fifteen steps or degrees that led from the women's to the men's court. But when we look at the psalms themselves we see that they must originally have been a hymn-book, not for the Levites, but for the laity who came up to Jerusalem at the great pilgrimage feasts, and who themselves remembered, or their fathers had told them, the days when, as we see in Ps. xlii., it was impossible to make pilgrimage to Zion. They are hymns of the laity, describing with much beauty and depth of feeling the emotions of the pilgrim when his feet stood within the gates of Jerusalem, when he looked forth on the encircling hills, when he felt how good it was to be camping side by side with his brethren on the slopes of Zion (cxxxiii.), when a sense of Jehovah's forgiving grace and the certainty of the redemption of Israel triumphed over all the evils of the present and filled his soul with humble and patient hope.

The titles which ascribe four of the pilgrimage songs to David and one to Solomon are lacking in the true LXX., and inconsistent with the contents of the psalms. Better attested, because found in the LXX. as well as in the Hebrew, and therefore probably as old as the collection itself, are the name of Moses in Ps. xc. and that of David in Ps. ci., ciii., cviii.-cx., cxxxviii.-cxlv. But where did the last collectors of the psalms find such very ancient pieces which had

¹ Possibly under Simon; compare the other *hallel* (Ps. cxlvi.-cl. with 1 Macc. xiii. 50 seq.).

been passed by all previous collectors, and what criterion was there to establish their genuineness? No canon of literary criticism can treat as valuable external evidence an attestation which first appears so many centuries after the supposed date of the poems, especially when it is confronted by facts so conclusive as that Ps. cviii. is made up of extracts from Ps. lvii. and lx. and that Ps. cxxxix. is marked by its language as one of the latest pieces in the book. The only possible question for the critic is whether the ascription of these psalms to David was due to the idea that he was the psalmist *par excellence*,¹ to whom any poem of unknown origin was naturally ascribed, or whether we have in some at least of these titles an example of the habit so common in later Jewish literature of writing in the name of ancient worthies. In the case of Ps. xc. it can hardly be doubted that this is the real explanation, and the same account must be given of the title in Ps. cxlv., if, as seems probable, it is meant to cover the whole of the great *hallel* or *tehilla* (Ps. cxlv.-cl.), which must, from the allusions in Ps. cxlix., as well as from its place, be almost if not quite the latest thing in the Psalter.

For the later stages of the history of the Psalter we have, as we have seen, a fair amount of evidence pointing to conclusions of a pretty definite kind. We have still to consider the two great groups of psalms ascribed to David in books I. and II. We have endeavoured to show that the ascription "to David" in these groups did not originally denote authorship by David, and that, notwithstanding the subscription of Ps. lxxii., which may well be a later note, there is no necessity to suppose an original collection of Davidic psalms from which excerpts were made. It is, however, probable that the title soon came to be understood of David's authorship, with the result that further notes were added indicating the situation in David's life to which the psalms appeared to be appropriate. It is certainly not impossible that the two groups of "Davidic" psalms once formed separate collections independently compiled, and that the subscription to Ps. lxxii. originally stood at the end of the second collection; for in book I. every psalm, except the introductory poems i. and ii. and the late Ps. xxxiii., which may have been added as a liturgical sequel to Ps. xxxii., bears the title "of David," and in like manner the group Ps. li.-lxxii., though it contains a few anonymous pieces and one psalm which is either "of," or rather, according to the oldest tradition, "for Solomon," is composed of "Davidic" psalms. It would seem also that the collectors of books I.-III. know of no Davidic psalms outside of these two collections, for Ps. lxxxvi. in the appendix to the Elohist collection is merely a cento of quotations from Davidic pieces with a verse or two from Exodus and Jeremiah. Now that the ascription "to David" was understood of David's authorship before the time of the LXX. is clear from such titles as that of Ps. xviii., for example, but there is no evidence that in early times David was regarded as the author of any of the psalms. Even the Chronicler, though he regarded David as the great founder of the Temple music, does not quote any psalm as composed by him, and the Chronicler's omission of 2 Sam. xxii.-xxiii. 7 makes it probable that this section has been inserted in the book of Samuel since he wrote. If, as is possible, Ecclus. xlvii. 8 is a reminiscence of Ps. ix. 2 and Ps. xviii. 2, we should indeed naturally infer that these two psalms were regarded by Ben Sira as the work of David; but this would prove nothing as to the date of the collection in which we now have them. It may fairly be contended therefore that the tradition that David is the author of the psalms which are assigned to him in books I. and II. comes to us from a period later than that in which the Chronicler wrote. And it is not too much to say that that view—which to some extent appears in the historical psalms of the Elohist Psalter—implies absolute incapacity to understand the difference between old Israel and later Judaism, and makes almost anything possible in the way of the ascription of comparatively modern pieces to ancient authors. In any case the titles are manifestly the product of the same uncritical spirit as we have just been speaking of, for not only are many of the titles certainly wrong, but they are wrong in such a way as to prove that they date from an age to which David was merely the abstract psalmist and which had no idea whatever of the historical conditions of his age. For example, Ps. xx. xxi. are not spoken by a king but addressed to a king by his people; Ps. v. xxvii. allude to the Temple (which did not exist in David's time) and the author of the latter psalm desires to live there continually. Even in the older Davidic psalm-book there is a whole series of hymns in which the writer identifies himself with the poor and needy, the righteous people of God suffering in silence at the hands of the wicked, without other hope than patiently to wait for the interposition of Jehovah (Ps. xii., xxv., xxxvii., xxxviii., &c.). Nothing can be further removed than this from any possible situation in the life of the David of the books of Samuel, and the case is still worse in the second Davidic collection, especially where we have in the titles definite notes as to the historical occasion on which the poems are supposed to have been written. To refer Ps. lii. to Doeg, Ps. liv. to the Ziphites, Ps. lix. to David when watched in his house by Saul, implies an absolute lack of the very elements of historical judgment. Even the bare names of the old history were no longer correctly known

when Abimelech (the Philistine king in the stories of Abraham and Isaac) could be substituted in the title of Ps. xxxiv. for Achish, king of Gath. In a word, the ascription of these two collections to David has none of the characters of a genuine historical tradition.

At the same time it is clear that the two collections do not stand on quite the same footing. The second collection of "Davidic" psalms, as well as the Korahitic and Asaphic psalms, have been subjected to an Elohist redaction, for which we must find a reason if the history of the Psalter is to be written. An explanation that naturally suggests itself is that, at the time when books II. and III. (with the exception of the appendix, Ps. lxxxiv.-lxxxix.) were collected, it was already the custom, from motives of reverence, to abstain from pronouncing the Tetragrammaton. Upon this supposition it might be explained that book I. was collected before this scruple arose, and books IV. and V. when the custom had arisen of substituting in reading the word *Adonai*. But, as we have seen, it is impossible to separate the contents of the Elohist books from those of the last collection. Both include psalms which are most naturally understood as referring to the persecution of Antiochus Epiphanes and to the Maccabean victories, and cannot therefore be separated by a long interval of time. Moreover the scruple as to the pronunciation of the Tetragrammaton seems to have arisen earlier, as in the LXX. version of the Pentateuch יהוה is represented by *Képios*. And further, if the Elohist redaction was due merely to a desire to avoid pronouncing the divine name, why was not the presumably earlier collection of psalms in book I. subjected to a similar redaction? It is therefore difficult to suppose that the Jewish Church as a whole passed through a stage in which it was felt desirable to substitute יהוה in writing for יהוה . There is, however, no difficulty in supposing that such a thing was done in some sections of the Jewish Church, and it is probable that we must look for an explanation of the peculiarity not to the time but to the place where the second collection was formed. Now it must be frankly admitted that the earlier books of psalms exhibit no particular suitability for the Temple services. It is only in the last collection, books IV. and V., that we find any number of psalms appropriate to such a ritual as that of the Temple, and it is difficult to resist the conviction that the earlier collections were made for use, not in the Temple at Jerusalem but in some synagogue or synagogues. Thus, for example, the numerous psalms in which the poets, though speaking perhaps, not as individuals but as members of a class, describe themselves as poor and afflicted at the hands of certain ungodly men, who appear to be Jews, can hardly have been originally collected by the Temple choirs. For since the ministers of the Temple at Jerusalem were the aristocracy of the land, and were often, as we know both from the book of Malachi and from the history of the Maccabees, the chief offenders, it is extremely unlikely that they collected for the official services of the Temple compositions directed against themselves. It is also remarkable that hymns such as Exodus xv., which would be specially suitable to the Temple, find no place in the Psalter. Moreover, in Ps. xl., we have the striking assertion, which surely did not originate in the Temple, that God has no delight in sacrifice and offerings. On the other hand, the first collection of "Davidic" psalms taken as a whole would be perfectly appropriate in the worship of a Judæan community of *Hasidim* in the Maccabean period. We have, unfortunately, no information as to the origin of synagogues, but their existence in pre-Maccabean times may be inferred not only from the statement in Ps. lxxiv. 8, but also from the fact that there must have been some rallying points for the religion of the *Hasidim*: besides that supplied by occasional visits or pilgrimages to Jerusalem. We need not suppose that congregations gathered together to worship away from Jerusalem, especially in times of distress, would necessarily sing the religious poems which they had collected, though it is by no means improbable that they would do so. At any rate, Ps. cxxxvii. 4 may fairly be taken as evidence that those heathen among whom the Jews dwelt "in a strange land" had heard and admired the "songs of Zion." Certainly in happier times, when the worst period of storm and stress was over, there would be a desire to enliven the services with music, which would naturally be borrowed from the traditional music of the great national sanctuary.

In thus assigning the first collection of psalms to some Judæan community of *Hasidim* in the earlier Maccabean period we need not conclude that all the psalms contained in this collection were first composed at this time. Although there is no psalm which can be shown with any probability to be pre-exilic, it is not impossible that there are some which date from as early a time as the age of Zerubbabel, by whose appointment national hopes were raised to so high a pitch. Thus, for example, Ps. xviii., xx., xxi., which in some respects recall the language of the song ascribed to Hannah in 1 Sam. ii., may possibly, like that song, be referred to this period. It must, however, be admitted that as a whole the psalms of the first collection are more suitable to a later date. Ps. viii., which is almost certainly quoted in Job. vii. 17, need not have been composed long before the book in which it is quoted: the references to the "godly" and to their persecutions at the hands of wicked men, who seem to be Jews, recall the Maccabean age; in Ps. xxii. the speaker, who is not an individual but speaks in the name of a community, bears a remarkable resemblance to the "suffering servant" of Isaiah lii. 13-liii.

¹ The explanation of יהוה suggested above offers another alternative.—R. H. K.

and of this last passage it may be said that *all the translatable portions of it can be naturally explained*, if it refers to the time when the resistance of the *Hastdīm*, whom the Sadducees had despised and shunned, had won freedom for Israel as a whole, and at no other known period; the fragment, Ps. xxiv. 7-10, is most easily understood of the time when the Lord who had shown Himself strong and mighty by His victories over the heathen returned in triumph to His Temple in 164 B.C.—in the days of Zerubbabel or of Nehemiah Jehovah had not recently shown Himself "mighty in battle."

In the light of these circumstances—and space here forbids more than the scantiest reference—we may reasonably suppose that the first book, with the exception of Ps. i., ii. and possibly xxxiii., is a collection of psalms in the shape which it assumed in a Judaean synagogue in the earlier days of the Maccabean victories.

We have already noticed the difficulty of supposing that the Elohist Psalter was compiled in a place where a Jehovistic Psalter was already in use. It is therefore probable that the second collection of psalms (books II. and III.), containing as it does an Elohist recension of a psalm occurring in book I. in a Jehovistic form, must have been compiled for use in some other district. Since the last collection (books IV. and V.) which may reasonably be assigned to the Temple at Jerusalem uses freely the name *יהוה*, it may be inferred that the district where an objection was felt to *writing* the Tetragrammaton was some distance from Jerusalem, and probably not in such close touch with it as most of the country districts of Judaea would be. Such a district we may find in southern Galilee, "the land of Zebulon and the land of Naphtali," apparently the only portion of Palestine north of Samaria where the worshippers of Jehovah existed in any considerable numbers. It is at least remarkable that the names Zebulon and Naphtali in Isaiah ix. 1 (a passage which, as has been already noted, is probably Maccabean) denote the region which had felt the brunt of the persecution of the heathen, while in Ps. lxxviii. 27 (a poem of which every translatable verse is explicable if it refers to the great procession at the rededication of the Temple in 164 B.C.) the same two tribes are joined with Judah and Benjamin (*sc.* Judaea) as celebrating the Lord's victory. The dissenting inhabitants of Samaria are naturally absent from such a festival. It is not improbable that the Elohist redaction of the second collection of psalms is due not so much to any Jewish scruples about *writing* the Tetragrammaton as to the fear that it might fall into the hands of the heathen who were trying to destroy the Hebrew Scriptures, and might thus be desecrated (cf. 1 Macc. i. 56, 57).

We may thus suppose that about the time of Jonathan the Maccabean High Priest (if our explanation of Ps. xlv. is correct), at all events not earlier than 150 B.C., a south Galilaean synagogue made a collection of the various religious poems current among its members. Perhaps those which were to be sung according to the old Davidic mode formed the nucleus of the collection, and to these were added other poems to be sung according to the more intricate Korahite and Asaphic modes. The appendix to this collection (Ps. lxxxiv.-lxxxix.) being non-Elohist presumably was collected elsewhere. It is possible that these last-mentioned psalms were originally an appendix to the Judaean collection and have been removed from their original place to after the other Levitical psalms.

In books IV. and V. we have a collection probably made originally for use in the Temple, consisting in the main of recent hymns, but embodying, at least to some extent, older traditional hymns of the Temple. On this hypothesis we are able to explain the presence of certain poetical pieces both in the book of Chronicles and in the Psalter. We need not suppose that the Chronicler quotes from the Psalter or vice versa, the matter which they have in common being probably derived from certain traditional songs current among the Levitical singers. Since this last collection includes a psalm (cx.) which can scarcely refer to any one earlier than Simon the Maccabee, and cannot well be later than his time, we are justified in assigning the compilation of this collection to about the year 140 B.C. But by this time a great change had taken place in the aims and aspirations of the Jews. The earlier Maccabean policy of concentration had given place to one of expansion. The Jews in Jerusalem could not ignore the Jews of Galilee or even of the Dispersion. The hymns which had brought comfort to the faithful in the time of their distress had become an integral part of their religion which could not be given up. Jerusalem was now the religious metropolis of a great nation, and accordingly it was felt desirable that the hymn-books of the several parts of the nation should be combined into a hymn-book for the whole. The synagogue collections, since they contained psalms which at this time were probably considered to be the work of David, were placed first, and the Temple collection added to them. There was then prefixed to the whole collection a hymn (Ps. ii.) describing the hoped-for greatness of Simon's kingdom, and finally Pharisaic sentiment pre-faced the whole by a psalm in praise of the law. In the final compilation, or perhaps in a subsequent redaction, some alterations were made in the original order, some notes were added describing the circumstances in which various psalms had been composed, and lastly, in order to assimilate the outward form of the Psalter to that of the Pentateuch, the three collections were divided into five books. The final redaction is probably to be dated between the years 140 and 130 B.C.

Musical Execution and Place of the Psalms in the Temple Service.—The musical notes found in the titles of the psalms and occasionally also in the text (Selah,¹ Higgaiōn) are so obscure that it seems unnecessary to enter here upon the various conjectures that have been made about them. The clearest point is that a number of the psalms were originally at least set to melodies named after songs,² and that one of these songs beginning אֶל־תַּשְׁחִיחַ (Al-tashith in E. V., Ps. lviii. seq.), may be probably identified with the vintage song, Isa. lxxv. 8. The original music of the psalms was therefore apparently based on popular melodies. A good deal is said about the musical services of the Levites in Chronicles, both in the account given of David's ordinances and in the descriptions of particular festival occasions. But unfortunately it has not been found possible to get from these accounts any clear picture of the ritual of any certainty as to the technical terms used. In Egypt by the translators of the Septuagint these terms were not understood.

The music of the temple attracted the attention of Theophrastus (ap. Porph. *De abst.* ii. 26), who was perhaps the first of the Greeks to make observations on the Jews. His description of the Temple ritual is not strictly accurate, but he speaks of the worshippers as passing the night in gazing at the stars and calling on God in prayer; his words, if they do not exactly fit anything in the later ritual, are well fitted to illustrate the original liturgical use of Ps. viii., cxxxiv. Some of the Jewish traditions as to the use of particular psalms have been already cited; it may be added that the Mishna (Tāmīd) assigns to the service of the continual burnt-offerings the following weekly cycle of psalms.—(1) xxiv., (2) xlvi., (3) lxxxii., (4) xciv., (5) lxxxii., (6) xciii., (Sabbath) xcii., as in the title. Many other details are given in the treatise *Sōfērīm*, but these for the most part refer primarily to the synagogue service after the destruction of the Temple. For details on the liturgical use of the Psalter in Christendom the reader may refer to Smith's *Dict. Chr. Ant.*, s.v. "Psalmody."

Ancient Versions.—(A) The oldest version, the LXX., follows a text generally closely corresponding to the Massoretic Hebrew, the main variations being in the titles and in the addition (lacking in some MSS.) of an apocryphal psalm ascribed to David when he fought with Goliath. Ps. ix. and x. are rightly taken as one psalm, but conversely Ps. cxlvii. is divided into two. The LXX. text has many "daughters," of which may be noticed (a) the Memphitic (ed. Lagarde, 1875); (b) the old Latin, which as revised by Jerome in 383 after the current Greek text forms the *Psalterium romanum*, long read in the Roman Church and still used in St Peter's; (c) various Arabic versions, including that printed in the polyglots of Le Jay and Walton, and two others of the four exhibited together in Lagarde's *Psalterium, Job, Proverbia, arabice*, 1876; on the relations and history of these versions see G. Hoffmann, in *Jenaer Literaturz.*, 1876, art. 539; the fourth of Lagarde's versions is from the Peshito. The Hexaplar text of the LXX., as reduced by Origen into greater conformity with the Hebrew by the aid of subsequent Greek versions, was further the mother (d) of the *Psalterium gallicanum*—that is, of Jerome's second revision of the Psalter (385) by the aid of the Hexaplar text; this edition became current in Gaul and ultimately was taken into the Vulgate; (e) of the Syro-Hexaplar version (published by Bugati, 1820, and in facsimile from the famous Ambrosian MS. by Ceriani, Milan, 1874). (B) The Christian Aramaic version or Peshito (P'shittā) is largely influenced by the LXX., compare Baethgen, *Untersuchungen über die Psalmen nach der Peschita*, Kiel, 1878 (unfinished).

¹Of the various explanations that have been given of Selah the only one which possesses any probability is that given independently by Baethgen and others, viz. that it is a mispronunciation of an original אֶל־תַּשְׁחִיחַ = ψάλλε. The word, which was probably derived from some Greek bandmaster, was presumably an instruction for a musical interlude. The LXX. translators who render it by διάψαλμα though not recognizing the derivation of the word, knew its meaning.—R. H. K.

²Compare the similar way of citing melodies with the prep. 'al or 'al kälā, &c., in Syriac (Land, *Anecd.* iv.; *Ephr. syr. hymni*, ed. Lamy).

This version has peculiar titles taken from Eusebius and Theodore of Mopsuestia (see Nestle, in *Theol. Literaturz.*, 1876, p. 283). (C) The Jewish Aramaic version or Targum is probably a late work.¹ The most convenient edition is in Lagarde, *Hagiographa chaldaice*, 1873. (D) The best of all the old versions is that made by Jerome after the Hebrew in 405. It did not, however, obtain ecclesiastical currency—the old versions holding their ground, just as English churchmen still read the Psalms in the version of the "Great Bible" printed in their Prayer Book. This important version was first published in a good text by Lagarde, *Psalterium juxta hebraeos hieronymi* (Leipzig, 1874).

Exegetical Works.—While some works of patristic writers are still of value for text criticism and for the history of early exegetical tradition, the treatment of the Psalms by ancient and medieval Christian writers is as a whole such as to throw light on the ideas of the commentators and their times rather than on the sense of a text which most of them knew only through translations. For the Psalms, as for the other books of the Old Testament, the scholars of the period of the revival of Hebrew studies about the time of the Reformation were mainly dependent on the ancient versions and on the Jewish scholars of the middle ages. In the latter class Kimhi stands pre-eminent; to the editions of his commentary on the Psalms enumerated in the article קִימְחִי must now be added the admirable edition of Dr Schiller-Szinessy (Cambridge, 1883), containing, unfortunately, only the first book of his longer commentary. Among the works of older Christian scholars since the revival of letters, the commentary of Calvin (1557) full of religious insight and sound thought—and the laborious work of M. Geier (1668, 1681 *et saepius*) may still be consulted with advantage, but for most purposes Rosenmüller's *Scholia in Psalms* (2nd ed., 1831–1822) supersedes the necessity of frequent reference to the predecessors of that industrious compiler. Of more recent works the freshest and most indispensable are Ewald's, in the first two half-volumes of his *Dichter des alten Bundes* (2nd ed., Göttingen, 1866; Eng. trans., 1880), and Olshausen's (1853). To these may be added (excluding general commentaries on the Old Testament) the two acute but wayward commentaries of Hitzig (1836, 1863–1865), that of Delitzsch (1859–1860, then in shorter form in several editions since 1867; Eng. trans., 1871), and that of Hupfeld (2nd ed. by Riehm, 1867, 2 vols.). The last-named work, though lacking in original power and clearness of judgment, is extremely convenient and useful, and has had an influence perhaps disproportionate to its real exegetical merits. The question of the text was first properly raised by Olshausen, and has since received special attention from, among others, Lagarde (*Prophetæ chald.*, 1872, p. 46 seq.), Dyserinck (in the "scholia" to his Dutch translation of the Psalms, *Theol. Tijdschr.*, 1878, p. 279 seq.), and Bickell (*Carmina V. T. metricæ*, &c., Innsbruck, 1882), whose critical services are not to be judged merely by the measure of assent which his metrical theories may command. In English we have, among others, the useful work of Perowne (5th ed., 1883), that of Lowe and Jennings, (2nd ed., 1885), and the valuable translation of Cheyne (1884). The mass of literature on the Psalms is so enormous that no full list even of recent commentaries can be here attempted, much less an enumeration of treatises on individual psalms and special critical questions. For the latter Kuenen's *Onderzoek*, vol. iii., is, up to its date (1865), the most complete, and the new edition now in preparation will doubtless prove the standard work of reference. As regards the dates and historical interpretation of the Psalms, all older discussions, even those of Ewald, are in great measure antiquated by recent progress in Pentateuch criticism and the history of the canon, and an entirely fresh treatment of the Psalter by a sober critical commentator is urgently needed.

The bibliography up to this point is taken from the article PSALMS by the late Professor W. Robertson Smith (*Ency. Brit.*, 1886), large portions of which are incorporated in the present article. It was the belief of Professor Robertson Smith that the second (Elohistic) collection of psalms originated in a time of persecution earlier than the time of Antiochus Epiphanes which he referred to the reign of Artaxerxes III. Ochus. This theory, which he set forth with all his accustomed learning and force, is still accepted in many quarters, many other passages of the Old Testament being likewise assigned to the same date. In the judgment of the present writer however, the results of Old Testament study (particularly in the Prophets) since Professor Robertson Smith's death have shown that this theory is untenable. Notwithstanding his reverence, therefore, for the great scholar with whose name it is associated, and to whose memory he would pay both grateful and humble tribute, he has ventured to omit or rewrite all those portions of the original article which he considers no longer tenable, while retaining every word which is still valuable.

Of the works on the Psalms which have appeared since the first publication of Professor W. Robertson Smith's article the following may be specially noticed: Cheyne, *The Book of Psalms* (1888), *The*

Origin of the Psalter, Bampton Lectures (1891), and the article *Psalms* (in *Ency. Bib.*, 1902); Bickell, *Die Dichtungen der Hebräer* (3 der Psalter, 1883), from a revised and metrically arranged text; Baethgen, in Nowack's *Hand-Komm.* (1892); Wellhausen, in *Sacred Books of the Old Test.* (Eng. trans. by Furness, J. Taylor and Paterson, 1898); Duhm, in Marti's *Kurzer Hand-Comm.* (1899); Kirkpatrick, in *Cambridge Bible for Schools* (1893–1895); W. T. Davison, in Hastings's *Dict. Bible* (1902); Driver, *The Parallel Psalter* (1904); C. A. and E. G. Briggs, "Critical and Exegetical Commentary on the Psalms," vol. i. (1906), vol. ii. (1907), in *International Critical Commentary*. (R. H. K.)

PSALTERY, PSALTERION, or SAWTRIE (Fr. *psalterion, salteire*; Ger. *Psalterium*; Ital. *salterio, istrumento di porco*), an ancient stringed instrument twanged by fingers or plectrum, and mentioned many times in the English Bible; a favourite instrument also during the middle ages in England, France and Italy. It is exceedingly doubtful whether the word was ever applied during the classic Greek period to any individual instrument; there is, moreover, no trace in the monuments of that time of the psalterion in any of the forms in which it afterwards became known during the middle ages. It is also puzzling to find no fewer than four different instruments translated *psalterion* in the Septuagint, i.e. Nebel, Psanterin, Ugab (organ) and Toph (Job xxi. 12). On the other hand the Aramaic word Pisantir or Psanterin (Dan. iii. 5, 10, 15) generally translated *psalterion*, and by some scholars claimed as a loan word from the Greek, corresponds to the *Santir*, a stringed instrument represented on Assyrian monuments of the 8th century B.C. (when as yet the word had not been used in Greek for a musical instrument) and still in use in Persia at the present day by the same name. The instrument itself, moreover, a dulcimer, which in its earlier forms differed from the psalterion mainly in that its strings were struck by curved sticks instead of being plucked, must in the absence of contrary evidence be considered as the prototype of the medieval psalterion or psaltery. Early medieval writers generally connect the psalterium and the cithara, probably because the strings of both were set in vibration in the same manner, by plucking or twanging.

The medieval psaltery consisted of a shallow box-soundchest over which strings varying in number were stretched, being fastened at one side to pegs and at the other to wrest pins. In the early rectangular form the strings, numbering 10 or 12, were, as in the cithara, of uniform length, the pitch being varied by the thickness and tension of the strings. When the triangular form succeeded the rectangular, the stringing was that of the harp, pitch being dependent on the length. The trapeze form, clearly borrowed from the oriental *Kanon*, and the curious Italian *istrumento di porco*, were the latest types to survive. In these later forms the vibrating length of the strings was regulated by means of two wooden bridges, converging as the strings became shorter. The psaltery was held in an upright position against the chest of the performer, until, owing to the increasing number of strings, it grew too cumbersome, and was placed flat on a table or on the knee. The German zither is the sole European survivor of the medieval psaltery. (K. S.)

PSAMMETICHUS (Egypt. *Psammethk*), the name of three kings of the Saite, XXVIth Dynasty, called by Herodotus respectively Psammethichus, Psammis and Psammenitus. The first of these is generally considered to be the founder of the dynasty; Manetho, however, carries it back through three or four predecessors who ruled at Sais as petty kings under the XXVth, Ethiopian, Dynasty. The name is frankly written so as to mean "the man of *methek*," i.e. "mixed drink," whether as a tippler or as a vendor of strong drink. The Egyptian scribes do not conceal the opprobrious elements, but it has been suggested that the name may be due to false etymology of a foreign name (though all the names throughout the dynasty appear to be Egyptian), or that *Methek* may have been an unknown deity. The story in Herodotus of the Dodecarchy and the rise of Psammethichus is fanciful. It is known from cuneiform texts that twenty local princelings were appointed by Esarhaddon and confirmed by Assur-bani-pal to govern Egypt. Niku (Necho), father of Psammethichus, was the chief of these kinglets, but they seem to have been quite unable to hold the Egyptians to the hated Assyrians against the more sympathetic Ethiopian. The labyrinth built by a king of the XIIth Dynasty is ascribed by Herodotus to the Dodecarchy, or rule of 12, which must

¹ It contains, however, elements which are as early as the time of the New Testament. Cf. Ps. lxxviii. 18 with Ephes. iv. 8.

represent this combination of rulers. If the dynasties were numbered thus before Manetho, the numeral may be the cause of Herodotus's confusion. After his father's death Psammetichus I. (664-610 B.C.) was able to defy the Assyrians and the Ethiopians, and during a long reign marked by intimate relations with the Greeks restored the prosperity of Egypt. The short reign of the second Psammetichus (594-589 B.C.) is noteworthy for the graffiti of his Greek, Phoenician and Carian mercenaries at Abu Simbel (*q.v.*). The third of the name was the unfortunate prince whose reign terminated after six months in the Persian conquest of Egypt (525 B.C.). It has been conjectured that the family of the Psammetichi was of Libyan origin; on the other hand, some would recognize negro features in a portrait of Psammetichus I., which might connect him with the Ethiopian rulers.

See above, EGYPT: *History*; on the name, F. Ll. Griffith, *Catalogue of the Rylands demotic papyri*; the portrait, H. Schäfer in *Zeitschrift für ägyptische Sprache*, xxxiii. 116. (F. Ll. G.)

PSELLUS (Gr. Ψέλλος), the name of several Byzantine writers, of whom the following may be mentioned:—

1. MICHAEL PSELLUS the elder, a native of Andros and a pupil of Photius, who flourished in the second half of the 9th century. His study of the Alexandrine theology, as well as of profane literature, brought him under the suspicions of the orthodox, and a former pupil of his, by name Constantine, accused him in an elegiac poem of having abandoned Christianity. In order to perfect his knowledge of Christian doctrine, Psellus had recourse to the instructions of Photius, and then replied to his adversary in a long iambic poem, in which he maintained his orthodoxy. None of his works has been preserved.

2. MICHAEL CONSTANTINE PSELLUS the younger, born in 1018 (probably at Nicomedia; according to some, at Constantinople) of a consular and patrician family. He studied at Athens and Constantinople, where he became intimate with John Xiphilinus. Under Constantine Monomachus (1042-1054) he became one of the most influential men in the empire. As professor of philosophy at the newly founded academy of Constantinople he revived the cult of Plato at a time when Aristotle held the field; this, together with his admiration for the old pagan glories of Hellas, aroused suspicions as to his orthodoxy. At the height of his success as a teacher he was recalled to court, where he became state secretary and vestarch, with the honorary title of Ἰππάρχος τῶν Φιλοσόφων (prince of philosophers). Following the example of his friend Xiphilinus he entered the monastery of Olympus (near Prusa in Bithynia), where he assumed the name of Michael. But, finding the life little to his taste, he resumed his public career. Under Isaac Comnenus and Constantine Ducas he exercised great influence, and was prime minister during the regency of Eudocia and the reign of his pupil Michael Parapinaces (1071-1078). It is probable that he died soon after the fall of Parapinaces.

Living during the most melancholy period of Byzantine history, Psellus exhibited the worst faults of his age. He was servile and unscrupulous, weak, fond of intrigue, intolerably vain and ambitious. But as a literary man his intellect was of the highest order. In the extent of his knowledge, in keenness of observation, in variety of style, in his literary output, he has been compared to Voltaire; but it is perhaps as the forerunner of the great Renaissance Platonists that he will be chiefly remembered. His works embraced politics, astronomy, medicine, music, theology, jurisprudence, physics, grammar and history.

Of his works, which are very numerous, many have not yet been printed. We may mention: *Chronographia* (from 976-1077), which in spite of its bias in favour of the Ducases is a valuable history of his time, chiefly on domestic affairs; three Epitaphioi or funeral orations over the patriarchs Cerularius, Lichudes and Xiphilinus. His letters (nearly 500 in number) are also full of details of the period. A complete list of his works is given in Fabricius, *Bibliotheca graeca*, x. 41; the most important have been published by C. Sathas in his *Μεσαιωνική βιβλιοθήκη*, iv. v. On Psellus himself see Leo Allatius, *De Psellis et eorum scriptis* (1634); E. Egger in *Dictionnaire des sciences philosophiques* (1875); A. Rambaud in *Revue historique* (1877); P. V. Bezobrazov, *Michel Psellos* (1890; in Russian); C. Neumann, *Die Weltstellung des byzantinischen Reiches vor den Kreuzzügen* (1894); C. Krumbacher, *Geschichte der byzantinischen Literatur* (1897); J. E. Sandys, *Hist. of Classical Scholarship* (1906), i. 411.

PSEUDO-DIPTERAL (Gr. ψευδής, false, δῖς, double, and πτερόν, a wing), the term given to a dipteral temple, *i.e.* in which there are two rows of columns round the naos, the inner row of which has been omitted to give more space for the processions or for shelter (see TEMPLE).

PSEUDONYM (Gr. ψευδώνυμος, having a false name, ψευδής, false and ὄνομα, name), a false or invented name, particularly the fictitious name under which an author produces his work in order to conceal his identity. The same end is gained by publication without any name, *i.e.* anonymously (Gr. ἄνωνυμος, without a name). The body of works thus produced either without the author's name or under a fictitious name is known as anonymous and pseudonymous literature, and many books have been published affording a key to the identity of the various writers, forming an important section of bibliography. Though Fredericus Geisler published a short treatise on the subject entitled *Larva detecta*, &c., in 1669, the chief early work was that of Vincent Placcius (1642-1699) whose *Theatrum anonymorum et pseudonymorum* was published in 1708, edited by L. F. Vischer with a preface and life by J. A. Fabricius; supplements were published in 1711 and in 1740. The next important work, only a fragment of the purposed scheme, was that of Adrien Baillet (*q.v.*), under the title of *Auteurs déguisés sous les noms étrangers*, &c. (1690). Antoine Alexandre Barbier (*q.v.*) published his standard work *Dictionnaire des ouvrages anonymes et pseudonymes* in 1806-1809 (2nd ed., 1822-1827). This was followed by the *Supplémentes littéraires dévoilées* of J. M. Quérard (*q.v.*). The third edition of Barbier's work, embodying Quérard and much new matter, was published in 1872-1879. This was edited by P. Gustave Brunet, who published a supplement in 1889. Other works in French are those of C. Jolliet, *Les Pseudonymes du jour* (1867 and 1884), and F. Drujon, *Livres à clef* (1888). Of German works in this sphere of bibliography the *Index pseudonymorum, Wörterbuch der Pseudonymen* of Emil Weller appeared in 1856, of which several supplements were published later. The most monumental of all works are the *Deutsches Anonymen-Lexikon*, 1501-1850, by M. Holzmann and H. Bohatta (1902-1907), supplement, 1851-1908 (1909), and the *Deutsches Pseudonymen-Lexikon*, by the same authors (1906). See also F. Sintenis, *Die Pseudonyme der neueren deutschen Litteratur* (1899), and the supplementary volume (1909), to Meyers's *Konversations-Lexikon* (6th ed.). The chief Italian work is the *Dizionario di opere anonime e pseudonime di scrittori italiani*, by G. Melzi (1848-1859), with supplement by G. Passano (1887). The Dutch *Veromde en naamlooze schrijvers . . . der Nederl. en Vlaamschen letteren*, by J. I. van Doorninck (1883-1885), was a second edition of an earlier work. The Academy of Upsala is publishing, under the editorship of L. Bygden, a Swedish dictionary *Svenskt anonym och pseudonym lexikon* (1898), &c. England was late in entering the field. The first work actually published was the *Handbook of Fictitious Names*, by R. Thomas (*Olphar Hamst*) (1868). Samuel Halkett, and the successor to his compilations, John Laing, both died before their work was published; edited and revised by Miss C. Laing it appeared in 1882-1888 in 4 vols. as the *Dictionary of the Anonymous and Pseudonymous Literature of Great Britain*, by S. Halkett and J. Laing. This remains the standard work on the subject in English. Other works are W. Cushing, *Initials and Pseudonyms* (American and English from the beginning of the 18th century); 2nd series (1886, 1888), and *Anonyms* (1890); F. Marchmont, *A Concise Handbook of Literature issued under Pseudonyms or Initials* (1896); see also especially W. P. Courtney, *The Secrets of our National Literature* (1908), the first chapter of which contains a sketch of the history of the subject, to which the above account is mainly due. The anonymous and pseudonymous Latin literature of the middle ages has been treated in modern times by A. Franklin, *Dictionnaire des noms, &c., latins 1100-1530* (1875), and A. G. Little, *Initia operum latinorum saec. 13-15* (1904).

PSEUDO-PERIPTERAL (Gr. ψευδής, false, περί, round, πτερόν, a wing), a term in architecture given to a temple in which the columns surrounding the naos have had walls built

between them, so that they become engaged columns, as in the great temple at Agrigentum. In Roman temples, in order to increase the size of the cella, the columns on either side and at the rear became engaged columns, the portico only having isolated columns. (See TEMPLE.)

PSEUDOPOD, **PSEUDOPODIUM**, the name given to an extension of the naked protoplasm of certain Protozoa, notably the Sarcodina (*q.v.*), for crawling or creeping or for the prehension of food, but not for active swimming (see also AMOEBA).

PSILOMELANE, a mineral consisting of hydrous manganese oxide with variable amounts of barium, potassium, &c. It is sometimes considered to be a hydrous manganese manganate, but of doubtful composition. The amount of manganese present corresponds to 70-80% of manganous oxide with 10-15% of "available" oxygen. The mineral is amorphous and occurs as botryoidal and stalactitic masses with a smooth shining surface and submetallic lustre. The name has reference to this characteristic appearance, being from the Greek *ψιλός* (naked, smooth) and *μέλας* (black); a Latinized form is calvonigrite, and a German name with the same meaning is *Schwarzer Glaskopf*. Psilomelane is readily distinguished from other hydrous manganese oxides (manganite and wad) by its greater hardness ($H. = 5\frac{1}{2}$); the sp. gr. varies from 3.7 to 4.7. The streak is brownish-black and the fracture smooth. Owing to its amorphous nature, the mineral often contains admixed impurities, such as iron hydrates. It is soluble in hydrochloric acid with evolution of chlorine. It is a common and important ore of manganese, occurring under the same conditions and having the same commercial applications as pyrolusite (*q.v.*). It is found at many localities; amongst those which have yielded typical botryoidal specimens may be mentioned the Restormel iron mine at Lostwithiel in Cornwall, Brendon Hill in Somerset, Hoy in the Orkneys, Sayn near Coblenz, and Crimora in Augusta county, Virginia. With pyrolusite it is extensively mined in Vermont, Virginia, Arkansas and Nova Scotia.

PSKOV, a government of the lake-region of north-west Russia, which extends from Lake Peipus to the source of the west Dvina, having the governments of St Petersburg and Novgorod on the N., Tver and Smolensk on the E., Vitebsk on the S. and Livonia on the W. It has an area of 17,064 sq. m. In the south-east it extends partly over the Alaun or Vorobiovy heights, which stretch west into Vitebsk and send to the north a series of irregular ranges which occupy the north-western parts of Pskov. A depression 120 m. long and 35 m. broad, drained by the Lovat and the Polista, occupies the interval between these two hilly tracts; it is covered with forests and marshes, the only tracts suitable for human occupation being narrow strips of land along the banks of the rivers, or between the marshes, and no communication is possible except along the watercourses.

With the exception of the south-eastern corner, where Carboniferous rocks crop out, nearly the whole of the government consists of Devonian strata of great thickness, with deposits of gypsum and white sandstone, the latter extensively quarried for building purposes. The bottom: moraine of the Scandinavian and Finnish ice-sheet formerly extended over the whole of this region, and has left behind it numerous ridges (*kames* or *eskers*), the upper parts consisting of Glacial sands and post-Glacial clays, sands and peat-bogs. The soil is thus not only infertile, but also badly drained, and only those parts of the territory which are covered with thicker strata of post-Glacial deposits are suitable for agriculture.

The rivers are numerous and belong to three separate basins—to Lakes Peipus and Pskov the rivers in the north-west, to Lake Ilmen those in the middle, and to that of the Dvina the rivers in the south-east. A great number of small streams pour into Lake Pskov, the chief being the Velikaya. The Lovat and the Shelon, belonging to the basin of Lake Ilmen, are both navigable; while the west Dvina flows for 100 m. on the south border of the government or within it, and is used only for floating timber. There are no fewer than 850 lakes in Pskov, with a total area of 391 sq. m. The largest is Lake Pskov, which is 50 m. long and 13 broad, covers 300 sq. m. and has a depth of 3 to 18 ft.; it is

connected by a channel, 40 m. long and 3 to 10 wide, with Lake Peipus. The marshes on the banks of the Polista are nearly 1250 sq. m. in extent. Forests occupy nearly one-third (32%) of the entire area, and in some districts (Kholm, Toropets, Porkhov) as much as two-thirds of the surface. Large pine forests are met with in the north; in other parts the birch and the aspen prevail; but almost one-quarter of the forest area is overgrown with brushwood.

The climate is very moist and changeable. The average temperature is 41° F. (17.1° in January and 64.8° in July).

The population of the government numbered 1,135,639 in 1897, when there were 584,931 women, and the urban population only 72,623. The estimated population in 1906 was 1,275,300. With the exception of 25,460 Estonians (1897), the inhabitants are almost entirely Great Russians. They belong mainly to the Orthodox Greek Church, but the official number of Nonconformists, 32,066, is far below the mark. There are also about 12,000 Lutherans and 4000 Roman Catholics. The government is divided into eight districts, the chief towns of which, with their populations in 1897, are Pskov (*q.v.*), Kholm (5899), Novorzhev (2973), Opochka (5658), Ostrov (6252), Porkhov (5573), Toropets (7489) and Velikiye Luki (8481). Between 1875 and 1896 the peasantry increased their landed possessions by 91%, and the merchants bought considerable areas from the nobles, who altogether sold 43% of their estates. Although the soil is far from fertile, no less than 30% of the total area is under crops and 12% under meadows. The crops principally cultivated are rye, oats, barley, pease, potatoes, flax (for which the government is famous) and hemp. Grain has to be imported, but oats are exported. Owing to the efforts of the *zemstvos*, there has been a notable improvement in agriculture, especially in dairy-farming. Fishing in Lake Pskov and the smaller lakes is a source of income. The manufacture of wooden wares for local needs, ship-building, the timber trade, and the weaving of linen and woollens for local requirements are additional sources of income. Flax, flour, tobacco factories, saw-mills, distilleries and breweries are the principal industrial establishments. The population engage also in the preparation of lime, in stone-quarrying, and in the transport of merchandise. (P. A. K.; J. T. BE.)

PSKOV, in German, *Pleskau*, a town of Russia, capital of the government of the same name and an archiepiscopal see of the Orthodox Greek Church, situated on both banks of the Velikaya River, 9 m. S.E. from Lake Pskov and 170 m. by rail S.W. of St Petersburg. Pop. (1897), 30,424. The chief part of the town, with its kremlin on a hill, occupies the right bank of the river, to which the ruins of its old walls (built in 1266) descend; the Zapskovye stretches along the same bank of the Velikaya below its confluence with the Pskova; and the Zavelichye occupies the left bank of the Velikaya—all three keeping their old historical names. The cathedral in the kremlin has been four times rebuilt since the 12th century, the present edifice dating from 1691-1699, and contains some very old shrines, as also the graves of the bishops of Pskov and of several Pskov princes, including those of Dovmont (d. 1299), and Vsevolod (d. 1138). The church of Dmitriy Solunskiy dates originally from the 12th century; there are others belonging to the 14th and 15th. The Spaso-Mirozhskiy monastery, founded in 1156, and restored in 1890-1903, has many remarkable antiquities. The ruins of numerous rich and populous monasteries in or near the town attest its former wealth and greatness. The present town is ill-built, chiefly of wood, and shows traces of decay. It has a cadets' school, a normal school for teachers, and a few lower technical schools, an archaeological museum (1903) and some scientific societies. The private collections (coins, antiquities, art works, &c.) of Messrs Pushkin and Sudhov are two of the most remarkable in Russia. The manufactures are unimportant. Since the completion of the St Petersburg and Warsaw railway the trade of Pskov has increased. Pskov has regular steam communication with Dorpat.

History.—Pskov, formerly the sister republic of Novgorod, and one of the oldest cities of Russia, maintained its independence and its free institutions until the 16th century, being thus

the last to be brought under the rule of Moscow. It already existed in the time of Rurik (9th century); and Nestor mentions under the year 914 that Olga, wife of Igor, prince of Novgorod, was brought from Pleskov (*i.e.* Pskov). The Velikaya valley and river were from a remote antiquity a channel for the trade of the south of Europe with the Baltic coast. Pskov being an important strategic point, its possession was obstinately disputed between the Russians and the Germans and Lithuanians throughout the 11th and 12th centuries. At that time the place had its own independent institutions; but it became in the 12th century a *prigorod* of the Novgorod republic—that is a city having its own free institutions, but included in certain respects within the jurisdiction of the metropolis, and compelled in time of war to march against the common enemy. Pskov had, however, its own prince (*defensor municipii*); and in the second half of the 13th century Prince (Timotheus) Dovmont fortified it so strongly that the town asserted its independence of Novgorod, with which, in 1348, it concluded a treaty wherein the two republics were recognized as equals. Its rule extended over the territory which now forms the districts of Pskov, Ostrov, Opochka, and Gdov (farther north on the east side of Lake Peipus). The *vyeche* or council of Pskov was sovereign, the councils of the subordinate towns being supreme in their own municipal affairs. The council was supreme in all affairs of general interest, as well as a supreme court of justice, and the princes were elected by it; these last had to defend the city and levied the taxes, which were assessed by twelve citizens. But while Novgorod constantly showed a tendency to become an oligarchy of the wealthier merchants, Pskov figured as a republic in which the influence of the poorer classes prevailed. Its trading associations, supported by those of the working classes, checked the influence of the wealthier merchants.

This struggle continued throughout the 14th and 15th centuries. Notwithstanding these conflicts Pskov was a very wealthy city. Its strong walls, its forty large and wealthy churches, built during this period, its numerous monasteries, and its extensive trade, bear testimony to the wealth of the inhabitants, who then numbered about 60,000. As early as the 13th century Pskov was an important station for the trade between Novgorod and Riga. A century later it became a member of the Hanseatic League. Its merchants and trading associations had factories at Narva, Reval and Riga, and exported flax, corn, tallow, skins, tar, pitch, honey, and timber for ship-building. Silks, woollen stuffs, and all kinds of manufactured wares were brought back in exchange. In 1399 the prince of Moscow claimed the privilege of confirming the elected prince of Pskov in his rights; and though, fifty years later, Pskov and Novgorod concluded defensive treaties against Moscow, the poorer classes continued to seek at Moscow a protection against the richer citizens. After the fall of Novgorod (1475) Pskov was taken (1510) by Basil Ivanovich, prince of Moscow, and a *voivode* or deputy was nominated to govern the city. Moscow, at the end of the 17th century, abolished the last vestiges of self-government at Pskov, which thenceforward fell into rapid decay. Near this city the Teutonic knights inflicted a severe defeat upon the Russians in 1502. Pskov became a stronghold of Russia against Poland, and was besieged (1581) for seven months by Stephen Bathory during the Livonian War, and in 1615 by Gustavus Adolphus of Sweden. Under Peter the Great it became a fortified camp.

(P. A. K.; J. T. BE.)

PSORIASIS, a skin affection characterized by the occurrence of flat dry patches of varying size covered with silvery white scales. Next to eczema and ringworm it is one of the most commonly found skin diseases. It occurs frequently during infancy and early adult life, and rarely begins after the age of fifty. Though a parasitic origin has been suggested, no bacteriological factor has yet been found, and it has been demonstrated that psoriasis may follow on nervous shock, gout, mental emotion and insufficient nourishment. It may also follow an attack of scarlet fever or erysipelas. The site of the disease may be determined by an abrasion or other injury of the skin,

or even an irritation caused by friction of the clothing. The favourite starting point of the lesion is either the elbows or the fronts of the knees. It is nearly always symmetrical in its distribution, and spreads over the trunk and the extensor surfaces of the limbs, in contrast to eczema, which selects the flexor surfaces. The hairy scalp may also be affected. The eruption generally first shows itself as one or more papules, at first red and spreading, and later white from the formation of scales and red at the spreading margin, where it is surrounded by a hyperaemic zone. On removing the scales is seen a smooth hyperaemic zone dotted with red spots. The patches spread centrifugally and may remain stationary for a long time or coalesce with other patches and cover large areas of skin. In some cases involution of the central portion accompanies the spreading of the patch, and large concentric rings are formed. The lesions may persist for years, or spontaneously disappear, leaving behind a slight brown stain. The symptoms are usually slight and there is little or no irritation or itching, and no pain except in a form which is associated with osteo-arthritis. The disease, though of noted chronicity, is subject to sudden exacerbations, and may reappear at intervals after it has completely disappeared. It has little or no effect upon the general health. Several forms have been described, *viz.* the simple uncomplicated, the nervous, the osteo-arthritic, and the seborrhoeic. Varieties have also been named according to the character of the patches, such as psoriasis punctata, guttata, circinata or nummularis, or when large areas are involved and the skin is harsh, dry and cracked, it is known as psoriasis inveterata. The pathological changes taking place in the skin have been described as an inflammation of the papillae and corium, with a down-growth of the stratum mucosum between the papillae and an increase of the horny layer (keratosis). This latter, however, has been said to be due to the formation in it of tiny dry abscesses. The silvery appearance of the scales is due to the inclusion of air globules within them. The treatment is hygienic, constitutional and local. The clothing must be regulated so as to prevent undue perspiration or irritation or chafing of the skin. The most effective local application is chrysarobin used as an ointment. A bath of hot water and soap should first be given, or an alkaline bath, in order to remove all the scales; the ointment is then applied, but must be used over a small area at a time, as it is apt to set up dermatitis. Tarry applications, such as unguentum picis liquidae, creosote ointment or liquor carbonis detergens, are also useful; and radio-therapy has caused a rapid removal of the lesions, but neither it nor the ointment has prevented subsequent recurrence. In chronic cases the sulphur-water baths of Harrogate, Aix-les-Bains and Aachen have been successful. The internal administration of small doses of vinum antimoniale, in acute cases, or of arsenic (in gradually increasing doses of the liquor arsenicalis) in chronic cases, is undoubtedly beneficial.

PSOROSPERMIASIS, the medical term for a disease caused by the animal parasites known as psorosperms or gregarinidae, found in the liver, kidneys and ureters.

PSYCHE ($\psi\chi\eta$), in Greek mythology, the personification of the human soul. The story of the love of Eros (Cupid) for Psyche is a philosophical allegory, founded upon the Platonic conception of the soul. In this connexion Psyche was represented in Greek and Graeco-Roman art as a tender maiden, with bird's or butterfly's wings, or simply as a butterfly. Sometimes she is pursued and tormented by Eros, sometimes she revenges herself upon him, sometimes she embraces him in fondest affection. The tale of Cupid and Psyche, in the *Melamorphoses* of Apuleius, has nothing in common with this conception but the name. In it Psyche, the youngest daughter of a king, arouses the jealousy of Venus, who orders Cupid to inspire her with love for the most despicable of men. Cupid, however, falls in love with her himself, and carries her off to a secluded spot, where he visits her by night, unseen and unrecognized by her. Persuaded by her sisters that her companion is a hideous monster, and forgetful of his warning, she lights a lamp to look upon him while he is asleep; in her ecstasy at his beauty

she lets fall a drop of burning oil upon the face of Cupid, who awakes and disappears. Wandering over the earth in search of him, Psyche falls into the hands of Venus, who forces her to undertake the most difficult tasks. The last and most dangerous of these is to fetch from the world below the box containing the ointment of beauty. She secures the box, but on her way back opens it and is stupefied by the vapour. She is only restored to her senses by contact with the arrow of Cupid, at whose entreaty Jupiter makes her immortal and bestows her in marriage upon her lover. The meaning of the allegory is obvious. Psyche, as the personification of the soul, is only permitted to enjoy her happiness so long as she abstains from ill-advised curiosity. The desire to pry into its nature brings suffering upon her; but in the end, purified by what she has undergone, she is restored to her former condition of bliss by the mighty power of love.

On this story see L. Friedländer, "Ueber das Märchen von Amor und Psyche" (in *Darstellungen aus der Sittengeschichte Roms*, 1888, vol. i.; for a treatment of the Greek conception, see E. Rohde, *Psyche*, 1894). For Psyche in art see A. Conze, *De Psyche imaginibus quibusdam* (1855); Max Collignon, *Essai sur les monuments grecs et romains relatifs au mythe de Psyché* (1877).

PSYCHICAL RESEARCH, a term which may be defined, partially, as an examination into the amount of truth contained in world-wide superstitions. Thus when Saul disguised himself before his séance with the witch of Endor, and when Croesus scientifically tested the oracles of Greece (finding clairvoyance or *lucidité* in the Delphic Pythoness), Saul and Croesus were psychical researchers. A more systematic student was the Neoplatonist philosopher Porphyry. In his letter to Anebo, answered in *Περὶ μυστηρίων* by Iamblichus (?) we find Porphyry concerned with the usual alleged phenomena—prophecy; the power of walking through fire unharmed; the movements of inanimate objects, untouched; the "levitation" of "mediums"; apparitions of spirits, their replies to questions, the falsehood of those replies; and so forth. Similar phenomena fill the lives of the saints and the records of witch trials. Apparitions, especially of the dying or the dead; the stereotyped disturbances in haunted houses; and the miraculous healing of diseases, are current in classical and medieval records. The exhibition of remote or even future events, to gazers in mirrors, crystals, vessels full of water, or drops of ink or blood, is equally notorious in classical, Oriental, medieval and modern literature; while the whole range of these phenomena is found in Chinese, Japanese, Hindu, ancient American, Red Indian and savage belief.

At various periods, and in proportion to the scientific methods of the ages, attempts have been made to examine these things scientifically. St Augustine wrote on the whole topic with remarkable acuteness and considerable scepticism; his treatment of miracles of healing is especially noteworthy. After Petrus Thyraeus (1546-1601), S. J. Wierus, Ludwig Lavater (1527-1586), and other authors of the 16th century, came the labours of Glanvill, Henry More, Richard Baxter, Boyle, Cotton Mather, and others in England and America, during and after the Restoration. Attempts were made to get first-hand evidences and Glanvill investigated the knocking drummer of Tedworth *in situ* (1663). The disturbances in the house of the Wesleys at Epworth (1716 and later) were famous, and have copious contemporary record. David Hume believed himself to have settled questions which, when revived by the case of Swedenborg and the experiments of Mesmer and his pupils, puzzled and interested Kant. The influence of Mesmer has never died out; the fact of "animal magnetism" (with such examples as the "divining rod," and the phenomena in general) was accepted in his manner, and explained, by Hegel. The researches of Braid (c. 1840-1850) gave a new name, "hypnotism," to what had been called "mesmerism" or "animal magnetism"; a name conveying no theory of "magnetic" or other "fluids." "Mesmerism" implies a theory of "emanations" from the operator to the patient; "hypnotism" implies no such hypothesis. In the middle of the 19th century Dr Gregory and Dr Mayo published their entertaining but unsystematic works,

Animal Magnetism and *The Truths in Popular Superstitions* respectively. Esdaile and Elliotson were practical pioneers in the medical use of induced sleep or somnambulism. For their ideas and experiments *The Zoist* may be consulted. The epidemic of "spiritualism" and of "turning tables" then invaded Europe from America, and was discussed by Dr Carpenter, Faraday, Gasparin, De Morgan and many others. The adventures of Daniel Dunglas Home excited all Europe, and his effects were studied by Sir William Crookes with especial attention. Home disappeared after a lawsuit; his successes remain an unsolved enigma. Believers explained them by the agency of the spirits of the dead, the old savage theory. He had many followers, most of whom, if not all, were detected in vulgar impostures. Of the books of this period those of Mr Richard Dale Owen (1810-1890) are the most curious, but exact method was still to seek.

In 1882 the Society for Psychical Research, under the presidency of Henry Sidgwick, professor of moral philosophy in the university of Cambridge, was founded expressly for the purpose of introducing scientific method into the study of the "debatable phenomena." Other early members were Edmund Gurney, F. W. H. Myers, Andrew Lang, Professor Barrett, Mrs Sidgwick, F. Podmore, Lord Tennyson, Lord Rayleigh and Professor Adams; while among presidents were Professor Balfour Stewart, A. J. Balfour, Professor William James of Harvard and Sir William Crookes. The society has published many volumes of *Proceedings*. In France and in Germany and Italy many men of distinguished scientific position have examined the Italian "medium" Eusapia Palladino, and have contributed experiments, chiefly in the field of hypnotism and "telepathy." Hypnotism has been introduced into official experimental psychology and medicine with some success.

It is plain that the range of psychical research is almost unlimited. It impinges on anthropology (with its study of the savage theory of spirits—animism—and of diabolical possession), and on the usual province of psychology, in the problems of the hallucinations both of morbid patients and of people in normal mental health. The whole topic of the unconscious or subconscious self is made matter not of mere metaphysical speculation (as by Kant and Hamilton), but of exact observation, and, by aid of hypnotism and automatism, of direct experiment. The six original committees of the society undertook the following themes:—

1. An examination of the nature and extent of any influence which may be exerted by one mind upon another, apart from any generally recognized mode of perception.
2. The study of hypnotism and the forms of so-called mesmeric trance, clairvoyance and other allied phenomena.
3. A critical revision of Reichenbach's researches into certain organizations called "sensitive."
4. A careful investigation of any reports, resting on strong testimony, regarding apparitions at the moment of death or otherwise, or regarding disturbances in houses reputed to be haunted.
5. An inquiry into the various physical phenomena commonly called spiritualistic, with an attempt to discover their causes and general laws.
6. The collection and collation of existing materials bearing on the history of these subjects.

To these themes we might now add the study of "crystal-gazing," and of the hallucinatory visions which a fair percentage of people observe when staring into any clear deep, usually a glass ball; but ink (with some experimenters) does as well, or a glass water-jug. Of these themes, the third has practically led to nothing. The experiments of Reichenbach on the perception of flames issuing from magnets have not been verified. The collection of historical examples, again (6), has not been much pursued by the society, except in Mr Gurney's studies of witchcraft in *Phantasms of the Living*, by himself, Mr Podmore and Mr Myers. On the other hand, a vast number of experiments were made in "thought transference." (1) Diagrams drawn by A were reproduced by B; cards thought of, numbers

and so forth were also reproduced in conditions that appeared to make the normal transference of the idea by sound, sight or touch impossible, and to put chance coincidence out of court. In one or two instances collusion was detected ingeniously. In others two explanatory theories have been broached. People may accidentally coincide in their choice of diagrams, or the "unconscious whispering" of a person fixing his mind hard on a number, card or what not may be heard or seen. But coincidence in diagrams does not apply when a ship, dumb-bells, a candlestick or a cat is drawn by both experimenters; nor can "unconscious whispering" be heard or seen when the experimenters are in different rooms. On the whole, the inquirers convinced themselves that one mind or brain may influence another mind or brain through no recognized channel of sense. This is, of course, an old idea (see Walton's *Life of Donne*, and his theory of the appearance of Mrs Donne, with a dead baby, to Dr Donne in Paris). The method of communication remains a problem. Are there "brain waves," analogous to the X-rays, from brain to recipient brain, or does mind touch mind in some unheard-of way? The former appears to be the hypothesis preferred by Sir William Crookes and Professor Flournoy (*Des Indes à la planète Mars*, pp. 363-365). On this showing there is nothing "supranormal" in "telepathy," as it is called. The latter theory of "a purely spiritual communication" is argued for by Mr Myers (*Proceedings of the Society for Psychical Research*, xv. 407-410). If we accept telepathy as experimentally demonstrated, and regard it as a *physical* process, we reduce (4), "apparitions at the moment of death or otherwise," to a normal though not very usual fact. Everyone would admit this in the case of mere empty hallucinations. A, in Paisley, sees P, in London, present in his room. P is neither dying nor in any other crisis, and A is, as both continue to be, in his normal health. Such experiences are by no means very uncommon, when there is nothing to suggest that P has exercised any telepathic influence on A. On the other hand, in *Phantasms of the Living*, and in the report on the Census of Hallucinations (*Proceedings*, vol. x.), the society has published large numbers of "coincidental" hallucinations, the appearance of P to A coinciding with the death or other crisis of the distant P. That such "wraiths" do occur is the popular and savage belief. But, it may be urged, many hallucinations occur and many deaths. People only remember the hallucinations which happened, or were made by erroneous reckoning to seem to happen, coincidentally with the decease of the person seen. This is not quite true, for a hallucination so vivid as to betaken for a real person and addressed as such is not easily forgotten by a sober citizen, even if "nothing happened" afterwards. None the less, the coincidental hallucinations have certainly a better chance of being remembered, while fancy is apt to exaggerate the closeness of the coincidence. Nothing can demonstrate that coincidences between death and hallucination occur more frequently than by the doctrine of chance they ought to do, except a census of the whole population. In the present indifference of government to psychical science no party is likely to institute such a census, and even if it were done, the frivolity of mankind would throw doubt on the statistics. It would be necessary to cross-examine each "percipient," and to ask for documentary or other corroborative evidence in each case.

The Society for Psychical Research collected statistics in proportion to its resources. More than 17,000 answers were received to questions rather widely circulated. The affirmative respondents were examined closely, their mental and physical health and circumstances inquired into, and collectors of evidence were especially enjoined to avoid selecting persons known to be likely to return affirmative replies. There were 80 cases at first hand in which the death of the person seen coincided, within twelve hours, with the visual hallucination of his or her presence, out of 352 instances of such hallucinations. By way of arriving at the true proportions, the hallucinations which coincided with nothing were multiplied by four. In this way allowance was made for obliviousness of non-coincidental hallucinations. The verdict of the committee was that, on the

evidence before them, hallucinations coincided with deaths in a ratio of 440 times more than was to be expected by the law of probabilities. The committee came to the conclusion that a relation of cause and effect does exist between the death of A and the vision of A beheld by P. The hallucination is apparently caused from without by some unexplained action of the mind or brain of A on the brain or mind of P. This effect is also traced, where death does not occur, for example, in the many instances of false "arrivals." A is on his way to X, or is dreaming that he is on his way, and is seen at X by P, or by P, Q and R, as may happen. These cases are common, and were explained in Celtic philosophy by the theory of the "Co-Walker," a kind of "astral body." The facts are accounted for in the same way by Scandinavian popular philosophy. Possibly in many instances such hallucinations are the result of expectancy in the beholder. Yet if we go out to shoot or fish, excepting to encounter grouse or salmon, we do not usually see grouse or salmon if they are not there! Where the arrival is not expected, this explanation fails. In "second sight," even among savages, these occurrences are not infrequent, and doubtless admit of an explanation by telepathy. In two instances, known at first hand to the present writer, persons dreamed, at a distance, that they entered their own homes. In one the person was seen, in the other distinctly heard, by the inmates of his or her house. In several of these examples knocks are heard, as in spiritualist séances. In fact, if we accept the evidence, living but remote persons may, unconsciously, produce effects of sounds and of phantasms exactly like those which popular belief ascribes to the spirits of the dead.

If we admit the evidence, of which a great body exists, and if we attribute the phenomena to telepathy, curious inferences may be drawn. Thus if the phenomena are such as only the spirits of the dead could be credited with producing—if the dead were frequently recognized by various good witnesses—it would follow (on the hypothesis of telepathy) that telepathy is not a *physical* process caused by material waves or rays from living brain to brain, the dead having no brains in working order. On the other hand, if living brains may thus affect each other, a subjective hallucination experienced by the living A may conceivably be "wired on" to the living P. Thus A, in a given house, may have a mere subjective hallucination of the presence of the dead B, and may, unconsciously, infect with that hallucination other persons who come to the house. Thus once admit that any living brain may infect any other, and it becomes practically impossible for a spirit of the dead to prove his identity. Any information which he may give in any way must either be known to living people, however remote, or unknown. If known to a living person, he may, unconsciously, "wire it on" to the seer. If wholly unknown to everybody, the veracity of the information cannot be demonstrated, except later, if it refers to the unknown future. Thus the theory of telepathy, with a little good will, puts the existence and activity of the souls of the dead beyond possibility of proof.

These remarks apply to the researches of the society into alleged isolated phantasms of the dead, and into "haunted houses." As to the former cases, it is admitted on all hands that sane and sober people may have subjective hallucinations of the presence of living friends, not dying or in any other crisis. Obviously then, the appearance of a dead person may equally be an empty hallucination. Thus, a member of the House of Commons, standing at the entrance of a certain committee-room, saw another member, of peculiar aspect and gait, pass him and enter the room, his favourite haunt. Several hours passed before the percipient suddenly recollected that the other member had been dead for some months. Even superstition cannot argue that this appearance was a ghost. In the same way Hawthorne, the celebrated novelist, frequently, he has written, saw a dead club-man in his club. But suppose, for the sake of argument, that at intervals members of the house kept seeing such appearances of dead members of parliament, and suppose that they had never seen the prototypes in their lifetime, but yet correctly described them: then it might be said that their hallucinations

had merely been "wired on" from the brain of some living member of parliament who knew the deceased.

Thus telepathy cuts two ways. It is, if accepted, a singular discovery, but it throws an enormous burden of proof on a "ghost" who wants to establish his identity. In the same way telepathy cuts at the root of "clairvoyance," or lucid view of events remote in space or distant in time. The vision may have been "wired on" telepathically by a living person who knew the remote event. The "supranormal" can only be proved if the information conveyed by the hallucination is verified in the future, or is proved by the finding of documents not known to exist at the time of the hallucination, but afterwards discovered. A curious possible instance was the discovery in 1856 of a MS. inventory of the jewels of Mary Stuart (1566), verifying in some degree a clairvoyant vision about the jewels published some years earlier (see "Queen Mary's Jewels" in the writer's *Book of Dreams and Ghosts*). For the same reasons the information nominally given by "spirits" of the dead through the mouth or by the automatic writing of Mrs Piper (Boston, U.S.) and other mediums may be explained by telepathy from the living who know the facts. This theory was rejected, for example, in the case of Mrs Piper, by Myers and Dr Richard Hodgson, who devoted much time to the examination of the lady (see *Proceedings*, vols. vi., viii., xiii., xiv., with criticisms by Mrs Sidgwick and the present writer in vol. xv. pt. xxxvi). In the late Dr Hodgson's opinion, the dead do communicate through the automatic writing or speaking of Mrs Piper. The published evidence (much is unpublished) does not seem to justify the conclusion, which is not accepted by Mrs Piper herself! Dr J. H. Hyslop has published enormous and minute reports on Mrs Piper, convincing to himself but not to most readers.

This leads us to the chief field of research in "automatism," or actions of the subconscious or "subliminal" self. The prototype of such things is found in the performances of natural somnambulists, who in all ages have seemed to exhibit faculties beyond their power when in a normal condition. The experiments of Mesmer, and of those who followed in his track, down to the psychologists of to-day, proved (what had long been known to savages and conjurers) that a state of somnambulism could be induced from without. Moreover, it is proved that certain persons can, as it were, hypnotize themselves, even unwittingly, and pass into trance. In these *secondary* conditions of trance, such persons are not only amenable to "suggestion," but occasionally evolve what are called secondary personalities: they speak in voices not their own, and exhibit traits of character not theirs, but in harmony with the impersonation. The popular, savage and ancient theory of these phenomena was that the people thus affected were inspired by a god or spirit, or "possessed" by a demon or a dead man. Science now regards the gods or demons or spirits as mere exhibitions of the secondary personality, which awakens when the normal personality slumbers. The knowledge and faculties of the secondary personality, far exceeding those exhibited in the normal state, are explained to a great extent by the patient's command, when in the secondary state, of resources latent in the memory. The same explanation is offered for other phenomena, like those of automatic writing, knocking out answers by tilting tables, or discovering objects by aid of the "divining rod." The muscular actions that tilt the table, or wag the rod, or direct the pencil or planchette, are unconsciously made, and reveal the latent stores of subconscious knowledge, so that a man writes or knocks out information which he possessed, but did not suspect himself of possessing. These processes were familiar to the Neoplatonists, and in one form or other are practised by Chinese, Tibetans, Negroes, Malaysians and Melanesians. A similar kind of automatism is revealed in the inspirations of genius, which often astonish the author or artist himself. An interesting example has been studied by Myers in the feats of arithmetic recorded about "calculating boys," who are usually unconscious of their methods. The whole of this vast field of the unconscious, or subconscious, or subliminal self has

been especially examined by Myers, and by such psychologists as Ribot, Janet, Richet, Flournoy and many others.

The general result is a normal explanation, not yet complete, of the phenomena hitherto attributed to witchcraft, inspiration, possession, and so forth. Probably the devils, saints, angels and spirits who have communicated with witches, living saints, demoniacs and visionaries are mere hallucinatory reflections from the subconscious self, endowed with its store of latent memories and strangely acute percipient faculties. Thus a curious chapter of human history is at last within possible reach of explanation. Men regard phenomena as "supranormal" or "supernatural," or reject them altogether, till their *modus* is explained. But it would not be candid to say that the explanation is complete, or nearly complete. The nature of the hypnotic trance itself remains a matter of dispute. The knowledge automatically revealed can by no means always be accounted for, either by latent memory or by the sharpening of the normal faculties of perception, while the limits of telepathy (if it be accepted) are vaguely conjectured. Even the results of simple experiments in "crystal-gazing" are often very perplexing. Further experiment may reveal some normal explanation, while scepticism (which seldom takes the trouble to examine the alleged facts with any care) can always repose on a theory of malobservation and imposture. These, of course, are *verae causae*, while in this, as in all provinces of human evidence, bad memories and unconscious errors distort the testimony. Psychological research encourages, or ought to encourage, the cool impartiality in examining, collecting and recording facts, which is usually absent, in greater or less degree, from the work even of eminent historians. Men of equal honesty and acuteness may believe or disbelieve in the innocence of Mary Queen of Scots, or in the "spirits" which control Mrs Piper. As to alleged "physical phenomena" of unknown cause, one, the power of passing without lesion with naked feet over fire, has recently been attested by numerous competent observers and experimenters in the ritual of Fijians and other South Sea Islanders, Japanese, Bulgarians, natives of southern India and other races. (The evidence has been collected by the present writer in *Proceedings S.P.R.* vol. xv. pt. xxxvi. pp. 2-15. Compare a case examined and explained more or less by S. P. Langley, *Nature*, August 22, 1901.) The much more famous tales of movements of objects untouched have been carefully examined, and perhaps in no instance have professional performers proved innocent of fraud. Yet the best known living medium, Eusapia Palladino, though exposed at Cambridge, has been rehabilitated, after later experiments, in the opinion of many distinguished Continental observers, who entirely disbelieve in the old theory, the action of "spirits," and venture no other hypothesis.

The results of psychical research, after several years of work, are not really less than could be expected from toil in a field so difficult. The theory of alternating, or secondary, personalities is the key, as we have said, to a strange chapter in "the history of human error." The provisional hypothesis of telepathy puts a meaning into the innumerable tales of "wraiths" and of "second sight." It is never waste of time to investigate the area of human faculty; and practical results, in the medical treatment of abnormal intellectual conditions, have already been obtained. The conduct of our witch-burning ancestors now becomes intelligible, a step on the way to being pardonable. With their methods and inherited prejudices they could scarcely have reasoned otherwise than they did in certain cases of hysteria and autohypnotization. Many "miracles" of healing and of "stigmatization" become credible when verified in modern experience and explained by "suggestion"; though to "explain the explanation" is a task for the future. Such as it is, the theory was accepted by St Francis de Sales in the case of St Theresa. Results of wider range and of more momentous interest may yet be obtained. The science of electrical phenomena was not developed in a quarter of a century, and it would be premature to ask more from psychical research than it has achieved in a short period. The subject is not readily capable

of exact experiment, human faculty being, as it were, capricious, when compared with ordinary physical processes. Imposture, conscious or unconscious, is also an element of difficulty. But already phenomena which are copiously reported throughout the whole course of history have been proved to possess an actual basis in fact, have been classified, and to some extent have been explained. Even if no light is ever to be cast on spiritual problems, at least the field of psychology has been extended.

The literature of psychical research is already considerable, and a complete bibliography would occupy much space. Readers who care to pursue the study will find their best guide in the *Proceedings of the Society for Psychical Research*, which contains a catalogue of the society's collection, including the Gurney Library (hypnotism), with reviews of modern books in many languages—French, German, Italian, Russian—as they appear. Among modern English books may be recommended *Phantasms of the Living*, by Gurney, Podmore and Myers; *Studies in Psychical Research*, by Podmore, with his *Apparitions and Thought-Transference*; and *Principles of Psychology*, by Professor William James, of Harvard. The historical side of the subject, especially as regards the beliefs of savages and of classical antiquity, may be studied in E. B. Tylor's *Primitive Culture* (under "Animism"), in Myers's *Classical Essays* (under "Greek Oracles"), and A. Lang's *Cock Lane and Common Sense*, and *Making of Religion*. Myers's work, *Human Personality*, contains vast collections of facts, with a provisional theory. Myers's regretted death prevented him from finally revising his book, which contains certain inconsistencies. It is plain that he tended more and more to the belief in the "invasion" and "possession" of living human organisms by spirits of the dead. The same tendency marks an article on "Psychical Research," by Sir Oliver Lodge, in *Harper's Magazine* (August 1908). Other students can find, in the evidence cited, no warrant for this return to the "palaeolithic psychology" of "invasion" and "possession." Th. Flournoy's *Des Indes à la planète Mars* is a penetrating study of pseudo-spiritual "messages." A criticism making against the notion of telepathy may be found in Herr Parish's *Hallucinations and Illusions* (Eng. trans.). Some errors and confusions in this work (due in part to the expansion of the original text) are noted in A. Lang's *Making of Religion*, appendix A. Such topics as TELEPATHY, CRYSTAL-GAZING, HYPNOTISM, SECOND SIGHT, the POLTERGEIST, &c., are dealt with under separate articles in this work. (A. L.)

PSYCHOLOGY ($\psi\upsilon\chi\eta$, the mind or soul, and $\lambda\omicron\gamma\omicron\varsigma$, theory), the science of mind, which can only be more strictly defined by an analysis of what "mind" means.

1. In the several natural sciences the scope and subject-matter of each are so evident that little preliminary discussion is called for. But with psychology, however much it is freed from metaphysics, this is different. It is indeed ordinarily assumed that its subject-matter can be at once defined. "It is what you can perceive by consciousness or reflection or the internal sense," says one, "just as the subject-matter of optics is what you can perceive by sight." Or, "psychology is the science of the phenomena of mind," we are told again, "and is thus marked off from the physical sciences, which treat only of the phenomena of matter." But, whereas nothing is simpler than to distinguish between seeing and hearing, or between the phenomena of heat and the phenomena of gravitation, a very little reflection may convince us that we cannot in the same fashion distinguish internal from external sense, or make clear to ourselves what we mean by phenomena of mind as distinct from phenomena of matter.

To every sense there corresponds a sense-organ; the several senses are distinct and independent, so that no one sense can add to or alter the materials of another: the possession of five senses, e.g. furnishing no data as to the character of a possible sixth. Moreover, sense-impressions are passively received and occur in the first instance without regard to the feeling or volition of the recipient and without any manner of relation to the "contents of consciousness" at the moment. Now such a description will apply but very partially to the so-called "internal sense." For we do not by means of it passively receive impressions differing from all previous presentations, as the sensations of colour for one "couched" differ from all he has experienced before: the new facts consist rather in the recognition of certain relations among pre-existing presentations, i.e. are due to our mental activity and not to a special mode of what has been called our sensitivity. For when we taste we cannot hear that we taste, when we see we cannot smell that we see; but when we taste we may be conscious that we taste, when we hear we may be conscious that we hear. Moreover, the facts so ascertained are never independent of feeling and volition and of the contents of

consciousness at the time, as true sensations are. Also if we consult the physiologist we learn that there is no evidence of any organ or "centre" that could be regarded as the "physical basis" of this inner sense; and, if self-consciousness alone is temporarily in abeyance and a man merely "beside himself," such state of delirium has little analogy to the functional blindness or deafness that constitutes the temporary suspension of sight or hearing.

To the concept of an internal perception or observation the preceding objections do not necessarily apply—that is to say, this concept may be so defined that they need not. But then in proportion as we escape the change of assuming a special sense which furnishes the material for such perception or observation, in that same proportion are we compelled to seek for some other mode of distinguishing its subject-matter. For, so far as the mere mental activity of perceiving or observing is concerned, it is not easy to see any essential difference in the process whether what is observed be psychical or physical. It is quite true that the so-called psychological observation is more difficult, because the facts observed are often less definite and less persistent, and admit less of actual isolation than physical facts do; but the process of recognizing similarities or differences, the dangers of mal-observation or non-observation, are not materially altered on that account. It may be further allowed that there is one difficulty peculiarly felt in psychological observation, the one most inaccurately expressed by saying that here the observer and the observed are one. But this difficulty is surely in the first instance due to the very obvious fact that our powers of attention are limited, so that we cannot alter the distribution of attention at any moment without altering the contents of consciousness at that moment. Accordingly, where there are no other ways of surmounting this difficulty, the psychological observer must either trust to representations at a later time, or he must acquire the power of taking momentary glances at the psychological aspects of the phase of consciousness in question. And this one with any aptitude for such studies can do with so slight a diversion of attention as not to disturb very seriously either the given state or that which immediately succeeds it. But very similar difficulties have to be similarly met by physical observers in certain special cases, as, e.g. in observing and registering the phenomena of solar eclipse; and similar aptitudes in the distribution of attention have to be acquired, say, by extempore orators or skilful surgeons. Just as little, then, as there is anything that we can with propriety call an inner sense, just so little can we find in the process of inner perception any satisfactory characteristic of the subject-matter of psychology. The question still is: What is it that is perceived or observed? and the readiest answer of course is: Internal experience as distinguished from external, what takes place in the mind as distinct from what takes place without.

This answer, it must be at once allowed, is adequate for most purposes, and a great deal of excellent psychological work has been done without ever calling it in question. But the distinction between internal and external experience is not one that can be drawn from the standpoint of psychology, at least not at the outset. From this standpoint it appears to be either (1) inaccurate or (2) not extra-psychological. As to (1), the boundary between the internal and the external was, no doubt, originally the surface of the body, with which the subject or self was identified; and in this sense the terms are of course correctly used. For a thing may, in the same sense of the word, be in one space and therefore not in—i.e. out of—another; but we express no intelligible relation if we speak of two things as being one in a given room and the other in last week. Any one is at liberty to say if he choose that a certain thing is "in his mind"; but if in this way he distinguishes it from something else not in his mind, then to be intelligible this must imply one of two statements—either that the something else is actually or possibly in some other mind, or, his own mind being alone considered, that at the time the something else does not exist at all. Yet, evident as it seems that the correlatives in and not-in must apply to the same category, whether space, time, presentation (or non-presentation) to a given subject, and so forth, we still find psychologists more or less consciously confused between "internal," meaning "presented" in the psychological sense, and "external," meaning not "not-presented" but corporeal or oftener extra-corporeal. But (2), when used to distinguish between presentations (some of which, or some relations of which with respect to others, are called "internal," and others or other relations, "external"), these terms are at all events accurate; only then they cease to mark off the psychological from the extra-psychological, inasmuch as psychology has to analyse this distinction and to exhibit the steps by which it has come about. But we have still to examine whether the distinction of phenomena of Matter and phenomena of Mind furnishes a better dividing line than the distinction of internal and external.

A phenomenon, as commonly understood, is what is manifest, sensible, evident, the implication being that there are eyes to see, ears to hear, and so forth—in other words, that there is presentation to a subject; and wherever there is presentation to a subject it will be allowed that we are in the domain of psychology. But in talking of physical phenomena we, in a way, abstract from this fact of presentation. Though consciousness should cease, the physicist would consider the sum

Mental and Material.

total of objects to remain the same: the orange would still be round, yellow and fragrant as before. For the physicist—whether aware of it or not—has taken up a position which for the present may be described by saying that phenomenon with him means appearance or manifestation, or—as we had better say—object, not for a concrete individual, but rather for what Kant called *Bewusstsein überhaupt*, or, as some render it, the objective consciousness, *i.e.* for an imaginary subject freed from all the limitations of actual subjects save that of depending on “sensibility” for the material of experience. However, this is not all, for, as we shall see presently, the psychologist also occupies this position; at least if he does not his is not a true science. But, further, the physicist leaves out of sight altogether the facts of attention, feeling, and so forth, all of which actual presentation entails. From the psychological point of view, on the other hand, the removal of the subject removes not only all such facts as attention and feeling, but all presentation or possibility of presentation whatever. Surely, then, to call a certain object, when we abstract from its presentation, a material phenomenon, and to call the actual presentation of this object a mental phenomenon, is a clumsy and confusing way of representing the difference between the two points of view. For the terms “material” and “mental” seem to imply that the two so-called phenomena have nothing in common, whereas the same object is involved in both, while the term “phenomenon” implies that the point of view is in each case the same, when in truth what is emphasized by the one the other ignores.

2. Paradoxical though it may be, we must then conclude that psychology cannot be defined by reference to a special subject-matter as such concrete sciences, for example, as mineralogy and botany can be; and, since it deals in

some sort with the whole of experience, it is obviously not an abstract science in any ordinary sense of that term. To be characterized at all, therefore, apart from metaphysical assumptions, it must be characterized by the standpoint from which this experience is viewed. It is by way of expressing this that widely different schools of psychology define it as subjective, all other positive sciences being distinguished as objective. But this seems scarcely more than a first approximation to the truth, and, as we have seen incidentally, is apt to be misleading. The distinction rather is that the standpoint of psychology is what is sometimes termed “individualistic,” that of the so-called object-sciences being “universalistic,” both alike being objective in the sense of being true for all, consisting of what Kant would call judgments of experience. For psychology is not a biography in any sense, still less a biography dealing with idiosyncrasies, and in an idiom having an interest and a meaning for one subject only, and incommunicable to any other. Locke, Berkeley and Hume have been severely handled because they regarded the critical investigation of knowledge as a psychological problem, and set to work to study the individual mind simply for the sake of this problem. But none the less their standpoint was the proper one for the science of psychology itself; and, however surely their philosophy was foredoomed to a collapse, there is no denying a steady psychological advance as we pass from Locke to Hume and his modern representatives. By “idea” Locke tells us he means “Whatsoever is the object of the understanding when a man thinks” (*i.e.* is conscious), and having, as it were, shut himself within such a circle of ideas he finds himself powerless to explain his knowledge of a world that is assumed to be independent of it; but he is able to give a very good account of some of these ideas themselves. He cannot justify his belief in the world of things whence certain of his simple ideas “were conveyed” any more than Robinson Crusoe could have explored the continents whose products were drifted to his desert island, though he might perhaps survey the island itself well enough. Berkeley accordingly, as Professor Fraser happily puts it, abolished Locke’s hypothetical outer circle. Thereby he made the psychological standpoint clearer than ever—hence the truth of Hume’s remark, that Berkeley’s arguments “admit of no answer”; at the same time the epistemological problem was as hopeless as before—hence again the truth of Hume’s remark that those arguments “produced no conviction.” Of all the facts with which he deals, the psychologist may truly say that their *esse* is *percipi*, inasmuch as all his facts are facts of presentation, are ideas in Locke’s sense, or objects which imply a subject. Before we became conscious there was no world for us; should our consciousness cease, the world for us

ceases too; had we been born blind, the world would for us have had no colour; if deaf, it would have had no sounds; if idiotic, it would have had no meaning. Psychology, then, never transcends the limits of the individual. But now, though this Berkeleyan standpoint is the standpoint of psychology, psychology is not pledged to the method employed by Berkeley and by Locke. Psychology may be individualistic without being confined exclusively to the introspective method. There is nothing to hinder the psychologist from employing materials furnished by his observations of other men, of infants, of the lower animals, or of the insane; nothing to hinder him taking counsel with the philologist or even the physiologist, provided always he can show the psychological bearings of those facts which are not directly psychological. The standpoint of psychology is individualistic; by whatever methods, from whatever sources its facts are ascertained, they must—to have a psychological import—be regarded as having place in, or as being part of, *some one’s consciousness or experience*. In this sense, *i.e.* as presented to an individual, “the whole choir of heaven and furniture of earth” may belong to psychology, but otherwise they are psychological nonentities. In defining psychology, however, the propriety of avoiding the terms *mind* or *soul*, which it implies, is widely acknowledged; mind because of the disastrous dualism of mind and matter, soul because of its metaphysical associations. Hence F. A. Lange’s famous mot: modern psychology is *Psychologie ohne Seele*. But *consciousness*, which is the most frequent substitute, is continually confused with self-consciousness, and so is apt to involve undue stress on the subjective as opposed to the objective, as well as to emphasize the cognitive as against the conative factors. *Experience*, it is maintained, is a more fundamental and less ambiguous term. Psychology then is the science of individual experience. The problem of psychology, in dealing with this complex subject-matter, is in general—first, to ascertain its ultimate constituents, and, secondly, to determine and explain the laws of their interaction.

General Analysis.

3. In seeking to make a first general analysis of experience, we must start from individual human experience, for this alone is what we immediately know. From this standpoint we must endeavour to determine the “irreducible minimum” involved, so that our concept may apply to all lower forms of experience as well. Etymologically *experience* connotes practical acquaintance, efficiency and skill as the result of trial—usually repeated trial—and effort. Many recent writers on comparative psychology propose to make evidence of experience in this sense the criterion of psychical life. The ox knoweth his owner and the ass his master’s crib, and so would pass muster; but the ant and the bee, who are said to learn nothing, would, in spite of their marvellous instinctive skill, be regarded as mere automata in Descartes’s sense. That this criterion is decisive on the positive side will hardly be denied; the question how far it is available negatively we must examine later on. But it will be well first briefly to note some of the implications of this positive criterion: *Experience is the process of becoming expert by experiment*. The chief implication, no doubt, is that which in psychological language we express as the duality of subject and object. Looking at this relation as the comparative psychologist has to do, we find that it tallies in the main with the biological relation of organism and environment. The individuality of the organism corresponds to, though it is not necessarily identical with, the psychological subject, while to the environment and its changes corresponds the objective *continuum* or *totum objectivum* as we shall call it. This correspondence further helps us to see still more clearly the error of regarding individual experience as wholly subjective, and at the same time helps us to find some measure of truth in the naïve realism of Common Sense. As these points have an important bearing on the connexion of psychology and epistemology, we may attempt to elucidate them more fully.

Though it would be unwarrantable to resolve a *thing*, as some have done, into a mere meeting-point of relations, yet it is

perhaps as great a mistake to assume that it can be anything determinate in itself apart from all relations to other things. By the physicist this mistake can hardly be made: for him action and reaction are strictly correlative: a material system can do no work on itself. For the biologist, again, organism and environment are invariably complementary. But in psychology, when presentations are regarded as subjective modifications, we have this mistaken isolation in a glaring form, and all the hopeless difficulties of what is called "subjective idealism" are the result. Subjective modifications no doubt are always one constituent of individual experience, but always as correlative to objective modifications or change in the objective *continuum*. If experience were throughout subjective, not merely would the term subjective itself be meaningless, not merely would the conception of the objective never arise, but the entirely impersonal and intransitive process that remained, though it might be described as absolute becoming, could not be called even solipsism, least of all real experience. Common Sense, then, is right in positing, wherever experience is inferred, (1) a factor answering to what we know as self, and (2) another factor answering to what each of us knows as the world. It is further right in regarding the world which each one immediately knows as a coloured, sounding, tangible world, more exactly as a world of sensible qualities. The assumption of naïve realism, that the world as each one knows it exists as such independently of him, is questionable. But this assumption goes beyond individual experience, and does not, indeed could not, arise at this standpoint.

Answering to the individuality and unity of the subjective factor, there is a corresponding unity and individuality of the objective. Every Ego has its correlative Non-Ego, whence in the end such familiar saying as *quot homines tot sententiae* and the like. The doctrine of Leibnitz, that "each monad is a living mirror. . . representative of the universe according to its point of view," will, with obvious reservations, occur to many as illustrative here. In particular, Leibnitz emphasized one point on which psychology will do well to insist. "Since the world is a plenum," he begins, "all things are connected together and everybody acts upon every other, more or less, according to their distance, and is affected by their reaction; hence each monad is a living mirror,"¹ &c. Subject and Object, or (as it will be clearer in this connexion to say) Ego and Non-Ego, are then not merely logically a universe, but actually *the universe*, so that, as Leibnitz put it, "He who sees all could read in each what is happening everywhere" (*Monadology*, § 61). Though every individual experience is unique, yet the more Ego₁ is similar to Ego₂ the more their complementaries Non-Ego₁, Non-Ego₂ are likewise similar; much as two perspective projections are more similar the more adjacent their points of sight, and more similar as regards a given position the greater its distance from both points. No doubt we must also make a very extensive use of the hypothesis of subconsciousness, just as Leibnitz did, before we can say that *the universe* is the objective factor in each and every individual's experience. But we shall have in any case to allow that, besides the strictly limited "content" rising above the threshold of consciousness, there is an indefinite extension of the presentational *continuum* beyond it. And the Leibnitzian *Monadology* helps us also to clear up a certain confusion that besets terms such as "content of consciousness," or "finite centre of experience"—a barbarous but intelligible phrase that has recently appeared—the confusion, that is, with a mosaic of mutually exclusive areas, or with a scheme of mutually exclusive logical compartments. Consciousnesses, though in one respect mutually exclusive, do not limit each other in this fashion. For there is a sense in which all individual experiences are absolutely the same, though relatively different as to their point of view, *i.e.* as to the manner in which for each the same absolute whole is sundered into subjective and objective factors.

This way of looking at the facts of mind helps, again, to dispel the obscurity investing such terms as *subjective*, *intersubjective*,

¹ *Principles of Nature and Grace*, § 3.

transsubjective and *objective*, as these occur in psychological or epistemological discussions. For the psychologist must maintain that no experience is merely subjective: it is only epistemologists (notably Kant) who so describe individual experience, because objects experienced in their concrete particularity pertain, like so many idiosyncrasies, to the individual alone. In contrast with this, epistemologists then describe universal experience—the objects in which are the same for every experient—as objective experience *par excellence*. And so has arisen the time-honoured opposition of Sense-knowledge and Thought-knowledge: so too has arisen the dualism of Empiricism and Rationalism, which Kant sought to surmount by logical analysis. It is in the endeavour to supplement this analysis by a psychological genesis that the terms intersubjective and transsubjective prove useful. The problem for psychology is to ascertain the successive stages in the advance from the one form of experience or knowledge to the other. "When ten men look at the sun or the moon," said Reid, "they all see the same individual object." But according to Hamilton this statement is not "philosophically correct. . . the truth is that each of these persons sees a different object. . . It is not by perception but by a process of reasoning that we connect the objects of sense with existences beyond the sphere of immediate knowledge."² Now it is to this "beyond" that the term *transsubjective* is applied, and the question before us is: How do individual subjects thus get *beyond* the immanence or immediacy with which all experience begins? By a "process of reasoning," it is said. But it is at least true in fact, whether necessarily true or not, that such reasoning is the result of social intercourse. Further, it will be generally allowed that Kant's *Analytik*, before referred to, has made plain the insufficiency of merely formal reasoning to yield the categories of Substance, Cause and End, by which we pass from mere perceptual experience to that wider experience which transcends it. And psychology, again, may claim to have shown that in fact these categories are the result of that reflective self-consciousness to which social intercourse first gives rise.

But such intercourse, it has been urged, presupposes the common ground between subject and subject which it is meant to explain. How, it is asked, if every subject is confined to his own unique experience, does this intersubjective intercourse ever arise? If *no* progress towards intellectual synthesis were possible before intersubjective intercourse began, such intercourse, as presupposing something more than immediate sense-knowledge, obviously never could begin.³ Let us illustrate by an analogy which Leibnitz's association of experience with a "point of view" at once suggests. If it were possible for the terrestrial astronomer to obtain observations of the heavens from astronomers in the neighbouring stars, he would be able to map in three dimensions constellations which now he can only represent in two. But unless he had ascertained unaided the heliocentric parallax of these neighbouring stars, he would have no means of distinguishing them as near from the distant myriads besides, or of understanding the data he might receive; and unless he had first of all determined the still humbler geocentric parallax of our sun, those heliocentric parallaxes would have been unattainable. So in like manner we may say "intersubjective parallax" presupposes what we may call "subjective parallax," and even this the psychological duality of object and subject. But such subjective parallax or acquaintance with other like selves is the direct outcome of the extended range in time which memory proper secures; and when in this way self has become an object, resembling objects become other selves or "ejects," to adopt with slight modification a term originated by the late W. K. Clifford. We may be quite sure that his faithful dog is as little of a solipsist as the noble savage whom he accompanies. Indeed, the rudiments of the social factor are, if we may judge by biological evidence, to be found very early. Sexual union in the physiological sense occurs in all but the lowest *Metazoa*, pairing and courtship are frequent among insects, while "among the cold-blooded fishes the battle of the stickleback with his rivals, his captivating manœuvres to lead the female to the nest which he has built, his mad dance of passion around her, and his subsequent jealous guarding of the nest, have often been observed and admired."⁴ Among birds and mammals

² *Lectures on Metaphysics*, ii. 153.

³ And it is precisely for want of this mediation that Kant's "two stems of human knowledge, which *perhaps* may spring from a common but to us unknown root," leave epistemology still more or less hampered with the old dualism of sense and understanding.

⁴ *Evolution of Sex*, by Geddes and Thomson, 1st ed. p. 265.

we find not merely that these psychological aspects of sexual life are greatly extended, but we find also prolonged education of offspring by parents and imitation of the parents by offspring. Even language, or, at any rate "the linguistic impulse," is not wholly absent among brutes.¹ Thus as the sensori-motor adjustments of the organism to its environment generally advance in complexity and range, there is a concomitant advance in the variety and intimacy of its relations specially with individuals of its kind. It is therefore reasonable to assume no discontinuity between phases of experience that for the individual are merely objective and phases that are also ejective as well; and once the ejective level is attained, some interchange of experience is possible. So disappears the great gulf fixed betwixt subjective or individual and intersubjective or universal experience by rival systems in philosophy.

4. From this preliminary epistemological discussion we may pass on to the psychological analysis of experience itself. As to this, there is in the main substantial agreement; the elementary facts of mind cannot be expressed in less than three propositions—"I feel somehow," "I know something," "I do something." But here at once there arises an important question, viz. What after all are we to understand by the subject of these propositions? The proposition "I feel somehow" is not equivalent to "I know that I feel somehow." To identify the two would be to confound consciousness with self-consciousness. We are no more confined to our own immediate observations here than elsewhere; but the point is that, whether seeking to analyse one's own consciousness or to infer that of a lobster, whether discussing the association of ideas or the expression of emotions, there is always an individual self or "subject" in question. It is not enough to talk of feelings or volitions: what we mean is that some individual—man or worm—feels, strives, acts, thus or thus. Obvious as this may seem, it has been frequently either forgotten or gainsaid. It has been forgotten among details or through the assumption of a medley of faculties, each treated as an individual in turn, and among which the real individual was lost. Or it has been gainsaid, because to admit that all psychological facts pertain to an experiencing subject or experient seemed to imply that they pertained to a particular spiritual substance, which was simple, indestructible, and so forth; and it was manifestly desirable to exclude such assumptions from psychology as a science aiming only at a systematic exposition of what can be known and verified by observation. But, however, much assailed or

Subject or Ego.

disowned, the concept of a "mind" or conscious subject is to be found implicitly or explicitly in all psychological writers whatever—not more in Berkeley, who accepts it as a fact, than in Hume, who treats it as a fiction. This being so, we are far more likely to reach the truth eventually if we openly acknowledge this inexpugnable assumption, if such it prove, instead of resorting to all sorts of devious periphrases to hide it. Now wherever the word *Subject*, or its derivatives, occurs in psychology we might substitute the word *Ego* and analogous derivatives, did such exist. But *Subject* is almost always the preferable term; its impersonal form is an advantage, and it readily recalls its modern correlative *Object*. Moreover, *Ego* has two senses, distinguished by Kant as pure and empirical, the latter of which was, of course, an object, the *Me* known, while the former was subject always, the *I* knowing. By pure *Ego* or *Subject* it is proposed to denote here the simple fact that everything experienced is referred to a Self experiencing. This psychological concept of a self or subject, then, is after all by no means identical with the metaphysical concepts of a soul or mind-atom, or of mind-stuff not atomic; it may be kept as free from metaphysical implications as the concept of the biological individual or organism with which it is so intimately connected.

The attempt, indeed, has frequently been made to resolve the former into the latter, and so to find in mind only such an individuality as has an obvious counterpart in this individuality of the organism, i.e. what we may call an objective individuality. But such procedure owes all its plausibility to the fact that it leaves out of sight the difference between the biological and the psychological standpoints. All that the biologist means by a dog is "the sum of the phenomena

which make up its corporeal existence."² And, inasmuch as its presentation to any one in particular is a point of no importance, the fact of presentation at all may be very well dropped out of account. Let us now turn to psychology: Why should we not here follow Huxley and take "the word 'soul' simply as a name for the series of mental phenomena which make up an individual mind"?³ Surely the moment we try distinctly to understand this question we realize that the cases are different. "Series of mental phenomena" for whom? For any passer-by such as might take stock of our biological dog? No, obviously only for that individual mind itself; yet that is supposed to be made up of, to be nothing different from, the series of phenomena. Are we, then, (1) quoting J. S. Mill's words, "to accept the paradox that something which *ex hypothesi* is but a series of feelings, can be aware of itself as a series"?⁴ Or (2) shall we say that the several parts of the series are mutually phenomenal, such as A may look at B, who was just now looking at A? Or (3) finally, shall we say that a large part of the so-called series, in fact every term but one, is phenomenal for the rest—for that one?

As to the first, paradox is too mild a word for it; even contradiction will hardly suffice. It is as impossible to express "being aware of" by one term as it is to express an equation or any other relation by one term: what knows can no more be identical with what is known than a weight with what it weighs. If a series of feelings is what is known or presented, then what knows, what it is presented to, cannot be that series of feelings, and this without regard to the point Mill mentions, viz. that the infinitely greater part of the series is either past or future. The question is not in the first instance one of time or substance at all, but simply turns upon the fact that knowledge or consciousness is unmeaning except as it implies something knowing or conscious of something. But it may be replied: Granted that the formula for consciousness is something doing something, to put it generally; still, if the two somethings are the same when I touch myself or when I see myself, why may not agent and patient be the same when the action is knowing or being aware of; why may I not know myself—in fact, do I not know myself? Certainly not; agent and patient never are the same in the same act; such terms as self-caused, self-moved, self-known, *et id genus omne*, either connote the incomprehensible or are abbreviated expressions—as, e.g. touching oneself when one's right hand touches one's left.

And so we come to the alternative: As one hand washes the other, may not different members of the series of feelings be subject and object in turn? Compare, for example, the state of mind of a man succumbing to temptation (as he pictures himself enjoying the coveted good and impatiently repudiates scruples of conscience or dictates of prudence) with his state when, filled with remorse, he sides with conscience and condemns this "former self"—the "better self" having meanwhile become supreme. Here the cluster of presentations and their associated sentiments and motives, which together played the rôle of self in the first situation, have—only momentarily it may be true, but still have—for the time the place of not-self; and under abnormal circumstances this partial alternation may become complete alienation, as in what is called "double consciousness." Or again, the development of self-consciousness might be loosely described as taking the subject or self of one stage as an object in the next—self being, e.g. first identified with the body and afterwards distinguished from it. But all this, however true, is beside the mark; and it is really a very serious misnomer to speak, as e.g. Herbert Spencer does, of the development of self-consciousness as a "differentiation of subject and object." It is, if anything, a differentiation of object and object, i.e. in plainer words, it is a differentiation among presentations—a differentiation every step of which implies just that relation to a subject which it is supposed to supersede.

There still remains the alternative, expressed in the words of J. S. Mill, viz. "the alternative of believing that the Mind or Ego is something different from any series of feelings or possibilities of them." To admit this, of course, is to admit the necessity of distinguishing between Mind or Ego, meaning the unity or continuity of consciousness as a complex of presentations, and Mind or Ego as the subject to which this complex is presented. In dealing with the body from the ordinary biological standpoint no such necessity arises. But, whereas there the individual organism is spoken of unequivocally, in psychology, on the other hand, the individual mind may mean either (i.) the series of feelings or "mental phenomena" above referred to; or (ii.) the subject of these feelings for whom they are phenomena; or (iii.) the subject of these feelings or phenomena plus the series of feelings or phenomena themselves, the two being in that relation to each other in which alone the one is subject and the other a series of feelings, phenomena or objects. It is in this last sense that Mind is used in empirical psychology.⁵ Its exclusive use in the first sense is favoured only by those who shrink from the speculative associations connected with its exclusive use in the

² T. H. Huxley, *Hume*, "English Men of Letters Series," (1879), p. 171.

³ Huxley, *op. cit.* p. 172.

⁴ *Examination of Sir W. Hamilton's Philosophy*; ch. xii. fin.

⁵ A meaning better expressed, as said above, by experience.

¹ Cf. Darwin, *Descent of Man*, i. 56.

second. But psychology is not called upon to transcend the relation of subject to object or, as we may call it, the fact of presentation. On the other hand, as has been said, the attempt to ignore one term of the relation is hopeless; and equally hopeless, even futile, is the attempt, by means of phrases such as consciousness or the unity of consciousness, to dispense with the recognition of a conscious subject.

5. We might now proceed to inquire more closely into the character and relations of the three invariable constituents of psychological life which are broadly distinguished as **Feeling**, cognitions, feelings and conations. But we should be at once confronted by a doctrine which, strictly taken, amounts almost to a denial of this tripartite classification of the facts of mind—the doctrine, viz. that *feeling* alone is primordial and invariably present wherever there is consciousness at all. Every living creature, it is said, feels, though it may never do any more; only the higher animals, and these only after a time, learn to discriminate and identify and to act with a purpose. This doctrine, as might be expected, derives its plausibility partly from the vagueness of psychological terminology, and partly from the intimate connexion that undoubtedly exists between feeling and cognition on the one hand and feeling and volition on the other. As to the meaning of the term, it is plain that further definition is requisite for a word that may mean (a) a touch, as feeling of roughness; (b) an organic sensation, as feeling of hunger; (c) an emotion, as feeling of anger; (d) feeling proper, as pleasure or pain. But, even taking feeling in the last, its stricter sense, it has been maintained that all the more complex forms of consciousness are resolvable into, or at least have been developed from, feelings of pleasure and pain. The only proof of such position, since we cannot directly observe the beginnings of conscious life, must consist of considerations such as the following. So far as we can judge, we find feeling everywhere; but, as we work downwards from higher to lower forms of life, the possible variety and the definiteness of sense-impressions both steadily diminish. Moreover, we can directly observe in our own organic sensations, which seem to come nearest to the whole content of primitive or infantile experience, an almost entire absence of any assignable *qualc*. Finally, in our sense-experience generally, we find the element of feeling at a maximum in the lower senses and the cognitive element at a maximum in the higher. But the so-called intellectual senses are the most used, and use (we know) blunts feeling and favours intellection, as we see in chemists, who sort the most filthy mixtures by smell and taste without discomfort. If, then, feeling predominates more and more as we approach the beginning of conscious life, may we not conclude that it is its only essential constituent? On the contrary, such a conclusion would be rash in the extreme. Two lines, e.g. may get nearer and nearer and yet will never meet, if the rate of approach is simply proportional to the distance. A triangle may be diminished indefinitely, and yet we cannot infer that it becomes eventually all angles, though the angles get no less and the sides do. Before, then, we decide whether pleasure or pain alone can ever constitute a complete experience, it may be well to inquire into the connexion between feeling and cognition, on the one hand, and between feeling and conation on the other, so far as we can now observe. And this is an inquiry which will help us towards an answer to our main question, namely, that concerning the nature and connexions of what are commonly regarded as the three ultimate facts of mind..

Broadly speaking, in any state of mind that we can directly observe, what we find is (1) that we are aware of a certain change in our sensations, thoughts or circumstances, (2) that we are pleased or pained with the change, and (3) that we act accordingly. We never find that feeling directly alters—i.e. without the intervention of the action of which it prompts—either our sensations or situation, but that regularly these latter with remarkable promptness and certainty alter it. We have not *first* a change of feeling, and then a change in our sensations, perceptions and ideas; but, these changing, change of feeling *follows*. In short, feeling appears to be an effect, which therefore cannot exist without

its cause, though in different circumstances the same immediate cause may produce a different amount or even a different state of feeling. Turning from what we may call the receptive phase of an experience to the active or appetitive phase, we find in like manner that feeling is certainly not—in such cases as we can clearly observe—the whole of what we experience at any moment. True, in common speech we talk of liking pleasure and disliking pain; but this is either tautology, equivalent to saying we are pleased when we are pleased and pained when we are pained; or else it is an allowable abbreviation, and means that we like pleasurable *objects* and dislike painful *objects*, as when we say we like feeling warm and dislike feeling hungry. But feeling warm or feeling hungry, we must remember, is not pure feeling in the stricter sense of the word. Within the limits of our observation, then, we find that feeling accompanies some more or less definite presentation which for the sake of it becomes the object of appetite or aversion; in other words, feeling implies a relation to a pleasurable or painful presentation or situation, that, as cause of feeling or as end of the action to which feeling prompts, is doubly distinguished from it. Thus the very facts that lead us to distinguish feeling from cognition and conation make against the hypothesis that consciousness can ever be all feeling.

But, as already said, the plausibility of this hypothesis is in good part due to a laxity in the use of terms. Most psychologists before Kant, and some even to the present day, **Feeling and Sensation distinct**, speak of pleasure and pain as sensations. But it is plain that pleasure and pain are not simple ideas, as Locke called them, in the sense in which touches and tastes are—that is to say, they are never like these localized or projected, nor are they elaborated in conjunction with other sensations and movements into percepts or intuitions of the external. This confusion of feeling with sensations is largely consequent on the use of one word *pain* both for certain organic sensations and for the purely subjective state of being pained. But such pains not only are always more or less definitely localized—which of itself is so far cognition, they are also distinguished as shooting, burning, gnawing, &c., all which symptoms indicate a certain objective quality. Accordingly psychologists have been driven by one means or another to recognize two “aspects” (Bain), or “properties” (Wundt), in what they call a sensation, the one a “sensible or intellectual” or “qualitative,” the other an “affective” or “emotive,” aspect or property. The term “aspect” is figurative and obviously inaccurate; even to describe pleasure and pain as properties of sensation is a matter open to much question. But the point which at present concerns us is simply that when feeling is said to be the primordial element in consciousness more is usually included under feeling than pure pleasure and pain, viz. some characteristic or quality by which one pleasurable or painful sensation is distinguishable from another. No doubt, as we go downwards in the chain of life the qualitative or objective elements in the so-called sensations become less and less definite; and at the same time organisms with well-developed sense-organs give place to others without any clearly differentiated organs at all. But there is no ground for supposing even the amoeba itself to be affected in all respects the same whether by changes of temperature or of pressure or by changes in its internal fluids, albeit all of these changes will further or hinder its life and so presumably be in some sort pleasurable or painful. On the whole, then, there are grounds for saying that the endeavour to represent all the various facts of consciousness as evolved out of feeling is due to a hasty striving after simplicity, and has been favoured by the ambiguity of the term feeling itself. If by feeling we mean a certain subjective state varying continuously in intensity and passing from time to time from its positive phase (pleasure) to its negative phase (pain), then this purely pathic state implies an agreeing or disagreeing something which psychologically determines it. If, on the other hand, we let feeling stand for both this state and the cause of it, then, perhaps, a succession of such “feelings” may make up a consciousness; but then we are including two of our elementary facts under the name of one

of them. *The simplest form of psychical life, therefore, involves not only a subject feeling but a subject having qualitatively distinguishable presentations which are the occasion of its feeling.*

6. We may now try to ascertain what is meant by cognition as an essential element in this life, or, more exactly, what we are to understand by the term *presentation*. It was an important step onwards for psychology when Locke introduced that "new way of ideas" which Stillingfleet found alternately so amusing and so dangerous. By ideas Locke told him he meant "nothing but the immediate objects of our minds in thinking"; and it was so far a retrograde step when Hume restricted the term to certain only of these objects, or rather to these objects in a certain state, viz. as reproduced ideas or "images." And, indeed, the history of psychology seems to show that its most important advances have been made by those who have kept closely to this way of ideas; the establishment of the laws of association with their many fruitful applications and the whole Herbartian psychology may suffice as instances (see HERBART). The truth is that the use of such a term is itself a mark of an important generalization, one which helps to free us from the mythology and verbiage of the "faculty-psychologists." All the various mental facts spoken of as sensations, movements, percepts, images, intuitions, concepts, notions, have two characteristics in common: (1) they admit of being more or less attended to, and (2) they can be variously combined together and reproduced. It is here proposed to use the term *presentation* to denote them all, as being the best English equivalent for what Locke meant by idea and what Kant and Herbart called a *Vorstellung*.

A presentation has then a twofold relation—first, directly to the subject, and, secondly, to other presentations. The former relation answers to the fact that a presentation is attended to, that the subject is more or less conscious of it: it is "in his mind" or presented. As presented to a subject a presentation might with advantage be called an object, or perhaps a psychical object, to distinguish it from what are called objects apart from presentation, *i.e.* conceived as independent of any particular subject. Locke, as we have seen, did so call it; still, to avoid possible confusion, it may turn out best to dispense with the frequent use of object in this sense. But on one account, at least, it is desirable not to lose sight altogether of this, which is after all the stricter as well as the older signification of object, namely, because it enables us to express definitely, without implicating any ontological theory, what we have so far seen reason to think is the fundamental fact in experience. Instead of depending mainly on that vague and treacherous word "consciousness," or committing ourselves to the position that ideas are modifications of a certain mental substance or identical with the subject to whom they are presented, we may leave all this on one side, and say that ideas are objects, and the relation of objects to subjects—that whereby the one is object and the other subject—is presentation; and it is because only objects sustain this relation that they may be spoken of simply as presentations. On the side of the subject this relation implies what, for want of a better word, may be called *attention*, extending the denotation of this term so as to include even what we ordinarily call inattention. Attention so used will thus cover part of what is meant by consciousness—so much of it, that is, as answers to being mentally active, active enough at least to "receive impressions." Attention on the side of the subject implies intensity on the side of the object: we might indeed almost call intensity the *matter* of a presentation, without which it is a nonentity.¹

The inter-objective relations of presentations, on which their second characteristic, that of revivability and associability depends, though of the first importance in themselves, hardly call for examination in a general analysis like the present. But there is one point

¹ Cf. Kant's *Principle of the Anticipations of Perception*: "In all phenomena the real, which is the object of sensation, has intensive magnitude."

still more fundamental that we cannot wholly pass by: it is—in part at any rate—what is commonly termed the unity or continuity of consciousness. From the physical standpoint and in ordinary life we can talk of objects that are isolated and independent and in all respects distinct individuals. The screech of the owl, for example, has physically nothing to do with the brightness of the moon: either may come or go without changing the order of things to which the other belongs. But psychologically, for the individual percipient, they are parts of one whole; the more his attention is given to the one the more it is taken from the other. Also the actual recurrence of the one will afterwards entail the re-presentation of the other also. Not only are they still parts of one whole, but such distinctness as they have at present is the result of a gradual differentiation.

It is quite impossible for us now to imagine the effects of years of experience removed, or to picture the character of our infantile presentations before our interests had led us habitually to concentrate attention on some and to ignore others. In place of the many things which we can now see and hear, not merely would there then be a confused presentation of the whole field of vision and of a mass of undistinguished sounds, but even the difference between sights and sounds themselves would be without its present distinctness. Thus the further we go back the nearer we approach to a total presentation having the character of one general *continuum* in which differences are latent. There is, then, in psychology, as in biology, what may be called a principle of "progressive differentiation or specialization";² and this, as well as the facts of reproduction and association, forcibly suggests the conception of a certain objective continuum forming the background or basis to the several relatively distinct presentations that are elaborated out of it—the equivalent, in fact, of that unity and continuity of consciousness which has been supposed to supersede the need for a conscious subject.

There is one class of objects of special interest even in a general survey, viz. movements or motor presentations. These, like sensory presentations, admit of association and reproduction, and seem to attain to such distinctness as they possess in adult human experience by a gradual differentiation out of an original diffused mobility which is little besides emotional expression. Of this, however, more presently. It is primarily to such dependence upon feeling that movements owe their distinctive character, the possession, that is, under normal circumstances, of definite and assignable psychical antecedents, in contrast to sensory presentations, which are devoid of them. We cannot psychologically explain the order in which particular sights and sounds occur; but the movements that follow them, on the other hand, can be adequately explained only by psychology. The twilight that sends the hens to roost sets the fox to prowl, and the lion's roar which gathers the jackals scatters the sheep. Such diversity in the movements, although the sensory presentations are similar, is due, in fact, to what we might call the principle of "subjective or hedonic selection"—that, out of all the manifold changes of sensory presentation which a given individual experiences, only a few are the occasion of such decided feeling as to become objects of possible appetite or aversion. It is this by means of movements that we are more than the creatures of circumstances and that we can with propriety talk of subjective selection. The representation of what interests us comes then to be associated with the representation of such movements as will secure its realization, so that—although no concentration of attention will secure the requisite intensity to a pleasurable object present only in idea—we can by what is strangely like a concentration of attention convert the idea of a movement into the fact, and by means of the movement attain the coveted reality.

² The biological principle referred to is that known as von Baer's law, viz. "that the progress of development is from the general to the special."

7. And this has brought us round naturally to the third of the commonly accepted constituents of experience. What is *conation*, or rather *conative action*? For there are two questions often more or less confused, the question of *Conation*. motive or spring of action, as it is sometimes called—why is there action at all? and the question of means—how do definite actions come about? The former question relates primarily to the connexion of conation and feeling. It is only the latter question that we now raise. In ordinary voluntary movement we have first of all an idea or re-presentation of the movement, and last of all the actual movement itself—a new presentation which may for the present be described as the filling out of the re-presentation, which thereby attains that intensity, distinctness and embodiment we call reality. How does this change come about? The attempt has often been made to explain it by a reference to the more uniform, and apparently simpler, case of reflex action, including under this term what are called sensori-motor and ideo-motor actions. In all these the movement seems to be the result of a mere transference of intensity from the associated sensation or idea that sets on the movement. But when by some chance or mischance the same sensory presentation excites two or more nascent motor changes that conflict, a temporary block is said to occur; and, when at length one of these nascent motor changes finally prevails, then, it is said, “there is constituted a state of consciousness which displays what we term volition.”¹ But this assumption that sensory and motor ideas are associated before volition, and that volition begins where automatic or reflex action ends, is due to that inveterate habit of confounding the psychical and the physical which is the bane of modern psychology. How did these particular sensory and motor presentations ever come to be associated? The only psychological evidence we have of any very intimate connexion between sensory and motor representations is that furnished by our acquired dexterities, *i.e.* by such movement as Hartley² styled “secondarily automatic.” But then all these have been preceded by volition: as Herbert Spencer says, “the child learning to walk wills each movement before making it.” Surely, then, a psychologist should take this as his typical case and prefer to assume that all automatic actions that come within his ken at all are in this sense secondarily automatic, *i.e.* to say that either in the experience of the individual or of his ancestors, volition or something analogous to it, preceded habit.

But, if we are thus compelled by a sound method to regard sensori-motor actions as degraded or mechanical forms of voluntary actions, instead of regarding voluntary actions as gradually differentiated out of something physical, we have not to ask: What happens when one of two alternative movements is executed? but the more general question: What happens when any movement is made in consequence of feeling? It is obvious that on this view the simplest *definitely purposive* movement must have been preceded by some movement simpler still. For any distinct movement purposely made presupposes the ideal presentation, before the actual realization, of the movement. But such ideal presentation, being a re-presentation, equally presupposes a previous actual movement of which it is the so-called mental residuum. There is then, it would seem, but one way left, *viz.* to regard those movements which are immediately expressive of pleasure or pain as primordial, and to regard the so-called voluntary movements as elaborated out of these. The vague and diffusive character of these primitive emotional manifestations is really a point in favour of this position. For such “diffusion” is evidence of an underlying continuity of motor presentations parallel to that already discussed in connexion with sensory presentations, a continuity which, in each case, becomes differentiated in the course of experience into comparatively distinct and discrete movements and sensations respectively.³

But whereas we can only infer, and that in a very roundabout fashion, that our sensations are not absolutely distinct but are parts of one massive sensation, as it were, we are still liable under the influence of strong emotion directly to experience the corresponding continuity in the case of movement. Such motor-continuum we may suppose is the psychical counterpart of that permanent readiness to act, or rather that continual nascent acting, which among the older physiologists was spoken of as “tonic action.” This “skeletal tone,” as it is now called, is found to disappear more or less completely from a limb when its sensory nerves are divided. “In the absence of the usual stream of afferent impulses passing into it, the spinal cord ceases to send forth the influences which maintain the tone.”⁴ And a like intimate dependence, we have every reason to believe, obtains throughout between sensation and movement. We cannot imagine the beginning of life but only life begun. The simplest picture, then, which we can form of a concrete state of mind is not one in which there are movements before there are any sensations or sensations before there are any movements, but one in which change of sensation is followed by change of movement, the link between the two being a change of feeling.

Having thus simplified the question, we may now ask again: How is this change of movement through feeling brought about? The answer, as already hinted, appears to be: *Dependence of Action of Feeling*. By a change of attention. We learn from such observations as psychologists describe under the head of fascination, imitation, hypnotism, &c., that the mere concentration of attention upon a movement is often enough to bring the movement to pass. But, of course, in such cases neither emotion nor volition is necessarily implied; but none the less they show the close connexion that exists between attention and movement. Everybody, too, must often have observed how the execution of any but mechanical movements arrests attention to thoughts or sensations, and how, vice versa, a striking impression or thought interrupts him in the performance of skilled movements. Let us suppose, then, that we have at any given moment a certain distribution of attention between sensory and motor presentations; a change in that distribution then will mean a change in the intensity of some of all of these. But, in the case of motor presentations, change of intensity means change of movement. Such changes are, however, quite minimal in amount so long as the given presentations are not conspicuously agreeable or disagreeable. So soon as they are, however, there is evidence of a most intimate connexion between feeling and attention; but it is hardly possible adequately to exhibit this evidence without first attempting to ascertain the characteristics of the presentations, or groups of presentations, that are respectively pleasurable and painful, and this must occupy us later on.

8. We are now at the end of our analysis, and the results may perhaps be most conveniently summarized by first throwing them into a tabular form and then appending a *Primordial Facts of Mind*. few remarks by way of indicating the main purport of the table. Taking no account of the specific difference between one concrete state of mind and another, and supposing that we are dealing with presentations

but only to reject it in favour of his own peculiar doctrine of “spontaneity,” which, however, is open to the objection that it makes movement precede feeling instead of following it—an objection that would be serious even if the arguments advanced to support his hypothesis were as cogent as only Bain supposed them to be. Against the position maintained above he objects that “the emotional wave almost invariably affects a whole group of movements,” and therefore does not furnish the “isolated promptings that are desiderated in the case of the will” (*Mental and Moral Science*, p. 323). But to make this objection is to let heredity count for nothing. In fact, wherever a variety of isolated movements is physically possible there also we always find corresponding instincts, “that untaught ability to perform actions,” to use Bain’s own language, which a minimum of practice suffices to perfect. But then these suggest gradual ancestral acquisition.

⁴ Foster, *Text-Book of Physiology*, § 597.

¹ Compare Spencer’s *Principles of Psychology*, i. §§ 217, 8.

² D. Hartley, *Observations on Man* (6th ed., 1834), pp. 66 sqq.

³ It may be well to call to mind here that Alexander Bain also regarded emotional expression as a possible commencement of action,

in their simplest form, *i.e.* as sensations and movements, we have:—

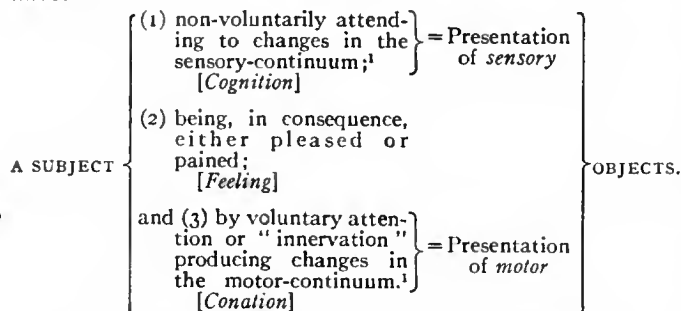

Of the three phases or functions, thus analytically distinguishable, but not really separable, the first and the third correspond in the main with the *receptive* and *active* states or powers of the older psychologists. The second, being more difficult to isolate, was long overlooked; or, at all events, its essential characteristics were not distinctly marked, so that it was confounded either with (1) which is its cause, or with (3), its effect. But perhaps the most important of all psychological distinctions is that which traverses both the old bipartite and the prevailing tripartite analysis, *viz.* that between the subject on the one hand, as acting and feeling, and the objects of this activity on the other. With this distinction clearly before us, instead of crediting the subject with an indefinite number of faculties or capacities, we must seek to explain not only reproduction, association, &c., but all varieties of thinking and acting, by the laws pertaining to ideas or presentations, leaving to the subject only the one power of variously distributing that attention upon which the intensity of a presentation in part depends. What we call activity in the narrower sense (as *e.g.* purposive movement and intellection) is but a special form of this single subjective activity, although a very important one.

According to this view, then, *presentations, attention, feeling*, are not to be regarded as three co-ordinate genera, each of which is a complete "state of mind or consciousness," *i.e.* as being all alike included under this one supreme category. There is, as Berkeley long ago urged, no resemblance between activity and an idea; nor is it easy to see anything common to pure feeling and an idea, unless it be that both possess intensity. Classification seems, in fact, to be here out of place. Instead, therefore, of the one *summum genus*, state of mind or consciousness, with its three co-ordinate subdivisions—cognition, emotion, conation—our analysis seems to lead us to recognize three distinct and irreducible components—attention, feeling, and objects or presentations—as together, in a certain connexion, constituting one concrete state of mind or *psychosis*. Of such concrete states of mind or *psychoses* we may then say—so far agreeing with the older, bipartite psychology—that there are two forms, corresponding to the two ways in which attention may be determined and the two classes of objects attended to in each, *viz.* (1) the *senory* or *receptive* attitude, when attention is non-voluntarily determined, *i.e.* where feeling follows the act of attention; and (2) the *motor* or *active* attitude, where feeling precedes the act of attention, which is thus determined voluntarily.

Attention.

9. Instead of a congeries of faculties we have assumed a single subjective activity and have proposed to call this *attention*. Some further explication of this position seems to be desirable. We start with the duality of subject and object as fundamental. We say of man, mouse, or monkey that it feels, perceives, remembers, infers, strives, and so forth. Leaving aside the first term, it is obvious that all the rest imply both an activity and an object. Is it possible to resolve these instances into a form in which the assumed diversity of the act will appear as a diversity of the object? At first sight it looks rather as if the kind

¹ To cover more complex cases we might here add the words "or trains of ideas."

of activity might vary while the object remained the same; that *e.g.* we perceived an object and later on remembered or desired it. It would then be most natural to refer these several activities to corresponding faculties of perception, memory and desire. This, indeed, is the view embodied in common speech, and for practical purposes it is doubtless the simplest and the best. Nevertheless, a more thorough analysis shows that when the supposed faculty is different the object is never entirely and in all respects the same. Thus in perception, *e.g.* we deal with "impressions" or primary presentations, and in memory and imagination with "ideas" (in the later sense) or secondary presentations. In desire the *want* of the object gives it an entirely different setting, adding a new characteristic, that of *value* or *worth*, so that its acquisition becomes the *end* of a series of efforts or movements. The older psychology, by its acceptance of the Cartesian doctrine that all the facts of immediate experience are to be interpreted as subjective modifications, failed to distinguish adequately between the subject as active and the objects of its activity. Hence the tendency to rest content with the popular distinction of various faculties in spite of the underlying sameness implied in the common application of "conscious" to them all. In fact, Locke's definition of idea (in the older and wider sense) as the immediate object of consciousness or thinking was censured by Reid as "the greatest blemish in the *Essay on Human Understanding*." But, accepting this definition as implied in the duality of subject and object, and accepting too the underlying sameness which the active form "conscious" undeniably implies, we have simply to ask: "Which is the better term to denote this common element—consciousness or attention?"

Consciousness, as the vaguest, most protean and most treacherous of psychological terms, will hardly serve our purpose. Attention, on the other hand, has an invariable active sense, and there is an appropriate verb, to attend. But many things, it may be said, are presented while few are attended to; if attention is to be made coextensive with the activity implied in consciousness, will not the vital distinction between attention and inattention be lost? In fact, however, this distinction implies a covert comparison, not an absolute contrast. In everyday life we recognize many degrees of attention, ranging from an extreme of intense concentration to one of complete remission, as Locke long ago pointed out.² Between these extremes there is perfect continuity, and not a difference of kind; to apply the one term attention to the whole range is very like applying the one term magnitude to large and small quantities alike.

But it is not enough to show that when we commonly talk of different faculties we also find psychological differences of object, and to assert that if there is one common factor in all psychical activity this factor is attention. To make our position secure it is needful to show directly that all the various faculties with which a subject can be credited are resolvable into attention and various classes or relations or states of presentations that are attended to. How far this is possible remains to be seen as we proceed. In the case of the so-called "intellectual powers" the position is generally conceded, but so far as the voluntary or active powers are concerned it is as generally denied. Now, in so far as volition implies not merely action, overt or intended, but also motives, in so far also it must be acknowledged it contains a factor *not* resolvable into attention to motor presentations. This further factor, which has been called "the volitional character of feeling," we here leave aside. Apart from this direct spring of action, then, the question is whether the active process itself differs from the cognitive or receptive process

² "That there are ideas, some or other, always present in the mind of a waking man, every one's experience convinces him; though the mind employs itself about them with several degrees of attention. Sometimes the mind fixes itself with such intention . . . that it shuts out all other thoughts and takes no notice of the ordinary impressions made on the senses; . . . at other times it barely observes the train of ideas . . . without directing and pursuing any of them; and at other times it lets them pass almost quite unregarded as faint shadows that make no impression" (*Essay*, ii. 19, §§ 3, 4).

save in being attention to a special class of objects. First of all, it is noteworthy that both have the same characteristics. Thus, what Hamilton called "the law of limitation" holds of each alike and of either with respect to the other; and it holds too not only of the number of presentations but also of the intensity. We can be absorbed in action just as much as in perception or thought; also, as already said, movements, unless they are mechanical, inhibit ideas; and vice versa, ideas, other than associated trains, arrest movements. Intoxication, hypnotism or insanity, rest or exhaustion, tell on apperception as well as on innervation. The control of thoughts, equally with the control of movements, requires effort; and as there is a strain peculiar to intently listening or gazing, which is known to have a muscular concomitant, so too there is a strain characteristic of recollection and visualization, which may quite well turn out to be muscular too. When movements have to be associated, the same continuous attention is called for as is found requisite in associating sensory impressions; and, when such associations have become very intimate, dissociation is about equally difficult in both cases.

There is one striking fact that brings to light the essential sameness of apperception and innervation, cited by Wundt for this very purpose. In so-called "reaction-time" experiments it is found, when the impression to be registered follows on a premonitory signal after a certain brief interval, that then the reaction (registering the impression) is often instantaneous; the reaction-time, in other words, is nil. In such a case the subject is aware not of three separate events, (1) the perception of the impression; (2) the reaction; (3) the perception of this; but the fact of the impression is realized and the registering movement is actualized at once and together; the subject is conscious of one act of attention and one only.

Theory of Presentations.

10. We come now to the exposition of the objects of attention or consciousness, *i.e.* to what we may call the objective or presentational factor of psychical life. The treatment of this will fall naturally into two divisions. In the first we shall have to deal with its general characteristics and with the fundamental processes which all presentation involves. In view of its general and more or less hypothetical character we may call it the theory of presentation. We can then pass on to the special forms of presentations, known as sensations, percepts, images, &c., and to the special processes to which these forms lead up.

This exposition will be simplified if we start with a supposition that will enable us to leave aside, at least for the present, the difficult question of heredity. We know that in

Assumption of a Psychological Individual.

the course of each individual's life there is more or less of progressive differentiation or development. Further, it is believed that there has existed a series of sentient individuals beginning with the lowest form of life and advancing continuously up to man. Some traces of the advance already made may be reproduced in the growth of each human being now, but for the most part such traces have been obliterated. What was experience in the past has become instinct in the present. The descendant has no consciousness of his ancestor's failures when performing by "an untaught ability" what they slowly and perhaps painfully acquired. But, if we are to attempt to follow the genesis of mind from its earliest dawn, it is the primary experience rather than the eventual instinct that we have first of all to keep in view. To this end, then, it is proposed to assume that we are dealing with one individual who has continuously advanced from the beginning of psychical life, and not with a series of individuals of whom all save the first inherited certain capacities from their progenitors. The life-history of such an imaginary individual, that is to say, would correspond with all that was new in the experience of a certain typical series of individuals each of whom advanced a certain stage in mental differentiation. On the other hand, from this history would be omitted that inherited reproduction of the net results, so to say, of ancestral experience, that innate tradition by which alone, under the actual conditions

of existence, progress is possible. The process of thus reproducing the old might differ as widely from that of producing the new as electrotyping does from engraving. However, the point is that as psychologists we know nothing directly about it; neither can we distinguish precisely at any link in the chain of life what is old and inherited—original in the sense of Locke and Leibnitz—from what is new or acquired—original in the modern sense. But we are bound as a matter of method to suppose all complexity and differentiation among presentations to have been originated, *i.e.* experimentally acquired, at some time or other. So long, then, as we are concerned primarily with the progress of this differentiation we may disregard the fact that it has not actually been, as it were, the product of one hand dealing with one *tabula rasa* to use Locke's—originally Aristotle's—figure, but of many hands, each of which, starting with a reproduction of what had been wrought on the preceding *tabulae*, put in more or fewer new touches before devising the whole to a successor who would proceed in like manner.

11. What is implied in this process of differentiation and what is it that becomes differentiated?—these are the questions to which we must now attend. Psychologists have usually represented mental advance as consisting fundamentally in the combination and recombination of various elementary units, the so-called sensations and primitive movements: in other words, as consisting in a species of "mental chemistry." If we are to resort to physical analogies at all—a matter of very doubtful propriety—we shall find in the growth of a seed or an embryo far better illustrations of the unfolding of the contents of consciousness than in the building up of molecules: the process seems much more a segmentation of what is originally continuous than an aggregation of elements at first independent and distinct. Comparing higher minds or stages of mental development with lower—by what means such comparison is possible we need not now consider—we find in the higher conspicuous differences between presentations which in the lower are indistinguishable or absent altogether. The worm is aware only of the difference between light and dark. The steel-worker sees half a dozen tints where others see only a uniform glow. To the child, it is said, all faces are alike; and throughout life we are apt to note the general, the points of resemblance, before the special, the points of difference. But even when most definite, what we call a presentation is still part of a larger whole. It is not separated from other presentations, whether simultaneous or successive, by something which is not of the nature of presentation, as one island is separated from another by the intervening sea, or one note in a melody from the next by an interval of silence. In our search for a theory of presentations, then, it is from this "continuity of consciousness" that we must take our start. Working backwards from this as we find it now, we are led alike by particular facts and general considerations to the conception of a *totum objectivum* or objective continuum which is gradually differentiated, thereby giving rise to what we call distinct presentations, just as some particular presentation, clear as a whole, as Leibnitz would say, becomes with mental growth a complex of distinguishable parts. Of the very beginning of this continuum we can say nothing; absolute beginnings are beyond the pale of science. Experience advances as this continuum is differentiated, every differentiation being a change of presentation. Hence the commonplace of psychologists—We are only conscious as we are conscious of change.

But "change of consciousness" is too loose an expression to take the place of the unwieldy phrase differentiation of a presentation-continuum, to which we have been driven. For not only does the term "consciousness" confuse what exactness requires us to keep distinct, an activity and its object, but also the term "change" fails to express the characteristics which distinguish new presentations from other changes. Differentiation implies that the simple becomes complex or the complex more complex; it implies also that this increased complexity is due to the persistence of former changes; we may even say such persistence is

The Presentation-Continuum.

Gradual Differentiation of Presentation-Continuum.

essential to the very idea of development or growth. In trying, then, to conceive our psychological individual in the earliest stages of development we must not picture him as experiencing a succession of absolutely new sensations, which, coming out of nothingness, admit of being strung upon the "thread of consciousness" like beads picked up at random, or cemented into a mass like the bits of stick and sand with which the young caddis covers its nakedness. The notion, which Kant has done much to encourage, that psychical life begins with a confused manifold of sensations—devoid not only of logical but even of psychological unity—is one that becomes more inconceivable the more closely we consider it. An absolutely new presentation, having no sort of connexion with former presentations till the subject has synthesized it with them, is a conception for which it would be hard to find a warrant either by direct observation, by inference from biology, or in considerations of an a priori kind. At any given moment we have a certain whole of presentations, a "field of consciousness," psychologically one and continuous; at the next we have not an entirely new field but a partial change within this field. Many who would allow this in the case of representations, *i.e.* where idea succeeds idea by the workings of association, would demur to it in the case of primary presentations or sensations. "For," they would say, "may not silence be broken by a clap of thunder, and have not the blind been made to see?" To urge such objections is to miss the drift of our discussion, and to answer them may serve to make it clearer. Where silence can be broken there are representations of preceding sounds and in all probability even subjective presentations of sound as well; silence as experienced by one who has heard is very different from the silence of Condillac's statue before it had ever heard. The question is rather whether such a conception as that of Condillac's is possible; supposing a sound to be, qualitatively, entirely distinct from a smell, could a field of consciousness consisting of smells be followed at once by one in which sounds had part? And, as regards the blind coming to see, we must remember not only that the blind have eyes but that they are descended from ancestors who could see. What nascent presentations of sight are thus involved it would be hard to say; and the problem of heredity is one that we have for the present left aside.

The view here taken is (1) that at its first appearance in psychical life a new sensation or so-called elementary presentation is really a partial modification of some pre-existing presentation which thereby becomes as a whole more complex than it was before; and (2) that this complexity and differentiation of parts never become a plurality of discontinuous presentations, having a distinctness and individuality such as the atoms or elementary particles of the physical world are supposed to have. Beginners in psychology, and some who are not beginners, are apt to be led astray by expositions which set out from the sensations of the special senses, as if these furnished us with the type of an elementary presentation. The fact is we never experience a mere sensation of colour, sound, touch, and the like; and what the young student mistakes for such is really a perception, a sensory presentation combined with various sensory and motor presentations and with representations—and having thus a definiteness and completeness only possible to complex presentations. Moreover, if we could attend to a pure sensation of sound or colour by itself, there is much to justify the suspicion that even this is complex and not simple, and owes to such complexity its clearly marked specific quality. In certain of our vaguest and most diffused organic sensations there is probably a much nearer approach to the character of the really primitive presentations.

In such sensations we can distinguish three variations, *viz.* variations of quality, of intensity, and of what Bain called *Diffusion* massiveness, or, as we shall say, extensity. This *Diffusion* and last characteristic, which everybody knows who *Restriction* knows the difference between the ache of a big bruise and the ache of a little one, between total and partial immersion in a bath, is, as we shall see later on, an essential element in our perception of space. But it is certainly

not the whole of it, for in this experience of massive sensation alone it is impossible to find other elements which an analysis of spatial intuition unmistakably yields. Extensity and extension, then, are not to be confounded. Now, we find, even at our level of mental evolution, that an increase in the intensity of a sensation is apt to entail an increase in its extensity too. In like manner we observe a greater extent of movement in emotional expression when the intensity of the emotion increases. Even the higher region of imagination is no exception, as is shown by the whirl and confusion of ideas incident to delirium, and, indeed, to all strong excitement. But this "diffusion" or "radiation," as it has been called, diminishes as we pass from the class of organic sensations to the sensations of the five senses, from movements expressive of feeling to movements definitely purposive, and from the tumult of ideas excited by passion to the steadier sequences determined by efforts to think. Increased differentiation seems, then, to be intimately connected with increased "restriction." Probably there may be found certain initial differentiations which for psychology are ultimate facts that it cannot explain. As already said, the very beginning of experience is beyond us, though it is our business—*working from within*—to push back our analysis as far as we can. But some differentiations being given, then it may be safely said that, in accordance with what we have called the principle of subjective selection (see § 6), attention would be voluntarily concentrated upon certain of these and upon the voluntary movements specially connected with them. To such subjectively initiated modifications of the presentation-continuum, moreover, we may reasonably suppose "restriction" to be in large measure due. But increased restriction would render further differentiation of the given whole of presentation possible, and so the two processes might supplement each other. These processes have now proceeded so far that at the level of human consciousness we find it hard to form any tolerably clear conception of a field of consciousness in which an intense sensation, no matter what, might—so to say—diffuse over the whole. Colours, *e.g.* are with us so distinct from sounds that—except as regards the excitement of attention or the drain upon it—there is nothing in the intensest colour to affect the simultaneous presentation of a sound. But at the beginning whatever we regard as the earliest differentiation of sound might have been inco-presentable with the earliest differentiation of colour, if sufficiently diffused, much as a field of sight all blue is now inco-presentable with one all red. Or, if the stimuli appropriate to both were active together, the resulting sensation might have been not a blending of two qualities, as purple is said to be a blending of red and violet, but rather a neutral sensation without the specific qualities of either. Now, on the other hand, colours and sounds are necessarily so far localized that we are directly aware that the eye is concerned with the one and the ear with the other. This brings to our notice a fact so ridiculously obvious *Inco-presentability* that it has never been deemed worthy of mention, although it has undeniably important bearings—the fact, *viz.* that certain sensations or movements are an absolute bar to the simultaneous presentation of other sensations or movements. We cannot see an orange as at once yellow and green, though we can feel it at once as both smooth and cool; we cannot open and close the same hand at the same moment, but we can open one hand while closing the other. Such inco-presentability or contrariety is thus more than mere difference, and occurs only between presentations belonging to the same sense or to the same group of movements. Strictly speaking, it does not always occur even then; for red and yellow, hot and cold, are presentable together provided they have certain other differences which we shall meet again presently as differences of "local sign."

12. In the preceding paragraphs we have had occasion to distinguish between the presentation-continuum or whole field of consciousness, as we may for the present call it, and those several differentiations within this field *Retentiveness* which are ordinarily spoken of as presentations, and to which—now that their true character as parts is clear—

we too may confine the term. But it will be well in the next place, before inquiring more closely into their characteristics, to consider for a moment that persistence of preceding modifications which the principle of progressive differentiation implies. This persistence is best spoken of as retentiveness. It is often confused with memory, though this is something much more complex and special; for in memory there is necessarily some contrast of past and present, whereas here there is simply the persistence of the old. But what is it that persists? On our theory we must answer, the continuum as differentiated, not the particular differentiation as an isolated unit. If psychologists have erred in regarding the presentations of one moment as merely a plurality of units, they have erred in like manner concerning the so-called residua of such presentations. As we see a certain colour or a certain object again and again, we do not go on accumulating images or representations of it, which are somewhere crowded together like shades on the banks of the Styx; nor is such colour, or whatever it be, the same at the hundredth time of presentation as at the first, as the hundredth impression of a seal on wax would be. There is no such lifeless fixity in mind. The explanations of perception most in vogue are far too mechanical and, so to say, atomistic; but we must fall back upon the unity and continuity of our presentation-continuum if we are to get a better. Suppose that in the course of a few minutes we take half a dozen glances at a strange and curious flower. We have not as many complex presentations which we might symbolize as F_1, F_2, \dots, F_6 . But rather, at first only the general outline is noted, next the disposition of petals, stamens, &c., then the attachment of the anthers, position of the ovary, and so on; that is to say, symbolizing the whole flower as $[p'(ab) s' (cd) o' (fg)]$, we first apprehend say $[p' \dots s' \dots o']$, then $[p' (ab) s' \dots o']$, or $[p' (a..) s' (c..) o' (f..)]$, and so forth. It is because the traits first attended to persist that the later form an addition to them till the complex is at length complete. There is nothing in this instance properly answering to what are known as the reproduction and association of ideas; in the last and complete apprehension as much as in the first vague and inchoate one the flower is there as a primary presentation. There is a limit, of course, to such a procedure, but the instance taken, we may safely say, is not such as to exceed the bounds of a simultaneous field of consciousness. Assuming then that such increase of differentiation through the persistence of preceding differentiations holds of the presentation-continuum as a whole, we conclude that, in those circumstances in which we now have a specific sensation of, say, red or sweet, there would be for some more primitive experience nothing but a vague, almost organic, sensation, which, however, would persist, so that on a repetition of the circumstances it could be again further differentiated. The earlier differentiations, in short, do not disappear like the waves of yesterday in the calm of today, nor yet last on like old scars beside new ones; but rather the two are blended and combined, so that the whole field of consciousness, like a continually growing picture, increases indefinitely in complexity of pattern.

13. *Assimilation*.—This process, in which later differentiations blend with and thereby further restrict and specialize what is retained of earlier and less definite presentations, is thus a further implication of the principle of the progressive development of the presentational continuum. When not ignored altogether this further process has been commonly regarded as merely a simple form of "association," its peculiarity being, as it was supposed, that the presentations associated—though numerically distinct—were in quality perfectly identical. In point of fact, both these assumptions seem to be erroneous and due to the so-called psychologist's fallacy.¹ For the experiencing subject there is apparently at this stage—as we have already urged—neither the numerical distinctness nor the qualitative identity which the words "past impression (A_1)" and "present impression (A_2)" suggest. Still the connexion between this process of mere blending or fusion, which we shall call *assimilation*, and the process of association proper is so close, and the detailed analysis called for so complex, that we must needs defer further discussion till we come to treat of association as a whole (cf. below, § 24). It may then be possible to show that we have here to do with a process

¹ As, e.g. in interpreting the conduct of children as if they were already "grown-up" persons; cf. J. Ward, *Il. of Spec. Phily.* (1882), pp. 369 *fin.* 374; James, *Prin. of Psychy.* (1890), i. 196.

much simpler and more fundamental than association. But it is at least clear at once that if the term *association* is to be correctly used it will imply that the presentations associated are from the first distinct, are attended to as distinct, are associated solely in consequence of such attention, and remain to the last distinguishable.

In view of the intimate connexion between differentiation, retentiveness and assimilation it will sometimes be convenient to refer to all three together as constituting what we may call the *plasticity* of the presentational continuum.

14. This will be the most convenient place to take note of certain psychological doctrines which, though differing in some material respects, are usually included *Relativity* under the term Law of Relativity.

a. Hobbes's *Sentire semper idem et non sentire ad idem recidunt* is often cited as one of the first formulations of this law; and if we take it to apply to the whole field of consciousness it becomes at once true and trite: a field of consciousness unaltered either by change of impression or of idea would certainly be a blank and a contradiction. Understood in this sense the Law of Relativity amounts to what Hamilton called the Law of Variety: "that we are conscious only as we are conscious of difference."² But, though consciousness involves change, it is still possible that particular presentations in the field of consciousness may continue unchanged indefinitely. When it is said that "a constant impression is the same as a blank," what is meant turns out to be something not psychological at all, as, e.g., our insensibility to the motion of the earth or to the pressure of the air—cases in which there is obviously no presentation, nor even any evidence of nervous change. Or else this paradox proves to be but an awkward way of expressing what we may call accommodation, whether physiological or psychological. Thus the skin soon adapts itself to certain seasonal alterations of temperature, so that heat or cold ceases to be felt: the sensation ceases because the nervous change, its proximate physical counterpart, has ceased. Again, there is what James Mill calls "an acquired incapacity of attention," such that a constant noise, for example, in which we have no interest, is soon inaudible. In such a case of psychological accommodation we should expect also to find on the physiological side some form of central reflection or isolation more or less complete. As a rule, no doubt, impressions do not continue constant for more than a very short time; still there are sad instances enough in the history of disease, bodily and mental, to show that such a thing can quite well happen, and that such constant impressions (and "fixed ideas," which are in effect tantamount to them), instead of becoming blanks, may dominate the entire consciousness, colouring or bewildering everything.

b. From the fact that the field of consciousness is continually changing it has been supposed to follow, not only that a constant presentation is impossible, but—as a further consequence—that every presentation is essentially nothing but a transition or difference. "All feeling," says Bain, the leading exponent of this view, "is two-sided. . . . We may attend more to one member of the couple than to the other. . . . We are more conscious of heat when passing to a higher temperature, and of cold when passing to a lower. The state we have passed to is our *explicit* consciousness, the state we have passed from is our *implicit* consciousness." But the transition need not be from heat to cold, or vice versa: it can equally well take place from a neutral state, which is indeed the normal state, of neither heat nor cold; a new-born mammal, e.g. must experience cold, having never experienced heat. Again, suppose a sailor becalmed gazing for a whole morning upon a stretch of sea and sky, what sensations are implicit here? Shall we say yellow as the greatest contrast to blue, or darkness as the contrary of light, or both? What, again, is the implicit consciousness when the explicit is sweet; is it bitter or sour, and from what is the transition in such a case? For one thing it seems clear that the transition of attention from one presentation to another and the differences between the presentations themselves are distinct facts. It is strange that the psychologist who has laid such stress on neutral states of surprise

² *The Works of Thos. Reid*, supplementary note, p. 932.

as being akin to feeling and so distinct from special presentations, should in any way confound the two. The mistake is perhaps accounted for by the fact that Bain, in common with the rest of his school, nowhere distinguishes between attention and the presentations that are attended to. If "change of impression" and being conscious or mentally alive are the same thing, it is then manifestly tautologous to say that one is the indispensable condition of the other. If they are not the same thing, then the succession of shocks or surprises cannot wholly determine the impressions which successively determine them.

But we have still to consider whether the impressions themselves are nothing but differences or contrasts. "We do not know any one thing of itself but only the difference between it and another thing," said Bain. But it is plain we cannot speak of contrast or difference between two states or things as a contrast or difference, if the states or things are not themselves presented; the so-called contrast or difference would then be itself a single presentation, and its supposed "relativity" but an inference. Difference is not more necessary to the presentation of two objects than two objects to the presentation of difference. And, what is more, a difference between presentation is not at all the same thing as the presentation of that difference. The former must precede the latter; the latter, which requires active comparison, need not follow. There is an ambiguity in the words "know," "knowledge," which Bain seems not to have considered: "to know" may mean either to perceive or apprehend, or it may mean to understand or comprehend.¹ Knowledge in the first sense is only what we shall have presently to discuss as the recognition or assimilation of an impression (see below, § 18); knowledge in the latter sense is the result of intellectual comparison and is embodied in a proposition. Thus a blind man who cannot know light in the first sense can know about light in the second if he studies a treatise on optics. Now in simple perception or recognition we cannot with any exactness say that two *things* are perceived: straight is a thing, *i.e.* a definite object presented; not so not-straight, which answers to no definite object at all. Only when we rise to intellectual knowledge is it true to say: "No one could understand the meaning of a *straight* line without being shown a line not straight, a bent or crooked line."² Two distinct presentations are necessary to the comparison that is here implied; but we must first recognize our objects before we *can* compare them, and this further step we may never take. We need, then, to distinguish between the comparativity of intellectual knowledge, which we must admit—for it rests at bottom on a purely analytical proposition—and the "differential theory of presentations," which, however plausible at first sight, must be wrong somewhere, since it commits us to absurdities. Thus, if we cannot have a presentation *X* but only the presentation of the difference between *Y* and *Z*, it would seem that in like manner we cannot have the presentation of *Y* or *Z*, nor therefore of their difference *X*, till we have had the presentation of *A* and *B* say, which differ by *Y*, and of *C* and *D*, which we may suppose differ by *Z*.

The lurking error in this doctrine, that all presentations are but differences, may perhaps emerge if we examine more closely what may be meant by difference. We may speak of (*a*) differences in intensity between sensations supposed to be qualitatively identical, as *e.g.* between the taste of strong and weak tea; or of (*b*) differences in quality between presentations of the same sense, as *e.g.* between red and green; or of (*c*) differences between presentations of distinct senses, as *e.g.* between blue and bitter. Now as regards (*a*) and (*b*), it will be found that the difference between two intensities of the same quality, or between two qualities of the same order, may be itself a distinct pre-

sentation, that is to say, in passing from a load of 10 lb to one of 20 lb, for example, or from the sound of a note to that of its octave, it is possible to experience the change continuously, and to estimate it as one might the distance between two places on the same road. But nothing of this kind holds of (*c*).³ In passing from the scent of a rose to the sound of a gong or a sting from a bee we have no such means of bringing the two into relation—scarcely more than we might have of measuring the length of a journey made partly on the common earth and partly through the looking-glass. In (*c*), then, we have only a diversity of presentations, but not a special presentation of difference; and we only have more than this in (*a*) or (*b*) provided the selected presentations occur together. We say that we know the difference between a sound and a taste; but what we mean is simply that we know what it is to pass from attending to the one to attending to the other. It is simply an experience of change. Change, however, implies continuity, and there is continuity here in the movement of attention and the affective state consequent on that, but not directly in the qualities themselves.

c. If red follows green we may be aware of a greater difference than we could if red followed orange; and we should ordinarily call a 10 lb load heavy after one of 5 lb and light after one of 20 lb. Facts like these it is which make the differential theory of presentations plausible. On the strength of such facts Wundt has formulated a law of relativity, free, apparently, from the objections just urged against Bain's doctrine. It runs thus: "Our sensations afford no absolute but only a *relative* measure of external impressions. The intensities of stimuli, the pitch of tones, the qualities of light, we apprehend (*empfinden*) in general only according to their mutual relation, not according to any unalterably fixed unit given along with or before the impression itself."⁴

But if true this law would make it quite immaterial what the impressions themselves were: provided the relation continued the same, the sensation would be the same too, just as the ratio of 2 to 1 is the same whether our unit be miles or millimetres. In the case of intensities, *e.g.* there is a *minimum sensible* and a *maximum sensible*. The existence of such extremes is alone sufficient to turn the flank of the thoroughgoing relativists; but there are instances enough of intermediate intensities that are directly recognized. A letter-sorter, for example, who identifies an ounce or two ounces with remarkable exactness identifies each for itself and not the first as half the second; of an ounce and a half or of three ounces he may have a comparatively vague idea. And so generally within certain limits of error, *indirectly ascertained*, we can identify intensities, each for itself, neither referring to a common standard nor to one that varies from time to time—to any intensity, that is to say, that chances to be simultaneously presented; just as an enlisting sergeant will recognize a man fit for the Guards without a yard measure and whether the man's comrades are tall or short. As regards the qualities of sensations the outlook of the relativists is, if anything, worse. In what is called Meyer's experiment (described under VISION) what appears greenish on a red ground will appear of an orange tint on a ground of blue; but this contrast is only possible within certain very narrow limits. In fact, the phenomena of colour-contrast, so far from proving, distinctly disprove that we apprehend the qualities of light only according to their mutual relation. In the case of tones it is very questionable whether such contrasts exist at all. Summing up on the particular doctrine of relativity of which Wundt is the most distinguished adherent, the truth seems to be that, in some cases where two presentations whose difference is itself presentable occur in close connexion, this difference—as we indirectly learn—exerts a certain bias on the assimilation or identification

³ Common language seems to recognize some connexion even here or we should not speak of harsh tastes and harsh sounds, or of dull sounds and dull colours and so forth. All this is, however, super-added to the sensation, probably on the ground of similarities in the accompanying organic sensations.

⁴ *Physiologische Psychologie*, 1st ed., p. 421; the doctrine reappears in later editions, but no equally general statement of it is given.

¹ Other languages give more prominence to this distinction; compare *γνώσκειν* and *εἰδέναι*, *noscere* and *scire*, *kennen* and *wissen*, *connaître* and *savoir*. On this subject there are some acute remarks in a little-known book, the *Exploratio philosophica*, of Professor J. Grote. Hobbes, too, was well awake to this difference, as *e.g.* when he says, "There are two kinds of knowledge; the one, sense or knowledge original and remembrance of the same; the other, science or knowledge of the truth of propositions, derived from understanding."

² Bain, *Logic*, i. 3.

of one or both of the presentations. There is no "unalterably fixed unit" certainly, but, on the other hand, "the mutual relations of impressions" are not everything.

15. The term "field of consciousness" has occurred sundry times in the course of this exposition: it is one of several *Subconsciousness* employed in describing what have been incidentally referred to as "degrees or grades of consciousness"—a difficult and perplexing topic that we must now endeavour further to elucidate. Sailors steering by night are said to look at the pole-star, "the cynosure of every eye," but this does not prevent them from seeing the rest of the starry vault. At a *conversazione* we may listen to some one speaker while still hearing the murmur of other voices, and while listening we may also see the speaker and thereby identify him the better. What in these instances is looked at or listened to has been called the "focus" of consciousness, the rest of what is heard or seen or otherwise presented being called the "field" within which attention is thus concentrated or brought to a point. Of these objects beyond the focus we have then only a lower degree of consciousness, and the more "distant" they are from the centre of interest the fainter and obscurer they are supposed to be or to become. Now, it is obvious that the continuity here implied, if strictly taken, logically commits us to a field of consciousness extending with ever diminishing intensity *ad infinitum*. But we have next to notice certain new features that have led psychologists to give to the term field of consciousness a more restricted meaning. A meteor flashing across the sky would certainly divert the helmsman's attention, and for the nonce he would look at that and not at the star in the Little Bear's tail; a voice at our elbow accosting us, we should turn to the new speaker and listen to him, still hearing it may be, but no longer "following," the discourse thus for us interrupted. In these cases a change in the field of consciousness brings about a non-voluntary change in the focus. But it only does so provided it is sufficiently intense and abrupt, and the more attention is already concentrated the less effective a given disturbance will be. A whole swarm of meteors might have streaked the sky unheeded while Ulysses, life in hand, steered between Scylla and Charybdis, just as all the din of the siege failed to distract Archimedes bent over his figures in the sand. On the other hand, we can voluntarily transfer the focus of consciousness to any object within the field, provided again this is sufficiently differentiated from the rest. But, more than that, we can not only of our own motion turn to look at or to listen to what we have only seen or heard, but not noticed before; we can also look out or listen for something not as yet distinguishable, perhaps not as yet existing at all. And here again the concentration of attention may be maximal, as when a shipwrecked crew scan the horizon for a sail, or a beleaguered troop hearken for the oncoming of rescue. Now, such anticipated presentations as soon as they are clearly discernible have already a certain finite intensity, and so they are said to have passed over "the threshold"—to use Herbart's now classic phrase—and to have entered the field of consciousness. Afterwards any further increase in their intensity is certainly gradual; are we then to suppose that before this their intensity changed instantly from zero to a finite quantity and not rather that there was an ultra-liminal or subliminal phrase where too it only changed continuously? The latter alternative constitutes the hypothesis of *subconsciousness*.

According to this hypothesis the total field with which we began is divided into two parts by what Fechner emphatically called "the fact of the threshold," and the term field of consciousness is henceforth restricted to that part within which the focus of consciousness always lies, the outlying part being the region of *subconsciousness*. Difficulties now begin to be apparent. The intensity or vivacity of a presentation within the field of consciousness depends partly on what we may call its inherent or absolute intensity, partly on the attention that it receives; but this does not hold of presentations in *subconsciousness*. These sub-presentations, as we ought perhaps to call them, cannot be severally and selectively attended to,

cannot be singled out as direct objects of experience. Many psychologists have accordingly maintained not only that they cannot with propriety be called presentations, but that they have no strictly psychical existence at all. This, however, is too extreme a view. If nothing of a presentational character can exist save in the field of consciousness as thus circumscribed by a definite boundary or threshold, a breach of continuity is implied such as we nowhere else experience: even the field of sight, from which the metaphor of a field of consciousness is derived, has no such definite margin. The threshold then is not comparable to a mathematical line on opposite sides of which there is an intensive discontinuity. This has been amply proved by the psychophysical investigations of Fechner and others. We listen, say, to a certain sound as it steadily diminishes; at length we cease to hear it. Again, we listen for this same sound as it steadily increases and presently just barely hear it. In general it is found that its intensity in the former case is less than it is in the latter, and there is also in both cases a certain margin of doubt between clear presence and clear absence; the presentation seems to flicker in and out, now there and now gone. Further, in comparing differences in sensations—of weight, brightness, temperature, &c.—we may fail wholly to detect the difference between *a* and *b*, *b* and *c*, and yet the difference between *a* and *c* may be clearly perceived. We have thus to recognize the existence of a difference between sensations, although there is no so-called "sensation of difference." But if this much continuity must be admitted we can hardly fail to admit more. If differences of presentation exist within the field of consciousness beyond the outermost verge of the "threshold of difference," we cannot consistently deny the existence of any presentations at all beyond the threshold of consciousness. Since the field of consciousness varies greatly and often suddenly with the amount and distribution of attention, we must, as already said, either recognize such *subconscious* presentations or suppose that clearly differentiated presentations, presentations that is to say of finite intensity, pass abruptly into or out of existence with every such variation of the field.

The hypothesis of *subconsciousness*, then, is in the main nothing more than the application to the facts of presentation of the law of continuity, its introduction into psychology being due to Leibnitz, who first formulated that law. Half the difficulties in the way of its acceptance are due to our faulty terminology. With Leibnitz consciousness was not coextensive with all psychical life, but only with certain higher phases of it.¹ Of late, however, the tendency has been to make *subconsciousness* cover all stages of mental development, and all grades of presentation, so that a presentation of which there is no *subconsciousness* resolves itself into the manifest contradiction of an unrepresented presentation—a contradiction not involved in Leibnitz's "unperceived perception." But such is not the meaning intended when it is said, for example, that a soldier in battle is often unconscious of his wounds or a scholar unconscious at any one time of most of the knowledge "hidden in the obscure recesses of his mind." There would be no point in saying a subject is not conscious of what is not presented at all; but to say that what is presented lacks the intensity requisite in the given distribution of attention to change that distribution appreciably is pertinent enough. *Subconscious* presentations may tell on conscious life—as sunshine or mist tells on a landscape, or the underlying writing on a palimpsest—although lacking either the intensity or the individual distinctness requisite to make them definite features. Even if there were no facts to warrant

¹ The following brief passage from his *Principes de la nature et de la grace* (§ 4) shows his meaning: "Il est bon de faire distinction entre la *Perception*, qui est l'état intérieur de la *Monade* représentant les choses externes, et l'*Apperception*, qui est la *Conscience*, ou la connaissance réflexive de cet état intérieur, laquelle n'est point donnée à toutes les âmes, ni toujours à la même âme. Et c'est faute de cette distinction que les Cartésiens ont manqué, en comptant pour rien les perceptions dont on ne s'aperçoit pas, comme le peuple compte pour rien les corps insensibles" (*Op. Phil.* Erdmann's ed., p. 715).

this concept of an ultra-liminal presentation of impressions it might still claim an a priori justification.

The subconscious presentation of ideas as distinct from impressions calls, however, for some special consideration. As we can turn our attention to the sensory threshold and await the entrance of an expected impression, so we may await the emergence of a "memory-image"; and again the threshold turns out to be not a mathematically exact boundary but a region of varying depth.¹ What we are trying to recollect seems first to waver, now at the tip of our tongue and the next moment completely gone, then perhaps a moment afterwards rising into clear consciousness. Sometimes when asked, say, for the name of a certain college contemporary we reply: I cannot tell, but I should know the name if I heard it. We are aware that we could "recognize," though we cannot "reproduce." At other times we are confident that even recognition is no longer possible, and still if we met the man himself in the old scenes and heard his voice his name might yet recur. Nevertheless, it may be urged, it is surely incredible that all the incidents of a long lifetime and all the items of knowledge of a well-stored mind that may possibly recur—"the infinitely greater part of our spiritual treasures," as Hamilton says—are severally retained and continuously presented in the form and order in which they were originally experienced or acquired. This, however, is not implied. Images in contrast to impressions have always a certain generality. The same image may figure in very various connexions, as may the same letter, for example, in many words, the same word in many sentences. We cannot measure the literature of a language by its vocabulary, nor may we equate the extent of our "spiritual treasures" when these are successively unfolded with the psychical apparatus, so to say, in which they are subconsciously involved.² Take the first book of the *Aeneid*, which, as Macaulay would say, every schoolboy knows: as subconsciously involved, when the boy is not thinking of it, his knowledge is more comparable to a concordance than to the text itself, which nevertheless can be reproduced from it. In the text Aeneas occurs many times, in the concordance as a heading but once. But give him the cue *Aeneas scopulum*, and the boy reels off from the 180th line; or *Præcipue pius Aeneas*, and he starts with the 220th. But ask him for the 580th line; he is probably helpless, while a dunce with the book in his hand can read it off at once. Say instead *Et pater Aeneas*, and the boy can straightway complete the line while the dunce is now helpless. So though its explicit revival is successional, occurs, so to say, in single file, a whole scheme in which many ideas are involved may rise towards the threshold together. When our schoolboy, for example, turns from classics to geography, the mention of Atlas, which might then have recalled a Titan, now leads him to think only of his book of maps. And there is a like sudden shifting of the substratum of our thoughts, when, taking up the morning paper, we glance first at the foreign telegrams, then at the money market, and then at the doings of our political friends. Yet more remote than all, obscurer but more pervasive, like the clouds of cherubs or imps vaguely limned in medieval pictures, are the indefinite constituents of our emotional atmosphere, "gay notes that people the sunbeams" of our cheerfulness and make all *couleur de rose*, or "horrid shapes and sights unholy" that overcast the outlook when we "have the blues." And as attention relaxes, these advance into the foreground and become more or less palpable hopes or fears.

¹ Herbart and Fechner describe subconscious presentations generally as existing *below* the threshold. On the other hand, we have spoken of subconscious *sensations* as existing *beyond* it. In view of the important differences between the two forms of presentations primary and secondary, this distinction of ultra-liminal and subliminal seems convenient and justifiable.

² This doctrine of the involution and evolution of ideas we owe to Leibnitz. Herbart attempted in a very arbitrary and a priori fashion to develop it into a physical statics and dynamics with the result—usual to extreme views—that later psychologists neglected it altogether. There are now signs of a fresh reaction, and we shall continually come across evidence of the wide range and great importance of the doctrine as we proceed.

Because of the manifold forms into which they may evolve, subconscious images, while still involved, are sometimes called "psychical" or more definitely "presentational dispositions." The word *disposition* means primarily an arrangement, as when we talk of the disposition of troops in a battle or of cards in a game; the *disposita*, that is to say, are always something actual. Which of several potential dispositions they will actually assume will depend upon circumstances, but at least, as Leibnitz long ago maintained, "les puissances véritables ne sont jamais des simples possibilités." What is requisite to the realization of a given potentiality is sometimes a condition to be added, sometimes it is one to be taken away. A locomotive with the fire out has no tendency to move, but with steam up it is only hindered from moving by the closure of the throttle-valve or the friction of the brake. Now presentational dispositions we assume to be of the latter sort. They are processes or functions more or less inhibited, and the inhibition is determined by their relation to other psychical processes or functions. The analysis and genesis of these presentational interactions will occupy us at length by and by; it may then be possible to explain the gradual involution of what was successively unfolded in explicit consciousness into those combinations which Herbart called "apperception-masses," combinations devoid of the concrete hints of date and place which are essential to memory. Meanwhile the evidence adduced—decidedly cogent though admittedly indirect—together with the difficulties besetting the extreme view that beyond or below the threshold of consciousness there is nothing presentational, seems clearly to justify the hypothesis of subconsciousness. At the same time the principle of continuity, everywhere of fundamental importance when we are dealing with reality, forbids the attempt arbitrarily to assign any limits to the subconscious.

Many psychologists have proposed to explain subconscious retention by habit. But it is obvious that habit itself implies retention and is practically synonymous with disposition; it must therefore presuppose *disposita* if we are to escape the absurdities of *puissances ou facultés nues*, with which in this very connexion Leibnitz twitted Locke. Yet, obvious as all this may be, it is frequently ignored even by those who are fond of exposing the pretended explanations of the "faculty-psychologists" and quoting Molière to confute them. Thus we find J. S. Mill arguing: "I have the power to walk across the room though I am sitting in my chair; but we should hardly call this power a latent act of walking."³ Nor should we call it a power at all if Mill had been paralysed, or if, instead of sitting in his chair, he had been lying in his cradle. What we want is the simplest psychological description of the situation after the power has been acquired by practice and is still retained. In such a case we can be conscious of the "idea" of the movement without the movement actually ensuing; yet only in such wise that the idea is more apt to pass over into action the intenser it is, and often actually passes over in spite of us. Surely there must be some functional activity answering to this conscious presentation; why may not a much less amount of it be conceived possible in subconscious presentation?

Sensation, Movement and the External World.

16. On the view of experience here maintained, we are bound to challenge the description of sensations⁴ as due to physical stimuli—widely current though it is—as one that is psychologically inappropriate. The following definition, given by Bain, may be taken as a type: "By sensations, in the strict meaning, we understand the mental impressions, feelings or states of consciousness following on the action of external things on some part of the body, called on that account sensitive."⁵ It is true, no doubt, that what the psychologist calls sensibility has as its invariable concomitant what physiologists call sensibility,

³ *Examination of Sir W. Hamilton's Philosophy*, 3rd ed., p. 329.

⁴ For a detailed account of the various sensations and perceptions pertaining to the several senses the reader is referred to the articles VISION; HEARING; TOUCH; TASTE; SMELL, &c.

⁵ *Senses and Intellect*, 4th ed. (1894), p. 101.

Definition of Sensation.

or what the more careful of them call irritability; and, true again, that this irritability is invariably preceded by a physical process called stimulation. But it may be urged, why not recognize a connexion that actually obtains, since otherwise sensation must remain unexplained? Well, in the first place, such "psychophysical" connexion is not a psychological explanation: it cannot be turned directly to account in psychology, either analytic or genetic. Next the psychological fact called sensation always is, and at bottom always must be, independently ascertained; for the physiological "neurosis" or irritation has not necessarily a concomitant "psychosis" or sensation and, strictly dealt with, affords no hint of such. Finally, this inexplicability of sensation is a psychological fact of the utmost moment: it answers to what we call reality in the primary sense of the term. The psychophysicist, in setting out to explain sensation, has—unawares to himself—left this fundamental reality behind him. For it belongs essentially to individual experience, and this—in assuming the physical standpoint—he has of course transcended. Nevertheless the mistake of method that here reveals itself was perhaps inevitable, for the facts of another's sense-organs and their physical excitants must have obtruded themselves on observation long before the reflective attitude was advanced enough to make strictly psychological analysis possible. The psychophysical standpoint, that is to say, was attained before the purely psychological; and the consequent bias is only now in process of correction. A series of physical processes, first without and then within the organism—ethereal or aerial vibrations, neural and cerebral excitations—was the starting-point. What comes first, immediately, and alone, in the individual's experience, and is there simply and positively *real*, was then misinterpreted as subjective modification, mental impression, *species sensibiles*, or the like. For from the days of Democritus to our own the same crude metaphor has prevailed without essential variation. And here the saying holds: *Vestigia nulla retrorsum*. Into the man's head the whole world goes, including the head itself. Such thoroughgoing "introjection" affords no ground for subsequent "projection." Thus the endeavour to explain sensation overreaches itself: the external object or thing that was supposed to cause sensations and to be therefore distinct from them, was in the end wholly resolved into these and regarded as built out of them by association (Mill) or by apperceptive synthesis (Kant). But no "mental chemistry," no initial alchemy of "forms," can generate objective reality from feelings or sense-impressions as psychophysically defined.¹ A's experience as it is for B is not real but inferential; and if the grounds of the inference, which are the only realities for B, are to be regarded as the causes of which A's experiences are merely the effects, then the two experiences are on a wholly different footing. When A treats B in the same fashion we get the world in duplicate: (1) as original and outside, *i.e.* as *cause*, and (2) as copied within each percipient's head, *i.e.* as *effect*. But when B interprets his own experience as he had interpreted A's we seem to have lost the real world altogether. In presence of this dilemma, the philosophers of our time, as already said, are feeling it needful to revise their psychology. The question of method is vital. If the psychophysical standpoint were the more fundamental, psychology would be based on physiology, and the old definition of sensation might stand. If, on the other hand, it is the exclusive business of psychology to analyse and trace the development of individual experience as it is for the experiencing individual, then—however much neurological evidence may be employed as a means of ascertaining psychological facts—the facts themselves must be scrupulously divested of all physical implications, the psychophysical method takes a secondary place, and the objective reality of "sensory" presentations stands unimpeached.

The duality of subject and object in experience compels us also to object to the description of sensations as "states of conscious-

¹ Nothing shows this more plainly than the newly-coined term *epiphenomenon* now applied in this connexion.

ness." Since it is the subject, not the object that is conscious, the term state of consciousness implies strictly a subjective reference; and so it is only applicable to sensations, if they are regarded as subjective modifications, either affective or active. The former would identify sensation with feeling, and this—for reasons already given—we must disallow. But it is true that a sensation, like other presentations, implies the subjective activity we call attention; it is not, however, a modification or state of this activity, but the object of it. This relation is expressed in German by means of the distinction generally of *Vorstellen* and *Vorstellung* and in the present case of *Empfinden* and *Empfindung*; and German psychology has gained in clearness in consequence. The distinction of conception and concept (*conceit*) is to be found in older English writers and was revived by Sir W. Hamilton, who suggested also the analogous distinction of perception and percept. It would be a great gain if there were a corresponding pair of terms to distinguish between "the sensing act" and the object "sensed," as some have been driven to say. Reception and receipt at once occur and seem unexceptionable—apart, of course, from their novelty.² At any rate, if we are to rest content with our present untechnical terminology we must understand sensations to mean objective changes as they first break in upon the experience of our psychological individual; in this respect Locke's term "impression" has a certain appropriateness.

What we ordinarily call a single sensation has not only a characteristic quality but it is also quantitatively determined in respect of intensity, protensity (or duration) and extensity. A plurality of properties, it may be said, straightway implies complexity of some sort. This is obvious and un-*Characteristics of Sensation*.—analysis of simple sensations is possible, and the description just given is reached by means of it. Such analysis, however, presupposes the comparison of many sensations; but to the complexity it discloses there is no answering plurality discernible in the immediate experience of a single sensation. To make this clearer let us start from a case in which such plurality *can* be directly verified. In a handful of rose petals we are aware at once of a definite colour, a definite odour and a definite "feel." Here there is a plurality ($a+b+c$), any part of which can be withdrawn from our immediate experience without prejudice to the rest, for we can close the eyes, hold the nose, or drop the petals on the table. Let us now turn to the colour alone; this we say has a certain quality, intensity, extensity, &c. But not only have we not one sense for quality, another for intensity, &c., but we cannot reduce the intensity to zero and yet have the quality remaining; nor can we suppress the quality and still retain the extensity. In this case then what we have is not a plurality of presentations ($a+b+c$), but a single presentation having a plurality of attributes ($a\ b\ c$) so related that the absence of any one annihilates the whole. But though, as already said, such single presentation gives, as it stands, no evidence of this plurality, yet it is to be remembered that in actual experience we do not deal with sensations in isolation; here, accordingly, we find evidence in plenty to justify our psychological analysis. In innumerable cases we experience varieties of intensity with little or no apparent change of quality, as happens, for example, when a sounding pitch-pipe is moved towards or away from the ear; and continuous changes of quality without any change of intensity, as happens when the pipe is shortened or lengthened without any alteration of position. We may have tactual or visual sensations which vary greatly in extensity without any striking change of quality, and we may have such sensations in every possible variety of quality without any changes of extensity.

The numerous and striking diversities among our present sensations are obviously not primordial; what account then can we give of their gradual differentiation? Some psychologists have assumed the existence of absolute "units of

² Reception does not in English suggest the taking *back* of the Latin *recipere*; it expresses only the comparative passivity of sense. In contrast to *percipere* (to take entire possession of) it implies the absence of that assimilation which is essential to perception; and finally it contrasts appropriately with retention.

³ This distinction, though continually overlooked, is vitally important. By *psychological* analysis we mean such analysis as the psychological observer can reflectively make, by *psychical* analysis only such analysis as is possible in the immediate experience of the subject observed.

sensibility," all identically the same, and explain the unlikenesses in our existing sensations as resulting "from unlike modes of integration of these absolute units."¹ *Differentiation of Sensation.* The sole evidence on which they rely is physiological, the supposed existence of a single nerve shock or neural tremor. It is true that in an extirpated nerve what is known as the "negative variation" is approximately such an isolated event of uniform quality. But the same cannot be said of what happens during the stimulation of a nerve *in situ* with its peripheral and central connexions still intact. The only evidence apparently to which we can safely appeal in this inquiry is that furnished by biology. Protoplasm, the so-called "physical basis of life," is amenable to stimulation by every form of physical agency—mechanical, chemical, thermal, photical, electrical—with the single exception of magnetism; and in keeping with this it is found that unicellular organisms respond, and respond in ways more or less peculiar, to each of these possible modes of excitation. Since, so far as is known, there is no morphological separation of function in these lowest forms of life, it is reasonably assumed that the single cell acts the part of "universal sense-organ," and that the advance to such complete differentiation of sense-organs as we find among the higher vertebrates has been a gradual advance. Numerous facts can now be adduced of the occurrence of "transitional" or "alternating" sense-organs among the lower forms of multicellular animals; organs, that is to say, which are normally responsive to two or more kinds of stimulus, and thus hold an intermediate position between the universal sense-organ of the *Protozoa* and the special sense-organ of the *Mammalia*. For example, a group of cells which would behave towards all stimuli impartially were they independent unicellular organisms become, as an organ in a multicellular organism, amenable only to mechanical or only to chemical stimuli,—become, that is to say, an organ of touch and of hearing, or an organ of taste and also of smell; until, finally, when differentiation is sufficiently advanced, the group ends by becoming exclusively the organ of one specified sense, touch or hearing in the one case, taste or smell in the other.² Of course the imperfectly specialized sensations, say of the leech, and still more the wholly unspecialized sensations of the amoeba, cannot be regarded as blends of some or all of those which we are said to receive through our five senses. We must rather suppose that sensations at the outset corresponded very closely with the general vital action of stimuli as distinct from their action on specially differentiated sensory apparatus. Even now we are still aware of the general effects of light, heat, fresh air, food, &c., as invigorating or depressing quite apart from their specific qualities. Hence the frequent use of the term general or common sensibility (*coenesthesia*). But, though less definitely discriminated, the earlier, and what we call the lower, sensations are not any less concrete than the later and higher. They have been called general rather than specific, not because psychologically they lack any essential characteristic of sensation which those acquired later possess, but simply because physiologically they are not, like these, correlated to special sense-organs.

But, short of resolving such sensations into combinations of one primordial modification of consciousness, if we could *Complexity of Sensations.* conceive such, there are many interesting facts which point clearly to a complexity that we can seldom directly detect. Several of our supposed sensations of taste, *e.g.*, are complicated with sensations of touch and smell: thus the pungency of pepper and the dryness of wine are actual sensations, and their spicy flavours are really smells. How largely smells mingle with what we ordinarily take to be simply tastes is best brought home to us by a severe cold in the head, as this temporarily prevents the access of exhalations to the olfactory surfaces. The difference between the smooth feel of a polished surface and the roughness of one that is

unpolished, though to direct introspection an irresolvable difference of quality, is probably due to the fact that several nerve-terminations are excited in each case: where the sensation is one of smoothness all are stimulated equally; where it is one of roughness the ridges compress the nerve-ends more, and the hollows compress them less, than the level parts do. The most striking instance in point, however, is furnished by the differences in musical sounds, to which the name *timbre* is given. To the inattentive or uninstructed ear notes or "compound tones" appear to be only qualitatively diverse and not to be complexes of simple tones. Yet it is possible with attention and practice to distinguish these partial tones in a note produced on one instrument, a horn, say, and to recognize that they are different from those of the same note produced on a different instrument, for example, a violin.

In like manner many persons believe that they can discriminate in certain colours, hence called "mixed," the elementary colours of which they are held to be composed; red and yellow, for example, in orange, or blue and red in violet. But in so thinking they appear to be misled, partly by the resemblance that certainly exists between orange and red, on the one hand, and orange and yellow on the other, the two colours between which in the colour spectrum it invariably stands; and partly by the knowledge that, as a pigment, orange is obtainable by the mixture of red and yellow pigments; and so in the other cases. As we shall see later, however (§ 39), in this particular case of sensory continua, resemblance is no proof of complexity. Were it otherwise we should have to conclude that a given tone, since this also resembles the two between which it is intermediate, ought to be a blend of both; whereas, in point of fact, the tone *d*—though as regards pitch it has a certain resemblance to *c* and *e*, its neighbours on either side—differs widely from the chord *c-e*, which is made up of these. In all cases in which the psychological complexity of a sensation is beyond dispute the partial sensations are distinguished by discernible differences of extensity, and usually of intensity as well. Thus, if the skin be touched by the point of a hot or cold brawawl the temperature sensation has not the punctual character of the touch but seems rather to surround this as a sort of penumbra. Similarly, the ground-tone of a clang-complex has not only a greater intensity but also a greater extensity than any of the over-tones.³ There is also in such cases a certain rivalry or antagonism between the complex as an unanalysed whole and the complex as analysed, and even between the several partial sensations after such analysis. In the absence of such direct evidence it is unwarrantable to infer psychological complexity from complexity in the physical stimuli, even when this is really present. In the case of pigment mixture, however, there is no such physical complexity as is vulgarly supposed. And it is worth noting that white light is physically the most complex of all, whereas the answering sensation is not only simple but probably the most primitive of all visual sensations.

Every sensation within the fields of consciousness has sensibly some continuous duration and seems sensibly to admit of some continuous variation in intensity and extensity. But whether this quantitative continuity *Quantitative Continuity.* of presentational change is more than apparent has been questioned. Sensations of almost liminal intensity are found to fluctuate every few seconds, and, as already remarked, when the threshold of intensity is actually reached, they seem intermittently to appear and disappear, a fact which Hume long ago did not fail to notice. The results of numerous experiments, however, justify the conclusion that these variations are due primarily to oscillation of attention, and furnish so far no ground for the assumption that even the liminal sensation is discontinuous. But again we can only detect a difference of intensity when this is of finite amount and bears a certain constant ratio to the initial intensity with which it is compared—a fact commonly known as Weber's Law. But this imperfection in our power of discrimination is no proof that our sensations vary discontinuously; and not only is there no positive evidence in favour of such discontinuity, but it is altogether improbable on general grounds. Lastly, there is always more or less distinctness in the several nerve-endings as well as isolation of the nerve-fibres themselves. The skin, for example, when carefully explored, turns out to be a complex mosaic of so-called "spots," severally responding to stimulation by sensations of pressure, heat, cold and pain. But from this to argue that the extensity of a sensation is really a mere aggregate without any continuity is on a par with calling a lake a

¹ Cf. G. H. Lewes, *Problems of Life and Mind* (1879), vol. iii. pp. 250 sqq.; H. Spencer, *Principles of Psychology*, vol. i. § 60.

² Cf. W. A. Nagel, "Die Phylogense specifischer Sinnesorgane," *Bibliotheca zoologica* (1894), pp. 1-42.

³ Cf. Stumpf, *Tonpsychologie*, ii. 58 seq.

collection of pools because it is fed by separate streams. If it could be shown that in the brain as a whole there is no functional continuity a formidable psychophysical problem would no doubt arise.

As regards the quality of sensations—the primitive sensation of sight appears to consist only of the single quality we call “light,” a quality which ranges in intensity from a dazzling brightness that becomes painful and blinding down to a zero of complete darkness; a limit which, however, is never completely attained, since the retina is always more or less internally stimulated—hence what is called the eye’s own light (*Eigenlicht*). The first responses to light-stimulation seem to be very much on a par with our own to diffused heat or cold; some organisms seek the light and others shun it. As little as our temperature-sense yields us a perception of form does the light-sense at this level yield any. Not until the stage of visual spatial perception is reached and some discrimination of form is possible, do black and white attain the meaning they now have for us. An object can be visually perceived only when its colour or shade differs from that of the surrounding field; so far black as a “secondary quality” is on a par with colour, that is to say, when we are talking of things it may be called a quality. But there is still an important difference; in a light field many colours or shades may be distinguished, but in a dark field none. Though it is correct to speak of perceiving a black object, must we not then maintain that—so far as it is really black¹—the object yields us directly no sensation? Similarly, the piper is said to “feel” the holes in his whistle when actually he only touches the solid metal in which they are pierced; or the soldier is said to hear the tattoo, though he has no auditory sensation of the silence intervening between successive taps on the drum. And it has yet to be shown that there is any more justification for speaking of visual sensations without luminosity. Meanwhile we must maintain that in absolute darkness we do not see black, since we do not see at all. No doubt we are prone to identify the two concepts darkness and blackness, for what we may call their sensory content is the same, viz. the absence of visual sensation.

Whereas in nature the only diffused light we need consider is that emitted by the sun, the rays transmitted by the things about us vary in physical quality and in their effects upon protoplasm. As soon, therefore, as visual forms can be distinguished, a differentiation among light-sensations becomes obviously advantageous. The first colours to be differentiated were probably yellow and blue, or perhaps it would be truer to say “warm” colour and “cold” colour, upon which there followed a further differentiation of the warm colour into red and green.² It is interesting to note that all possible sensations of colour constitute a specific continuum. We may represent it by a sphere, in which (a) the maximum of luminosity is at one pole and the minimum at the other; (b) the series of colours proper (red to violet and through purple back to red), constituting a closed line, are located round the equator or in zones parallel to it, according to shade; and (c) the amount of saturation (or absence of white) for any given zone of illumination increases with distance from the axis.

In dealing with the quality of auditory sensations we have to distinguish between the simple sensations called tones and the sensation-complexes, either clangs or noises, which result from their combination. Simple tones also constitute a qualitative continuum, but it has only one dimension, their so-called “pitch”; this may be represented by a straight line ranging between two more or less indefinite extremes. If intensity, that is to say loudness, is taken into account, we have of course a continuum of two dimensions. The tone-continuum is also universally regarded as steadily diminishing in massiveness or extensity as the pitch rises. And, in fact, as we approach the lower

¹ As a matter of fact there are no objects absolutely black, none that are devoid of all lustre and completely absorbent of light. But this does not affect the argument.

² It is assumed that the physiological differentiation of the retina has advanced from the centre, where vision is most distinct, towards the margin where it is least so; and it is found that stimulation of the margin yields none but achromatic sensations, stimulation of a certain intermediate zone only sensations of yellow or blue, and central stimulation alone sensations of every hue. Further, total colour-blindness is extremely rare, whereas red-green colour-blindness is comparatively common.

limit, the so-called deep or grave tones become less “even,” till at length distinct, more or less pervasive, tremors are felt rather than heard as distinct impulses on the ear-drum. The so-called high or acute tones again, as we approach their limit, are accompanied by tactual, often more or less painful, sensations, as if the ear were pierced by a fine needle. This connexion of auditory with tactual sensations confirms the independent evidence of biology pointing to an original differentiation of sound from touch. The special characteristics of tone-complexes, whether clangs or noises, are due to the remarkable analytic power which belongs to the sense of hearing. Two colours cannot be simultaneously presented unless they are differently localized, but several tones may form one complex whole within which they, as “partial” tones, are distinguishable, though spatially undifferentiated.

Unlike the higher senses of sight and hearing, the lower senses of touch, taste, smell, &c., do not constitute qualitative continua. Temperatures may indeed be represented as ranging in opposite directions, i.e. through heat or through cold, between a zero of no sensation and the organic sensations due to the destructive action of both extremes, heat and cold alike. But the continuity in this case is intensive rather than qualitative. Tastes fall into the four isolated qualities known as sweet, sour, bitter, saline; but smells hardly admit of classification at all. Sensations of touch and sight have in a pre-eminent degree a certain peculiar continuity which differentiations of extensity entail, and which we shall have presently to consider further under the title of local signs. The various sensations classed together as organic, hunger, thirst, physical pain, &c., are left to the physiologist to describe.

Our motor presentations contrast with the sensory by their want of striking qualitative differences. They are divided into two groups: (a) motor presentations proper and (b) auxilio-motor or kinaesthetic presentations. The former answer to our “feelings of muscular effort” or “feelings of innervation.” The latter are those presentations due to the straining of tendons, stretching and flexing of the skin, and the like, by which the healthy man knows that his efforts to move are followed by movement, and so knows the position of his body and limbs. It is owing to the absence of these presentations that the anaesthetic patient cannot directly tell whether his efforts are effectual or not, nor in what position his limbs have been placed by movements from without. Thus under normal circumstances motor presentations are always accompanied by auxilio-motor; but in disease and in passive movements they are separated and their distinctness thus made manifest. Originally we may suppose kinaesthetic presentations to have formed one imperfectly differentiated continuum, but now, as with sensations, they have become a collection of special continua, viz. the groups of movements possible to each limb and certain combinations of these movements.

But whereas kinaesthetic presentations were commonly allowed to be purely sensory, the concomitants of centripetal excitations—hence the older name of “muscular or sixth sense” applied to them by Sir Charles Bell, Weber, Sir William Hamilton and others—concerning motor presentations proper, a very different view, first tentatively advanced by the great physiologist Johannes Müller, and adopted by Helmholtz, Wundt, and especially by Bain, long prevailed. It is, however, now generally discredited, if not completely overthrown.³ According to this view, “the characteristic feeling of exerted force” must be regarded, Bain maintained, “not as arising from an inward transmission . . . but as the concomitant of the outgoing current by which the muscles are stimulated to act” (*op. cit.* p. 79). The necessity for this assumption has certainly not been established on physiological grounds, nor apparently did Bain rely primarily on these; for at the very outset of his discussion we find him saying “that action is a more intimate and inseparable property of our constitution than any of our sensations, and enters as a component part into every one of our senses” (*op. cit.* p. 59). But this important psychological truth is affirmed as strenuously by some, at any rate (e.g. Professor James) of Bain’s opponents as it was by Bain himself. Unhappily many, under the same psychophysical

³ Cf. Bastian, *The Brain as an Organ of Mind* (1880), pp. 691 sqq.; Ferrier, *The Functions of the Brain* (1886), 2nd ed. pp. 382 sqq.; James, *Principles of Psychology* (1890), ch. xxvi.

bias and so induced, like the upholders of this innervation theory, to look for evidence of subjective activity in the wrong place, have been led to doubt or to deny the reality of this activity altogether. In fact, this theory, while it lasted, tended to sustain an undue separation of so-called "sensory" from so-called "motor" presentations, as if living experience were literally an alternation of two independent states, one wholly passive and the other wholly active, corresponding to the anatomical distinction of organs of sense and organs of movement. The subject of experience or Ego does not pass to and fro between a *sensorium commune* or intelligence department and a *motorium commune* or executive, is not in successive intervals receptive and active, still less always passive, but rather always actively *en rapport* with an active Non-Ego, commonly called the External World.

Perception.

17. In treating apart of the differentiation of our sensory and motor continua, as resulting merely in a number of distinguishable sensations and movements, we have been compelled by the exigencies of exposition to leave out of sight another process which really advances *pari passu* with this differentiation, viz. the integration or synthesis of these proximately elementary presentations into those complex presentations which are called percepts, intuitions, sensori-motor reactions and the like. It is, of course, not to be supposed that in the evolution of mind any creature attained to such variety of distinct sensations and movements as a human being possesses without making even the first step towards building up this material into the most rudimentary knowledge and action. On the contrary, there is every reason to think, as has been said already incidentally, that further differentiation was helped by previous integration, that perception prepared the way for distincter sensations, and purposive action for more various movements. This process of synthesis, which is in the truest sense a psychical process, deserves some general consideration before we proceed to the several complexes that result from it. Most complexes, certainly the most important, are consequences of that principle of subjective selection whereby interesting sensations lead through the intervention of feeling to movements; and the movements that turn out to subserve such interest come to have a share in it. In this way—which we need not stay to examine more closely now—it happens that a certain sensation, comparatively intense, and a certain movement, definite enough to control that sensation, engage attention, to the more or less complete exclusion of the other less intense sensations and more diffused movements that accompany them. Apart from this intervention of controlling movements, the presentation-continuum, however much differentiated, would remain for all purposes of knowledge little better than the disconnected manifold for which Kant took it. At the same time it is to be remembered that the subject obtains command of particular movements out of all the mass involved in emotional expression only because such movements prove on occurrence adapted to control certain sensations. A long process, in which natural selection probably played the chief part at the outset—subjective selection becoming more prominent as the process advanced—must have been necessary to secure as much purposive movement as even a worm displays. We must look to subjective interest to explain, so far as psychological explanation is possible, those syntheses of motor and sensory presentations which we call spatial perception and the intuitions of material things. For example, some of the earliest lessons of this kind seem to be acquired as we may presently see, in the process of exploring the body by means of the limbs,—a process for which grounds in subjective interest can obviously never be wanting.

Perception sometimes means only the recognition of a sensation or movement as distinct from its original presentation, thus implying the more or less definite revival of certain residua of past experience which resembled the present. More frequently it is used as the equivalent of what has been otherwise called the "localization and projection" of sensations—that is to say, of sensations apprehended either as affections of some part of

our own body regarded as extended or as states of some foreign body beyond it. According to a former usage, strictly taken, there might be perception without any spatial presentation at all; a sensation that had been attended to a few times might be perceived as familiar. According to the latter, an entirely new sensation, provided it were complicated with motor experiences in the way required for its localization or projection, would be perceived. But as a matter of fact actual perception probably invariably includes both cases: impressions which we recognize we also localize or project, and impressions which are localized or projected are never entirely new—they are, at least, perceived as sounds or colours or aches, &c. It will, however, frequently happen that we are specially concerned with only one side of the whole process, as is the case with a tea-taster or a colour-mixer on the one hand, or, on the other, with the patient who is perplexed to decide whether what he sees and hears is "subjective," or whether it is "real." But there is still a distinction called for: perception as we now know it involves not only recognition (or assimilation) and localization, or "spatial reference," as it is not very happily termed, but it usually involves "objective reference" as well. We may perceive sound or light without any presentation of that which sounds or shines; but none the less we do not regard such sound or light as merely the object of our attention, as having only immanent existence, but as the quality or change or state of a thing, an object distinct not only from the subject attending but from all presentations whatever to which it attends. Here again the actual separation is impossible, because this factor in perception has been so intertwined throughout our mental development with the other two. Still a careful psychological analysis will show that such "reification," as we might almost call it, has depended on special circumstances, which we can at any rate conceive absent. These special circumstances are briefly the constant conjunctions and successions of impressions, for which psychology can give no reason, and the constant movements to which they prompt. Thus we receive together, e.g. those impressions we now recognize as severally the scent, colour, and "feel" of the rose we pluck and handle. We might call each a "percept," and the whole a "complex percept." But there is more in such a complex than a sum of partial percepts; there is the apprehension or intuition of the rose as a thing having this scent, colour and texture. We have, then, under perception to consider (a) the recognition and (b) the localization of impressions, and (c) the intuition of things.

18. The range of the terms recognition or assimilation of impressions is wide: between the simplest mental process they may be supposed to denote and the most complex *Assimilation of Impressions* there is a great difference. The penguin that *watched unmoved the first landing of man upon its lonely rock* becomes as wild and wary as more civilized fowl after two or three visits from its molester: it then recognizes that featherless biped. His friends at home also recognize him though altered by years of peril and exposure. In the latter case some trick of voice or manner, some "striking" feature, calls up and sustains a crowd of memories of the traveller in the past—events leading on to the present scene. The two recognitions are widely different, and it is from states of mind more like the latter than the former that psychologists have usually drawn their description of perception. At the outset, they say, we have a primary presentation or impression P , and after sundry repetitions there remains a mass or a series of P residua, $p_1 p_2 p_3 \dots$; perception ensues when, sooner or later, P_n "calls up" and associates itself with these representations or ideas. Much of our later perception, and especially when we are at all interested, awakens, no doubt, both distinct memories and distinct expectations; but, since these imply previous perceptions, it is obvious that the earliest form of recognition, or, as we might better call it, assimilation, must be free from such complications, can have nothing in it answering to the overt judgment, P_n is a P . Assimilation involves retentiveness and differentiation, as we have seen, and prepares the way for re-presentation; but in itself there is no confronting

the new with the old, no determination of likeness, and no subsequent classification. The pure sensation we may regard as a psychological myth; and the simple image, or such sensation revived, seems equally mythical, as we may see later on. The *n*th sensation is not like the first: it is a change in a presentation-continuum that has itself been changed by those preceding; and it cannot with any propriety be said to reproduce these past sensations, for they never had the individuality which such reproduction implies. Nor does it associate with images like itself, since where there is association there must first have been distinctness, and what can be associated can also, for some good time at least, be dissociated.

19. To treat of the localization of impressions is really to give an account of the steps by which the psychological **Localization of Impressions.** individual comes to a knowledge of space. At the outset of such an inquiry it seems desirable first of all to make plain what lies within our purview, and what does not, lest we disturb the peace of those who, confounding philosophy and psychology, are ever eager to fight for or against the a priori character of this element of knowledge. That space is a priori in the epistemological sense it is no concern of the psychologist either to assert or to deny. Psychologically a priori or original in such sense that it has been either actually or potentially an element in all presentation from the very beginning it certainly is not. It will help to make this matter clearer if we distinguish what philosophers frequently confuse, viz. the concrete spatial experiences, constituting actual localization for the individual, and the abstract concept of space, generalized from what is found to be common in such experiences. A gannet's mind "possessed of" a philosopher, if such a conceit may be allowed, would certainly afford its tenant very different spatial experiences from those he might share if he took up his quarters in a mole. So, any one who has revisited in after years a place from which he had been absent since childhood knows how largely a "personal equation," as it were, enters into his spatial perceptions. Or the same truth may be brought home to him if, walking with a friend more athletic than himself, they come upon a ditch, which both know to be twelve feet wide, but which the one feels he can clear by a jump and the other feels he cannot. In the concrete "up" is much more than a different direction from "along." The hen-harrier, which cannot soar, is indifferent to a quarry a hundred feet above it—to which the peregrine, built for soaring, would at once give chase—but is on the alert as soon as it descends prey of the same apparent magnitude, but upon the ground. Similarly, in the concrete, the body is the origin or datum to which all positions are referred, and such positions differ not merely quantitatively but qualitatively. Moreover, our various bodily movements and their combinations constitute a network of co-ordinates, qualitatively distinguishable but geometrically, so to put it, both redundant and incomplete. It is a long way from these facts of perception, which the brutes share with us, to that scientific concept of space as having three dimensions and no qualitative differences which we have elaborated by the aid of thought and language, and which reason may see to be the logical presupposition of what in the order of mental development has chronologically preceded it. That the experience of space is not psychologically original seems obvious—quite apart from any successful explanation of its origin—from the mere consideration of its complexity. Thus we must have a plurality of objects—*A* out of *B*, *B* beside *C*, distant from *D*, and so on; and these relations of externality, juxtaposition, and size or distance imply further specialization; for with a mere plurality of objects we have not straightway spatial differences. Juxtaposition, e.g. is only possible when the related objects form a continuum; but, again, not any continuity is extensive. Now how has this complexity come about?

The first condition of spatial experience seems to lie in what has been noted above (§ 11) as the extensity of sensation. This much we may allow is original; for the longer we reflect the more clearly we see that no combination or association of sensations varying only in intensity and

quality, not even if motor presentations are added, will account for this space-element in our perceptions. A series of touches *a*, *b*, *c*, *d* may be combined with a series of movements *m*₁, *m*₂, *m*₃, *m*₄; both series may be reversed; and finally the touches may be presented simultaneously. In this way we can attain the knowledge of the coexistence of objects that have a certain quasi-distance between them, and such experience is an important element in our perception of space; but it is not the whole of it. For, as has been already remarked by critics of the associationist psychology, we have an experience very similar to this in singing and hearing musical notes or the chromatic scale. The most elaborate attempt to get extensity out of succession and coexistence is that of Herbert Spencer. He has done, perhaps, all that can be done, and only to make it the more plain that the entire procedure is a *ὑστερον πρότερον*. We do not first experience a succession of touches or of retinal excitations by means of movements, and then, when these impressions are simultaneously presented, regard them as extensive, because they are associated with or symbolize the original series of movements; but, before and apart from movement altogether, we experience that massiveness or extensity of impressions in which movements enable us to find positions, and also to measure.¹ But it will be objected, perhaps not without impatience, that this amounts to the monstrous absurdity of making the contents of consciousness extended. The edge of this objection will best be turned by rendering the concept of extensity more precise. Thus, suppose a postage stamp pasted on the back of the hand; we have in consequence a certain sensation. If another be added beside it, the new experience would not be adequately described by merely saying we have a greater quantity of sensation, for intensity involves quantity, and increased intensity is not what is meant. For a sensation of a certain intensity, say a sensation of red, cannot be changed into one having two qualities, red and blue, leaving the intensity unchanged; but with extensity this change is possible. For one of the postage stamps a piece of wet cloth of the same size might be substituted and the massiveness of the compound sensation remain very much the same. Intensity belongs to what may be called graded quantity: it admits of increment or decrement, but is not a sum of parts. Extensity, on the other hand, does imply plurality: we might call it latent or merged plurality or a "ground" of plurality, inasmuch as to say that a single presentation has massiveness is to say that a portion of the presentation-continuum at the moment undifferentiated is capable of differentiation.

Attributing this property of extensity to the presentation-continuum as a whole, we may call the relation of any particular sensation to this larger whole its *local sign*, and can see that, so long as the extensity of a presentation admits of diminution without the presentation becoming nil such presentation either has or may have two or more local signs—its parts, taken separately, though identical in quality and intensity, having a different relation to the whole. Such difference of relation must be regarded fundamentally as a ground or possibility of distinctness of sign—whether as being the ground or possibility of different complexes or otherwise—rather than as being from the beginning such an overt difference as the term "local sign," when used by Lotze, is meant to imply.² From

¹ We are ever in danger of exaggerating the competence of a new discovery; and the associationists seem to have fallen into this mistake, not only in the use they have made of the concept of association in psychology in general, but in the stress they have laid upon the fact of movement when explaining our space-perceptions in particular. Indeed, both ideas have here conspired against them—association in keeping up the notion that we have only to deal with a plurality of discrete impressions, and movement in keeping to the front the idea of sequence. Mill's *Examination of Hamilton* (3rd ed., p. 266 seq.) surely ought to convince us that, unless we are prepared to say, as Mill seems to do, "that the idea of space is at bottom one of time" (p. 276), we must admit the inadequacy of our experience of movement to explain the origin of it.

² To illustrate what is meant by different complexes it will be enough to refer to the psychological implications of the fact that scarcely two portions of the sensitive surface of the human body are anatomically alike. Not only in the distribution and character of

this point of view we may say that more partial presentations are concerned in the sensation corresponding to two stamps than in that corresponding to one. The fact that these partial presentations, though identical in quality and intensity, on the one hand are not wholly identical, and on the other are presented only as a quantity and not as a plurality, is explained by the distinctness along with the continuity of their local signs. Assuming that to every distinguishable part of the body there corresponds a local sign, we may allow that at any moment only a certain portion of this continuum is definitely within the field of consciousness; but no one will maintain that a part of one hand is ever felt as continuous with part of the other or with part of the face. Local signs have thus an invariable relation to each other: two continuous signs are not one day coincident and the next widely separate.¹ This last fact is only implied in the mere massiveness of a sensation in so far as this admits of differentiation into local signs. We have, then, when the differentiation is accomplished, a plurality of presentations constituting an extensive continuum, presented simultaneously, and having certain fixed and invariable relations to each other. Of such experience the typical case is that of passive touch, though the other senses exemplify it. It must be allowed that our concept of space in like manner involves a fixed continuity of positions; but then it involves, further, the possibility of movement. Now in the continuum of local signs there is nothing whatever of this; we might call this continuum an implicit *plenum*. It only becomes the presentation of *occupied space* after its several local signs are complicated in an orderly way with *active* touches, when in fact we have experienced the contrast of movements with contact and movements without, *i.e. in vacuo*. It is quite true that we cannot now think of this plenum except as a space, because we cannot divest ourselves of these motor experiences by which we have explored it. We can, however, form some idea of the difference between the perception of space and this one element in the perception by contrasting massive internal sensations with massive superficial ones, or the general sensation of the body as "an animated organism" with our perception of it as extended. Or we may express the difference by remarking that extension implies the distinction of here and there, while extensity rather suggests ubiquity.

It must seem strange, if this conception of extensity is essential to a psychological theory of space, that it has escaped notice so long. The reason may be that in investigations into the origin of our knowledge of space it was always the *concept* of space and not our concrete space *percepts* that came up for examination. Now in space as we conceive it one position is distinguishable from another solely by its co-ordinates, *i.e.* by the magnitude and signs of certain lines and angles, as referred to a certain datum, position or origin; and these elements our motor experiences seem fully to explain. But on reflection we ought, surely, to be puzzled by the question, how these coexistent positions could be known before those movements were made which constitute them different positions. The link we thus suspect to be missing is supplied by the more concrete experiences we obtain from our own body, in which two positions have a qualitative difference or "local colour" *independently of movement*. True, such positions would not be known as spatial without movement; but neither would the movement be known as spatial had those positions no other difference than such as

the nerve-endings but in the variety of the underlying parts—in one place bone, in another fatty tissue, in others tendons or muscles variously arranged—we find ample ground for diversity in "the local colouring" of sensations. And comparative zoology helps us to see how such diversity has been developed as external impressions and the answering movements have gradually differentiated an organism originally almost homogeneous and symmetrical. Between one point and another on the surface of a sphere there is no ground of difference; but this is no longer true if the sphere revolves round a fixed axis, still less if it also runs in one direction along its axis.

¹ The improvements in the sensibility of our "spatial sense" consequent on practice, its variations under the action of drugs, &c., are obviously no real contradiction to this; on the contrary, such facts are all in favour of making extensity a distinct factor in our space experience and one more fundamental than that of movement.

arises from movement. In a balloon drifting steadily in a fog we should have no more experience of change of position than if it hung becalmed and still.

We may now consider the part which movement plays in elaborating the presentations of this dimensionless continuum into percepts of space. In so doing we must bear in mind that while this continuum implies the *Positional signs*, the incopresentability of two impressions having the same local sign, it allows not only of the presentation of sensations of varying massiveness, but also of a sensation involving the whole continuum *simultaneously*, as in Bain's classic example of the warm bath. As regards the motor element itself, the first point of importance is the incopresentability and invariability of a *successive* series of auxilio-motor or kinaesthetic presentations, P_1, P_2, P_3, P_4 . P_1 cannot be presented along with P_2 , and from P_4 it is impossible to reach P_1 again save through P_3 and P_2 . Such a series, taken alone, could afford us, it is evident, nothing but the knowledge of an invariable sequence of impressions which it was in our own power to produce. Calling the series of P 's "positional signs," the contrast between them and local signs is obvious. Both are invariable, but succession characterizes the one, simultaneity the other; the one yields potential position without place, the other potential place (*τόπος*) without position; hence we call them both merely signs.² But in the course of the movements necessary to the exploration of the body—probably our earliest lesson in spatial perception—these positional signs receive a new significance from the active and passive touches that accompany them, just as they impart to these last a significance they could never have alone.

It is only in the resulting complex that we have the presentations of actual position and of spatial magnitude. For space, though conceived as a coexistent continuum, excludes the notion of omnipresence or ubiquity; two positions l_d and l_e must coexist, but they are not strictly distinct positions so long as we conceive ourselves present in the same sense in both. But, if F_d and F_e are, *e.g.* two impressions produced by compass points touching two different spots as l_d and l_e on the hand or arm, and we place a finger upon l_d and move it to l_e , experiencing thereby the series P_1, P_2, P_3, P_4 , this series constitutes l_d and l_e into positions and also involves F_d and F_e with a relation not of mere distinctness as *τόποι* but of definite distance. The resulting complex perhaps admits of symbolization as follows:—

$$\begin{array}{c} \dots F_d F_e F_e F_d F_e F_e F_e F_e F_e \dots \\ T \quad l \quad l \quad l \\ P_1 p_2 p_3 p_4 \end{array}$$

Here the first line represents a portion of the tactual continuum, F_d and F_e being distinct "feels," if we may so say, or passive touches presented along with the fainter sensations of the continuum as a whole, which the general "body-sense" involves; T stands for the active touch of the exploring finger and P_1 for the corresponding kinaesthetic sensation regarded as "positional sign"; the rest of the succession, as not actually present at this stage but capable of revival from past explorations, is symbolized by the $l \quad l \quad l$ and $p_2 p_3 p_4$.

When the series of movements is accompanied by active touches without passive there arises the distinction between one's own body and foreign bodies; when the initial movement of a series is accompanied by both active and passive touches, the final movement by active touches only, and the intermediate movements are unaccompanied by either, we get the further presentation of empty space lying between us and them—but only when by frequent experience of contacts along with those intermediate movements we have come to know all movement as not only succession but change of position. Thus active touches come at length to be projected, passive touches alone being localized in the stricter sense. But in actual fact, of course, the localization of one impression is not perfected before that of another is begun, and we must take care lest our necessarily meagre exposition give rise to the mistaken notion

² Thus a place may be known topographically without its position being known geographically, and vice versa.

that localizing an impression consists wholly and solely in performing or imaging the particular movements necessary to add active touches to a group of passive impressions. That this cannot suffice is evident merely from the consideration that a single position out of relation to all other positions is a contradiction. Localization, though it depends on many special experiences of the kind described, is not like an artificial product which is completed a part at a time, but is essentially a growth, its several constituents advancing together in definiteness and interconnexion. So far has this development advanced that we do not even imagine the special movements which the localization of an impression implies, that is to say, they are no longer distinctly represented as they would be if we definitely intended to make them: the past experiences are "retained," but too much blended in the mere perception to be appropriately spoken of as remembered or imaged.

A propos of this almost instinctive character of even our earliest spatial percepts it will be appropriate to animadvert on a misleading implication in the current use of such terms as "localization," "projection," "bodily reference," "spatial reference" and the like. The implication is that external space, or the body as extended, is in some sort presented or supposed apart from the localization, projection or reference of impressions to such space. That it may be possible to put a book in its place on a shelf there must be (1) the book, and (2), distinct and apart from it, the place on the shelf. But in the evolution of our spatial experience impressions and positions are not thus presented apart. We can have, or at least we can suppose, an impression which is recognized without being localized as has been already said; but if it is localized this means that a more complex presentation is formed by the addition of new elements, not that a second distinct object is presented and some indescribable connexion established between the impression and it, still less that the impression is referred to something not strictly presented at all. The truth is that the body as extended is from the psychological point of view not perceived at all apart from localized impressions. In like manner impressions projected (or the absence of impressions projected) constitute all that is perceived as the occupied (or unoccupied) space beyond. It is not till a much later stage, after many varying experiences of different impressions similarly localized or projected, that even the mere materials are present for the formation of such an abstract concept of space as "spatial reference" implies.¹ Psychologists, being themselves at this later stage, are apt to commit the oversight of introducing it into the earlier stage which they have to expound.

20. In a complex percept, such as that of an orange or a piece of wax, may be distinguished the following points concerning which psychology may be expected to give an account: (a) the object's reality, (b) its solidity or occupation of space, (c) its unity and complexity, (d) its permanence, or rather its continuity in time and (e) its substantiality and the connexion of its attributes and powers. Though, in fact, these items are most intimately blended, our exposition will be clearer if we consider each for a moment apart.

a. The terms actuality and reality have each more than one meaning. Thus what is real, in the sense of material, is opposed to what is mental; as the existent or actual it is opposed to the non-existent; and again, what is actual is distinguished from what is possible or necessary. But here both terms, with a certain shade of difference, in so far as actual is more appropriate to movements and events, are used, in antithesis to whatever is ideal or represented, for what is sense-given or presented. This seems at least their primary psychological meaning; and it is the one most in vogue in English philosophy at any rate, over-tinged as that is with psychology.² Any examination of this characteristic will be best deferred till we come to deal with ideation generally (see § 21 below).

Meanwhile it may suffice to remark that reality or actuality is not a single distinct element added to the others which enter into the complex presentation we call a thing, ¹ Cf. on this point Poincaré, *La Science et l'hypothèse*, pp. 74 sqq.

² Thus Locke says, "Our simple ideas [i.e. presentations or impressions, as we should now say] are all real... and not fictions at pleasure; for the mind... can make to itself no simple idea more than what it has received" (*Essay*, ii. 30, 2). And Berkeley says, "The ideas imprinted on the senses by the Author of Nature are called *real things*; and those excited in the imagination, being less regular, vivid and constant, are more properly termed *ideas* or *images of things*, which they copy or represent" (*Prin. of Hum. Know.*, pt. i. § 33).

as colour or solidity may be. Neither is it a special relation among these elements, like that of substance and attribute, for example. In these respects the real and the ideal, the actual and the possible, are alike; all the elements or qualities within the complex, and all the relations of those elements to each other, are the same in the rose represented as in the presented rose. The difference turns not upon what these elements are, regarded as qualities or relations presented or represented, but upon whatever it is that distinguishes the presentation from the representation of any given qualities or relations. Now this distinction, as we shall see, depends partly upon the relation of such complex presentation to other presentations in consciousness with it, partly upon its relation as a presentation to the subject whose presentation it is. In this respect we find a difference, not only between the simple qualities, such as cold, hard, red and sweet in strawberry ice, e.g. as presented and as represented, but also, though less conspicuously, in the spatial, and even the temporal, relations which enter into our intuition as distinct from our imagination of it. So then, reality or actuality is not strictly an item by itself, but a characteristic of all the items that follow.

b. In the so-called physical solidity or impenetrability of things our properly motor presentations or "feelings of effort or innervation" come specially into play. They are not entirely absent in those movements of ^{Impenetrability.} exploration by which we attain a knowledge of space; but it is when these movements are definitely resisted, or are only possible by increased effort, that we reach the full meaning of body as that which occupies space. Heat and cold, light and sound, the natural man regards as real, and by and by perhaps as due to the powers of things known or unknown, but not as themselves things. At the outset things are all corporeal like his own body, the first and archetypal thing, that is to say: things are intuited only when touch is accompanied by pressure; and, though at a later stage passive touch without pressure may suffice, this is only because pressures depending on a subjective initiative, i.e. on voluntary muscular exertion, have been previously experienced. It is of more than psychological interest to remark how the primordial factor in materiality is thus due to the projection of a subjectively determined reaction to that action of a not-self of which sense-impressions consist—an action of the not-self which, of course, is not known as such till this projection of the subjective reaction has taken place. Still we must remember that accompanying sense-impressions are a condition of its projection: muscular effort without simultaneous sensations of contact would not yield the distinct presentation of something resistant occupying the space into which we have moved and would move again. Nay more, it is in the highest degree an essential circumstance in this experience that muscular effort, though subjectively initiated, is still only possible when there is contact with something that, as it seems, is making an effort the counterpart of our own. But this something is so far no more than thing-stuff; without the elements next to be considered our psychological individual would fall short of the complete intuition of distinct things.

c. The remaining important factors in the psychological constitution of things might be described in general terms as the time-relations of their components. Such relations are themselves in no way psychologically deter- ^{Unity and Complexity.} mined; impressions recur with a certain order or want of order quite independently of the subject's interest or of any psychological principles of synthesis or association whatever. It is essential that impressions should recur, and recur as they have previously occurred, if knowledge is ever to begin; out of a continual chaos of sensation, all matter and no form, such as some philosophers describe, nothing but chaos could result. But a flux of impressions having this real or sense-given order will not suffice; there must be also attention to and retention of the order, and these indispensable processes at least are psychological.

But for its familiarity we should marvel at the fact that out of the variety of impressions simultaneously presented we do

not instantly group together all the sounds and all the colours, all the touches and all the smells; but, dividing what is given together, single out a certain sound or smell as belonging together with a certain colour and feel, similarly singled out from the rest, to what we call one thing. We might wonder, too—those at least who have made so much of association by similarity ought to wonder—that, say, the white of snow calls up directly, not other shades of white or other colours, but the expectation of cold or of powdery softness. The first step in this process has been the simultaneous projection into the same occupied space of the several impressions which we thus come to regard as the qualities of the body filling it. Yet such simultaneous and coincident projection would avail but little unless the constituent impressions were again and again repeated in like order so as to prompt anew the same grouping, and unless, further, this constancy in the one group was present along with changes in other groups and in the general field. There is nothing in its first experience to tell the infant that the song of the bird does not inhere in the hawthorn whence the notes proceed, but that the fragrance of the mayflower does. It is only where a group, as a whole, has been found to change its position relatively to other groups, and—apart from casual relations—to be independent of changes of position among them, that such complexes can become distinct unities and yield a world of things. Again, because things are so often a world within themselves, their several parts or members not only having distinguishing qualities but moving and changing with more or less independence of the rest, it comes about that what is from one point of view one thing becomes from another point of view several—like a tree with its separable branches and fruits, for example. Wherein then, more precisely, does the unity of a thing consist? This question, so far as it here admits of answer, carries us over to temporal continuity.

d. Amidst all the change above described there is one thing comparatively fixed: our own body is both constant as a group and a constant item in every field of groups; and not only so, but it is beyond all other things an object of continual and peculiar interest, inasmuch as our earliest pleasures and pains depend solely upon it and what affects it. The body becomes, in fact, the earliest form of self, the first datum for our later conceptions of permanence and individuality. A continuity like that of self is then transferred to other bodies which resemble our own, so far as our direct experience goes, in passing continuously from place to place and undergoing only partial and gradual changes of form and quality. As we have existed—or, more exactly, as the body has been continuously presented—during the interval between two encounters with some other recognized body, so this is regarded as having continuously existed during its absence from us. However permanent we suppose the conscious subject to be, it is hard to see how, without the continuous presentation to it of such a group as the bodily self, we should ever be prompted to resolve the discontinuous presentations of external things into a continuity of existence. It might be said: Since the second presentation of a particular group would, by the mere workings of psychical laws, coalesce with the image of the first, this coalescence would suffice to “generate” the concept of continued existence. But such assimilation is only the ground of an intellectual identification and furnishes no motive, one way or the other, for real identification: between a second presentation of A and the presentation at different times of two A's there is so far no difference. Real identity no more involves exact similarity than exact similarity involves sameness of things; on the contrary, we are wont to find the same thing alter with time, so that exact similarity after an interval, so far from suggesting one thing, is often the surest proof that there are two concerned. Of such real identity, then, it would seem we must have direct experience; and we have it in the continuous presentation of the bodily self; apart from this it could not be “generated” by association among changing presentations. Other bodies being in the first instance personified, that then is regarded as one thing—from whatever point of view

we look at it, whether as part of a larger thing or as itself compounded of such parts—which has had one beginning in time. But what is it that has thus a beginning and continues indefinitely? This leads to our last point.

e. So far we have been concerned only with the combination of sensory and motor presentations into groups and with the differentiation of group from group; the relations to each other of the constituents of each group still **Substantiality.** for the most part remain. To these relations in the main must be referred the correlative concepts of substance and attribute, the distinction in substances of qualities and powers, of primary qualities and secondary, and the like.¹

Of all the constituents of things only one is universally present, that above described as physical solidity, which presents itself according to circumstances as impenetrability, resistance or weight. Things differing in temperature, colour, taste and smell agree in resisting compression, in filling space. Because of this quality we regard the wind as a thing, though it has neither shape nor colour, while a shadow, though it has both but not resistance, is the very type of nothingness. This constituent is invariable, while other qualities are either absent or change—form altering, colour disappearing with light, sound and smells intermitting. Many of the other qualities—colour, temperature, sound, smell—increase in intensity if we advance till we touch a body occupying space; with the same movement too its visual magnitude varies. At the moment of contact an unvarying tactual magnitude is ascertained, while the other qualities and the visual magnitude reach a fixed maximum; then first it becomes possible by effort to change or attempt to change the position and form of what we apprehend. This tangible plenum we thenceforth regard as the seat and source of all the qualities we project into it. In other words, that which occupies space is psychologically the substantial; the other real constituents are but its properties or attributes, the marks or manifestations which lead us to expect its presence.

Imagination or Ideation.²

21. Before the intuition of things has reached a stage so complete and definite as that just described, imagination or ideation as distinct from perception has well begun. In passing to the consideration of this higher form of **Impressions and Ideas.** mental life we must endeavour first of all analytically to distinguish the two as precisely as may be and then to trace the gradual development of the higher.

To begin, it is very questionable whether Hume was right in applying Locke's distinction of simple and complex to ideas in the narrower sense as well as to impressions. “That idea of red,” says Hume, “which we form in the dark and that impression which strikes our eyes in the sunshine differ only in degree, not in nature.”³ But what he seems to have overlooked is that, whereas we may have a mere sensation red, we can only have an image or representation of a red *thing* or a red *form*, *i.e.* of red in some way ideally projected or intuited. In other words, there are no ideas—though there are concepts—answering to simple or isolated impressions. The synthesis which has taken place in the evolution of the percept can only partially fail in the idea, and never so far as to leave us with a chaotic “manifold” of mere sensational remnants. On the contrary, we find that in “constructive imagination” a new kind of effort is often requisite in order partially to dissociate these representational complexes as a preliminary to new combinations. But it is doubtful whether the results of such an analysis are ever the ultimate elements of the percept, that is, merely isolated impressions in a fainter form. We may now try to ascertain further the characteristic marks which distinguish what is imaged from what is perceived.

¹ The distinction between the thing and its properties is one that might be more fully treated under the head of “Thought and Conception.” Still, inasmuch as the material warrant for these concepts is contained more or less implicitly in our percepts, some consideration of it is in place here.

² Ideation—“a word of my own coining,” says James Mill.

³ *Treatise of Human Nature*, bk. i. pt. i. § 1.

The most obvious difference is that which Hume called "the force or liveliness" of primary presentations as compared with secondary presentations. But what exactly are we to understand by this somewhat figurative language? A simple difference of intensity cannot be all that is meant, for—though we may be momentarily confused—we can perfectly well distinguish the faintest impression from an image; moreover, we can reproduce such faintest impressions in idea. The whole subject of the intensity of representations awaits investigation. Between moonlight and sunlight or between midday and dawn we can discriminate many grades of intensity; but it does not appear that there is any corresponding variation of intensity between them when they are not seen but imagined. Many persons suppose they can imagine a waxing or a waning sound or the gradual abatement of an intense pain; but what really happens in such cases is probably not a rise and fall in the intensity of a single representation, but a change in the complex represented. In the primary presentation there has been a change of quality along with change of intensity, and not only so, but most frequently a change in the muscular adaptations of the sense-organs too, to say nothing of organic sensations accompanying these changes. A representation of some or all of these attendants is perhaps what takes place when variations of intensity are supposed to be reproduced. Again, hallucinations are often described as abnormally intense images which simply, by reason of their intensity, are mistaken for percepts. But such statement, though supported by very high authority, is almost certainly false, and would probably never have been made if physiological and epistemological considerations had been excluded as they ought to have been. Hallucinations, when carefully examined, seem just as much as percepts to contain among their constituents some primary presentation—either a so-called subjective sensation of sight and hearing or some organic sensation due to deranged circulation or secretion. Intensity alone, then, will not suffice to discriminate between impressions and images.

What we may call superior steadiness is perhaps a more constant and not less striking characteristic of percepts. Ideas are not only in a continual flux, but even when we attempt forcibly to detain one it varies continually in clearness and completeness, reminding one of nothing so much as of the illuminated devices made of gas jets, common at fêtes, when the wind sweeps across them, momentarily obliterating one part and at the same time intensifying another. There is not this perpetual flow and flicker in what we perceive. The impressions entering consciousness at any one moment are psychologically independent of each other; they are equally independent of the impressions and images presented the moment before—independent, *i.e.* as regards their order and character, not, of course, as regards the share of attention they secure. Attention to be concentrated in one direction must be withdrawn from another, and images may absorb it to the exclusion of impressions as readily as a first impression to the exclusion of a second. But, when attention is secured, a faint impression has a fixity and definiteness lacking in the case of even vivid ideas. One ground for this definiteness and independence lies in the localization or projection which accompanies all perception. But why, if so, it might be asked, do we not confound percept and image when what we imagine is imagined as definitely localized and projected? Because we have a contrary percept to give the image the lie; where this fails, as in dreams, or where, as in hallucination, the image obtains in other ways the fixity characteristic of impressions, such confusion does in fact result. But in normal waking life we have the whole presentation-continuum, as it were, occupied and in operation: we are distinctly conscious of being embodied and having our senses about us.

But how is this contrariety between impression and image possible? With eyes wide open, and while clearly aware of the actual field of sight and its filling, one can recall or imagine a wholly different scene: lying warm in bed one can imagine oneself out walking in the cold. It is useless to say the times are different, that what is perceived is present and what is imagined

is past or future.¹ The images, it is true, have certain temporal marks—of which more presently—by which they may be referred to what is past or future; but as imaged they *are* present, and, as we have just observed, are regarded as actual whenever there are no correcting impressions. We cannot at once see the sky red and blue; how is it we can imagine it the one while perceiving it to be the other? When we attempt to make the field of sight at once red and blue, as in looking through red glass with one eye and through blue glass with the other, either the colours merge and we see a purple sky or we see the sky first of the one colour and then of the other in irregular alternation. That this does not happen between impression and image shows that, whatever their connexion, images as a whole are distinct from the presentation-continuum and cannot with strict propriety be spoken of as revived or reproduced impressions. This difference is manifest in another respect, *viz.* when we compare the effects of diffusion in the two cases. An increase in the intensity of a sensation of touch entails an increase in the extensity; an increase of muscular innervation entails irradiation to adjacent muscles; but when a particular idea becomes clearer and more distinct, there rises into consciousness an associated idea qualitatively related probably to impressions of quite another class, as when the smell of tar calls up memories of the sea-beach and fishing-boats. Since images are thus distinct from impressions, and yet so far continuous with each other as to form a train in itself unbroken, we should be justified, if it were convenient, in speaking of images as changes in a new continuum; and later on we may see that this is convenient.

Impressions then—unlike ideas—have no associates to whose presence their own is accommodated and on whose intensity their own depends. Each bids independently for attention, so that often a state of distraction ensues, such as the train of ideas left to itself never occasions. The better to hear we listen; the better to see we look; to smell better we dilate the nostrils and sniff; and so with all the special senses: each sensory impression sets up nascent movements for its better reception.² In like manner there is also a characteristic adjustment for images which can be distinguished from sensory adjustments almost as readily as these are distinguished from each other. We become most aware of this as, *mutatis mutandis*, we do of them, when we voluntarily concentrate attention upon particular ideas instead of remaining mere passive spectators, as it were, of the general procession. To this ideational adjustment may be referred most of the strain and "head-splitting" connected with recollecting, reflecting and all that people call headwork; and the "absent look" of one intently thinking or absorbed in reverie seems directly due to the absence of sensory adjustment that accompanies the concentration of attention upon ideas.

22. But, distinct as they are, impressions and images are still closely connected. In the first place, there are two or three well-marked intermediate stages, so that, though we cannot directly observe it, we seem justified in assuming a steady transition from the one to the other. As the first of such intermediate stages, it is usual to reckon what are often, and—so far as psychology goes—inaccurately, styled after-images. They would be better described as after-sensations, inasmuch as they are due either (1) to the persistence of the original peripheral excitation after the stimulus is withdrawn, or (2) to the effects of the exhaustion or the repair that immediately follows this excitation. In the former case they are qualitatively identical with the original sensation and are called "positive," in the latter they are complementary to it and are called "negative" (see VISION). These last, then, of which we have clear instances only in connexion with sight, are obviously in no

¹ Moreover, as we shall see, the distinction between present and past or future psychologically presupposes the contrast of impression and image.

² Organic sensations, though distinguishable from images by their definite though often anatomically inaccurate localization, furnish no clear evidence of such adaptations. But in another respect they are still more clearly marked off from images, *viz.* by the pleasure or pain they directly occasion.

sort re-presentations of the original impression, but a sequent presentation of diametrically opposite quality; while positive after-sensations are, psychologically regarded, nothing but the original sensations in a state of evanescence. It is this continuance and gradual waning after the physical stimulus has completely ceased that give after-sensations their chief title to a place in the transition from impression to image. There is, however, another point: after-sensations are less affected by movement than impressions are. If we turn away our eyes we cease to see the flame at which we have been looking, but the after-image remains still projected before us and continues localized in the dark field of sight, even if we close our eyes altogether. This fact that movements do not suppress them, and the fact that yet we are distinctly aware of our sense-organs being concerned in their presentation, serve to mark off after-sensations as intermediate between primary and secondary presentations. The after-sensation is in reality more elementary than either the preceding percept or its image. In both these, in the case of sight, objects appear in space of three dimensions, *i.e.* with all the marks of solidity and perspective;¹ but the so-called after-image lacks all these.

Still further removed from normal sensations (*i.e.* sensations determined by the stimuli appropriate to the sense-organ) are the "recurrent sensations" often unnoticed but probably experienced more or less frequently by everybody—cases, that is, in which sights or sounds, usually such as at the time were engrossing and impressive, suddenly reappear several hours or even days after the physical stimuli, as well as their effects on the terminal sense-organ, seem entirely to have ceased. Thus workers with the microscope often see objects which they have examined during the day stand out clearly before them in the dark; it was indeed precisely such an experience that led the anatomist Henle first to call attention to these facts. But he and others have wrongly referred them to what he called a "sense-memory"; all that we know is against the supposition that the eye or the ear has any power to retain and reproduce percepts. "Recurrent sensations" have all the marks of percepts which after-sensations lack; they only differ from what are more strictly called "hallucinations" in being independent of all subjective suggestion determined by emotion or mental derangement.

In what Fechner has called the "memory after-image" or the primary memory-image, as it is better termed, we have the image proper in its earliest form. As an instance of what is meant may be cited the familiar experience that a knock at the door, the hour struck on the clock, the face of a friend whom we have passed unnoticed, may sometimes be recognized a few minutes later by means of the persisting image, although—apparently—the actual impression was entirely disregarded. But in vision the primary memory-image can always be obtained, and is obtained to most advantage, by looking intently at some object for an instant and then closing the eyes or turning them away. The image of the object will appear for a moment very vividly and distinctly, and can be so recovered several times in succession by an effort of attention. Such reinstatement is materially helped by rapidly opening and closing the eyes, or by suddenly moving them in any way. In this respect a primary memory-image resembles an after-sensation, which can be repeatedly revived in this manner when it would otherwise have disappeared. This seems to show that the primary memory-image in such cases

¹ The following scant quotation from Fechner, one of the best observers in this department, must suffice in illustration. "Lying awake in the early morning after daybreak, with my eyes motionless though open, there usually appears, when I chance to close them for a moment, the black after-image of the white bed immediately before me and the white after-image of the black stove-pipe some distance away against the opposite wall. . . . Both [after images] appear as if they were in juxtaposition in the same plane; and, though—when my eyes are open—I seem to see the white bed in its entire length, the after-image—when my eyes are shut—presents instead only a narrow black stripe owing to the fact that the bed is seen considerably foreshortened. But the memory-image on the other hand completely reproduces the pictorial illusion as it appears when the eyes are open" (*Elemente der Psychophysik*, ii. 473).

owes its vivacity in part to a positive after-sensation; at any rate it proves that it is in some way still sense-sustained. But in other respects the two are very different: the after-sensation is necessarily presented if the intensity of the original excitation suffices for its production, and cannot be presented otherwise, however much we attend. Moreover, the after-sensation is only for a moment positive, and then passes into the negative or complementary phase, when, so far from even contributing towards the continuance of the original percept, it directly hinders it. Primary memory-images on the other hand, and indeed all images, depend mainly upon the attention given to the impression; provided that was sufficient, the faintest impression may be long retained, and without it very intense ones will soon leave no trace. The primary memory-image retains so much of its original definiteness and intensity as to make it possible with great accuracy to compare two physical phenomena, one of which is in this way "remembered" while the other is really present. For the most part this is indeed a more accurate procedure than that of dealing with both together, but it is only possible for a very short time. From Weber's experiments with weights and lines² it would appear that even after 100 seconds a considerable waning has taken place, and after 100 seconds all that is distinctive of the primary image has probably ceased.

On the whole, then, it appears that the ordinary memory-image is a joint effect; it is not the mere residuum of changes in the presentation-continuum, but an effect of these only when there has been some concentration of attention upon them. It has the form of a percept, but is not constituted of revived *impressions*, for the essential marks of impressions are absent; there is no localization in, or projection into, external space, neither is there the motor adaptation, nor the tone of feeling, incident to the reception of impressions. Ideas do not reproduce the intensity of these original constituents, but only their quality and complication. What we call the vividness of an idea is of the nature of intensity, but it is an intensity very partially and indirectly determined by that of the original impression; it depends much more upon the state of what we shall call the memory-continuum and the attention the idea receives. The range of vividness in ideas is probably comparatively small; what are called variations in vividness are often really variations in distinctness and completeness.³ Where we have great intensity, as in hallucinations, primary presentations may be reasonably supposed to enter into the complex.

It is manifest that the memory-continuum has been in some way formed out of or differentiated from the presentation-continuum by the movements of attention, but the precise connexion of the two continua is still very difficult to determine. We see perhaps the first distinct step of this evolution in the primary memory-image: here there has been no cessation in presentation, and yet the characteristic marks of the impression are gone, so much so, indeed, that superposition without "fusion" with an exactly similar impression is possible. We have now to inquire into the genesis and development of ideation.

Genesis and Development of Ideation.

23. We find ourselves sometimes engrossed in present perceptions, as when tracing, for example, the meanderings of an ant; at other times we may be equally absorbed in reminiscences; or, again, in pure reverie and "castle-building." Here are three well-marked forms of conscious life: the first being concerned with what is, the second with what has been, and the third with the merely possible. Again, the first involves definite spatial and temporal order, though the temporal order, as just said, is in the main restricted to the "sensible present"; the second involves only definite time-order; and the last neither in a definite way. Thus, analytically regarded, perception, memory, imagination, show a steady advance. In infancy the first

² *Die Lehre vom Tastsinne*, &c., pp. 86 seq.

³ As we have seen that there is a steady transition from percept to image, so, if space allowed, the study of hallucinations might make clear an opposite and abnormal process—the passage, that is to say, of images into percepts, for such, to all intents and purposes, are hallucinations of perception, psychologically regarded.

predominates, while senility lapses back to the second; in the third, where similarities suggest themselves and the contrast of actual and possible is explicit, we have at length the groundwork of logical comparison. Nevertheless, since imagination plays a conspicuous part in child life before much personal reminiscence appears, it would seem probable that ideas do not first arise as definite memory-images or reminiscences. On the other hand, in the so-called homing instincts of the lower animals we have evidence of isolated "memories" of a simpler form than ours.

The subject is as difficult as it is interesting and important, and we can hardly hope at present for a final solution. One chief obstacle, as is so often the case in psychology, lies in the unsettled connotation of such leading terms as *memory*, *association* and *idea*. Even what is most fundamental of all, that "plasticity" which we have analysed into retentiveness, differentiation and integration, is sometimes described as if it already involved memory-ideas and their association. Ideas, that is to say, are identified with mere "residua" of former "impressions," and yet at the same time are spoken of as "copies" of these: which is much like saying the evening twilight is a *replica* of the noonday glare as well as its parting gleam. Again, the continuous differentiation and reintegration of the presentational continuum which mark the progress of perceptual experience are resolved into an original multiplicity of presentational atoms which are associated by "adhesion" of the contiguous. Yet before the differentiation there was no plurality, and after the integration there is only a complex unity, comparable perhaps with another organic whole, but certainly not with a mosaic stuck together with cement. This mistaken identification by the Associationist psychology of later processes with simpler and earlier ones, by which they are only partially explained, has not only obscured the science with inappropriate concepts but has prevented the question on which we are entering—that concerning the genesis and development of ideas—from being ever effectually raised. The discussion of this question will incidentally yield the best refutation of those views.

Experience, we say, is the acquisition of practical acquaintance and efficiency as the result of repeated opportunity and effort. This means that strangeness on the cognitive side gives place to familiarity, and that on the active side clumsiness is superseded by skill. But though analytically distinct, the two sides are, as we have already insisted, actually inseparable: to the uninteresting we are indifferent, and what does not call for active response is ignored. If the original presentations whether sensory or motor, be A, B, C, we find then that they gradually acquire a new character, become, let us say, A γ , B γ , C γ , γ representing the eventual familiarity or facility, as the case may be. We find, again, a certain sameness in this character, however various the presentations to which it pertains, a sameness which points to the presence of subjective constituents, and to these we may assign the "feelings" that enter into accommodation and adjustment. This factor is important as evidence of a subjective co-operation which may enable us to dispense with the mutual "adhesions" and "attractions" among presentations, on which the Associationists rely. But it is obvious that there must be an objective factor as well; and it is this objective factor in the process giving rise to γ that now primarily concerns us. We have described that process as assimilation or immediate recognition: the older psychology described it as association of the completely similar, or as automatic association. That the two views have something in common is shown by the juxtaposition of "automatic" and "immediate," "similarity" and "assimilation." To prepare the way for further discussion, let us first ascertain these points of agreement. "When I look at the full moon," said Bain, "I am instantly impressed with the state arising from all my former impressions of her disc added together." This we may symbolize in the usual fashion as $A + a_n \dots + a_1 + a_2 + a_1$. Now, it will be granted (1) that the present occurrence (full moon) has been preceded by a series of like occurrences, enumerable as 1, 2, 3, \dots , n ; (2) that the present experience (A γ) is what it is in consequence of the preceding experiences of these occurrences; and (3) that it "arises instantly" as the joint result of such preceding experiences. But it is denied (1) that this present experience is the mere sum, or even the mere "fusion," of the experiences preceding it; (2) that they were qualitatively identical; (3) that they persist severally unaltered, in such wise that experience "drags at each remove a lengthening chain"

of them. In the case of dexterities, where γ answers to facility, it is obvious that there is no such series of identicals (a_1, a_2, \dots, a_n) at all. From the first rude beginning—say the school-boy's pothooks—up to the finished performance of the adept there is continuous approximation: awkward and bungling attempts, passing gradually into the bold strokes of mastery. Nor is the case essentially different in cognition where γ answers to familiarity; if we attend, as it is plain we ought, not to the physical fact cognized, but to the individual's perception of it. This, too, is an acquisition, has entailed activity, and is marked by gradual approximation towards clearness and distinctness. The successive experiences of n identical occurrences does not then result in an accumulation of n identical *residua*. The ineptness of the atomistic psychology with its "physical" and "chemical" analysis is nowhere more apparent than here. Considering the intimate relation of life and mind, and the strong physiological bias shown by the Associationists from Hartley onwards, it is surely extraordinary how completely they have failed to appreciate the light-bearing significance of such concepts as function and development. Facility and faculty (or function) are much the same, both etymologically and actually. As the perfected structure is not so many rudimentary structures "added together," but something that supersedes them completely, must we not say the same of the perfected function? The less fit is not embodied in the fittest that finally survives. Development implies change of form in a continuous whole: every growth *into* means an equal growth *out of*: thus one cannot find the caterpillar in the butterfly. Between organic development and mental development there is then more than an analogy.

But though assimilation cannot be analysed into a series of identical ideas (a_1, a_2, \dots, a_n), either "added together" or "instantaneously fused," yet it does result in an a which may *provisionally* be called an idea. Such idea is, however, neither a memory-idea in the proper sense nor an idea within the meaning of the term implied in imagination or ideation. For it is devoid of the temporal signs¹ indicated by the subscript numerals in a_1, a_2, \dots , and it does not yet admit of reproduction as part of an ideational continuum, one, that is, divested of the characteristics belonging to the actual and sensibly present. It is, so to say, embryonic, something additional to the mere sensation assimilated, and yet something less than a "free or independent idea." It is, as it has been happily called,² a tied (*gebundene*) or implicit idea. We have clear evidence of the sense-bound stage of this immature "idea" in the so-called "memory after-image" (cf. § 22). There is, however, nothing in this of memory, save as the term is loosely used for mere retentiveness; and *after-percept* would therefore be a less objectionable name for it. This after-percept is entirely sense-sustained and admits of no ideal recall, though—in *minds sufficiently advanced*—it may persist for a few moments, and so form the basis of such comparison with a second sensation, as we find in the experiments of Weber, Fechner and others.³ At a still lower level, or in actual perception, we cannot assume even this amount of partial independence, though continuity clearly points to something beyond the bare sensation, which is a pure abstraction, as we may presently see.

It is saying too little to maintain, as some do, that this "something" is subconscious, on the ground that it is not discoverable by direct analysis. Yet it is saying too much, regardless of this defect, to describe a percept as a presentative-representative

¹ On this term cf. below, §§ 24, 28.

² Cf. Drobisch, *Empirische Psychologie* (1842), § 31; Höfding, "Ueber Wiederkennen, Association und psychische Activität," in *Vierteljahrsschr. f. wissenschaftl. Philosophie*, Bd. xiii. and xiv. To Höfding we are also indebted for the term *Bekanntheitsqualität*, which has suggested the γ character used above. Cf. also Ward, "Assimilation and Association," *Mind* (1894-1895).

³ Recent experiments, however, seem to prove that the after-percept is not the sole factor, and often is not a factor at all in such successive comparison (so-called); but that what is now termed "the absolute impression" may supplement it or even replace it altogether. As to what is meant by absolute impression, cf. § 14, c.

complex, if representation is to imply the presence of a free or independent idea. To call this "something" a tied or nascent idea on the ground of its possible later development into an independent representation seems, then, nearest the truth. The same meaning is sometimes expressed in a wholly different and designedly paradoxical way, by saying that all cognition (perception) is *recognition*. This statement has been met by elaborate expositions of the difference between knowing and knowing *again*, the irrelevance of which any lexicon would show; and, further, by the demand: How on such a view is a *first* cognition possible, or how is an indefinite regress of assimilation to be avoided? We may confidently reply that it cannot be avoided: an absolute beginning of experience, whether phylogenetically or ontogenetically, is beyond us. Assimilation means further assimilation; in this sense all cognition is further cognition, and a bare sensation is, as said, an abstraction representing a limit to which we can never regress.

We find evidence, again, of ideas in the making in what Lewes called preperception. Of this instances in plenty are furnished by everyday illusions, as when a scarecrow is hailed by the traveller who mistakes it for a husbandman, or when what is taken for an orange proves to be but an imitation in wax. In reality all complex percepts involve preperception; and, so far, it must be allowed that such percepts are directly analysable into presentative-representative complexes. Nevertheless, the representative element is not yet, and may never become, an idea proper. The sight of ice yields a forefeel of its coldness, the smell of baked meats a foretaste of their savour. Such prepercepts differ from free ideas just as after-percepts do: they are still sense-bound and sense-sustained. Nor can this complication be with any propriety identified either with the association pertaining to memory or with that specially pertaining to ideation; though, no doubt, the two processes—complication and association—are genetically continuous, as are their respective constituents, nascent and free ideas.¹ The whole course of perceptual integration being determined and sustained by subjective interest, involves from the outset, as we have seen, concurrent conative impulses; and thus the same assimilation that results in familiarity and preperception on the subjective side results in facility and purpose on the conative. Knowing immediately *what to do* is here the best evidence of knowing *what there is* to do with; the moth that flies into the candle has assuredly no preperception of it, and does not act with purpose. Bearing this in mind, we may now see one way, and probably the earliest, in which tied ideas become free.

The contrast between the actual and the possible constitutes, as we have seen, the main difference between experience at the perceptual and experience at the ideational stage. A subject confined to the former level knows not yet this difference. Such knowledge is attained, not through any quasi-mechanical interaction of presentations, but usually through bitter experience. The chapter of accidents is the Bible of fools, it has been said; but we are all novices at first, and get wisdom chiefly by the method of trial and failure. Things are not always different in what to us are their essential properties, but they so differ from time to time. Resemblances are frequent enough to give us familiarity and confidence; yet uniformity is flecked by diversity, and thwarted intentions disclose possibilities for which we were not prepared. What was taken for sugar turns out to be salt; what was seized as booty proves to be bait. We catch many Tatars, and so learn wariness in a rough school. In such wise preperceptions displaced by the actual fact yield the "what" severed from the "that," the "ideal" freed at length from the exclusive hold of the real. In a new situation after such adventures the attitude assumed—if, for brevity, we describe it in terms of our own still more advanced experience—is of this sort: "It may be a weasel, if so, I back; it may be a rabbit, if it is, I spring." Instead of unquestioned preperception that "makes

¹ Hence the earlier process has been named "impressional association" (Stout, *Analytic Psychology*, 1896, ii. pp. 27-29), and again "animal association" (Thorndike, *Animal Intelligence, an Experimental Study of the Associative Processes in Animals*, 1898, pp. 71, 87, and *passim*). But it seems preferable to confine the term "association" to the later process, in which alone the component presentations have that amount of distinctness and individuality which the term properly connotes.

the mouth water," we have the alternative possibilities present as "free ideas," and action is in suspense, the alternative courses, that is to say, again present only in idea. It is easy to see how in such situations one free idea, a "what" sundered from its "that," will tend to loosen the sensory ties of alternative, still implicit ideas. On the cognitive side, from immediate assimilation an advance is made towards mediate cognition, towards comparison; on the active side there is advance from impulsive action towards deliberate action.²

We conclude, then, that implicit ideas—the products of assimilation, and integrated as such in complex percepts and the motor co-ordinations to which they lead—are more likely to emerge as free ideas the more this perceptual complexity increases. Perception in the lower animals, who give no signs of either memory or ideation, has apparently no such complexity. A fish, for example, can feel, smell, taste, see, and even hear, but we cannot assume solely on that account that it has any percepts to which its five senses contribute, as they do to our percept, say, of an orange or a peppermint. Taking voluntary movements as the index of psychical life, it would seem that the fish's movements are instigated and guided by its senses, not collectively but separately. Thus a dog-fish, according to Steiner, seeks its food exclusively by scent; so that when its olfactory bulbs are severed, or the fore-brain, in which they end, is destroyed, it ceases to feed spontaneously. The carp, on the other hand, appears to search for its food wholly under the guidance of sight, and continues to do so just as well when the fore-brain is removed, the mid-brain, whence the optic nerves spring, seeming to be the chief seat of what intelligence it has.³ Again, Bateson observes: "There can be no doubt that soles also perceive objects approaching them, for they bury themselves if a stroke at them is made with a landing-net; yet they have no recognition of a worm hanging by a thread immediately over their heads, and will not take it even if it touch them, but continue to feel for it aimlessly on the bottom of the tank, being aware of its presence by the sense of smell."⁴ To this inability to combine simple percepts into one complex percept of a single object or situation we may reasonably attribute the fish's lack of true ideas, and consequent lack of sagacity. The sagacity even of the higher animals does not amount to "general intelligence," such as enables a child "to put two and two together," as we say, whatever "two and two" may stand for. So far as life consists of a series of definite situations and definite acts, so far the things done or dealt with together, the contents of the several *foci* or concentrations of attention, form so many integrated and comparatively isolated wholes. Round the more complicated of these, and closely connected with them, free ideas arise as sporadic groups, making possible those "lucid intervals," those fitful gleams of intelligence in the very heat of action, which occasionally interrupt the prevailing irrationality of the brutes. And as we cannot credit even the higher animals with general trains of ideas, just as little can we credit them with a continuous memory: indeed, it is questionable how far memory of the past, as past, belongs to them at all. For they live entirely in an up-stream, expectant attitude, and it is in this aspect that "free ideas" arise when they arise at all. We cannot imagine a dog regretting, like one of *Punch's* heroes, that he "did not have another slice of that mutton."⁵

The free idea (*a*) then at its first emergence has neither an assignable position in a continuous memory-record, as *a*₁ or *a*₂, nor has it a definite relation as a "generic idea" to possible specializations such as *a'* or *a"*. These further developments bring us to the general consideration of mental association.

² Some light is perhaps here thrown on the reciprocal relation of "association by contrast" and "association by similarity" as severally the differentiation of partial similars and the integration of partial dissimilars.

³ J. Steiner, *Die Functionen des Centralnervensystems u.s.w.*, 2te Abth. Die Fische (1888), pp. 50, 126, 19 seq., 101.

⁴ W. Bateson, "The Sense-Organs and Perceptions of Fishes," *Journ. Marine Biol. Assoc.* (1890), p. 239.

⁵ Cf. Stout, *Manual of Psychology* (1899), vol. ii. ch. i.; also F. H. Bradley, "Memory and Inference," *Mind* (1899), pp. 145 sqq.; and especially Thorndike, *Animal Intelligence*, cited above.

Mental Association and the Memory-Continuum.

24. Great confusion has been occasioned, as we have seen incidentally, by the lax use of the term "association," and this confusion has been increased by a further laxity in the use of the term "association by similarity." In so far as the similarity amounts to identity, as in assimilation, we have a process which is more fundamental than association by contiguity, but then it is not a process of association. And when the reviving presentation is only partially similar to the presentation revived, the nature of the association does not appear to differ from that operative when one "contiguous" presentation revives another. In the one case we have, say, abx recalling aby , and in the other abc recalling def . Now anybody who will reflect must surely see that the similarity between abx and aby , as distinct from the identity of their partial constituent ab , cannot be the means of recall; for this similarity is nothing but the state of mind—to be studied presently—which results when abx and aby , having been recalled are in consciousness together and then compared. But if ab , having concurred with y before and being now present in abx , again revives y , the association, so far as that goes, is manifestly one of contiguity, albeit as soon as the revival is complete, the state of mind immediately incident may be what Bain loved to style "the flash of similarity." So far as the mere revival itself goes, there is no more similarity in this case than there is when abc revives def . For the very abc that now operates as the reviving presentation was obviously never in time contiguous with the def that is revived; if all traces of previous experiences of abc were obliterated there would be no revival. In other words, the abc now present must be "automatically associated," or, as we prefer to say, must be assimilated to those residua of abc which were "contiguous" with def , before the representation of this can occur. And this, and nothing more than this, we have seen, is all the "similarity" that could be at work when abx "brought up" aby .

On the whole, then, we may assume that the only principle of association we have to examine is the so-called *association by contiguity*, which, as ordinarily formulated, runs: Any presentations whatever, which are in consciousness together or in close succession, cohere in such a way that when one recurs it tends to revive the rest, such tendency increasing with the frequency of the conjunction. It has been often contended that any investigation into the nature of association must be fruitless.¹ But, if association is thus a first principle, it ought at least to admit of such a statement as shall remove the necessity for inquiry. So long, however, as we are asked to conceive presentations originally distinct and isolated becoming eventually linked together, we shall naturally feel the need of some explanation of the process, for neither the isolation nor the links are clear—not the isolation, for we can only conceive two presentations separated by other presentations intervening; nor the links, unless these are also presentations, and then the difficulty recurs. But, if for contiguity we substitute continuity and regard the associated presentations as parts of a new continuum, the only important inquiry is how this new whole was first of all integrated.

To ascertain this point we must examine each of the two leading divisions of contiguous association—that of simultaneous presentations and that of presentations occurring in close succession. The last, being the clearer, may be taken first. In a series of associated presentations $ABCDE$, such as the movements made in writing, the words of a poem learned by heart, or the simple letters of the alphabet themselves, we find that each member recalls its successor but not its predecessor. Familiar as this fact is, it is not perhaps easy to explain it satisfactorily. Since C is associated both with B and D , and apparently as intimately with the one as with the other, why does it revive the later only and not the earlier? B recalls C ; why does not C recall B ? We have seen that any

¹ So Hume, *Treatise of Human Nature*, pt. i. § 4 (Green and Grose's ed., p. 321); also Lotze, *Metaphysik*, 1st ed., p. 526.

reproduction at all of B , C or D depends primarily upon its having been the object of special attention, so as to occupy at least momentarily the focus of consciousness. Now we can in the first instance only surmise that the order in which they are reproduced is determined by the order in which they were thus attended to when first presented. The next question is whether the association of objects simultaneously presented can be resolved into an association of objects successively attended to. Whenever we try to recall a scene we saw but for a moment there are always a few traits that recur, the rest being blurred and vague, instead of the whole being revived in equal distinctness or indistinctness. On seeing the same scene a second time our attention is apt to be caught by something unnoticed before, as this has the advantage of novelty; and so on, till we have "lived ourselves into" the whole, which may then admit of simultaneous recall. Bain, who is rightly held to have given the best exposition of the laws of association, admits something very like this in saying that "coexistence is an artificial growth formed from a certain peculiar class of mental successions." But, while it is easy to think of instances in which the associated objects were attended to successively, and we are all perfectly aware that the surest—not to say the only—way to fix the association of a number of objects is by thus concentrating attention on each in turn, it seems hardly possible to mention a case in which attention to the associated objects could not have been successive. In fact, an aggregate of objects on which attention could be focused at once would be already associated.

The exclusively successional character of contiguous association has recently been denied, and its exclusively simultaneous character maintained instead. It is at once obvious that this opposition of succession and simultaneity cannot be pressed so as to exclude duration altogether and reduce the whole process to an instantaneous event. Nor is there any ground for saying that there is a fixed and even distribution of attention to whatever is simultaneously presented: facts all point the other way. Still, though we cannot exclude the notion of process from consciousness, we may say that presentations attended to together become *pro tanto* a new whole, are synthesized or complicated. Such primary synthesis leads not to an association of ideas, but rather to the formation of one percept, which may become eventually a free idea. The disconcerted preperception which sets this free may likewise liberate a similar or contrasting idea, but it will not resolve either complex into the several "ideas" of its sensory or motor constituents, with which only the psychologist is familiar. The actual recurrence of some of these constituents may again reinstate the rest, not, however, as memories or as "thoughts," but only as tied ideas in a renewed perception.

Again, it has become usual to distinguish the association of contiguous experiences and the so-called association of similars or opposites as respectively external and internal forms of association. The new terminology is illuminating: the substitution of forms for laws marks the abandonment of the old notion that association was by "adhesion" of the contiguous and "attraction" of the similar. We are thus left to find the cause of association in interested attention; and that, we may safely say, is an adequate, and apparently the sole adequate, cause for the two commonly recognized forms of external association, the so-called simultaneous and the successive. But these two are certainly not co-ordinate; and if our analysis be sound, the former—for which we would retain the Herbartian term complication—yields us not members of an association but a member for association. So far, then, we should have but one form of association, that of the successive contents of focalized attention; and but one result, the representation or memory-continuum,² in contrast to the primary- or presentation-continuum, whence its constituents arise. Turning now to the distinction of external and internal, it at once strikes the unprejudiced mind that "internal association" is something of an anomaly, since the very notion of association implies externality. Also, on closer inspection what we find is not an association of similars or opposites as such, but—something quite distinct—a similarity or contrast of associates; of ideas, that is to say, which are contiguous members of the memory (or experience) continuum, or of ideas which have become contiguous through its reduplication.

The only case, then, that now remains to be considered is that—to take it in its simplest form—of two primary presentations A and X , parts of different special continua or distinct—*i.e.* non-adjacent—parts of the same, and occupying the focus of consciousness in immediate succession. This constitutes

² Experience-continuum would perhaps be a better name, since it is only a preliminary to a true memory record, as we shall presently see.

their integration; for the result of this occupation may be regarded as a new continuum in which *A* and *X* become adjacent parts. For it is characteristic of a continuum that an increase in the intensity of any part leads to the intenser presentation of adjacent parts; and in this sense *A* and *X*, which were not originally continuous, have come to be so. We have here, then, some justification for the term secondary- or memory-continuum when applied to this continuous series of representations to distinguish it from the primary or presentation-continuum from which its constituents are derived. The most important peculiarity of this continuum, therefore, is that it is a series of representations integrated by means of the movements of attention out of the differentiations of the primary or presentation-continuum, or rather out of so much of these differentiations as pertain to what we know as the primary memory-image. These movements of attention, if the phrase may be allowed, come in the end to depend mainly upon interest, but at first appear to be determined entirely by mere intensity.¹ To them it is proposed to look for that continuity which images lose in so far as they part with the local signs they had as percepts and cease to be either localized or projected. Inasmuch as it is assumed that these movements form the connexion between one representation and another in the memory-train, they may be called "temporal signs."² The evidence for their existence can be more conveniently adduced presently; it must suffice to remark here that it consists almost wholly of facts connected with voluntary attention and the voluntary control of the flow of ideas, so that temporal signs, unlike local signs, are fundamentally motor and not sensory. And, unlike impressions, representations can have each but a single sign,³ the continuum of which, in contrast to that of local signs, is not rounded and complete, but continuously advancing. But in saying this we are assuming for a moment that the memory-continuum forms a perfectly single and unbroken train. If it ever actually were such, then, in the absence of any repetition of old impressions and apart from voluntary interference with the train, consciousness, till it ceased entirely, would consist of a fixed and mechanical round of images. Some approximation to such a state is often found in uncultured persons who lead uneventful lives, and still more in idiots, who can scarcely think at all.

25. In actual fact, however, the memory-train is liable to change in two respects, which considerably modify its structure, viz. (1) through the evanescence of some parts, and (2) through the partial recurrence of like impressions, which produces reduplications of varying amount and extent in other parts. As regards the first, we may infer that the waning or sinking towards the threshold of consciousness which we can observe **Formation** in the primary mental image continues in sub-**Ideational** consciousness after the threshold is past. For the **Continuum**, longer the time that elapses before their revival the fainter, the less distinct, and the less complete are the images when revived, and the more slowly they rise. All the elements of a complex are not equally revivable, as we have seen already: tastes, smells and organic sensations, though powerful as impressions to revive other images, have little capacity for ideal

reproduction themselves, while muscular movements, though perhaps of all presentations the most readily revived, do not so readily revive other presentations. Idiosyncrasies are, however, frequent; thus we find one person has an exceptional memory for sounds, another for colours, another for forms. Still it is in general true that the most intense, the most impressive, and the most interesting presentations persist the longest. But the evanescence, which is in all cases comparatively rapid at first, deepens sooner or later into real or apparent oblivion. In this manner it comes about that parts of the memory-continuum lose all distinctness of feature and, being without recognizable content, shrivel up to a dim and meagre **Obliviscence**, representation of life that has lapsed—a representation that just suffices, for example, to show us that "our earliest recollections" are not of our first experiences, or to save them from being not only isolated but discontinuous. Such discontinuity can, of course, never be absolute; we must have something represented even to mark the gap. Oblivion and the absence of all representation are thus the same, and the absence of all representation cannot psychologically constitute a break. The terms "evolution" and "involution" have in this respect been happily applied to the rising and falling of representations. When we recall a particular period of our past life, or what has long ceased to be a familiar scene, events and features gradually unfold and, as it were, spread out as we keep on attending. A precisely opposite process may then be supposed to take place when they are left in undisturbed forgetfulness; this process is called obliviscence.

More important changes are produced by the repetition of parts of the memory-train. The effect of this is not merely to prevent the evanescence of the particular image **Repetition**, or series of images, but by partial and more or less frequent reduplications of the memory-train or "thread" upon itself to convert it into a partially new continuum, which we might perhaps call the ideational continuum or "tissue."⁴ The reduplicated portions of the train are strengthened, while at the points of divergence it becomes comparatively weakened, and this apart from the effects of obliviscence. One who had seen the king but once would scarcely be likely to think of him without finding the attendant circumstances recur as well; this could not happen after seeing him in a hundred different scenes. The central representation of the whole complex would have become more distinct, whereas the several diverging lines would tend to dissipate attention and, **Generic Images**, by involving opposing representations, to neutralize each other, so that probably no definite background would be reinstated. Even this central representation would be more or less generalized. It has been often remarked that one's most familiar friends are apt to be mentally pictured less concretely and vividly than persons seen more seldom and then in similar attitudes and moods; in the former case a "generic image" has grown out of such more specific representations as the latter affords. Still further removed from memory-images are the images that result from such familiar percepts as those of horses, houses, trees, &c.

Thus as the joint effect of obliviscence and reduplication we are provided with trains of ideas distinct from the memory-thread and thereby with the material, already more or less organized, for intellectual and volitional **Trains of Ideas**, manipulation. We do not experience the flow of ideas—save very momentarily and occasionally—altogether undisturbed; even in dreams and reverie it is continually interrupted and diverted. Nevertheless it is not difficult to ascertain that, so far as it is left to itself, it takes a very different course from that which we should have to retrace if bent on reminiscence and able to recollect perfectly. The readiness and steadiness of this flow are shown by the extremely small effort necessary in order to follow it. Nevertheless from its very nature it is liable, though not to positive breaches

⁴ This contrast of thread and tissue is suggested, of course, by Herbert's terms *Reihe* and *Gewebe*. It is justified by the fact that memory proper follows the single line of temporal continuity, while ideation furnishes the basis for manifold logical connexions.

¹ This connexion of association with continuous movements of attention makes it easier to understand the difficulty above referred to, viz. that in a series *A B C D . . . B* revives *C* but not *A*, and so on—a difficulty that the analogy of adhesiveness or links leaves unaccountable. To ignore the part played by attention in association, to represent the memory-continuum as due solely to the concurrence of presentations, is perhaps the chief defect of the associationist psychology, both English and German. Spencer's endeavour to show "that psychical life is distinguished from physical life by consisting of successive changes only instead of successive and simultaneous changes" (*Principles of Psychology*, pt. iv. ch. ii., in particular pp. 403, 406) is really nothing but so much testimony to the work of attention in forming the memory-continuum, especially when, as there is good reason to do, we reject his assumption that this growing seriality is physically determined.

² A term borrowed from Lotze (*Metaphysik*, 1st ed., p. 295), but the present writer is alone responsible for the sense here given to it and the hypothesis in which it is used.

³ Apart, that is to say, of course, from the reduplications of the memory-train spoken of below.

of continuity from its own working, yet to occasional blocks or impediments to the smooth succession of images at points where reduplications diverge, and either permanently or at the particular time neutralize each other.¹

The flow of ideas is, however, exposed to positive interruptions from two distinct sides—by the intrusion of new presentations and of voluntary interference. The only result of such interruptions which we need here consider is the *conflict of presentations* that may ensue. Herbart and his followers have gone so far as to elaborate a complete system of psychical statics and dynamics, based on the conception of presentations as forces and on certain more or less improbable assumptions as to the modes in which such forces interact. Since our power of attention is limited, it continually happens that attention is drawn off by new presentations at the expense of old ones. But, even if we regard this non-voluntary redistribution of attention as implying a struggle between presentations, still such conflict to secure a place in consciousness is very different from a conflict between presentations that are already there. Either may be experienced to any degree possible without the other appearing at all; thus, absorbed in watching a starry sky, one might be unaware of the chilliness of the air, though recognizing at once, as soon as the cold is felt, that, so far from being incompatible, the clearness and the coldness are causally connected. This difference between a conflict of presentations to enter the field of consciousness—if we allow for a moment the propriety of the expression—and that opposition or incompatibility between presentations which is only possible when they are in consciousness has been strangely confused by the Herbartians. In the former the intensity of the presentation is primarily alone of account; in the latter, on the contrary, quality and content are mainly concerned. Only the last requires any notice here, since such opposition arises when the ideational continuum is interrupted in the ways just mentioned, and apparently arises in no other way. Certainly there is no such opposition between primary presentations: there we have the law of incompensability preventing the presentation of opposites with the same local sign; and their presentation with different local signs involves, on this level at all events, no conflict. But what has never been presented could hardly be represented, if the ideational process were undisturbed: even in our dreams white negroes or round squares, for instance, never appear. In fact, absurd and bizarre as dream-imagery is, it never at any moment entails overt contradictions, though contradiction may be implicit.

But between ideas and percepts actual incompatibility is frequent. In the perplexity of Isaac, e.g.—"The voice is Jacob's voice, but the hands are the hands of Esau"—we have such a case in a familiar form. There is here not merely mental arrest but actual conflict: the voice perceived identifies Jacob, at the same time the hands identify Esau. The images of Esau and Jacob by themselves are different, but do not conflict; neither is there any strain, quite the contrary, in recognizing a person partly like Jacob and partly like Esau. For there is no direct incompatibility between smooth and rough, so long as one pertains only to voice and the other only to hands, but the same hands and voice cannot be both smooth and rough. Similar incompatibilities may arise without the intrusion of percepts, as when, in trying to guess a riddle or to solve a problem, or generally to eliminate intellectual differences, we have images which in themselves are only logically opposite, psychologically opposed, or in conflict, because each strives to enter the same complex. In all such conflicts alike we find, in fact, a relation of presentations the exact converse of that which constitutes similarity. In the latter we have two complete presentations, $a\ b\ x$ and $a\ b\ y$, as similar, each including the common part $a\ b$; in the former we have two partial presentations, x and y , as contraries, each excluding the other from the incomplete $a\ b$. And this $a\ b$, it is to be noted, is not more essential to the similarity than to the conflict. But in the one case it is a generic image (and can logically be predicated of two subjects); in the other it is a partially determined individual (and cannot be subject to opposing predicates). Except as thus supplementing $a\ b$, x and y do not conflict; black and white are not incompatible save as attributes of the same thing. The possibility of most of these conflicts—of all, indeed, that have any logical interest—lies in that reduplication of the memory-continuum which gives rise to these new complexes, generic images or general ideas.

Reminiscence and Expectation: Temporal Perception.

26. Having thus attempted to ascertain the formation of the ideational continuum out of the memory-train, the question arises: How now are we to distinguish between imagining and remembering, and again, between imagining and expecting?

¹ It is a mark of the looseness of much of our psychological terminology that facts of this kind are commonly described as cases of association. Dr Bain calls them "obstructive association," which is about on a par with "progress backwards"; Mr Sully's "divergent association" is better. But it is plain that what we really have is an arrest or inhibition consequent on association, and nothing that is either itself association or that leads to association.

It is plainly absurd to make the difference depend on the presence of belief in memory and expectation and on its absence in mere imagination; for the belief itself depends on this difference instead of constituting it. One real and obvious distinction, however, which Hume pointed out as regards memory, is the fixed order and position of the ideas of what is remembered or expected as contrasted with "the liberty" of the imagination to transpose and change its ideas. This order and position in the case of memory are, of course, normally those of the original impressions, but it seems rather naïve of Hume to tell us that memory "is tied down to these without any power of variation," while imagination has liberty to transpose as it pleases, as if the originals sat to memory for their portraits, while to imagination they were but studies. Such correspondence being out of the question—as Hume takes care to state as soon as it suits him—all we have, so far, is this fixity and definiteness as contrasted with the kaleidoscopic instability of ideation. In this respect what is remembered or expected resembles what is perceived: the grouping not only does not change capriciously and spontaneously, but resists any mental efforts to change it. But, provided these characteristics are there, we should be apt to believe that we are remembering, just as, *mutatis mutandis*, with like characteristics we might believe that we were perceiving: hallucination is possible in either case.

This fixity of order and position is, however, not sufficient to constitute a typical reminiscence where the term is exactly used. But remembering is often regarded as equivalent to knowing and recognizing, as when on revisiting some once familiar place one remarks, "How well I remember it!" What is meant is that the place is recognized, and that its recognition awakens memories. Memory includes recognition; recognition as such does not include memory. In human consciousness, as we directly observe it, there is, perhaps, no pure recognition: here the new presentation is not only assimilated to the old, but the former framing of circumstance is reinstated, and so perforce distinguished from the present. It may be there is no warrant for supposing that such reintegration of a preceding field is ever absolutely nil, still we are justified in regarding it as extremely vague and meagre, both where mental evolution is but slightly advanced and where frequent repetition in varying and irrelevant circumstances has produced a blurred and neutral zone. The last is the case with a great part of our knowledge; the writer happens to know that *bos* is the Latin for "ox" and *bufo* the Latin for "toad," and may be said to remember both items of knowledge, if "remember" is only to be synonymous with "retain." But if he came across *bos* in reading he would think of an ox and nothing more; *bufo* would immediately call up not only "toad" but Virgil's *Georgics*, the only place in which he has seen the word, and which he never read but once. In the former there is so far nothing but recognition (which, however, of course rests upon retentiveness); in the latter there is also remembrance of the time and circumstances in which that piece of knowledge was acquired. Of course in so far as we are aware that we recognize we also think that remembrance is at any rate possible, since what we know we must previously have learned—recognition excluding novelty. But the point here urged is that there is an actual reminiscence only when the recognition is accompanied by a reinstatement of portions of the memory-train continuous with the previous presentation of what is now recognized. Summarily stated, we may say that between knowing and remembering on the one hand and imagining on the other the difference primarily turns on the fixity and completeness of the grouping in the former; in the latter there is a shifting play of images more or less "generic," reminding one of "dissolving views." Hence the first two approximate in character to perception, and are rightly called recognitions. Between them, again, the difference turns primarily on the presence or absence of temporal signs. In what is remembered these are still intact enough to ensure a localization in the past of what is recognized; in what is known merely such localization is prevented, either because of the obliviscence of temporal connexions or because

the reduplications of the memory-train that have consolidated the central group have entailed their suppression. There is further the difference first mentioned, which is often only a difference of degree, viz. that reminiscences have more circumstantiality, so to say, than mere recognitions have: more of the collateral constituents of the original concrete field of consciousness are reinstated. But of the two characteristics of memory proper—(a) concreteness or circumstantiality, and (b) localization in the past—the latter is the more essential. It sometimes happens that we have the one with little or nothing of the other. For example, we may have but a faint and meagre representation of a scene, yet if it falls into and retains a fixed place in the memory train we have no doubt that some such experience was once actually ours. On the other hand, as in certain so-called illusions of memory, we may suddenly find ourselves reminded by what is happening at the moment of a preceding experience exactly like it—some even feel that they know from what is thus recalled what will happen next; and yet, because we are wholly unable to assign such representation a place in the past, instead of a belief that it happened, there arises a most distressing sense of bewilderment, as if one were haunted and had lost one's personal bearings.¹ It has been held by some psychologists² that memory proper includes the representation of one's past self as agent or patient in the event or situation recalled. And this is true as regards all but the earliest human experience, at any rate; still, whereas it is easy to see that memory is essential to any development of self-consciousness, the converse is not at all clear, and would involve us in a needless circle.

27. Intimately connected with memory is expectation. We may as the result of reasoning conclude that a certain event will happen; we may also, in like manner, conclude **Expectation.** that a certain other event has happened. But as we should *not* call the latter memory, so it is desirable to distinguish such indirect anticipation as the former from that expectation which is directly due to the interaction of ideas. Any man knows that he will die, and may make a variety of arrangements in anticipation of death, but he cannot with propriety be said to be expecting it unless he has actually present to his mind a series of ideas ending in that of death, such series being due to previous associations, and unless, further, this series owes its representation at this moment to the actual recurrence of some experience to which that series succeeded before. And as familiarity with an object or event in very various settings may be a bar to recollection, so it may be to expectation: the average Englishman, e.g. is continually surprised without his umbrella, though only too familiar with rain, since in our climate one not specially attentive to the weather obtains no clear representation of its successive phases. But after a series of events *A B C D E* . . . has been once experienced we instinctively expect the recurrence of *B C* . . . on the recurrence of *A*, i.e. provided the memory-train continues so far intact. Such expectation, at first perhaps slight—a mere tendency easily overborne—becomes strengthened by every repetition of the series in the old order, till eventually, if often fulfilled and never falsified, it becomes certain and, as we commonly say, irresistible. To have a clear case of expectation, then, it is not necessary that we should distinctly remember any previous experience like it, but only that we should have actually present some earlier member of a series which has been firmly associated by such previous experiences, the remaining members, or at least the next, if they continue serial, being revived through that which is once again realized. This expectation may be instantly checked by reflection, just as it may, of course, be disappointed in fact; but these are matters which do not concern the inquiry as to the nature of expectation while expectation lasts.

We shall continue this inquiry to most advantage by widening it into an examination of the distinction of present, past and future. To a being whose presentations never passed through

the transitions which ours undergo—first divested of the strength and vividness of impressions, again reinvested with them and brought back from the faint world of ideas **Present, Past, and Future.**—the sharp contrasts of “now” and “then,” and all the manifold emotions they occasion, would be quite unknown. Even we, so far as we confine our activity and attention to ideas are almost without them. Time-order, succession, antecedence, and consequence, of course, there might be still, but in that sense of events as “past and gone for ever,” which is one of the melancholy factors in our life; and in the obligation to wait and work in hope or dread to what is “still to come” there is much more than time-order. It is to presentations in their primary stage, to impressions, that we owe what real difference we find between now and then, whether prospective or retrospective, as it is to them also that we directly owe our sense of the *real*, of what *is* and exists as opposed to the non-existent that is not. But the present alone and life in a succession of presents, or, in other words, continuous occupation with impressions, give us no knowledge of the present as present. This we first obtain when our present consciousness consists partly of memories or partly of expectations as well. An event expected differs from a like event remembered chiefly in two ways—in its relation to present impressions and images and in the active attitude to which it leads. The diverse feelings that accompany our intuitions of time and contribute so largely to their colouring are mainly consequences of these differences. Let us take a series of simple and familiar events *A B C D E*, representing ideas by small letters, and perceptions by capitals whenever it is necessary to distinguish them. Such series may be present in consciousness in such wise that *a b c d* are imaged while *E* is perceived anew, i.e. the whole symbolized as proposed would be *a b c d E*; such would be, e.g. the state of a dog that had just finished his daily meal. Again, there may be a fresh impression of *A* which revives *b c d e*; we should have then (1) *A b c d e*—the state of our dog when he next day gets sight of the dish in which his food is brought to him. A little later we may have (2) *a b C d e*. Here *a b* are either after-sensations or primary memory-images, or have at any rate the increased intensity due to recent impression; but this increased intensity will be rapidly on the wane even while *C* lasts, and *a b* will pale still further when *C* gives place to *D*, and we have (3) *a b c D e*. But, returning to (2), we should find *d e* to be increasing in intensity and definiteness, as compared with their state in (1), now that *C*, instead of *A*, is the present impression. For, when *A* occupied this position, not only was *e* raised less prominently above the threshold of consciousness by reason of its greater distance from *A* in the memory-continuum, but, owing to the reduplications of this continuum, more lines of possible revival were opened up, to be successively negated as *B* succeeded to *A* and *C* to *B*; even dogs know that “there is many a slip 'twixt the cup and the lip.” But, where *A B C D E* is a series of percepts such as we have here supposed—and a series of simpler states would hardly afford much ground for the distinctions of past, present and future—there would be a varying amount of active adjustment of sense-organs and other movements supplementary to full sensation. In (2), the point at which we have *a b c d e*, for instance, such adjustments and movements as were appropriate to *b* would cease as *B* lapsed and be replaced by those appropriate to *C*. Again, as *C* succeeded to *B*, and *d* in consequence increased in intensity and definiteness, the movements adapted to the reception of *D* would become nascent, and so on. Thus, psychologically regarded, the distinction of past and future and what we might call the oneness of direction of time depend, as just described, (1) upon the continuous sinking of the primary memory-images on the one side, and the continuous rising of the ordinary images on the other side, of that member of a series of percepts then repeating which is actual at the moment; and (2) on the preventient adjustments of attention, to which such words as “expect,” “await,” “anticipate,” all testify by their etymology. These conditions in turn will be found to depend upon all that is implied in the formation of the memory-train and upon that recurrence of like series of impressions which we

¹ Any full discussion of *paramnesia*, as these very interesting states of mind are called, belongs to mental pathology.

² As, e.g. James Mill (*Analysis of the Human Mind*, ch. x.), who treats this difficult subject with great acuteness and thoroughness.

attribute to the "uniformity of nature." If we never had the same series of impressions twice, knowledge of time would be impossible, as indeed would knowledge of any sort.

28. Time is often figuratively represented as a line, and we may perhaps utilize this figure to make clear the relation of our perception of time to what we call time itself. The present, though conceived as a point or instant of time, is still such that we actually can and do in that moment attend to a plurality of presentations to which we might otherwise have attended to severally in successive moments. Granting this implication of simultaneity and succession, we may, if we represent succession as a line, represent simultaneity as a second line at right angles to the first; pure time—or time-length without time-breadth, we may say—is a mere abstraction. Now it is with the former line that we have to do in treating of time as it is (or as we conceive it), and with the latter in treating of our perception of time, where, just as in a perspective representation of distance, we are confined to lines in a plane at right angles to the actual line of depth. In a succession of events $A B C D E \dots$ the presence of B means the absence of A and of C , but the presentation of this succession involves the simultaneous presence, in some mode or other, of two or more of the presentations $A B C D$. In our temporal perception, then, all that corresponds to the differences of past, present and future is presented simultaneously. To this fact the name of "specious present" or "psychical present" has been given. What we have is not a moving point or moment of objective time, but rather a moving line, the contents of which, continuously changing, simultaneously represent a portion of the line of objective succession, viz. the immediate past as still present in primary memory-images, and the immediate future as anticipated in prepercepts and nascent acts.¹ This truism—or paradox—that all we know of succession is but an interpretation of what is really simultaneous or coexistent, we may then concisely express by saying that we are aware of time only through time-perspective, and experience shows that it is a long step from a succession of presentations to such presentation of succession. The first condition of such presentation is that we should have represented together presentations that were in the first instance attended to successively, and this we have both in the persistence of primary memory-images and in the simultaneous reproduction of longer or shorter portions of the memory-train. In a series thus secured there may be time-marks, though no time, and by these marks the series will be distinguished from other simultaneous series. To ask which is first among a number of simultaneous presentations is unmeaning; one might be logically prior to another, but in time they are together and priority is excluded. Nevertheless after each distinct representation a, b, c, d there probably follows, as we have supposed, some trace of that movement of attention of which we are aware in passing from one presentation to another. In our present reminiscences we have, it must be allowed, little direct proof of this interposition, though there is strong indirect evidence of it in the tendency of the flow to follow the order in which the presentations were first attended to. With the movements themselves we are familiar enough, though the residua of such movements are not ordinarily conspicuous. These residua, then, are our temporal signs, and, together with the representations connected by them, constitute the memory-continuum. But temporal signs alone will not furnish all the pictorial exactness of the time-perspective. They give us only a fixed series; but the working of obliviscence, by insuring a progressive variation in intensity and distinctness as we pass from one member of the series to the other, yields the effect which we call time-distance. By themselves such variations would leave us liable to confound more vivid representations in the distance with fainter ones nearer the present, but from this mistake the temporal signs save us; and, as a matter of fact, where the memory-train is imperfect such mistakes continually occur. On the other hand, where these variations are slight and imperceptible, though the memory-

¹ Cf. W. James, *Principles of Psychology*, i. 629 sqq.; L. W. Stern, "Psychische Präsenzzeit," *Z. f. Psych.*, (1897), xiii. 325 sqq.

continuum preserves the order of events intact, we have still no such distinct appreciation of comparative distance in time as we have nearer the present where these perspective effects are considerable.

29. When in retrospect we note that a particular presentation X has had a place in the field of consciousness, while certain other presentations, $A B C D \dots$, have succeeded each other, then we may be said in observing this relation of the two to perceive the duration of X . And it is in this way that we do subjectively estimate longer periods of time. But first, it is evident that we cannot apply this method to indefinitely short periods without passing beyond the region of distinct presentation; and, since the knowledge of duration implies a relation between distinguishable presentations $A B C D$ and X , the case is one in which the hypothesis of subconsciousness can hardly help any but those who confound the fact of time with the knowledge of it. Secondly, if we are to compare different durations at all, it is not enough that one of them should last out a series $A B C D$, and another a series $L M N O$; we also want some sort of common measure of those series. Locke was awake to this point, though he expresses himself vaguely (*Essay*, ii. 14, §§ 9-12). He speaks of our ideas succeeding each other "at certain distances not much unlike the images in the inside of a lantern turned round by the heat of a candle," and "guesses" that "this appearance of theirs in train varies not very much in a waking man." Now what is this "distance" that separates A from B , B from C , and so on, and what means have we of knowing that it is tolerably constant in waking life? It is probably that the residuum of which we have called a temporal sign; or, in other words, it is the movement of attention from A to B . But we must endeavour here to get a more exact notion of this movement. Everybody knows what it is to be distracted by a rapid succession of varied impressions, and equally what it is to be wearied by the slow and monotonous recurrence of the same impressions. Now these "feelings" of distraction and tedium owe their characteristic qualities to movements of attention. In the first, attention is kept incessantly on the move; before it is accommodated to A , it is disturbed by the suddenness, intensity, or novelty of B ; in the second, it is kept all but stationary by the repeated presentation of the same impression. Such excess and defect of surprises make one realize a fact which in ordinary life is so obscure as to escape notice. But recent experiments have set this fact in a more striking light, and made clear what Locke had dimly before his mind in talking of a certain distance between the presentations of a waking man. In estimating very short periods of time, of a second or less—indicated say by the beats of a metronome—it is found that there is a certain period for which the mean of a number of estimates is correct, while shorter periods are on the whole over-estimated, and longer periods under-estimated. This we may perhaps take to be evidence of the time occupied in accommodating or fixing attention. Whether the "point of indifference" is determined by the rate of usual bodily movement, as Spencer asserts and Wundt conjectures, or conversely, is a question we need not discuss just now. But, though the fixation of attention does of course really occupy time, it is probably not in the first instance perceived as time, i.e. as continuous "protensity," to use a term of Hamilton's, but as intensity. Thus, if this supposition be true, there is an element in our concrete time-perception which has no place in our abstract conception of time. In time conceived as physical there is no trace of intensity; in time psychically experienced duration is primarily an intensive magnitude, witness the comparison of times when we are "bored" with others when we are amused. It must have struck every one as strange who has reflected upon it that a period of time which seems long in retrospect—such as an eventful excursion—should have appeared short in passing; while a period, on the contrary, which in memory has dwindled to a wretched span seemed everlasting till it was gone. But, if we consider that in retrospect length of time is represented primarily and chiefly by impressions that have survived, we have an explanation of one-half; and in the intensity of the movements of attention we shall perhaps find an explanation

of the other. What tells in retrospect is the series *a b c d e*, &c.; what tells in the wearisome present is the intervening *t1t2t3*, &c., or rather the original accommodation of which these temporal signs are the residuum. For, as we have seen elsewhere, the intensity of a presentation does not persist, so that in memory the residuum of the most intense feeling of tedium may only be so many *t*'s in a memory-continuum whose surviving members are few and uninteresting. But in the actual experience, say, of a wearisome sermon, when the expectation of release is continually balked and attention forced back upon a monotonous dribble of platitudes, the one impressive fact is the hearer's impatience. On the other hand, so long as we are entertained, attention is never involuntary, and there is no continually deferred expectation. Just as we are said to walk with least effort when our pace accords with the rate of swing of our legs regarded as pendulums, so in pastimes impressions succeed each other at the rate at which attention can be most easily accommodated, and are such that we attend willingly.¹ We are absorbed in the present without being unwillingly confined to it; not only is there no motive for retrospect or expectation, but there is no feeling that the present endures. Each impression lasts as long as it is interesting, but does not continue to monopolize the focus of consciousness till attention to it is fatiguing, because uninteresting. In such facts, then, we seem to have proof that our perception of duration rests ultimately upon quasi-motor acts of varying intensity, the duration of which we do not directly experience as duration at all. They do endure and their intensity is a function of their duration; but the intensity is all that we directly perceive. In other words, it is here contended that what Locke called an instant or moment—"the time of one idea in our minds without the succession of another, of one wherein therefore we perceive no succession at all"—is psychologically not "a part in duration" in that sense in which, as he says, "we cannot conceive any duration without succession" (*Essay*, ii. 16, 12).

But, if our experience of time depends primarily upon acts of attention to a succession of distinct objects, it would seem that time, subjectively regarded, must be discrete and not continuous. This, which is the view steadily maintained by the psychologists of Herbart's school, was implied if not stated by Locke, Berkeley and Hume. Locke hopelessly confuses time as perceived and time as conceived, and can only save himself from pressing objections by the retort, "It is very common to observe intelligible discourses spoiled by too much subtlety in nice divisions." But Berkeley and Hume, with the mathematical discoveries of Newton and Leibnitz before them, could only protest that there was nothing answering to mathematical continuity in our experience. And, whereas Locke had tried to combine with his general psychological account the inconsistent position that "none of the distinct ideas we have of either [space or time] is without all manner of composition," Berkeley declares, "For my own part, whenever I attempt to frame a simple idea of time, abstracted from the succession of ideas in my mind, which flows uniformly and is participated by all beings, I am lost and embroiled in inextricable difficulties. I have no notion of it at all, only I hear others say it is infinitely divisible, and speak of it in such a manner as leads me to harbour odd thoughts of my existence. . . . Time therefore being nothing, abstracted from the succession of ideas in our minds, it follows that the duration of any finite spirit must be estimated by the number of ideas or actions succeeding each other in that same spirit or mind" (*Principles of Knowledge*, i. § 98). Hume, again, is at still greater pains to show that "the idea which we form of any finite quality is not infinitely divisible, but that by proper distinctions and separations we may run this idea up to inferior ones, which will be perfectly simple and indivisible . . . that the imagination reaches a *minimum*, and may raise up to itself an idea of which it cannot conceive any subdivision, and which cannot be diminished without a total annihilation" (*Human Nature*, pt. ii. § 1, Green's ed., pp. 334 seq.).

At first blush we are perhaps disposed to accept this account of our time-perception, as Wundt, e.g. does, and to regard the attribution of continuity as wholly the result of after-reflection.² But it may be doubted if this is really an exact analysis of the case.

¹ To this rate the "indifference point" mentioned above is obviously related. It has also been called "adequate time" or "optional time." It is, however, a *tempo* that varies with the subject-matter attended to; when effective attention is more difficult the tempo is slower than it is when to attend is easy.

² Cf. Wundt, *Logik*, i. 432.

Granted that the impressions to which we chiefly attend are distinct and discontinuous in their occupation of the focus of consciousness, and that, so far, the most vivid element in our time-experience is discrete; granted further that in recollection and expectation such objects are still distinct—all which seems to imply that time is a mere plurality—yet there is more behind. The whole field of consciousness is not occupied by distinct objects, neither are the changes in this field discontinuous. The experimental facts above-mentioned illustrate the transition from a succession the members of which are distinctly attended to to one in which they are indistinctly attended to, i.e. are not discontinuous enough to be separately distinguished. Attention does not move by hops from one definite spot to another, but, as Wundt himself allows, by alternate diffusion and concentration, like the foot of a snail, which never leaves the surface it is traversing. We have a clear presentation discerned as *A* or *B* when attention is gathered up; and, when attention spreads out, we have confused presentations not admitting of recognition. But, though not recognizable, such confused presentations are represented, and so serve to bridge over the comparatively empty interval during which attention is unfocused. Thus our perception of a period of time is not comparable to so many terms in a series of finite units any more than it is to a series of infinitesimals. When attention is concentrated in expectation of some single impression, then, no doubt, it is brought to a very fine point ("zugespitzt," as Herbart would say); and a succession of such impressions would be represented as relatively discrete compared with the representation of the scenery of a day-dream. But absolutely discrete it is not and cannot be. In this respect the truth is rather with Herbert Spencer, who, treating of this subject from another point of view, remarks, "When the facts are contemplated objectively, it becomes manifest that, though the changes constituting intelligence approach to a single succession, they do not absolutely form one" (*Psychology*, i. § 180).

On the whole, then, we may conclude that our concrete time-experiences are due to the simultaneous representation of a series of definite presentations both accompanied and separated by more or fewer indefinite presentations more or less confused; that, further, the definite presentations have certain marks or temporal signs due to the movements of attention; that the rate of these movements or accommodations is approximately constant; and that each movement itself is primarily experienced as an intensity.

Experimental Investigations concerning Memory and Association.

30. Of the vast mass of experimental work undertaken in recent years, that relating to memory and association is probably the most important. A brief account of some of it is therefore offered at this point, by way of illustrating the character of the "new psychology."

The learning and retaining of a stanza of poetry, say, is obviously a function of many variables, such as the mode of presentation (whether the words are heard only, or heard and seen, or both heard, seen and spoken aloud), the length, familiarity with the words and ideas used, the number of repetitions, the attention given, &c. Familiarity of course implies previous learning and retaining; the first essential, therefore, in any attempt to study these processes from the beginning, is the exclusion of this factor. Accordingly Ebbinghaus, the pioneer in experiments of this kind,³ devised the new material, which is now regularly employed, namely, closed monosyllables, not themselves words, and strung together promiscuously into lines of fixed length so as never to form words: *bam. rit. por. sig. nef. gud*, &c., is an instance of such "senseless verses." With very slight attention most persons would be able to reproduce three or four such syllables on a single reading or hearing; and by greater concentration six or seven might be so reproduced. This maximum, called sometimes the "span of prehension," has been repeatedly made the subject of special inquiry. In idiots it is found, as might be expected, remarkably low; in school children it increases rapidly between the ages of eight and fourteen, and then remains almost stationary, individual differences being small compared with the striking differences that appear when longer lines make repetitions necessary.⁴ This comparatively constant span of prehension is doubtless

³ H. Ebbinghaus, "Ueber das Gedächtniss: Untersuchungen zur experimentellen Psychologie" (1885).

⁴ Cf. J. Jacobs and F. Galton on the "Span of Prehension," *Mind* (1887), pp. 75 sqq.; Bourdon, "Influence de l'âge sur la mémoire immédiate," *Rev. phil.* (1894), xxxviii., 148 sqq.

closely connected with certain other psychical constants, such as the duration of the psychical present and of the primary memory-image, the *tempo* of movements of attention (§§ 28, 29), &c. There are isolated investigations of these several conditions, but the subject as a whole still awaits systematic treatment.¹ That it is not wanting in interest is evident when we consider that if our span of prehension were enlarged, a corresponding increase in the variety and range of metre and rhyme in poetry, of "phrase" in music, and of evolution in the dance would be possible. The limits at present imposed on these and like complexities find their ultimate explanation in the constants just mentioned.

With lines of greater length than seven syllables some repetition is requisite before they can be said correctly: the number of such repetitions was found by Ebbinghaus to increase very rapidly with the number of syllables to be learnt. In his own case, for lines of 12, 16, 24, 36 syllables the repetitions necessary were on the average 16.6, 30, 44, 55 respectively. Thus for a line exceeding in length that of the span of prehension only about five times, he required fifty-five times as many repetitions, if we may call the single presentation of the syllables a "repetition." Substituting poetry for gibberish of equal amount, Ebbinghaus found that one-tenth the number of repetitions sufficed; the enormous saving thus effected showing how numerous and intimate are the ready-made associations that "rhyme and reason" involve. But at one and the same time to memorize five verses even of sense requires more than five times as many repetitions as the memorizing of one. Two or three lines of inquiry here present themselves, e.g. (1) as to the comparative value of successive repetitions when several are taken together; (2) as to retention after an interval, as (a) a function of the number of repetitions previously made, and as (b) a function of the time; (3) as to the respective effects of more or less cumulating, or more or less distributing, the repetitions, on the number of these required.

1. It is at once obvious that beyond a certain point exhaustion of attention renders further repetition for a time futile; thus Ebbinghaus found 64 repetitions at one sitting of six 16-syllable nonsense verses, a task lasting some three-quarters of an hour, "was apt to bring on asthenia, a sort of epileptic *aura*, and the like!" But keeping well within this heroic limit, a certain "law of diminishing return," to use an economic analogy, discloses itself. Thus taking a line of 10 syllables, the number of syllables reproduced correctly and in their proper order, after 1, 3, 6, 9 and 12 "repetitions," were 2.2, 2.5, 2.8, 3.4, 3.9 respectively, as the averages of a series of experiments with each of eight persons.² "The first repetition is undoubtedly the best," assuming, of course, that the subjects start with their attention fully concentrated. Some persons naturally do this, many do not; the experimenter has therefore to take special precautions to secure uniformity in this respect.

2. (a) On relearning a line after an interval of twenty-four hours there was in Ebbinghaus's case an average saving of one repetition for every three made the day before. A line of 16 syllables, for example, required some 30 repetitions, and could then be said off correctly. If only 8 repetitions were taken at first, the line being "underlearnt," it probably appeared quite strange the next day, yet the *proportional* saving was no less; on the other hand, if an additional 30 repetitions followed immediately on the first, the line being "doubly learnt," in spite of the

¹ Cf. Dietze, "Untersuchungen über den Umfang des Bewusstseins u.s.w.," *Phil. Studien* (1885), pp. 362 sqq.; L. W. Stern, "Psychische Präsenzzeit," *Ztschr. f. Psychologie* (1897), xiii. 325 sqq.; Daniels, "Memory After-image and Attention," *Am. Jour. of Psychology* (1893), vi. 558 sqq.

² W. G. Smith, "The Place of Repetition in Memory," *Psychological Rev.* (1896), pp. 20 sqq. The figures given are unquestionably low, partly, as the writer points out, in consequence of the method employed, but partly, as his detailed tables show, in consequence of the lax attention of three out of his eight subjects. Objections have been taken to the plan of this investigation, but it is doubtful if they invalidate the result here mentioned. Cf. Jost, "Die Associationsfestigkeit in ihrer Abhängigkeit von der Vertheilung der Wiederholungen," *Ztschr. f. Psychologie*, xiv. 455 sqq.

familiarity next day apparent, the proportional saving was no greater. The *absolute* saving would, of course, be less. We are so far led to infer that the stronger associations effected by many repetitions at one time fall off more rapidly than weaker associations effected by fewer repetitions in the same way. Herbart in his "psychical dynamics"—influenced probably by physical analogies—conjectured that the "sinking" or "inhibition" of presentations generally was proportional to their intensity: the less there was to sink, the slower the sinking became. Recent experiments certainly point in this direction. (b) As to retention as a function of the time—we all know that memories fade with time, but not at what precise rate. Ebbinghaus, by a series of prolonged experiments, ascertained the rate to be proportional to the logarithm of the time—a result already implied in that connecting retention and intensity; albeit in inquiries of this kind independent confirmation is always of value.

3. Had the proportional saving just described held good indefinitely, some 100 repetitions of the 16 syllables at one time should have dispensed with any further repetition twenty-four hours afterwards; whereas, in fact, this result seemed never attainable. Beyond a certain degree of accumulation, an ever-diminishing return was manifest, and that apparently short of the stage at which exhaustion of attention began to be felt. But, contrariwise, when the repetitions were distributed over several days, an ever-increasing efficiency was then the result. Thus, for Ebbinghaus, 38 repetitions spread over three days were as effective as 68 taken together. The results of careful experiments by Jost with two different subjects, using G. E. Müller's "method of telling" (to be described later on), are still more conclusive. Comparing 8 repetitions on three successive days with 4 repetitions on six, and 2 on twelve, the efficiencies, tested twenty-four hours later, were respectively as 11.5, 35, and 54; and probably, as Jost surmises, the effect of the maximum distribution—single "repetition" on twenty-four successive days—would have been more advantageous still, securing in fact the superiority of a first impression (cf. 1, above) on every occasion. This result again, is in part explained by the law of sinking already found. For if the sinking were simply proportional to the time, or were independent of the intensity, there would so far be no reason why one mode of distributing a given number of repetitions should be more economical than another. There is, however, another reason for this superiority, less clearly implied, to which we shall come presently.

Invariably, and almost of necessity, a more or less complex rhythmical articulation becomes apparent as the syllables are repeated, even when—as in the improved methods of G. E. Müller and his *collaborateurs*—they are presented singly and at regular intervals. A series of twelve syllables, for example, would be connected into six trochees, with a caesura in the middle of the verse; while in each half of it the first and last accented syllables would be specially emphasized; thus:

bām fīs | lūp tōl | gēn kēr || dūb nāf | &c.

In trying to suppress this tendency and to repeat the syllables in a monotonous, *staccato* fashion, just as they were presented, the *tempo*, though really unchanged, seemed to be distinctly quickened, a consequence, doubtless, of the greater effort involved. Moreover, the attempt, which was seldom successful, about doubled the number of repetitions required for learning off, thereby showing how much is gained by this psychical organization of disconnected material. But the gain thus ensured was manifest in other ways. Each foot, whether dissyllabic or trisyllabic, became a new complex unit, the elements to be connected by successive association being thereby reduced to a half or a third, and the whole line seemingly shortened. The varied intonation, again, helped to fix the place of each foot in the verse, thus further facilitating the mind's survey of the whole. Such a transformation can hardly be accounted for so long as retention and association are regarded as merely mechanical and passive processes.

Psychical rhythm, upon which we here touch, has also been experimentally investigated at great length, alike in its physiological

psychological and aesthetical aspects. The topic is far too intricate and unsettled for discussion here, yet two or three points may be noted in passing. We are not specially concerned with *objective* rhythms, recurring series of impressions—that is to say, in which there are actually periodic variations of intensity, interval and the like. What is remarkable is that even a perfectly regular succession of sounds (or touches), qualitatively and quantitatively all alike, a series therefore devoid of all objective rhythm, is nevertheless apprehended as rhythmically grouped, provided the rate lies between the limits of about 0.8" and 0.14". The slower of these rates leads to simple groups of two, replaced by groups of four or eight as the rate increases; groups of three and six also occur, though less frequently. The average duration of the groups, whether these are large or small, is comparatively constant, measuring rather more than one second. The subject usually keeps time by taps, nods or other accompanying movements; the pulse and respiration are also implicated. These organic rhythms have even been regarded as the prime source of all psychical rhythm and of its manifold aesthetic effects. Some connexion there is unquestionably. As the decimal system corresponds to our possession of ten fingers, and our movements to the structure of our limbs, so here we may assume that physiological processes fix the limits within which psychical rhythm is possible, but yet may be as little an adequate cause of it or its developments as fingers are of arithmetic, or legs of an Irish jig. In motor rhythms, such as the last, the initiative is obviously psychical, and the respiratory and other periodic organic processes simply follow suit. And even sensory rhythms can often be varied at the subject's own choice, or on the suggestion of another; and then again the breathing is altered in consequence. Familiar instances of such procedure are to be found in the "tunes" so readily attributed to the puff of a locomotive, to the churning of a steamer's screw, and the like. Psychical rhythm, then, we may conclude, is due to attention or apperception, but the conditions determining it are many, and their relations very complex. If the presentations to be "rhythmized" (the *rhythmizomenon*, as the Germans say) succeed each other slowly, the length (or shall we say the breadth?) of the "psychical present" tells one way: the first impression is below the threshold when the third appears. If they arrive rapidly, their intensity and duration and the span of prehension tell another way; for it is essential that they retain their individual distinctness and only so many can be grasped at once. But if the series continue long enough, or be frequently experienced, sub-groups may be treated as individuals; and indeed till some facility is acquired, the subject attending is aware of no rhythm. In the act of attention itself there are phases, in so far as expectation involves preadjustment to what is coming: usually the first members of a tact are predominant, and the rhythm tends to "fall"; several alternations of accent within a complex rhythmic whole are of course still compatible with this. But it is important to note that, whether simple or complex, the rhythm is an intuited unity as truly as a geometrical figure may be. Unlike a geometrical figure, however, it rarely or never has symmetry. We cannot reverse a tune and obtain an effect comparable with that obtained by reprinting the score backwards in line with the original. We now pass to a question in which the psychological bearing of this fact becomes apparent.¹

But first a new method of dealing with memory-problems must be mentioned, in which the connexion between rhythmizing and memorizing has been turned to account by the Göttingen psychologists. The method of Ebbinghaus consisted in ascertaining the repetitions saved in consequence of previous repetitions, when the verse was relearnt some fixed time later. Hence this method is called the learning method or the method of saving. When, a given time after a certain number of repetitions (say) in trochaic measure, the subject is confronted with one of the accented syllables and asked to name the unaccented syllable that belongs to it, he will answer sometimes rightly, sometimes wrongly, and sometimes be unable to answer at all. This, the new, method is therefore named *Treffer-methode*, the method of "shots," or, let us say, the telling method. It enables the experimenter to obtain far more insight into details than was possible before, for the "misses" as well as the "hits" are instructive. Moreover, by measuring the time of each answer (*Trefferzeit*) and comparing these times together, much can be learnt; in stronger or recent associations, for example, the answers being quicker than in weaker or older ones.

Does association work forwards only or backwards also, as the middle link of a chain, when lifted, raises the contiguous links on either side of it? This is certainly not the case when the forward direction makes sense, but with nonsense verses, if the mechanical analogy is a sound one, such reversal is to be expected. For here there are none of the "obstructing associations" which

¹ The following are among the more important papers on rhythm: T. L. Bolton, "Rhythm," *Am. Journ. of Psychology* (1894), pp. 145 sqq.; E. E. Meumann, "Untersuchungen z. Psychologie u. Aesthetik des Rhythmus," *Phil. Studien* (1894), x, 249 sqq., 393 sqq.; M. K. Smith, "Rhythmus und Arbeit," *Phil. Studien* (1900), xvi, 71 sqq. 197 sqq.; *Arbeit und Rhythmus* (1899), by K. Bucher, a well-known economist, bringing out the teleological aspects of rhythm.

"rhyme and reason" imply. In learning a verse backwards Ebbinghaus found a saving of 12.4 % of the time originally taken up in learning it forwards. A saving almost as great (10.4 %) was effected by relearning a like verse forwards, but skipping one syllable: the order of syllables, that is to say, being 1, 3, 5, . . . 15, 2, 4, . . . 16. Even when learning backwards and skipping one syllable, Ebbinghaus found a saving of 5 %. But the number of his experiments (four) was too few to give this result much value, as he fully admits. These experiments as a whole, then, might incline us to suppose that association does work in both directions, though the connexions backwards are considerably weaker. But if so the associations both ways should be alike at least in form—continuous, that is to say, backwards, *d c b a*, as well as forwards, *a b c d*. The facts at present available are, however, against this. In two or three hundred experiments by Müller and Pilzecker, verses of twelve syllables were repeated a set number of times in anapaestic measure—accented, that is to say, on the 3rd, 6th, 9th and 12th. After a fixed interval the subject, confronted with one of the accented syllables, mentioned any of the other syllables which he called to mind. Now the cases in which the syllable *immediately* preceding was revived were only about half as frequent as those in which the syllable *next but one preceding* was revived; the time of telling (*Trefferzeit*) for the latter was also *shorter*. This result is incompatible with the theory of continuous backward association, but it is readily explained by the fact that the group of three syllables had become one complex whole, and it shows that the tendency to reinstate the initial member of the group is stronger than that to reinstate the middle. The saving effected in Ebbinghaus's experiment is also thus explained.²

A somewhat paradoxical situation is brought to light when the method of saving and the method of telling are used together. In the experiments by Jost, mentioned above, the series of verses were repeated thirty times; after an interval of twenty-four hours one series was tested by the first method and the other by the second. Two new series were then taken: the first repeated four times, and after an interval of a minute tested by the first method; the other was then repeated in like manner, and tested after the same interval by the second method. The old series was found (by the method of saving) to require on an average 5.85 repetitions for relearning, and the new 9.6; yet on the method of telling, the new series yielded 2.7 "hits," with an average time of about 1½ second for each, while the old yielded only .9 "hits," with an average time of 4½ seconds for each. Thus one may be able to reproduce relatively little of a given subject-matter, and yet require only a few repetitions in order to learn it off anew; on the other hand, one may know relatively much, and still find many more repetitions requisite for such complete learning. The "age" of the associations is then important. Other things being equal, we may conclude that each fresh repetition effects more for old associations than for recent ones. It might be supposed that the strength of the old associations was more uniform and on the average greater than the strength of the new; so that while none of the old were far below the threshold, few, if any, were above it; whereas more of the new might be above the threshold though the majority had lapsed entirely. And the latter would certainly be the case if the subject of experiment tried to make sure of a few "hits," and paid no attention to the rest of the series. Due care was, however, taken that the ends of the experiment should not in this way be defeated. Also, there is ample evidence to show that the supposed greater uniformity in strength of old associations is not, in fact, the rule. We seem left, then, to conjecture that the difference is the effect of the process of assimilation working subconsciously—that psychical aspect of nervous growth which Professor James has aptly characterized by saying that "we learn to skate in summer and to swim in winter." It continually happens that we can recognize connexions that we are quite unable to reproduce. To the diminished "strength" of an association, as tested by the

² There are still other forms of what seems at first sight to be regressive association, but none that do not admit of explanation without this assumption.

method of telling, there may then quite well be an equivalent set-off in more developed assimilation. As a seed germinates it has less latent energy, but this is replaced by growth in root and stem: similar relations may obtain when an old association is said merely to lose "strength." On the other hand—within the range of the primary memory-image—we can often reproduce what after a longer interval we should fail to recognize. We seem warranted, then, in concluding that this conception of "association-strength," so freely used by G. E. Müller and his co-workers, requires more analysis than it has yet received. The two factors which their methods disclose in it appear to confirm the distinction we have already made between impressions and free ideas. They help us also to understand, further, the superiority of distributed over cumulated repetition, of "inwardly digesting" over "cram."

Feeling.

31. Such summary survey as these limits allow of the more elementary facts of cognition is here at an end; so far the most conspicuous factors at work have been those of what might be termed the ideational mechanism. In the higher processes of thought we have to take more account of mental activity and of the part played by language. But it seems preferable, before entering upon this, to explore also the emotional and active constituents of mind in their more elementary phases.

In our preliminary survey we have seen that psychical life consists in the main of a continuous alternation of predominantly receptive and predominantly reactive consciousness. In its earliest form experience is simply an interplay of alternations of sensation and movement. At a later stage we find that in the receptive phase ideation is added to sensation; and that in the active phase thought and fancy, or the voluntary manipulation and control of the ideational trains, are added to the voluntary manipulation and control of the muscles. At this higher level also it is possible that either form of receptive consciousness may lead to either form of active: sensations may lead to thought rather than to action in the restricted sense, and ideas apart from sensations may prompt to muscular exertion. There is a further complication still: not only may either sensations or ideas lead to either muscular or mental movements, but movements themselves, whether of mind or limb, may as mere presentations determine other movements of either kind. In this respect, however, movements and thoughts either in themselves or through their sensational and ideational accompaniments may be regarded as pertaining to the receptive side of consciousness. With these provisos, then, the broad generalization may hold that receptive states lead through feeling to active states, and that presentations that give neither pleasure nor pain meet with no responsive action. But first the objection must be met that presentations that are in themselves purely indifferent lead continually to very energetic action, often the promptest and most definite action. To this there are two answers. First, on the higher levels of psychical life presentations in themselves indifferent are often indirectly interesting as signs of, or as means to, other presentations that are more directly interesting. It is enough for the present, therefore, if it be admitted that all such indifferent presentations are without effect as often as they are *not* instrumental in furthering the realization of some desirable end. Secondly, a large class of movements, such as those called sensori-motor and ideo-motor, are initiated by presentations that are frequently, it must be allowed, neither pleasurable nor painful. In all such cases, however, there is probably only an apparent exception to the principle of subjective selection. They may all be regarded as instances of another important psychological principle which we shall have to deal with more fully by and by, viz. that voluntary actions, and especially those that either only avert pain or are merely subsidiary to pleasure-giving actions, tend at length, as the effect of habit in the individual and of heredity in the race, to become "secondarily automatic," as it has been called. Such mechanical or instinctive dexterities make possible a more efficient use of present energies in securing pleasurable and interesting experiences, and, like the rings of former growths in a tree, afford a basis for further advance, as old interests fall and new ones present themselves. Here, again, it suffices for our present purpose if it be granted that there is a fair presumption in favour of supposing all such movements to have been originally initiated by feeling, as certainly very many of them were.

Of the feeling itself that intervenes between these sensory and motor presentations there is but little to be said. The chief points have been already insisted upon, viz. that it is not itself a presentation, but a purely subjective state, at once the effect of a change in receptive consciousness and the cause of a change in motor consciousness; hence its continual confusion either with the movements, whether ideational or muscular, that are its

expression, or with the sensations or ideas that are its cause. For feeling as such is, so to put it, matter of *being* rather than of direct knowledge; and all that we know about it we know from its antecedents or consequents in presentation.

Pure feeling, then, ranging solely between the opposite extremes of pleasure and pain, we are naturally led to inquire whether there is any corresponding contrast in the causes of feeling on the one hand, and on the other Causes of
Feeling. in its manifestations and effects. To begin with the first question, which we may thus formulate: What, if any, are the invariable differences characteristic of the presentations or states of mind we respectively like and dislike; or, taking account of the diverse sources of feeling—sensuous, aesthetic, intellectual, active—is there anything that we can predicate alike of all that are pleasurable and deny of all that are painful, and vice versa? It is at once evident that at least in presentations objectively regarded no such common characters will be found; if we find them anywhere it must be in some relation to the conscious subject *i.e.* in the fact of presentation itself. There is one important truth concerning pleasures and pains that may occur at once as an answer to our inquiry, and that is often advanced as such, viz. that whatever is pleasurable tends to further and perfect life, and whatever is painful to disturb or destroy it. The many seeming exceptions to this law of self-conservation, as it has been called, probably all admit of explanation in conformity with it, so as to leave its substantial truth unimpeached.¹ But this law, however stated, is too teleological to serve as a purely psychological principle, and, as generally formulated and illustrated, it takes account of matters quite outside the psychologist's ken. We are not now concerned to know *why* a bitter taste *e.g.* is painful or the gratification of an appetite pleasant, but *what* marks distinctive of all painful presentations the one has and the other lacks. From a biological standpoint it may be true enough that the final cause of sexual and parental feelings is the perpetuation of the species; but this does not help us to ascertain what common character they have as actual sources of feeling for the individual. From the biological standpoint again, even the senile decadence and death of the individual may be shown to be advantageous to the race; but it would certainly be odd to describe this as advantageous to the individual; so different are the two points of view. What we are in search of, although a generalization, has reference to something much more concrete than concepts like race or life, and does not require us to go beyond the consciousness of the moment to such ulterior facts as they imply.

Were it possible it would be quite unnecessary to examine in detail every variety of pleasurable and painful consciousness in connexion with a general inquiry of this sort. It will be best to enumerate at the outset the only cases that specially call for investigation. Feeling may arise mainly from (a) single sensations or movements, including in these what recent psychologists call their *tone*; or it may be chiefly determined by (b) some combination or arrangement of these primary presentations—hence what might be styled the lower aesthetic feelings. We have thus among primary presentations a more material and a more formal cause or ground of feeling. The mere representation of these sources of feeling involves nothing of moment: the idea of a bright colour or a bitter taste has not definiteness or intensity enough to produce feeling; and the ideal presentation of a harmonious arrangement of sounds or colours does not in itself differ essentially as regards the feeling it occasions from the actual presentation. When we advance to the level at which there occur ideas more complex and more highly representative—or re-representative, as Mr Spencer would say—than any we have yet considered we can again distinguish between material and formal grounds of feeling. To the first we might refer, *e.g.* (c) the egoistic, sympathetic, and religious feelings; this class will probably require but brief notice. The second, consisting of (d) the intellectual and (e) the higher aesthetic feelings, is psychologically more important. There is a special class of

¹ See Spencer, *Data of Ethics*, chs. i.-iv.; G. H. Schneider, *Freud und Leid des Menschengeschlechts*, ch. i.

feelings, which might be distinguished from all the preceding as *reflex*, since they arise from the memory or expectation of feelings but in fact these are largely involved in all the higher feelings, and this brief reference to them will suffice: of such hope, fear, regret are examples.

a. The quality and intensity as well as the duration and frequency of a sensation or movement all have to do with *Sensations and Movements* determining to what feeling it gives rise. It will be best to leave the last two out of account for a time. Apart from these, the pleasantness or painfulness of a movement appears to depend solely upon its intensity, that is to say, upon the amount of effort necessary to effect it, in such wise that a certain amount of exertion is agreeable and any excess disagreeable. Some sensations also, such as those of light and sound, are agreeable if not too intense, their pleasantness increasing with their intensity up to a certain point, on nearing which the feeling rapidly changes and becomes disagreeable or even painful. Other sensations, as bitter tastes, *e.g.* are naturally unpleasant, however faint—though we must allow the possibility of an acquired liking for moderately bitter or pungent flavours. But in every case such sensations produce unmistakable manifestations of disgust, if at all intense. Sweet tastes, on the other hand, however intense, are pleasant to an unspoiled palate, though apt before long to become mawkish, like "sweetest honey, loathsome in his own deliciousness," as confectioners' apprentices are said soon to find. The painfulness of all painful sensations or movements increases with their intensity without any assignable maximum being reached.

A comparison of examples of this kind, which it would be tedious to describe more fully and which are indeed too familiar to need much description, seems to show (1) that, so far as feeling is determined by the intensity of a presentation, there is pleasure so long as attention can be adapted or accommodated to the presentation, and pain so soon as the intensity is too great for this; and (2) that, so far as feeling is determined by the quality of a presentation, those that are pleasurable enlarge the field of consciousness and introduce or agreeably increase in intensity certain organic sensations, while those that are painful contract the field of consciousness and introduce or disagreeably increase in intensity certain organic sensations. There are certain other hedonic effects due to quality, the examination of which we must for the present defer. Meanwhile as to the first point it may be suggested, as at any rate a working hypothesis, that in itself any and every simple sensation or movement is pleasurable if there is attention forthcoming adequate to its intensity. In the earliest and simplest phases of life, in which the presentation-continuum is but little differentiated, it is reasonable to suppose that variation in the intensity of presentation preponderates over changes in the quality of presentation, and that to the same extent feeling is determined by the former and not by the latter. And, whereas this dependence on intensity is invariable, there is no ground for supposing the quality of any primary presentation, when not of excessive intensity, to be invariably disagreeable; the changes above-mentioned in the hedonic effects of bitter tastes, sweet tastes, or the like tend rather to prove the contrary. This brings us to the second point, and it requires some elucidation. We need here to call to mind the continuity of our presentations and especially the existence of a background of organic sensations or somatic consciousness, as it is variously termed. By the time that qualitatively distinct presentations have been differentiated from this common basis it becomes possible for any of these, without having the intensity requisite to affect feeling directly, to change it indirectly by means of the systemic sensations accompanying them, or, in other words, by their tone. The physiological concomitants of these changes of somatic tone are largely reflex movements or equivalents of movements, such as alterations in circulatory, respiratory and excretory processes. Such movements are psychologically movements no longer, and are rightly regarded as pertaining wholly to the sensory division of presentations. But originally it may have been otherwise. To us now, these organic reflexes seem but part and parcel of the special sensation whose tone they

form, and which they accompany even when that sensation, so far as its mere intensity goes, might be deemed indifferent. But perhaps at first the special qualities that are now throughout unpleasant may have been always presented with an excessive intensity that would be painful on this score alone, and the reflexes that at present pertain to them may then have been psychologically the expression of this pain.¹ At any rate it is manifestly unfair to refuse either to seek out the primitive effects of the sensations in question and allow for the workings of heredity, or to reckon this accompanying systemic feeling as part of them. The latter seems the readier and perhaps, too, the preferable course. A word will now suffice to explain what is meant by enlarging and contracting the field of consciousness and agreeably increasing or decreasing certain elements therein.

The difference in point is manifest on comparing the flow of spirits, buoyancy and animation which result from a certain duration of pleasurable sensations with the lowness or depression of spirits, the gloom and heaviness of heart, apt to ensue from prolonged physical pain. Common language, in fact, leaves us no choice but to describe these contrasted states by figures which clearly imply that they differ in the range and variety of the presentations that make up consciousness, and in the quickness with which these succeed each other.² It is not merely that in hilarity as contrasted with dejection the train of ideas takes a wider sweep and shows greater liveliness, but as it were at the back of this, on the lower level of purely sensory experience, certain organic sensations which are ordinarily indifferent acquire a gentle intensity, which seems by flowing over to quicken and expand the ideational stream as we see, for instance, in the effects of mountain air and sunshine. Or, on the other hand, these sensations become so violently intense as to drain off and ingulf all available energy in one monotonous corroding care, an oppressive weight which leaves no place for free movement, no life or leisure to respond to what are wont to be pleasurable solicitations.³

As regards the duration and the frequency of presentation, it is in general true that the hedonic effect soon attains its maximum, and then, if pleasant, rapidly declines, or even changes to its opposite. Pains in like manner decline, but more slowly and without in the same sense changing to pleasures. The like holds of too frequent repetition. Physiological explanation of these facts, good as far as it goes, is, of course, at once forthcoming: sensibility is blunted, time is required for restoration, and so forth; but at least we want the psychological equivalent of all this. In one respect we find nothing materially new; so

¹ In the lowly organisms that absorb food directly through the skin such bitter juices as exist naturally might at once produce very violent effects—comparable, say, to scalding; and the reflexes then established may have been continued by natural selection so as to save from poisoning the higher organisms, whose absorbent surfaces are internal and only guarded in this way by the organ of taste. Some light is thrown on questions of this kind by the very interesting experiments of Dr Romanes; for a general account of these see his *Jelly-fish, Star-fish, and Sea-urchins*, ch. ix.

² This is one among many cases in which the study of a vocabulary is full of instruction to the psychologist. The reader who will be at the trouble to compare the parallel columns under the heading "Passive Affections," in Roget's *Thesaurus of English Words and Phrases*, will find ample proof both of this general statement and of what is said above in the text.

³ Observation and experiment show that the physical signs of pain in the higher animals consist in such changes as a lowered and weaker pulse, reduction of the surface temperature, quickened respiration, dilatation of the iris, and the like. And so far as can be ascertained these effects are not altogether the emotional reaction to pain but in large measure its actual accompaniments, the physical side of what we have called its *tone*. The following is a good description of these general characteristics of feeling: "En même temps, il se fait une série de mouvements généraux de flexion, comme si l'animal voulait se rendre plus petit, et offrir moins de surface à la douleur. Il est intéressant de remarquer que, pour l'homme comme pour tous les animaux, on retrouve ces mêmes mouvements généraux de flexion et d'extension répondant aux sentiments différents de plaisir et de la douleur. Le plaisir répond à un mouvement d'épanouissement, de dilatation, d'extension. Au contraire, dans la douleur, on se rapetisse, on se referme sur soi; c'est un mouvement général de flexion" (C. Richet, *L'Homme et l'Intelligence: la douleur*, p. 9).

far as continued presentation entails diminished intensity we have nothing but diminished feeling as a consequence; so far as its continued presentation entails satiety the train of agreeable accompaniments ceases in which the pleasurable tone consisted. But in another way long duration and frequent repetition produce indirectly certain characteristic effects on feeling in consequence of habituation and accommodation. We may get used to a painful presentation in such wise that we cease to be conscious of it as positively disagreeable, though its cessation is at once a source of pleasure; in like manner we come to require things simply because it is painful to be without them, although their possession has long ceased to be a ground of positive enjoyment. This loss (or gain) consequent on accommodation¹ has a most important effect in changing the sources of feeling: it helps to transfer attention from mere sensations to what we may distinguish as interests.

b. Certain sensations or movements not separately unpleasant become so when presented together or in immediate succession; and contrariwise, some combinations of sensations or of movements may be such as to afford pleasure distinct from, and often greater than, any that they separately yield. Here again we find that in some cases the effect seems mainly to depend on

intensity, in others mainly on quality. (i.) As instances of the former may be mentioned the pleasurable of a rhythmic succession of sounds or movements, of symmetrical forms and curved outlines, of gentle crescendos and diminuendos in sound, and of gradual variations of shade in colour, and the painfulness of flickering lights, "beats" in musical notes, false time, false steps, false quantities, and the like. In all these, whenever the result is pleasurable, attention can be readily accommodated—is, so to say, economically meted out; and, whenever the result is painful, attention is surprised, balked, wasted. Thus we can make more movements and with less expenditure of energy when they are rhythmic than when they are not, as the performances of a ball-room or of troops marching to music amply testify. Of this economy we have also a striking proof in the ease with which rhythmic language is retained. (ii.) As instances of the latter may be cited those arrangements of musical tones and of colours that are called harmonious or the opposite. Harmony, however, must be taken to have a different meaning in the two cases. When two or three tones harmonize there results, as is well known, a distinct pleasure over and above any pleasure due to the tones themselves. On the other hand, tones that are discordant are unpleasant in spite of any pleasantness they may have singly. Besides the negative condition of absence of beats, a musical interval to be pleasant must fulfil certain positive conditions, sufficiently expressed for our purpose by saying that two tones are pleasant when they give rise to few combination-tones, and when among these there are several that coincide, and that they are unpleasant when they give rise to many combination-tones, and when among these there are few or none that coincide. Too many tones together prevent any from being distinct. But where tones coincide the number of tones actually present is less than the number of possible tones, and there is a proportionate simplification, so to put it: more is commanded and with less effort. An ingenious writer² on harmony, in fact, compares the confusion of a discord to that of "trying to reckon up a sum in one's head and failing because the numbers are too high." A different explanation must be given of the so-called harmonies of colour. The pleasurable effect of graduations of colour or shade—to which, as Ruskin tells us, the rose owes its victorious beauty when compared with other flowers—has been already mentioned: it is rather a quantitative than a qualitative effect. What we are

¹ It has been definitely formulated, but in physiological language, by Bain as the Law of Novelty: "No second occurrence of any great shock or stimulus, whether pleasure, pain, or mere excitement, is ever fully equal to the first, notwithstanding that full time has been given for the nerves to recover from their exhaustion" (*Mind and Body*, p. 51). Cf. also his *Emotions and Will*, 3rd ed., p. 83.

² Preyer, *Akustische Untersuchungen*, p. 59

now concerned with are the pleasurable or painful combinations of different ungraduated colours. A comparison of these seems to justify the general statement that those colours yield good combinations that are far apart in the colour circle, while those near together are apt to be discordant. The explanation given, viz. that the one arrangement secures and the other prevents perfect retinal activity, seems on the whole satisfactory—especially if we acknowledge the tendency of all recent investigations and distinguish sensibility to colour and sensibility to mere light as both psychologically and physiologically two separate facts. Thus, when red and green are juxtaposed, the red increases the saturation of the green and the green that of the red, so that both colours are heightened in brilliance. But such an effect is only pleasing to the child and the savage; for civilized men the contrast is excessive, and colours less completely opposed, as red and blue, are preferred, each being a rest from the other, so that as the eye wanders to and fro over their border different elements are active by turns. Red and orange, again, are bad, in that both exhaust in a similar manner and leave the remaining factors out of play.

c. The more or less spontaneous workings of imagination, as well as that direct control of this working necessary to thinking in the stricter sense, are always productive of pain or pleasure in varying degrees. Though the *Ideation and Intellection.* position of the higher intellectual processes has not yet been reached, there will be no inconvenience in at once taking account of their effects on feeling, since these are fairly obvious and largely independent of any analysis of the processes themselves. It will also be convenient to include under the one term "intellectual feelings," not only the feelings connected with certainty, doubt, perplexity, comprehension, and so forth, but also what the Herbartian psychologists—whose work in this department of psychology is classical—have called *par excellence* the formal feelings—that is to say, feelings which they regard as entirely determined by the form of the flow of ideas, and not by the ideas themselves. Thus, be the ideas what they may, when their onward movement is checked by divergent or obstructing lines of association, and especially when in this manner we are hindered, say, from recollecting a name or a quotation (as if, e.g. the names of Archimedes, Anaximenes and Anaximander each arrested the clear revival of the other), we are conscious of a certain strain and oppressiveness, which give way to momentary relief when at length what is wanted rises into distinct consciousness and our ideas resume their flow. Here again, too, as in muscular movements, we have the contrast of exertion and facility, when "thoughts refuse to flow" and we work "invita Minerva," or when the appropriate ideas seem to unfold and display themselves before us like a vision before one inspired. To be confronted with propositions we cannot reconcile—i.e. with what is or appears inconsistent, false, contradictory—is apt to be painful; the recognition of truth or logical coherence, on the other hand, is pleasurable. The feeling in either case is, no doubt, greater the greater our interest in the subject-matter; but the mere conflict of ideas as such is in itself depressing, while the discernment of agreement, of the one in the many, is a distinct satisfaction. Now in the one case we are conscious of futile efforts to comprehend as one ideas which the more distinctly we apprehend them for the purpose only prove to be the more completely and diametrically opposed: we can only affirm and mentally envisage the one by denying and suppressing the representation of the other; and yet we have to strive to predicate both and to embody them together in the same mental image. Attention is like a house divided against itself: there is effort but it is not effective, for the field of consciousness is narrowed and the flow of ideas arrested. When, on the other hand, we discern a common principle among diverse and apparently disconnected particulars, instead of all the attention we can command being taxed in the separate apprehension of these "dissecta membra," they become as one, and we seem at once to have at our disposal resources for the command of an enlarged field and the detection of new resemblances.

d. Closely related to these formal intellectual feelings are certain of the higher aesthetic feelings. A reference to some of the commonplaces of aesthetical writers may be sufficient briefly to exhibit the leading characteristics of these feelings. There is a wide agreement among men in general as to what is beautiful and what is not, and it is the business of a treatise on empirical aesthetics from an analysis of these matters of fact to generalize the principles of taste—to do, in fact, for one source of pleasure and pain what we are here attempting in a meagre fashion for all. And these principles are the more important in their bearing upon the larger psychological question, because among aesthetic effects are reckoned only such as are pleasing or otherwise in themselves, apart from all recognition of utility, of possession, or of ulterior gratification of any kind whatever. Thus, if it should be objected that the intellectual satisfaction of consistency is really due to its utility, to the fact that what is incompatible and incomprehensible is of no avail for practical guidance, at least this objection will not hold against the aesthetic principle of *unity in variety*. In accordance with this primary maxim of art criticism, at the one extreme art productions are condemned for monotony, as incapable of sustaining interest because “empty,” “bald” and “poor”; at the other extreme they are condemned as too incoherent and disconnected to furnish a centre of interest. And those are held as so far praiseworthy in which a variety of elements, be they movements, forms, colours or incidents, instead of conflicting, all unite to enhance each other and to form not merely a mass but a whole. Another principle that serves to throw light on our inquiry is that which has been called the principle of *economy*,¹ viz. that an effect is pleasing in proportion as it is attained by little effort and simple means. The brothers Weber in their classic work on human locomotion discovered that those movements that are aesthetically beautiful are also physiologically correct; grace and ease, in fact, are well-nigh synonymous, as Herbert Spencer points out, and illustrates by apt instances of graceful attitudes, motions and forms. The same writer,² again, in seeking for a more general law underlying the current maxims of writers on composition and rhetoric is led to a special formulation of this principle as applied to style, viz. that “economy of the recipient’s attention is the secret of effect.”

Perhaps of all aesthetical principles the most wide-reaching, as well as practically the most important, is that which explains aesthetic effects by association. Thus, to take one example where so many are possible, the croaking of frogs and the monotonous ditty of the cuckoo owe their pleasantness, not directly to what they are in themselves, but entirely to their intimate association with spring-time and its gladness. At first it might seem, therefore, that in this principle there is nothing fresh that is relevant to our present inquiry, since a pleasure that is only due to association at once carries back the question to its sources; so that in asking why the spring, for example, is pleasant we should be returning to old ground. But this is not altogether true; aesthetic effects call up not merely ideas but ideals. A great work of art improves upon the real in two respects: it intensifies and it transfigures. It is for art to gather into one focus, cleared from dross and commonplace, the genial memories of a lifetime, the instinctive memories of a race; and, where theory can only classify and arrange what it receives, art—in a measure free from “the literal unities of time and place”—creates and glorifies. Still art eschews the abstract and speculative; however plastic in its hands, the material wrought is always that of sense. We have already noticed more than once the power which primary presentations have to sustain vivid re-presentations, and the bearing of this on the aesthetic effects of works of art must be straightway obvious. The notes and colours, rhymes and rhythms, forms and movements, which produce the lower aesthetic feelings also serve as the means of bringing into view,

¹ Cf. Fechner, *Vorschule der Aesthetik*, ii. 263. Fechner’s full style for it is “Princip der ökonomischen Verwendung der Mittel oder des kleinsten Kraftmasses.”

² *Essays, Scientific, Political and Speculative*, vol. ii., Ess. I. and VIII.

and maintaining at a higher level of vividness, a wider range and flow of pleasing ideas than we can ordinarily command.

When we reach the level at which there is distinct self-consciousness (cf. § 44), we have an important class of feelings determined by the relation of the present-*Egoistic* and feeling of self to the other contents of consciousness. *Socialistic* And as the knowledge of other selves advances *pari passu* with that of one’s own self, so along with the egoistic feelings appear certain social or altruistic feelings. The two have much in common; in pride and shame, for example, account is taken of the estimate other persons form of us and of our regard for them; while, on the other hand, when we admire or despise, congratulate or pity another, we have always present to our mind a more or less definite conception of self in like circumstances. It will therefore amply serve all the ends of our present inquiry if we briefly survey the leading characteristics of some contrasted egoistic feelings, such as self-complacency and disappointment. When a man is pleased with himself, his achievements, possessions or circumstances, such pleasure is the result of a comparison of his present position in this respect with some former position or with the position of someone else. Without descending to details, we may say that two prospects are before him, and the larger and fairer is recognized as his own. Under disappointment or reverse the same two pictures may be present to his mind, but accompanied by the certainty that the better is not his or is his no more. So far, then, it might be said the contents of his consciousness are in each case the same, the whole difference lying in the different relationship to self. But this makes all the difference even to the contents of his consciousness, as we shall at once see if we consider its active side. Even the idlest and most thoughtless mind teems with intentions and expectations, and in its prosperity, like the fool in the parable, thinks to pull down its barns and build greater, to take its ease, eat, drink and be merry. The support of all this pleasing show and these far-reaching aims is, not the bare knowledge of what abundance will do, but the reflection—These many goods are mine. In mind alone final causes have a place, and the end can produce the beginning; the prospect of a summer makes the present into spring. But action is paralysed or impossible when the means evade us. In so far as a man’s life consists in the abundance of the things he possesseth, we see then why it dwindles with these. The like holds where self-complacency or displicency rests on a sense of personal worth or on the honour or affection of others.

32. We are now at the end of our survey of certain typical pleasurable and painful states. The answer to our inquiry which it seems to suggest is that there is pleasure in proportion as a maximum of attention is effectively exercised, and pain in proportion as such effective attention is frustrated by distractions, shocks, or incomplete and faulty adaptations, or fails of exercise, owing to the narrowness of the field of consciousness and the slowness and smallness of its changes. Something must be said in explication of this formula, and certain objections that might be made to it must be considered. First of all it implies that feeling is determined partly by quantitative, or, as we might say, material conditions, and partly by conditions that are formal or qualitative. As regards the former, both the intensity or concentration of attention and its diffusion or the extent of the field of consciousness have to be taken into account. Attention, whatever else it is, is a limited quantity—

Pluribus intentus minor est ad singula sensus—

to quote Hamilton’s pet adage. Moreover, as we have seen, attention requires time. If, then, attention be distributed over too wide a field, there is a corresponding loss of intensity, and so of distinctness: we tend towards a succession of indistinguishables—indistinguishable, therefore, from no succession. We must not have more presentations in the field of consciousness than will allow of some concentration of attention: a maximum diffusion will not do. A maximum concentration, in like manner—even if there were no other objection to it—

would seem to conflict with the general conditions of consciousness, inasmuch as a single simple presentation, however intense, would admit of no differentiation, and any complex presentation is in some sort a plurality. The most effective attention, then, as regards its quantitative conditions, must lie somewhere between the two zeros of complete indifference and complete absorption. If there be an excess of diffusion, effective attention will increase up to a certain point as concentration increases, but beyond that point will decrease if this intensification continues to increase; and vice versa, if there be an excess of concentration. But, inasmuch as these quantitative conditions involve a plurality of distinguishable presentations or changes in consciousness, the way is open for formal conditions as well. Since different presentations consort differently when above the threshold of consciousness together, one field may be wider and yet as intense as another, or intenser and yet as wide, owing to a more advantageous arrangement of its constituents.¹

The doctrine here developed, viz., that feeling depends on efficiency, is in the main as old as Aristotle; all that has been

done is to give it a more accurately psychological expression, and to free it from the implications of the faculty theory, in which form it was expounded

by Hamilton. Of possible objections there are at least two that we must anticipate, and the consideration of which will help to make the general view clearer. First, it may be urged that, according to this view, it ought to be one continuous pain to fall asleep, since in this state consciousness is rapidly restricted both as to intensity and range. This statement is entirely true as regards the intensity and substantially true as regards the range, at least of the higher consciousness: certain massive and agreeable organic sensations pertain to falling asleep, but the variety of presentations at all events grows less. But then the capacity to attend is also rapidly declining; even a slight intruding sensation entails an acute sense of strain in one sense, in place of the massive pleasure of repose throughout; and any voluntary concentration either in order to move or to think involves a like organic conflict, futile effort, and arrest of balmy ease. There is as regards the more definite constituents of the field of consciousness a close resemblance between natural sleepiness and the state of monotonous humdrum we call tedium or ennui; and yet the very same excitement that would relieve the one by dissipating the weariness of inaction would disturb the other by renewing the weariness of action: the one is commensurate with the resources of the moment, the other is not. Thus the maximum of effective attention in question is, as Aristotle would say, a maximum "relative to us." It is possible, therefore, that a change from a wider to a narrower field of consciousness may be a pleasurable change, if attention is more effectively engaged. Strictly speaking, however, the so-called negative pleasures of rest do not consist in a mere narrowing of the field of consciousness so much as in a change in the amount of concentration. Massive organic sensations connected with restoration take the place of the comparatively acute sensations of jaded powers forced to work. We have, then, in all cases to bear in mind this subjective relativity of all pleasurable or painful states of consciousness.

¹ As it is impossible to say that any distinguishable presentation is absolutely simple, the hypothesis of subconsciousness would leave us free to assume that any pleasantness or unpleasantness that cannot be explained on the score of intensity is due to some obscure harmony or discord, compatibility or incompatibility, of elements not separately discernible. But this, though tempting, is not really a very scientific procedure. If a particular presentation is pleasurable or painful in such wise as to lead to a redistribution of attention, it is reasonable to look for an explanation primarily in its connexion with the rest of the field of consciousness. Moreover, it is obvious—since what takes place in subconsciousness can only be explained in analogy with what takes place in consciousness—that, if we have an inexplicable in the one, we must have a corresponding inexplicable in the other. If the feeling produced by what comports itself as a simple presentation cannot be explained by what is in consciousness, we should be forced to admit that some presentations are unpleasant simply because they are unpleasant—an inexplicability which the hypothesis of subconsciousness might push farther back but would not remove.

33. But there is still another and more serious difficulty to face. It has long been a burning question with theoretical moralists whether pleasures differ only quantitatively or differ qualitatively as well, whether psychological analysis will justify the common distinction of higher and lower pleasures or force us to recognize nothing but differences of degree, of duration, and so forth—as expounded, e.g. by Bentham, whose cynical *mol*, "pushpin is as good as poetry provided it be as pleasant," was long a stumbling block in the way of utilitarianism. The entire issue here is confused by an ambiguity in terms that has been already noticed: pleasure and pleasures have not the same connotation. By a pleasure or pleasures we mean some assignable presentation or presentations experienced as pleasant—i.e. as affording pleasure; by pleasure simply is meant this subjective state of feeling itself. The former, like other objects of knowledge, admit of classification and comparison: we may distinguish them as coarse or as noble, or, if we will, as cheap and wholesome. But while the causes of feeling are manifold, the feeling itself is a subjective state, varying only in intensity and duration. The best evidence of this lies in the general character of the actions that ensue through feeling—the matter which has next to engage us. Whatever be the variety in the sources of pleasure, whatever be the moral or conventional estimate of their worthiness, if a given state of consciousness is pleasant we seek so far to retain it, if painful to be rid of it: we prefer greater pleasure before less, less pain before greater. This is, in fact, the whole meaning of preference as a psychological term. Wisdom and folly each prefer the course which the other rejects. Both courses cannot, indeed, be objectively preferable; that, however, is not a matter for psychology. But as soon as reflection begins, exceptions to this primary principle of action seem to arise continually, even though we regard the individual as a law to himself. Such exceptions, however, we may presently find to be apparent only. At any rate the principle is obviously true before reflection begins—true so long as we are dealing with actually present sources of feeling, and not with their re-presentations. But to admit this is psychologically to admit everything, at least if experience is to be genetically explained. Assuming then that we start with only quantitative variations of feeling, we have to attempt to explain the development of formal and qualitative differences in the character given to the grounds of feeling. But, if aversions and pursuits result from incommensurable states of pain and pleasure, there seems no other way of saving the unity and continuity of the subject except by speculative assumption—the doctrine known as the freedom of the will in its extremest form. The one position involves the other, and the more scientific course is to avoid both as far as we can.

The question, then, is: How, if action depends in the last resort on a merely quantitative difference, could it ever come about that what we call the higher sources of feeling should supersede the lower? If it is only quantity that turns the scales, where does quality come in, for we cannot say, e.g. that the astronomer experiences a greater thrill of delight when a new planet rewards his search than the hungry savage in finding a clump of pig-nuts? *Tempora mutantur nos et mutamur in illis* contains the answer in brief. We shall understand this answer better if we look at a parallel case, or what is really our own from another point of view. We distinguish between higher and lower forms of life: we might say there is more life in a large oyster than in a small one, other things being equal, but we should regard a crab as possessing not necessarily more life—as measured by waste of tissue—but certainly as manifesting life in a higher form. How, in the evolution of the animal kingdom, do we suppose this advance to have been made? The tendency at any one moment is simply towards more life, simply towards growth; but this process of self-conservation imperceptibly but steadily modifies the self that is conserved. The creature is bent only on filling its skin; but in doing this as easily as may be it gets a better skin to fill, and accordingly seeks to fill it differently. Though cabbage and boney are what

they were before, they have changed relatively to the grub now it has become a butterfly. So, while we are all along preferring a more pleasurable state of consciousness before a less, the content of our consciousness is continually changing; the greater pleasure still outweighs the less, but the pleasures to be weighed are either wholly different, or at least are the same for us no more. What we require then, is not that the higher pleasures shall always afford greater pleasure than the lower did, but that to advance to the level of life on which pleasure is derived from higher objects shall on the whole be more pleasurable and less painful than to remain behind. And this condition seems provided in the fact of accommodation above referred to and in the important fact that attention can be more effectively expended by what we may therefore call improvements in the form of the field of consciousness. But when all is said and done a certain repugnance is apt to arise against any association of the differences between the higher and lower feelings with differences of quantity. Yet such repugnance is but another outcome of the common mistake of supposing that the real is obtained by pulling to pieces rather than by building up. No logical analysis—nay, further, no logical synthesis—is adequate to the fullness of things. For the rest, such aversion is wholly emotional, and has no more an intellectual element in it than has the disgust we feel on first witnessing anatomical dissections.¹

Emotion and Emotional Expression.

34. We now pass from the causes of feeling to its effects. We have assumed (§ 7) that the simplest and earliest of these effects are to be found in the various bodily movements commonly described as the expression or manifestation of emotion. But in a notorious article, entitled "What is an Emotion?" Professor James² attempted to turn this, the common-sense position, upside down. Before proceeding we must, therefore, examine his alternative theory: "Common sense says: we lose our fortune, are sorry and weep; we meet a bear, are frightened and run; we are insulted by a rival, are angry and strike." But, Professor James continues, "the hypothesis here to be defended says that this order of sequence is incorrect: that the one mental state is not immediately induced by the other, that the bodily manifestations must first be interposed between, and that the more rational statement is that we feel sorry because we cry, angry because we strike, afraid because we tremble, and not that we cry, strike or tremble because we are sorry, angry or fearful, as the case may be." In a word, whereas it is commonly supposed that the emotion precedes and produces the expression, it seems here to be maintained that the expression precedes and produces the emotion. But the sequence denied in the first case is a psychological sequence, the sequence maintained in the second is a physiological sequence. The subject's experiences of the bodily expressions is here the emotion, and these are physically, not psychically, determined. "They are sensational processes," says Professor James; "processes due to inward currents set up by physical happenings."

The new theory is, then, in part psychological, in part psychophysical. As to the first part, which the author calls "the vital point of the whole theory," it consists mainly in exposing the ambiguity of the phrase "bodily expression of an emotion"—a phrase which is liable to mislead us into fancying that

¹ "To look at anything in its elements makes it appear inferior to what it seems as a whole. Resolve the statue or the building into stone and the laws of proportion, and no worthy causes of the former beautiful result seem now left behind. So, also, resolve a virtuous act into the passions and some quantitative law, and it seems to be rather destroyed than analysed, though after all what was there else it could be resolved into?" Sir A. Grant, *Aristotle's Ethics*, Essay IV., "The Doctrine of the Mean," i. 210 (2nd ed.).

² *Mind* (1884), ix. 188 sqq.; and, again, *Principles of Psychology*, ch. xxv. Very similar views were advanced independently and almost at the same time by the Danish physiologist C. Lange; hence the name James-Lange theory, by which their views are commonly known. Of Lange's work a German translation was published in 1887.

emotion, like thought, may be antecedent to, or independent of, any expression or utterance. My fear or anger may chance to be *expressive* to another, but they are of necessity *impressive* to me. "A disembodied human emotion is a sheer nonentity." In so far as I have a certain emotion, in so far I have "the feelings of its bodily symptoms." This is true, not to say trite; but how do these symptoms arise? With this question we pass to the psychophysical side of the theory, and here it becomes perplexing, and is itself perplexed; for to this question it is driven to return two distinct and divergent answers. First, we are told that it is not the emotion that gives rise to the bodily expression, but that, on the contrary, "the bodily changes follow directly the perception of the existing fact," it being beyond doubt "that objects do excite bodily changes by a preorganised mechanism." Again: "Each emotion is," for Professor James, "a resultant of a sum of elements, and each element is caused by a physiological process of a sort already well known. The elements are all organic changes, and each of them is *the reflex effect of the existing object.*" The old attempts at classification and description being contemptuously dismissed as belonging only to "the lowest stage of science," we are informed that now we step from a superficial to a deep order of inquiry. "The questions now are *causal*: 'Just what changes does this object and what changes does that object excite?' and 'How come they to excite these particular changes, and not others?'" But we have not had to wait for the James-Lange theory to raise these questions, and surely there are none that bring out its defects more glaringly. "Objects" that determine bodily changes by means of preorganized mechanism and without psychical interposition might fairly be taken to be physical objects; and indeed the whole process is expressly described as reflex. But only very slovenly physiologists talk of "objects" exciting reflexes: it is inexact even to say that sensations do so. All that reflex action requires is a *stimulus*. "The essence of a reflex action," says Foster, "consists in the transmutation, by means of the irritable protoplasm of a nerve-cell, of afferent into efferent impulses." Let Professor James be confronted first by a chained bear and next by a bear at large: to the one object he presents a bun, and to the other a clean pair of heels; or let him first be thrilled by a Beethoven symphony and then by a Raphael Madonna. Will he now undertake to account, in terms of stimuli and their reflex effects, for the very different results of the similar "causes" in the one case, or for the similar results of the very different "causes" in the other? Such a challenge would certainly be declined, and Professor James would remind us that in his nomenclature "it is the total situation on which the reaction of the subject is made."³ But there is just a world of difference between "object"=stimulus transformed by preorganised mechanism into an efferent discharge, and "object"=total situation to which the subject reacts. The attempt to explain emotion causally on the lines of the former meaning lands us in the conscious automaton theory, with which we must deal presently: this Professor James rejects. The latter meaning, on the other hand, involves the recognition of the subject's attitude as essential to the reaction, and of this as determined by pleasure, pain or by some "interest" resting ultimately on these. Such, with scarcely an exception, has always been, and still remains, the analysis of emotion in vogue among psychologists. It brings to the fore a new category, that of worth or value, one wholly extraneous to the physiologist's domain, and repugnant to the mechanical analogies which are there in place. No doubt such a concept is attained only by reflexion, but the experiences from which it is drawn, the affective states and the conative tendencies of the subject experiencing, must have preceded. From this central standpoint alone the objective situation has a worth which explains the subject's attitude, and here alone can we find the clue which

³ "Physical Basis of Emotion," *Psychological Review* (1894), p. 518. In this reply to criticisms Professor James is supposed to have modified his views: it would be nearer the truth to say that he has made admissions incompatible with them.

will enable us to answer the questions of cause that Professor James propounds.

The experimental investigations of Mosso, Féré, Lehmann, and others have shown that the vaso-motor and such like bodily changes as are prominent in emotional excitement are present also to some extent in all forms of conscious activity. The more unwanted and interesting the situation, the more diffused movements predominate over movements that are purposive; the further assimilation, both on the cognitive and the reactive side, has advanced, the more diffusion is replaced by restriction and adaptation. But we are not warranted in separating these factors of voluntary activity into distinct processes, as the physiologist, for example, separates the functions of striped and unstriped muscle. Unless we are prepared to treat *all* activity as reflex—as the physiologist may quite well do, if he keep strictly to his own point of view—it does not seem possible to regard emotional expression as so much organic sensation with which purposive movement has nothing to do. No doubt this connexion of vegetal and animal functions remains one of the obscurest in all psycho-biology, though its teleological fitness is obvious enough.

Nevertheless, Professor James's main position is that an emotion is but a sum of organic sensations; and in order to establish this he is led to the second and very different statement which we have now to examine. Here, so far from suggesting inquiries as to the "objects" that excite emotion, his point is to maintain that in so far as the bodily cause is set up, *be the means what they may*, in so far as the emotion is present.¹ And here, at length, the contention is explicit: Emotions are a certain complex of organic sensations, and such complexes are emotions: the two are not merely coexistent, they are identical. The exciting object is thus, after all, physiological; that is to say, it is whatever stimulus sets up the sensations. It cannot be psychological, "the total situation for the reacting subject," for in this sense the emotion, it is maintained, may be "objectless." In support of his position Professor James first of all cites pathological cases of such objectless emotion. He next follows up these with accounts of other cases in which emotional apathy seemed to keep pace with sensory anaesthesia, arguing that, according to his theory, a subject absolutely anaesthetic should also be incapable of emotion, although "emotion-inspiring objects might evoke the usual bodily expression from him." Whether *any* testimony from lunatics, hypnotics and other minds diseased could suffice to establish this novel doctrine is questionable: that the evidence so far adduced is insufficient, Professor James himself seems to allow. There are some four or five of the apathetic cases altogether: three of them are regarded by the mental pathologists who describe them as adverse to Professor James's theory.² Of the fourth case, reported by a pathologist on Professor James's side, the latter himself candidly observes, "We must remember that the patient's inemotivity may have been a co-ordinate result with the anaesthesia of his neural lesions, and not the anaesthesia's mere effect." This missing link in the argument is supplied by the experiments of Professor Sherrington,³ and these show conclusively that normal emotional states are possible along with complete visceral anaesthesia. As to emotional excitement induced by intoxication or disease, and so far *groundless*, the most that can safely be said is that the object may be vague, ill-defined and shifting, but not that it is absent altogether. States of physical exaltation, depression or irritability readily arouse by association appropriate *troupes* of imagery; only when they fail of this are we entitled to say that there is no object, and then we must add that there is also no emotion.

Emotional and Conative Action.

35. As in dealing with the causes of feeling, so we may now in like manner proceed to inquire whether in its manifestations or effects there is any contrast corresponding to the opposing extremes of pleasure and pain. We have already seen reasons for dismissing reflex movements or movements not determined by feeling as psychologically secondary, the effects of habit and heredity, and for regarding those diffusive movements that are immediately expressive of feeling as primordial—such movements as are strictly purposive being gradually selected or elaborated from them. But some distinction is called for among the various movements expressive of emotion; for there is more in these than the direct effect of feeling regarded as merely pleasure or pain. It has been usual with psychologists to confound emotions with feeling, because intense feeling is essential to emotion. But, strictly

¹ *Text-Book of Psychology* (1890), p. 383.

² G. H. J. Berkley, "Two Cases of General Cutaneous and Sensory Anaesthesia without marked Psychological Implications," *Brain* (1891), xiv. 441 sqq.

³ "Experiments on the Value of Vascular and Visceral Factors for the Genesis of Emotion," *Proc. Roy. Soc.* (1900), lxvi. 390 sqq.; and *Nature*, lxii. 328 sqq.

speaking, a state of emotion is a complete state of mind, a psychosis, and not a psychical element, if we may so say. Thus in anger we have over and above pain a more or less definite object as its cause, and a certain characteristic reactive display—frowns, compressed lips, erect head, clenched fists, in a word, the combative attitude—as its effect, and similarly of other emotions; so that generally in the particular movements indicative of particular emotions the primary and primitive effects of feeling are overlaid by what Darwin has called serviceable associated habits. The purposive actions of an earlier stage of development become, though somewhat atrophied as it were, the emotive outlet of a later stage: in the circumstances in which our ancestors worried their enemies we only show our teeth. We must, therefore, leave aside the more complex emotional manifestations and look only to the simplest effects of pleasure and of pain, if we are to discover any fundamental contrast between them.⁴

Joy finds expression in dancing, clapping the hands and meaningless laughter, and these actions are not only pleasurable in themselves but such as increase the existing pleasure. Attention is not drafted off or diverted; but rather the available resources seem reinforced, so that the old expenditure is supported as well as the new. To the pleasure on the receptive side is added pleasure on the active side. The violent contortions due to pain, on the other hand, are painful in themselves, though less intense than the pains from which they withdraw attention; they are but counter-irritants that arrest or inhibit still more painful thoughts or sensations. Thus, according to Darwin, "sailors who are to be flogged sometimes take a piece of lead into their mouths in order to bite it with their utmost force, and thus to bear the pain." When in this way we take account of the immediate effects as well as of the causes of feeling, we find it still more strikingly true that only in pleasurable states is there an efficient expenditure of attention. It is needless now to dwell upon this point, although any earlier mention of it would hardly have been in place. But we should fail to realize the contrast between the motor effects of pleasure and of pain if we merely regarded them as cases of diffusion. The intenser the feeling the intenser the reaction, no doubt, whether it be smiles or tears, jumping for joy, or writhing in agony; but in the movements consequent on pleasure the diffusion is the result of mere exuberance, an overflow of good spirits, as we sometimes say, and these movements, as already remarked, are always comparatively purposeless or playful. Even the earliest expressions of pain, on the contrary, seem but so many efforts to escape from the cause of it; in them there is at least the blind purpose to flee from a definite ill, but in pleasure only the enjoyment of present fortune.

From Plato downwards psychologists and moralists have been fond of discussing the relation of pleasure and pain. It has been maintained that pain is the first and more fundamental fact, and pleasure nothing but relief from pain; and, again, on the other side, that pleasure is prior and positive, and pain only the negation of pleasure. So far as the mere change goes, it is obviously true that the diminution of pain is *pro tanto* pleasant, and the diminution of pleasure *pro tanto* unpleasant; and if relativity had the unlimited range sometimes assigned to it this would be all we could say. But we must sooner or later recognize the existence of a comparatively fixed neutral state, deviations from which, of comparatively short duration and of sufficient intensity, constitute distinct states of pleasure or pain. Such states, if not of liminal intensity, may then be further diminished without reversing

⁴ Of the three principles Darwin advances in explanation of emotional expression that which he places last—perhaps because it admits of less definite illustration—seems both psychologically and physiologically more fundamental than the more striking principle of serviceable associated habits which he places first; indeed the following, which is his statement of it, implies as much: "Certain actions which we recognize as expressive of certain states of mind are the direct result of the constitution of the nervous system, and have been from the first independent of the will, and to a large extent of habit" (*Expression of the Emotions*, p. 66). It is in illustration of this principle too that Darwin describes the movements expressive of joy and grief, emotions which in some form or other are surely the most primitive of any.

their pleasurable or painful character. The turning-point here implied may, of course, gradually change too—as a result, in fact, of the law of accommodation. Thus a long run of pleasure would raise “the hedonistic zero,” while—to the small extent to which accommodation to pain is possible—a continuance of pain would lower it. But such admission makes no material difference where the actual feeling of the moment is alone concerned and retrospect out of the question. On the whole it seems, therefore, most reasonable to regard pleasure and pain as emerging out of a neutral state, which is prior to and distinct from both—not a state of absolute indifference, but of simple contentment, marked by no special active display. But it is by reference to such state of equilibrium or *ἀναμία* that we see most clearly the superior volitional efficacy of pain upon which pessimists love to descant. “Nobody,” says Von Hartmann, “who had to choose between no taste at all for ten minutes or five minutes of a pleasant taste and then five minutes of an unpleasant taste, would prefer the last.” Most men and all the lower animals are content “to let well alone.”

To ascertain the origin and progress of purposive action it seems, then, that we must look to the effects of pain rather than to those of pleasure. It is true that psychologists not infrequently describe the earliest purposive movements as appetitive; or at least they treat appetitive and aversive movements as co-ordinate and equally primitive, pleasures being supposed to lead to actions for their continuance as much as pains to actions for their removal. No doubt, as soon as the connexion between a pleasurable sensation and the appropriate action is completely established, as in the case of imbibing food, the whole process is then self-sustaining till satiety begins. But the point is that such facility was first acquired under the teaching of pain—the pain of unsatisfied hunger. The term “appetite” is apt both by its etymology and its later associations to be misleading. What are properly called the “instinctive” appetites are—when regarded from their active side—movements determined by some existing uneasy sensation. So far as their earliest manifestation in a particular individual is concerned, this urgency seems almost entirely of the nature of a *vis a tergo*; and the movements are only more definite than those simply expressive of pain because of inherited pre-adaptation, on which account, of course, they are called “instinctive.” But what one inherits another must have acquired, and we have agreed here to leave heredity on one side and consider only the original evolution.

But if none but psychological causes were at work this evolution would be very long and in its early stages very uncertain. At first, when only random movements ensue, we may fairly suppose both that the chance of at once making a happy hit would be small and that the number of chances, the space for repentance, would also be small. Under such circumstances natural selection would have to do almost everything and subjective selection almost nothing. So far as natural selection worked, we should have, not the individual subject making a series of tries and perfecting itself by practice, as in learning to dance or swim, but we should have those individuals whose structure happened to vary for the better surviving, increasing and displacing the rest. How much natural selection, apparently unaided, can accomplish in the way of complicated adjustment we see in the adaptation of the form and colour of plants and animals to their environment. Both factors, in reality, operate at once, and it would be hard to fix a limit to either, though to our minds natural selection seems to lose in comparative importance as we advance towards the higher stages of life.

But psychologically we have primarily to consider subjective selection, *i.e.* first of all, the association of particular movements with particular sensations through the mediation of feeling. The sensations here concerned are mainly painful excitations from the environment, the recurring pains of innutrition, weariness, &c., and pleasurable sensations due to the satisfaction of these organic wants—pleasures which, although not a mere “filling-up,” as Plato at one time contended, are still preceded by pain, but imply over and above the removal of this a certain surplus of positive good. There seem only a few points to notice. (a) When the movements that ensue through pleasure are themselves pleasurable there is ordinarily no ground for

singling out any one; such movements simply enhance the general enjoyment, which is complete in itself and so far contains no hint of anything beyond. (b) Should one of these spontaneous movements of pleasure chance to cause pain, no doubt such movement is speedily arrested. Probably the most immediate connexion possible between feeling and purposive action is that in which a painful movement leads through pain to its own suppression. But such connexion is not very fruitful of consequences, inasmuch as it only secures what we may call internal training and does little to extend the relation of the individual to its environment. (c) Out of the irregular, often conflicting movements which indirectly relieve pain some one may chance to remove the cause of it altogether. Upon this movement, the last of a tentative series, attention, released from the pain, is concentrated; and in this way the evil and the remedy become so far associated that on a recurrence of the former the many diffused movements become less, and the one purposive movement more, pronounced; the one effectual way is at length established and the others, which were but palliatives, disappear. (d) When things have advanced so far that some one definite movement is definitely represented along with the painful sensation it remedies, it is not long before a still further advance is possible and we have *preventive movements*. Thanks to the orderliness of things, dangers have their premonitions. After a time, therefore, the occurrence of some signal sensation revives the image of the harm that has previously followed in its wake, and a movement—either like the first, or another that has to be selected from the random tries of fear—occurs in time to avert the impending ill. (e) In like manner, provided the cravings of appetite are felt, any signs of the presence of pleasurable objects prompt to movements for their enjoyment or appropriation. In these last cases we have action determined by percepts. The cases in which the subject is incited to action by ideas as distinct from percept require a more detailed consideration; such are the facts mainly covered by the term “desire.”

By the time that ideas are sufficiently self-sustaining to form trains that are not wholly shaped by the circumstances of the present, entirely new possibilities of action are opened up. We can desire to live again through experiences of which there is nothing actually present to remind us, and we can desire a new experience which as yet we only imagine. We often, no doubt, apply the term to the simpler states mentioned under (e) in the last paragraph: the fox in the fable is said to have desired the grapes he vilified because out of his reach. Again, at the other extreme it is usual to speak of a desire for honour, or for wealth, and the like; but such are not so much single states of mind as inclinations or habitual desires. Moreover, abstractions of this kind belong to a more advanced stage of development than that at which desire begins, and of necessity imply more complicated grounds of action than we can at present examine. The essential characteristics of desire will be more apparent if we suppose a case somewhere between these extremes. A busy man reads a novel at the close of the day, and finds himself led off by a reference to angling or tropical scenery to picture himself with his rods packed *en route* for Scotland, or booked by the next steamer for the fairyland of the West Indies. Presently, while the ideas of Jamaica or fishing are at least as vividly imagined as before, the fancied preparations receive a rude shock as the thought of his work recurs. Some such case we may take as typical and attempt to analyse it.

First of all it is obviously true, at least of such more concrete desires, that what awakens desire at one time fails to do so at another, and that we are often so absorbed or content with the present as not to be amenable to (new) desires at all. A given *x* or *y* cannot, then, be called desirable *per se*, it is only desirable by relation to the contents of consciousness at the moment. Of what nature is this relation? (1) At the level of psychical life that we have now reached very close and complete connexions have been formed between ideas and the movements necessary for their realization, so that when the idea is vividly

present these movements are apt to be nascent. This association is the result of subjective selection—*i.e.* of feeling—but being once established, it persists like other associations independently of it. (2) Those movements are especially apt to become nascent which have not been recently executed, which are therefore fresh and accompanied by the organic sensations of freshness, but also those which are frequently executed, and so from habit readily aroused. The latter fact, which chiefly concerns habitual desires, may be left aside for a time. (3) At times, then, when there is a lack of present interests, or when these have begun to wane, or when there is positive pain, attention is ready to fasten on any new suggestion that calls for more activity, requires a change of active attitude, or promises relief. Such spontaneous concentration of attention ensures greater vividness to the new idea, whatever it be, and to its belongings. In some cases this greater vividness may suffice. This is most likely to happen when the new idea affords intellectual occupation, and this is at the time congenial, or with indolent and imaginative persons who prefer dreaming to doing. (4) But when the new idea does not lead off the pent-up stream of action by opening out fresh channels, when, instead of this, it is one that keeps them intent upon itself in an attitude comparable to expectation, then we have desire. In such a state the intensity of the re-presentation is not adequate to the intensity of the incipient actions it has aroused. This is most obvious when the latter are directed towards sensations or percepts, and the former remains only an idea. If it were possible by concentrating attention to convert ideas into percepts, there would be an end of most desires: "if wishes were horses beggars would ride." (5) But our voluntary power over movements is in general of this kind: here the fiat may become fact. When we cannot hear we can at least listen, and, though there be nothing to fill them, we can at least hold out our hands. It would seem, then, that the source of desire lies essentially in this excess of the active reaction above the intensity of the re-presentation (the one constituting the "impulse," the other the "object" of desire, or the desideratum), and that this disparity rests ultimately on the fact that movements have, and sensations have not, a subjective initiative. (6) The impulse or striving to act will, as already hinted, be stronger the greater the available energy, the fewer the present outlets, and, habits apart, the fresher the new opening for activity. (7) Finally, it is to be noted that, when such inchoate action can be at once consummated, desire ends where it begins: to constitute a definite state of desire there must be not only an obstacle to the realization of the desideratum—if this were all we should rather call the state one of wishing—but an obstacle to its realization by means of the actions its representation has aroused.

However the desire may have been called forth, its intensity is primarily identical with the strength of this impulse to action, and has no definite or constant relation to the amount of pleasure that may result from its satisfaction. **Relation of Desire to Feeling.** The feeling directly consequent on desire as a state of want and restraint is one of pain, and the reaction which this pain sets up may either suppress the desire or prompt to efforts to avoid or overcome the obstacles in its way. To inquire into these alternatives would lead us into the higher phases of voluntary action; but we must first consider the relation of desire to feeling more closely.

Instances are by no means wanting of very imperious desires accompanied by the clear knowledge that their gratification will be positively distasteful.¹ On the other hand it is possible to recollect or picture circumstances known or believed to be intensely pleasurable without any desire for them being awakened at all: we can regret or admire without desiring. Yet there are many psychologists who maintain that desire is excited only by the prospect of the pleasure that may arise through its gratification, and that the strength of the desire is proportional to the intensity of the pleasure thus anticipated.

¹ As such an instance may be cited Plato's story of Leontius, the son of Aglaeon, in *Rep.* iv. 439 *fin.*

Quidquid petitur petitur sub specie boni is their main formula. The plausibility of this doctrine rests partly upon a seemingly imperfect analysis of what strictly pertains to desire and partly on the fact that it is substantially true both of what we may call "presentation-prompted" action, which belongs to an earlier stage than desire, and of the more or less rational action that comes later. In the very moment of enjoyment it may be fairly supposed that action is sustained solely by the pleasure received and is proportional to the intensity of that pleasure. But there is here no re-presentation and no seeking; the conditions essential to desire, therefore, do not apply. Again, in rational action, where both are present, it may be true—to quote the words of an able advocate of the view here controverted—that "our character as rational beings is to desire everything exactly according to its pleasure value."² But consider what such conceptions as the good, pleasure value and rational action involve. Here we have foresight and calculation, regard for self as an object of permanent interest—Butler's cool self-love; but desire as such is blind, without either the present certainty of sense or the assured prevision of reason. Pleasure in the past, no doubt, has usually brought about the association between the representation of the desired object and the movement for its realization; but neither the recollection of this pleasure nor its anticipation is necessary to desire, and even when present they do not determine what urgency it will have. The best proof of this lies in certain habitual desires. Pleasures are diminished by repetition, whilst habits are strengthened by it; if the intensity of desire, therefore, were proportioned to the "pleasure value" of its gratification, the desire for renewed gratification should diminish as this pleasure grows less; but, if the present pain of restraint from action determines the intensity of desire, this should increase as the action becomes habitual. And observation seems to show that, unless prudence suggests the forcible suppression of such belated desires or the active energies themselves fail, they do in fact become more imperious, although less productive of positive pleasure, as time goes on.

In this there is, of course, no exception to the general principle that action is consequent on feeling—a greater pleasure being preferred before a less, a less pain before a greater; for, though the feeling that follows upon its satisfaction be less or even change entirely, still the pain of the unsatisfied desire increases as the desire hardens into habit. It is also a point in favour of the position here taken that appetites, which may be compared to inherited desires, certainly prompt to action by present pain rather than by prospective pleasure.

Intellection.

36. Desire naturally prompts to the search for the means to its satisfaction and frequently to a mental rehearsal of various possible courses of action, their advantages and disadvantages. Thus, by the time the ideational continuum has become—mainly by the comparatively passive working of association—sufficiently developed to furnish free ideas as thinking material, motives are forthcoming for thinking to begin. It is obviously impossible to assign any precise time for this advance; like all others, it is gradual. Fitfully, in strange circumstances and under strong excitement, the lower animals give unmistakable signs that they can understand and reason. But thought as a permanent activity may be fairly said to originate in and even to depend upon the acquisition of speech. This indispensable instrument, which more than anything else enables our psychological individual to advance to the distinctly human or rational stage, consists of gestures and vocal utterances, which were originally—and, indeed, are still to a large extent—emotional expressions.³ Our space will only allow us to note in what

² Bain, *Emotions and Will*, 3rd ed., p. 438.

³ It must be noted that, though we still retain our psychological standpoint, the higher development of the individual is only possible through intercourse with other individuals, that is to say, through society. Without language we should be mutually exclusive and impenetrable, like so many physical atoms; with it each several mind may transcend its own limits and share the minds of others. As a

way language when it already exists, is instrumental in the development as distinct from the communication of thought. But first of all, what in general is thinking, of which language is the instrument?

In entering upon this inquiry we are really passing one of the hardest and fastest lines of the old psychology—that between sense and understanding. So long as it was the fashion to assume a multiplicity of faculties the need was less felt for a clear exposition of their connexion. A man had senses and intellect much as he had eyes and ears; the heterogeneity in the one case was no more puzzling than in the other. But for psychologists who do not cut the knot in this fashion it is confessedly a hard matter to explain the relation of the two. The contrast of receptivity and activity hardly avails, for all presentation involves activity and essentially the same activity, that of attention. Nor can we well maintain that the presentations attended to differ in kind, albeit such a view has been held from Plato downwards. *Nihil est in intellectu quod non fuerit prius in sensu*: the blind and deaf are necessarily without some concepts that we possess. If pure being is pure nothing, pure thought is equally empty. Thought consists of a certain elaboration of sensory and motor presentations and has no content apart from these. We cannot even say that the forms of this elaboration are psychologically a priori; on the contrary, what is epistemologically the most fundamental is the last to be psychologically realized. This is not only true as a fact; it is also true of necessity, in so far as the formation of more concrete concepts is an essential preliminary to the formation of others more abstract—those most abstract, like the Kantian categories, &c., being thus the last of all to be thought out or understood. And though this formative work is substantially voluntary, yet, if we enter upon it, the form at each step is determined by the so-called matter, and not by us; in this respect "the spontaneity of thought" is not really freer than the receptivity of sense.¹ It is sometimes said that thought is synthetic, and this is true; but imagination is synthetic also; and the processes which yield the ideational train are the only processes at work in intellectual synthesis. Moreover, it would be arbitrary to say at what point the mere generic image ceases and the true concept begins—so continuous are the two. No wonder, therefore, that English psychology has been prone to regard thought as only a special kind of perception—perceiving the agreement or disagreement of ideas—and the ideas themselves as mainly the products of association. Yet this is much like confounding observation with experiment or invention—the act of a cave-man in betaking himself to a drifting tree with that of Noah in building himself an ark. In reverie, and even in understanding the communications of others, we are comparatively passive spectators of ideational movements, non-voluntarily determined. But in thinking or "intellection," as it has been conveniently termed, there is always a search for something more or less vaguely conceived, for a clue which will be known when it occurs by seeming to satisfy certain conditions. Thinking may be broadly described as solving a problem—finding an AX that is B. In so doing we start from a comparatively fixed central idea or intuition and work along the several diverging lines of ideas associated with it—hence far the aptest and in fact the oldest description of thought is that it is *discursive*. Emotional excitement—and at the outset the natural man does not think much in cold blood—quickens the flow of ideas; what seems relevant is at once contemplated more closely, while what seems irrelevant awakens little interest and receives little attention. At first the control acquired is but very imperfect; the actual course of thought of even a disciplined mind falls far short of the clearness, distinctness, and coherence of the logician's ideal. Familiar associations are apt to hurry attention away from the proper topic, so that thought

herd of individuals mankind would have a natural history as other animals have; but personality can only emerge out of intercourse with persons, and of such intercourse language is the means. But important as is this addition of a transparent and responsive world of minds to the dead opaqueness of external things, the development of our psychological individual still remains a purely individual development. The only new point is—and it is of the highest importance to keep it in sight—that the materials of this development no longer consist exclusively of presentations elaborated by a single mind in accordance with psychical laws. Nevertheless that combination of individual experiences which converts subjective idiosyncrasy and isolation into the objectivity and solidarity of Universal Mind only affects the individual in accordance with psychical laws, and we have no need therefore to overstep our proper domain in studying the advance from the non-rational phase to the phase of reason.

¹ Locke, so often misrepresented, expressed this truth according to his lights in the following: "The earth will not appear painted with flowers nor the fields covered with verdure whenever we have a mind to it. . . . Just thus is it with our understanding: all that is voluntary in our knowledge is the employing or withholding any of our faculties from this or that sort of objects and a more or less accurate survey of them" (*Essay*, iv. 13, 2).

becomes not only discursive but wandering; in place of concepts of fixed and crystalline completeness, such as logic describes, we may find a congeries of ideas but imperfectly compacted into one generic idea, subject to continual transformation and implicating much that is irrelevant and confusing.

Thus, while it is possible for thought to begin without language, just as arts may begin without tools, yet language enables us to carry the same process enormously farther. In the first place it gives us an increased command of *Thought and Language*. even such comparatively concrete generic images as can be formed without it. The name of a thing or action becomes, for one who knows the name, as much an objective mark or attribute as any quality whatever can be. The form and colour of what we call an "orange" are perhaps even more intimately combined with the sound and utterance of this word than with the taste and fragrance which we regard as strictly essential to the thing. But, whereas its essential attributes often evade us, we can always command its nominal attribute, in so far as this depends upon movements of articulation. By uttering the name (or hearing it uttered) we have secured to us, in a greater or less degree, that superior vividness and definiteness that pertain to images reinstated by impressions: our idea approximates to the fixity and independence of a percept (cf. § 21 above). With young children and uncultured minds—who, by the way, not uncommonly "think aloud"—the gain in this respect is probably more striking than those not confined to their mother-tongue or those used to an analytical handling of language at all realize.² When things are thus made ours by receiving names from us and we can freely manipulate them in idea, it becomes easier mentally to bring together facts that logically belong together, and so to classify and generalize. For names set us free from the cumbersome tangibility and particularity of perception, which is confined to just what is presented here and now. But as ideas increase in generality they diminish in definiteness and unity; they not only become less pictorial and more schematic, but they become vague and unsteady as well, because formed from a number of concrete images only related as regards one or two constituents, and not assimilated as the several images of the same thing may be. The mental picture answering to the word "horse" has, so to say, body enough to remain a steady object when under attention from time to time; but that answering to the word "animal" is perhaps scarcely twice alike. The relations of things could thus never be readily recalled or steadily controlled if the names of those relations, which as words always remain concrete, did not give us a definite hold upon them—make them comprehensible. Once these "airy nothings" have a name, we reap again the advantages a concrete constituent affords: by its means that which is relevant becomes more closely associated, and that which is irrelevant—abstracted from—falls off. When what answers to the logical connotation or meaning of a concept is in this way linked with the name, it is no longer necessary that such "matter or content" should be distinctly present in consciousness. It takes time for an image to raise its associates above the threshold; and, when all are there, there is more demand upon attention in proportion. There is thus a manifest economy in what Leibnitz happily styled "symbolic," in contrast to "intuitive" thinking. Our power of efficient attention is limited, and with words for counters we can, as Leibnitz remarks, readily perform operations involving very complex presentations, and wait till these operations are concluded before realizing and spreading out the net result in sterling coin.

But this simile must not mislead us. In actual thinking there never is any complete separation between the symbol and the ideas symbolized: the movements of the one are never entirely suspended till those of the *Thought and Ideation*. other are complete. "Thus," says Hume, "if, instead of saying, that in war the weaker have always recourse

² Ruskin, in his *Fors clavigera*, relates that the sight of the word "crocodile" used to frighten him when a child so much that he could not feel at ease again till he had turned over the page on which it occurred.

to negotiation, we should say, that they have always recourse to conquest, the custom which we have acquired of attributing certain relations to ideas still follows the words and makes us immediately perceive the absurdity of that proposition."¹ How intimately the two are connected is shown by the surprises that give what point there is to puns, and by the small confusion that results from the existence of homonymous terms. The question thus arises—What are the properly ideational elements concerned in thought? Over this question psychologists long waged fight as either nominalists or conceptualists. The former maintain that what is imaged in connexion with a general concept, such as *triangle*, is some individual triangle "taken in a certain light,"² while the latter maintain that an "abstract idea" is formed embodying such constituents of the several particulars as the concept connotes, but dissociated from the specific or accidental variations that distinguish one particular from another. As often happens in such controversies, each side saw the weak point in the other. The nominalists easily showed that there was no distinct abstract idea representable apart from particulars; and the conceptualists could as easily show that a particular presentation "considered in a certain light" is no longer merely a particular presentation nor yet a mere crowd of presentations. The very thing to ascertain is what this consideration in a certain light implies. Perhaps a speedier end might have been put to this controversy if either party had been driven to define more exactly what was to be understood by image or idea. Such ideas as are possible to us apart from abstraction are, as we have seen, revived percepts, not revived sensations, are complex total re-presentations made up of partial re-presentations, which may figure in other totals (cf. § 21). Reproductive imagination is so far but a faint rehearsal of actual percepts, and constructive imagination but a faint anticipation of possible percepts. In either case we are busied with elementary presentations complicated or synthesized to what are tantamount to intuitions, in so far as the forms of intuition remain in the idea, though the fact, as tested by movement, &c., is absent. The several partial re-presentations, however, which make up an idea might also be called ideas, not merely in the wide sense in which every mental object may be so called, but also in the narrower sense as secondary presentations, i.e. as distinguished from primary presentations or impressions. But such isolated images of an impression, even if possible, would no more be intuitions than the mere impression itself would be one: taken alone the one would be as free of space and time as is the other. Till it is settled, therefore, whether the ideational elements concerned in conception are intuitive complexes or something answering to the ultimate elements of these, nothing further can be done.

In the case of what are specially called "concrete" as distinct from "abstract" concepts—if this rough-and-ready, but unscientific, distinction may be allowed—the idea answering to the concept differs little from an intuition, and we have already remarked that the generic image (*Gemeinbild* of German psychologists) constitutes the connecting link between imagination and conception. But even concerning these it is useless to ask what does one imagine in thinking, e.g. of triangle or man or colour. We never—except for the sake of this very inquiry—attempt to fix our minds in this manner upon some isolated concept; in actual thinking ideas are not in consciousness alone and disjointedly, but as part of a context. When the idea "man" is present, it is present in some proposition or question, as—Man is the paragon of animals; In man there is nothing great but mind; and so on. It is quite clear that in understanding or mentally verifying such statements very different constituents out of the whole complex "man" are prominent in each. Further, what is present to consciousness when a general term is understood will differ, not only with a different context, but also the longer we dwell upon it: we may either analyse its connota-

tion or muster its denotation, as the context or the cast of our minds may determine. Thus what is relevant is alone prominent, and the more summary the attention we bestow the less the full extent and intent of the concept are displayed. To the nominalist's objection, that it is impossible to imagine a man without imagining him as either tall or short, young or old, dark or light, and so forth, the conceptualist might reply that at all events percepts may be clear without being distinct, that we can recognize a tree without recognizing what kind of tree it is, and that, moreover, the objection proves too much: for, if our image is to answer exactly to fact, we must represent not only a tall or a short man, but a man of definite stature—one not merely either light or dark, but of a certain precise complexion. But the true answer rather is that in conceiving as such we do not necessarily imagine a man or a tree at all, any more than—if such an illustration may serve—in writing the equation to the parabola we necessarily draw a parabola as well.

The individuality of a concept is thus not to be confounded with the sensible concreteness of an intuition either distinct or indistinct, and "the pains and skill" which Locke felt were required in order to frame what he called an abstract idea are not comparable to the pains and skill that may be necessary to discriminate or decipher what is faint or fleeting. The material "framed" consists no doubt of ideas, if by this is meant that in thinking we work ultimately with the ideational continuum, but what results is never a mere intuitive complex nor yet a mere group of such. The concept or "abstract idea" only emerges when a certain intelligible relation is established among the members of such a group; and the very same intuition may furnish the material for different concepts as often as a different *geistiges Band* is drawn between them. The stuff of this bond, as we have seen, is the word, and this brings into the foreground of consciousness when necessary those elements—whether they form an intuition or not—which are relevant to the concept. Conception, then, is not identical with imagination, although the two terms are still often, and were once generally, regarded as synonymous. The same ultimate materials occur in each; but in the one they start with and retain a sensible form, in the other they are elaborated into the form which is called "intelligible."

37. The distinctive character of this intellectual synthesis lies, we have seen, in the fact that it is determined entirely by what is synthesized, whether that be the elementary constituents of intuitions or general relations of whatever kind among these. It differs, therefore, in being selective from the synthesis of association, which rests upon contiguity and unites together whatever occurs together. It differs also from any synthesis, though equally voluntary in its initiation, which is determined by a purely subjective preference, since intellection depends upon objective relations alone. Owing to the influence of logic, which has long been in a much more forward state than psychology, it has been usual to resolve intellection into comparison, abstraction, and classification, after this fashion: ABCM and ABCN are compared, their differences M and N left out of sight, and the class notion ABC formed including both; the same process repeated with ABC and ABD yields a higher class notion AB; and so on. But our ideational continuum is not a mere string of ideas of concrete things, least of all such concrete things as this view implies. Not till our daily life resembles that of a museum porter receiving specimens will our higher mental activity be comparable to that of the savant who sorts such specimens into cases and compartments. What we perceive is a world of things in continual motion, waxing, waning, the centres of manifold changes, affecting us and apparently affected by each other, amenable to our action and, as it seems, continually interacting among themselves. Even the individual thing, as our analysis of perception has attempted to show, is not a mere sum of properties which can be taken to pieces and distributed like type, but a whole combined of parts very variously related. To understand intellection we must look at its actual development under the impetus of practical needs,

¹ *Treatise of Human Nature* (Green and Grose's ed.), pt. i. § vii. p. 331.

² Cf. Berkeley, *Principles of Human Knowledge*, Intro. § 16, Hume, *op. cit.* § 7.

rather than to logical ideals of what it ought to be. Like other forms of purposive activity, thinking is primarily undertaken as a means to an end, and especially the end of economy. It is often easier and always quicker to manipulate ideas than to manipulate real things; to the common mind the thoughtful man is one who "uses his head to save his heels." In all the arts of life, in the growth of language and institutions, in scientific explanation, and even in the speculations of philosophy, we may remark a steady simplification in the steps to a given end or conclusion, or—what is for our present inquiry the same thing—the attainment of better results with the same means. The earliest machines are the most cumbersome and clumsy, the earliest speculations the most fanciful and anthropomorphic. Gradually imitation yields to invention, the natural fallacy of *post hoc, ergo propter hoc* to methodical induction, till what is essential and effective is realized and appreciated and what is accidental and inert is discarded and falls out of sight. In this way man advances in the construction of a complete mental clue or master key to the intricacies of the real world, but this key is still the counterpart of the world it enables us to control and explain.

To describe the process by which such insight is attained as a mere matter of abstraction deserves the stigma of "soulless blunder" which Hegel applied to it. Of course if attention is concentrated on X it must *pro tanto* be abstracted from Y, and such command of attention may require "some pains and skill." But to see in this invariable accompaniment of thinking its essential feature is much like the schoolboy's saying that engraving consists in cutting fine shavings out of a hard block. The great thing is to find out what are the light-bearing and fruit-bearing combinations. Moreover, thinking does not begin with a conscious abstraction of attention from recognized differences in the way logicians describe. The actual process of generalization, for the most part at all events, is much simpler. The same name is applied to different things or events because only their more salient features are perceived at all. Their differences, so far from being consciously and with effort left out of account, often cannot be observed when attention is directed to them: to the inexperienced all *is* gold that glitters. Thus, and as an instance of the principle of progressive differentiation already noted (§ 6), we find genera recognized before species, and the species obtained by adding on differences, not the genus by abstracting from them. Of course such vague and indefinite concepts are not at first logically general: they only become so when certain common elements are consciously noted as pertaining to presentations in other respects qualitatively different, as well as numerically distinct. But actually thinking starts from such more potential generality as is secured by the association of a generic image with a name: So far the material of thought is always general—is freed, that is, from the local and temporal and other defining marks of percepts.

38. The process of thinking itself is psychologically much better described as (1) an analysis and (2) a re-synthesis of this material already furnished by the ideational **Thought as Analytic.** trains. The logical resolution of thought into hierarchies of concepts arranged like Porphyry's tree, into judgments uniting such concepts by means of a logical copula, &c., is the outcome of later reflection—mainly for technical purposes—upon thought as a completed product, and entirely presupposes all that psychology has to explain. The logical theory of the formation of concepts by generalization (or abstraction) and by determination (or concretion)—*i.e.* by the removal or addition of defining marks—assumes the previous existence of the very things to be formed, for these marks or attributes—X's and Y's, A's and B's—are themselves already concepts. Moreover, the act of generalizing or determining is really an act of judgment, so that the logician's account of conception presupposes judgment, while at the same time his account of judgment presupposes conception. But this is no evil; for logic does not essay to exhibit the actual genesis of thought but only an ideal for future thinking. Psychologically, however—that is to say, chronologically—the judgment is

first. The growing mind, we may suppose, passes beyond simple perception when some striking peculiarity in what is at the moment perceived is a bar to its recognition. The stalking hunter is not instantly recognized as the destroying biped, because he crawls on all fours; or the scarecrow looks like him, and yet not like him, for, though it stands on two legs, it never moves. There is thus no immediate assimilation; recognition under such circumstances is in itself a judgment, involving an analysis more or less explicit. But of more account is the further judgment to which it leads, that which connects the new fact with the generic idea. Though actually complex, generic images are not explicitly known as complexes when they first enter into judgments; as the subjects of such judgments they are but starting-points for predication—It crawls; It does not move; and the like. Such impersonal judgments, according to most philologists, are in fact the earliest; and we may reasonably suppose that by means of them our generic images have been partially analysed, and have attained to something of the distinctness and constancy of logical concepts. But the analysis is rarely complete: a certain confused and fluctuating residuum remains behind. The psychological concept merges at sundry points into those cognate with it—in other words, the continuity of the underlying memory-train still operates; only the ideal concept of logic is in all respects *lotus, teres, atque rotundus*. Evidence of this, if it seem to any to require proof, is obtainable on all sides, and, if we could recover the first vestiges of thinking, would doubtless be more abundant still.

But, if we agree that it is through acts of judgment which successively resolve composite presentations into elements that concepts first arise, it is still very necessary to inquire more carefully what these elements are. On the one side we have seen logicians comparing them to so many letters, **Logical Bias in Psychology.** and on the other psychologists enumerating the several sensible properties of gold or wax—their colour, weight, texture, &c.—as instances of such elements. In this way formal logic and sensationalist psychology have been but blind leaders of the blind. Language, which has enabled thought to advance to the level at which reflection about thought can begin, is now an obstacle in the way of a thorough analysis of it. A child or savage would speak only of "red" and "hot," but we of "redness" and "heat." They would probably say, "Swallows come when the days are lengthening and snipe when they are shortening"; we say, "Swallows are spring and snipe are winter migrants." Instead of "The sun shines and plants grow," we should say, "Sunlight is the cause of vegetation." In short, there is a tendency to resolve all concepts into substantive concepts; and the reason of this is not far to seek. Whether the subject or starting-point of our discursive thinking be actually what we perceive as a thing, or whether it be a quality, an action, an effectuation (*i.e.* a transitive action), a concrete spatial or temporal relation, or finally, a resemblance or difference in these or in other respects, it becomes by the very fact of being the central object of thought *pro tanto* a unity, and all that can be affirmed concerning it may so far be regarded as its property or attribute. It is, as we have seen, the characteristic of every completed concept to be a fixed and independent whole, as it were, crystallized out of the still-fluent matrix of ideas. Moreover, the earliest objects of thought and the earliest concepts must naturally be those of the things that live and move about us; hence, then—to seek no deeper reason for the present—this natural tendency, which language by providing distinct names powerfully secures, to reify or personify not only things but every element and relation of things which we can single out, or, in other words, to concrete our abstracts.¹ It is when things have reached this stage that logic begins. But ordinary, so-called formal, logic, which intends to concern itself not with thinking but only with the most general structure of thought, is debarred from recognizing any difference between concepts that does not affect their relations as terms in a proposition. As a consequence it drifts inevitably into that compartmental logic or logic of extension which knows nothing of categories or predicables, but only of the one relation of whole and part qualitatively considered. It thus pushes this reduction to a common denomination to the utmost: its terms, grammatically regarded, are always names and symbolize classes or compartments of things. From this point of view all disparity among concepts, save that of contradictory exclusion, and all connexion, save that of partial coincidence, are at an end.

Of a piece with this are the logical formula for a simple judgment, X is Y, and the corresponding definitions of judgment as the comparison of two concepts and the recognition of their agreement or

¹ See Wundt, *Logik*, i. 107 seq., where this process is happily styled "dic kategoriale Verschiebung der Begriffe."

disagreement.¹ It certainly is possible to represent every judgment as a comparison, although the term is strictly adequate only to judgments of one kind and affords but a very artificial description of others. But for a logic mainly concerned with inference—*i.e.* with explicating what is implicated in any given statements concerning classes—there is nothing more to be done than to ascertain agreements or disagreements; and the existence of these, if not necessarily, is at least most evidently represented by spatial relations. Such representation obviously implies a single ground of comparison only and therefore leaves no room for differences of category. The resolution of all concepts into class concepts and that of all judgments into comparisons thus go together. On this view if a concept is complex it can only be so as a class combination; and, if the mode of its synthesis could be taken account of at all, this could only be by treating it too as an element in the combination like the rest: iron is a substance, &c., virtue a quality, &c., distance a relation, &c., and so on. There is much of directly psychological interest in this thoroughgoing reduction of thought to a form which makes its consistency and logical concatenation conspicuously evident. But of the so-called matter of thought it tells us nothing. And, as said, there are many forms in that matter of at least equal moment, both for psychology and for epistemology: these formal logic has tended to keep out of sight.

It has generally been under the bias of such a formal or computational logic that psychologists, and especially English psychologists, have entered upon the study of mind. They have brought with them an analytic scheme which affords a ready place for sensations or "simple ideas" as the elements of thought, but none for any differences in the combinations of these elements. Sensations being in their very nature concrete, all generality becomes an affair of names; and, as Sigwart has acutely remarked, sensationalism and nominalism always go together. History would have borne him out if he had added that a purely formal logic tends in like manner to be nominalistic.

If we are still to speak of the elements of thought, we must extend this term so as to include not only the sensory elements we are said to receive but three distinct ways in which this pure matter is combined: (1) the forms of intuition—Time and Space?; (2) the real categories—Substance, Attribute, State, Act, Effect, End or Purpose, &c.—the exact determination of which is not here in place; and (3) certain formal (logical and mathematical) categories—as Unity, Difference, Identity, Likeness. These cannot be obtained by such a process of abstraction and generalization as logicians and psychologists alike have been wont to describe. They are not primarily concepts more general than all others in the sense in which animal is more general than man, but rather distinct methods of relating or synthesizing presentations. Kant, though he accepted almost unquestioned the logic and psychology current in his day, has yet been the occasion, in spite of himself, of materially advancing both, and chiefly by the distinction he was led to make between formal and transcendental logic. In his exposition of the latter he brings to light the difference between the "functions of the understanding" in synthesizing—or, as we might say, organizing—percepts into concepts and the merely analytic subsumption of *abc* and *abd* under *ab—a, b, c* and *d* being what they may. Unlike other concepts, categories as such do not in the first instance signify objects of thought, however general, but these functions of the understanding in constituting objects. In fine, they all imply some special process, and the general characteristic of the resulting products is what we have first of all to note.

Objects of Higher Order: their Analysis and Genesis.

39. By transposing a tune from one key to another we may obtain two entirely diverse aggregates of notes, and yet the melody may remain unchanged. On the other hand, by varying the order of the notes two distinct tunes may result from the same collection of tones. Sense furnishes merely the parts: whence, then, this identity of the whole in spite of their diversity, this diversity of the whole in spite of their identity? From the sameness or difference of the several "intervals," it is replied. But the answer is insufficient; for the tune is a unity, not a mere series, and, further, with every interval the same problem recurs.

¹ Cf. Hamilton: "To judge (*kplveiv, judicare*) is to recognize the relation of congruence or of conflict in which two concepts, two individual things, or a concept and an individual, compared together, stand to each other" (*Lectures on Logic*, i. 225).

² As to these it must suffice to refer to what has been already said; cf. § 11 and § 28.

For the interval, too, is a whole, though a simpler one: it does not necessarily change with a change of its constituents, nor remain the same as long as their distance is unaltered. Feelings and "associations," again, cannot account for the result, inasmuch as such accompaniments are not invariably present: moreover, they obviously presuppose the melody instead of producing it. Of such complex wholes or combinations—as distinct from mere aggregates or collections—there are many forms; as, for example, geometrical figures and patterns, motions and other changes, numbers, logical connexions, &c. In view of this variety it seems to strike the unprejudiced as wild to expect that "the progress of psychophysics" may disclose an explanation of such combinations conforming to the old scholastic maxim, *Nihil est in intellectu quod non fuerit prius in sensu*. Yet hopes of such a *generatio aequivoca* are entertained!³ Meanwhile the "old psychology," at any rate, is content to regard such complex wholes as new presentations, the products, that is to say, not of a quasi-mechanical interaction of their constituents, but of intellectual synthesis.

What is here said of the combinations whereby the items of an aggregate are construed as parts of a whole holds equally of the comparisons whereby such items are related, as like or unlike, compatible or incompatible. Before either combination or comparison is possible, such items or particulars must be "given." But it is conceivable that they should be given and no intellectual synthesis ensue; such a consciousness has been happily named *anoetic*.⁴ Whether or no it actually exists is another matter: it is a conceivable limit, and has the theoretical usefulness of limiting conceptions generally. But relative *anoesis* suffices here. Suppose, then, we have: (a) *item*, a sound; *item*, ditto; *item*, ditto; or (b) *item*, blue; *item*, green. The sensationalist, from Hume onwards, has complained that he does not find in the one case a further item: *total three*; nor in the other a further item: *unlikeness*. After vainly seeking the living whole among the dead particulars, he next surmises that they generate it by their conjoint action! But whence this notion of "action"; and how, if such *disjecta membra* suffice, do they so often fail of their effect, so that we cannot "see the wood for the trees"? Combinations and comparisons then, we conclude, are not given, but "grounded" on what is given, and is thus their *fundamentum*. Hence Meinong, who has studied the psychology of intellection with especial care, has called the new presentations, due to this process of "grounding" (*Fundiren*), "objects of a higher order," or ideal objects.⁵ They have validity in respect of the particulars on which they are grounded, but not reality as data existing for perception alongside of such particulars.

The reader will here be reminded of Hume's distinction between knowledge and probability. His four philosophical relations, "which, depending solely upon ideas, can be the objects of knowledge and certainty—resemblance, continuity, degrees in quality and proportions in quantity or number"—are objects of higher order and *ideal*. "The other three, which depend not upon the idea, and may be absent or present even while *that* remains the same"—namely, identity, the situations in time and place, and causation—are thus obviously not the result of grounding or *noesis* merely, are not ideal but *empirical*, and have, that is to say, existential import. In fact, the second of these, the situations, though they imply synthesis in the wider sense in which all complex perception does, do not involve intellectual synthesis at all: are neither ideal combinations nor ideal relations. And since such temporal and spatial situations enter into both the other two—numerical identity and causation—the mixed, a posteriori character of these is obvious. Whatever be the defects of Hume's psychology, his classification of relations is so far sound, and its epistemological importance can hardly be overrated. It is accordingly to be regretted that the one vague term "relation" does not allow us to make these distinctions more precise. The German language, with the two terms *Verhältniss* and *Beziehung*, can do more.

³ Cf. e.g. F. Schumann, "Zur Psychologie der Zeitanschauung," *Ztschr. f. Psychologie*, xvii. 130, 136.

⁴ G. F. Stout, *Analytic Psychology*, i. 50 sqq.

⁵ A. Meinong, "Ueber Gegenstände höherer Ordnung u.s.w.," *Ztschr. f. Psychologie* (1899), xxi. 182 sqq. Special mention must be made of an earlier paper by C. v. Ehrenfels ("Ueber Gestaltqualitäten," *Vierteljahrsschr. f. wissenschaftl. Philosophie*, 1890, pp. 249 sqq.), round which the whole subsequent discussion of this topic centres. Cf., too, Stout, *op. cit.* bk. i. ch. iii.

It will be convenient at this point to digress somewhat for a moment to consider a question of some psychological interest. When we say that two "contents" are similar, and when too they admit of analysis, we can, if need be, enumerate certain elements as the ground of their partial likeness, and certain others as the ground of their partial diversity. We may further say that, abstracting from these last, we can regard the points of resemblance as constituting a general class to which the two contents belong as specific instances. But how is either comparison or abstraction possible when the two resembling contents appear as simple, and so far unanalysable? Instances, of course, are familiar to every one: thus we call red and orange colours, and say they resemble each other more than do red and blue. In presence of this question logicians and psychologists are apt to be at loggerheads. The logician maintains that abstraction and resemblance (as distinct from qualitative identity) imply complexity; and surely here he cannot be gainsaid. Yet there are the facts: reds and blues of sorts and a whole scale of degrees of likeness and unlikeness; but no constituent parts, no assignable marks of identity or diversity, are forthcoming, such as we find when we class sugar and salt together as solid or soluble, and pronounce them like in colour and unlike in taste. Here the logician's symbols $a+b+c$, $a+b+d$, have their counterparts: there—for the percipient's consciousness at all events—they have not. We cannot "consider and attend to either the sameness or the differences in" red and blue, as we can to the like or the unlike properties in salt and sugar. None the less it would be hasty to conclude that colours or any given sensations are simple. We are often struck by the likeness of complex wholes—two faces, say—long before we can discern the exact points of resemblance. Still, so long as there is no perceptible complexity in the individual presentations there can be no analysis of them, and, therefore, neither abstraction nor comparison based upon it. Can we find elsewhere the complexity that generalization and comparison invariably imply? Though colour may be regarded as a general term applicable alike to red, green and blue, just as animal is a general term applicable alike to bird, beast and fish, it is a mistake to infer that the processes are the same because of this similarity in their products. We seem bound to distinguish between consciously logical or "noetic" processes and processes that are unconsciously logical or "hyponoetic," as we may perhaps call them. In the former the subjective aspect is left aside; in the latter it cannot be. The only common mark we can psychologically assign to colours is that they are all seen, and to tones—as the element of notes and noises—that they are all heard. So often as we talk of tasting tastes, smelling smells, feeling touches, language leads us to bear witness to this fact. When the sunset red changes to the twilight grey, I still see; but when the thunder follows the lightning there is a double change, though not an absolute one: from seeing I pass to hearing, but I am sentient still. And if progressive differentiation be the order of experience then the "universal" sentience precedes the differentiations seeing, hearing, &c., and, again, the "universal" colour the differentiations, red, green, blue, &c. Such "first universals," then, are not reached by abstraction, but are given in the fundamental continuity of experience, and their subsequent differentiation admits neither of definition nor the classification applicable to discrete complexes, which are the material of logical comparison only. When red is pronounced liker or nearer to yellow than it is to green, this is because a smaller change is experienced in the transition from red to yellow than in that from red to green, and because in the latter yellow is reached and passed before green appears.¹ Proximity and resemblance are, then, so far one and the same; also both are equally relative, admit of the same indefinite gradation, and have the same limit in *zero*, regarded either as coincidence or identity. The conception of "distance between" answers, then, to what we have called a hyponoetic relation, and this is plainly distinct from the analysis of discrete complexes, with which, as said, noetic comparison is alone concerned: the one implies and the other excludes the notion of continuity and change—a fact which helps still further to distinguish the two.

Categories.

40. We come now to deal with the categories in more detail. To begin with what are *par excellence* formal categories, and among these with that which is the most fundamental: **Formal Categories:** mental and formal of all—How do we come by the **Unity.** conception of unity? "Amongst all the ideas we have," says Locke, "as there is none suggested to the mind by more ways, so there is none more simple than that of unity, or one. It has no shadow of variety or composition in it; every object our senses are employed about, every idea in our understandings, every thought of our minds, brings this idea along with it."² But to assign a sensible origin to unity is certainly

¹ Assuming, of course, that the change is the simplest or directest possible, i.e. a change of "colour proper" without change of saturation.

² *Essay concerning Human Understanding*, II. xvi. § 1.

a mistake—one of a class of mistakes already more than once referred to, which consist in transferring to the data of sense all that is implied in the language necessarily used in speaking of them. The term "a sensation" no doubt carries along with it the idea of unity, but the bare sensation as received brings along with it nothing but itself. And, if we consider sensory consciousness merely, we do not receive a sensation, and then another sensation, and so on *seriatim*; but we have always a continuous diversity of sensations even when these are qualitatively sharply differentiated. Moreover, if unity were an impression of sense and passively received, it would, in common with other impressions, be unamenable to change. We cannot see red as blue, but we can resolve many (parts) into one (whole), and vice versa.³ Unity, then, is the result of an act the occasions for which, no doubt, are at first non-voluntarily determined; but the act is still as distinct from them as is attention from the objects attended to. It is to that movement of attention already described in dealing with ideation (§ 24) that we must look as the source of this category. This same movement, in like manner, yields us temporal signs; and the complex unity formed by a combination of these is what we call number. When there is little or no difference between the field and the focus of attention, unifying is an impossibility, whatever the impressions received may be. On the other hand, as voluntary acts of concentration become more frequent and distinct the variegated continuum of sense is shaped into intuitions of definite things and events. Also, as soon as words facilitate the control of ideas, it becomes possible to single out special aspects and relations of things as the subjects or starting-points of our discursive thinking. Thus the forms of unity are manifold: every act of intuition or thought, whatever else it is, is an act of unifying.

It is obvious that the whole field of consciousness at any moment can never be actually embraced as one. What is unified becomes thereby the focus of consciousness and so leaves an outlying field; so far unity may be held to imply plurality. But it cannot with propriety be said that in a simple act of attention the field of consciousness is analysed into two distinct parts, i.e. two unities—*this* (now attended to) and *the other* or the rest (abstracted from). For the not-this is but the rest of a continuum and not itself a whole; it is left out but not determined, as the bounding space is left out when a figure is drawn. To know two unities we must connect both together; and herein comes to light the difference between the unity which is the form of the concept or subject of discourse and the unity of a judgment. The latter is of necessity complex; the former may or may not be. But in any case the complexity of the two is different. If the subject of thought is not only clear but distinct—i.e. not merely defined as a whole but having its constituents likewise more or less defined—such distinctness is due to previous judgments. At any future time these may of course be repeated; such are the analytical or explicative judgments of logic. As the mere subject of discourse it is, however, a single unity simultaneously apprehended; the relation ascertained between it and its predicate constitutes the unity of judgment, a unity which is comprehended only when its parts are successively apprehended.

But, though a judgment is always a complex unity, the extent of this complexity seems at first sight to vary as the form of synthesis varies. Formal logic, as we have seen, **Law of Dichotomy or Duality.** by throwing the form of synthesis into the predicate has no difficulty in reducing every judgment to an **S is P.** But, if we at all regard the matter thought, it is certain, for example, that "It is an explosion" is less complex than "The enemy explodes the mine." The first answers one question; the second answers three. But as regards the more complex judgment both the process of ascertaining the fact and the language in which it is expressed show that the three elements concerned in it are not synthesized at once.

³ "We may regard one of the words here printed as *one*, in that by a definite act we unite a plurality of letters in our image and separate it from its neighbours: we may also regard the one word as *many* when we attend to the transition from one letter to another and mark each step" (Sigwart, *Logic*, ii. § 66).

Suppose we start from the explosion—and changes or movements are not only apt to attract attention first, but, when recognized as events and not as abstracts personified, they call for some supplementing beyond themselves—then in this case we may search for the agent at work or for the object affected, but not for both at once. Moreover, if we find either, a complete judgment at once ensues: "The enemy explodes," or "The mine is exploded." The original judgment is really due to a synthesis of these two. But, when the results of former judgments are in this manner taken up into a new judgment, a certain "condensation of thought" ensues. Of this condensation the grammatical structure of language is evidence, though logical manipulation—with great pains—obliterates it. Thus our more complex judgment would take the form—"The enemy is now mine-exploding" or "The mine is enemy-exploded," according as one or other of the simpler judgments was made first. An examination of other cases would in like manner tend to show that intellectual synthesis is always—in itself and apart from implications—a binary synthesis. Wundt, to whom belongs the merit of first explicitly stating this "law of dichotomy or duality"¹ as the cardinal principle of discursive thinking, contrasts it with synthesis by mere association. This, as running on continuously, he represents thus—A—B—C—D— . . . ; the synthesis of thought, on the other hand, he symbolizes by forms such as the following:—

$$\overbrace{AB} \quad \overbrace{AB \quad CD} \quad \overbrace{AB \quad CDE} \quad \&c.$$

Thus, Socrates is a philosopher; the philosopher Socrates discovered a method; the philosopher Socrates discovered the dialectical method; &c. The point is that the one thing attended to in an intellectual act is the synthesis of two ideas, and of two ideas only, because, as only one movement of attention is possible at a time, only two ideas at a time can be synthesized. In that merely associative synthesis by which the memory-continuum is produced attention moves from A to B and thence to C without any relation between A and B being attended to at all, although they must have relations, that of sequence *e.g.* at least.

"Difference," says Hume, "I consider rather as a negation of relation than anything real or positive. Difference is of two kinds, as opposed either to identity or resemblance. The first is called a difference of *number*, the other of *kind*." The truth seems rather to be that difference in Hume's sense of numerical difference² is so far an element in all relations as all imply distinct correlatives. To this extent even identity—or at least the recognition of it—rests on difference, that form of difference, *viz.* which is essential to plurality. But absolute difference (*i.e.* diversity) of kind may be considered tantamount not, indeed, to the negation, but at least to the absence of all formal relation. That this absolute difference—or disparateness, as we may call it—affords no ground for relations becomes evident when we consider (1) that, if we had only a plurality of absolutely different presentations, we should have no consciousness at all (*cf.* § 11); and (2) that we never compare—although we distinguish—presentations which seem absolutely or totally disparate, as *e.g.* a thunderclap and the taste of sugar, or the notion of free trade and that of the Greek accusative. All actual comparison of what is qualitatively different rests upon at least partial likeness. This being understood, it is noteworthy that the recognition of unlikeness is, if anything, more "real or positive" than that of likeness, and is certainly the simpler of the two. In the comparison of sensible impressions—as of two colours, two sounds, the lengths or the directions of two lines, &c.—we find it easier in some cases to have the two impressions that are compared presented together, in others to have first one presented and then the other. But, either way, the essential matter is to secure the most effective presentation of their difference, which in every case is something

¹ Wundt, *Logik: eine Untersuchung der Principien der Erkenntnis* (2nd ed., 1893), i. 59 sqq.

² Hume's numerical difference, that is to say, is really distinctness, not quantitative difference.

positive and, like any other impression, may vary in amount from bare perceptibility to the extremest distance that the continuum to which it belongs will admit. Where no difference or distance at all is perceptible there we say there is likeness or equality. Is the only outcome, then, that when we pass from *ab* to *ac* there is a change in consciousness, and that when *ab* persists there is none? To say this is to take no account of the operations (we may symbolize them as $ac \rightarrow ab : c$, $ab \rightarrow ab : o$) by which the difference or the equality results. The change of presentation (*c*) and absence of change (*o*) are not here what they are as merely passive occurrences, so to put it. This is evident from the fact that in the former there is positive presentation and in the latter no presentation at all. The relation of unlikeness, then, is distinguished from the mere "position" or fact of change by (1) the voluntary concentration of attention upon *ab* and *ac* with a view to the detection of this change as *their* difference, and by (2) the act, relating them through it, in that they are judged unlike to that extent. The type of comparison is such superposition of geometrical lines or figures (as, *e.g.* in Euclid I. iv.) : if they coincide we have concrete equality; if they do not their difference is a line or figure. All sensible comparisons conform essentially to this type. In comparing two shades we place them side by side, and passing from one to the other seek to determine not the absolute shade of the second but its shade relative to the first—in other words, we look out for contrast. We do not say of one "It is dark," for in the scale of shades it may be light, but "It is darker"; or vice versa. Where there is no distance or contrast we simply have not *two* impressions, and, as said—if we consider the difference by itself—no impression at all. Two coincident triangles must be perceived as one. The distinction between the one triangle thus formed by two coinciding and the single triangle rests upon something extraneous to this bare presentation of a triangle that is one and the same in both cases. The marks of this numerical distinctness may be various: they may be different temporal signs, as in reduplications of the memory-continuum; or they may be constituents peculiar to each, from which attention is for the moment abstracted, any one of which suffices to give the common or identical constituent a new setting. In general, it may be said (1) that the numerical distinctness of the related terms is secured in the absence of all qualitative difference solely by the intellectual act which has so unified each as to retain what may serve as an individual mark; and (2) that they become related as "like" either in virtue of the active adjustment to a change of impression which their partial assimilation defeats, or in virtue of an anticipated continuance of the impression which this assimilation confirms.

It is in keeping with this analysis that we say in common speech that two things in any respect similar are so far the same. This ambiguity in the word "same," whereby it means either individual identity or indistinguishable resemblance has been often noticed, and from a logical or objective point of view justly complained of as "engendering fallacies in otherwise enlightened understandings." But apparently no one has inquired into its psychological basis, although more than one writer has admitted that the ambiguity is one "in itself not always to be avoided."³ It is not enough to trace the confusion to the existence of common names and to cite the forgotten controversies of scholastic realism. We are not now concerned with the conformity of thought to things or with logical analysis, but with the analysis of a psychological process. The tendency to treat presentations as if they were copies of things—the objective bias, as we may call it—is the one grand obstacle to psychological observation. Some only realize with an effort that the idea of extension is not extended; no wonder, then, if it should seem "unnatural" to maintain that the idea of two like things does not consist of two like ideas. But, assuming that both meanings of identity have a psychological justification, it will be well to distinguish

³ Cf. J. S. Mill, *Logic*, bk. i. ch. iii. § 11, and *Examination of Hamilton*, 3rd ed., ch. xiv. p. 306, note; also Meinong, "Hume-Studien" II., *Wiener Sitzungsberichte (Phil. Hist. Cl.)*, ci. 709.

them and to examine their connexion. Perhaps we might term the one "material identity" and the other "individual identity"—following the analogy of expressions such as "different things but all made of the same stuff," "the same person but entirely changed." Thus there is unity and plurality concerned in both, and herein identity or sameness differs from singularity or mere oneness, which so far entails no relation. But the unity and the plurality are different in each, and each is in some sort the converse of the other. In the one, two different individuals partially coincide; in the other, one individual is partially different; the unity in the one case is an individual presentation, in the other is the presentation of an individual.

In material identity the unity is that of a single presentation, whether simple or complex, which enters as a common constituent into two or more others. It may be possible, *Material Identity.* of course, to individualize it, but as it emerges in a comparison it is a single presentation and nothing more. On account of this absence of individual marks this single presentation is what logicians call "abstract"; but this is not psychologically essential. It may be a generic image which has resulted from the neutralization of individual marks, but it may equally well be a simple presentation, like red, to which such marks never belonged. We come here from a new side upon a truth which has been already expounded at length, viz. that presentations are not given to us as individuals but as changes in a continuum. Time and space—the instruments, as it were, of individualization, which are presupposed in the objective sciences—are psychologically later than this mere differentiation.

The many vexed questions that arise concerning individual identity are metaphysical rather than psychological. But it will serve to bring out the difference between the *Individual Identity.* two forms of identity to note that an identification cannot be established solely by qualitative comparison; an *alibi* or a breach of temporal continuity will turn the flank of the strongest argument from resemblance. Moreover, resemblance itself may be fatal to identification when the law of being is change.

41. As regards the real categories, it may be said generally that these owe their origin in large measure to the anthropomorphic or mythical tendency of human thought—*Real Categories.* τὸ ὁμοιον τῷ ὁμοίῳ γινώσκεισθαι. Into the formation of these conceptions two very distinct factors enter—(1) the facts of what in the stricter sense we call "self-consciousness," and (2) certain spatial and temporal relations among our presentations themselves. On the one hand, it has to be noted that these spatial and temporal relations are but the occasion or motive—and ultimately perhaps, we may say, the warrant—for the analogical attribution to things of selfness, efficiency and design, but are not directly the source of the forms of thought that thus arise. On the other hand, it is to be noted also that such forms, although they have an independent source, would never apart from suitable material come into actual existence. If the followers of Hume err in their exclusive reliance upon "associations naturally and even necessarily generated by the order of our sensations" (J. S. Mill), the disciple of Kant errs also who relies exclusively on "the synthetic unity of apperception." The truth is that we are on the verge of error in thus sharply distinguishing the two at all; if we do so momentarily for the purpose of exposition it behoves us here again to remember that mind grows and is not made. The use of terms like "innate," "a priori," "necessary," "formal," &c., without further qualification leads only too easily to the mistaken notion that all the mental facts so named are alike underived and original, independent not only of experience but of each other; whereas but for the forms of intuition the forms of thought would be impossible—that is to say, we should never have a self-consciousness at all if we had not previously learnt to distinguish occupied and unoccupied space, past and present in time, and the like. But, again, it is equally true that, if we could not feel and move as well as receive impressions, and if experience did not repeat

itself, we should never attain even to this level of spatial and temporal intuition. Kant shows a very lame and halting recognition of this dependence of the higher forms on the lower both in his schematism of the categories, and again in correcting in his Analytic the opposition of sense and understanding as respectively receptive and active with which he set out in his Aesthetic. Still, although what are called the subjective and objective factors of real knowledge advance together, the former is in a sense always a step ahead. We find *again* without us the permanence, individuality, efficiency, and adaptation we have found *first of all* within (cf. § 20, b and d). But such primitive imputation of personality, though it facilitates a first understanding, soon proves itself faulty and begets the contradictions which have been one chief motive to philosophy. We smile at the savage who thinks a magnet must need food or the child who is puzzled that the horses in a picture remain for ever still; but few consider that underlying all common-sense thinking there lurks the same natural precipitancy. We attribute to extended things a unity which we know only as the unity of an unextended subject; we attribute to changes among these extended things what we know only when we act and suffer ourselves; and we attribute further to them in their changes a striving for ends which we know only because we feel. In asking what they are, how they act, and why they are thus and thus, we assimilate them to ourselves, in spite of the differences which lead us by-and-by to see a gulf between mind and matter. Such instinctive analogies have, like other analogies, to be confirmed, refuted, or modified by further knowledge, *i.e.* by the very insight into things which these analogies have themselves made possible. That in their first form they were mythical, and that they could never have been at all unless originated in this way, are considerations that make no difference to their validity—assuming, that is, that they admit, now or hereafter, of a logical transformation which renders them objectively valid. This legitimation is, of course, the business of philosophy; we are concerned only with the psychological analysis and origin of the conceptions themselves.

42. As it must here suffice to examine one of these categories, let us take that which is the most important and central of the three, viz. causality or the relation of cause and effect, as that will necessarily throw some light upon the *Causality.* constitution of the others. To begin, we must distinguish three things, which, though very different, are very liable to be confused. (1) Perceiving in a definite case, *e.g.* that on the sun shining a stone becomes warm, we may say the sun makes the stone warm. This is a concrete instance of predicating the causal relation. In this there is, explicitly at all events, no statement of a general law or axiom, such as we have when we say (2) "Every event must have a cause"—a statement commonly known as the principle of causality. This again is distinct from what is on all hands allowed to be an empirical generalization, viz. (3) that such and such particular causes have invariably such and such particular effects. With these last psychology is not directly concerned at all: it has only to analyse and trace to its origin the bare conception of causation as expressed in (1) and involved in both these generalizations. Whether only some events have causes, as the notion of chance implies, whether all causes are uniform in their action or some capricious and arbitrary, as the unreflecting suppose—all this is beside the question for us.

One point in the analysis of the causal relation Hume may be said to have settled once for all: it does not rest upon or contain any immediate intuition of a causal nexus. The two relations that Hume allowed to be perceived (or "presumed to exist"), viz. contiguity in space of the objects causally related and priority in time of the cause before the effect, are the only relations directly discernible. We say indeed "The sun warms the stone" as readily as we say "The sun rises and sets," as if both were matters of direct observation then and there. But that this is not so is evident from the fact that only in some cases when one change follows upon another do we regard it as following from the other: casual coincidence is at least as common as causal connexion. Whence the difference, then, if not from perception? Hume's answer,¹ repeated in the main by English psychologists since, is, as all the world knows, that the difference is the result of association, that when a change α in an object A has been frequently observed to precede a change β in another object B, this repetition *determines* the mind to a transition from the one to the other. It is this

¹ *Treatise of Human Nature*, pt. iii. § xiv., "of the idea of necessary connexion."

determination, which could not be present at first, that constitutes "the third relation betwixt these objects." This "internal impression" generated by association is then projected; "for 'tis a common observation that the mind has a great propensity to spread itself on external objects."

The subjective origin and the after-projection we must admit, but all else in Hume's famous doctrine seems glaringly at variance with facts. In one respect it proves too much, for not all constant sequences are regarded as causal, as according to his analysis they ought to be; again, in another respect it proves too little, for causal connexion is continually predicated on a first occurrence. The natural man has always distinguished between causes and signs or portents; but there is nothing to show that he produced an effect many times before regarding himself as the cause of it. J. S. Mill has indeed obviated the first objection epistemologically by adding to constant conjunction the further characteristic of "unconditionality." But this is a conception that cannot be psychologically explained from Hume's premisses, unless perhaps by resolving it into the qualification that the invariability must be complete and not partial, whereupon the second objection applies. "Unconditional" is a word for which we can find no meaning as long as we confine our attention to temporal succession. It will not do to say both that an invariable succession generates the idea, and that such invariable succession must be not only invariable but also unconditional in order to generate it. We may here turn the master against the disciple: "the same principle," says Hume, "cannot be both the cause and the effect of another, and this is perhaps the only proposition concerning that relation which is either intuitively or demonstratively certain" (*op. cit.* p. 391). Unconditionality is then part of the causal relation and yet not the product of invariable repetition.

Perhaps the source of this element in the relation will become clear if we examine more closely the so-called "internal impression" of the mind, which according to Hume constitutes the whole of our idea of power or efficacy. To illustrate the nature of this impression Hume cites the instant passage of the imagination to a particular idea on hearing the word commonly annexed to it, when "'twill scarce be possible for the mind by its utmost efforts to prevent that transition" (*op. cit.* p. 393). It is this determination, then, which is felt internally, not perceived externally, that we mistakenly transfer to objects and regard as an intelligible connexion between them. But, if Hume admits this, must he not admit more? Can it be pretended that it is through the workings of association among our ideas that we first feel a determination which our utmost efforts can scarce resist, or that we feel such determination under no other circumstances? If it be allowed that the natural man is irresistibly determined to imagine an apple when he hears its name or to expect thunder when he sees lightning, must it not also be allowed that he is irresistibly determined much earlier and in a much more impressive way when overmastered by the elements or by his enemies? But, further, such instances bring to light what Hume's "determination" also implies, viz. its necessary correlative, effort or action. Even irresistible association can only be known as such by efforts to resist it. Hume allows this when he says that his principles of association "are not infallible causes; for one may fix his attention during some time on any one object without looking farther" (*op. cit.* p. 393). But the fact is, we know both what it is to act and what it is to suffer, to go where we would and to be carried where we would not, quite apart from the workings of association. And, had Hume not confused the two different inquiries, that concerning the origin of the idea of causation and that concerning the ground of causal inference or law of causation, it could never have occurred to him to offer such an analysis of the former as he does.

Keeping to the former and simpler question, it would seem that when in ordinary thinking we say A causes this or that in B we project or analogically attribute to A what we experience in acting, and to B what we experience in being acted on; and the structure of language shows that such projection was made long before it was suspected that what A once did and B once suffered will be done and suffered in the same circumstances again. The occasions suitable for this projection are determined by the temporal and spatial relations of the objects concerned, which relations are matter of intuition. These are of no very special interest from a psychological point of view, but the subjective elements we shall do well to consider further. First of all, we must note the distinction of immanent action and transient action; the former is what we call action simply, and implies only a single thing, the agent; the latter, which we might with advantage call effectuation, implies two things, a patient as well as an agent. In scientific language the agent in an intransitive act is called a *causa immanens* and so distinguished from the agent in effectuation or *causa transiens*. Common thought, however, does not regard mere action as caused at all; and we shall find it, in fact, impossible to resolve action into effectuation. But, since the things with which we ordinarily deal are complex, have many parts, properties, members, phases, and in consequence of the analytic procedure of thought, there ensues, indeed, a continual shifting of the point of view from which we regard any given thing, so that what is in one aspect one thing is in another many

(cf. § 20). So it comes about that, when regarding himself as one, the natural man speaks of himself as walking, shouting, &c.; but, when distinguishing between himself and his members, he speaks of raising his voice, moving his legs, and so forth. Thus no sooner do we resolve any given action into an effectuation, by analytically distinguishing within the original agent an agent and a patient, than a new action appears. Action is thus a simpler notion than causation and inexplicable by means of it. It is certainly no easy problem in philosophy to determine where the resolution of the complex is to cease, at what point we must stop, because in the presence of an individual thing and a simple activity. At any rate, we reach such a point psychologically in the conscious subject, and that energy in consciousness we call attention. If this be allowed, Hume's critique of the notion of efficacy is really wide of the mark. "Some," he says, "have asserted that we feel an energy or power in our own mind; and that, having in this manner acquir'd the idea of power, we transfer that quality to matter, where we are not able immediately to discover it. . . . But to convince us how fallacious this reasoning is, we need only consider that the will, being here consider'd as a cause, has no more a discoverable connexion with its effects than any material cause has with its proper effect. . . . The effect is there [too] distinguishable and separable from the cause, and could not be foreseen without the experience of their constant conjunction" (*op. cit.* p. 455). This is logical analysis, not psychological; the point is that the will is not considered as a cause and distinguished from its effects, nor in fact considered at all. It is not a case of sequence between two separable impressions; for we cannot really make the indefinite regress that such logical distinctions as that between the conscious subject and its acts implies. Moreover, our activity as such is not directly presented at all: we are, being active; and further than this psychological analysis will not go.² There are, as we have seen, two ways in which this activity is manifested, the receptive or passive and the motor or active in the stricter sense—(cf. § 8) and our experience of these we project in predicating the causal relation. But two halves do not make a whole; so we have no complete experience of effectuation, for the simple reason that we cannot be two things at once. We are guided in piecing it together by the temporal and spatial relations of the things concerned. Hence, perhaps, some of the antinomies that beset this concept. In its earliest form, then, the so-called necessary connexion of cause and effect is perhaps nothing more than that of physical constraint. To this, no doubt, is added the strength of expectation—as Hume supposed—when the same effect has been found invariably to follow the same cause. Finally, when upon the basis of such associated uniformities of sequence a definite intellectual elaboration of such material ensues, the logical necessity of reason and consequent finds a place, and so far as deduction is applicable cause and reason become interchangeable ideas.

Belief.

43. The mention of logical necessity brings us to a new topic, viz. the "objectivity" of thought and cognition generally. The psychological treatment of this topic is tantamount to an inquiry into the characteristics of the states of mind we call certainty, doubt, belief—all of which centre round the one fact of *evidence*. Between the certainty that a proposition is true and the certainty that it is not there may intervene many grades of uncertainty. We may know that A is sometimes B, or sometimes not; or that some at least of the conditions of B are present or absent; or the presentation of A may be too confused for distinct analysis. This is the region of probability, possibility, more or less obscurity. Leaving this aside, it will be enough to notice those cases in which certainty may be complete. With that certainty which is absolutely objective, i.e. with knowledge, psychology has no direct concern; it is for logic to furnish the criteria by which knowledge is ascertained.

Emotion and desire are frequent indirect *causes* of subjective certainty, in so far as they determine the constituents and the

¹ Hume here has Locke and Berkeley specially in view. Locke as a patient and acute inquirer was incomparably better as a psychologist than a man addicted to literary foppery like Hume, for all his genius, could possibly be. On the particular question, see Locke, *Essay*, bk. ii. c. 21, §§ 3-5.

² In an article (*Mind*, 1886, p. 317) Mr F. H. Bradley created some stir by declaring that "the present use of these phrases [active energy] is little better than a scandal and a main obstacle in the path of English psychology." In *Mind* for 1902 and 1903 he has made important contributions towards clearing up the supposed confusion, and the subject is still being debated. But the main contention of the text, that activity is for psychology at all events ultimate and unanalysable, seems still to await refutation. A brief notice of some of the diverse views obtaining will be found in an address, "The Problems of General Psychology," by J. Ward *Philosophical Review* (1904), pp. 608 sqq.

grouping of the field of consciousness at the moment—"pack the jury" or "suborn the witnesses," as it were. But the *ground* of certainty is in all cases some quality or some relation of these presentations *inter se*. In a sense, therefore, the ground of all certainty is objective—in the sense, that is, of being something at least directly and immediately determined for the subject and not by it. Where certainty is mediate, one judgment is often spoken of as the ground of another; but a syllogism is still psychologically a single, though not a simple, judgment, and the certainty of it as a whole is immediate. Between the judgment A is B and the question Is A B? the difference is not one of content nor scarcely one of form: it is a difference which depends upon the effect of the proposition on the subject judging. (i.) We have this effect before us most clearly if we consider what is by common consent regarded as the type of certainty and evidence, the certainty of present sense-impressions whence it is said, "Seeing is believing." The evident is here the actual, and the "feeling or consciousness" of certainty is in this case nothing but the sense of being taken fast hold of and forced to apprehend what is there. (ii.) The like is true of memory and expectation: in these also there is a sense of being tied down to what is given, whereas in mere imagination, however lively, this non-voluntary determination is absent (cf. § 26). Hume saw this at times clearly enough, as, e.g. when he says, "An idea assented to *feels* different from a fictitious idea that the fancy alone presents to us." But unfortunately he not only made this difference a mere difference of intensity, but spoke of belief itself as "an operation of the mind" or "manner of conception that bestowed on our ideas this additional force or vivacity."¹ In short, Hume confounded one of the indirect causes of belief with the ground of it, and again, in describing this ground committed the *ὑστερον πρότερον* of making the mind determine the ideas instead of the ideas determine the mind. (iii.) In speaking of intellection he is clearer: "The answer is easy with regard to propositions that are prov'd by intuition or demonstration. In that case the person who assents not only conceives the ideas according to the proposition, but is necessarily determin'd to conceive them in that particular manner" (*op. cit.* p. 395). It has been often urged—as by J. S. Mill, for example—that belief is something "ultimate and primordial." No doubt it is; but so is the distinction between activity and passivity, and it is not here maintained that certainty can be analysed into something simpler, but only that it is identical with what is of the nature of passivity—objective determination. As Bain put it, "The leading fact in belief . . . is our primitive credulity. We begin by believing everything; whatever is true" (*Emotions and Will*, 3d ed., p. 511). But the point is that in this primitive state there is no act answering to "believe" distinct from the non-voluntary attention answering to "perceive," and no reflection such as a modal term like "true" implies. With eyes open in the broad day no man says, "I am certain there is light"; he simply sees. He may by-and-by come absolutely to disbelieve much that he sees—e.g. that things are nearer when viewed through a telescope—just as he will come to disbelieve his dreams, though while they last he is certain in these too. The consistency we find it possible to establish among certain of our ideas becomes an ideal, to which we expect to find all our experience conform. Still the intuitive evidence of logical and mathematical axioms is psychologically but a new form of the actual; we are only certain that two and two make four and we are not less certain that we see things nearer through a telescope.

Presentation of Self, Self-Consciousness and Conduct.

44. The concept of self we have just seen underlying and to a great extent shaping the rest of our intellectual furniture; on this account it is at once desirable and difficult to analyse it and ascertain the conditions of its development. In attempting this we must carefully distinguish between the bare presentation of self and that reference of other presentations to it which is often called specially self-consciousness, "inner sense," or

¹ *Treatise of Human Nature*, Green and Grose's ed., i. 396.

internal perception. Concerning all presentations whatever—that of self no less than the rest—it is possible to reflect, "This presentation is mine; it is my object; I am the subject attending to it." The presentation of self, then, is one presentation among others, the result, like them, of the differentiation of the original continuum. But it is obvious that this presentation must be in existence first before other presentations can be related to it. On the other hand, it is only in and by means of such relations that the concept of self is completed. We begin, therefore, with self simply as an object, and end with the concept of that object as the subject or "myself" that knows itself. The self has, first of all (a) a unique interest and (b) a certain inwardness, (c) it is an individual that (d) persists, (e) is active, and finally (f) knows itself. These several characteristics of self are intimately involved; so far as they appear at all they advance in definiteness from the lowest level of mere sentience to those moments of highest self-consciousness in which conscience approves or condemns volition.

The earliest and to the last the most important element in self—what we might perhaps term its root or material element—is that variously styled the organic sensations—vital sense, coenaesthesia, or somatic consciousness. This largely *Self and the Body* determines the tone of the special sensations and enters, though little suspected, into all our higher feelings. If, as sometimes happens in serious nervous affections, the whole body or any part of it should lose common sensibility, the whole body or that part is at once regarded as strange and even as hostile. In some forms of hypochondria, in which this extreme somatic insensibility and absence of zest leave the intellect and memory unaffected, the individual doubts his own existence or denies it altogether. Ribot cites the case of such a patient, who, declaring that he had been dead for two years, thus expressed his perplexity:—"J'existe, mais en dehors de la vie réelle, matérielle, et, malgré moi, rien ne m'ayant donné la mort. Tout est mécanique chez moi et se fait inconsciemment."² It is not because they accompany physiological functions essential to the efficiency of the organism as an organism, but simply because they are the most immediate and most constant sources of feeling, that these massive but ill-defined organic sensations are from the first the objects of the directest and most unreflecting interest. Other objects have at the outset but a mediate interest through subjective selection in relation to these, and never become so instinctively and inseparably identified with self, never have the same inwardness. This brings us to a new point. As soon as definite perception begins, the body as an extended thing is distinguished from other bodies, and such organic sensations as can be localized at all are localized within it. At the same time the actions of other bodies upon it are accompanied by pleasures and pains, while their action upon each other is not. The body also is the only thing directly set in motion by the reactions of these feelings, the purpose of such movements being to bring near to it the things for which there is appetite and to remove it from those towards which there is aversion. It is thus not merely the type of occupied space and the centre from which all positions are reckoned, but it affords us an unfailling and ever-present intuition of the actually felt and living self, to which all other things are external, more or less distant, and at times absent altogether. The body then first of all gives to self a certain measure of individuality, permanence and inwardness.

But with the development of ideation there arises within this what we may call an inner zone of self, having still more unity and permanence. We have at this stage not only an intuition of the bodily self doing or suffering *Inner Self*. here and now, but also memories of what it has been and done under varied circumstances in the past. External impressions have by this time lost in novelty and become less absorbing, while the train of ideas, largely increased in number, distinctness and mobility, diverts attention and often shuts out the things of sense altogether. In all such reminiscence or reverie a generic image of self is the centre, and every new image as it arises derives all its interest from relation to this; and so apart from bodily appetites new desires may be quickened and old emotions stirred again when all that is actually present is dull and unexciting. But desires and emotions, it must be remembered, though awakened by what is only imaginary, invariably entail actual organic perturbations, and with these the generic image of self comes to be intimately united. Hence arises a contrast between the inner self, which the natural man locates in his breast or *σπῆν*, the chief seat of these emotional disturbances, and the whole visible and tangible body besides. Although from their nature they do not admit of much ideal representation, yet, when actually present, these organic sensations exert a powerful and often irresistible influence over other ideas; they have each their appropriate train, and so heighten in the very

² "Bases affectives de la personnalité" in *Revue philosophique*, xviii. 149.

complex and loosely compacted idea of self those traits they originally wrought into it, suppressing to an equal extent all the rest. Normally there is a certain equilibrium to which they return, and which, we may suppose, determines the so-called temperament, *naturel* or disposition, thus securing some tolerable uniformity and continuity in the presentation of self. But even within the limits of sanity great and sudden changes of mood are possible, as, e.g. in hysterical persons or those of a "mercurial temperament," or among the lower animals at the onset of parental or migratory instincts. Beyond those limits—as the concomitant apparently of serious visceral derangements or the altered nutrition of parts of the nervous system itself—complete "alienation" may ensue. A new self may arise, not only distinct from the old and devoid of all save the most elementary knowledge and skill that the old possessed, but diametrically opposed to it in tastes and disposition—obscenity, it may be, taking the place of modesty and cupidity or cowardice succeeding to generosity or courage. The most convincing illustrations of the psychological growth and structure of the presentation of self on the lower levels of sensation and ideation are furnished by these melancholy spectacles of minds diseased; but it is impossible to refer to them in detail here.¹

Passing to the higher level of intellection, we come at length upon the concept which every intelligent being more or less distinctly forms of himself as a person, M. or N., having such and such a character, tastes and convictions, such and such a history, and such and such an aim in life.

The main instrument in the formation of this concept, as of others, is language, and especially the social intercourse that language makes possible. Up to this point the presentation of self has shaped that of not-self,—that is to say, external things have been comprehended by the projection of its characteristics. But now the order is in a sense reversed: the individual advances to a fuller self-knowledge by comparing the self within with what is first discernible in other persons without. So far *avant l'homme est la société*; it is through the "us" that we learn of the "me" (cf. § 36, note 1). Collective action for common ends is of the essence of society, and in taking counsel together for the good of his tribe each one learns also to take counsel with himself for his own good on the whole; with the idea of the common weal arises the idea of happiness as distinct from momentary gratification. The extra-regarding impulses are now confronted by a reasonable self-love, and in the deliberations that thus ensue activity attains to its highest forms—those of thought and volition. In the first we have a distinctly active manipulation of ideas as compared with the more passive spectacle of memory and imagination. Thereby emerges a contrast between the thinker and these objects of his thought, including among them the mere generic image of self, from which is now formed this concept of self as a person. A similar, even sharper, contrast also accompanies the exercise of what is very misleadingly termed "self-control," i.e. control by this personal self of "the various natural affections"—to use Butler's phrase—which often hinder it as external objects hindered them. It is doubtful whether the reasoning, regulating self is commonly regarded as definitely localized. The effort of thinking and concentrating attention upon ideas is no doubt referred to the brain, but this is only comparable with the localization of other efforts in the limbs; when we think we commonly feel also, and the emotional basis is of all the most subjective and inalienable. If we speak of this latest phase of self as *par excellence* "the inner self," such language is then mainly figurative, inasmuch as the contrasts just described are contrasts into which spatial relations do not enter.

45. The term "reflection," or internal perception is applied to that state of mind in which some particular presentation or group of presentations (x or y) is not simply in the field of consciousness but there as consciously related to self, which is also presented at the same time. Self here may be symbolized by M, to emphasize the fact that it is in like manner an object in the field of consciousness. The relation of the two is commonly expressed by saying, "This (x or y) is my (M's) percept, idea or volition; I (M) it is that perceive, think, will it." Self-consciousness, in the narrowest sense, as when we say "I know myself, I am conscious that I am," &c., is but a special, though the most important, instance of this internal perception: here self (M) is presented in relation to self (with a difference, M'); the subject itself—at least, so we say—is or appears as its own object.

It has been often maintained that the difference between consciousness and reflection is not a real difference, that to know and to know that you know are "the same thing considered in

different aspects."² But different aspects of the same thing are not the same thing, for psychology at least. Not only is it not the same thing to feel and to know that you feel; but it might even be held to be a different thing still to know that you feel and to know that you know that you feel—such being the difference perhaps between ordinary reflection and psychological introspection.³ The difficulty of apprehending these facts and keeping them distinct seems obviously due to the necessary presence of the earlier along with the later; that is to say, we can never know that we feel without feeling. But the converse need not be true. How distinct the two states are is shown in one way by their notorious incompatibility, the direct consequence of the limitation of attention: whatever we have to do that is not altogether mechanical is ill done unless we lose ourselves in the doing of it. This mutual exclusiveness receives a further explanation from the fact so often used to discredit psychology, viz. that the so-called introspection, and indeed all reflection, are really retrospective. It is not while we are angry or lost in reverie that we take note of such states, but afterwards, or by momentary side glances intercepting the main interest, if this be not too absorbing.

But we require an exacter analysis of the essential fact in this retrospect—the relation of the presentation x or y to that of self or M. What we have to deal with, it will be observed, is, implicitly at least, a judgment. First of all, then, it is noteworthy that we are never prompted to such judgments by everyday occurrences or acts of routine, but only by matters of interest, and, as said, generally when these are over or have ceased to be all-engrossing. Now in such cases it will be found that some effect of the preceding state of objective absorption persists, like wounds received in battle, unnoticed till the fight is over—such e.g. as the weariness of muscular exertion or of long concentration of attention; some pleasurable or painful after-sensation passively experienced, or an emotional wave subsiding but not yet spent; "the jar of interrupted expectation," or the relief of sudden attainment after arduous striving, making prominent the contrast of contentment and want in that particular; or, finally, the quiet retrospect and mental rumination in which we note what time has wrought upon us and either regret or approve what we were and did. All such presentations are of the class out of which, as we have seen, the presentation of self is built up, and so form in each case the concrete bond connecting the generic image of self with its object. In this way and in this respect each is a concrete instance of what we call a state, act, affection, &c., and the judgments in which such relations to the standing presentation of self are recognized are the original and the type of all real predications. The opportunities for reflection are at first few, the materials being as it were thrust upon attention, and the resulting "percepts" are but vague. By the time, however, that a clear concept of self has been attained the exigencies of life make it a frequent object of contemplation, and as the abstract of a series of instances of such definite self-consciousness we reach the purely formal notion of a subject or pure ego. For empirical psychology this notion is ultimate; its speculative treatment falls altogether—usually under the heading "rational psychology"—to metaphysics.

46. The growth of intellection and self-consciousness reacts powerfully upon the emotional and active side of mind. To describe the various sources of feeling and of desire that thus arise—aesthetic, social and religious sentiments, *Conduct*, pride, ambition, selfishness, sympathy, &c.—is beyond the scope of systematic psychology, and certainly quite beyond the limits of an article like the present. But at least a general *résumé* of the characteristics of activity on this highest or rational level is indispensable. If we are to gain any oversight in a matter of such complexity it is of the first importance to keep steadily in view, as a fundamental principle, that as the causes of feeling become more complex, internal, and representative the consequent actions change in like manner. We have noted this

²So—misled possibly by the confusions incident to a special faculty of reflection, which they controvert—James Mill, *Analysis*, i. 224 seq. (corrected, however, by both his editors, pp. 227 and 230), and also Hamilton, *Lect.* i. 192.

³It has been thought a fatal objection to this view that it implies the possibility of an indefinite regress; but why should it not? We reach the limit of our experience in reflection, or at most in deliberate introspection, just as in space of three dimensions we reach the limit of our experience in another respect. But there is no absurdity in supposing a consciousness more evolved and explicit than our self-consciousness, and advancing on it as it advances on that of the unreflecting brutes.

¹This subject has a very wide literature. The following are especially interesting: Ribot, *Les Maladies de la personnalité* (3rd ed., 1889); Boris Sidis and S. P. Goodhart, *Multiple Personality* (1905); Morton Prince, *The Dissociation of a Personality* (1906).

connexion already in the case of the emergence of desires, and seen that desire in prompting to the search for means to its end is the *primum movens* of intellection (cf. § 35). But intellect does much more than devise and contrive in unquestioning subservience to the impulse of the moment, like some demon of Eastern fable; even the brutes, whose cunning is on the whole of this sort, are not without traces of self-control. As motives conflict and the evils of hasty action recur to mind, deliberation succeeds to mere invention and design. In moments of leisure, the more imperious cravings being stilled, besides the rehearsal of failures or successes in the past, come longer and longer flights of imagination into the future. Both furnish material for intellectual rumination, and so we have at length (1) concepts of general and distant ends, as wealth, power, knowledge, and—self-consciousness having arisen—that concept also of the happiness or perfection of self, and (2) maxims or practical generalizations as to the best means to these ends. Instead of actions determined by the *vis a tergo* of blind passion we have conduct shaped by what is literally prudence or foresight, the pursuit of ends that are not esteemed desirable till they are judged to be good. The good, it is truly urged, is not to be identified with the pleasant, for the one implies a standard and a judgment, and the other nothing but a bare fact of feeling; thus the good is often not pleasant and the pleasant not good; in talking of the good, in short, we are passing out of the region of nature into that of character. It is so, and yet this progress is itself so far natural as to admit of psychological explication. As already urged (§ 34), the causes of feeling change as the constituents of consciousness change; also they depend more upon the form of that consciousness as this increases in complexity. When we can deliberately range to and fro in time and circumstances, the good that is not directly pleasant may indeed be preferred to what is only pleasant while attention is confined to the seen and sensible; but then the choice of such good is itself pleasant—pleasanter than its rejection would have been.

The mention of deliberation brings us to the perennial problem of "the freedom of the will." But to talk of will is to lapse into the confusions of the old faculty—psychology. As **Freedom.** Locke long ago urged: "The question is not proper, whether the will be free, but whether a man be free."¹ In the absence of external constraint, when a man does what he likes, we say he is "externally free"; but he may still be the slave of every momentary impulse, and then it is said that he is not "internally" free. The existence and nature of this internal freedom is the problem. But if such freedom is held to imply a certain sovereignty or autonomy of self over against momentary propensities and blind desires, there can obviously be no question of its existence till the level of self-consciousness is reached and maxims or principles of action are possible. The young child, the brute and the imbecile, even when they do as they like, have not this freedom, though they may be said to act spontaneously. A resolutely virtuous man will have more of this freedom than the man of good moral disposition who often succumbs to temptation; but it is equally true that the hardened sinner has more of it than one still deterred in his evil ways by scruples of conscience. A man is internally free, then, whenever the ends he pursues have his whole-hearted approval, whether he say with Milton's Satan, "Evil be thou my good," or with Jesus, "Thy will be done." But this freedom is always within our experience a relative freedom; hence at a later time we often declare that in some past act of choice we were not our true selves, not really free. But what is this true self more than our ideal? Or perhaps we prefer to say that we were free and could have acted otherwise; and no doubt we might, if the place of the purely formal and abstract concept of self had been occupied by some other phase of that empirical self which is continuously, but at no one moment completely, presented. It must then be admitted that psychological analysis in this case is not only actually imperfect, but must always remain so—so long, at any rate, as all that we discern by reflection is less than all we are. But this admission does not commit us to allowing the possible existence of a *liberum arbitrium indifferentiae*, sometimes called "absolute indeterminism"; for that would seem to differ in no respect from absolute chance or caprice. On the other hand, the rigidly determinist position can only be psychologically justified by ignoring the activity of the experiencing subject altogether. At bottom it treats the analysis of conduct as if it were a dynamical problem pure and simple. But motives are never merely so many quantitative forces playing upon something inert, or interacting entirely by themselves. At the level of self-consciousness especi-

ally motives are reasons and reason is itself a motive. In the blind struggle of so-called "self-regarding" impulses might is the only right; but in the light of principles or practical maxims right is the only might.² This superiority in position of principles is only explicable by reference to the inhibitory power of attention, which alone makes deliberation possible and is essentially voluntary; that is, subjectively determined. But no, it may be objected, deliberation in such cases is just the result of painful experiences of the evil of hasty action, and only ensues when this motive is strong enough to restrain the impulse that would otherwise prevail. Even if this be granted, it does not prove that the subject's action is determined for and not by him; it merely states the obvious fact that prudence and self-control are gradually acquired. Authoritative principles of action, such as self-love and conscience, are no more psychologically on a par with appetites and desires than thought and reason are on a par with the association of ideas.

Relation of Body and Mind.

47. The question of subjective initiative leads us naturally to that concerning the connexion of mind and organism, to which we now proceed. In development and efficiency, in **Parallelism.** the intensity and complexity of their processes, mind and brain keep invariably and exactly in line together. Striking and impressive instances of this correspondence are to be found in comparative psychology, and especially in mental pathology; but it is needless here to enlarge on a point which in the main is beyond dispute. In this correspondence lay the plausibility of the old materialism. But a closer scrutiny discloses an equally impressive disparity: we reject materialism, accordingly, while still maintaining this *psychoneural parallelism* to be a well-established fact. From this we must distinguish a second sense of parallelism founded on the disparity just mentioned as pertaining to the psychical and neural correlates. We may call this *physiologico-psychological*, or, more briefly, *methodological, parallelism*. It disclaims as illogical the attempt to penetrate to psychical facts from the standpoint of physiology, so persistently and confidently pursued by the old materialists. It also forbids the psychologist to piece out his own shortcomings with tags borrowed from the physiologist. The concepts of the two sciences are to be kept distinct, as the facts themselves to which they relate are distinct. Confusion is inevitable if the psychologist, for example, talks of his volition as the cause of his arm moving, when by arm movement he means the process described by the physiologist in terms of efferent excitations, muscular flexions, and so forth; or if the physiologist speaks of a sensation of red as produced by retinal stimulation due to light-waves of a certain length, when by sensation he means what he immediately experiences on looking at a field poppy. This methodological convention, as we may call it, implies a more stringent interpretation of causation than that expounded by J. S. Mill and his contemporaries. It does not, however, forbid psychological inferences on the basis of physiological facts, nor vice versa. But in spite of this distinctness of the facts, and of the standpoints from which they are respectively studied, their causal relation cannot be simply ignored: it is, however, a problem that pertains strictly to the higher standpoint of philosophy. There have been in all four different theories of this relation within modern times: (1) that of mutual interaction—the common-sense view—very inconsistently maintained by Descartes; (2) the "occasionalism" substituted for this by Geulincx and the later Cartesians; (3) the pre-established harmony of Leibnitz; and (4) the monism of Spinoza, which reduced matter and mind to parallel attributes of the One Substance. The last of these—severed, however, from Spinoza's metaphysics—is still perhaps the prevailing theory, and to it the term *psychophysical parallelism* most properly applies. For whereas the parallelism first mentioned states a real correspondence between psychical processes and neural processes, but leaves open the question of a possible interaction between matter and mind, modern psychophysical parallelism is a pure hypothesis concerning the relation of psychical facts to physical theories, on the ground of which—as we shall presently see—any interaction between matter and mind is expressly denied.

² The right is only relative, of course, when the maxims are "hypothetical"—to use Kant's phrase,—but it is absolute when the maxim is "categorical."

¹ *Essay concerning Human Understanding*, II. xxi. §§ 16 sqq.

But in the exposition of this hypothesis these two meanings of parallelism are frequently confused or interchanged. The same term "body" is applied both to an aggregate of matter and to the living organism. Now life must be regarded as either inherent in matter, or as the result simply of a particular material configuration, or as physically inexplicable. But, for the present at all events, it cannot be explained physically; nor are we even within measurable distance of such an explanation: so much is beyond cavil. Yet the hypothesis of psychophysical parallelism confines us to one or other of the former alternatives: at the same time its unwarrantable identification with psychoneural parallelism—where we find a real correspondence between mind and *organism*—tends to conceal the gravity of such assumptions. The standpoint of physiology, therefore, must be described not as identical with that of physics, but as intermediate between it and the standpoint of psychology. If the fact of life could be reduced to physical terms, physiology then, no doubt, would have to fall into line with physics, much as chemistry, for example, may have had to do. On the other hand, till a physical explanation of life is forthcoming, physiology belongs, with psychology, to the biological group of sciences, and cannot divest itself completely of the teleological concepts essential to them, not a vestige of which belongs to bare physics. It is just because of this community in their concepts that there actually is a certain "point to point" correspondence or parallelism between the psychical and the neural: as an *organ* a neuron is a unit; physically regarded, it ceases to be one. Yet this illicit identification of organism and material body is thought to be legitimate, inasmuch as physiological processes are found to rest invariably on a physical basis: and inasmuch as, though methodological parallelism forbids the physiologist to identify *psychosis* with *neurosis*, no limits can be imposed on his efforts to ascertain the mechanism of the neurosis itself. But if this be granted, is not psychophysical parallelism justified, in principle at all events? By no means: as little, for example, as an explanation of the mechanism of a locomotive would justify us in ascribing its origin, its maintenance or its guidance to the machine itself. When life and mind are explained by their mechanism the physicist may summon the biologist, as Mephistopheles did Faust, "*Her zu mir*": then, but not before.

A favourite mode of stating psychophysical parallelism is that known as the *Double Aspect Theory*. In this, besides "Double Aspect" meanings, we find also an equally unjustified interpretation of parallelism in the second sense. All that methodology prescribes is that psychologists and neurologists—and, we may add, that physicists too—shall severally, as "specialists," mind their own business. Again, all that the first two jointly ascertain is simply the fact of correspondence: the explanation of it is still to seek. Two propositions are now advanced which are held to meet this need. First—and negatively—the connexion, it is said, is not causal: mind does not act on body, nor body on mind: the changes on each side form two independent series, each "going along by itself." In other words, the series themselves are said to exemplify what methodology enjoins on the sciences that investigate them—they mind their own business and never intrude into each other's domains. Nevertheless their interaction is not *prima facie* contradictory or absurd, and ordinary thought, as we have seen, assumes that it exists. What evidence, then, is there for denying it absolutely? Empirical evidence for such a universal negative there can hardly be; it must be established therefore—if established at all—on *a priori* grounds. Meanwhile two facts, already noticed, make seriously against it. On the psychical side sensations point to an intrusion of some sort, and are not psychically explicable (cf. § 16), and the like—for the present at all events—must be said of the fact of life on the physical side. Apart from all this, it seems plain that methodological parallelism, so far from justifying the denial of interaction, simply precludes its discussion on the dualistic level to which that parallelism is confined. The gulf implied is indeed not absolute—of so much, parallelism in the first sense assures us—but those who are forced to keep to their own side of it obviously are not the people to settle how it is crossed. We are aware that the dualism is not absolute, it is replied: it is only phenomenal, and the two series of phenomena are conditioned by an underlying unity of substance. Such is the second, and positive, proposition of the theory. Again asking for evidence, we are told that this underlying unity is unknown—in fact, unknowable. This unknowable substance is assumed, then, simply because—the impossibility of causal connexion being taken as established—no other alternative remains. The nega-

tive proposition is thus the foundation of the theory, and without it this agnostic monism becomes entirely arbitrary. We have, therefore, to continue our search for the grounds on which the possibility of interaction is denied. But it will be worth while first to examine certain ambiguities besetting the positive statement.

Difference of aspect may result solely from difference of standpoint, or it may be due to difference in the reality itself. The circle, seen as concave from within and as convex from without, is an ancient instance of the first still in great favour; the pillar that was cloud and darkness to the Egyptians, but light to the children of Israel, may serve to exemplify the second. The former we may call the phenomenal, and the latter the ontal, meaning of "aspect." With these two very different meanings our theory plays fast and loose, as suits its own convenience. To do this is easy—in so far as the reality is unknown and unknowable; and necessary—since in the end, the reality, however unknowable, must somehow include both the phenomenal aspects and all that pertains to them, and so far therefore be known. In dealing with "aspect" in the first sense, the one question to be raised concerns the nature and relation of the respective standpoints. To one belongs what we know as individual experience, and this is essentially concrete, immediate, and qualitatively diverse; to the other belongs an abstract, conceptual scheme, wholly quantitative, familiarly known as the mechanical theory. Between these there is plainly no such co-ordination as the inept comparison with the inside and the outside of a circle implies.¹ Neither is there, on the other hand, the same complete opposition; for the entire mechanical theory is based upon individual experience as enlarged and developed by inter-subjective intercourse. Both the sense-knowledge of the one and the thought-knowledge of the other relate to the one objective factor involved in both. So far, then, there is fundamentally only one standpoint—that of the subjective factor to the objective factor, which is immediately perceived in the one and mediately conceived in the other. The question here raised is thus primarily epistemological, but it is a question, as we have seen, in which psychology is intimately concerned. "Aspect" in the second sense is independent of standpoints. We have here to deal with attributes of the one reality, more or less in Spinoza's sense: this reality itself, as possessed of disparate attributes, is so far dual, and the question of causal connexion between these attributes is not escaped. For to know that a thing has invariably two distinct attributes does not enable us to determine straightway how the changes or "modes" of the one are connected with those of the other. (1) The same attribute might be always the initiating or independent variant, and then would come the question of finding out which of the two it was; or (2) it might be that now one, now the other, took the lead, the grounds of this alternation being then the topic for inquiry; or, finally, (3) it might be, as our theory assumes, that there was but a single series of double changes. The questions here raised are philosophical questions, but again they are questions in which psychology is intimately concerned. Our examination thus yields two results: first, there is fundamentally only a single standpoint—that of experience, now at the perceptual, now at the conceptual, level; and secondly, the distinction of aspects is not merely phenomenal, but pertains "somehow" to reality. The question is how; and this leads us to resume our inquiry into the grounds on which interaction is denied.

These grounds neither pertain to psychology nor to physiology. In spite of the outstanding difficulties connected with sensation and life, which these sciences severally raise, such denial is upheld

¹ In fact, if there were, since it is only as we contemplate finite portions of the circle that the distinction of concave and convex is present, the nearer we approximated to its elements the more this difference of aspect would disappear. If on the physical side we called these elements atoms, there would be an answering element of "mind-stuff" on the psychical; and there would be no more unity and no other diversity in a given man's mind than in his brain regarded as a complex of primordial atoms. Wild as all this seems, yet views of the kind have been seriously put forward more than once as the logical outcome of psychophysical parallelism.

mainly on the strength of an interpretation of the principle known as the conservation of energy—an interpretation of it, however, which many of the ablest physicists disallow. The energy of the physical world, it is maintained, is a strictly invariable amount; matter, therefore, cannot act on mind, for such action would entail a decrease, nor can mind act on matter, since that would entail an increase, of this energy. In other words, the material world is held to be a "closed system"; and as all the changes within it are mass-motions, there can be none which are not the effect and equivalent of antecedent mass-motions. But now this statement must be established on physical grounds: to assume it otherwise would be openly to beg the very question at issue. For if mind does act on matter, the physical mechanism *is* subject to changes from without, and so often its motions are *not* due to antecedent motions; and this—the common-sense view—cannot, of course, be summarily dismissed as impossible or absurd. Now, energy is essentially a metrical notion, and its conservation in finite and isolated material systems has been ascertained by careful quantitative experiments. To say that the energy of the material universe is constant is only a way of expressing the generalization of this result—is tantamount, in other words, to saying that it holds of all finite isolated systems. The *whole* universe may perhaps be called isolated, but we do not know that it is finite. We cannot, therefore, apply metrical concepts to it; and consequently we cannot interpret the conservation of energy as meaning that the physical part of it is a closed system. But if not a closed system, then the energy of a given group of bodies may be increased or decreased without interaction between that group and other bodies—may be increased or decreased by psychophysical interaction, that is to say. And, moreover, such psychophysical interaction would not invalidate the conservation of energy, rightly understood; for that merely means that the energy of a group of bodies can be altered only from without, and this might happen whenever such interaction occurred.¹ We seem, therefore, justified for the present in rejecting psychophysical parallelism as one of the three possible modes of relating mind and matter regarded as attributes of the real. Not only are there psychological as well as biological objections which it has not yet overcome, but there are so far no physical grounds in its favour.

At this point we may again for a moment turn aside to consider a modified form of the doctrine—the so-called *Conscious Automaton Theory*, an attempt to blend the old Cartesian views concerning the minds of man and brute. According to Huxley,² the best known modern exponent of this theory, "our mental conditions are simply the symbols in consciousness of the changes that take place automatically in the organism." This consciousness is supposed "to be related to the mechanism of the body simply as a collateral product of its working, and to be as completely without any power of modifying that working as the steam-whistle . . . is without influence upon the locomotive's machinery": thus "the feeling we call volition is not the cause of a voluntary act, but the symbol of that state of the brain which is the immediate cause of that act." In other words, physical changes are held to be independent of psychical, whereas psychical changes are declared to be their "collateral products." They are called *collateral* products, or "epiphenomena," to obviate the charge of materialism, and to conform to the interpretation of the conservation of energy that we have just discussed. Such a theory is, strictly speaking, one of parallelism no longer: rather it adopts, instead, the first of the two possibilities we have noted above as opposed to parallelism. According to it, matter is the initiating or independent variant, on whose changes mind simply follows suit. It is open to two fatal objections. First, it is methodologically unsound: its psychology is physiological in the

¹ The possibility is enough: we cannot tell what actually happens, and do not, therefore, know how far the direction of matter by mind calls for a modification or limitation of physical hypotheses. Cf. Ward, *Naturalism and Agnosticism* (3rd ed., 1906), ii. 73-86.

² Essay on "Animal Automatism," *Collected Essays*, vol. i.

bad sense. It regards all states of consciousness as passive, *i.e.* as ultimately either "feelings" or "reflexes." Volitional activity is declared illusory; and if this be true, intellectual activity must be illusory too. But to detect illusion requires experience of reality—we only know the sham by knowing the genuine first; and even passive states could not be experienced as such save by contrast with states that are active. To the physical side, then, we naturally turn for this knowledge which we are told is not to be found on the psychical; and we do so the more readily as, according to the present theory, the physical holds the primary place. But we turn in vain; for matter is inert, and its energy only "works" by taking the line of least resistance, like water running down hill. Moreover, such activity as we are in search of could only be found here in case the physical mechanism showed signs of being intelligently directed, and that would also be evidence that psychical activity is not illusory. Is, then, the physical side after all primary? No, we reply: the assumption is epistemologically unsound. This is our second objection. The *order* implied in the distinction of physical phenomena and psychical *epiphenomena* is contrary to all experience and indefensible. A physical phenomenon is either actually perceived or possibly perceptible; otherwise it is devoid of empirical reality altogether. But objects of perception are so far psychical; that is, they belong to immediate or individual experience. Therefore we cannot regard them as independent of this experience, nor this as their collateral product, *i.e.* as epiphenomenal. Again, the *phenomenality* supposed to be common to both involves, as we have already seen, a fundamental identity in the standpoint of each: they belong to the same continuous experience at different levels. And lastly, their abstract, merely quantitative, character shows that it is the concepts of physics, and not the facts of immediate experience, that are symbolic, and so to say epithetic. The attempt—either empirically or speculatively—to outflank mind by way of matter is an absurdity on a par with getting into a basket in the hope of being able to carry oneself.

These epistemological considerations may help us to deal with the prime and ultimate argument for strict parallelism. When all is said and done, it is urged, still the interaction of mind and matter remains inconceivable. But this is hardly a sufficient reason for denying what is *prima facie* a fact. Occasionalists, from Geulinx to Lotze, have acknowledged the same obscurity in *all* cases of transeunt action. Yet they did not venture to deny that sensations were interruptions in the psychical series, the "occasions" for which were only to be found in the physical; nor that purposive movements were interruptions in the physical series, the "occasions" for which were only to be found in the psychical. And surely such a position is more in harmony with experience than that of the parallelists, who maintain that each series "goes along of itself"—a statement which, as we have repeatedly urged, contradicts psychology and assumes the physical "explanation" of life. Whereas occasionalism leaves the question of ultimate means to be dealt with by a metaphysics which will respect the facts,³ parallelism forecloses it on the basis of a ready-made metaphysics—modern naturalism, that is to say—in which psychology as an independent science is entirely ignored. Starting with a dualism as absolute as that of Descartes—*but* replacing his two substances by one, enjoying the *odium cum dignitate* of the Unknowable—starting, too, from the physical side, no wonder such a philosophy finds that what is for us the most familiar and of the supremest interest, the concrete world of sense and striving, is for it the altogether inconceivable, the supreme "world riddle." And yet if the naturalist could deign to listen to the plainest teachings of psychology and of epistemology, the riddle would seem no longer insoluble, for his phenomenal dualism and his agnostic monism would alike disappear. The material mechanism which he calls Nature would rank not as the profoundest reality there is to know: it would rather become—what indeed "machine" primarily connotes—an instrumentality subservient to the "occasions" of the living world of ends; and so regarded, it would cease to be merely calculable, and

³ Cf. Lotze, *Metaphysik*, § 61 *fin*.

would be found intelligible as well. Psychophysical parallelism, then, we conclude, is not a philosophically tenable position; and—pending the metaphysical discussion as to the ultimate nature of interaction generally—we have to rest content with the second of the three possible modes of connexion above defined, as occasionalism formulates it. According to this, the two series, the psychical and the physical, are not independent and “closed” against each other; but in certain circumstances—e.g. in perception—physical changes are the occasion of psychical, and in certain circumstances—e.g. in purposive movements—psychical changes are the occasion of physical: the one change not being explicable from its psychical antecedents, nor the other from its physical.

Into the metaphysical discussion we cannot, of course, enter here. It must suffice to say that it will not be conducted on the lines of our present inquiry: it will not start from a dualism of matter and mind, either regarded as substances or as phenomena. Its problem will rather be the interaction of subject and object—a duality in the unity of experience, which by no means coincides with the dualism of matter and mind, neurosis and psychosis, and the like.

COMPARATIVE PSYCHOLOGY

48. Psychoneural parallelism is no doubt a well established generalization; nevertheless, concerning its exact range and its precise meaning there are differences of opinion. It is applicable, every one will allow, so soon as there is evidence of experiences individually acquired (cf. § 3); and from such point onwards, in ascending any biological phylum, we find that the psychical and neural aspects differentiate and develop together. But how when we descend? Interpreting the neural correlate physiologically, and not morphologically, as referring primarily to function and not to structure, we find that even in unicellular organisms it is still present as irritability and conductivity (leading to contraction, secretion, &c.). But as at higher levels psychosis is correlative to neurosis, the principle of continuity would seem to justify us in assuming a like correspondence here. Moreover, “learning by experience,” the comparative psychologist’s criterion, obviously presupposes some antecedent and underlying process, of which it is the differentiation and development. And our general analysis of mind, if correct, enables us to describe this process—“the irreducible psychical minimum,” of which we are here in search. We have such complete psychosis—and it is the simplest we know—in the emotional or diffused movements that follow immediately upon sensation; and these are so far purposive—though not intentional—that they tend to heighten or retain what is pleasurable, and to alleviate or remove what is painful. Given that plasticity, which is the psychological presupposition of all acquisition, then learning by experience is a possible development from such a primitive stage.

But though every psychosis have its concomitant neurosis, it is uncertain how far the converse holds good. The action of the heart, for example, depends upon neuroses of which we have now no *direct* consciousness. Facts of this kind have led to three hypotheses concerning the lowest forms of life, differing more or less from that just proposed. (i.) Perfectibility and instinct are found, it is said, to be in inverse ratio. Hence in the lowest forms of life there is no “learning by experience,” because a stationary state of complete adjustment to environment has been already attained, and all reactions have therefore become “secondarily automatic”: consciousness, having served its purpose, has disappeared. To such a very Buddhist psychology it may be objected: (1) that even organic reflexes tell upon the so-called vital sense or *coenaesthesia*, and so far—the irreducible minimum being still intact—do not preclude all possibility of learning, should occasion arise; and (2) that the psychical life, even of a Protozoan, does not, according to the best evidence, show any such mechanical finality as is here supposed.¹ (ii.) According to the second view, which is advocated by Herbert Spencer, the behaviour of the lower organisms is wholly made

up of such reflexes, supposed to be devoid of all psychical concomitants; but consciousness—so far from having disappeared—first comes upon the scene at the opportune moment when the increasing complexity of the mechanism calls for its guidance. Psychologically this hypothesis is less defensible than the last, and it has already been dealt with at some length (cf. § 7). It not only assumes, as that does, far more uniformity in the interaction of organism and environment than the facts warrant, but in regarding life as prior to mind, and as the means of its evolution, it burdens science with two insoluble problems instead of one. For even if it were possible chemically to build up protoplasm, we should still be as far from organisms as a heap of bricks are from putting themselves together as a house. (iii.) The last view we have to notice is essentially an extension of the preceding, and is chiefly interesting as a *reductio ad absurdum* of that. The physics of colloidal substances—at present wanting, but confidently expected “in the near future” by certain biologists—is the key which is to unlock the mysteries of protoplasm. Certain organisms, regarded as varieties of such a substance, react positively to a given physical property of the environment, and others negatively: thus a moth flies towards the light, and a centipede runs from it—the one is positively, the other negatively, “heliotropic”; the radicle of a seed, growing downwards, is, positively, the plumule, growing upwards, is, negatively, “geotropic.” Instincts are but complexes of such tropisms, and owe their character entirely to the symmetrical form and definite structure of the colloidal substance. Now if it facilitate the work of the biologist to say that when what we ordinarily regard as a hungry caterpillar climbs to the tip of a branch it is forced so to do by positive heliotropism; that then positive chemiotropism sets up mastication of the young buds; and that, lastly, “we can imagine this process leading to the destruction of the substances in the skin of the animal that are sensitive to light, and upon which the heliotropism depended,” so leaving it free to crawl downwards and come in contact with the new buds which have in the meantime unfolded²—if such language serve any useful purpose, all well and good; only it must be applied to the hungry man too: in short, all behaviour must be described in the same terms. For the champion of colloids to betake himself to consciousness as he approaches the higher forms of life is as much a breach of methodological parallelism as it is for the psychologist to fall back upon protoplasm as he approaches the lower. But to suppose that psychical processes first appear in the complicated form of association of ideas—which learning by experience is taken to imply—and at the same time to assume that such experience, even when it appears, is “ultimately due to the motions of colloidal substances,” these are incongruous absurdities which only the grossest ignorance would be bold enough to maintain.

Concluding, as we have done, that mind and matter—as we may provisionally call them—do really interact, we naturally infer that organic structures are not the result solely of material processes, but involve the co-operation of mental direction and selection: in other words, we are led to regard structure as partly shaped and perfected by function, rather than function as solely determined by structure, itself mechanically evolved. And such a view is justified by the fact that mechanical evolution is primarily a process of “degradation” rather than development, a case of *facilis descensus* contrasting with the upward struggle of life *per aspera ad astra*. Still, the notion of life or mind as formative and directive has its difficulties. In the first place, we have no experience of mind organizing matter—no experience of the actual process, that is to say—however sure we may feel of the fact.³ Hence the occasionalism to which here, at any rate, science is confined. But even so, the difficulty is not wholly removed. In the handicrafts whence we derive the conception

² Cf. J. Loeb, *Comparative Psychology* (1901), pp. 188 sqq.—an interesting book, full of psychological crudities.

³ But, of course, a thoroughgoing spiritualism ought to explain the very existence of matter as really the appearance or manifestation of mind.

¹ Cf. H. S. Jennings, *Behaviour of the Lower Organisms* (1906).

of organs the artificer handles, but does not literally order, his tools—as if they too were intelligent. The conscious direction of such movements is doubtless facilitated by the fact that many of the complex co-ordinations actually involved in them are carried out automatically, thanks to structural modifications, either inherited or acquired. And, regarding life phylogenetically, we can imagine this process carried back indefinitely. Indeed, if it be illogical to talk of mechanisms evolving themselves and giving rise to the beings whose ends they serve, we have no choice but to accept this dualism of mind-shaping and matter inert. No choice, that is, unless we can establish the primacy of the psychological standpoint. Here we have duality but not dualism, and the object is not inert, *i.e.* is not matter. But still there remain two difficulties—possibly resolvable into one—the plasticity already referred to as involved in all biological development and hereditary transmission; as to these, psychology is almost wholly in the dark.¹

AUTHORITIES.—*Historical:* There are few good works on the history of psychology; the only one in English, R. Blakey, *History of the Philosophy of Mind from the Earliest Period to the Present Time* (London, 1848), is poor. F. A. Carus's *Geschichte der Psychologie* (Leipzig, 1808) is at least useful for reference. A work bearing the same title by H. Siebeck (the first part consisting of two divisions—(i.) *Die Psychologie von Aristoteles*, (ii.) *Die Psychologie von Aristoteles bis zu Thomas von Aquino* (Gotha, 1880 and 1884) is thoroughly and carefully done. Siebeck has also contributed a series of articles, "Zur Psychologie der Scholastik," to the *Archiv f. d. Gesch. d. Philos.* (vols. i.—iii.). *Die Philosophie in ihrer Geschichte (I. Psychologie)*, by Professor Harms (Berlin, 1878), is also good. T. A. Ribot's *La Psychologie anglaise contemporaine* (3rd ed., 1892) and *La Psychologie allemande contemporaine* (2nd ed., 1885) are lucid and concise in style, though the latter work in places is superficial and inaccurate. Of Max Dessoir's *Geschichte der neueren deutschen Psychologie* the section dealing with the 17th-century writers prior to Kant went into a second edition in 1897; it contains a useful collection of material. From *Les Origines de la psychologie contemporaine* (2nd ed., 1908), by the neo-Thomist scholar Mgr. D. Mercier, much may be learnt, though its purpose is not primarily historical.

Positive: The recent output of systematic works on psychology has been voluminous. Among the most important of these may be mentioned J. Sully's *The Human Mind* (2 vols., 1892); W. James, *Principles of Psychology* (2 vols., 1890); G. F. Stout, *Analytic Psychology* (2 vols., 1896); *A Manual of Psychology* (2nd ed., 1901); H. Höfding, *Outlines of Psychology* (1891; translated from the Danish); G. T. Ladd, *Psychology, Descriptive and Explanatory* (1894); W. Wundt, *Grundriss der Psychologie* (4th ed., 1901, translated); F. Jodl, *Lehrbuch der Psychologie* (2 vols., 2nd ed., 1902). Dealing mainly with experimental psychology are: Külpe, *Grundriss der Psychologie auf experimenteller Grundlage dargestellt* (1893; translated); Ebbinghaus, *Grundzüge der Psychologie* (3rd ed., 1908), Bd. I.; and E. B. Titchener, *Experimental Psychology: a Manual of Laboratory Practice* (2 vols., 1901); C. S. Myers, *Experimental Psychology* (1908).

Of the older more advanced textbooks Professor Volkmann's *Lehrbuch der Psychologie* (2 vols., 3rd ed., 1885; edited by Cornelius) is written in the main from a Herbartian standpoint. To the honoured name of Lotze belongs a distinguished place in any enumeration of modern productions in philosophy; his *Medizinische Psychologie* (Göttingen, 1852) is still valuable. A large part of his *Mikrokosmos* (3 vols., 3rd ed., 1876–1880; trans. into English, 2 vols., 1885) and one book of his *Metaphysik* (2nd ed., 1884; also trans. into English) are, however, devoted to psychology. The doctrine of evolution has been as fruitful in this study as in other sciences that deal with life. In this respect Herbert Spencer's *Principles of Psychology* (2 vols., 3rd ed., 1881) and *Data of Ethics* (1879) occupy a foremost place. Dr Alexander Bain's standard volumes, *The Senses and the Intellect* (4th ed., 1894) and *The Emotions and the Will* (3rd ed., 1875), contain a good deal of "physiological psychology," but no adequate recognition of the importance of the modern theory of development. Wundt's *Physiologische Psychologie* (3 vols., 6th ed., 1908 seq.) is indispensable to the student of this subject.

Specially interesting as treating psychological problems on new lines are *La Psychologie des idées-forces*, by A. Fouillée (2 vols., 1893)—perhaps the best French contribution to recent psychology; its cardinal point is the fundamentally dynamical character of the psychical. R. Avenarius, *Kritik der reinen Erfahrung* (2 vols., 1888–1890; 2nd ed., 1908), is an attempt, on the model of Kirchhoff and Mach's treatment of physics, to describe experience, taking the relation of the central nervous system to the environment as starting-point. Its strange and forbidding terminology prevented the timely recognition of its merits; but since the author's death in 1896—from overwork and disappointment—quite a literature has grown up,

partly expository, partly controversial, devoted to this latest critique. H. Cornelius, *Psychologie als Erfahrungswissenschaft* (1897), rather epistemological than psychological, claims affinity with the critiques of Kant and Avenarius. In J. Rehmke's *Lehrbuch der allgemeinen Psychologie* (2nd ed., 1905)—a psychology with a soul, and claiming to be philosophy as well—the problems of perception and of psychoneural interaction are discussed at length. F. Brentano, *Psychologie vom empirischen Standpunkte* (1874), vol. i., treats presentations and judgments as fundamentally distinct, feeling and willing, on the other hand, as fundamentally one. His influence on Austrian psychologists has been considerable, and is more or less apparent in the following: K. Twardowski, *Zur Lehre vom Inhalt und Gegenstand der Vorstellungen* (1894); A. Meinong, *Psychologisch-ethische Untersuchungen zur Werththeorie* (1894), and also numerous important papers; v. Ehrenfels, *System der Werththeorie* (2 vols., 1897–1898); A. Höfler, *Psychologie* (1897).

Important as treating of particular topics are C. Stumpf, *Tonpsychologie* (2 vols., 1883–1890); A. Lehmann, *Die Hauptgesetze des menschlichen Gefühlsleben* (trans. from the Danish; 1892); various monographs by T. A. Ribot on diseases of memory, will, personality, on the psychology of attention, of the emotions, of general ideas, &c., all translated into English; J. M. Baldwin, *Social and Ethical Interpretations in Mental Development* (1897); W. Wundt, *Völkerpsychologie* (3 vols., 1900); W. McDougall, *An Introduction to Social Psychology* (1908).

There are several periodicals devoted exclusively to psychology, the chief being the *American Journal of Psychology*; the *Psychological Review*; *Zeitschrift für Psychologie und Physiologie der Sinnesorgane*; *L'Année psychologique*; the *British Journal of Psychology*; and *Archiv für die gesammte Psychologie*. (J. W. *)

PSYCHOPHYSICS (from Gr. ψυχή, soul, φύσις, nature), a department of psychology which deals with the physiological aspects of mental phenomena, and in particular investigates the quantitative relations between stimuli and the resultant sensations. Following the introspective school of which the last leader was Alexander Bain, the tendency of psychological investigation, in the hands of Fechner, Helmholtz, Wundt, Münsterberg, was predominantly psychophysical, and psychological study, especially in Germany, where the first fully-equipped laboratory was set up in Leipzig (1870) by Wundt, and in America became largely a matter of experiment and apparatus. Such apparatus has been devised for optical, acoustical, haptical (Gr. ἅπτειν, touch), taste and smell experiments. Haptical apparatus includes the *kinesimeter* (for cutaneous sensation), the *thermaesthesiometer* (for heat and cold sensation), the *algometer* or *algesimeter* (for pain sensations), the *aesthesiometer* (*e.g.* those of Jastrow and Münsterberg). Among important apparatus for measuring the time relations of mental processes are the *d'Arsonval chronometer*, which marks hundredths of a second, and the *Hipp chronoscope*, in which the stimulus and the clock are electrically connected.

For authorities see Baldwin's *Dict. of Philos. and Psych. s.v.* "Laboratory," and the latest psychological textbooks.

PTARMIGAN (*Lagopus mutus* or *alpinus*), a gallinaceous bird akin to the grouse (*q.v.*). The word in Gaelic is *tarmachan*, which appears from the end of the 16th century in many forms, such as *tormican*, *tarmichen*, and even "termagant."

PTERIA (mod. *Boghaz Keui*), the ancient capital of the "White Syrians" of Cappadocia, which Croesus of Lydia is stated by Herodotus to have taken, enslaved and ruined, after he had declared war on the rising power of Persia and crossed the Halys (after the middle of the 6th century B.C.). Thereafter he fought a drawn battle near the city, and retired again across the river to his ultimate defeat and doom. Pteria is mentioned by no other ancient authority, but it is of great interest if, as seems highly probable, (1) its "White Syrian" inhabitants were what we call "Hittites" (*q.v.*), or at least, participants in the "Hittite civilization"; (2) its remains are to be seen in the immense prehistoric city and remarkable rock-sculptures near Boghaz Keui in Cappadocia, about 100 m. east of Angora and beyond the Kizil Irmak (*Halys*). This is the chief "Hittite" site in Asia Minor, far superior in extent to either Euyuk or Giauvar Kalesi, which seem to have been its dependencies, and a centre from which roads, marked by the occurrence of "Hittite" monuments, radiate towards Syria and the Aegean. Sir W. M. Ramsay has shown with great probability that it was the importance of Pteria and its bridge over the Halys which

¹ On the subject of comparative psychology generally, see *Animal Behaviour* (1900), by Professor C. Lloyd Morgan; L. T. Hobbhouse, *Mind in Evolution* (1901).

diverted the Persian "royal road" far to the north of its natural line. This road, in fact, followed an earlier main track whose ultimate objective had been different.

The remains of Boghaz Keui are indubitably pre-Persian and pre-Greek. They consist of a large fortified city on a steep slope enclosed by two deep ravines, and falling to northward over 800 ft. from summit to base. The acropolis was strengthened with a circle of stone redoubts, between which led very narrow gateways, and with internal redoubts as well. Just inside what seems to have been its principal entrance is a rock face inscribed with nine lines of "Hittite" characters, greatly perished (Nishan Tash), and a similar inscription, equally illegible, can be detected on a neighbouring rock. Below the acropolis on the north-east is a residential quarter, containing large ruins of what seems to have been a palace or temple built round a central court. The whole site is surrounded by a strong wall, 14 ft. thick, with towers about 100 ft. apart. The monument, however, which earliest rendered Boghaz Keui famous is the sculptured rock grotto, 1 m. to the east, called Yasili Kaya. Here two hypaethral galleries are adorned with reliefs in panels, the larger gallery showing two processions, which, starting on both walls from the entrance, meet at the head of the grotto. On the left wall are 45 figures, headed by a gigantic male figure, erect on the bent necks of two men. On the right wall he is opposed by a female of almost equal stature standing on a leopard or lioness, and followed by a young male with battle-axe, erect on a similar beast. Behind these are some 20 figures of mitred priests, &c. There can be no doubt that the female is the great Nature goddess of western Asia, attended by her spontaneously-generated son, with whose help she creates the world (see GREAT MOTHER OF THE GODS). Priests or minor divinities follow them. The other procession, according to the analogy of other monuments, should be composed of mortals bearing *sacra* and headed by their king, who makes offering or dedicates his city to, or engages in some mystic union with, the goddess. The figure following him seems to be that of his high priest. "Hittite" symbols are carved above many of the figures. Besides the processions there are five independent reliefs in the small gallery and its approach, one repeating the figure of the high priest.

In 1906, as the result of the discovery of cuneiform tablets at Boghaz Keui by E. Chantre in 1890, a concession for the excavation of the site was obtained by the Berlin Oriental Society, and H. Winckler was sent to make a preliminary examination. He found a number of tablets in two languages, Babylonian and local, the latter being that of the Arzawa letters found at Tell el-Amarna. Among them was a cuneiform copy of the treaty made by Rameses II. in his 20th year with the king of the Kheta, and inscribed on a wall at Karnak. In 1907 Winckler returned with O. Puchstein and others and made regular excavations, laying bare much of the fortifications and two temples, and finding inscribed monuments and many more tablets. From those written in Babylonian Winckler has established the fact that Boghaz Keui was the capital of a powerful Hatti dynasty from the middle of the 16th century B.C. to at least 1200 B.C. He claims further that its ancient name was Hatti. At the height of its power it ruled all Asia Minor down to the Aegean and northern Syria to the headwaters of the Orontes, and was also overlord of the Mitanni and the Amurri (Amarru) in Mesopotamia. It had continual relation on terms of equality with Egypt and Babylonia. The four kings of the Kheta, alluded to by name in Egyptian texts, have been identified with kings of Boghaz Keui. The decline of Hatti power began with the expansion of Assyria after 1100 B.C. and Cappadocia seems to have been inferior to Phrygia after the rise of the Midæan dynasty in the 9th and 8th centuries. It should be added that the identification of Boghaz Keui with the Pteria of Herodotus has not yet been confirmed, and the latter name has been claimed for a primitive site at Ak-alan near Samsun by Th. Makridi Bey, as the result of his excavations for the Constantinople Museum in 1907 (see HITTITES).

AUTHORITIES.—C. Ritter, *Erdkunde*, xviii; C. Texier, *Descr. de l'Asie Mineure* (i., 1843); J. Hamilton, *Researches*, &c. (1842); H. Barth, *Reise von Trapezunt*, &c. (*Ergänz. Petermann's Geog. Mith.*; 1860); G. Perrot and E. Guillaume, *Expl. arch. de la Galatie* (1862-1872); K. Humann and O. Puchstein, *Reisen in Kleinasien u. Nordsyrien* (1890); Murray's *Guide to Asia Minor* (1894); G. Perrot and C. Chipiez, *Hist. de l'art* (1886) vol. iv.; Lord Warkworth, *Notes of a Diary*, &c. (1898); E. Chantre, *Mission en Cappadocie* (1898). (For recent excavations see HITTITES.) (D. G. H.)

PTERIDOPHYTA (Gr. πτέρις, fern, and φυτόν plant), or as they are frequently called, the Vascular Cryptogams, the third of the large subdivisions of the vegetable kingdom. The Ferns form the great majority of existing Pteridophytes; the importance and interest of the other groups, of which the Club-mosses and Horsetails are the most familiar examples, depend largely on the fact that they are the surviving representatives of large families of plants which flourished in earlier geological periods. (See PALAEOBOTANY.)

The relation which exists between the two alternating stages

or generations, which together constitute the complete life-cycle of all plants higher than the Thallophyta, is perhaps the most natural characteristic of the Pteridophyta. From the germinated spore of a fern plant, which must not be confused with the "seed" of seed-bearing plants, a small, flat, green organism is developed; this is the prothallus (gametophyte, sexual generation; fig. 7). As the result of fertilization of an ovum produced by this, the fern plant (sporophyte, asexual generation) originates; from it spores are ultimately set free, with the germination of which the life-history again commences. The point common to all Pteridophyta is that from the first the gametophyte is an independent organism, while the sporophyte, though in the first stages of its development it obtains nutriment from the prothallus, becomes physiologically independent when its root develops. This independence of the two generations for the greater part of their lives distinguishes this group

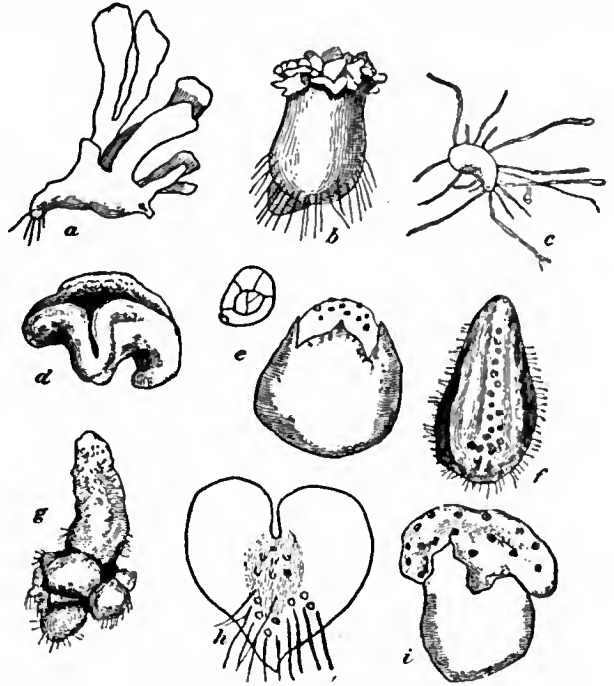

FIG. 1.—Diagrammatic sketches of prothalli of—

- a, Equisetum.
- b, Lycopodium cernuum.
- c, L. phlegmaria.
- d, L. clavatum.
- e, Selaginella.
- f, Botrychium virginianum.
- g, Helminthostachys.
- h, A Fern.
- i, Salvinia.

on the one hand from the Bryophyta (in which the sporophyte is throughout its life attached to the gametophyte), and on the other hand from the Gymnosperms and Angiosperms (in which the more or less reduced gametophyte remains enclosed within the tissues of the sporophyte). The gametophyte, which is usually dorsiventral, though in some cases radially symmetrical (fig. 1, b), is a small thallus attached to the soil by rhizoids. In structure it is equally simple, being composed of parenchymatous tissue without any clearly marked conducting system. Usually it grows exposed to the light and contains chlorophyll, but subterranean saprophytic prothalli also occur in the Lycopodiaceae and Ophioglossaceae (fig. 1, c, d, f, g). In the heterosporous forms the gametophyte is more or less reduced (fig. 1, e, i). The reproductive organs ultimately produced on the same or on different individuals are of two kinds, the antheridia and archegonia; the origin of both is from single superficial cells of the prothallus. The antheridium (fig. 8) at maturity consists of a layer of cells forming the wall which encloses a group of small cells; from each of the latter a single motile spermatozoid originates. The archegonium (fig. 9) consists of a more or less projecting neck and the venter, which is usually enclosed by the tissue of the prothallus. A central series of cells can be distinguished in it, the lowest of which is the ovum; above this come

the ventral canal cell and one or more canal cells. When the archegonium has opened by the separation of the terminal cells of the neck, the disintegration of the canal cells leaves a tubular passage, at the base of which is the ovum (fig. 9, b). Down this

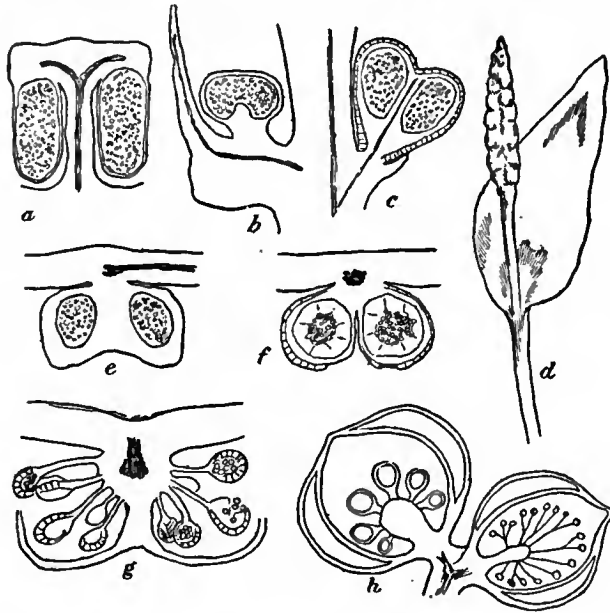

FIG. 2.—Diagrammatic sketches of spore-producing members of—
a, Equisetum. *d*, Ophioglossum. *g*, Nephrodium.
b, Lycopodium. *e*, Kaulfussia. *h*, Salvinia.
c, Psilotum. *f*, Angiopteris.

(All except *d* represent vertical sections of sporangiophore or sorus.)

canal the spermatozoid, which in the Ferns has been shown to be attracted by reason of its positive irritability to malic acid, passes and fuses with the ovum. After fertilization the latter surrounds itself with a cell-wall and develops into the sporophyte. The early segmentation of the embryo differs in the several groups, but usually the first leaf or leaves, the apex of the stem and the first root are differentiated early, while a special absorbent organ (the foot) maintains for some time the physiological connexion between the sporophyte and the prothallus. The sporophyte is always highly organized both as regards form and structure. Root, stem and leaf can be distinguished even in the simplest forms, and the plant is traversed by a well-developed vascular system. The reproductive organs of the sporophyte are the sporangia, within which the spores are produced; the sporangia are often borne on or in relation to leaves, which may be more or less distinct from the foliage leaves in form and structure (cf. fig. 2). The cells of the wall of the sporangium are usually so constructed as to determine the dehiscence of the sporangium and the liberation of its spores. The spores produced in each sporangium vary from very many to a single one in the case of some heterosporous forms. These latter bear spores of two kinds, microspores and megaspores, in separate sporangia. From the microspore an extremely reduced male prothallus and from the megaspore the female prothallus, develops (cf. fig. 1, *e*). The spores of the homosporous Vascular Cryptogams are usually of small size; the prothalli produced from them usually bear both antheridia and archegonia, though under special conditions an imperfect sexual differentiation may result. The complete life-history, with its regular alternation of gametophyte and sporophyte, is now known in all except a few rare genera of recent Pteridophyta, and will be described in connexion with the several groups. A cytological difference of great importance between the two generations can only be mentioned in passing. The nuclei of the cells of the sexual generation possess a definite number of chromosomes and this number is also characteristic of the sexual cells. On fertilization the number is doubled and all the cells of the spore-bearing generation have the double number. On the formation

of the spores a reduction to the number characteristic of the gametophyte takes place.

The systematic arrangement of the Vascular Cryptogams for the purposes of identification and description necessarily remains unchanged, while the comparative morphology is being more fully worked out. But modifications in the order of placing the natural groups are of importance in expressing the results of such investigations. Such a scheme may be placed here in a tabular form before entering on the consideration of the life-history, natural history, morphology, and classification of the several groups:—

Classification.

Pteridophyta.

I. EUISETALES . . .	{	<i>Equisetaceae.</i>
	{	<i>Calamariaceae.</i>
II. SPHENOPHYLLALES . . .	{	<i>Sphenophyllaceae.</i>
III. PSILOTALES . . .	{	<i>Cheirostrobaceae.</i>
	{	<i>Psilotaceae.</i>
IV. LYCOPODIALES . . .	{	<i>Lycopodiaceae.</i>
	{	<i>Selaginellaceae.</i>
	{	<i>Lepidodendraceae.</i>
V. OPHIOGLOSSALES . . .	{	<i>Isoetaceae.</i>
	{	<i>Ophioglossaceae.</i>
VI. FILICALES . . .	{	<i>Filicaceae</i> . . .
	{	<i>Marattiaceae.</i>
	{	<i>Osmundaceae.</i>
	{	<i>Schizaeaceae.</i>
	{	<i>Gleicheniaceae.</i>
	{	<i>Maloniaceae.</i>
	{	<i>Loxosomaceae.</i>
	{	<i>Hymenophyllaceae.</i>
	{	<i>Cyatheaceae.</i>
	{	<i>Polypodiaceae.</i>
	{	<i>Hydropterideae</i> {
	{	<i>Salviniaceae.</i>
	{	<i>Marsiliaceae.</i>

These main subdivisions are of unequal size and importance. The Sphenophyllales are only known in a fossil state, while the Equisetales, Lycopodiales and Filicales include both living and extinct representatives. The small groups of recent plants forming the Psilotales and Ophioglossales are given independence in this scheme of classification owing to their exact affinities with the other phyla being at present doubtful.

I. EUISETALES.—The plants of the single living genus *Equisetum*, which vary in height from a few inches to 40 ft., have subterranean rhizomes, from which the erect shoots arise. The habit of the plant depends on the degree of branching rather than upon the foliage. The internodes are elongated and hollow. The leaves are borne in whorls, those of each whorl cohering, except at their extreme tips, to form a sheath. The leaves of successive whorls alternate with one another, and this applies also to the branches which arise in the axil of the leaf sheath. In most species many of these buds, which alternate with the leaves, remain dormant, but in others the aerial shoots are copiously and repeatedly branched. In some species branches of the rhizome with tuberos internodes are formed, which serve as a means of vegetative reproduction. The roots which arise from the base of the lateral buds remain undeveloped on the aerial stem. The vascular bundles equal in number the leaf-teeth from which they enter the stem and form a single ring. Each bundle runs downwards through one internode and then divides into two branches which insert themselves on the alternating bundles entering at this node. The young stems, and the older stems of certain species, are clearly monostelic; but in other species an inner and outer endodermis may be present, or an endodermal layer surrounds each bundle. The vascular bundles themselves are collateral, the xylem consisting of the protoxylem, towards the centre of the stem, and two groups of xylem, between which the phloem is situated; the protoxylem elements soon break down, giving rise to the carinal canal. Only the median or carinal strand of xylem is common to stem and leaf; the lateral cauline strands possibly represent the remains of a centripetally developed mass of primary xylem. There is no secondary thickening except at the node in *E. maximum*, where some short tracheides, arranged in radial rows, arise from a cambium. The stems, the surface of which exhibits a number of ridges with intervening furrows, perform the greater part of the work of assimilation. The chlorophyll-containing tissue reaches the surface at the sides and base of the furrows,

where stomata of peculiar form occur in the epidermis, while subepidermal strands of sclerenchyma occupy the ridges. In the cortical tissue beneath each furrow a wide intercellular space is present running the length of the internode, and called the

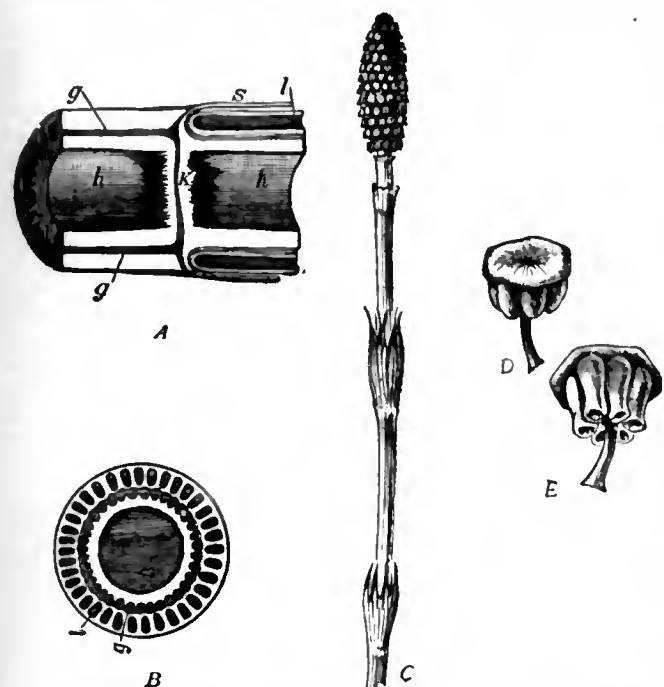

(C, D, E from Strasburger's *Lehrbuch der Botanik*, by permission of Gustav Fischer.)

FIG. 3.—*Equisetum maximum*.

A, Longitudinal section of the rhizome, including a node and portions of the adjoining internodes; *k*, septum between the two internodal cavities, *hh*; *gg*, vascular bundles; *l*, vallicular canal; *s*, leaf-sheath.

B, Transverse section of the rhizome; *g*, vascular bundle; *l*, vallicular canal.

C, Fertile shoot showing two leaf-sheaths and the terminal strobilus.

D, E, Sporophylls bearing sporangia, which in E have opened.

vallicular canal. The central cylinder of the root, in which there are several xylem and phloem strands, has around it a two-layered endodermis, the inner layer of which appears to take the place of a pericycle. The sporangia are borne upon lateral outgrowths of the axis (the sporangiophores), which arise in whorls and are associated in definite strobili or cones (fig. 3, C); at the base of the cone an outgrowth of the axis like a rudimentary leaf sheath (the annulus) is present. Each sporangiophore (fig. 3 D) consists of a stalk expanding into a peltate disk of hexagonal outline; from the inner surface of the latter six to nine large sporangia hang parallel with the stalk. The single vascular bundle supplies a branch to the base of each sporangium. The latter arises from a number of superficial cells, the cells destined to form the spores being derived from a single one of these. A tapetal layer is derived from the cells surrounding the sporogenous group, and the arrest of a number of the spore-mother-cells further contributes to the nourishment of the remainder, each of which gives rise to four spores. The outermost layer of the cell-wall of the ripe spore splits along spiral lines, giving rise to the elaters; these two long strips of wall, attached by their middle points to the spore, tend to straighten out in dry, and close round the spore in damp air. They thus assist in the opening of the sporangium, which takes place by a slit on its inner face. Further, several spores will be likely to germinate together owing to their elaters becoming entangled; a fact of some importance, since the antheridia and archegonia, though occurring sometimes on the same prothallus, are more often borne on separate individuals. The prothalli contain abundant chlorophyll, and are dorsiventral. Those that bear the antheridia are the smaller, and are either filamentous, or flattened, and irregularly lobed. The antheridia are

deeply sunk in the tissue; the spermatozoids consist of a spiral of two or three coils, the numerous cilia being attached to the pointed anterior end. The female prothalli, which are sometimes branched, consist of a thick cushion bearing thin, erect lobes, at the base of which the archegonia are situated. The necks of the latter are short, the central series of cells consisting of ovum, ventral canal cell and one or two canal cells. The half of the embryo directed towards the archegonial neck gives rise to the apex of the stem and a sheath of three leaves, the other half to the small foot and the primary root. The first shoots are of limited growth, being replaced by lateral branches, which gradually acquire the number of leaf-teeth characteristic of the species.

Fossil species, some of which attained a great size, are known, to which the name *Equisetites* is given, since they appear to be closely allied to the existing forms. Two other extinct genera, *Phyllothea* and *Schizoneura*, may be mentioned here. Abnormal specimens of *Equisetum* in which the strobilus is interrupted by whorls of leaves are of interest for comparison with the fructification of *Phyllothea*. The most important and best known of the extinct Equisetales are, however, the Calamites (see PALAEOBOTANY: *Palaeozoic*). In the primary structure of the stem the Calamites present many points of resemblance to *Equisetum*, but secondary thickening went on in both stem and root. These plants, which appear to have grown in swampy soil, thus attained the dimensions of considerable trees. The leaves, which were of simple form (except in *Archaeocalamites*, where they forked), were inserted in whorls at the nodes; they were either free from one another or cohered by their bases into a sheath. The branches alternated in position with the leaves, and sprang from just above the insertion of the latter. Some of the branches terminated in cones, which present a general similarity to those of *Equisetum*. This similarity is closest in *Archaeocalamites*, an ancient type found in Upper Devonian rocks; in this the strobilus consists of peltate sporangiophores inserted in whorls on the axis. In the other Calamarian strobili known the whorls of sporangiophores are separated by whorls of bracts. In some the sporangiophores stood midway between the sterile whorls, while in others they approached the whorl above or below. There is a close resemblance between these sporangiophores and those of *Equisetum*, but as a rule only four sporangia were borne on each. Some Calamites were heterosporous, sporangia with microspores and megaspores being found in the same cone.

Our knowledge of the extinct Equisetales, full as it is with respect to certain types, does not suffice for a strictly phylogenetic classification of the group. The usual subdivision is into Equisetaceae including *Equisetum* and *Equisetites* (with which *Phyllothea* and *Schizoneura* may be provisionally associated), and Calamariaceae, including *Calamites* and *Archaeocalamites*.

II. SPHENOPHYLLALES.—The two very distinct genera *Sphenophyllum* and *Cheirostrobus*, included in this group, are known only from the Palaeozoic rocks. Though the high specialization of this ancient group of plants renders the determination of their natural affinities difficult, indications are afforded by anatomy and the morphology of the strobilus.

In general appearance the species of *Sphenophyllum* (the remains of *Cheirostrobus* known do not allow of any idea of its habit being formed) present some resemblances to the Equisetales. The long, sparingly branched stem bore at the somewhat swollen nodes whorls of six to eighteen wedge-shaped or linear leaves, which did not alternate in successive whorls. Both the broader and narrower leaves may be more or less deeply divided, and both forms may occur on the same shoot. From the relation of the thickness of the stem to its length it may be inferred that the shoots of *Sphenophyllum* derived support from adjoining plants. Without entering into detail regarding the anatomy, it may be stated that secondary thickening took place in both genera. The single stele in the stem consisted of the phloem surrounding a solid central strand of xylem, the groups of protoxylem being situated at the projecting angles. In *Sphenophyllum*, in which the transverse section of the xylem is triangular, there were three or six protoxylem groups; in *Cheirostrobus* they were more numerous. The anatomy of the stem is thus very unlike that characteristic of the Equisetales, and presents essential points of resemblance to the Lycopodiales and especially to the Psilotales. The general morphology of the cones, on the other hand, suggests some affinity with the Equisetales. The cone of *Sphenophyllum* consisted of an axis bearing at the nodes whorls of bracts, united below into a sheath. The overlapping bracts afforded protection to the sporangia, which were borne on sporangiophores springing from the upper surface of the coherent bracts near their origin from the axis; two sporangiophores usually arose from each bract, and sometimes adhered to its upper surface for some distance. Each bent round at the upper end, and bore one or two sporangia on the side turned towards the axis. The mature sporangium had a wall of a single layer of cells, which were larger towards the

base, where they continued into the epidermis of the sporangiophore. In *Sphenophyllum fertile* both the ventral lobes of the sporophyll (corresponding to the sporangiophores in other species) and the dorsal lobes, which in other species are sterile, were developed as peltate sporangiophores. In other species of *Sphenophyllum*, which are known only as impressions, single sporangia, or groups of four, appear to have been inserted directly on the upper surface of the bracts. In *Cheirostrobus* a similar relation of sporangiophores to bracts existed, but here each bract was divided into three segments. From each segment, near its base, a stalked peltate sporangiophore arose; this bore four sporangia, which hung parallel to the stalk. That these three sterile segments, with their sporangiophores, are together comparable to one of the bracts of *Sphenophyllum*, with its sporangiophores, is shown by the vascular supply in each case being derived from a single leaf-trace. So far as is at present known, the Sphenophyllales were homosporous. The differences between the two genera described above are sufficiently marked to justify the division of the Sphenophyllales into the two orders Sphenophyllaceae and Cheirostrobaseae. A consideration of the characters of both shows that the Psilotales are the nearest living representatives of the Sphenophyllales, while resemblances suggesting actual relationship exist between this group and the Equisetales and Lycopodiales. It has been suggested that the Sphenophyllales may have sprung from a very old stock which existed prior to the divergence of the latter groups. So long, however, as our knowledge of these phyla is confined, as at present, to specialized forms, the nature of the relationship between them must remain to some extent hypothetical.

III. PSILOTALES.—The two genera *Psilotum* and *Tmesipteris*, which are provisionally isolated in this group, have usually been classed with the Lycopodiales. Recent work both on their anatomy and on the morphology and structure of their spore-producing organs has however tended to show that their peculiarities can be best understood in the light of our knowledge of the Sphenophyllales. Some authorities place them in this group and there is much to be said in support of the close relationship implied. The Psilotaceae, however, differ from the Sphenophyllales in a number of definite features, such as the arrangement of the leaves singly and not in whorls, and the mode of branching. These differences and our comparatively imperfect knowledge of the Sphenophyllaceous plants which most closely resemble the Psilotaceae appear to justify the provisional isolation of the latter as a distinct group, showing affinities with both the Sphenophyllales and Lycopodiales. In both *Psilotum* and *Tmesipteris* the functions of the root-system, which is completely absent, are performed by leafless rhizomes bearing absorbent hairs and inhabited by an endophytic fungus. *Psilotum* lives epiphytically or in soil rich in humus, while *Tmesipteris* is epiphytic (and, it has been suggested, partially parasitic) upon stems of tree ferns: the former has small scale-like leaves; those of the latter are of considerable size. The stem is monostelic, the protoxylem groups being towards the periphery of the xylem, the development of which is thus centripetal; the centre of the stele is occupied by sclerenchymatous tissue. The leaves, which bear the sporangia, are dichotomous, and do not form definite cones, but alternate in irregular zones with the foliage leaves. The sporophylls may exceptionally undergo further dichotomies and bear more numerous syngangia. The sporangia of the Psilotaceae are associated in syngangia, which occupy the same position relatively to the sporophyll, as the single sporangium of *Lycopodium* or the group of sporangia in *Sphenophyllum majus*. The careful study of the development of the syngangium of *Tmesipteris*, which consists of two loculi, and of *Psilotum*, which consists of three, has shown that their structure can be explained as originating by the septation of a single sporangium resembling that of *Lycopodium*. Other views of the nature of the Psilotaceous syngangium are, however, possible, and indeed the existence of both simple and complicated sporangiophores in the Sphenophyllaceae leaves the question open as to whether the syngangium in existing Psilotaceae is a relatively simple type of sporangiophore which has persisted unaltered or is the result of reduction from a more elaborate structure. There is some reason to believe that the prothallus of *Psilotum* resembles some *Lycopodium* prothalli, but conclusive evidence is wanting; that of *Tmesipteris* is unknown.

IV. LYCOPODIALES.—The living representatives of this group are of small size compared with the related plants which lived in Palaeozoic times. A large proportion of the living species are

tropical, though others have a wide distribution. As general characteristics of the Lycopodiales, the simple form of the leaves, which are generally of small size, and the situation of the sporangia on the upper surface of the sporophylls, which are often associated in cones, close to their insertion on the axis, may be mentioned; there are both homosporous and heterosporous forms, the prothalli exhibiting corresponding differences. A number of species of *Lycopodium* are epiphytic and those of *Isoetes* live submerged in water. Vegetative reproduction is effected in various ways: by the separation of the branches of a creeping stem in some *Lycopodia*, the persistence through the winter of the apex of the shoot in *L. inundatum*, and by the formation of leafy bulbils on the aerial stem of *L. Selago* and others. A highly specialized means of vegetative reproduction is seen in the tubers of *Phylloglossum* and the embryos of some Lycopods. The modifications shown by the gametophyte of *Lycopodium* will be described below. All such special relations of the plant to its environment, which might be expected in the few forms of a large group which has persisted beyond the others, are less marked in the genus *Selaginella*. It would appear as if the latter was more suited to the conditions of the existing flora, and many of the specific forms within it may rather be regarded as recently evolved than as simply persistent.

Lycopodiaceae.—This order contains the two genera *Phylloglossum* and *Lycopodium*; the former has a single species, confined to Australia, Tasmania and New Zealand, while nearly one hundred species of *Lycopodium* are known. Erect and creeping terrestrial plants and

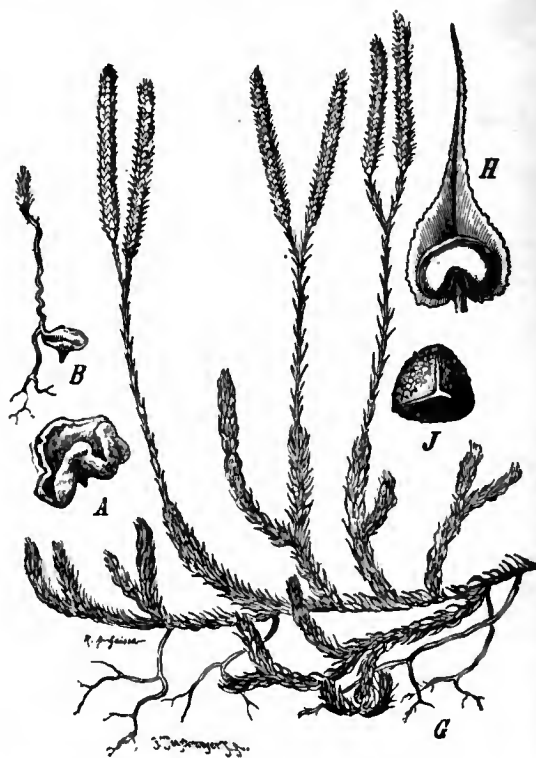

(From Strasburger's *Lehrbuch der Botanik*.)

FIG. 4.—*Lycopodium clavatum*.

- A, Old prothallus.
 B, Prothallus bearing young sporophyte.
 G, Portion of a mature plant showing the creeping habit, the adventitious roots and the specialized erect branches bearing the strobili or cones.
 H, Sporophyll bearing the single sporangium on its upper surface.
 J, Spore, highly magnified.

pendulous epiphytes occur in the latter genus. The simple leaves, which are of small size and do not possess a ligule, are arranged spirally around the branched stem in the majority of the species. The roots of the erect forms often grow downwards in the cortex of the stem to reach the soil. The anatomy of *Lycopodium* presents considerable variety in detail, but the stem is always monostelic and the development of the xylem centripetal, the protoxylems being situated at the periphery of the stele; pericycle and endodermis surround the stele, and the wide cortex may be more or less

acelerenchymatous. The central cylinder of the root often shows a striking resemblance to that of the stem. The Lycopodiaceae are homosporous. The spores are formed in sporangia of considerable size, situated on the upper surface and near the base of the sporophylls. The latter may differ from the foliage leaves and be arranged in definite cones, or the two may be similar and occupy alternate zones of a shoot with continued growth; sometimes rudiments of sporangia are found at the bases of the leaves (fig. 4). In the development of the sporangium the sporogenous tissue is derived from a number of superficial cells by divisions parallel to the surface. The tapetum is derived from the layer of cells surrounding the sporogenous group. Short trabeculae of sterile tissue have been found to project into the cavity of the sporangium of some species. The spores, when liberated by the dehiscence of the sporangium, give rise to the prothallus, which is now, owing mainly to the investigations of Treub and Bruchmann, known in a number of tropical and temperate species. In habit and mode of life of the prothallus these present striking differences, which may be correlated with the situations inhabited by the sporophyte, and are perhaps to be regarded as adaptations which have enabled the species to survive. Thus in *L. cernuum* and others the prothallus is green and grows on the surface of the soil (fig. 1, b); in the species living on the moors it is subterranean and saprophytic, though sometimes capable of developing chlorophyll when exposed to light (fig. 1, d); while in *L. Phlegmaria* and other epiphytic forms the prothallus consists of fine branches growing saprophytically in rotting wood (fig. 1, c). A comparison of these various types would appear to indicate that the primitive form of prothallus in the genus was radially symmetrical and contained chlorophyll. The prothalli of *L. cernuum* come nearest to this; in them the meristem forms a zone slightly below the summit, which may bear a number of green lobes. The different forms of the prothallus found in *L. Selago* give an idea of how the more extremely modified types could be derived from such a prothallus as that of *L. cernuum*. All the saprophytic prothalli contain an endophytic fungus in definite layers of their tissue. The antheridia and archegonia are produced above the meristematic zone, and are more or less sunk in the tissues of the prothallus. The most important difference in the sexual organs concerns the length of the archegonial neck; this is shortest and has only a single canal cell in *L. cernuum*, while in *L. complanatum* it is longer than in any other Vascular Cryptogam, and contains a number of canal cells. The spermatozooids are biciliate. The embryo in *L. cernuum* and other forms with superficial green prothalli is attached to the prothallus by a small foot, and develops at first as a tuberous body (the protocorm) bearing rhizoids; this forms a number of simple leaves, and upon it the apex of the shoot arises later. In the saprophytic forms the protocorm is absent, and in some of them the foot is of large size (fig. 4, B). When new individuals of species which possess a protocorm arise vegetatively from the leaves or roots of young plants, the protocorm appears in the young sporophyte. This fact leads to

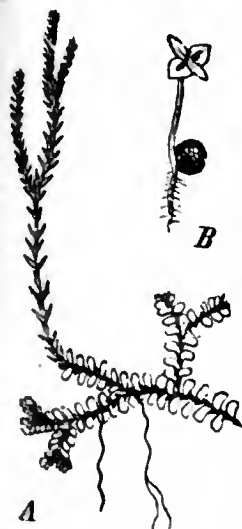

(From Strasburger's Lehrbuch der Botanik.)

FIG. 5.—*Selaginella*. A, *S. helvetica* (nat. size), groups arranged round the periphery, much as in *Lepidodendron*. The cells of the endodermis are developed as trabeculae, which traverse the continuous air-space surrounding each stele. The simple, uni-nerved leaves have a ligule near the base; the base of the ligule is somewhat sharply marked off from the other tissues of the leaf. In some species a depression of the leaf-surface encloses the ligule, regarding the function of which little is known. The roots, the stele of which is monarch, may arise directly from

the stem, or are borne on rhizophores, which spring from the shoot at the point of branching, and root on reaching the soil. In structure they resemble the roots, but their morphological nature is uncertain. The sporophylls are arranged radially in the cones, which are terminal on the branches. A single sporangium is borne on the axis just above the insertion of each sporophyll. *Selaginella* is heterosporous, the megasporangia being often found towards the base of the cone. The development of the micro- and megasporangia is the same up to the stage of isolation of the spore mother-cells. The sporogenous tissue, which is referable to several archesporial cells, is surrounded by a tapetum, mostly derived from the sporogenous group. In the microsporangium all the mother-cells undergo the tetrad division, giving rise to the numerous microspores. In the megasporangium, on the other hand, the four megaspores, which arise from a single mother-cell, are nourished at the expense of the other sporogenous cells and of the tapetum. On germination the microspores give rise to a reduced prothallus, consisting of the small cell first cut off and a wall of cells enclosing two to four central ones; from these latter the biciliate spermatozooids originate. The megaspore becomes filled with the female prothallus, the formation of cell-walls commencing at the pointed end of the spore, where from the first the nuclei are more numerous, and later extending to the base. The surface of the prothallus, which is exposed when the thick wall of the spore is ruptured, may produce a few rhizoids; upon it the archegonia, consisting of a short neck and the central series of ovum, ventral canal cell and canal neck, arise (fig. 1, e). After fertilization the embryo forms a short suspensor; the apex of the stem, with a leaf on each side of it, is first distinguishable; at the base of this is the foot; while the root arises on the farther side of the latter. Thus the position of the root in *Selaginella* is different from what obtains in the other Vascular Cryptogams. A point of interest in this heterosporous genus is that the formation of the prothallus may commence before the megaspore is liberated from the sporangium.

Lepidodendraceae.—This order includes only extinct forms, the best known of which are the plants placed in the genera *Lepidodendron* and *Sigillaria*. These plants, a fuller description of which must be sought in the article PALAEOBOTANY: Palaeozoic, underwent secondary increase in thickness and attained the size of large trees; the aerial stem was more or less branched dichotomously. The leaves, which were of simple form and provided with a ligule, were, as the leaf-scars on the stem show, variously arranged. In *Sigillaria* the latter form vertical rows, while in *Lepidodendron* the arrangement is a complicated spiral. The stem had a single stele, the primary xylem of which was polyarch and centripetally developed. The upright stems were attached to the soil by a number of dichotomously branched members (*Stigmaria*), which, whatever their morphological nature may be, appear to have performed the function of roots: they bore numerous cylindrical appendages, which penetrated the soil on all sides. The cones, which in some instances at least were heterosporous, presented a general resemblance to those of *Lycopodium* and *Selaginella*, a single sporangium being situated on the upper surface of each sporophyll. The cavities of the large sporangia were sometimes traversed by trabeculae of sterile tissue resembling those found in *Isoetes*. In some of the heterosporous forms (*Lepidocarpon*, *Miadesmia*) the sporangia were sometimes surrounded by an integument; and since only a single megaspore attained maturity, the structure of the megasporangium suggests a comparison with an ovule.

Isoëtaceae.—The single genus (*Isoetes*) contains about fifty, mostly aquatic, species, though a few are amphibious or terrestrial. The plants present considerable uniformity in general habit, consisting of a short, unbranched stem, bearing the closely-crowded awl-shaped leaves, which in the larger species attain the length of a foot. Each leaf bears a ligule resembling that of *Selaginella* in structure and position. The stem is monostelic, the centre of the stele being occupied by a mass of short tracheides; but little can be said as to the primary structure of the central cylinder, which appears to be reduced. A meristematic zone forms a short distance outside the xylem, from which secondary tissue is developed both internally and externally; that to the inside contains both xylem and phloem elements. By the unequal development of the secondary cortex the stem becomes two- or three-lobed; the roots, which branch dichotomously, spring from the furrows between the lobes. The leaves have a single main bundle, and in the mesophyll are four longitudinal series of large intercellular spaces separated by transverse diaphragms. The sporangia, which are situated singly on the adaxial surface of the leaves, between their insertion on the stem and the ligule, arise from a considerable number of epidermal cells. The cells composing the young sporangium are at first similar, but ultimately become differentiated into sterile trabeculae, which may stretch from the inner to the outer wall, and the mother-cells of the spores. The latter are more numerous in the microsporangium than in the megasporangium. The tapetal layer is partly formed from the sporangial wall and partly as a layer covering the trabeculae. The spores, which are set free by the rotting of the sporangial wall, germinate much as in the case of *Selaginella*, though the similarity may be a case of independent resemblance. Important points of difference are found in the multiciliate spermatozooids, and in the embryo, which has no suspensor.

The several orders of Lycopodiales described above, while presenting a number of features in common, are distinctly isolated from one another. A natural classification of such specialized plants can only be obtained when the extinct forms are more fully known. What is known at present, while it does not indicate the phylogeny of the Lycopodiales, at least shows that such living orders as Lycopodiaceae and Selaginellaceae cannot be regarded as forming a linear series. The difficulty is increased when it is borne in mind that the small surviving forms probably have a long geological history, and may have coexisted with the Lepidodendraceae. For these reasons no attempt has been made to arrange the orders in larger divisions, since such a division as that of the ligulate and eligulate forms, while convenient for practical purposes, may not express the phylogeny of the group. The Psilotaceae, formerly included in the Lycopodiales, have been described separately owing to their resemblance to the Sphenophyllales. It remains to be mentioned that the Isoëtaceae have been regarded as more nearly allied to the Filicales than to the former, near which they are here placed.

V. OPHIOGLOSSALES.—The peculiarities of this small order of Pteridophyta render their systematic position a matter of doubt, especially in the absence of evidence as to their geological history, and justify their separation for the present from the other main natural groups. In the three genera, *Ophioglossum*, *Botrychium* and *Helminthostachys*, there is an underground rhizome, from which one leaf or a few leaves with sheathing bases are produced annually; the roots arise in more or less definite relation to the insertion of the leaves. The latter are simple, or irregularly lobed in *Ophioglossum*, more or less compoundly pinnate in *Botrychium* and palmately pinnate in *Helminthostachys*. The fertile branch or branches are situated on the adaxial surface of the leaves, and may be simple, as in *Ophioglossum* (fig. 2, d), or more or less compound, the degree of branching in the sterile and fertile segments exhibiting a general parallelism. The stem is monostelic, the arrangement of the xylem and phloem being collateral. The endodermis and pericycle surround the whole stele in *Botrychium* and *Helminthostachys*; in *Ophioglossum* each bundle has a separate sheath. Well-marked secondary thickening occurs in *Botrychium*. In the roots of *Ophioglossum* and *Botrychium* and in the first formed roots of *Helminthostachys* an endophytic fungus is present, forming a mycorrhiza—the stele in the larger roots has the usual radial arrangement of xylem and phloem; monarch roots occur in *Ophioglossum*. The morphology of the fertile spike is a disputed question, upon the answer to which the systematic position of the Ophioglossaceae largely rests. The spike is most simple in *Ophioglossum*, where it bears on each side a row of large sporangia, which hardly project from the surface, the vascular bundles occupying a central position. In the young spike, which arises when the leaf is still very small, a band of tissue derived from superficial cells is distinguishable along either side; this sporangiogenic band gives rise to the sporogenous groups, the sterile septa between them, and the outer walls of the sporangia. The spike of *Helminthostachys* corresponds to that of *Ophioglossum*, but in it the sporangia are borne on two lateral rows of branched sporangiophores. The sporangia themselves resemble those of *Botrychium*, which project from the ultimate subdivisions of the branched spike; each is developed from a number of cells, the sporogenous tissue arising from a single cell. Two diverse views of the morphology of the fertile spike in these plants have been entertained. The older view was that it was a fertile segment of the leaf; and though its ventral position presents a difficulty, this must be regarded as a possible explanation; the occasional occurrence of sporangia on the lamina in *Botrychium* has been regarded as supporting it. On the other hand, the spike has been explained as due to the elaboration of a single sporangium occupying a similar position with regard to the leaf as in the Lycopodiales, and evidence of considerable weight has been brought forward in support of this interpretation. The important bearing of this question on the relationship of the

Ophioglossaceae to the phyla of the Filicales and Lycopodiales will be obvious.

The position of the fertile spike in relation to the leaf corresponds to that of the synangium or sporangiophores in the Psilotales and Sphenophyllales. The Ophioglossaceae are homosporous, and the prothalli, which are known in species of all three genera, are subterranean and saprophytic (fig. 1, f, g). The prothallus of *O. pedunculatum*, as observed by Mettenius, subsequently reached the surface and produced green lobes; those of the other species known are wholly saprophytic, and contain an endophytic fungus. Those of *Ophioglossum* are cylindrical, while the dorsiventral prothallus of *Botrychium* bears the sexual organs on the upper surface. They present a general, but probably homoplastic, resemblance to the saprophytic prothalli of certain *Lycopodia*. Important points of difference exist, however, in the apical position of the meristem of the Ophioglossaceae prothalli, in the presence of a basal cell to the archegonium, and in the multiciliate spermatozooids. In these respects, in the megaphyllous habit and in certain anatomical features, the Ophioglossaceae approach the Filicales. Some species of *Botrychium* have recently been found to have embryos provided with a suspensor. The position of the Ophioglossaceae can at present only be regarded as an open question, in considering which the possible antiquity of the group must be borne in mind.

VI. FILICALES.—This group of Pteridophyta differs from the others in being well represented in our present flora by forms, many of which can be regarded not as archaic types which have persisted to the present day, but as having been evolved in comparatively recent periods. The Ferns exhibit a wide range in size from the minute epiphytic Hymenophyllaceae, with leaves barely a centimetre in length, to gigantic tree-ferns 80 ft. or more in height. A general characteristic of their habit is the large size of the leaves, which are often highly compound, relatively to the stem. Some ferns have a longer or shorter erect stem often clothed by the persistent bases of the leaves; in others the stem creeps on the surface of the substratum or is subterranean. Its surface is clothed with filamentous or scaly hairs (paleae), which protect the growing point; and adventitious roots spring from it. The position of the branches varies in the group; they are only exceptionally axillary (Hymenophyllaceae, Botryopteridae). The anatomy of the stele in the stem exhibits on the whole a progression from a solid protostele through a tubular solenostele to one or more circles of separate steles derived by the breaking up of the solenostele. The leaf-traces usually interrupt the continuity of the stele of the axis on their departure. The sporangia are borne in groups (sori) on the under surface of the leaves; sometimes the fertile leaves differ more or less from the purely vegetative ones. The form of the sorus and the structure of the sporangium are of great systematic importance. The sorus is frequently protected by an outgrowth from the surface or margin of the leaf called the indusium. Heterospory is only known in the Hydropteridae. The prothallus developed from the spore is green and in most cases dorsiventral, bearing the archegonia and antheridia on the under surface.

Some of the more striking adaptive modifications in the gametophyte and sporophyte, and certain effects of altered external conditions which have been ascertained experimentally, may be briefly mentioned. The dorsiventrality of the prothallus has been shown to depend mainly on the illumination, the filamentous form being retained in feeble light; a similar result is obtained when the prothalli are cultivated in water. These facts may have a bearing on the filamentous prothalli of some Hymenophyllaceae. The reproduction of the prothallus by gemmae in species of *Trichomanes*, *Vittaria* and *Monogramme* is another interesting adaptation; the prothallus of *Gymnogramme*



(From Strasburger's *Lehrbuch der Botanik*.)
FIG. 6.—*Scolopendrium vulgare*. ($\frac{1}{2}$ nat. size.)

leptophylla is perennial, the sporophyte being annually borne on it. The phenomena of apogamy and apospory which have now been observed in a number of Ferns, may be mentioned here. In the former the prothallus produces one or more fern-plants vegetatively, the projection which develops into the sporophyte in many cases occupying the position of an archegonium. In some apogamous Ferns sporangia may occur on the prothallus and the vegetative organs of the sporophyte may also occur singly. In apospory the converse phenomenon is seen, the gametophyte springing vegetatively from the sporangium, receptacle of the sorus, or leaf-margin of the fern-plant. In a number of cases, though not in all, apospory appears to be correlated with a failure of the sporangia to develop.

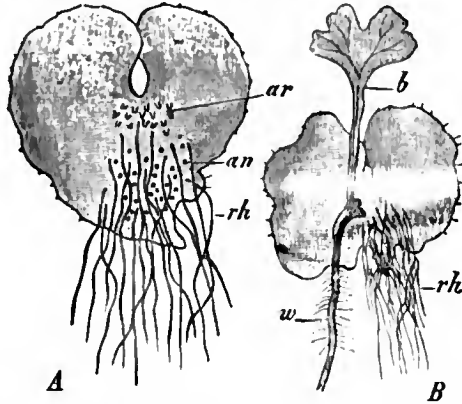

(From Strasburger's *Lehrbuch der Botanik*.)

FIG. 7.—*Nephrodium filix-mas*.

A, Prothallus viewed from the lower surface; ar, archegonia; an, antheridia; rh, rhizoids (much enlarged). B, Prothallus bearing a young fern plant; b, first leaf; w, primary root. (X 8.)

The adaptations in the vegetative organs of the sporophyte are similar to those in the Flowering Plants. Thus there are a few

Ferns which climb, others are water plants, while many, especially those which live as epiphytes, are more or less xerophytic. Some of the epiphytic forms (*Polypodium quercifolium*, *Platycrium*) have strongly dimorphic leaves, the sterile leaves serving in some cases to catch falling debris, and thus to provide the plant with soil. Lastly, the symbiotic relation between the plant and ants is found in Ferns, the rhizome of *Polypodium carnosum* containing cavities inhabited by these insects. The existence of these myrmecophilous Ferns suggests a possible explanation of the nectaries on the leaves of some other species, such as the Common Bracken.

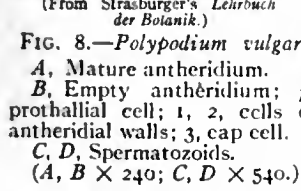

(From Strasburger's *Lehrbuch der Botanik*.)

FIG. 8.—*Polypodium vulgare*. A, Mature antheridium. B, Empty antheridium; p, prothallial cell; 1, 2, cells of antheridial walls; 3, cap cell. C, D, Spermatozoids. (A, B X 240; C, D X 540.)

The main existing groups of the Filicaceae may now be briefly described, with special reference to the characters of gametophyte and sporophyte, which have been found of value in determining affinities.

Marattiaceae.—These are ferns of considerable size, the large leaves of which are borne on a short, erect, swollen stem (*Angiopteris*, *Marattia*), or arise from a more or less horizontal rhizome (*Danaea*, *Kaulfussia*). The leaves, at the base of which are two large stipule-like outgrowths, have a thick leaf-stalk, and are simple or simply pinnate in *Danaea*, pinnate in *Archangiopteris* bi- to tri-pinnate in *Marattia* and *Angiopteris*, and digitately lobed in *Kaulfussia*. The stem, from the ground tissue of which sclerenchyma is absent, has a complicated system of steles arranged in concentric circles; the thick roots, the central cylinders of which have several alternating groups of xylem and phloem, arise in relation to these. The pinnae, except in a few filmy forms, are thick; in *Kaulfussia* large

pores derived from stomata occur in the epidermis. The sori are borne on the under surface of the pinnae, usually in a single row on either side of the midrib, but in *Kaulfussia* dotted over the expanded lamina. The large sporangia, each of which originates from a number of superficial cells, are here incompletely separated from one another and arranged in a single circle forming a synangium. The

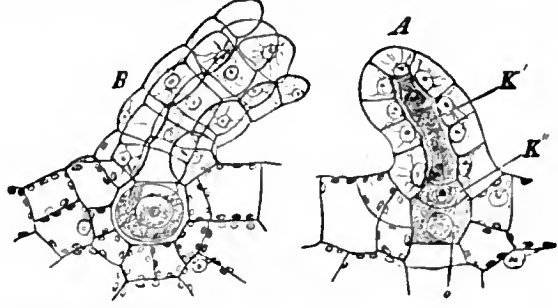

(From Strasburger's *Lehrbuch der Botanik*.)

FIG. 9.—*Polypodium vulgare*.

A, Unopened archegonium; o, ovum; k', ventral canal cell; k'', neck-canal-cell. B, Mature opened archegonium. (X 240.)

association is closest in *Danaea*, where the individual sporangia of the elongated sorus, which is sunk in a depression of the leaf, open by pores; in *Marattia* and *Kaulfussia* (fig. 2, e) they dehisce by slits on the inner face; while in *Angiopteris* (fig. 2, f) they are almost free from one another. The spores produce a green prothallus of large size, the sexual organs of which hardly project from the surface. The cotyledon and stem grow up vertically through the prothallus, the root turning downwards into the soil.

Osmundaceae.—The two genera of this group, *Osmunda* and *Todea*, have thick erect stems, covered with the closely crowded leaf bases. The stem is monostelic, the vascular tissues being separated into curved groups comparable with collateral vascular bundles, which surround the pith. The somewhat thick roots are diarch. The leaves are large and pinnate; their lamina is usually thick, though filmy species of *Todea* occur. The leaf-base shows indications of stipular outgrowths. In *Todea* the sori, each of which consists of a single circle of bulky sporangia, are borne on the under surface of the pinnae. In *Osmunda* the region of the leaf which bears the sporangia has its lamina little developed; the leaf thus bears sterile and fertile pinnae, or, as in *O. cinnamomea*, sterile and fertile leaves may be present. The sporangia originate from single cells, though surrounding cells may contribute to the formation of the stalk. The latter is thick and short, and the wall of the sporangium, which opens by a median slit, has a group of thick-walled cells at the summit, forming the annulus. The prothalli are similar to those of the other Filicaceae, but more massive; the same may be said of the archegonia and antheridia, which, however, project more than in the preceding group.

Schizaeaceae.—The anatomy of the stem differs in the four recent genera of this order, and presents a series possibly illustrating the origin of a number of concentric steles from a solid stele, the intermediate step being represented by those forms in which the central cylinder is tubular. The sporangia are borne singly or in sori of two or three on the margin or under surface of leaves, the fertile pinnae of which differ more or less from the sterile segments. The sporangium is of considerable size, and dehisces by a median slit, the annulus being a more or less definitely limited horizontal ring of cells near the apex. The prothallus and sexual organs may resemble those of the Polypodiaceae; in *Aneimia* and *Mohria* the prothallus, though flattened, is not bilaterally symmetrical, the growing point being on one side; a filamentous type of prothallus is known in *Schizaea*.

Gleicheniaceae.—These forms have a horizontal rhizome, from which simply pinnate leaves arise in *Platyzoma*, while *Gleichenia* bears compound pinnate leaves with continued apical growth. The rhizome usually has a solid central cylinder in *Gleichenia*, while that of *Platyzoma* is tubular. The sporangia arise simultaneously in the sorus, which is borne on the under surface of the ordinary pinna; in those species with large sporangia the latter form a single circle, in others sporangia may also arise from the central part of the receptacle. The annulus is horizontal and the dehiscence median. The prothalli, while resembling those of the Polypodiaceae, have points of similarity with those of the preceding groups.

Matoniaceae.—This contains the single genus *Matonia*, two species of which are known from the eastern tropics. They are of special interest, since they have been shown to be the surviving forms of a group species which have been identified from Jurassic and Cretaceous rocks. The living species have a long rhizome, from the upper surface of which the large leaves arise; these are branched in a pedate manner, each branch being pinnate. The structure of the rhizome is complicated, a transverse section showing that the centre may be occupied by a solid stele, outside of which are two tubular steles. The sori are borne on the under surface of the pinnae,

each consisting of a single series of large sporangia covered by a coriaceous indusium, which is attached to the central part of the receptacle. The sporangium, which corresponds on the whole to that of the Gleicheniaceae, has a somewhat oblique annulus; the dehiscence also is not truly median. The gametophyte is unknown.

Loxomataceae.—The single genus *Loxosoma* has a tubular stele in its rhizome, which bears leaves resembling those of some *Davallias*. The elongated receptacle of the marginal sori is surrounded by a basal cup-shaped indusium. The sporangia, which arise in basipetal succession on the receptacle, dehisce by a median slit, though the annulus is somewhat oblique; they have resemblances to the Gleicheniaceae. When mature, the sporangia are raised above the margin of the indusium by the elongation of the receptacle, thus facilitating the dispersion of the spores. The gametophyte is unknown.

Hymenophyllaceae.—This group, which contains the two genera *Hymenophyllum* and *Trichomanes*, is characterized by the prevalent "filmy" texture of the leaves. Many of the species inhabit situations in which the air is constantly moist, especially in the tropics; some are terrestrial; others, some of which are very minute, are epiphytic on tree-stems. A single solid central cylinder is found in the rhizome. The sori, which are marginal, have a long receptacle, bearing the sporangia in basipetal succession, and are surrounded by a cup-shaped indusium. The sporangia present a considerable range in size, the largest being found in species of *Hymenophyllum*, the smallest in *Trichomanes*. Each has an almost horizontal annulus resembling that of *Gleichenia*, but the dehiscence is lateral. The gametophyte in *Hymenophyllum* is flat and variously lobed; that of *Trichomanes* may be similar, but in other species is filamentous. The archegonia and antheridia present points of similarity to those of the Gleicheniaceae.

Cyatheaceae.—This order includes the majority of existing tree-ferns, as well as some of smaller size. The stem has a ring of flattened steles. The sorus has a somewhat elongated receptacle, on which the sporangia arise basipetally; the indusium may be cup-shaped, bivalve or wanting. The dehiscence of the sporangium is almost transverse, as in the Polypodiaceae, but the annulus is slightly oblique. The prothalli correspond to those of the next group.

Polypodiaceae.—This group, which contains the remaining ferns, includes a number of distinct lines of descent and will doubtless require subdivision as our knowledge of the morphology of the genera classed in it becomes extended. Space will not allow of an account of the progress already made in this direction. The stem in the more primitive forms has a tubular stele (solenostele); for the most part two to many steles, arranged in a ring (dictyostele). In a number of genera, which there is reason to regard as relatively primitive, the sporangia show the same regular basipetal succession as in some of the preceding groups; in the great majority, however, the succession is not regular, but those of various ages are intermixed in the sorus (fig. 2, g). The sporangia dehisce by a transverse slit, the annulus being truly vertical or, in some of the genera in which they are regularly arranged, very slightly oblique. The structure of the prothallus and sexual organs will be evident from figs. 7, 8 and 9; some of the more interesting modifications have been referred to above.

Our knowledge of the extinct Filicales cannot be readily summarized, since it is in a transition state, owing to the recent evidence which has shown that many of the fern-like plants of the Palaeozoic period belonged to a group of seed-bearing plants derived from a filicineous ancestry. There is, however, abundant evidence that the Ferns were represented in the most ancient floras known, though they were not such a dominant group as has hitherto been supposed. The best known of these ancient Ferns belong to the Botryopterideae; the characters of this group point to its having been the starting-point of several series of existing Ferns (see PALAEOBOTANY: *Palaeozoic*).

A consideration of the Filicales as arranged above will show that the several sub-orders may in general terms be said to form a series between those in which the sorus consists of a single circle of bulky sporangia and those Polypodiaceae in which the numerous small sporangia appear to be grouped without order in the sorus. When the survey is extended to the extinct Ferns of which the fructification is known, many of those from the more ancient rocks are found to group themselves with the existing sub-orders with large sporangia, such as the Marattiaceae, Gleicheniaceae and Schizaeaceae; the Polypodiaceae, on the other hand, do not appear until much later. The extinct forms cannot be dealt with in detail here; but it may be pointed out that their order of appearance affords a certain amount of direct evidence that the existing Ferns with a single circle of large sporangia in the sorus are relatively primitive. The series which can be constructed from a study of the sorus is in general supported by the anatomy of the sporophyte, and by the

structure and sexual organs of the gametophyte. A more detailed investigation of all the characters of the Ferns will be needed before the course of evolution thus broadly indicated can be traced, but the results obtained afford a deeper insight into the general method of progression and the selective factors in the process. On the ground mainly of an examination of the sorus and sporangium, Bower has shown that the Filicales may be divided into three groups—the *Simplices*, *Gradatae* and *Mixtae*—in which the sporangia arise simultaneously, in basipetal succession, or irregularly in the sorus respectively. The first includes the Marattiaceae, Osmundaceae, Schizaeaceae, Gleicheniaceae and Matoniaceae; the second the Loxomataceae, Hymenophyllaceae, Cyatheaceae and the Dennstaedtiaceae (a group including species placed in the *Synopsis Filicum* in *Dicksonia* and *Davallia*); while the remaining Polypodiaceae constitute the *Mixtae*. The change from the one type of sorus to the other may have taken place in several different lines of descent, some of which have been traced. A consideration of the biology of the sorus gives an insight into the advantages obtained by the one type over the preceding, as regards protection, spore production and the dispersal of the spores, and thus indicates the way in which natural selection may have acted. The differences in the form and mode of dehiscence of the sporangia (those of the *Simplices* having median dehiscence and a horizontal annulus, those of the *Gradatae* a more or less oblique position of the annulus and of the plane of dehiscence, while in the *Mixtae* the annulus is vertical and the dehiscence transverse) stand in relation to the position of the sporangia in the sorus relatively to one another. The application of the important criteria which Bower has thus pointed out to the construction of a strictly phylogenetic classification of the Filicales cannot be made until the anatomy, the sexual generation and the palaeobotanical evidence have been further examined from this point of view. Though on this account and because the subdivisions *Simplices*, *Gradatae* and *Mixtae* do not correspond to definite phylogenetic groups, they have not been used in classifying the Ferns above; they are of great importance as an advance towards a natural classification.

HYDROPTERIDEAE.—Two very distinct orders of heterosporous Filicales, the Salviniaceae and the Marsiliaceae, are included in this group. The difficulty of determining their exact relationship to the other orders of Ferns is increased by the more or less completely aquatic habit of the plants and the modifications and reductions in structure associated with this. The absence of an annulus from their indehiscent sporangia makes it impossible to compare them with the other Ferns in respect of this important character. It has been suggested with considerable probability that the Marsiliaceae are allied to the Schizaeaceae, while the Salviniaceae may possibly be related to the Hymenophyllaceae or to some other family of the *Gradatae*. Space will only permit of a brief general account of the more obvious features of the several genera, the structure and life-history of which are known in great detail. Unlike as they are in many respects, the two orders agree in being heterosporous. The microspores on germination produce a small, greatly reduced male prothallus bearing one or two antheridia which give rise to a number of spirally coiled, multiciliate spermatozooids. The single large megaspore contained in each megasporangium produces a small prothallus, which bears one or a few archegonia; these are exposed on the surface of the prothallus at the summit of the germinated megaspore (fig. 1, i).

1. The Salviniaceae include the two genera *Salvinia* (fig. 10) and *Azolla*. The small dorsiventral plants are in both cases floating aquatics. *Azolla* has roots depending from the lower surface of the stem into the water, while these organs are completely wanting in *Salvinia*, their place being taken functionally by highly divided leaves borne on the ventral surface of the stem. *Nostoc* colonies are constantly present in a special cavity of the dorsal lobe of the leaf in *Azolla*. The sporangia in both genera are associated in sori enclosed by indusia springing from the base of the receptacle. In *Salvinia* (fig. 2, h) the sori are borne towards the base of the submerged leaves, in *Azolla* on the reduced ventral lobe of the leaf. They consist either of microsporangia or megasporangia, which are arranged in basipetal succession on the receptacle. In the megasorus of *Azolla*

there is only the one terminal, functional sporangium. The microspores are united by means of hardened protoplasm into one or more masses, while the solitary megaspores have a more or less complicated episporium.



(Reduced. After Bischoff from Strasburger's *Lehrbuch der Botanik*.)

FIG. 10.—*Salvinia natans*.

A, From the side. B, From above.

2. The Marsiliaceae also include two genera, *Marsilia* and *Pilularia*, the latter of which is found in Britain. The plants grow as a rule in marshy places, though some species of *Marsilia* are xerophytic. The creeping stem produces roots from the ventral surface and leaves from the dorsal surface; the leaves when young are circinately coiled. The leaves are simple and linear in *Pilularia*, but in *Marsilia* bear a pinnate four-lobed lamina. The highly specialized sporocarps are borne on the basal portions of the leaves, as a rule singly, but in some species of *Marsilia* in numbers. The development of the sporocarp shows that it corresponds to a pinna, although when mature it may appear to occupy a ventral position in relation to the vegetative portion of the leaf. It has a complicated structure in both genera; in *Pilularia* its shape is nearly spherical, while in *Marsilia* it is elongated and bean-shaped. The sori are developed in depressions and are thus protected within the resistant outer wall of the sporocarp. There are usually four sori in *Pilularia*, while in *Marsilia* they form two longitudinal rows. Each sorus includes both microsporangia, with numerous spores, and megasporangia, each of which contains a single megaspore with a complicated wall. Enclosed within the sporocarp they can endure a period of drought, but on the return of moist conditions are extruded from the sporocarp by the swelling of a special mucilaginous tissue and the spores become free. The development of the prothallus is in general similar to that of the Salviniaceae, though the resemblance may be homoplastic. The stem in the less reduced forms is solenostelic with sclerenchymatous ground tissue occupying the centre of the stele.

In the absence of direct evidence from Palaeobotany, and bearing in mind the modifications associated with adaptation to an aquatic life in other plants, the recognition of any more definite affinity for these heterosporous ferns than that indicated above appears to be inadvisable. Further evidence is necessary before they can be removed from such a position of convenience as is assigned to them here and placed in proper relation to the series of the Filicaceae.

The several phyla of Pteridophyta having now been briefly described, their relationship to one another remains for consideration. The available evidence does not suffice to solve this question, although certain indications exist. In the earliest land vegetations of which we have any sufficient record specialized forms of Equisetales, Lycopodiales, Sphenophyllales and Filicales existed, so that we are reduced to hypotheses founded on the careful comparison of the recent and extinct members of these groups. In this connexion it may be pointed out that the fuller study of the extinct forms has as yet been of most use in emphasizing the difficulty of the questions at issue. It has thus led to a condition of uncertainty as regards the relationship of the great groups of Vascular Cryptogams, in which, however, lies the hope of an ultimate approach to a satisfactory solution. The study of the Sphenophyllales, however, as has been pointed out above, appears to indicate that the Equisetales and Lycopodiales may be traced back to a common ancestry. As to the relationship of the Filicales to the other phyla, evidence from extinct plants appears to be wanting.

If, as has been suggested by Bower, the strobiloid types are relatively primitive, the large-leaved Pteridophyta must be supposed to have arisen early from such forms. The question cannot be discussed fully here, but enough has been said above to show that in the light of our present knowledge the main phyla of the Vascular Cryptogams cannot be placed in any serial relationship to one another.

It may even be regarded as an open question whether some of them may not have arisen independently and represent parallel lines of evolution from Bryophytic or Algal forms. This leads us to consider the question whether any indications exist as to the manner in which the Pteridophyta arose. It will be evident that no direct record of this evolution can be expected, and recourse must be had to hypotheses founded on the indirect evidence available. There appears to be no reason to doubt that the sexual generation is homologous with the thallus of a Liverwort, or of such an Alga as *Coleochaete*. It is with regard to the origin of the spore-bearing generation of the Pteridophyta that differences of opinion exist. This, though at first dependent on the prothallus, soon becomes independent. It may be regarded as derived from a wholly dependent sporogonium not unlike that of some of the simpler Bryophyta; the latter are assumed to have arisen from primitive Algal forms, in which, as the first step in the interpolation of the second generation in the life cycle, the fertilized ovum gave rise to a group of swarm spores, each of which developed into a new sexual plant. On this view the origin of the sporophyte is looked for in the gradual development of sterile tissue in the generation arising from the fertilized ovum, and a consequent postponement of spore-formation. Certain green Algae (e.g. *Oedogonium*, *Coleochaete*), the Bryophyta, and the simpler Pteridophyta, such as *Phylloglossum*, have been regarded as illustrating the method of progression, though there is no reason to regard the existing forms as constituting an actual series. For a discussion of this view, which regards the alternation of generations in Pteridophytes as antithetic and the two generations as not homologous with one another, reference may be made to the works of Celakovsky and Bower. Although the antithetic theory is supported by many facts regarding the life-history and structure of the group of plants under consideration, it is quite possible that a stage in which the sporophyte was wholly dependent on the gametophyte may never have been passed through in their evolution. The spore-bearing generation may throughout its phylogenetic history have been independent at one part of its life, and have been derived by modification of individuals homologous with those of the sexual generation, and not by the progressive sterilization of a structure the whole of which was originally devoted to asexual reproduction. A number of facts regarding the Algae, and also those relating to such deviations from the normal life cycle as apogamy or apospory, may be regarded as lending support to this view, which, in contrast to the theory of antithetic alternation, has been called that of homologous alternation. Without entering further into the discussion of these alternative theories, for which the literature of the subject must be consulted, it may be pointed out that on the latter view the strobiloid forms of Pteridophyta would not necessarily be regarded as primitive relatively to the large-leaved forms, and also that the early stages of the origin of the sporophyte in the two cases may have proceeded on different lines.

Another question of great interest, which can only be touched upon here and may fitly close the consideration of this division of the Vegetable Kingdom, concerns the evidence as to the derivation of higher groups from the Pteridophyta. The most important positive evidence on this point indicates that the most ancient Gymnosperms were derived from the Filicales rather than from any other phylum of the Vascular Cryptogams. Extinct forms are known intermediate between the Ferns and the Cycads, and a number of these have been shown to bear seeds and must be classed as Pteridospermae. These forms will, however, be found discussed in the articles treating of extinct plants and the Gymnosperms, but their recognition will serve

to emphasize, in conclusion, the important position the Pteridophyta hold with regard to the existing flora.

Cultivation.—Numerous species of ferns, both temperate and tropical, are cultivated as valued ornamental plants. Species of the other groups are occasionally grown for scientific purposes in the larger botanic gardens, but their cultivation, which often presents special difficulties, need not be referred to here. While a number of ferns can be multiplied vegetatively, by buds formed on the leaves and in other ways, the regular mode of propagation is by sowing the spores shed from the ripe sporangia. The spores should be thinly sprinkled on the surface of the soil in well-drained pots, which should stand in saucers filled with water and be covered with glass plates. After the prothalli have attained some size and bear sexual organs the pots should be occasionally sunk in water so as to flood the prothalli for a few minutes and facilitate fertilization. The young plants developed on the prothalli should be carefully pricked out into other pans and later transferred to 3-in. pots. When the pots are fairly filled with roots the plants may be shifted into larger ones.

The best time for a general repotting of ferns is in spring, just before growth commences. Those with creeping rhizomes can be propagated by dividing these into well-rooted portions, and, if a number of crowns is formed, they can be divided at that season. In most cases this can be performed with little risk, but the *Gleichenias*, for example, must only be cut into large portions, as small divisions of the rhizomes are almost certain to die; in such cases, however, the points of the rhizomes can be led over and layered into small pots, several in succession, and allowed to remain unsevered from the parent plant until they become well rooted. In potting the well-established plants, and all those of considerable size, the soil should be used in a rough turfy state, not sifted but broken, and one-sixth of broken crocks or charcoal and as much sand as will insure free percolation should be mixed with it.

The stove ferns require a day temperature of 65° to 75°, but do not thrive in an excessively high or close dry atmosphere. They require only such shade as will shut out the direct rays of the sun, and, though abundant moisture must be supplied, the atmosphere should not be loaded with it. The water used should always be at or near the temperature of the house in which the plants are growing. Some ferns, as the different kinds of *Gymnogrammae* and *Cheilanthes*, prefer a drier atmosphere than others, and the former do not well bear a lower winter temperature than about 60° by night. Most other stove ferns, if dormant, will bear a temperature as low as 55° by night and 60° by day from November to February. About the end of the latter month the whole collection should be turned out of the pots and retrained or repotted into larger pots as required. This should take place before growth has commenced. Towards the end of March the night temperature may be raised to 60°, and the day temperature to 70° or 75°, the plants being shaded in bright weather. Such ferns as *Gymnogrammas*, which have their surface covered with golden or silver powder, and certain species of scaly-surfaced *Cheilanthes* and *Nothochlaena*, as they cannot bear to have their fronds wetted, should never be syringed; but most other ferns may have a moderate sprinkling occasionally (not necessarily daily) and as the season advances sufficient air and light must be admitted.

AUTHORITIES.—Scott, *Structural Botany: Flowerless Plants* (London, 1896); *Studies in Fossil Botany* (Edinburgh, 1900);* Campbell, *Mosses and Ferns* (London, 1895);* Engler and Prantl, *Die natürlichen Pflanzenfamilien* (Theil i. Abth. 4.; Leipzig, 1898–1902); Bower, *The Origin of a Land Flora* (London, 1908); Goebel, *Organography of Plants* (Oxford, 1905); Hooker and Baker, *Synopsis Filicum* (London, 1874); Baker, *Fern Allies* (London, 1887); Christ, *Die Rankräuter der Erde* (Jena, 1897); Seward, *Fossil Botany*, vol. i. (Cambridge, 1898). In those works marked with an asterisk copious references to the recent literature of the subject will be found.

(W. H. L.)

PTEROBRANCHIA, a zoological group established by Ray Lankester in 1877. It contained at that time the single genus *Rhabdopleura*, a minute animal dredged by Sars off the Lofoten Islands, and by Norman off the Shetlands. *Rhabdopleura* was at first regarded as an aberrant Polyzoon, but with the publication of the *Challenger Report* (*Cephalodiscus*) in 1887, it became clear that *Cephalodiscus*, the second genus now included in the order, had affinities in the direction of the Enteropneusta. The connexion of the Pterobranchia with the Polyzoa is in the highest degree questionable.

Rhabdopleura is no doubt of world-wide distribution, since it has been recorded in various localities from Greenland to South Australia, usually in water of not less than forty fathoms. *Cephalodiscus*, which for many years was known solely as the result of a single dredging by the "Challenger" from 245 fathoms in the Straits of Magellan, has recently been found in entirely different parts of the world, as for instance between Japan and Korea at 100 fathoms, at about half that depth off the south-east coast of Celebes, and between tide-marks on the coast of Borneo.

It appears to be common in the neighbourhood of Cape Town, while the recent Antarctic expeditions have shown that it occurs in various localities from the Falkland Islands to the Antarctic circle. No less than twelve species, referred to three sub-genera (*Demiothecia*, *Idiothecia*, *Orthococcus*), have now been described; but it is at present uncertain whether more than a single species of *Rhabdopleura* is valid, although several specific names have been suggested for specimens from different localities.

Both genera are characterized by their habit of secreting a tubular gelatinoid investment, the "coenocium," composed of a number of superposed lamellae, doubtless the result of its intermittent secretion, mainly though perhaps not exclusively, by the proboscides of the zooids. In *Rhabdopleura* each zooid forms its own delicate tube composed of a characteristic series of distinct rings. In *Cephalodiscus* the coenocium is more massive, and may contain a continuous irregular cavity in which the zooids live (*Demiothecia*), or may be secreted in such a way that each zooid has its own independent tube (*Idiothecia*, *Orthococcus*).

The zooids are a modification of the type of structure known in *Balanoglossus*, from which they differ principally in the following respects: (i.) The alimentary canal, instead of being straight, has a U-shaped flexure, the dorsal line between the mouth and the anus being short. (ii.) The proboscis (fig. 1, b), known as the "buccal shield," is a large organ, strongly flattened in an

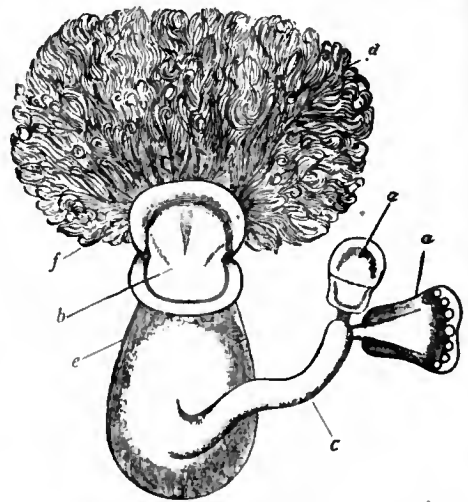

(From a drawing by Professor McIntosh.)

FIG. 1.—Zooid of *Cephalodiscus dodecalophus* (× 50).

- | | |
|---------------|-------------------------------|
| a, a, Buds. | d, Arms and tentacles. |
| b, Proboscis. | e, Ventral edge of proboscis. |
| c, Stalk. | f, Its dorsal edge. |

antero-posterior direction, its ventral lobe usually concealing the mouth. (iii.) The collar is produced dorsally into arms (one pair in *Rhabdopleura*, four to eight pairs in *Cephalodiscus*), each of which bears numerous ciliated tentacles, the organs by which the microscopic food-particles are conveyed to the mouth. (iv.) The third division of the body, the metasome, is prolonged ventrally into a relatively enormous outgrowth containing the loop of the alimentary canal, beyond which projects a stalk (fig. 1, c), of a length varying with the state of contraction and perhaps with the species. (v.) The stalk gives rise to buds, by which the colonial habit is acquired. While in *Rhabdopleura* the buds remain in organic continuity with the parent, in *Cephalodiscus* they become free at an early stage, and the coenocium accordingly contains a number of separate individuals. In the living *Cephalodiscus* a zooid can crawl by means of its proboscis over the gelatinous processes of the outer side of the coenocium, a position which it can assume owing to the very great extensibility of the stalk, the proximal sutorial end of which remains attached to the inner surface of some part of the coenocium (Andersson, 1907).

In correspondence with the fundamental constitution of the zooid, each of the three segments has its own body-cavity separated from the others. The main proboscis-cavity (fig. 2, b.c.¹) is unpaired, and opens to the exterior by the two proboscis pores (p.p.). It contains a closed vesicle regarded by Schepotieff as a right proboscis-cavity and in any case representing the pericardium of *Balanoglossus*, the glomerulus of which is also probably represented. The collar-cavity (b.c.²) is paired, although its ventral mesentery is not complete. It extends into the arms, which originate in the bud (fig. 1) as dorsal outgrowths of the collar. The ventral and lateral parts of the anterior

margin of the collar constitute the so-called operculum (*op.*), a structure which not only acts as a lower lip, but must be important in separating the food-current produced by the cilia of the tentacles from the external apertures of the collar-canal and gill-slits. The collar-canal (fig. 3, *c.p.*) are a pair of ovoid organs which open from the collar-cavity to the exterior, their external pores lying immediately behind the base of the operculum.

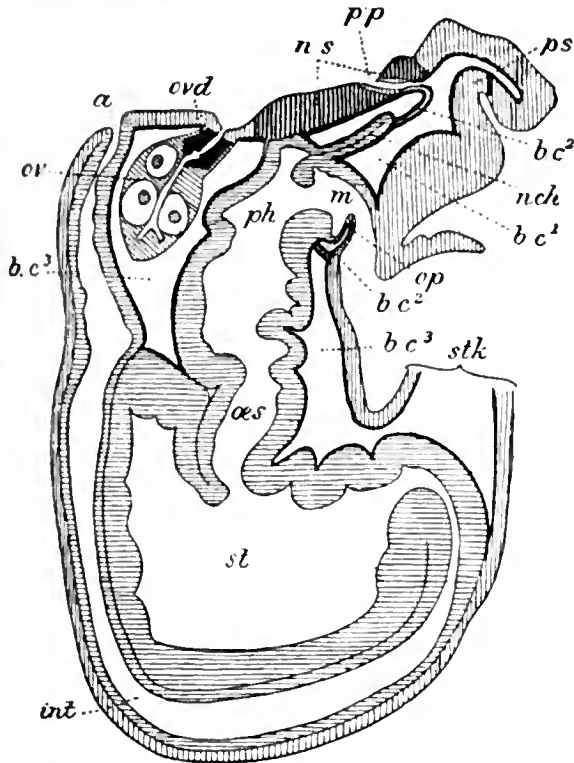

(After Harmer.)

FIG. 2.—Median (sagittal) section of *Cephalodiscus dodecalophus*.

- | | |
|---|---|
| <i>a.</i> , Anus. | <i>op.</i> , Operculum, or ventral lip. |
| <i>b.c.1.</i> , Body-cavity of proboscis. | <i>ov.</i> , Ovary. |
| <i>b.c.2.</i> , Of collar. | <i>ovd.</i> , Oviduct. |
| <i>b.c.3.</i> , Of metasome. | <i>ph.</i> , Pharynx. |
| <i>int.</i> , Intestine. | <i>p.p.</i> , Proboscispore. |
| <i>m.</i> , Mouth. | <i>p.s.</i> , Proboscis. |
| <i>nch.</i> , Notochord. | <i>st.</i> , Stomach. |
| <i>n.s.</i> , Central nervous system. | <i>stk.</i> , Stalk. |
| <i>oes.</i> , Oesophagus. | |

While it is not improbable that the collar-pores and the proboscispores may evacuate excretory substances, there can be little doubt that their primary function is to regulate the turgidity of the segment to which they respectively belong. A pair of gill-slits (fig. 3, *g.s.*), which do not occur in *Rhabdopleura*, open immediately behind the collar-pores. It is probable that they serve to strain off the superfluous water which is introduced into the mouth during the process of feeding. An anterior median diverticulum of the pharynx (fig. 2, *nch.*), growing forwards in the septum between the proboscis-cavity and the collar-cavities, and supported dorsally by the median mesentery of the collar, is the representative of the so-called notochord or stomochord of *Balanoglossus*; and if the view that this organ is really a notochord is well founded, it may be regarded as the homologue of the anterior end of the Vertebrate notochord.

The metasome contains nearly the whole of the alimentary canal, in which pharynx (fig. 2, *ph.*), oesophagus (*oes.*), stomach (*st.*) and intestine (*int.*) may be distinguished. The remarkable position of the anus (*a*) on the dorsal side has already been alluded to. The metasomatic cavities are divided by dorsal (fig. 3, *d.mes.*) and ventral mesenteries, the latter following the outer curvature of the loop of the alimentary canal. The most conspicuous blood vessel possessed by *Cephalodiscus* is the dorsal vessel (*d.b.v.*). A ventral vessel occurs on the anterior side of the metasome and forms a loop extending down the entire length of the stalk, while a "heart" projects into the cavity of the pericardium, probably connected on the ventral side of the notochord with the ventral vessel, and on its dorsal side with the dorsal vessel. At their opposite ends the dorsal and ventral vessels are probably connected with one another by means of a splanchnic sinus surrounding the stomach. The original specimen of *C. dodecalophus* contained exclusively female zooids, in which a single pair of ovaries (figs. 2, 3, *ov.*) lie in the metasomatic cavities, and open to the exterior dorsally by short, highly

pigmented oviducts (fig. 2, *ovd.*). In *C. nigrescens* and in some other species a zooid may contain a pair of ovaries, a pair of testes, or an ovary and a testis, although the males, females and hermaphrodites do not differ from one another in external characters. In *C. sibogae* (Celebes) the single colony known is of the male sex. The reproductive individuals have undergone an extraordinary simplification of the organs concerned with the collection and digestion of food. Thus the arms are reduced to a single pair and possess no tentacles, there is no definite operculum, and the alimentary canal is vestigial. The testes, which correspond in position with the ovaries of a female *Cephalodiscus*, constitute the greater part of the animal. Associated with these males are neuter zooids, which usually possess no functional reproductive organs, but have in other respects the structure of an ordinary female *Cephalodiscus*. It appears probable that there is a vascular connexion between these and the male individuals, which thus derive their nutriment from the neuters. The reproductive organs of *Rhabdopleura* have but seldom been observed. They resemble those of *Cephalodiscus* in structure and in position, except that in each sex the gonad occurs on the right side of the body only (Schepotieff, 1906).

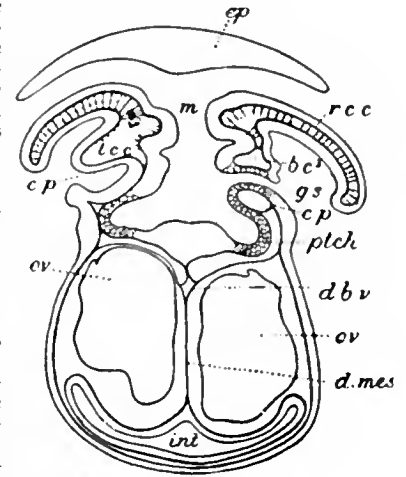

(After Masterman.)

FIG. 3.—Section transverse to the long axis of *Cephalodiscus dodecalophus* (morphologically a frontal section).

- | | |
|--|---|
| <i>b.c.3.</i> , Body cavity of metasome. | <i>d.b.v.</i> , Dorsal blood-vessel. |
| <i>c.p.</i> , Collar-canal, above which is seen the operculum. | <i>d.mes.</i> , Dorsal mesentery. |
| | <i>ep.</i> , Proboscis. |
| | <i>g.s.</i> , Gill-slit. |
| | <i>int.</i> , Intestine. |
| | <i>l.c.c.</i> , Left collar-cavity. |
| | <i>m.</i> , Mouth. |
| | <i>ov.</i> , Ovary. |
| | <i>plch.</i> , Vacuolated tissue of pharyngeal wall, the so-called "pleurochords" of Masterman. |
| | <i>r.c.c.</i> , Right collar-cavity. |

The eggs of *Cephalodiscus* possess a large amount of yolk, and it is practically certain that there is no pelagic larval form. The embryos are hatched in an early stage, but their metamorphosis has not been observed. The early development appears to resemble that of the large-yolked species of *Balanoglossus*. In the bud-development, the three-segmented condition is extremely conspicuous, and a striking feature is the great relative size of the proboscis (fig. 1). A considerable part of the alimentary canal is said to be derived from the ectoderm in the buds of both *Cephalodiscus* and *Rhabdopleura*. Schepotieff (1907) states that in the young buds of the latter the central part of the alimentary canal is developed from cells which are apparently not of ectodermic origin.

The affinity of the Pterobranchia to the Enteropneusta may be regarded as definitely established. Considering the wide differences between the two groups in the size and external characters, and in the mode of life, including the mode of feeding, it is indeed surprising that in every important organ the two groups should show a fundamental morphological identity. Their relations to *Phoronis* are doubtful (see PHORONIDEA). The question of their affinity to other divisions of the animal kingdom depends principally on the views which are held with regard to the relationships of the Enteropneusta and Phoronidea respectively. The suggestion has been made by Allmann and recently upheld by Schepotieff that *Rhabdopleura* is related to some of the Graptolites.

BIBLIOGRAPHY.—(1) Andersson, "Die Pterobranchier," *Wiss. Ergebn.-Schwed. Sudpolar Exp.* (1907) vol. v.; (2) Fowler, "Rhabdopleura," *Proc. Roy. Soc.* (1893), lii. 132; *Festschr. Leuckarts* (1892), p. 293; art. "Hemichorda," *Ency. Brit.* (1902), suppl. vols. xxix. p. 249; *Quart. Journ. Mic. Sci.* (1905), xlviii. 23; (3) Harmer, "Appendix to report on *Cephalodiscus*," *Challenger Rep.* (1887), vol. xx. pt. lxii. p. 39; "Pterobranchia," *Siboga Rep.* (1905), Monogr. vol. xxvi. bis.; (4) Lankester, "Rhabdopleura," *Quart. Journ. Mic. Sci.* (1884), xxiv. 622; art. "Polyzoa," *Ency. Brit.*, 9th ed. (1885), xix. 430, 434; "Cephalodiscus nigrescens," *Proc. Roy. Soc.* (1905), B. lxxvi. 400; (5) McIntosh, "Report on *Cephalodiscus*," *Challenger Rep.* (1887), vol. xx. pt. lxii.; (6) Masterman, "Cephalodiscus," *Quart. Journ. Mic. Sci.* (1898), xl. 340;

(1903), vol. xlv. 715; "Cephalodiscus: Budding," &c., *Trans. Roy. Soc. Edin.* (1900), vol. xxxix. 507; (7) Ridewood, "Cephalodiscus" *Mar. Invest. S. Africa* (1906), vol. iv. 173; *National Antarctic Exp., Nat. Hist.*, ii. (1907); *Quart. Journ. Mic. Sci.* (1907), vol. ii., 221; (8) G. O. Sars, "Rhabdopleura," *Christiania Univ. Program.* (1869), vol. i.; (9) Schepotieff, "Rhabdopleura," *Zool. Jahrb. Abt. Anat.* (1906), vol. xxiii., 463; (1907), vol. xxiv., 193; "Cephalodiscus" (1907), vol. xxv. 553; "Rhabdopleura and Graptolites," *Neues Jahrb. f. Mineral* (1905), Bd. ii. p. 79. (S. F. H.)

PTERODACTYLES (Gr. for wing-fingers), an extinct order of flying reptiles, variously known as Pterosauria (Gr. for wing-lizards) or Ornithosauria (Gr. for bird-lizards), whose remains occur in all Mesozoic formations from the Lower Lias to the Upper Cretaceous inclusive. Their bones are of very light, though strong construction, and hollow like those of flying



Rhamphorhynchus phyllurus: restoration by O. C. Marsh, showing extent of flying membranes ($\frac{1}{2}$ nat. size).—Upper Jurassic (Lithographic stone); Bavaria.

birds, with well-fitting articulations, quite different from those of ordinary reptiles. The head is large and remarkably bird-like in shape, while it is fixed on the neck at the same angle as in birds. The brain is small, but resembles that of birds in its general conformation. The trunk is relatively small, with few slender ribs and a keeled breastbone (sternum). The forelimbs are always a pair of wings, the fifth digit or "little" finger being enormously elongated for the support of a smooth flying membrane (seen in specimens from the lithographic stone of Bavaria). The wings are thus constructed on the same plan as those of a bat, but instead of four fingers, only one is elongated to bear the membrane. The hind-limbs are comparatively feeble, and must have been of very little use for walking.

The remains of pterodactyles are found chiefly in marine deposits, so that these reptiles must have frequented the coast-lines. They probably fed partly on fish, partly on insects; but no traces of food have hitherto been observed within the fossil skeletons. The oldest satisfactorily known member of the group is *Dimorphodon* from the Lower Lias of Dorsetshire. The typical species has a skull about 20 centim. in length, with large teeth in front, smaller teeth behind; its tail is much elongated and slender. Equally fine skeletons of *Campylognathus* have been found in the Upper Lias of Württemberg. Other long-tailed pterodactyles occur well preserved in the Upper Jurassic (lithographic stone) of Bavaria and Württemberg, which is so fine-grained as to show impressions of the wing-membrane. In *Rhamphorhynchus* there is also a rhomboidal expansion of membrane at the end of the tail. The short-tailed *Pterodactylus* itself, sometimes no larger than a sparrow, is also found in the same formation. It was originally described by Collini in 1784 as an unknown sea-animal, and its true nature was first determined by Cuvier in 1809, when he named it "Pterodactyle." The Pterosaurians of the Cretaceous period, just before their extinction both in Europe and in North America, were of enormous size, and some became toothless. A pair of wings of the toothless *Pteranodon* from the Chalk of Kansas, now in the British Museum, measures about five and a half metres in span. Fragments of equally large pterodactyles with teeth are found in the English Chalk.

See H. G. Seeley, *The Ornithosauria* (Cambridge, 1870) and *Dragons of the Air* (London, 1901); S. W. Williston, paper in *Kansas University Quarterly* (1897), vi. 35; G. F. Eaton, papers in *Amer. Journ. Science* (1903-1904), 4th series, vols. xvi., xvii.

(A. S. Wo.)

PTERON (Gr. πτερόν, a wing), an architectural term used by Pliny for the peristyle of the tomb of Mausolus, which was raised on a lofty podium, and so differed from an ordinary peristyle raised only on a stylobate, as in Greek temples, or on a low podium, as in Roman temples.

PTOLEMAEUS, of Alexandria, surnamed Chennus, Greek grammarian during the reigns of Trajan and Hadrian. According to Suidas, he was the author of an historical drama named *Sphinx*, of an epic, *Anthomeros*, in 24 books (both lost) and a *Strange History*. The last is probably identical with the work of which an abridgment has been preserved in Photius (*cod.* 190). It contains a medley of all sorts of legends and fables belonging to both the mythological and historical periods. It is probable that Chennus was also the author of a lost treatise on the life and works of Aristotle, ascribed to "Ptolemaeus" in an Arabic list of his works, taken from a Syriac version of the Greek original (A. Baumstark, *Aristoteles bei den Syrern vom v.-viii. Jahrh.*, Leipzig, 1900).

See editions of Photius's abridgment by J. Roulez (1834); and in A. Westermann, *Mythographi graeci* (1843); R. Hercher, *Über die Glaubwürdigkeit der neuen Geschichte des Ptolemäus Chennus* (Leipzig, 1856); J. E. Sandys, *Hist. of Classical Scholarship* (2nd ed., 1906).

PTOLEMIES, a dynasty of Macedonian kings who ruled in Egypt from 323 to 30 B.C.

The founder, **PTOLEMY** (Πτολεμαῖος), son of Lagus, a Macedonian nobleman of Eordea, was one of Alexander the Great's most trusted generals, and among the seven "body-guards" attached to his person. He plays a principal part in the later campaigns of Alexander in Afghanistan and India. At the Susa marriage festival in 324 Alexander caused him to marry the Persian princess Artacama; but there is no further mention of this Asiatic bride in the history of Ptolemy. When Alexander died in 323 the resettlement of the empire at Babylon is said to have been made at Ptolemy's instigation. At any rate he was now appointed satrap of Egypt under the nominal kings Philip Arrhidaeus and the young Alexander. He at once took a high hand in the province by killing Cleomenes, the financial controller appointed by Alexander the Great; he also subjugated Cyrenaica. He contrived to get possession of Alexander's body which was to be interred with great pomp by the imperial government and placed it temporarily in Memphis. This act led to an open rupture between Ptolemy and the imperial regent Perdiccas. But Perdiccas perished in the attempt to invade Egypt (321). In the long wars between the different Macedonian chiefs which followed, Ptolemy's first object is to hold his position in Egypt securely, and secondly to possess the Cyrenaica, Cyprus and Palestine (Coele-Syria). His first occupation of Palestine was in 318, and he established at the same time a protectorate over the petty kings of Cyprus. When Antigonus, master of Asia in 315, showed dangerous ambitions, Ptolemy joined the coalition against him, and, on the outbreak of war, evacuated Palestine. In Cyprus he fought the partisans of Antigonus and reconquered the island (313). A revolt of Cyrene was crushed in the same year. In 312 Ptolemy, with Seleucus, the fugitive satrap of Babylonia, invaded Palestine and beat Demetrius, the son of Antigonus, in the great battle of Gaza. Again he occupied Palestine, and again a few months later, after Demetrius had won a battle over his general and Antigonus entered Syria in force, he evacuated it. In 311 a peace was concluded between the combatants, soon after which the surviving king Alexander was murdered in Macedonia, leaving the satrap of Egypt absolutely his own master. The peace did not last long, and in 309 Ptolemy commanded a fleet in person which detached the coast towns of Lycia and Caria from Antigonus and crossed to Greece, where Ptolemy took possession of Corinth, Sicyon and Megara (308). In 306 a great fleet under Demetrius attacked Cyprus, and Ptolemy's brother, Menelaus, was defeated and captured in the decisive battle of Salamis. The complete loss of Cyprus followed. Antigonus and Demetrius

now assumed the title of kings; Ptolemy, as well as Cassander, Lysimachus and Seleucus, answered this challenge by doing the same. In the winter (306-5) Antigonus tried to follow up the victory of Cyprus by invading Egypt, but here Ptolemy was strong, and held the frontier successfully against him. Ptolemy led no further expedition against Antigonus overseas. To the Rhodians, besieged by Demetrius (305-4), he sent such help as won him divine honours in Rhodes and the surname of *Sotēr* ("saviour"). When the coalition was renewed against Antigonus in 302, Ptolemy joined it, and invaded Palestine a third time, whilst Antigonus was engaged with Lysimachus in Asia Minor. On a report that Antigonus had won a decisive victory, for a third time he evacuated the country. But when news came that Antigonus had been defeated and slain at Ipsus (301) by Lysimachus and Seleucus, Ptolemy occupied Palestine for the fourth time. The other members of the coalition had assigned Palestine to Seleucus after what they regarded as Ptolemy's desertion, and for the next hundred years the question of its ownership becomes the standing ground of enmity between the Seleucid and Ptolemaic dynasties. Henceforth, Ptolemy seems to have mingled as little as possible in the broils of Asia Minor and Greece; his possessions in Greece he did not retain, but Cyprus he reconquered in 295-4. Cyrene, after a series of rebellions, was finally subjugated about 300 and placed under his stepson Magas (Beloch, *Griech. Gesch.* III. [ii.], p. 134 seq.). In 285 he abdicated in favour of one of his younger sons by Berenice (*q.v.*), who bore his father's name of Ptolemy; his eldest (legitimate) son, Ptolemy Ceraunus, whose mother, Eurydice, the daughter of Antipater, had been repudiated, fled to the court of Lysimachus. Ptolemy I. Soter died in 283 at the age of 84. Shrewd and cautious, he had a compact and well-ordered realm to show at the end of fifty years of wars. His name for *bonhomie* and liberality attached the floating soldier-class of Macedonians and Greeks to his service. Nor did he neglect conciliation of the natives. He was a ready patron of letters, and the great library, which was Alexandria's glory, owed to him its inception. He wrote himself a history of Alexander's campaigns, distinguished by its straightforward honesty and sobriety.

PTOLEMY II. *Philadelphus* (309-246), was of a delicate constitution, no Macedonian warrior-chief of the old style. His brother Ptolemy Ceraunus found compensation by becoming king in Macedonia in 281, and perished in the Gallic invasion of 280-79 (see BRENNUS). Ptolemy II. maintained a splendid court in Alexandria. Not that Egypt held aloof from wars. Magas of Cyrene opened war on his half-brother (274), and Antiochus I., the son of Seleucus, desiring Palestine, attacked soon after. Two or three years of war left Egypt the dominant naval power of the eastern Mediterranean; the Ptolemaic sphere of power extended over the Cyclades to Samothrace, and the harbours and coast towns of Cilicia Trachea ("Rough Cilicia"), Pamphylia, Lycia and Caria were largely in Ptolemy's hands (*Theoc. Idyll.* xvii. 86 seq.). The victory won by Antigonus, king of Macedonia, over his fleet at Cos (between 258-56; see Beloch, III. [ii.], p. 428 seq.) did not long interrupt his command of the Aegean. In a second war with the Seleucid kingdom, under Antiochus II. (after 260), Ptolemy sustained losses on the seaboard of Asia Minor and agreed to a peace by which Antiochus married his daughter Berenice (250?). Ptolemy's first wife, Arsinoë (I.), daughter of Lysimachus, was the mother of his legitimate children. After her repudiation he married, probably for political reasons, his full-sister Arsinoë (II.), the widow of Lysimachus, by an Egyptian custom abhorrent to Greek morality. The material and literary splendour of the Alexandrian court was at its height under Ptolemy II. Poms and gay religions flourished. Ptolemy deified his parents as the *θεοὶ ἀδελφοί*, and his sister-wife, after her death (270), as *Philadelphus*. This surname was used in later generations to distinguish Ptolemy II. himself, but properly it belongs to Arsinoë only, not to the king. Callimachus, made keeper of the library, Theocritus, and a host of lesser poets, glorified the Ptolemaic family. Ptolemy himself was eager to increase the library and

to patronize scientific research. He had the strange beasts of far-off lands sent to Alexandria. But, an enthusiast for Hellenic culture, he seems to have shown but little interest in the native religion. The tradition which connects the Septuagint translation of the Old Testament into Greek with his name is not historical. Ptolemy had many brilliant mistresses, and his court, magnificent and dissolute, intellectual and artificial, has been justly compared with the Versailles of Louis XIV.

PTOLEMY III. *Euergetes I.* (reigned 246-221), son of Ptolemy II. and Arsinoë I. At the beginning of his reign he reunited the Cyrenaica to Egypt by marrying Berenice the daughter and successor of Magas (who had died about 250). At the same time he was obliged to open war on the Seleucid kingdom, where Antiochus II. was dead and his sister Berenice had been murdered, together with her infant son, by Antiochus's former wife, Laodice, who claimed the kingdom for her son Seleucus II. Ptolemy marched triumphantly into the heart of the Seleucid realm, as far at any rate as Babylonia, and received the formal submission of the provinces of Iran, while his fleets in the Aegean recovered what his father had lost upon the seaboard, and made fresh conquests as far as Thrace. This moment marks the zenith of the Ptolemaic power. After Ptolemy returned home, indeed, Seleucus regained northern Syria and the eastern provinces, but the naval predominance of Egypt in the Aegean remained, although there are traces of its being replaced locally, towards the end of Euergetes' reign, by that of Macedonia—in Amorgos, Naxos, Syros, Nisyros, Cos and parts of Crete (see Beloch, III. [ii.], p. 463). After his final peace with Seleucus, Ptolemy no longer engaged actively in war, although his forces might occasionally mingle in the broils of Asia Minor, and he supported the enemies of Macedonia in Greece. It seems probable that his internal policy differed from his father's in patronizing the native religion more liberally; he has left larger traces at any rate among the monuments that are known to-day.

PTOLEMY IV. *Philopator* (reigned 221-204), son of the preceding, was a wretched debauchee under whom the decline of the Ptolemaic kingdom began. His reign was inaugurated by the murder of his mother, and he was always under the dominion of favourites, male and female, who indulged his vices and conducted the government as they pleased. Self-interest led his ministers to make serious preparations to meet the attacks of Antiochus III. (the Great) on Palestine, and the great Egyptian victory of Raphia (217), at which Ptolemy himself was present, secured the province till the next reign. The arming of Egyptians in this campaign had a disturbing effect upon the native population of Egypt, so that rebellions were continuous for the next thirty years. Philopator was devoted to orgiastic forms of religion and literary dilettantism. He built a temple to Homer and composed a tragedy, to which his vile favourite Agathocles added a commentary. He married (about 215) his sister Arsinoë (III.), but continued to be ruled by his mistress Agathoclea, sister of Agathocles.

PTOLEMY V. *Epiphanes* (reigned 204-181), son of Philopator and Arsinoë, was not more than five years old when he came to the throne, and under a series of regents the kingdom was paralysed. Antiochus III. and Philip V. of Macedonia made a compact to divide the Ptolemaic possessions overseas. Philip seized several islands and places in Caria and Thrace, whilst the battle of Panium (198) definitely transferred Palestine from the Ptolemies to the Seleucids. Antiochus after this concluded peace, giving his own daughter Cleopatra to Epiphanes to wife (193-192). Nevertheless, when war broke out between Antiochus and Rome Egypt ranged itself with the latter power. Epiphanes in manhood was chiefly remarkable as a passionate sportsman; he excelled in athletic exercises and the chase. Great cruelty and perfidy were displayed in the suppression of the native rebellion, and some accounts represent him as personally tyrannical.

The elder of his two sons, PTOLEMY VI. *Philometor* (181-145), succeeded as an infant under the regency of his mother Cleopatra. Her death was followed by a rupture between the Ptolemaic and Seleucid courts, on the old question of Palestine.

Antiochus IV. Epiphanes invaded Egypt (170) and captured Philometor.

The Alexandrians then put his younger brother PTOLEMY VII. *Euergetes II.* (afterwards nicknamed *Physkon*, on account of his bloated appearance) upon the throne. Antiochus professed to support Philometor, but, when he withdrew, the brothers agreed to be joint-kings with their sister Cleopatra as queen and wife of Philometor. Antiochus again invaded Egypt (168), but was compelled by the Roman intervention to retire. The double kingship led to quarrels between the two brothers in which fresh appeals were continually made to Rome. In 163 the Cyrenaica was assigned under Roman arbitration to Euergetes as a separate kingdom. As he coveted Cyprus as well, the feud still went on, Rome continuing to interfere diplomatically but not effectively. In 154 Euergetes invaded Cyprus but was defeated and captured by Philometor. He found his brother, however, willing to pardon and was allowed to return as king to Cyrene. In 152 Philometor joined the coalition against the Seleucid king Demetrius I. and was the main agent in his destruction. The protégé of the coalition, Alexander Balas, married Philometor's daughter Cleopatra (Thea), and reigned in Syria in practical subservience to him. But in 147 Philometor broke with him and transferred his support, together with the person of Cleopatra, to Demetrius II., the young son of Demetrius I. He himself at Antioch was entreated by the people to assume the Seleucid diadem, but he declined and installed Demetrius as king. In 145 in the battle on the Oenoparas near Antioch, in which Alexander Balas was finally defeated, Philometor received a mortal wound. Philometor was perhaps the best of the Ptolemies. Kindly and reasonable, his good nature seems sometimes to have verged on indolence, but he at any rate took personal part, and that bravely and successfully, in war.

Philometor's infant son, Ptolemy Philopator Neos (?), was proclaimed king in Alexandria under the regency of his mother Cleopatra. Euergetes however, swooping from Cyrene, seized the throne and married Cleopatra, making away with his nephew. He has left an odious picture of himself in the historians—a man untouched by benefits or natural affection, delighting in deeds of blood, his body as loathsome in its blown corpulence as his soul. Something must be allowed for the rhetorical habit of our authorities, but that Euergetes was ready enough to shed blood when policy required seems true. He soon found a more agreeable wife than Cleopatra in her daughter Cleopatra, and thenceforth antagonism between the two queens, the "sister" and the "wife," was chronic. In 130-1 Cleopatra succeeded in driving Euergetes for a time to Cyprus, when he revenged himself by murdering the son whom she had borne him (surnamed *Memphites*). Massacres inflicted upon the Alexandrians and the expulsion of the representatives of Hellenic culture are laid to his charge. On the other hand, the monument and papyri show him a liberal patron of the native religion and a considerable administrator. In fact, while hated by the Greeks, he seems to have had the steady support of the native population. But there are also records which show him, not as an enemy, but a friend, like his ancestors, to Greek culture. He himself published the fruit of his studies and travels in a voluminous collection of notebooks, in which he showed a lively eye for the oddities of his fellow kings. The old Ptolemaic realm was never again a unity after the death of Euergetes II. By his will he left the Cyrenaica as a separate kingdom to his illegitimate son Ptolemy Apion (116-96), whilst Egypt and Cyprus were bequeathed to Cleopatra (Kokke) and whichever of his two sons by her, PTOLEMY VIII. *Soter II.* (nicknamed *Lathyros*) and PTOLEMY IX. Alexander I., she might choose as her associate. The result was, of course, a long period of domestic strife. From 116 to 108 Soter reigned with his mother, and at enmity with her, in Egypt, whilst her favourite son, Alexander, ruled Cyprus. Cleopatra compelled Soter to divorce his sister-wife Cleopatra and marry another sister, Selene. Cleopatra plunged into the broils of

the Seleucid house in Syria and perished. In 108 Cleopatra Kokke called Alexander to Egypt, and Soter flying to Cyprus took his brother's place and held the island against his mother's forces. The attempts which Soter and Cleopatra respectively made in 104-3 to obtain a predominance in Palestine came to nothing. Alexander now shook off his mother's yoke and married Soter's daughter Berenice. Cleopatra Kokke died in 101 and from then till 89 Alexander reigned alone in Egypt. In 89 he was expelled by a popular uprising and perished the following year in a sea-fight with the Alexandrian ships off Cyprus. Soter was recalled (88) and reigned over Egypt and Cyprus, now reunited, in association with his daughter Berenice. This, his second; reign in Egypt (88-80), was marked by a native rebellion which issued in the destruction of Thebes. On his death Berenice assumed the government, but the son of Alexander I., PTOLEMY X. Alexander II., entering Alexandria under Roman patronage, married, and within twenty days assassinated, his elderly cousin and stepmother. He was at once killed by the enraged people and with him the Ptolemaic family in the legitimate male line became extinct. Ptolemy Apion meanwhile, dying in 96, had bequeathed the Cyrenaica to Rome. The Alexandrian people now chose an illegitimate son of Soter II. to be their king, PTOLEMY XI. *Philopator Philadelphus Neos Dionysus*, nicknamed *Auletes*, the flute-player (80-51), setting his brother as king in Cyprus. The rights of these kings were doubtful, not only because of their illegitimate birth, but because it was claimed in Rome that Alexander II. had bequeathed his kingdom to the Roman people. Two Seleucid princes, children of Soter's sister Selene, appeared in Rome in 73 to urge their claim to the Ptolemaic throne. Ptolemy Auletes was thus obliged to spend his reign in buying the support of the men in power in Rome. Cyprus was annexed by Rome in 58, its king committing suicide. From 58 to 55 Auletes was in exile, driven out by popular hatred, and worked by bribery and murder in Rome to get himself restored to Roman power. His daughter Berenice meanwhile reigned in Alexandria, a husband being found for her in the Pontic prince Archelaus. In 55 Auletes was restored by the proconsul of Syria, Aulus Gabinius. He killed Berenice and, dying in 51, bequeathed the kingdom to his eldest son, aged ten years, who was to take as wife his sister Cleopatra, aged seventeen. In the reign of PTOLEMY XII. *Philopator* (51-47) and Cleopatra Philopator, Egyptian history coalesces with the general history of the Roman world, owing to the murder of Pompey off Pelusium in 48 and the Alexandrine War of Julius Caesar (48-47). In that war the young king perished and a still younger brother, PTOLEMY XIII. *Philopator*, was associated with Cleopatra till 44, when he died, probably by Cleopatra's contriving. From then till her death in 30, her son, born in 47, and asserted by Cleopatra to be the child of Julius Caesar, was associated officially with her as PTOLEMY XIV. *Philopator Philometor Caesar*; he was known popularly as *Caesarion*. (For the incidents of Cleopatra's reign see CLEOPATRA, ARSINOË.) After her death in 30 and Caesarion's murder Egypt was made a Roman province. Cleopatra's daughter by Antony (Cleopatra Selene) was married in 25 to Juba II. of Mauretania. Their son Ptolemy, who succeeded his father (A.D. 23-40), left no issue.²

See Mahaffy, *The Empire of the Ptolemies* (1895) and *Egypt under the Ptolemaic Dynasty* (1899); Strack, *Die Dynastie der Ptolemäer* (1897); Bouché-Leclercq, *Histoire des Lagides* (1904, 1907); Meyer, *Das Heerwesen der Ptolemäer und Römer* (Leipzig, 1900).

(E. R. B.)

PTOLEMY (CLAUDIUS PTOLEMAEUS), the celebrated mathematician, astronomer and geographer, was a native of Egypt, but there is an uncertainty as to the place of his birth. Some ancient manuscripts of his works describe him as of Pelusium, but Theodorus Meliteniota, a Greek writer on astronomy of the

²The Ptolemies were not in antiquity distinguished by the ordinal numbers affixed to their names by modern scholars and represented according to the usual convention by Roman figures. This is merely done for our convenience. In the case of the later Ptolemies different systems of notation prevail according as the problematic Eupator and Philopator Neos are reckoned in or not.

¹Or, according to another view, Eupator. On the obscure questions raised by these two surnames, see L. Pareti, *Ricerche sui Tolemei Eupatore e Neo Filopatore* (Turin, 1908).

12th century, says that he was born at Ptolemais Hermii, a Grecian city of the Thebaid. It is certain that he observed at Alexandria during the reigns of Hadrian and Antoninus Pius, and that he survived Antoninus. Olympiodorus, a philosopher of the Neoplatonic school who lived in the reign of the emperor Justinian, relates in his scholia on the *Phaedo* of Plato that Ptolemy devoted his life to astronomy and lived for forty years in the so-called Πτερά τοῦ Κανώβου, probably elevated terraces of the temple of Serapis at Canopus near Alexandria, where they raised pillars with the results of his astronomical discoveries engraved upon them. This statement is probably correct; we have indeed the direct evidence of Ptolemy himself that he made astronomical observations during a long series of years; his first recorded observation was made in the eleventh year of Hadrian, 127 A.D.,¹ and his last in the fourteenth year of Antoninus, 151 A.D. Ptolemy, moreover, says, "We make our observations in the parallel of Alexandria." St Isidore of Seville asserts that he was of the royal race of the Ptolemies, and even calls him king of Alexandria; this assertion has been followed by others, but there is no ground for their opinion. Indeed Fabricius shows by numerous instances that the name Ptolemy was common in Egypt. Weidler, from whom this is taken, also tells us that according to Arabian tradition Ptolemy lived to the age of seventy-eight years; from the same source some description of his personal appearance has been handed down, which is generally considered as not trustworthy, but which may be seen in Weidler, *Historia astronomiae*, p. 177, or in the preface to Halma's edition of the *Almagest*, p. 61.

Mathematics.

Ptolemy's work as a geographer is discussed below, and an account of the discoveries in astronomy of Hipparchus and Ptolemy is given in the article ASTRONOMY: *History*. Their contributions to pure mathematics, however, require to be noticed here. Of these the chief is the foundation of trigonometry, plane and spherical, including the formation of a table of chords, which served the same purpose as our table of sines. This branch of mathematics was created by Hipparchus for the use of astronomers, and its exposition was given by Ptolemy in a form so perfect that for 1400 years it was not surpassed. In this respect it may be compared with the doctrine as to the motion of the heavenly bodies so well known as the Ptolemaic system, which was paramount for about the same period of time. There is, however, this difference, that, whereas the Ptolemaic system was then overthrown, the theorems of Hipparchus and Ptolemy, on the other hand, will be, as Delambre says, for ever the basis of trigonometry. The astronomical and trigonometrical systems are contained in the great work of Ptolemy, Ἡ μαθηματικὴ σύνταξις, or, as Fabricius after Syncellus writes it, Μεγάλη σύνταξις τῆς ἀστρονομίας; and in like manner Suidas says οὗτος [Πτολ.] ἔγραψε τὸν μέγαν ἀστρονόμον ἢτοι σύνταξιν. The *Synaxis* of Ptolemy was called Ὁ μέγας ἀστρονόμος to distinguish it from another collection called Ὁ μικρὸς ἀστρονόμος, also highly esteemed by the Alexandrian school, which contained some works of Autolycus, Euclid, Aristarchus, Theodosius of Tripolis, Hylpsicles and Menelaus. To designate the great work of Ptolemy the Arabs used the superlative *μεγίστη*, from which, the article *al* being prefixed, the hybrid name *Almagest*, by which it is now universally known, is derived.

We proceed now to consider the trigonometrical work of Hipparchus and Ptolemy. In the ninth chapter of the first book of the *Almagest* Ptolemy shows how to form a table of chords. He supposes the circumference divided into 360 equal parts (τμήματα), and then bisects each of these parts. Further, he divides the diameter into 120 equal parts, and then for the subdivisions of these he employs the sexagesimal method as most convenient in practice, i.e. he divides each of the sixty parts of the radius into sixty equal parts, and each of these parts he further subdivides into sixty equal parts. In the Latin translation these subdivisions become "partes minutae primae" and "partes minutae secundae," whence our "minutes"

¹Weidler and Halma give the ninth year; in the account of the eclipse of the moon in that year Ptolemy, however, does not say, as in other similar cases, he had observed, but it had been observed (*Almagest*, iv. 9).

and "seconds" have arisen. It must not be supposed, however, that these sexagesimal divisions are due to Ptolemy; they must have been familiar to his predecessors, and were handed down from the Chaldaeans. Nor did the formation of the table of chords originate with Ptolemy; indeed, Theon of Alexandria, the father of Hypatia, who lived in the reign of Theodosius, in his commentary on the *Almagest* says expressly that Hipparchus had already given the doctrine of chords inscribed in a circle in twelve books, and that Menelaus had done the same in six books, but, he continues, every one must be astonished at the ease with which Ptolemy, by means of a few simple theorems, has found their values; hence it is inferred that the method of calculation in the *Almagest* is Ptolemy's own.

As starting-point the values of certain chords in terms of the diameter were already known, or could be easily found by means of the *Elements* of Euclid. Thus the side of the hexagon, or the chord of 60°, is equal to the radius, and therefore contains sixty parts. The side of the decagon, or the chord of 36°, is the greater segment of the radius cut in extreme and mean ratio, and therefore contains approximately 37° 4' 55" parts, of which the diameter contains 120 parts. Further, the square on the side of the regular pentagon is equal to the sum of the squares on the sides of the regular hexagon and of the regular decagon, all being inscribed in the same circle (Eucl. XIII. 10); the chord of 72° can therefore be calculated, and contains approximately 70° 32' 3". In like manner, the square on the chord of 90°, which is the side of the inscribed square, is twice the square on the radius; and the square on the chord of 120°, or the side of the equilateral triangle, is three times the square on the radius; these chords can thus be calculated approximately. Further, from the values of all these chords we can calculate at once the chords of the arcs which are their supplements.

This being laid down, we now proceed to give Ptolemy's exposition of the mode of obtaining his table of chords, which is a piece of geometry of great elegance, and is indeed, as De Morgan says, "one of the most beautiful in the Greek writers."

He takes as basis and sets forth as a lemma the well-known theorem, which is called after him, concerning a quadrilateral inscribed in a circle: The rectangle under the diagonals is equal to the sum of the rectangles under the opposite sides. By means of this theorem the chord of the sum or the difference of two arcs whose chords are given can be easily found, for we have only to draw a diameter from the common vertex of the two arcs the chord of whose sum or difference is required, and complete the quadrilateral; in one case a diagonal, in the other one of the sides is a diameter of the circle. The relations thus obtained are equivalent to the fundamental formulæ of our trigonometry—

$$\begin{aligned} \sin(A+B) &= \sin A \cos B + \cos A \sin B, \\ \sin(A-B) &= \sin A \cos B - \cos A \sin B, \end{aligned}$$

which can therefore be established in this simple way.

Ptolemy then gives a geometrical construction for finding the chord of half an arc from the chord of the arc itself. By means of the foregoing theorems, since we know the chords of 72° and of 60°, we can find the chord of 12°; we can then find the chords of 6°, 3°, 1½° and three-fourths of 1°, and lastly, the chords of 4¼°, 7¼°, 9°, 10¼°, &c.—all those arcs, namely, as Ptolemy says, which being doubled are divisible by 3. Performing the calculations, he finds that the chord of 1½° contains approximately 1° 34' 55", and the chord of three-fourths of 1° contains 0° 47' 8". A table of chords of arcs increasing by 1½° can thus be formed; but this is not sufficient for Ptolemy's purpose, which was to frame a table of chords increasing by half a degree. This could be effected if he knew the chord of one-half of 1°; but, since this chord cannot be found geometrically from the chord of 1½°, inasmuch as that would come to the trisection of an angle, he proceeds to seek in the first place the chord of 1°, which he finds approximately by means of a lemma of great elegance, due probably to Apollonius. It is as follows: If two unequal chords be inscribed in a circle, the greater will be to the less in a less ratio than the arc described on the greater will be to the arc described on the less. Having proved this theorem, he proceeds to employ it in order to find approximately the chord of 1°, which he does in the following manner—

$$\frac{\text{chord } 60^\circ}{\text{chord } 45^\circ} < \frac{60}{45}, \text{ i.e. } < \frac{4}{3}, \therefore \text{chord } 1^\circ < \frac{4}{3} \text{ chord } 45';$$

again—

$$\frac{\text{chord } 90^\circ}{\text{chord } 60^\circ} < \frac{90}{60}, \text{ i.e. } < \frac{3}{2}, \therefore \text{chord } 1^\circ > \frac{2}{3} \text{ chord } 90'.$$

For brevity we use a modern notation. It has been shown that the chord of 45° is 0° 47' 8" q.p., and the chord of 90° is 1° 34' 15" q.p.; hence it follows that approximately

$$\text{chord } 1^\circ < 1^\circ 2' 50'' 40''' \text{ and } > 1^\circ 2' 50''.$$

Since these values agree as far as the seconds, Ptolemy takes 1° 2' 50" as the approximate value of the chord of 1°. The chord of 1° being thus known, he finds the chord of one-half of a degree, the approximate value of which is 0° 31' 25", and he is at once in a position to complete his table of chords for arcs increasing by half a degree. Ptolemy then gives his table of chords, which is arranged in three columns; in the first he has entered the arcs, increasing by half-degrees, from 0° to 180°; in the second he gives the values of the

chords of these arcs in parts of which the diameter contains 120, the subdivisions being sexagesimal; and in the third he has inserted the thirtieth parts of the differences of these chords for each half-degree, in order that the chords of the intermediate arcs, which do not occur in the table, may be calculated, it being assumed that the increment of the chords of arcs within the table for each interval of 30' is proportional to the increment of the arc.¹

Trigonometry, we have seen, was created by Hipparchus for the use of astronomers. Now, since spherical trigonometry is directly applicable to astronomy, it is not surprising that its development was prior to that of plane trigonometry. It is the subject-matter of the eleventh chapter of the *Almagest*, whilst the solution of plane triangles is not treated separately in that work.

To resolve a plane triangle the Greeks supposed it to be inscribed in a circle; they must therefore have known the theorem—which is the basis of this branch of trigonometry: The sides of a triangle are proportional to the chords of the double arcs which measure the angles opposite to those sides. In the case of a right-angled triangle this theorem, together with Eucl. I. 32 and 47, gives the complete solution. Other triangles were resolved into right-angled triangles by drawing the perpendicular from a vertex on the opposite side. In one place (*Alm.* vi. ch. 7; i. 422, ed. Halma) Ptolemy solves a triangle in which the three sides are given by finding the segments of a side made by the perpendicular on it from the opposite vertex. It should be noticed also that the eleventh chapter of the first book of the *Almagest* contains incidentally some theorems and problems in plane trigonometry. The problems which are met with correspond to the following: Divide a given arc into two parts so that the chords of the doubles of those arcs shall have a given ratio; the same problem for external section. Lastly, it may be mentioned that Ptolemy (*Alm.* vi. ch. 7; i. 421, ed. Halma) takes 3° 8' 30",

i.e. $3 + \frac{8}{60} + \frac{30}{3600} = 3.1416$, as the value of the ratio of the circumference to the diameter of a circle, and adds that, as had been shown by Archimedes, it lies between $3\frac{1}{7}$ and $3\frac{1}{4}$.

The foundation of spherical trigonometry is laid in chapter xi. on a few simple and useful lemmas. The starting-point is the well-known theorem of plane geometry concerning the segments of the sides of a triangle made by a transversal: The segments of any side are in a ratio compounded of the ratios of the segments of the other two sides. This theorem, as well as that concerning the inscribed quadrilateral, was called after Ptolemy—naturally, indeed, since no reference to its source occurs in the *Almagest*. This error was corrected by Mersenne, who showed that it was known to Menelaus, an astronomer and geometer who lived in the reign of the emperor Trajan. The theorem now bears the name of Menelaus, though most probably it came down from Hipparchus; Chasles, indeed, thinks that Hipparchus deduced the property of the spherical triangle from that of the plane triangle, but throws the origin of the latter farther back and attributes it to Euclid, suggesting that it was given in his *Porisms*.² Carnot made this theorem the basis of his theory of transversals in his essay on that subject. It should be noticed that the theorem is not given in the *Almagest* in the general manner stated above; Ptolemy considers two cases only of the theorem, and Theon, in his commentary on the *Almagest*, has added two more cases. The proofs, however, are general. Ptolemy then lays down two lemmas: If the chord of an arc of a circle be cut in any ratio and a diameter be drawn through the point of section, the diameter will cut the arc into two parts the chords of whose doubles are in the same ratio as the segments of the chord; and a similar theorem in the case when the chord is cut externally in any ratio. By means of these two lemmas Ptolemy deduces in an ingenious manner—easy to follow, but difficult to discover—from the theorem of Menelaus for a plane triangle the corresponding theorem for a spherical triangle: If the sides of a spherical triangle be cut by an arc of a great circle, the chords of the doubles of the segments of any one side will be to each other in a ratio compounded of the ratios of the chords of the doubles of the segments of the other two sides. Here, too, the theorem is not stated generally; two cases only are considered, corresponding to the two cases given *in plano*. Theon has added two cases. The proofs are general. By means of this theorem four of Napier's formulae for the solution of right-angled spherical triangles can be easily established. Ptolemy does not give them, but in each case when required applies the theorem of Menelaus for spherics directly. This greatly increases the length of his demonstrations, which the modern reader finds still more cumbersome, inasmuch as in each case it was necessary to express the relation in terms of chords—the equivalents of sines—only, cosines and tangents being of later invention.

Such, then, was the trigonometry of the Greeks. Mathematics, indeed, has ever been, as it were, the handmaid of astronomy, and many important methods of the former arose

¹ Ideler has examined the degree of accuracy of the numbers in these tables and finds that they are correct to five places of decimals.

² On the theorem of Menelaus and the rule of six quantities, see Chasles, *Aperçu historique sur l'origine et développement des méthodes en géométrie*, note vi. p. 291.

from the needs of the latter. Moreover, by the foundation of trigonometry, astronomy attained its final general constitution, in which calculations took the place of diagrams, as these latter had been at an earlier period substituted for mechanical apparatus in solving the ordinary problems.³ Further, we find in the application of trigonometry to astronomy frequent examples and even a systematic use of the method of approximations—the basis, in fact, of all application of mathematics to practical questions. There was a disinclination on the part of the Greek geometer to be satisfied with a mere approximation, were it ever so close; and the unscientific *agrimensor* shirked the labour involved in acquiring the knowledge which was indispensable for learning trigonometrical calculations. Thus the development of the calculus of approximations fell to the lot of the astronomer, who was both scientific and practical.⁴

We now proceed to notice briefly the contents of the *Almagest*. It is divided into thirteen books. The first book, which may be regarded as introductory to the whole work, opens with a short preface, in which Ptolemy, after some observations on the distinction between theory and practice, gives Aristotle's division of the sciences and remarks on the certainty of mathematical knowledge, "inasmuch as the demonstrations in it proceed by the incontrovertible ways of arithmetic and geometry." He concludes his preface with the statement that he will make use of the discoveries of his predecessors, and relate briefly all that has been sufficiently explained by the ancients, but that he will treat with more care and development whatever has not been well understood or fully treated. Ptolemy unfortunately does not always bear this in mind, and it is sometimes difficult to distinguish what is due to him from that which he has borrowed from his predecessors.

Ptolemy then, in the first chapter, presupposing some preliminary notions on the part of the reader, announces that he will treat in order—what is the relation of the earth to the heavens, what is the position of the oblique circle (the ecliptic), and the situation of the inhabited parts of the earth; that he will point out the differences of climates; that he will then pass on to the consideration of the motion of the sun and moon, without which one cannot have a just theory of the stars; lastly, that he will consider the sphere of the fixed stars and then the theory of the five stars called "planets." All these things—i.e. the phenomena of the heavenly bodies—he says he will endeavour to explain in taking for principle that which is evident, real and certain, in resting everywhere on the surest observations and applying geometrical methods. He then enters on a summary exposition of the general principles on which his *Syntaxis* is based, and adduces arguments to show that the heaven is of a spherical form and that it moves after the manner of a sphere, that the earth also is of a form which is sensibly spherical, that the earth is in the centre of the heavens, that it is but a point in comparison with the distances of the stars, and that it has not any motion of translation. With respect to the revolution of the earth round its axis, which he says some have held, Ptolemy, while admitting that this supposition renders the explanation of the phenomena of the heavens much more simple, yet regards it as altogether ridiculous. Lastly, he lays down that there are two principal and different motions in the heavens—one by which all the stars are carried from east to west uniformly about the poles of the equator; the other, which is peculiar to some of the stars, is in a contrary direction to the former motion and takes place round different poles. These preliminary notions, which are all older than Ptolemy, form the subjects of the second and following chapters. He next proceeds to the construction of his table of chords, of which we have given an account, and which is indispensable to practical astronomy. The employment of this table presupposes the evaluation of the obliquity of the ecliptic, the knowledge of which is indeed the foundation of all astronomical science. Ptolemy in the next chapter indicates two means of determining this angle by observation, describes the instruments he employed for that purpose, and finds the same value which had already been found by Eratosthenes and used by Hipparchus. This "is followed by spherical geometry and trigonometry enough for the determination of the connexion between the sun's right ascension, declination and longitude, and for the formation of a table of declinations to each degree of longitude. Delambre says he found both this and the table of chords very exact."⁵

In book ii., after some remarks on the situation of the habitable parts of the earth, Ptolemy proceeds to make deductions from the principles established in the preceding book, which he does by means of the theorem of Menelaus. The length of the longest day being given, he shows how to determine the arcs of the horizon intercepted between the equator and the ecliptic—the amplitude of the eastern point of the ecliptic at the solstice—for different

³ Comte, *Système de politique positive*, iii. 324.

⁴ Cantor, *Vorlesungen über Geschichte der Mathematik*, p. 356.

⁵ De Morgan, in Smith's *Dictionary of Greek and Roman Biography*, s.v. "Ptolemaeus, Claudius."

degrees of obliquity of the sphere; hence he finds the height of the pole and reciprocally. From the same data he shows how to find at what places and times the sun becomes vertical and how to calculate the ratios of gnomons to their equinoctial and solstitial shadows at noon and conversely, pointing out, however, that the latter method is wanting in precision. All these matters he considers fully and works out in detail for the parallel of Rhodes. Theon gives us three reasons for the selection of that parallel by Ptolemy: the first is that the height of the pole at Rhodes is 36° , a whole number, whereas at Alexandria he believed it to be $30^\circ 58'$; the second is that Hipparchus had made at Rhodes many observations; the third is that the climate of Rhodes holds the mean place of the seven climates subsequently described. Delambre suspects a fourth reason, which he thinks is the true one, that Ptolemy had taken his examples from the works of Hipparchus, who observed at Rhodes and had made these calculations for the place where he lived. In chapter vi. Ptolemy gives an exposition of the most important properties of each parallel, commencing with the equator, which he considers as the southern limit of the habitable quarter of the earth. For each parallel or climate, which is determined by the length of the longest day, he gives the latitude, a principal place on the parallel, and the lengths of the shadows of the gnomon at the solstices and equinox. In the next chapter he enters into particulars and inquires what are the arcs of the equator which cross the horizon at the same time as given arcs of the ecliptic, or, which comes to the same thing, the time which a given arc of the ecliptic takes to cross the horizon of a given place. He arrives at a formula for calculating ascensional differences and gives tables of ascensions arranged by 10° of longitude for the different climates from the equator to that where the longest day is seventeen hours. He then shows the use of these tables in the investigation of the length of the day for a given climate, of the manner of reducing temporal¹ to equinoctial hours and vice versa, and of the nonagesimal point and the point of orientation of the ecliptic. In the following chapters of this book he determines the angles formed by the intersections of the ecliptic—first with the meridian, then with the horizon, and lastly with the vertical circle—and concludes by giving tables of the angles and arcs formed by the intersection of these circles, for the seven climates, from the parallel of Meroe (thirteen hours) to that of the mouth of the Borysthenes (sixteen hours). These tables, he adds, should be completed by the situation of the chief towns in all countries according to their latitudes and longitudes; this he promises to do in a separate treatise and has in fact done in his *Geography*.

Book iii. treats of the motion of the sun and of the length of the year. In order to understand the difficulties of this question Ptolemy says one should read the books of the ancients, and especially those of Hipparchus, whom he praises "as a lover of labour and a lover of truth" (*ἀνδρὶ φιλοπόνῳ τε ὁμοῦ καὶ φιλαληθείᾳ*). He begins by telling us how Hipparchus was led to discover the precession of the equinoxes; he relates the observations by which Hipparchus verified the eccentricity of the solar orbit imperfectly known to his Chaldaean predecessors, and gives the hypothesis of the eccentric by which he explained the inequality of the sun's motion. Ptolemy concludes this book by giving a clear exposition of the circumstances on which the equation of time depends. Ptolemy, moreover, applies Apollonius's hypothesis of the epicycle to explain the inequality of the sun's motion, and shows that it leads to the same results as the hypothesis of the eccentric. He prefers the latter hypothesis as more simple, requiring only one and not two motions, and as equally fit to clear up the difficulties. In the second chapter there are some general remarks to which attention should be directed. We find the principle laid down that for the explanation of phenomena one should adopt the simplest hypothesis that it is possible to establish, provided that it is not contradicted by the observations in any important respect.² This fine principle, which is of universal application, may, we think—regard being paid to its place in the *Almagest*—be justly attributed to Hipparchus. It is the first law of the "philosophia prima" of Comte.³ We find in the same page another principle, or rather practical injunction, that in investigations founded on observations where great delicacy is required we should select those made at considerable intervals of time in order that the errors arising from the imperfection which is inherent in all observations, even in those made with the greatest care, may be lessened by being distributed over a large number of years. In the same chapter we find also the principle laid down that the object of mathematicians ought to be to represent all the celestial phenomena by uniform and circular motions. This principle is stated by Ptolemy in the manner which is unfortunately too common with him—that is to say, he does not give the least indication whence he derived it. We know, however, from Simplicius, on the authority of Sosigenes,⁴ that Plato is said to have proposed the following

problem to astronomers: "What regular and determined motions being assumed would fully account for the phenomena of the motions of the planetary bodies?" We know, too, from the same source that Eudemos says in the second book of his *History of Astronomy* that "Eudoxus of Cnidus was the first of the Greeks to take in hand hypothesis of this kind,"⁵ that he was in fact the first Greek astronomer who proposed a geometrical hypothesis for explaining the periodic motions of the planets—the famous system of concentric spheres. It thus appears that the principle laid down here by Ptolemy can be traced to Eudoxus and Plato; and it is probable that they derived it from the same source, namely, Archytas and the Pythagoreans. We have indeed the direct testimony of Geminus of Rhodes that the Pythagoreans endeavoured to explain the phenomena of the heavens by uniform and circular motions.⁶

Books iv., v. are devoted to the motions of the moon, which are very complicated; the moon in fact, though the nearest to us of all the heavenly bodies, has always been the one which has given the greatest trouble to astronomers.⁷ Book iv., in which Ptolemy follows Hipparchus, treats of the first and principal inequality of the moon, which quite corresponds to the inequality of the sun treated of in the third book. As to the observations which should be employed for the investigation of the motion of the moon, Ptolemy tells us that lunar eclipses should be preferred, inasmuch as they give the moon's place without any error on the score of parallax. The first thing to be determined is the time of the moon's revolution; Hipparchus, by comparing the observations of the Chaldaeans with his own, discovered that the shortest period in which the lunar eclipses return in the same order was 126,007 days and 1 hour. In this period he finds 4267 lunations, 4573 restitutions of anomaly and 4612 tropical revolutions of the moon less $7\frac{1}{2}^\circ$ q.p.; this quantity ($7\frac{1}{2}^\circ$) is also wanting to complete the 345 revolutions which the sun makes in the same time with respect to the fixed stars. He concluded from this that the lunar month contains 29 days and $31' 50'' 8''' 20''$ of a day, very nearly, or 29 days 12 hours $44' 3'' 20''$. These results are of the highest importance. In order to explain this inequality, or the equation of the centre, Ptolemy makes use of the hypothesis of an epicycle, which he prefers to that of the eccentric. The fifth book commences with the description of the astrolabe of Hipparchus, which Ptolemy made use of in following up the observations of that astronomer, and by means of which he made his most important discovery, that of the second inequality in the moon's motion, now known by the name of the "evection." In order to explain this inequality he supposed the moon to move on an epicycle, which was carried by an eccentric whose centre turned about the earth in a direction contrary to that of the motion of the epicycle. This is the first instance in which we find the two hypotheses of eccentric and epicycle combined. The fifth book treats also of the parallaxes of the sun and moon, and gives a description of an instrument—called later by Theon the "parallactic rods"—devised by Ptolemy for observing meridian altitudes with greater accuracy.

The subject of parallaxes is continued in the sixth book of the *Almagest*, and the method of calculating eclipses is there given. The author says nothing in it which was not known before his time.

Books vii., viii. treat of the fixed stars. Ptolemy verified the fixity of their relative positions and confirmed the observations of Hipparchus with regard to their motion in longitude, or the precession of the equinoxes. The seventh book concludes with the catalogue of the stars of the northern hemisphere, in which are entered their longitudes, latitudes and magnitudes, arranged according to their constellations; and the eighth book commences with a similar catalogue of the stars in the constellations of the southern hemisphere. This catalogue has been the subject of keen controversy amongst modern astronomers. Some, as Flamsteed and Lalande, maintain that it was the same catalogue which Hipparchus had drawn up 265 years before Ptolemy, whereas others, of whom Laplace is one, think that it is the work of Ptolemy himself. The probability is that in the main the catalogue is really that of Hipparchus altered to suit Ptolemy's own time, but that in making the changes which were necessary a wrong precession was assumed. This is Delambre's opinion; he says, "Whoever may have been the true author, the catalogue is unique, and does not suit the age when Ptolemy lived; by subtracting $2^\circ 40'$ from all the longitudes it would suit the age of Hipparchus; this is all that is certain."⁸ It has been remarked that Ptolemy, living at Alexandria, at which city the altitude of the pole is 5° less than at Rhodes, where Hipparchus observed, could have seen stars which are not visible at Rhodes; none of these stars, however, are in Ptolemy's catalogue. The eighth book contains, moreover, a description of the milky way and the manner

¹ Καίρια, temporal or variable. These hours varied in length with the seasons; they were used in ancient times and arose from the division of the natural day (from sunrise to sunset) into twelve parts.

² *Alm.* ed. Halma, i. 159.

³ *Système de politique positive*, iv. 173.

⁴ This Sosigenes, as Th. H. Martin has shown, was not the astronomer of that name who was a contemporary of Julius Caesar, but a Peripatetic philosopher who lived at the end of the 2nd century.

⁵ Brandis, *Schol. in Aristot. editio acad. reg. borussica* (Berlin, 1836), p. 498.

⁶ *Εἰσαγωγή εἰς τὰ φαινόμενα*, c. i. in Halma's edition of the works of Ptolemy, vol. iii. ("Introduction aux phénomènes célestes, traduite du grec de Geminus," p. 9), Paris, 1819.

⁷ This has been noticed by Pliny, who says, "Multiformi haec (luna) ambage torsit ingenia contentplantium, et proximum ignorari maxime sidus indignantium" (*N.H.*, ii. 9).

⁸ Delambre, *Histoire de l'astronomie ancienne*, ii. 264.

of constructing a celestial globe; it also treats of the configuration of the stars, first with regard to the sun, moon and planets, and then with regard to the horizon, and likewise of the different aspects of the stars and of their rising, culmination and setting simultaneously with the sun.

The remainder of the work is devoted to the planets. The ninth book commences with what concerns them all in general. The planets are much nearer to the earth than the fixed stars and more distant than the moon. Saturn is the most distant of all, then Jupiter and then Mars. These three planets are at a greater distance from the earth than the sun.¹ So far all astronomers are agreed. This is not the case, he says, with respect to the two remaining planets, Mercury and Venus, which the old astronomers placed between the sun and earth, whereas more recent writers² have placed them beyond the sun, because they were never seen on the sun.³ He shows that this reasoning is not sound, for they might be nearer to us than the sun and not in the same plane, and consequently never seen on the sun. He decides in favour of the former opinion, which was indeed that of most mathematicians. The ground of the arrangement of the planets in order of distance was the relative length of their periodic times; the greater the circle, the greater, it was thought, would be the time required for its description. Hence we see the origin of the difficulty and the difference of opinion as to the arrangement of the sun, Mercury and Venus, since the times in which, as seen from the earth, they appear to complete the circuit of the zodiac are nearly the same—a year.⁴ Delambre thinks it strange that Ptolemy did not see that these contrary opinions could be reconciled by supposing that the two planets moved in epicycles about the sun; this would be stranger still, he adds, if it is true that this idea, which is older than Ptolemy, since it is referred to by Cicero,⁵ had been that of the Egyptians.⁶ It may be added, as strangest of all, that this doctrine was held by Theon of Smyrna,⁷ who was a contemporary of Ptolemy or somewhat senior to him. From this system to that of Tycho Brahe there is, as Delambre observes, only a single step.

We have seen that the problem which presented itself to the astronomers of the Alexandrian epoch was the following: it was required to find such a system of equable circular motions as would represent the inequalities in the apparent motions of the sun, the moon and the planets. Ptolemy now takes up this question for the planets; he says that "this perfection is of the essence of celestial things, which admit of neither disorder nor inequality," that this planetary theory is one of extreme difficulty, and that no one had yet completely succeeded in it. He adds that it was owing to these difficulties that Hipparchus—who loved truth above all things, and who, moreover, had not received from his predecessors observations either so numerous or so precise as those that he has left—had succeeded, as far as possible, in representing the motions of the sun and moon by circles, but had not even commenced the theory of the five planets. He was content, Ptolemy continues, to arrange the observations which had been made on them in a methodic order and to show thence that the phenomena did not agree with the hypotheses of mathematicians at that time. He showed that in fact each planet had two inequalities, which are different for each, that the retrogradations are also different, whilst other astronomers admitted only single inequality and the same retrogradation; he showed further that their motions cannot be explained by eccentrics nor by epicycles carried along concentrics, but that it was necessary to combine both hypotheses. After these preliminary notions he gives from Hipparchus the periodic motions of the five planets, together with the shortest times of restitutions, in which, moreover, he has made some slight corrections. He then gives tables of the mean motions in longitude and of anomaly of each of the five planets.⁸

¹ This is true of their mean distances; but we know that Mars at opposition is nearer to us than the sun.

² Eratosthenes, for example, as we learn from Theon of Smyrna.

³ Transits of Mercury and Venus over the sun's disk, therefore, had not been observed.

⁴ This was known to Eudoxus. Sir George Cornwall Lewis (*An Historical Survey of the Astronomy of the Ancients*, p. 155), confusing the geocentric revolutions assigned by Eudoxus to these two planets with the heliocentric revolutions in the Copernican system, which are of course quite different, says that "the error with respect to Mercury and Venus is considerable"; this, however, is an error not of Eudoxus but of Cornwall Lewis, as Schiaparelli has remarked.

⁵ "Hunc [solem] ut comites consequuntur Veneris alter, alter Mercurii cursus" (*Somnium Scipionis*, *De rep.* vi. 17). This hypothesis is alluded to by Pliny, *N.H.* ii. 17, and is more explicitly stated by Vitruvius, *Arch.* ix. 4.

⁶ Macrobius, *Commentarius ex Cicerone in somnium Scipionis*, i. 19.

⁷ Theon (Smyrnaeus Platonicus), *Liber de astronomia*, ed. Th. H. Martin (Paris, 1849), pp. 174, 294, 296. Martin thinks that Theon, the mathematician, four of whose observations are used by Ptolemy (*Alm.* ii. 176, 193, 194, 195, 196, ed. Halma), is not the same as Theon of Smyrna, on the ground chiefly that the latter was not an observer.

⁸ Delambre compares these mean motions with those of our modern tables and finds them tolerably correct. By "motion in

and shows how the motions in longitude of the planets can be represented in a general manner by means of the hypothesis of the eccentric combined with that of the epicycle. He next applies his theory to each planet and concludes the ninth book by the explanation of the various phenomena of the planet Mercury. In the tenth and eleventh books he treats, in like manner, of the various phenomena of the planets Venus, Mars, Jupiter and Saturn.

Book xii. treats of the stationary and retrograde appearances of each of the planets and of the greatest elongations of Mercury and Venus. The author tells us that some mathematicians, and amongst them Apollonius of Perga, employed the hypothesis of the epicycle to explain the stations and retrogradations of the planets. Ptolemy goes into this theory, but does not change in the least the theorems of Apollonius; he only promises simpler and clearer demonstrations of them. Delambre remarks that those of Apollonius must have been very obscure, since, in order to make the demonstrations in the *Almagest* intelligible, he (Delambre) was obliged to recast them. This statement of Ptolemy is important, as it shows that the mathematical theory of the planetary motions was in a tolerably forward state long before his time. Finally, book xiii. treats of the motions of the planets in latitude, also of the inclinations of their orbits and of the magnitude of these inclinations.

Ptolemy concludes his great work by saying that he has included in it everything of practical utility which in his judgment should find a place in a treatise on astronomy at the time it was written, with relation as well to discoveries as to methods. His work was justly called by him *Μαθηματικὴ σύνταξις*, for it was in fact the mathematical form of the work which caused it to be preferred to all others which treated of the same science, but not by "the sure methods of geometry and calculation." Accordingly, it soon spread from Alexandria to all places where astronomy was cultivated; numerous copies were made of it, and it became the object of serious study on the part of both teachers and pupils. Amongst its numerous commentators may be mentioned Pappus and Theon of Alexandria in the 4th century and Proclus in the 5th. It was translated into Latin by Boetius, but this translation has not come down to us. The *Syntaxis* was translated into Arabic at Bagdad by order of the enlightened caliph Al-Mamūn, who was himself an astronomer, about 827 A.D., and the Arabic translation was revised in the following century by Tobit ben Korra. The *Almagest* was translated from the Arabic into Latin by Gerard of Cremona (*q.v.*). In the 15th century it was translated from a Greek manuscript in the Vatican by George of Trebizond. In the same century an epitome of the *Almagest* was commenced by Purbaeh (d. 1461) and completed by his pupil and successor in the professorship of astronomy in the university of Vienna, Regiomontanus. The earliest edition of this epitome is that of Venice (1496), and this was the first appearance of the *Almagest* in print. The first complete edition of the *Almagest* is that of P. Liechtenstein (Venice, 1515)—a Latin version from the Arabic. The Latin translation of George of Trebizond was first printed in 1528, at Venice. The Greek text, which was not known in Europe until the 15th century, was first published in the 16th by Simon Grynaeus, who was also the first editor of the Greek text of Euclid, at Basel (1538). This edition was from a manuscript in the library of Nuremberg—where it is no longer to be found—which had been presented by Regiomontanus, to whom it was given by Cardinal Bessarion.

Other works of Ptolemy, which we now proceed to notice very briefly, are as follow. (1) *Φάσεις ἀπλανῶν ἀστέρων καὶ συναγωγὴ ἐπισημασίων*, *On the Apparitions of the Fixed Stars and a Collection of Prognostics*. It is a calendar of a kind common amongst the Greeks under the name of *παράπηγμα*, or a collection of the risings and settings of the stars in the morning or evening twilight, which were so many visible signs of the seasons, with prognostics of the principal changes of temperature with relation to each climate, after the observations of the best meteorologists, as, for example, Meton, Democritus, Eudoxus, Hipparchus, &c. Ptolemy, in order to make his *Parapegma* useful to all the Greeks scattered over the enlightened world of his time, gives the apparitions of the stars not for one parallel only but for each of the five parallels in which the length of the longest day varies from 13½ hours to 15½ hours—that is, from the latitude of Syene to that of the middle of the Euxine. This work was printed by Petavius in his *Uranologium* (Paris, 1630), and by Halma in his edition of the works of Ptolemy, vol. iii. (Paris, 1819). (2) *Ἐπιθέσεις τῶν πλανημένων ἢ τῶν οὐρανίων κίκλων κινήσεις*, *On the Planetary Hypothesis*. This is a summary of a portion of the *Almagest*, and contains a brief statement of the principal hypotheses for the explanation of the motions of the heavenly bodies. It was first published (Gr., Lat.) by Bainbridge, the Savilian professor of astronomy at Oxford, with the Sphere of Proclus and the *Κανὼν βασιλειῶν* (London, 1620), and afterwards by Halma, vol. iv. (Paris, 1820). (3) *Κανὼν βασιλειῶν*, *A Table of Reigns*. This is a chronological table of Assyrian, Persian, Greek and Roman sovereigns, with the length of their reigns, from Nabonassar to Antoninus Pius. This table (cf. G. Syncellus, *Chronogr.* ed. Dind. i. 388 seq.) was printed by Scaliger, Calvisius, Petavius, Bainbridge and by Halma,

longitude" must be understood the motion of the centre of the epicycle about the eccentric, and by "anomaly" the motion of the star on its epicycle.

vol. iii. (Paris, 1819). (4) Ἀρμονικῶν βιβλία γ'. This *Treatise on Music* was published in Greek and Latin by Wallis at Oxford (1682). It was afterwards reprinted with Porphyry's commentary in the third volume of Wallis's works (Oxford, 1699). (5) Τετραβιβλος οὐραγίς, *Tetrabiblon* or *Quadripartitum*. This work is astrological, as is also the small collection of aphorisms, called *Καπρός* or *Centiloquium*, by which it is followed. It is doubtful whether these works are genuine, but the doubt merely arises from the feeling that they are unworthy of Ptolemy. They were both published in Greek and Latin by Camerarius (Nuremberg, 1535), and by Melancthon (Basel, 1553). (6) *De analemmate*. The original of this work of Ptolemy is lost. It was translated from the Arabic and published by Commandine (Rome, 1552). The *Analemma* is the description of the sphere on a plane. We find in it the sections of the different circles, as the diurnal parallels, and everything which can facilitate the intelligence of gnomonics. This description is made by perpendiculars let fall on the plane; whence it has been called by the moderns "orthographic projection." (7) *Planisphaerium*, *The Planisphere*. The Greek text of this work also is lost, and we have only a Latin translation of it from the Arabic. The "planisphere" is a projection of the sphere on the equator, the eye being at the pole—in fact what is now called "stereographic" projection. The best edition of this work is that of Commandine (Venice, 1558). (8) *Optics*. This work is known to us only by imperfect manuscripts in Paris and Oxford, which are Latin translations from the Arabic. The *Optics* consists of five books, of which the fifth presents most interest: it treats of the refraction of luminous rays in their passage through media of different densities, and also of astronomical refractions, on which subject the theory is more complete than that of any astronomer before the time of Cassini. De Morgan doubts whether this work is genuine on account of the absence of allusion to the *Almagest* or to the subject of refraction in the *Almagest* itself; but his chief reason for doubting its authenticity is that the author of the *Optics* was a poor geometer. (G. J. A.)

The publication of a new edition of Ptolemy's works under the title, *Claudii Ptolemaei opera quae exstant omnia*, was recently undertaken at Leipzig. The first volume (in two parts, 1898, 1903) contains the Greek text of the *Almagest* edited by J. L. Heiberg. Consult also J. E. Montucla, *Histoire des mathématiques*, i. 293; J. B. J. Delambre, *Connaissance des temps* (1816); and *Histoire de l'astronomie ancienne*, vol. 2; J. J. A. Caussin, *Nouvelles mémoires de l'acad. des inscriptions*, t. vi.; P. Tannery, *Recherches sur l'histoire de l'astronomie ancienne*, ch. vi.-xv.; Narriue, *History of Astronomy* (1833); Fabricius, *Bibliotheca graeca*, ed. Harles, vol. 5; Halma's 1813-1816 edition of his *Almagest* (Greek with French translation); A. Berry, *A Short History of Astronomy*, pp. 62-73; *British Museum Catalogue*.

Geography.

Ptolemy is hardly less celebrated as a geographer than as an astronomer, and his *Geographikē syntaxis* exercised as great an influence on geographical progress (especially during the period of the Classical Renaissance), as did his *Almagest* on astronomical. This exceptional position was largely due to its scientific form, which rendered it convenient and easy of reference; but, apart from this, it was really the most considerable attempt of the ancient world to place the study of geography on a scientific basis. The astronomer Hipparchus had indeed pointed out, three centuries before Ptolemy, that the only way to construct a trustworthy map of the inhabited world would be by observations of the latitude and longitude of all the principal points on its surface. But the materials for such a map were almost wholly wanting, and, though Hipparchus made some approach to a correct division of the known world into zones of latitude, "climates" or *klimata*, as he termed them, trustworthy observations of latitude were then very few, while the means of determining longitudes hardly existed. Hence probably it arose that no attempt was made to follow up the suggestion of Hipparchus until Marinus of Tyre, who lived shortly before Ptolemy, and whose work is known to us only through the latter. Marinus' scientific materials being inadequate, he contented himself mostly with determinations derived from itineraries and other rough methods, such as are still employed where more accurate means of determination are not available. The greater part of Marinus' treatise was occupied with the discussion of his authorities, and it is impossible, in the absence of the original work, to decide how far his results attained a scientific form. But Ptolemy himself considered them, on the whole, so satisfactory that he made his predecessor's work the basis of his own in regard to all the Mediterranean countries, that is, in regard to almost all those regions of which he had definite knowledge. In the more remote regions of the world, Ptolemy availed himself of

Marinus' information, but with reserve, and himself explains the reasons that induced him sometimes to depart from his predecessor's conclusions. It is unjust to term Ptolemy a plagiarist from Marinus, as he himself fully acknowledges his obligations to that writer, from whom he derived the whole mass of his materials, which he undertook to arrange and present to his readers in a scientific form. It is this form, unique among those ancient geographical treatises which have survived, that constitutes one great merit of Ptolemy's work. At the same time it shows the increased knowledge of Asia and Africa acquired since Strabo and Pliny.

1. *Mathematical Geography*.—As an astronomer, Ptolemy was of course better qualified to explain the mathematical conditions of the earth and its relations to the celestial bodies than most preceding geographers. His general views had much in common with those of Eratosthenes and Strabo. Thus he assumed that the earth was a globe, the surface of which was divided by certain great circles—the equator and the tropics—parallel to one another, dividing the earth into five zones, the relations of which with astronomical phenomena were of course clear to his mind as a matter of theory, though in regard to the regions bordering on the equator, as well as to those adjoining the polar circle, he could have had no confirmation of his conclusions from actual observation. He adopted also from Hipparchus the division of the equatorial circle into 360 parts (*degrees*, as they were subsequently called, though the word does not occur in this sense in Ptolemy), and supposed other circles to be drawn through this, from the equator to the pole, to which he gave the name of *meridians*. He thus, like modern geographers, conceived the whole surface of the earth as covered with a network of *parallels of latitude* and *meridians of longitude*, terms which he himself was the first extant writer to employ in this technical sense. Within the network thus constructed it was his task to place the outline of the world, so far as known to him.

But at the very outset of his attempt he fell into an error vitiating all his conclusions. Eratosthenes (276-196 B.C.) was the first who had attempted scientifically to determine the earth's circumference, and his result of 250,000 (or 252,000) stadia, *i.e.* 25,000 (25,200) geographical miles, was generally adopted by subsequent geographers, including Strabo. Poseidonius, however (*c.* 135-50 B.C.), reduced this to 180,000, and the latter computation was inexplicably adopted by Marinus and Ptolemy. This error made every degree of latitude or longitude (measured at the equator) equal to only 500 stadia (50 geographical miles), instead of its true equivalent of 600 stadia. The mistake would have been somewhat neutralized had there existed a sufficient number of points of which the position was fixed by observation; but we learn from Ptolemy himself that such observations for latitude were very few, while the means of determining longitudes were almost wholly wanting.¹ Hence the positions laid down by him were, with few exceptions, the result of computations from itineraries and the statements of travellers, liable to much greater error in ancient times than at the present day, from the want of any accurate mode of observing bearings, of measuring time (by portable instruments), or of estimating distances at sea, except by the rough estimate of the time employed in sailing from point to point. Even the use of the log was unknown to the ancients. But, great as were the errors resulting from such imperfect means of calculation, they were increased by the permanent error arising from Ptolemy's system of graduation. Thus if he concluded (from itineraries) that two places were 5000 stadia distant, he would place them 10° apart, and thus in fact separate them by 6000 stadia.

Another source of permanent error (though of less importance), which affected all his longitudes, arose from his prime meridian. Here also he followed Marinus, who, supposing that the Fortunate Islands (vaguely answering to our Canaries plus the Madeira group) lay farther west than any part of Europe or Africa, had taken the meridian through the (supposed) outermost of this group as his prime meridian, from whence he calculated his longitudes eastwards to the Indian Ocean. But as both Marinus and Ptolemy had no exact knowledge of the islands in question, the line thus assumed was purely imaginary, drawn through the supposed position of an island which they placed 2½° (instead of 9° 20') west of the Sacred Promontory (*i.e.* Cape St Vincent, regarded by Marinus and Ptolemy, as by previous geographers, as the westernmost point of Europe). Hence all Ptolemy's longitudes, reckoned eastwards, were about 7° less than they would have been if really measured from the meridian of Ferro, which continued so long in use. This error was the more unfortunate as the longitude was really calculated, not from this imaginary line, but from Alexandria, westwards as well as eastwards (as Ptolemy himself has done in his eighth book), and afterwards reversed, so as to suit the supposed method of computation.

¹ Hipparchus pointed out the mode of determining longitudes by observations of eclipses, but the instance to which he referred (of the celebrated eclipse before the battle of Arbela, which was also seen at Carthage) was a mere matter of popular observation, of no scientific value. Yet Ptolemy seems to have known of no other.

The equator was in like manner placed by Ptolemy at a considerable distance from its true geographical position. The place of the equinoctial line was well known to him as a matter of theory, but as no observations could have been made in those regions he could only calculate its place from that of the tropic, which he supposed to pass through Syene. And as he here, as elsewhere, reckoned a degree of latitude as equivalent to 500 stadia, he inevitably made the interval between the tropic and the equator too small by one-sixth; and the place of the former being fixed by observation, he necessarily carried up the supposed place of the equator too high by more than 230 geographical miles. But as he had practically no geographical acquaintance with the equinoctial regions this error was of little importance.

With Marinus and Ptolemy, as with preceding Greek geographers, the most important line for practical purposes was the parallel of 36° N., which, passing through the Straits of Gibraltar, Rhodes Island and the Gulf of Issus, and thus dividing the Mediterranean (as Dicaearchus and his successors usually regarded it) into two, was continued in theory along the chain of Mt Taurus till it joined the mountains north of India; thence to the Eastern Ocean it was regarded as constituting the dividing line of the inhabited world, along which the length of the latter must be measured. But so inaccurate were the observations and so imperfect the materials at command, even in regard to the best known regions, that Ptolemy, following Marinus, describes this parallel as passing through Caralis in Sardinia and Lilybaeum in Sicily, the one being really in 39° 12' lat., the other in 37° 50'. Still more strangely he places Carthage 1° 20' south of the dividing parallel, while it really lies nearly 1° north of it.

The problem that had especially attracted the attention of geographers from Dicaearchus to Ptolemy was to determine the length and breadth of the inhabited world. This question had been fully discussed by Marinus, who had arrived at conclusions widely different from his predecessors. Towards the north, indeed, there was no great difference of opinion, the latitude of Thule being generally recognized as that of the highest northern land, and this was placed both by Marinus and Ptolemy in 63° N., not far beyond the true position of the Shetland Islands, which had come to be generally identified with the mysterious Thule of Pytheas. The western extremity, as already mentioned, had been in like manner determined by the prime meridian drawn through the supposed position of the outermost of the Fortunate Islands. But towards the south and east Marinus gave an enormous extension to Africa and Asia, beyond what had been known to or suspected by earlier geographers, and, though Ptolemy reduced Marinus' calculations, he retained an exaggerated estimate of their results.

The additions thus made to the estimated dimensions of the known world were indeed in both directions based upon a real extension of knowledge, derived from recent information; but the original statements were so perverted by misinterpretation as to give results (in map-construction) differing widely from the truth. The southern limit of the world had been fixed by Eratosthenes and even by Strabo at the parallel which passed through the eastern extremity of Africa (Cape Guardafui), the Cinnamon Region (Somaliland) and the country of the Sembritaë (Sennaar). This parallel, which would correspond nearly to that of 10° of true latitude, they supposed to be situated at a distance of 3400 stadia (340 geographical miles) from that of Meroë (the position of which was pretty accurately known) and 13,400 to the south of Alexandria; while they conceived it as passing eastward through Taprobane (Ceylon, often Ceylon *plus* Sumatra?), universally recognized as the southernmost land of Asia. Both these geographers were ignorant of the vast extension of Africa to the south of this line and even of the equator, and conceived it as trending away west from the Cinnamon Land and then north-west to the Straits of Gibraltar. Marinus had, however, learned from itineraries both by land and sea the fact of this extension, of which he had conceived so exaggerated an idea that even after Ptolemy had reduced it by more than half it was still much in excess of the truth. The eastern coast of Africa was indeed tolerably well known, being frequented by Greek and Roman traders, as far as a place called Rhapta (opposite to Zanzibar?), placed by Ptolemy not far from 7° S. To this he added a bay extending to Cape *Prasum* (Delgado?), which he placed in 15½° S. At the same time he assumed the position in about the same parallel of a region called *Agisymba*, inhabited by Ethiopians and abounding in rhinoceroses, which was supposed to have been discovered by a Roman general, Julius Maternus, whose itinerary was employed by Marinus. Taking, therefore, this parallel as the limit of knowledge to the south, while he retained that of Thule to the north, Ptolemy assigned to the inhabited world a breadth of nearly 80°, instead of less than 60°, as in Eratosthenes and Strabo.

It had been a common belief among Greek geographers, from the earliest attempts at scientific geography, not only that the length of the inhabited world greatly exceeded its breadth, but that it was more than twice as great, an unfounded assumption to which their successors seem to have felt themselves bound to conform. Thus Marinus, while extending his Africa unduly southward, exaggerated Asia still more grossly eastward. Here also he really possessed a great advance in knowledge over all his predecessors, the silk trade with China having led to an acquaintance, though of

a vague and general kind, with regions east of the Pamir and Tian Shan, the limits of Asia as previously known to the Greeks. Marinus had learned that traders proceeding eastward from the Stone Tower (near the Pamir?) to Sera, the capital of the Seres (inland China?), occupied seven months on the journey; thence he calculated that the distance between the two points was 36,200 stadia or 3620 geographical miles. Ptolemy, while he points out the erroneous mode of computation on which this conclusion was founded, could not correct it by any real authority, and hence reduced it summarily by one half. He therefore placed Sera (Singanfu?), the easternmost point on his map of Asia, 45½° from the Stone Tower, which again he fixed, on the authority of itineraries cited by Marinus, at 24,000 stadia or 60° of longitude from the Euphrates, reckoning in both cases a degree of longitude (in this latitude) as equivalent to 400 stadia. Both distances were greatly in excess, independently of error arising from graduation. The distances west of the Euphrates were of course comparatively well known, nor did Ptolemy's calculation of the length of the Mediterranean differ very materially from those of previous Greek geographers, though still greatly exceeding the truth, after allowing for the permanent error of graduation. This last, it must be remembered, would be cumulative, the longitudes being computed from a fixed point in the west, instead of being reckoned east and west from Alexandria, which was undoubtedly the mode in which they were really calculated. These causes of error combined to make Ptolemy allow 180° long., or 12 hours' interval, between the Fortunate Islands meridian and Sera (really about 130°).

But in thus estimating the length and breadth of the known world, Ptolemy attached a very different sense to these terms from that which they had generally borne. Most earlier Greek geographers and "cosmographers" supposed the inhabited world to be surrounded on all sides by sea, and to form a vast island in the midst of a circumfluous ocean. This notion (perhaps derived from the Homeric "ocean stream," and certainly not based upon direct observation) was nevertheless in accordance with truth, great as was the misconception involved of the continents included. But Ptolemy in this respect went back to Hipparchus, and assumed that the land extended indefinitely north in the case of eastern Europe, east, south-east and north in that of Asia, and south, south-west and south-east in that of Africa. His boundary line was in each of these cases an arbitrary limit, beyond which lay the Unknown Land, as he calls it. But in Africa he was not content with this extension southward; he also prolonged the continent eastward from its southernmost known point, so as to form a connexion with south-east Asia, the extent and position of which he wholly misconceived.

In this last case Marinus derived from the voyages of recent navigators in the Indian seas a knowledge of extensive lands hitherto unknown to the Hellenic-Roman world, and Ptolemy acquired more information in this quarter. But he formed a false conception of the bearings of the coasts thus made known, and of the position of the lands to which they belonged, and, instead of carrying the line of coast northwards from the Golden Chersonese (Malay Peninsula) to the Land of the Sinae (sea-coast China), he brought it down again towards the south after forming a great bay, so that he placed Cattigara—the principal emporium in this part of Asia, and the farthest point known to him—on a supposed coast of unknown extent, but with a direction from north to south, and facing west. The hypothesis that this land was continuous with southernmost Africa, so as to enclose the Indian Ocean as one vast lake, though a mere assumption, is stated by him as definitely as if based upon positive information. It must be noticed that Ptolemy's extension of Asia eastwards, so as to diminish by 50° of longitude the interval between easternmost Asia and westernmost Europe, fostered Columbus' belief that it was possible to reach the former from the latter by direct navigation, crossing the Atlantic.

Ptolemy's errors respecting distant regions are one thing; it is another thing to discover, in regard to the Mediterranean basin, the striking imperfections of his geographical knowledge. Here he had indeed some well-established data for latitudes. That of Massilia had been determined, within a few miles, by Pytheas, and those of Rome, Alexandria and Rhodes were approximately known, all having been observation-centres for distinguished astronomers. The fortunate accident that Rhodes lay on the same parallel with the Straits of Gibraltar enabled Ptolemy to connect the two ends of the Inland Sea on the famous parallel of 36° N. Unfortunately Ptolemy, like his predecessors, supposed its course to lie almost uniformly through the open sea, ignoring the great projection of Africa towards the north from Carthage westward. The erroneous position assigned to Carthage being supposed to rest upon astronomical observation, doubtless determined that of all North Africa. Thus Ptolemy's Mediterranean, from Massilia to the opposite point of Africa, had a width of over 11° of latitude (really 6½°). He was still more at a loss in respect of longitudes, for which he had no trustworthy observations; yet he came nearer the truth than previous geographers, all of whom had greatly exaggerated the length of the Inland Sea. Their calculations, like those of Marinus and Ptolemy, could only be founded on the imperfect estimates of mariners; and Ptolemy, in translating these conclusions into scientific form, vitiated his results by his system of

graduation. Thus while Marinus calculated 24,800 stadia as the length of the Mediterranean from the Straits to the Gulf of Issus, this was stated by Ptolemy at 62°, or about 20° too much. Even after correcting the error due to his computation of 500 stadia to a degree, there remains an excess of nearly 500 geographical miles.

Another error which disfigured the eastern portion of Ptolemy's Mediterranean map was the position of Byzantium, which Ptolemy (misled by Hipparchus) placed in the same latitude with Massilia, thus carrying it up more than 2° above its true position. This pushed the whole Euxine—with whose general form and dimensions he was fairly well acquainted—too far north by the same amount; besides this he enormously exaggerated the extent of the Palus Maeotis (the Sea of Azov), which he also represented as having its direction from south to north; by the combined effect of these two errors he carried up its northern extremity (with the Tanais estuary and city) as high as 54° 30' (the true south shore of the Baltic). Ptolemy, however, was the first writer of antiquity who showed some conception of the relations between the Tanais or Don (usually considered by the ancients as the boundary between Europe and Asia) and the Rha or Volga, which he correctly described as flowing into the Caspian. He was also the first geographer after Alexander to return to the correct view (found in Herodotus and Aristotle) that the Caspian was an inland sea, without communication with the ocean.

As to north Europe, Ptolemy's views were vague and imperfect. He had indeed more acquaintance with the British Islands than any previous geographer, and showed a remarkable knowledge of certain British coast-lines. But he (1) placed Ireland (*Ivernia*) farther north than any part of Wales, and (2) twisted round the whole of Scotland, so as to make its length from west to east and to place the northern extremities of Britain and Ireland almost on the same parallel. These errors are probably connected and are naturally accompanied by the placing of Thule, the Orkneys (*Orkades*) and the Hebrides (*Ebudae*) indiscriminately on the left or north of Caledonia. Here he was perhaps embarrassed by adopting Marinus' conclusion that Thule lay in 63° N., while regarding it, like earlier geographers, as the northernmost of all lands. Ptolemy also supposed the northern coast of Germany, beyond the Cimbric Chersonese (Denmark), to be the southern shore of the Northern Ocean, with a general direction from west to east. Of the almost wholly landlocked Baltic he was entirely ignorant, as well as of the Scandinavian Peninsula; his Scandia is an island smaller than Corsica, lying in the true position of southern central Sweden. Some way east of the Vistula, Ptolemy, however, makes the Sarmatian coast trend north, to the parallel of Thule; nor did he conceive this as an actual limit, but believed the Unknown Land to extend indefinitely in this direction as also to the north of Asiatic Scythia.

As to the latter region, vague and erroneous as were his views concerning this enormous tract from Sarmatia to China, they show an advance on those of earlier geographers. Ptolemy was the first who had anything like a clear idea of the great north-and-south dividing range of Central Asia (the Pamir and Tian Shan), which he called Imaus, placing it nearly 40° too far east, and making it divide Scythia into two portions (Within Imaus and Beyond Imaus), somewhat corresponding to Russian and Chinese Central Asia. Ptolemy also applies the term Imaus to a section of the backbone range which in his system crosses Asia from west to east. This section lies east of the Indian Caucasus, and forms an angle with the other Imaus running north.

On the southern shores of Asia Ptolemy's geography is especially faulty, though he shows a greatly increased general knowledge of these regions. For more than a century the commercial relations between western India and Alexandria, the chief eastern emporium of the Roman Empire, had become more important and intimate than ever before. The tract called the *Periplus of the Erythraean Sea*, about A.D. 80, contains sailing directions for merchants from the Red Sea to the Indus and Malabar, and even indicates that the coast from Barygaza (Baroch) had a general southward direction down to and far beyond Cape Komari (Comorin), which, taken together with its account of the shore-line as far as the Ganges, affords some suggestions at least of a peninsular character for south India. But Ptolemy, following Marinus, not only gives to the Indian coasts, from Indus to Ganges, an undue extension in longitude, but practically denies anything of an Indian peninsula, placing capes Komaria and Kory (his southernmost points in India) only 4° S. of Barygaza, the real interval being over 800 geographical miles, or, according to Ptolemy's system of graduation, 16° of latitude. This error, distorting the whole appearance of south Asia, is associated with another as great, but of opposite tendency, in regard to Taprobane (in which ancient ideas of Ceylon and Sumatra are confusedly mingled). The size of this was exaggerated by most earlier Greek geographers; but Ptolemy extended it through 15° of latitude and 12° of longitude, so as to make it about fourteen times as large as the reality, and bring down its southern extremity more than 2° south of the equator.

Similar distortions in regions beyond the Ganges, concerning which Ptolemy is our only ancient authority, are less surprising. Between the date of the *Periplus* and that of Marinus it seems probable that Greek mariners had not only crossed the Gangetic gulf and visited the land on the opposite side, which they called the

Golden Chersonese, but pushed considerably farther east, to Cattigara. But these commercial voyagers either brought back inaccurate notions, or Ptolemy's preconceptions destroyed the value of the new information, for nowhere does he distort the truth more wildly. After passing the Great Gulf, beyond the Golden Chersonese, he makes the coast trend southward, and thus places Cattigara (perhaps one of the south China ports) 8½° south of the equator. In this he was perhaps influenced by his notion of a junction of Asia and Africa in a *terra incognita* south of the Indian Ocean.

In regard to West Africa, we may notice that he conceives this coast as running almost due north and south to 10° N., and then (after forming a great bay) as bending away to the unknown southwest. Though the Fortunate Islands were so important to his system as his prime meridian, he was entirely misinformed about them, and extended the group through more than 5° of latitude, so as to bring down the most southerly of them to the real parallel of the Cape Verde Islands.

In regard to the mathematical construction or projection of his maps, not only was Ptolemy greatly in advance of all his predecessors, but his theoretical skill was altogether beyond the nature of the materials to which he applied it. The methods by which he obviated the difficulty of transferring the delineation of different countries from the spherical surface of the globe to the plane surface of an ordinary map differed little from those in use at the present day, and the errors arising from this cause (apart from those produced by his fundamental error of graduation) were really of little consequence compared with the defective character of his information and the want of anything approaching to a survey of the countries delineated. He himself was well aware of his deficiencies in this respect, and, while giving full directions for the scientific construction of a general map, he contents himself, for the special maps of different countries, with the simple method employed by Marinus of drawing the parallels of latitude and meridians of longitude as straight lines, assuming in each case the proportion between the two, as it really stood with respect to some one parallel towards the middle of the map, and neglecting the inclinations of the meridians to one another. Such a course, as he himself repeatedly affirms, will not make any material difference within the limits of each special map.

Ptolemy especially devoted himself to the mathematical branch of his subject, and the arrangement of his work, in which his results are presented in a tabular form, instead of being at once embodied in a map, was undoubtedly designed to enable the student to construct his maps for himself. This purpose it has abundantly served, and there is little doubt that we owe to the peculiar form thus given to his results their transmission in a comparatively perfect condition to the present day. Unfortunately the specious appearance of these results has led to the belief that what was stated in so scientific a form must necessarily be based upon scientific observations. Though Ptolemy himself has distinctly pointed out in his first book the defective nature of his materials, and the true character of the data furnished by his tables, few readers studied this portion of his work, and his statements were generally received with undoubting faith. It is only in modern times that his apparently scientific work has been shown to be in most cases a specious edifice resting upon no adequate foundations.

There can be no doubt that the work of Ptolemy was from the time of its first publication accompanied with maps, which are regularly referred to in the eighth book. But how far those which are now extant represent the original series is a disputed point. In two of the most ancient MSS. it is expressly stated that the maps which accompany them are the work of one Agathodaemon of Alexandria, who "drew them according to the eight books of Claudius Ptolemy." This expression might equally apply to the work of a contemporary draughtsman under the eyes of Ptolemy himself, or to that of a skilful geographer at a later period, and nothing is known from any other source concerning this Agathodaemon. The attempt to identify him with a grammarian of the same name who lived in the 5th century is wholly without foundation. But it appears, on the whole, most probable that the maps appended to the MSS. still extant have been transmitted by uninterrupted tradition from the time of Ptolemy.

2. *Progress of Geographical Knowledge in Certain Special Regions.*—Ptolemy records, after Marinus, the penetration of Roman expeditions to the land of the Ethiopians and to Agisymba, clearly some region of the Sudan beyond the Sahara desert, perhaps the basin of Lake Chad. But while this name was the only recorded result of these expeditions, Ptolemy also gives much other information concerning the interior of North Africa (whence derived we know not) to which nothing similar is found in any earlier writer. Unfortunately this new information was of so crude a character, and is presented in so embarrassing a form, as to perplex rather than assist. Thus Ptolemy's statements concerning the rivers Gir and Nigir, and the lakes and mountains with which they were connected, have baffled successive generations of interpreters. It may safely be said that they present no resemblance to the real features of the country as now known, and cannot be reconciled with them except by arbitrary conjecture.

As to the Nile, both Greeks and Romans had long endeavoured to discover the sources of this river, and an expedition sent out for that purpose by the emperor Nero had undoubtedly penetrated as far

as the marshes of the White Nile in about 9° N. Ptolemy's statement that the Nile derived its waters from two streams which rose in two lakes a little south of the equator was nearer the truth than any of the theories concocted in modern times before the discovery of the Victoria and Albert Nyanza. In connexion with this subject he introduces a range of mountains running from east to west, which he calls the Mountains of the Moon, and which, however little understood by Ptolemy, may be considered to represent in a measure the fact of the alpine highlands now known to exist in the neighbourhood of the Nyanzas and in British and German East Africa (Ruwenzori, Kenya, Kilimanjaro, &c.).

In Asia, as in Africa, Ptolemy had obtained, as we have seen, a vague, sometimes valuable, often misleading, half-knowledge of extensive regions, hitherto unknown to the Mediterranean world, and especially of Chinese Asia and its capital of Sera (Singanfu). North of the route leading to this far eastern land (supposed by Ptolemy to be nearly coincident with the parallel of 40°) lay a vast region of which apparently he knew nothing, but which he vaguely assumed to extend indefinitely northwards as far as the limits of the Unknown Land. The Jaxartes, which since Alexander had been the boundary of Greek geography in this direction, was still the northern limit of all that was really known of Central Asia. Beyond that Ptolemy places many tribes, to which he could assign no definite locality, and mountain ranges which he could only place at hazard. As to south-east Asia, in spite of his misplacement of Cattigara and the Sinae or Thinae, we must recognize in the latter name a form of China; from the Sinae being placed immediately south of the Seres, it is possible that Ptolemy was aware of the connexion between the two—the Chinese coast known only by maritime voyages, and inland China, known only by continental trade.

As to Mediterranean countries, we have seen that Ptolemy professed (in the main) to follow Marinus; the latter, in turn, largely depended on Timosthenes of Rhodes (*fl.* c. 260 B.C.), the admiral of Ptolemy Philadelphus, as to coasts and maritime distances. Claudius Ptolemy, however, introduced many changes in Marinus' results, some of which he has pointed out though there are doubtless many others which we have no means of detecting. For the interior of the different countries Roman roads and itineraries must have furnished both Marinus and Ptolemy with a mass of valuable materials. But neither seems to have taken full advantage of these; and the tables of the Alexandrian geographer abound with mistakes—even in countries so well known as Gaul and Spain—which might easily have been obviated by a more judicious use of such Roman authorities.

In spite of the merits of Ptolemy's geographical work it cannot be regarded as a complete or satisfactory treatise upon the subject. It was the work of an astronomer rather than a geographer. Not only did its plan exclude all description of the countries with which it dealt, their climate, natural productions, inhabitants and peculiar features, but even its physical geography proper is treated in an irregular and perfunctory manner. While Strabo was fully alive to the importance of the rivers and mountain chains which (in his own phrase) "geographize" a country, Ptolemy deals with this part of his subject in so careless a manner as to be often worse than useless. In Gaur, for instance, the few notices he gives of the rivers that play so important a part in its geography are disfigured by some astounding errors; while he does not notice any of the great tributaries of the Rhine, though mentioning an obscure streamlet, otherwise unknown, because it happened to be the boundary between two Roman provinces.

BIBLIOGRAPHY.—Ptolemy's *Geographia* was printed for the first time in a Latin translation, accompanied with maps, in 1462(?), and numerous other editions followed in the latter part of the 15th and earlier half of the 16th centuries, but the Greek text did not make its appearance till 1533, when it was published at Basel in quarto, edited by Erasmus. All these early editions, however, swarm with textual errors, and are critically worthless. The same may be said of the edition of P. Bertius (Gr. and Lat., Leiden, 1618, typ. Elzevir), which was long the standard library edition. It contains a new set of maps drawn by Mercator, as well as a fresh series (not intended to illustrate Ptolemy) by Ortelius, the Roman Itineraries, including the *Tabula Peutingeriana*, and much other miscellaneous matter. The first attempt at a really critical edition was made by F. G. Wilberg, and C. H. F. Grashof (4to, Essen, 1838–1845), but this only covered the first six books of the entire eight. The edition of C. F. A. Nobbe (3 vols., 18mo., Leipzig, 1843), presents the best Greek text of the whole work, and has a useful index. The best edition, so far as completed, is that published in A. F. Didot's *Bibliotheca graecorum scriptorum* (*Claudii Ptolemaei geographia*; 2 vols., Paris, 1883 and 1901), originally edited by Carl Müller and continued by C. T. Fischer, with a Latin translation and a copious commentary, geographical as well as critical. See also, F. C. L. Sickler, *Claudii Ptolemaei Germania* (Hesse Cassel, 1833); W. D. Cooley, *Claudius Ptolemy and the Nile* (London, 1854); J. W. McCrindle, *Ancient India described by Ptolemy* (Bombay, 1885), reprinted from *Indian Antiquary* (1884); Henry Bradley, "Ptolemy's Geography of the British Isles," in *Archaeologia*, vol. xlvi. (1885); T. G. Rylands, *Geography of Ptolemy Elucidated* (Dublin, 1893); and a Polish study of Ptolemy's Germany and Sarmatia, in

the Historical-Philosophical Series (2) of the Cracow University (1902), vol. xvi. (E. H. B.; C. R. B.)

PTOMAINÉ POISONING (Gr. πῶμα, corpse), a phrase now popularized in the sense of a certain class of food-poisoning. The word "ptomaine" was invented by the Italian chemist Selmi for the basic substances produced in putrefaction. They belong to several classes of chemical compounds. (See **MEDICAL JURISPRUDENCE**.)

PUBERTY (Lat. *pubertas*, from *pubes*, *puber*, mature, adult), that period of life at which the generative organs in both sexes become functionally active (see **REPRODUCTIVE SYSTEM**). In northern countries males enter upon sexual maturity between fourteen and sixteen, sometimes not much before the eighteenth year, females between twelve and fourteen. In tropical climates puberty is much earlier. In English common law the age of puberty is conclusively presumed to be fourteen in the male and twelve in the female. Puberty is of much ethnological interest, as being the occasion among many races for feasts and religious ceremonies. In Rome a feast was given to the family and friends: the hair of boys was cut short, a lock being thrown into the fire in honour of Apollo, and one into water as an offering to Neptune. Girls offered their dolls to Venus, and the *bullæ*—a little locket of gold worn round children's necks, often by boys as well as girls—was taken off and dedicated in the case of the former to Hercules or the household lares, in the case of the latter to Juno. The attainment of puberty is celebrated by savages with ceremonies some of which seem to be directly associated with totemism. The Australian rites of initiation include the raising of those scars on the bodies of clansmen or clanswomen which serve as tribal badges or actually depict the totem. Among many savage peoples lads at puberty undergo a pretence of being killed and brought to life again.

PUBLICANI, literally men employed "in connexion with the revenue," (*publicum*, from *populus*, people), or possibly "in the public service," the name given in ancient Rome to a body of men who either hired state property or monopolies for a certain period, during which they could farm such property to their own profit, or bought of the state for a fixed sum the right to farm for a term of years the taxes due to the treasury from the public land in Italy (see **AGRARIAN LAWS**) or the land held by Roman subjects in the provinces. In very early times the senate entrusted to officials appointed for the purpose the control of the sale of salt (Livy ii. 9); and it was a natural development from this that the state, instead of appointing officials to manage its monopolies, should let out those monopolies to individuals. A regular system was soon established by which the censor, who held office every fifth year, placed all the sources of public revenue in the hands of certain individuals or companies, who on payment of a fixed sum into the treasury, or on giving adequate security for such payment, received the right to make what profit they could out of the revenues during the five years that should elapse before the next censorship. The assignment was made to the highest bidder at a public auction held by the censor. The same system was applied to the public works, the *publicanus* (or company) in this case being paid a certain sum, in return for which he took entire charge of a certain department of the public works, and winning his appointment by making the lowest tender. That this system was well established at the time of the Second Punic War is assumed in Livy's account of the various offers made by the wealthier class of citizens to relieve the exhausted treasury after the battle of Cannae. On the one hand we have companies offering a price for branches of the revenue which was calculated rather to meet the needs of the state than to ensure any profit for themselves (Livy xxiii. 49). On the other hand individuals are represented as undertaking the management of public works on the understanding that they will expect no payment until the conclusion of the war (*ibid.* xxiv. 18).

In very early times the *publicani* may have been men closely connected with the government. But since wealth was a necessary qualification for the post, and wealth at Rome became more and more confined to the commercial class, the *publicani* became

identical with the leading representatives of the class of capitalists and traders. This class was always distinct at Rome from the hereditary nobility which monopolized the government of the state, and members of the senatorial class were excluded from it by definite enactment (see SENATE). Although common interest was strong enough to secure for the government in time of external danger the loyal support of the commercial class, yet after the close of the great wars a market hostility grew up between it and the government.

The extension of the Roman system of tax-farming to the provinces did not at first increase the importance of the *publicani* in Italy; for in the earlier provinces, in which the collection of the revenues was put up to auction in the province itself, the *publicani* were generally natives. But C. Gracchus, who carried a law that the taxes of the new province of Asia should be put up to auction by the censor in Rome, gave to the Roman capitalists an opportunity of greatly extending their financial operations and thus in a short time of securing important political powers. It was in their capacity of *publicani* in the wealthiest provinces that the capitalist or equestrian *judices* (see EQUITES) became a menace to the provincial governors who represented the senatorial power. Cicero often applies the name *publicani* to the whole order; and on the various occasions when the demands of the equestrian party determined the policy of the state we can clearly trace the interests of the *publicani*, who were involved in an infinite number of commercial and financial transactions in the provinces, as the motive of its action. Thus the cruel fate of the Roman business men in Cirta led the capitalist class to force the Jugurthine War upon the senate in 112 B.C.; the disorganization of Asiatic commerce by the pirates led the same party to support the proposal to confer extraordinary powers on Pompey in 67 B.C.; and the rigour of the senate in opposing any relaxation of the burdensome contract made by the tax-farmers of Asia in 60 B.C. led to that estrangement between the senate and the capitalist class which enabled the democratic party to work its will and pave the way for the principate.

The companies of *publicani* continued some of their operations in the provinces under the early principate, but they lost many of their opportunities of oppression and embezzlement. We hear of a vigorous attempt made by Nero to suppress their unjust exactions, and they appear to have been kept under much closer supervision.

The term *publicanus* was applied at this time, and probably earlier, to the subordinate officials employed by the companies of *publicani* for the actual collection of the revenue, and thus acquired the general sense of "tax-collector," even in provinces where the system of tax-farming by contract with societies of *publicani* was not in existence. (A. M. CL.)

PUBLIC HEALTH, LAW OF. State medicine as an organized department of administration is entirely of modern growth. By the common law of England the only remedy for any act or omission dangerous to health was an action for damages or an indictment for nuisance. The indictment for nuisance still lies for many offences which are now punishable in a summary manner under the powers of modern legislation. But for a long time it was the only, not as now a concurrent, remedy. At a comparatively early date statutes were passed dealing with matters for which the common law had provided too cumbrous a remedy, while the plague called forth the act of 1 Jac. I. c. 31 (1603), which made it a capital offence for an infected person to go abroad after being commanded by the proper authority to keep his house. The act for the rebuilding of London after the great fire, 19 Car. II. c. 3 (1668), contained various provisions as to the height of houses, breadth of streets, construction of sewers and prohibition of noisome trades. Numerous local acts gave the authorities of the more important towns power over the public health. But it was not until 1848 that a general Public Health Act, embracing the whole of England (except the Metropolis), was passed. The Public Health Act 1848 created a general board of health as the supreme authority in sanitary matters, but greater local sanitary control was given by an act of 1858. The local government board, the present central authority, was

created by an act of 1871. Numerous acts dealing with public health were passed from 1849 to 1874; and the law was digested into the Public Health Act 1875, as amended by the Local Government Act 1894 and other acts.

The tendency of English sanitary legislation has been to place local sanitary regulations in the hands of the local authorities, subject to general superintendence by a government department. The jurisdiction of a local authority is both preventive and remedial. The matters falling under it are very numerous, but the more important will be found in the article ENGLAND: *Local Government*. The act of 1875 was followed by the Public Health Acts Amendment Act 1890, the Public Health Act 1896 and the Public Health Acts Amendment Act 1907. The first of these statutes confers enlarged powers on such local authorities as choose to adopt it—the right of adoption being general in the case of urban authorities, and in that of rural authorities limited to certain specified provisions unless extended by the local government board. The Public Health Acts 1896 and 1904 abolished the old system of quarantine (*q.v.*), and empowered the local government board to make regulations as to the landing or embarking of infected persons from ships, British or foreign; while the act of 1907 enabled local authorities to adopt many of the useful clauses introduced into private bills from time to time, relating not only to sanitary provisions, but to streets and buildings, milk, &c. supply, recreation grounds, sky-signs, &c.

Elaborate provision has been made for the notification of infectious diseases by the Infectious Diseases (Notification) Acts 1889 and 1899. The former statute was originally adoptive only, but it has now been extended by the latter to every district in England or Wales—in London notification has been compulsory since 1891. Reference should be made also to the following statutes: the Infectious Disease (Prevention) Act 1890 provides for the inspection of dairies, and the cleansing and disinfecting of premises, and under the Public Health (Ports) Act 1896 the local government board may by order assign to any port sanitary authority powers or duties arising under this statute. The scope of the Baths and Washhouses Acts 1846 to 1882 sufficiently appears from the title. The Isolation Hospitals Act 1893 enables county councils to promote the establishment of hospitals for the reception of patients suffering from infectious diseases; the Cleansing of Persons Act 1897 enables local authorities to permit persons who apply to them, on the ground that they are infested with vermin, to have the gratuitous use of cleansing apparatus; and the Vaccination Acts of 1898 and 1907 profoundly modified the law as to vaccination by giving a discretion to magistrates. See too, among other acts, those of 1881 (alkali works), 1882 (fruit pickers), 1883 (epidemics), 1889 (cholera), 1904 (shop hours), 1905 (medical inspection of aliens) and numerous others.

In addition to these statutes, account has to be taken of a large body of legislation which relates indirectly to the law of public health, or at least comes well within its range of operation. It deals with a very great variety of subjects, and only the slightest sketch of its results need be given here. (For factories and workshops, see LABOUR LEGISLATION, and for merchant shipping, see SEAMEN.) The Coal Mines Regulation Act 1896 aims at the prevention of accidents due to inflammable gas and coal-dust in coal mines. The Cotton Cloth Factories Acts 1889 and 1897 enable the home secretary to make regulations for health in cotton mills. The Rivers Pollution Prevention (Borough Councils) Act 1898 enables joint committees of English and Scottish county councils of counties on both sides of the Border to exercise the powers of the Rivers Pollution Prevention Act 1876, in relation to any river or tributary which is partly in England and partly in Scotland—an expression including the Tweed. The Notification of Births Act 1907 and the Children Act 1908 (see CHILDREN: *Law relating to*) have given great protection to infant life. Lastly, reference may be made to the Contagious Diseases (Animals) Act 1894, which consolidated the law on this subject.

London.—Down to the year 1891 London was governed in matters of public health by a series of special statutes (especially the Metropolitan Police Acts), and by provisions in the general statutes. The law as to the Metropolis was consolidated, and is now regulated by the Public Health (London) Act 1891. The sanitary authorities for the execution of the act were the commissioners of sewers for the City of London, the vestries of the larger and the district boards of some of the smaller parishes, and varying authorities for Woolwich and some other places. Under the London Government Act 1890, the powers of each existing vestry and district board are transferred to the council of the borough comprising the area within the jurisdiction of such vestry and district board; and the borough councils take over certain of the powers of the county council (e.g. as to dairies, milk, slaughter-houses and offensive businesses) and exercise concurrent jurisdiction with it in other matters. Provision is made for the appointment of medical officers of health and sanitary inspectors. The medical officer is for some purposes placed on the footing of a district poor-law medical officer, and he cannot be removed without the consent of the local government board. In its structure and substance

the Public Health (London) Act 1891, which consists of 144 sections, closely resembles the general acts (see LONDON, § iv.).

The law of public health in London is also affected by a number of later statutes relating to the Metropolis alone, such as the London Building Acts 1894 and 1898, the Baths and Washhouses Act 1896, the Canals Protection (London) Act 1898, &c.

Scotland.—Sanitary legislation occurs as early as the reign of Alexander III. The *Statuta Gilde*, c. 19, forbade the deposit of dung or ashes in the street, market, or on the banks of the Tweed at Berwick, under a penalty of eight shillings. At a later date the act of 1540, c. 20, enacted that no flesh was to be slain in Edinburgh on the east side of the Leith Wynd; that of 1621, c. 29, fixed the locality of fleshers and candlemakers. The various statutes relating to public health in Scotland are now consolidated and amended by the Public Health (Scotland) Act 1897, which, together with the Infectious Diseases Notification Act 1889 and the Burgh Police (Scotland) Act 1892, constitute the statutory law of Scottish sanitary administration. The central authority is the local government board for Scotland. The local authorities are—(i.) in burghs under the Burgh Police (Scotland) Act 1892, the town council or burgh commissioners; (ii.) in other burghs, the town council or board of police; (iii.) in districts where the county is divided into districts, the district committee; (iv.) in counties not so divided, the county council. The substantive provisions are similar to those of the English acts.

Ireland.—Several acts of the Irish parliament dealt with specific nuisances, e.g. 5 Geo. III. c. 15, forbidding the laying of filth in the streets of cities or county towns, and making regulations as to sweeping and scavenging. There were also numerous private acts dealing with water-supply and the obstruction of watercourses. In 1878 the existing legislation was consolidated by the Public Health (Ireland) Act 1878, a close copy of the English act of 1875. Most of the English acts apply to Ireland with modifications and adaptations.

United States.—After the Civil War boards of health were established in the chief cities. Public health is under the control of the local authorities to a greater extent than in England. By the Act of Congress of the 25th of February 1799 officers of the United States are bound to observe the health laws of the states. A national board of health was created by the act of the 3rd of March 1879, c. 202; and it was succeeded by the Public Health and Marine Hospital Service, whose chief officer is the surgeon-general and which has jurisdiction in quarantine and in epidemics of a peculiarly dangerous nature.

Authorities.—English: Glen, *Public Health Acts*, 13th edition (London, 1906); Lumley, *Public Health Acts*, 7th edition (London, 1908); Redlich and Hirst, *Local Government* (1904); Hunter, *Open Spaces* (London, 1896); Hunt, *London Local Government* (London, 1897); Hunt, *London Government Act 1899* (London, 1899); Macmorran, Lushington and Naldrett, *London Government Act 1899* (London, 1899); Shaw's *Vaccination Manual* (London, 1899); Macmorran, *Public Health (London) Act 1891* (2nd ed., 1910); *Encyclopædia of Local Government Law* (by various authors), begun in 1905; *Annual Report of Local Government Board*; *Annual Volume of Statutory Rules and Orders*. Scottish: Macdougall and Murray, *Handbook of Public Health* (Edinburgh). Irish: Vanston, *Public Health in Ireland* (Dublin, 1892); Vanston's *Public Health Supplement* (Dublin, 1897). American: Bouvier, *Law Dict.*, ed. Rawle (London and Boston, 1897).

PUBLIC HOUSE, in its general English acceptation, a house in respect of which a licence has been obtained for the consumption of intoxicating liquors. Public houses are frequently distinguished as "tied" and "free." A tied house is one rented from a person or firm from whom the tenant is compelled to purchase liquors or other commodities to be consumed therein. A free house has no such covenant. The keepers of public houses ("publicans" or "licensed victuallers") are subject, in the conduct of their business, to a number of restrictions laid down by various acts of parliament; while, in order to ply their trade, they require a justices' licence and an excise licence. (See LIQUOR LAWS; TEMPERANCE.)

By the Parliamentary Elections Act (1853) a public house must not be used for elections, meetings or committee rooms. By the Payment of Wages in Public Houses Prohibition Act (1883) it is illegal to pay wages to any workman in a public house, except such wages as are paid by the resident owner or occupier. By the Sheriffs Act (1887) when a debtor is arrested he must not be taken to a public house without his free consent, nor must he be charged with any sum for liquor or food, except what he freely asks for.

PUBLILIUS (less correctly **PUBLIUS**) **SYRUS**, a Latin writer of mimes, flourished in the 1st century B.C. He was a native of Syria and was brought as a slave to Italy, but by his wit and

talent he won the favour of his master, who freed and educated him. His mimes, in which he acted himself, had a great success in the provincial towns of Italy and at the games given by Caesar in 46 B.C. Publilius was perhaps even more famous as an improvisatore, and received from Caesar himself the prize in a contest in which he vanquished all his competitors, including the celebrated Decimus Laberius. All that remains of his works is a collection of Sentences (*Sententiae*), a series of moral maxims in iambic and trochaic verse. This collection must have been made at a very early date, since it was known to Aulus Gellius in the 2nd century A.D. Each maxim is comprised in a single verse, and the verses are arranged in alphabetical order according to their initial letters. In course of time the collection was interpolated with sentences drawn from other writers, especially from apocryphal writings of Seneca; the number of genuine verses is about 700. They include many pithy sayings, such as the famous "judex damnatur ubi nocens absolvitur" (adopted as its motto by the *Edinburgh Review*).

The best texts of the *Sentences* are those of E. Wölfflin (1869) A. Spengel (1874) and W. Meyer (1880), with complete critical apparatus and index verborum; recent editions with notes by O. Friedrich (1880), R. A. H. Bickford-Smith (1895), with full bibliography; see also W. Meyer, *Die Sammlungen der Spruchverse des Publilius Syrus* (1877), an important work.

PUBLISHING. In the technical sense, publishing is the business of producing and placing upon the market printed copies of the work of an author (see BOOK). Before the invention of printing the actual maker of a manuscript was to a great extent his own publisher and his own bookseller. Increase of facilities for the production of copies led to a steady though slow differentiation of functions. The author was the first factor to be isolated and confined to a well-marked province, yet we may find upon the title-page of some old books an intimation that they might be purchased either at the shop of the bookseller who published them or at the lodgings of the author.

The separation of publishing from bookselling came later (see BOOKSELLING). Booksellers were the first publishers of printed books, as they had previously been the agents for the production and exchange of authentic manuscript copies; and as they are quite competent to make contracts with paper-makers, printers and bookbinders, there is no particular reason why they should not be publishers still, except the tendency of every composite business to break up, as it expands, into specialized departments. That tendency may be seen at work in the publishing business itself. When publishers had conquered their own province, and had confined booksellers to bookselling, they held in their own hands the entire business of distribution to the trade. But a class of wholesale booksellers has grown up, and although important retail booksellers in London continue to deal directly with the publishers, the retail booksellers throughout the country draw their supplies quite largely from the wholesale agents.

The intellectual movement which was largely responsible for the French Revolution, and the general stir and upheaval which followed that portentous cataclysm, precipitated the separation of production from distribution in the book trade, by the mere expansion of the demand for books. That separation was practically complete at the beginning of the 19th century, although it would not be difficult to find survivals of the old order of things at a much later date. The old bookseller-publishers were very useful men in their time. They met pretty fairly the actual needs of the public; and as regards the author, they took the place of the private patron upon whom he was previously dependent. No doubt the author had much to endure at their hands, still, they did undoubtedly improve his status by introducing him to public patronage and placing him upon a sounder economic basis. If in the earlier days they were less than liberal in their terms, it may be remembered that their own business was not very extensive or very remunerative. They were not equipped either with brains or with capital to extend that business in answer to the growing demand for books. By the daily routine of their shops they

were tied down to narrow views, and their timidity is characteristically shown by the fact that to publish a book of any importance required the co-operation of a number of booksellers who shared the expenses and the profits.

Enterprise could not be expected from a committee of that kind and of that composition; hence there was not merely an opportunity, but a clamorous demand for men of larger ideas and wider outlook to undertake the proper business of publishing, unhampered by the narrowing influences of retail trade.

Besides unconsciously improving the position of authors by enabling them to appeal to the public instead of to patrons, whom Johnson classed with other evils in the line "toil, envy, want, the patron and the gaol," the bookseller-publishers gave them, or many of them, steady employment as literary assistants and advisers.

As the demand for books increased, these worthy tradesmen felt with growing acuteness their own want of literary ability and of education. They called in men of letters to supply their own deficiencies. No doubt they expected the lowest kind of hack work from their assistants, no doubt the pay was poor, no doubt they trampled upon the sensibilities of the man of letters, and no doubt he irritated them by his unbusinesslike habits. Still, the association was useful to both parties; and indeed, one may lay down many books at the present day with a sigh of regret that the writers had never been compelled to go through an apprenticeship of the kind.

The emergence of the publishers as a separate class was accompanied by differentiation of the functions of their literary assistants. The routine drudgery which men of education and ability formerly had to undergo fell to a class now known as "proof readers," who are on the watch for typographical errors, grammatical slips, ambiguities of expression, obvious lapses of memory and oversights of all kinds. Men of letters became "publishers' readers," and their duty was to appraise the worth of the manuscripts submitted, and to advise their employers as to the value of the matter, the originality of the treatment, and the excellence of the style. Their advice was also sought upon literary projects that may have suggested themselves to the publishers, and novel suggestions emanating from themselves were welcomed. Men of letters in positions of that kind could obviously exercise very considerable influence over the proceedings of the publishing firms to which they were attached, and many an unknown writer has owed the acceptance of his work to the sympathetic insight of the publishers' reader.

The man of letters as publisher's reader is, however, a transitory phenomenon in the evolution of the publishing business. His primary function is to tell the publisher what is intrinsically good, but probably he has always to some extent discharged the secondary function of advising the publisher as to what it would pay to publish. The qualities which make a man a sound critic of intrinsic worth are quite different from those that make him a good judge of what the public will buy. When books were comparatively few, and when the reading public was comparatively small, select and disposed to give considerable attention to the few books it read, the critical faculty was of more importance than the business one. But when the output of books became large, and when, as the consequence of educational changes, the reading public became numerous, uncritical and hurried and superficial in its reading, the importance of the critical faculty in the publisher's reader dwindled, while the faculty of gauging the public mind and guessing what would sell became increasingly valuable. The publisher's literary adviser belongs to the period when the publishing business had expanded sufficiently to compel the publisher to look for skilled assistance in working more or less upon the older traditions. But when, as is now the case, expansion has gone so far as to swamp the older traditions, and to make publishing a purely commercial affair, the literary reader gives place to the man of business with aptitude for estimating how many copies of a given book can be sold. This is practically recognized by at least one London publisher, who in recent years paid no salary to his reader, but gave him a small commission upon every copy

that was sold of any book the publication of which he had recommended. Nothing could more plainly indicate that literary faculty is not wanted, and that the reader's function is to judge, not literary value, but commercial utility.

The market is flooded with books badly written, badly constructed, as poor in matter as in style, hastily flung together, and outrageously padded to suit conventional relations between size and price. They are books which no man of literary taste or judgment could ever recommend for publication on their merits, but they are published, just as crackers are at Christmas, on a calculation that a certain number will find buyers. Even if the publisher sees no prospect of an adequate sale, he publishes the books all the same, upon terms which ensure to him a manufacturing profit and throw the risk of loss upon other shoulders.

There is no reproach, stated or implied, to the publisher. He is merely a man of his age carrying on his business upon terms which the age prescribes through a number of concurrent causes. Any reproach that may fall upon him he invites by sometimes giving himself the airs of one belonging to an earlier age, and claiming credit for acting upon principles that are obsolete.

An author, even if he be an immortal genius, is, from the economic point of view, a producer of raw material. A publisher, however eminent, is from the same point of view a middleman who works up the author's raw material into a saleable form and places it upon the market. The relationship between the two is one that occurs with great frequency in business, always giving rise to efforts by each party to adjust the division of profits for his own advantage. If there be anything peculiar to the publishing business it is that the party who in that business most successfully adjusts matters for his own advantage is liable to be charged by the other with some form of moral obliquity. The diatribes of authors against publishers are familiar to every one; and publishers on their side have some hard things to say about authors, though their sentiments are less piquantly and less publicly expressed. The publisher is usually a more or less capable man of business, while the author is generally—though there are very notable exceptions—quite ignorant of business and apparently incapable of learning the rudiments. It necessarily follows that the author, left to himself, accepts agreements and signs contracts which are much less favourable than they need be to his acquisition of a due share of the profits jointly made by himself and the publisher. What makes his position still worse is the circumstance that each author fights for his own hand, whereas the publishers, although in competition with one another, are also to some extent in combination.

In these circumstances it occurred to Sir Walter Besant and some others that a remedy for this inferiority in position might be found in a combination of authors for mutual help and protection. After a troublesome period of incubation the Society of Authors was established in London in 1883, with Lord Tennyson as its first president, and with a goodly list of 35 vice-presidents. It offered useful assistance to authors ignorant of business in the way of examining contracts, checking publishers' accounts, revising their sometimes too liberal estimates of costs of production, and giving advice as to the publishers to be applied to or avoided in any given case. It has no doubt been of great service in checking the abuses of the publishing trade and in compelling the less scrupulous among the publishers to conform more or less exactly to the practice of the more honourable. On general questions such as that of copyright it serves to focus the opinions of authors, though here it champions their interests against the public rather than against the publishers. But the society has never been an effective combination of authors; and indeed the obstacles, material and moral, to such a combination are so great as to render complete success extremely improbable. Nothing could better illustrate this difficulty than the fact that, concurrently with the Society of Authors, a totally different machinery for the furtherance of the interests of authors came into existence. The "literary agent" made his appearance about 1880. He is supposed to be an

expert in all matters pertaining to publishing and to the book market. He takes the author's business affairs entirely into his hands; utilizes the competition among publishers to sell the author's work to the highest bidder; checks accounts, estimates and sales; keeps the author's accounts for him; and charges a commission upon the proceeds. Here we have the author fighting as of old for his own hand. The only difference is that he does his fighting by proxy, hiring a stronger man than himself to deal the blows on his account. There is no question whatever of solidarity with his fellow-authors, and the whole system is a direct negation of the principle upon which the Society of Authors was founded.

On the other hand, both publishers and booksellers have long had the disposition, and to some extent the ability, to co-operate, and the efforts of both sets of men have unfortunately been in the direction of maintaining, if not raising, the price of books to the public. Since the formation of the Publishers' Association in 1896 the publishing trade has been strongly organized on the trade-union pattern, and its operations have been assisted by the less powerful Booksellers' Association. Books, like many other articles, are sold by the makers at list prices, and the retailer's profit is furnished by discounts off these prices. Under such a system competition among retailers takes the form of the sacrifice by the more enterprising of a portion of their discount. They prefer a large sale at a low profit to a small sale at a high profit. It is always the desire of the less enterprising to put an end to this competition by artificial regulations compelling all to sell at the same price.

Many attempts have been made to destroy freedom of dealing in books. In July 1850 twelve hundred booksellers within 12 m. of the London General Post Office signed a stringent agreement not to sell below a certain price. This agreement was broken almost immediately. Another attempt was made in 1852; but at a meeting of distinguished men of letters resolutions were adopted declaring that the principles of the Booksellers' Association of that period were opposed to free trade, and were tyrannical and vexatious in their operations. *The Times* took an active part in defending and enforcing the conclusions which they sanctioned. The question was eventually referred to a commission, consisting of Lord Campbell, Dean Milman and George Grote, which decided that the regulations were unreasonable and inexpedient, and contrary to the freedom which ought to prevail in commercial transactions. An attempt was also made in 1869 to impose restrictions upon the retail bookseller; but that also failed, mainly by reason of the ineffective organization which the publishers then had at command.

Feeling their hands greatly strengthened by the establishment of their Association, the publishers were emboldened to make another effort to put an end to reductions in the selling price of books. After much discussion between authors, publishers and booksellers, a new scheme was launched on the 1st of January 1900. Books began to be issued at *net* prices, from which no bookseller was permitted to make any deduction whatever. This decree was enforced by the refusal of all the publishers included in the Association to supply books to any bookseller who should dare to infringe it in the case of a book published by any one of them. In other words, a bookseller offending against one publisher was boycotted by all. Thus, what is known as the "net system" depended absolutely upon the close trade union into which the publishers had organized themselves. The Booksellers' Association signed an agreement to charge the full published price for every net book, but that body had no real power to impose its will upon recalcitrant booksellers. Its assent to the terms of the publishers merely relieved them of the fear of active opposition on the part of the wholesale booksellers and the large retail booksellers, mainly located in London.

All books were not issued at net prices even in 1910, though the practice had extended enormously since it began in 1900. But the principle was applied all round. In the case of such books as six-shilling novels the discount price of four shillings and sixpence was treated as the net price, and the usual penalty

was inflicted upon those who dared to sell at any lower price, at all events within twelve months of the date of publication.

Owing to the fact that the net system was gradually introduced, net books and discount books being issued side by side with discount books in the majority, the full effect of the innovation was not immediately apparent. But the establishment of *The Times* Book Club in 1905 brought the system to the test. That Club aimed at giving to the readers of *The Times* a much more prompt and copious supply of new books than could be obtained from the circulating libraries. The scheme was at first very favourably received by the publishers, who saw in it the promise of largely increased orders for their goods. They obtained these orders, but then something else happened which they had not foreseen. Of the books they issued the vast majority were of only ephemeral interest. For a few weeks, sometimes only for a few days, everybody wanted to glance at them, and then the public interest dwindled and died. As the copies ceased to be in demand for circulation the Book Club naturally tried to take advantage of the buying demand, which always exists, though it is always repressed by the very high prices charged by publishers in Great Britain. The Book Club sold its surplus copies at reduced prices, and was obliged to do so, since otherwise it would have been swamped with waste paper. But the authors and publishers now rose in arms. Forgetting that they had been paid the full trade price for every copy, they said that the Book Club was spoiling the market, and that a wholesale buyer had no right to sell at the best price he could get. Hence arose what came to be known as the Book War, between *The Times* and the associated publishers and booksellers, the publishers withdrawing their advertisements from *The Times* and doing their best to refuse books to the Book Club. The conflict made a considerable commotion, and the arguments on both sides were hotly contested. It did not, however, alter the fact that the public will not pay high prices for books having no permanent value.

The Booksellers' Association, dominated by the large booksellers in London and a few great towns, made common cause with the Publishers' Association. Their interests were not affected by the net system, and they saw in the Book Club an energetic competitor. The small booksellers up and down the country are injuriously affected, because it is more difficult than ever for them to stock books on which there is a very small margin of profit, and the sale of which they cannot any longer push by the offer of a discount. Formerly, if a book did not sell at the full price, they could sacrifice their profit and even part of what they paid for it, thus saving at least part of their invested capital. Now if a book does not sell at the net price they have to keep it so long that it is probably unsaleable at any price and forms a dead loss. Hence they cannot afford to stock books at all, and that channel of distribution is blocked.

The cast-iron retail price is economically wrong. A bookseller with a large turn-over in the midst of a dense population can afford to sell at a small profit. He finds his reward in increased sales. His action is good for the public, for the author, and for the publisher himself, were he enlightened enough to see it. But a small bookseller in a remote country town cannot afford to sell at an equally low profit, because he has not access to a public large enough to yield correspondingly increased sales. Yet both are arbitrarily compelled to sell only at a uniform price fixed by the publisher. What makes the matter worse is that there is no cast-iron wholesale price. The small bookseller has to pay more for his books than the large one who buys in dozens of copies. Carriage on his small parcels often eats up what profit is left to him. As he is not allowed to have books "on sale or return," he has no chance whatever; and as a distributing agency the small bookseller has become negligible.

It is not a necessary consequence of the net system that new books should cost the public more than before. If it has become the practice to sell a ten-shilling book for seven shillings and sixpence, and if that practice be thought objectionable, the obvious remedy, supposing publishers to have no other end in view, is to publish the book at the price for which it is sold. But the net system has been used to enforce the sale of the book

at the published price and nothing less, which obviously amounts to compelling the public to pay more than before for the book. Again, if the object were to benefit the retail bookseller by relieving the pressure of competition, it is plain that after abolishing discounts the publishers would charge the same wholesale prices as before to the booksellers. But, on the contrary, they have so adjusted their prices that the retailer gets no more profit upon a book sold net than he formerly obtained from a book of the same published price after allowing a discount. Thus the object and result of the net system is to increase the profits of the publishers at the expense of the public. This has been accomplished at a time when paper is cheaper than at any previous period, and when machinery has reduced the cost of composition, printing and binding to an almost equal extent. It is a remarkable illustration of the power of combination among quasi-monopolists to raise the price of their commodities even in the face of a falling market.

The Book War came to an end in 1908; but though the publishers and booksellers appeared in the result to have brought the Book Club within terms which were satisfactory to them, the whole situation had really been changed. The public for the first time had been educated. Public attention had been forcibly directed to the fact that there is no reason in the nature of things why the price of books should increase, but on the contrary, every reason why they should be cheaper than at any previous period. A certain mystery which had hung over the publishing trade was effectually dispelled. The man in the street learned that books priced to him at six shillings can be produced by the joint labours of the paper maker, the printer, and the bookbinder for about sixpence, and that in many cases the author gets little or nothing out of the difference. There followed a quickening of the public demand for literature at reasonable prices, and enterprising people were found to meet the demand. A vast quantity of good literature, much better than nine-tenths of what is written to-day, has been brought within reach of persons of the smallest incomes. Hundreds of standard works have appeared in convenient and readable editions at a shilling, at sevenpence and even sixpence per volume. These cheap editions have an enormous sale, not only because they are low in price, but because they have permanent value. For the cost of a novel which he will never look at twice, and which perhaps was hardly worth reading once, a man may obtain half a dozen books that have stood the test of time, and that will become the valued companions of his leisure. He gets them too in a form suited not only to his purse, but to the limited storage accommodation at the disposal of the mass of modern readers, who can neither buy nor house the stately editions that adorn the libraries of the wealthy. Thus, in respect of the large class of books read for recreation, we have reached the paradoxical position that cheapness and excellence go hand-in-hand; and that the disparaging adjective frequently linked with "cheap" is more properly associated with dear and pretentious.

Nor does the counter movement stop even here. There is a growing tendency to bring out books of current production in cheap editions, and also to publish the original edition at prices which must give a painful shock to the authors of the net system. Cheap magazines, and the *feuilletons* which newspapers are adopting from French practice, make considerable inroads upon the province of the six-shilling novel; and as regards more serious books the newspapers now give an amount of information about their contents which goes far to console the public for the prohibitive prices of the books themselves. These movements are developing and will continue to develop, seriously interfering with the plans of those who devised the net system. The combination publishers have never understood that, apart from the very small percentage of works which make real additions to the sum of knowledge or of genuine literary achievement, the reading of the books they turn out is a pastime, which has to compete in public favour with a great variety of other pastimes. They have chosen to make their form of recreation extremely expensive, with the double result that the public turn to others,

and that even their own is increasingly supplied by cheaper agencies.

There are certain classes of books which must always be relatively expensive, because they appeal only to students of some particular branch of science or of art or of literature, whose number is not great. But these are books of enduring value. Their price is justified not only by their prolonged service, but by the erudition or the exceptional qualities which go to the writing of them, as well as by the frequently exceptional cost of producing them. But as regards the vast output of books which merely amuse an idle hour, the existence of a large body of readers is the only excuse for their appearance, and if they cannot be produced at a low price ensuring an extensive sale they ought not to be produced at all. Thus there is more than a mere money question involved in the contention about price. An artificial system of prices leads to the printing of a vast quantity of trash, which demoralizes the reading public and is a serious obstacle to the success of the better books. Such a system operates, in fact, as a protective duty in favour of mediocrity and even of something worse. It is no defence of such a system that it panders to the vanity of incompetent scribblers, and enables publishers to make money by soiling paper that had better have been kept clean.

A rational system of prices would automatically solve some of the difficulties of the book-world. If a book is selling by tens of thousands of copies, as every book printed for pastime ought to do, it would not matter at what price any large buyer chose to resell his purchases. They would only be a drop in the bucket, and all the contention about second-hand prices would disappear.

Then there is the troublesome system of "remainders," that is to say, the unsaleable copies of thousands of books published every year. The editions are small enough—probably not more than one thousand copies—yet, in spite of circulating libraries, a third or a half of that modest number remains in the warehouses of the publishers. Sometimes they are sold for about the cost of their flimsy covers; sometimes they simply go to be reduced to their original pulp at the paper mills. If a book has any sale justifying its production, there will be no question of remainders, supposing its supply to have been regulated by the most ordinary prudence. The sale of such a book never stops dead, and any small surplus of copies can always be got rid of at a small reduction in price.

Towards the end of the 19th century came a large influx into England of American literature, especially fiction. Not only was there a growing appreciation of many American writers, but the attractive "get-up" of American books made its influence felt upon the British market. Some of the American methods of distribution were also introduced into Great Britain, but at first with only partial success. The most successful effort was the sale of important expensive works through the medium of newspapers. Canvassing, which was a common method of distributing books in the United States, met with little support in the United Kingdom, although about the middle of the 19th century a large trade was done through England and Scotland by canvassers, who sold in numbers and parts such works as Family Bibles, Daily Devotions, Lives of Christ and Foxe's *Book of Martyrs*.

The methods of publishing in America are similar to those adopted in Great Britain, but the discount to the booksellers is generally given *pro rata* according to the number purchased. It is, however, in respect of the means of distribution that the systems of the two countries differ most. In America the general stores to a large extent take the place of the English bookseller, and by their energy and extensive advertising a wider public is served. In the distribution of fiction the American plan of "booming" a book by copious advertising, although expensive, is often the means of inducing a large sale, and of bringing an author's name before the public. In 1901 the net system, as adopted in Great Britain, was partially introduced into America.

The continental methods of publishing and distributing, especially in Germany, differ, in many respects very materially, from those of Great Britain. In even the smallest German towns there is a bookseller who receives on sale, immediately upon publication, a supply of such new books as he or the publisher may think suitable to his class of book-buyers. The bookseller submits these books

to his customers, and by this method most books issued are at once placed at the disposal of any buyer interested in the particular subject. The large sums spent in other countries upon advertisements are thus saved. At the book fairs held in Leipzig at Easter and Michaelmas the accounts for books sent on sale are made up and paid. In France all books have to be licensed before publication, but the methods of publication differ little from those of other continental countries, in all of which book prices are much lower than in England.

PUCCINI, GIACOMO (1858—), Italian operatic composer, was born at Lucca, of a family already distinguished in music; his great-great-grandfather Giacomo, great-grandfather Antonio, grandfather Domenico, and father Michele, being all well known in the art. He was educated at the Milan Conservatoire, and in 1884 his opera *Le Villi* was performed at the Teatro del Verme. In 1889 his *Edgar* was performed at La Scala, and in 1893 his *Manon Lescaut* in Turin. But it was the production of *La Bohème* in Turin in 1896 that made him famous, and this opera had a great success everywhere. *Tosca* followed in 1900, and in 1904 *Madama Butterfly* confirmed the highest opinions of his talent.

PUCHTA, GEORG FRIEDRICH (1798–1846), German jurist, born at Kadolzburg in Bavaria on the 31st of August 1798, came of an old Bohemian Protestant family which had immigrated into Germany to avoid religious persecution. His father, Wolfgang Heinrich Puchta (1769–1845), a legal writer and district judge, imbued his son with legal conceptions and principles. From 1811 to 1816 young Puchta attended the gymnasium at Nuremberg, where he acquired a taste for Hegelianism. In 1816 he went to the university of Erlangen, where, in addition to being initiated by his father into legal practice, he fell under the influence of the writings of Savigny and Niebuhr. Taking his doctor's degree at Erlangen, he established himself here in 1820 as *privatdozent*, and in 1823 was made professor extraordinary of law. In 1828 he was appointed ordinary professor of Roman law at Munich. In 1835 he was appointed to the chair of Roman and ecclesiastical law at Marburg, but he left this for Leipzig in 1837, and in 1842 he succeeded Savigny at Berlin. In 1845 Puchta was made a member of the council of state (*Staatsrat*) and of the legislative commission (*Gesetzgebungskommission*). He died at Berlin on the 8th of January 1846. His chief merit as a jurist lay in breaking with past unscientific methods in the teaching of Roman law and in making its spirit intelligible to students. Among his writings must be especially mentioned *Lehrbuch der Pandekten* (Leipzig, 1838, and many later editions), in which he elucidated the dogmatic essence of Roman law in a manner never before attempted; and the *Kursus der Institutionen* (Leipzig, 1841–1847, and later editions), which gives a clear picture of the organic development of law among the Romans. Among his other writings are *Das Gewohnheitsrecht* (Erlangen, 1828–1837); and *Einleitung in das Recht der Kirche* (Leipzig, 1840).

Puchta's *Kleine zivilistische Schriften* (posthumously published in 1851 by Professor A. A. Friedrich Rudorff), is a collection of thirty-eight masterly essays on various branches of Roman law, and the preface contains a sympathetic biographical sketch of the jurist. See also Zeher, *Über die von Puchta der Darstellung des römischen Rechts zu Grunde gelegten rechtsphilosophischen Ansichten* (1853).

PÜCKLER-MUSKAU, HERMANN LUDWIG HEINRICH, FÜRST VON (1785–1871), German author, was born at Muskau in Lusatia on the 30th of October 1785. He served for some time in the bodyguard at Dresden, and afterwards travelled in France and Italy. In 1811, after the death of his father, he inherited the barony of Muskau and a considerable fortune. As an officer under the duke of Saxe-Weimar he distinguished himself in the war of liberation and was made military and civil governor of Bruges. After the war he retired from the army and visited England, where he remained about a year. In 1822, in compensation for certain privileges which he resigned, he was raised to the rank of *Fürst* by the king of Prussia. Some years earlier he had married the Gräfin von Pappenheim, daughter of Fürst von Hardenberg; in 1826 the marriage was legally dissolved though the parties did not separate. He again visited England and travelled in America and Asia Minor, living after his

return at Muskau, which he spent much time in cultivating and improving. In 1845 he sold this estate to Prince Frederick of the Netherlands, and, although he afterwards lived from time to time at various places in Germany and Italy, his principal residence was his seat, Schloss Branitz near Kottbus, where he laid out splendid gardens as he had already done at Muskau. In 1863 he was made an hereditary member of the Prussian Herrenhaus, and in 1866 he attended the Prussian general staff in the war with Austria. He died at Branitz on the 4th of February 1871, and, in accordance with instructions in his will, his body was cremated. As a writer of books of travel he held a high position, his power of observation being keen and his style lucid and animated. His first work was *Briefe eines Verstorbenen* (4 vols., 1830–1831), in which he expressed many independent judgments about England and other countries he had visited and about prominent persons whom he had met. Among his later books of travel were *Semilassos vorletzter Weltgang* (3 vols., 1835), *Semilasso in Afrika* (5 vols., 1836), *Aus Mehemed-Alis Reich* (3 vols., 1844) and *Die Rückkehr* (3 vols., 1846–1848). He was also the author of *Aedeutungen über Landschaftsgärtnerei* (1834).

See Ludmilla Assing, *Pückler-Muskau's Briefwechsel und Tagebücher* (9 vols., 1873–1876); *Fürst Hermann von Pückler-Muskau* (1873); and Petzold, *Fürst Hermann von Pückler-Muskau in seiner Bedeutung für die bildende Gartenkunst* (1874).

PUDDING, a term, now of rather wide application, for a dish consisting of boiled flour enclosing or containing meat, vegetables or fruit, or of batter, rice, sago or other farinaceous foods boiled or baked with milk and eggs. Properly a pudding should be one boiled in a cloth or bag. There are countless varieties, of which the most familiar are the Christmas plum-pudding, the Yorkshire pudding and the suet pudding. The word was originally and is still so used in Scotland for the entrails of the pig or other animal stuffed with meat, minced, flavoured and mixed with oatmeal and boiled. The etymology is obscure. The French *boudin* occurs in the Scottish original sense at the same time as *poding* (13th century) in English. *Boudin* has been connected with Italian *boldone* and Latin *botulus*, sausage, but the origins of these words are quite doubtful. Attempts have been made to find the origin in a stem *pod-*, to swell, cf. "podgy," L. Ger. *Pudde-wurst*, black-pudding, &c.

PUDSEY, a municipal borough in the Pudsey parliamentary division of the West Riding of Yorkshire, England, 6 m. W. by S. of Leeds, on the Great Northern railway. Pop. (1891), 13,444; (1901), 14,907. The principal buildings are the church of St Lawrence in Gothic style, erected in 1821, and the mechanics' institute, a fine building, comprising class-rooms, a library, a public hall and a lecture hall. A public park was opened in 1889. The town has an important woollen trade and possesses dyeing and fulling mills. Part of the parish, Tyersall, is in the borough of Bradford. Pudsey is mentioned in Domesday. It was sold by Edward II. to the Calverley family, from which it passed to an ancestor of the Milners. The town was incorporated in 1899, and the corporation consists of a mayor, 6 aldermen and 18 councillors. Area, 2399 acres.

PUDUKKOTTAI, a state of southern India, in subordination to Madras, lying between the British districts of Tanjore and Madura. Area, 1100 sq. m. Pop. (1901), 380,440, showing an increase of 2% in the decade. The state consists mainly of an undulating plain, nowhere of great fertility and in many parts barren; it is interspersed with rocky hills, especially in the south-west. Granite and laterite are quarried, red ochre is worked, and silk and cotton fabrics, bell-metal vessels and perfumes are among the principal manufactures. There is also some export trade in groundnuts and tanning bark. The chief, whose title is *tondaman*, is of the Kallan or robber caste. His ancestors received a grant of territory for loyal services to the British during the wars in the Carnatic at the end of the 18th century. Estimated gross revenue, £80,000; no tribute. The state has for some years past been well administered under a council, with a representative assembly. The town of Pudukkottai had a population in 1901 of 20,347. It is well laid out, and contains several fine new buildings.

PUEBLA, a state of Mexico, occupying the south-east angle of the great central plateau, or that part of it known as the Anahuac table-land. It is bounded N. and E. by the state of Vera Cruz, S. by the states of Oaxaca and Guerrero, and W. by the states of Morelos, Mexico, Tlaxcala and Hidalgo. Area, 12,204 sq. m. Pop. (1900), 1,021,133, largely civilized Indians. Lofty mountains overlook the plateau from the north-east and west, three of the highest peaks, Orizaba, Popocatepetl and Ixtaccihuatl rising above the permanent snow-line, while another, Malinche, lifts its isolated mass nearly to that limit. In the south the table-land breaks away and long fertile valleys lead downward toward the warm southern plains. The central table-land forms part of the watershed between the eastern and western drainage systems, some of the streams in the north and south-east emptying into the Gulf of Mexico, while the Atoyac, which has its source in Tlaxcala, crosses the state and discharges into the Pacific through the Mescala. Puebla has a temperate, healthful climate, one of the best in Mexico. The soil is generally fertile and the rainfall abundant. Agriculture is the principal industry. The Mexican, Interoceanic and Mexican Southern railways cross the state and afford ample transportation facilities.

PUEBLA (full title *La Puebla de los Angeles*, and more recently, *Puebla de Zaragoza*), a city of Mexico and capital of the state of the same name, on the banks of the Atoyac river, 60 m. S.E. of the city of Mexico, with which it is connected by two lines of railway. Pop. (1900), 93,152, including a large percentage of Indians. Its railway connexions put it in daily communication with the national capital, Vera Cruz, Pachuca, Oaxaca, and the terminal ports of the Tehuantepec railway—Coatzacoalcos and Salina Cruz. The city is built on a broad healthy plain, about 7200 ft. above sea-level. It is well provided with street railways, electric and gas illumination, water and drainage. The great Doric cathedral, about 165×320 ft., is perhaps the finest ecclesiastical building in Latin America. It was begun about 1552, but not completed until 1649. Among other churches, famous for their lavish decorations, are those of San José, San Cristobal, Santa Catarina and San Domingo. The "Teatro Principal," built in 1790, is said to be the oldest existing theatre on the continent. There are two other theatres, and an immense bull-ring. Among the more conspicuous public buildings are the palace of justice, the building of the state legislature, a school of medicine to which is attached the Palafoxiana Library of over 100,000 volumes, an academy of fine arts, and the national college. At Fort Guadalupe, near the city, there are several hot sulphur springs, which are used for medicinal baths. Puebla is one of the busiest manufacturing cities in Mexico, and among its products are cotton and woollen textiles, soap, glass, straw hats, pottery and leather goods. There are also some large foundries.

Puebla was founded in 1532 by Sebastian Ramirez de Fuenleal, archbishop of Santo Domingo, and the celebrated Franciscan friar Toribio Motolinia. In 1550 it became the see of the bishopric originally created in 1526 at Tlaxcala. The appellation "de los Angeles," which is now practically dropped, originated in a popular belief that during the building of the cathedral two angels every night added as much to the height of the walls as the workmen had completed on the preceding day. Its present title was given in honour of General Ignacio Zaragoza (1820-1862), who successfully defended the city against the first French attack in 1862. It was captured in the following year by the French, and then by the Mexicans under Porfirio Diaz in 1867. In the war between Mexico and the United States it was captured by General Winfield Scott and was his headquarters from June to August 1847.

PUEBLO, a city and the county-seat of Pueblo county, the second largest city of Colorado, U.S.A., and one of the most important industrial centres west of the Missouri river, situated on the Arkansas river, about 120 m. S. by E. of Denver. Pop. (1890), 24,558; (1900), 28,157, of whom 4705 were foreign-born, 1250 being Austrian, 587 German, 520 Italian, 415 Irish, 391 Swedish, 385 English and 341 English Canadian; (1910, census), 44,395. It is served by five great continental railway

systems—the Denver & Rio Grande, the Atchison, Topeka & Santa Fé, the Missouri Pacific, the Chicago, Rock Island & Pacific and the Colorado & Southern, giving it altogether a dozen outlets. It lies about 4680 ft. above the sea, in a valley at the junction of the prairies with the foothills of the Rockies, on both banks of the Arkansas river, near its confluence with Fountain Creek; the city has an exceptionally good climate and attracts many winter visitors. There are a state insane asylum and four hospitals, of which the Minnequa Hospital (for the employés of the Colorado Fuel & Iron Co.) and St Mary's Hospital are the most notable. Among the public buildings are the McClelland public library (1891) and the court-house, the latter of white stone quarried in the vicinity. The Mineral Palace (1891), having a roof formed of twenty-eight domes, in the northern part of the city, contains a collection of the minerals of the state. Pueblo is chiefly an industrial city, and is often called the Steel City, or the Pittsburg of the West. Cheap fuel is furnished by the excellent coal of Canyon City (about 30 m. west), Walsenburg (about 40 m. south-west) and Trinidad (about 75 m. south). Petroleum deposits in the immediate vicinity are of growing importance. Fluxing material is only about 50 m. away, around Cripple Creek. The rich river valley yields abundant crops of alfalfa, sugar beets, cantaloupes, apples and peaches, and the dry lands behind its shores prove fertile under irrigation or under the Campbell system of dry farming; on the plains livestock interests are important. In 1905 Pueblo's total factory products were valued at \$2,197,293 (an increase of 52.6% since 1900); if the output of the great smelting and refining establishments just outside the city limits had been included, the value would have been considerably larger. Pueblo is the greatest smelting centre west of the Missouri and probably the greatest in the United States. The bulk of the steel rails used on western railways are from the mills of the Pueblo district.

Pueblo was originally a Mexican settlement. A considerable body of Mormons settled here temporarily on their way to Utah in 1846-1847, and a trading post was established in 1850; but the site, owing principally to Indian troubles, had been practically abandoned before 1858, when another settlement was made on the Fontaine qui Bouille, or Fountain Creek. Two years later Pueblo was surveyed and platted. The first railway—the Denver & Rio Grande—came through in 1872. Pueblo was chartered as a city in 1870, and again, with an enlarged area, in 1887.

PUEBLO INDIANS, the Spanish name (*pueblo*=village) for the town-building tribes of American Indians of the Keresan, Shoshonean, Tanoan and Zuñian stocks, whose representatives are now practically confined to New Mexico and Arizona. Formerly they had a far greater range. They were alike in their sedentary agricultural characteristics, and had not the warlike disposition of the Plains Indians. Their modern history begins with their discovery in 1539 by Father Marcos de Niza. In the following year they were subdued by Francisco Vasquez de Coronado. Two years later they made a successful revolt, but in 1586 they had again to submit. In 1680 they once more rebelled, but by 1692 they were finally conquered. Their houses are communal, generally but one structure for the whole village. These houses are sometimes built of stone, but oftener of adobe, several storeys high, each storey receding from the one below. The common plan is a hollow square or curved figure, though in some cases the form of a pyramid is followed. A feature of each town is the underground chamber used for tribal ceremonies. Many of the towns are built on high table-lands inaccessible except by steep trails. The Pueblos are a short, sturdy type of American Indians, very active, but mild-mannered and much darker than those of the plains. They are farmers and herdsmen, and are skilful in basket-work, weaving, pottery and carving. They are notable for their highly developed ceremonial customs, and their blankets and earthenware are decorated with religious symbolism.

PUELICHE, a tribe of South-American Indians of Araucanian stock. Their home is the Pampas region of southern Argentina around the Colorado river. They are chiefly nomadic, breeding cattle and horses, and lead a wild, lawless life.

PUENTEAREAS, a town of north-western Spain in the province of Pontevedra; on the Tuy-Santiago de Compostella railway and on the river Tea, a right-hand tributary of the Miño. Pop. (1900), 13,452. Puenteareas is the chief town of a fertile hilly region, which produces wine, grain and fruit, and contains many cattle farms. The industries of the town itself are porcelain manufactures, tanning and distilling. Close by are the ruins of the castle of Sobroso, which played an important part in the mediæval civil wars.

PUENTE GENIL, or PUENTE JENIL, a town of southern Spain, in the province of Cordova; on the right bank of the river Genil or Jenil, a tributary of the Guadalquivir. Pop. (1900), 12,956. Puente Genil is on the Cordova-Málaga railway, and is the starting-point of the line to Linares. A bridge across the Genil, from which the name of the town is derived, joins the lower part of Puente Genil with the higher, which is built on rising ground extending to the olive groves above. There are several convents, schools for primary and higher education, hospitals, a municipal library and a theatre. The principal industry is the manufacture of olive oil. There are also flour-mills and linen factories. The *alhondiga* or permanent market is always well stocked with grain, vegetables and livestock.

PUPERAL FEVER (Lat. *puerpera*, from *puer*, child, and *parere*, to bring forth), the name given to the varieties of general infection, long regarded as a specific disease ("child-bed fever," "lying-in fever"), to which women are subject after parturition, owing to the genital tract being peculiarly exposed, in septic surroundings, to the invasion of pathogenic bacteria (see SEPSIS). Owing largely to the labours of I. P. Semmelweis (*q.v.*) the grave mortality formerly attending this condition has been enormously reduced; and the necessity of rigid cleanliness in the treatment of lying-in cases is fully recognized. When unhappily this is not the case, and infection takes place, its complications must be treated according to the circumstances, antiseptic douching being employed, or preferably curetting the endometrium with a sharp curette and swabbing with disinfectant solution. In definitely septicaemic cases antistreptococcic serum may be useful.

PUERTO CABELLO, a city and port of Venezuela, in the state of Carabobo, 20 m. N. by W. of Valencia, the capital of the state. Pop. (1891), 10,145. Puerto Cabello has railway connexions with Valencia and Caracas. It stands on a small peninsula which partly shelters a large bay, called "Golfo Triste," by the early Spanish navigators. After La Guayra the harbour is the principal port of Venezuela, and it is provided with mole, wharves, railway communication with the interior, and other facilities for the handling of merchandise and produce. The town and harbour were strongly fortified in colonial times, but the port defences were greatly damaged in 1902 in a bombardment by some German vessels of the allied blockading fleet. Among the exports are coffee, cacao, dyewoods, hides, skins, and copper ores. Puerto Cabello suffered much in the War of Independence, changing hands several times and remaining in the possession of Spain down to 1823.

PUERTO CORTES (CORTEZ or CABALLOS), a seaport on the Atlantic coast of Honduras; in 15° 51' N. and 87° 56' W., at the northern terminus of the transcontinental railway from Fonseca Bay, and near the mouth of the river Chamalecon. Pop. (1905), about 2500. The harbour, an inlet of the Gulf of Honduras, is deep, spacious and secure, and there is a railway pier at which vessels can load and discharge. The exports include bananas, coffee, cabinet woods, rubber, sarsaparilla, livestock, deerskins and gold. The harbour was discovered in 1527 by Gonzalo d'Avila, and the town was founded a few years later by order of Hernando Cortes, from whom it derives its name.

PUERTO DE SANTA MARIA, a seaport of southern Spain, in the province of Cadiz, on the right bank of the river Guadalete, with a station on the railway from Cadiz to Seville. Pop. (1900), 20,120. Puerto de Santa Maria, commonly called "El Puerto," is probably the *Menesethi Portus* of Ptolemy. Its most important industry is the wine trade; there are also glass,

liqueur, alcohol, starch and soap manufactures. The principal buildings are a Moorish citadel, a Gothic church founded in the 13th century, a Jesuit college, and a bull-ring which accommodates 12,000 spectators. The town is noted for its bull-fights, that given here in honour of Wellington being the subject of the considerably idealized description in Byron's *Childe Harold*.

PUERTO PRÍNCIPE (officially, CAMAGÜEY), a city and the capital of the province of Camagüey in east-central Cuba, about 528 m. E.S.E. of Havana. Pop. (1899), 25,102; (1907), 29,616. In addition to the axis-railway of the island, which connects it with Havana and Santiago, the city has connexion by a branch line with Nuevitas. Puerto Príncipe lies on a broad plain about equally distant from the north and south coasts of the island, and between two small rivers, the Tílima and Hatibonica. In appearance it is one of the most ancient of Cuban towns. Many of the churches, convents and other ecclesiastical establishments were built in the second half of the 18th century, some in the first half; and some parts of the original cathedral of 1617 have probably survived later alterations and additions. Some of the bridges, too, built in the 18th century, are picturesque. The city hall was begun in 1733. There is a provincial institute for secondary education. The city is the seat of a court of appeal. Puerto Príncipe is connected by railway, 47 m. long, with its port, Nuevitas (pop. in 1907, 4386), which is on the north side of the island and has a spacious land-locked bay of good depth, approached through a break in the off-lying coral keys and a narrow canyon entrance. About 50 m. south of Puerto Príncipe is Santa Cruz del Sur (pop. in 1907, 1640) on the south coast. Cabinet woods, fruit, tobacco, sugar, wax, honey and cattle products are the leading exports. In 1514 Diego Velasquez founded, on Nuevitas Bay (then known as the Puerto del Príncipe), a settlement that was moved in 1515 or 1516 to the site of the present city of Puerto Príncipe (or Santa Maria del Puerto del Príncipe). From very early times the surrounding plains were given over to horse and cattle-raising. As early as the beginning of the 17th century Havana depended on this supply to furnish the fleets of royal ships which monopolized trade between Spain and America. From very early times, too, a prosperous clandestine trade was maintained with Providence, the Bahamas, and especially with Curaçoa and Jamaica (after its capture by the English in 1655). After the capital, Puerto Príncipe was the richest prize of the island when it was captured and plundered in 1668 by a force of Frenchmen and Englishmen under Henry Morgan, the buccaneer. In the 18th century land grants and illicit trade led to serious disturbances. In 1775 Nuevitas was resettled, and in 1780 was made a legal (*habilitado*) port. After the cession of Santo Domingo to France in 1800, the Real Audiencia, the supreme court of the Spanish West Indies, was removed to Puerto Príncipe. A superior *audiencia* was created for Havana in 1838, but the older court continued to exist throughout the Spanish period. Puerto Príncipe boasts of being the most Creole of Cuban cities. It was prominent in the war of 1868-78 and in the disaffection preceding and following it.

PUERTO REAL, a seaport of southern Spain, in the province of Cadiz; on the north shore of the inner arm of the Bay of Cadiz and on the Seville-Cadiz railway. Pop. (1900), 10,535. Puerto Real (Port Royal) is the *Portus Gaditanus* of the Romans, and is probably the most ancient trading-station on the Bay of Cadiz. It owes its modern name to the fact that it was rebuilt in 1488 by Ferdinand and Isabella. The port has good quays, a dry dock of the Spanish Transatlantic Company, connected with their important works, and safe anchorage close to the wharves for the largest steamers. The town has fine squares, and broad, well-built streets, a handsome town-hall, many schools, a bull-ring, several convents, and a 16th-century Gothic parish church, with three naves and a remarkable atrium. There is an active trade in wine and oils; other industries are the construction and repairing of ships, and the production of salt.

PUFENDORF, SAMUEL (1632-1694), German jurist, was born at Chemnitz, Saxony, on the 8th of January 1632. His father was a Lutheran pastor, and he himself was destined for the ministry. Educated at Grimma, he was sent to study theology

at the university of Leipzig. Its narrow and dogmatic teaching was profoundly repugnant to him, and he soon abandoned it for the study of public law. He went so far as to quit Leipzig altogether, and betook himself to Jena, where he formed an intimate friendship with Erhard Weigel the mathematician, whose influence helped to develop his remarkable independence of character. Pufendorf quitted Jena in 1637 and became a tutor in the family of Petrus Julius Coyet, one of the resident ministers of Charles Gustavus, king of Sweden, at Copenhagen. At this time Charles Gustavus was endeavouring to impose upon Denmark a burdensome alliance, and in the middle of the negotiations he brutally opened hostilities. The anger of the Danes was turned against the envoys of the Swedish sovereign; Coyet, it is true, succeeded in escaping, but the second minister, Steno Bjelke, and the whole suite were arrested and thrown into prison. Pufendorf shared this misfortune, and was subjected to a strict captivity of eight months' duration. He occupied himself during this time in meditating upon what he had read in the works of Grotius and Hobbes. He mentally constructed a system of universal law; and, when, at the end of his captivity, he accompanied his pupils, the sons of Coyet, to the university of Leiden, he was enabled to publish, in 1661, the fruits of his reflections under the title of *Elementa jurisprudentiæ universalis, libri duo*. The work was dedicated to Charles Louis, elector palatine, who created for Pufendorf at Heidelberg a new chair, that of the law of nature and nations, the first of the kind in the world. In 1667 he wrote, with the assent of the elector palatine, a tract, *De statu imperii germanici, liber unus*. Published under the cover of a pseudonym at Geneva in 1667, it was supposed to be addressed by a gentleman of Verona, Severinus de Monzambano, to his brother Laelius. The pamphlet made a great sensation. Its author directly arraigned the organization of the Holy Roman Empire and exposed its feebleness, denounced in no measured terms the faults of the house of Austria, and attacked with remarkable vigour the politics of the ecclesiastical princes. Before Pufendorf, Philipp Bogislaw von Chemnitz, publicist and soldier, had written, under the pseudonym of "Hippolytus a Lapide," *De ratione status in imperio nostro romano-germanico*. Inimical, like Pufendorf, to the house of Austria, Chemnitz had gone so far as to make an appeal to France and Sweden. Pufendorf, on the contrary, rejected all idea of foreign intervention, and advocated that of national initiative. In 1670 Pufendorf was called to the university of Lund. His sojourn there was fruitful. In 1672 appeared the *De jure naturæ et gentium, libri octo*, and in 1675 a résumé of it under the title of *De officio hominis et civis*.

In the *De jure naturæ et gentium* Pufendorf took up in great measure the theories of Grotius and sought to complete them by means of the doctrines of Hobbes and of his own ideas. His first important point was that natural law does not extend beyond the limits of this life and that it confines itself to regulating external acts. He combated Hobbes's conception of the state of nature and concluded that the state of nature is not one of war but of peace. But this peace is feeble and insecure, and if something else does not come to its aid it can do very little for the preservation of mankind. As regards public law Pufendorf, while recognizing in the state (*civitas*) a moral person (*persona moralis*), teaches that the will of the state is but the sum of the individual wills that constitute it, and that this association explains the state. In this a priori conception, in which he scarcely gives proof of historical insight, he shows himself as one of the precursors of J. J. Rousseau and of the *Contrat social*. Pufendorf powerfully defends the idea that international law is not restricted to Christendom, but constitutes a common bond between all nations because all nations form part of humanity.

In 1677 Pufendorf was called to Stockholm as historiographer-royal. To this new period belong *Einleitung zur Historie der vornehmsten Reiche und Staaten*, also the *Commentarium de rebus suecicis, libri XXVI., ab expeditione Gustavi Adolphi regis in Germaniam ad abdicationem usque Christianæ* and *De rebus a Carolo Gustavo gestis*. In his historical works Pufendorf is hopelessly dry; but he professes a great respect for truth and generally draws from archives. In his *De habitu religionis christianæ ad vitam civilem* he traces the limits between ecclesiastical and civil power. This work propounded for the first

time the so-called "collegial" theory of church government (*Kollegialsystem*), which, developed later by the learned Lutheran theologian Christoph Mathæus Pfaff (1686-1760), formed the basis of the relations of church and state in Germany and more especially in Prussia.

This theory makes a fundamental distinction between the supreme jurisdiction in ecclesiastical matters (*Kirchenhoheit* or *jus circa sacra*), which it conceives as inherent in the power of the state in respect of every religious communion, and the ecclesiastical power (*Kirchengewalt* or *jus in sacra*) inherent in the church, but in some cases vested in the state by tacit or expressed consent of the ecclesiastical body. The theory was of importance because, by distinguishing church from state while preserving the essential supremacy of the latter, it prepared the way for the principle of toleration. It was put into practice to a certain extent in Prussia in the 18th century; but it was not till the political changes of the 19th century led to a great mixture of confessions under the various state governments that it found universal acceptance in Germany. The theory, of course, has found no acceptance in the Roman Catholic Church, but it none the less made it possible for the Protestant governments to make a working compromise with Rome in respect of the Catholic Church established in their states.

In 1688 Pufendorf was called to the service of Frederick William, elector of Brandenburg. He accepted the call, but he had no sooner arrived than the elector died. His son Frederick III. fulfilled the promises of his father; and Pufendorf, historiographer and privy councillor, was instructed to write a history of the Elector Frederick William (*De rebus gestis Frederici Wilhelmi Magni*). The king of Sweden did not on this account cease to testify his goodwill towards Pufendorf, and in 1694 he created him a baron. In the same year, on the 26th of October, Pufendorf died at Berlin and was buried in the church of St Nicholas, where an inscription to his memory is still to be seen.

Pufendorf was at once philosopher, lawyer, economist, historian and statesman. His influence was considerable, and he has left a profound impression on thought, and not on that of Germany alone. But the value of his work was much under-estimated by posterity. Much of the responsibility for this injustice rested with Leibnitz, who would never recognize the incontestable greatness of one who was constantly his adversary, and whom he dismissed as "vir parum jurisconsultus et minime philosophus." It was on the subject of the pamphlet of Severinus de Monzambano that their quarrel began. The conservative and timid Leibnitz was beaten on the battlefield of politics and public law, and the aggressive spirit of Pufendorf aggravated yet more the dispute, and so widened the division. From that time the two writers could never meet on a common subject without attacking each other.

See H. von Treitschke, "Samuel von Pufendorf," *Preussische Jahrbücher* (1875), xxxv. 614, and xxxvi. 61; Bluntschli, *Deutsches Staats-Wörterbuch*, viii. 424, and *Geschichte des allgemeinen Staatsrechts und der Politik*, p. 108; Lorimer, *The Institutes of the Law of Nations*, i. 74; Droysen, "Zur Kritik Pufendorfs," in his *Abhandlungen zur neueren Geschichte*; Roscher, *Geschichte der National-Oekonomie in Deutschland*, p. 304; Franklin, *Das deutsche Reich nach Severinus von Monzambano*.

PUFF-BALL, in botany, the common name for a genus of fungi (known botanically as *Lycoperdon*), and so called because of the cloud of brown dust-like spores which are emitted when the mature plant bursts. They are common in meadows and woods and on heaths or lawns, and when young resemble white balls, sometimes with a short stalk, and are fleshy in texture. If cut across in this state, they show a compact rind enclosing a loose tissue, in the interspaces of which the spores are developed; as the fungus matures it changes to yellowish-brown and brown and when ripe the rind tears at the apex and the spores escape through the aperture when any pressure is applied to the ball. When white and fleshy the fungus is edible. The fibrous mass which remains after the spores have escaped has been used for tinder or as a styptic for wounds. The giant puff-ball, *Lycoperdon giganteum*, reaches a foot or more in diameter.

PUFF-BIRD, the name first given, according to W. Swainson (*Zool. Illustrations*, 1st series, vol. ii., text to pl. 09), by English residents in Brazil to a group of birds now placed in the subfamily *Bucconinæ*, which with the *Galbulinæ* or jacamars form

the family *Galbulidae* of Coraciiform birds standing between the trogons (*q.v.*) and barbets, for a long time confounded, under the general name of barbets, with the *Capitonidae* of modern systematists. Each group has formed the subject of an elaborate monograph—the *Capitonidae* being treated by C. H. T. and G. F. L. Marshall (London, 1870–1871), and the *Bucconidae* by P. L. Sclater (London, 1879–1882). The *Bucconinae* are zygodactylous birds confined to the neotropical region, in the middle parts of which, and especially in its sub-Andean sub-region, they are, as regards species, abundant; while only two seem to reach Guatemala and but one Paraguay. As with most South American birds, the habits and natural history of the *Bucconidae* have been but little studied, and of only one species, which happens to belong to a rather abnormal genus, has the nidification been described. This is the *Chelidoptera tenebrosa*, which is said to breed in holes in banks, and to lay white eggs much like those of the kingfisher and consequently those of the jacamars. From his own observation Swainson writes (*loc. cit.*) that puff-birds are very grotesque in appearance. They will sit nearly motionless for hours on the dead bough of a tree, and while so sitting “the disproportionate size of the head is rendered more conspicuous by the bird raising its feathers so as to appear not unlike a puff-ball. . . . When frightened their form is suddenly changed by the feathers lying quite flat.” They are very confiding birds and will often station themselves a few yards only from a window. The *Bucconidae* almost without exception are very plainly-coloured, and the majority have a spotted or mottled plumage suggestive of immaturity. The first puff-bird known to Europeans seems to have been that described by G. de L. Marcgrav, under the name of “*tamatia*,” by which it is said to have been called in Brazil, and there is good reason to think that his description and figure—the last, comic as it is in outline and expression, having been copied by F. Willughby and many of the older authors—apply to the *Bucco maculatus* of modern ornithology—a bird placed by M. J. Brisson (*Ornithologie*, iv. 524) among the kingfishers. But if so, Marcgrav described and figured the same species twice, since his “*Matuitui*” is also Brisson’s “*Martin-pescheur tacheté du Brésil*.”

P. L. Sclater divides the family into 7 genera, of which *Bucco* is the largest and contains 20 species. The others are *Mala-coptila* and *Monacha*, each with 7, *Nonnula* with 5, *Chelidoptera* with 2, and *Micromonacha* and *Hapaloptila* with 1 species each. The most showy puff-birds are those of the genus *Monacha*, with an inky-black plumage, usually diversified by white about the head, and a red or yellow bill.

PUFFIN, the common English name of a sea-bird, the *Fratercula arctica* of most ornithologists, known however on various parts of the British coasts as the bottlenose, coulterneb, pope, sea-parrot and tammy-norie, to say nothing of other still more local designations, some (as marrott and willock) shared also with allied species of *Alcidae*, to which family it belongs. Of old time puffins were a valuable commodity to the owners of their breeding-places, for the young were taken from the holes in which they were hatched, and “being exceeding fat,” as Carew wrote in 1602 (*Survey of Cornwall*, fol. 35), were “kept salted, and reputed for fish, as coming nearest thereto in their taste.” In 1345, according to a document from which an extract is given in Heath’s *Islands of Scilly* (p. 190), those islands were held of the Crown at a yearly rent of 300 puffins¹ or 6s. 8d., being one-sixth of their estimated annual value. A few years later (1484), either through the birds having grown scarcer or money cheaper, only 50 puffins are said (*op. cit.* p. 196) to have been

¹ There cannot be much doubt that the name puffin given to these young birds, salted and dried, was applied on account of their downy clothing, for an English informant of Gesner’s described one to him (*Hist. avium*, p. 110) as wanting true feathers, and being covered only with a sort of woolly black plunage. It is right, however, to state that Caius expressly declares (*Rarior. animal. libellus*, fol. 21) that the name is derived “a naturali voce pupin.” Skeat states that the word is a diminutive, which favours the view that it was originally used as a name for these young birds. The parents were probably known by one or other of their many local appellations.

demanded. It is stated by both Gesner and Caius that they were allowed to be eaten in Lent. Ligon, who in 1673 published a *History of the Island of Barbadoes*, speaks (p. 37) of the ill taste of puffins “which we have from the isles of Scilly,” and adds “this kind of food is only for servants.” Puffins used to resort in vast numbers to certain stations on the coast, and are still plentiful on some, reaching them in spring with remarkable punctuality on a certain day, which naturally varies with the locality, and after passing the summer there leaving their homes with similar precision. They differ from most other *Alcidae* in laying their single egg (which is white with a few grey markings when first produced, but speedily begrimed by the soil) in a shallow burrow, which they either dig for themselves or appropriate from a rabbit, for on most of their haunts rabbits have been introduced. Their plumage is of a glossy black above—the cheeks grey, encircled by a black band—and pure white beneath; their feet are of a bright reddish orange, but the most remarkable feature of these birds, and one that gives them a very comical expression, is their huge bill. This is very deep and laterally flattened, so as indeed to resemble a coultter, as one of the bird’s common names expresses; but moreover it is parti-coloured—blue, yellow and red—curiously grooved and still more curiously embossed in places, that is to say during the breeding-season, when the birds are most frequently seen. But it had long been known to some observers that such puffins as occasionally occur in winter (most often washed up on the shore and dead) presented a beak very different in shape and size, and to account for the difference was a standing puzzle. Many years ago Bingley (*North Wales*, i. 354) stated that puffins “are said to change their bills annually.” The remark seems to have been generally overlooked; but it has proved to be very near the truth, for after investigations carefully pursued during some years by Dr Bureau of Nantes he was in 1877 enabled to show (*Bull. Soc. Zool. France*, ii. 377–399)² that the puffin’s bill undergoes what may be called an annual moult, some of its most remarkable appendages, as well as certain horny out-growths above and beneath the eyes, dropping off at the end of the breeding season, and being reproduced the following year. Not long after the same naturalist announced (*op. cit.* iv. 1–68) that he had followed the similar changes which he found to take place, not only in other species of puffins, as the *Fratercula corniculata* and *F. cirrhata* of the Northern Pacific, but in several birds of the kindred genera *Ceratorhina* and *Simorhynchus* inhabiting the same waters. The name puffin has also been given in books to one of the shearwaters which belong to the sub-family *Procellariina* of the Petrels (*q.v.*), and its latinized form *Puffinus* is still used in that sense in scientific nomenclature. This fact seems to have arisen from a mistake of Ray’s who, seeing in Tradescant’s Museum and that of the Royal Society some young shearwaters from the Isle of Man, prepared in like manner to young puffins, thought they were the birds mentioned by Gesner as the remarks inserted in Willughby’s *Ornithologia* (p. 251) prove; for the specimens described by Ray were as clearly shearwaters as Gesner’s were puffins.

PUGACHEV, EMEL'YAN IVANOVICH (? 1741–1775), Russian pretender, the date of whose birth is uncertain, was the son of a small Cossack landowner. He married a Cossack girl Sofia Nedyuzheva, in 1758, and the same year was sent with his fellow Cossacks to Prussia, under the lead of Count Zachary Chernuishev. In the first Turkish War (1769–74) of Catherine II. Pugachev, now a Cossack ensign, served under Count Peter Panin and was present at the siege of Bender. Invalided home, he led for the next few years a wandering life; was more than once arrested and imprisoned as a deserter; and finally, after frequenting the monasteries of the “Old Believers,” who exercised considerable influence over him, suddenly proclaimed himself (1773) to be Peter III. The story of Pugachev’s strong resemblance to the murdered emperor is a later legend. Pugachev dubbed himself Peter III. the better to attract to his standard all those (and they were many) who attributed their misery to

² See *Zoologist* for 1878, pp. 233–240.

the government of Catherine II., for Peter III. was generally remembered as the determined opponent of Catherine. As a matter of fact Pugachev and his followers were hostile to every form of settled government. The one thought of the destitute thousands who joined the new Peter was to sweep away utterly the intolerably oppressive upper-classes. Pugachev's story was that he and his principal adherents had escaped from the clutches of Catherine, and were resolved to redress the grievances of the people, give absolute liberty to the Cossacks, and put Catherine herself away in a monastery. He held a sort of mimic court at which one Cossack impersonated Nikita Panin, another Zachary Chernuishev, and so on. The Russian government at first made light of the rising. At the beginning of October 1773 it was simply regarded as a nuisance, and 500 roubles was considered a sufficient reward for the head of the troublesome Cossack. At the end of November 28,000 roubles were promised to whomsoever should bring him in alive or dead. Even then, however, Catherine, in her correspondence with Voltaire, affected to treat "*l'affaire du Marquis de Pugachev*" as a mere joke, but by the beginning of 1774 the joke had developed into a very serious danger. All the forts on the Volga and Ural were now in the hands of the rebels; the Bashkirs had joined them; and the governor of Moscow reported great restlessness among the population of central Russia. Shortly afterwards Pugachev captured Kazan, reduced most of the churches and monasteries there to ashes, and massacred all who refused to join him. General Peter Panin, the conqueror of Bender, was thereupon sent against the rebels with a large army, but difficulty of transport, lack of discipline, and the gross insubordination of his ill-paid soldiers paralysed all his efforts for months, while the innumerable and ubiquitous bands of Pugachev were victorious in nearly every engagement. Not till August 1774 did General Mikhelson inflict a crushing defeat upon the rebels near Tsaritsyn, when they lost ten thousand in killed and prisoners. Panin's savage reprisals, after the capture of Penza, completed their discomfiture. Pugachev was delivered up by his own Cossacks on attempting to fly to the Urals (Sept. 14), and was executed at Moscow on the 11th of January 1775.

See N. Dubrovin, *Pugachev and his Associates* (Rus.; Petersburg, 1884); Catherine II., *Political Correspondence* (Rus. Fr. Ger.; Petersburg, 1885, &c.); S. I. Gnyedich, *Emilian Pugachev* (Rus.; Petersburg, 1902). (R. N. B.)

PUGET, PIERRE (1622-1694), French painter, sculptor, architect and engineer, was born at Marseilles on the 31st of October 1622. At the age of fourteen he carved the ornaments of the galleys built in the port of his native city, and at sixteen the decoration and construction of a ship were entrusted to him. Soon after he went to Italy on foot, and was well received at Rome by Pietro di Cortona, who employed him on the ceilings of the Barberini Palace and on those of the Pitti at Florence. In 1643 he returned to Marseilles, where he painted portraits and carved the colossal figure-heads of men-of-war. After a second journey to Italy in 1646 he painted also a great number of pictures for Aix, Toulon, Cuers and La Ciotat, and sculptured a large marble group of the Virgin and Child for the church of Lorgues. His caryatides for the balcony of the Hôtel de Ville of Toulon were executed between 1655 and 1657. N. Fouquet employed Puget to sculpture a Hercules for his château in Vaux. The artist's desire to paint gradually subsided before his passion for sculpture, and a serious illness in 1665 brought Puget a prohibition from the doctors which caused him wholly to put aside the brush. The fall of Fouquet in 1666 found Puget at Genoa. Here he executed for Sublet des Noyers his French Hercules (Louvre), the statues of St Sebastian and of Alexandre Sauli in the church of Carignano (c. 1664), and much other work. The Doria family gave him a church to build; the senate proposed that he should paint their council chamber. But Colbert bade Puget return to France, and in 1669 he again took up his old work in the dockyards of Toulon. The arsenal which he had there undertaken to construct under the orders of the duke of Beaufort was destroyed by fire, and Puget, disheartened, took leave of Toulon. In 1685 he went

back to Marseilles, where he continued the long series of works of sculpture on which he had been employed by Colbert. His statue of Milo (Louvre) had been completed in 1682, Perseus and Andromeda (Louvre) in 1684; and Alexander and Diogenes (bas-relief, Louvre) in 1685, but, in spite of the personal favour which he enjoyed, Puget, on coming to Paris in 1688 to push forward the execution of an equestrian statue of Louis XIV., found court intrigues too much for him. He was forced to abandon his project and retire to Marseilles, where he remained till his death on the 2nd of December 1694. His last work, a bas-relief of the Plague of Milan, which remained unfinished, was placed in the council chamber of the town hall of his native city.

In spite of Puget's visits to Paris and Rome his work never lost its local character: his Hercules is fresh from the galleys of Toulon; his saints and virgins are men and women who speak Provençal. His best work, the St Sebastian at Genoa, though a little heavy in parts, shows admirable energy and life, as well as great skill in contrasting the decorative accessories with the simple surface of the nude. There is in the museum of Aix in Provence the bust of a long-haired young man in pseudo-classical costume which is believed to be a portrait of Louis XIV. made by Puget at the time of the king's visit in 1660.

See Léon Lagrange, *Pierre Puget* (Paris, 1868, with a catalogue of works); Charles Ginoux, *Annales de la vie de P. Puget* (Paris, 1894); Philippe Auquier, *Pierre Puget . . . biographie critique* (Paris, 1903).

PUGILISM (from Lat. *pugil*, boxer, Gr. *πύξ*, with clenched fist), the practice or sport of fighting with the fists. The first mention of such fighting in literature is found in the 23rd book of the *Iliad*, and shows that in Homer's time the art was already highly developed. The occasion was the games at the funeral of Patroclus, the champions engaged being Epeus, the builder of the wooden horse, and Euryalus. Each combatant seems to have been naked except for a belt, and to have worn the cestus. The fight ends with the defeat of Euryalus. According to Virgil (*Aeneid*, v.) similar games took place within the walls of Troy at the funeral of Hector, the principal boxers being Dares, the winner, and the gigantic Butex, a pupil of Amycus, Paris, the Trojan champion, abstaining from the contests. Further on we find the account of the games on the occasion of the funeral of Anchises, in the course of which Dares, the Trojan, receiving no answer to his challenge from the Sicilians, who stood aghast at his mighty proportions, claims the prize; but, just as it is about to be awarded him, Entellus, an aged but huge and sinewy Sicilian, arises and casts into the arena as a sign of his acceptance of the combat the massive cesti, all stained with blood and brains, which he has inherited from King Eryx, his master in the art of boxing. The Trojans are now appalled in their turn, and Dares, aghast at the fearful implements, refused the battle, which, however, is at length begun after Aeneas has furnished the heroes with equally matched cesti. For some time the young and lusty Dares circles about his gigantic but old and stiff opponent, upon whom he rains a torrent of blows which are avoided by the clever guarding and dodging of the Sicilian hero. At last Entellus, having got his opponent into a favourable position, raises his tremendous right hand on high and aims a terrible blow at the Trojan's head; but the wary Dares deftly steps aside, and Entellus, missing his adversary altogether, falls headlong by the impetus of his own blow, with a crash like that of a falling pine. Shouts of mingled exultation and dismay break from the multitude, and the friends of the aged Sicilian rush forward to raise their fallen champion and bear him from the arena; but, greatly to the astonishment of all, Entellus motions them away and returns to the fight more keenly than before. The old man's blood is stirred, and he attacks his youthful enemy with such furious and headlong rushes, buffeting him grievously with both hands, that Aeneas puts an end to the battle, though barely in time to save the discomfited Trojan from being beaten into insensibility.

Although fist-fighting was supposed by the Greeks of the classic period to have been a feature of the mythological games at Olympia, it was not actually introduced into the historical

Olympic contests until the 23rd Olympiad after the re-establishment of the famous games by Iphitus (about 880 B.C.). Onomastus was the first Olympic victor. In heroic times the boxers are supposed to have worn the ζῶμα, or belt, but in the Greek games the contestants, except for the cestus, fought entirely naked, since the custom had been introduced in the 15th Olympiad, and was copied by the contestants at the Pythian, Nemean, Isthmian and Panathenaic games (see GAMES, CLASSICAL). At Olympia the boxers were rubbed with oil to make them supple and limit the flow of perspiration, a precaution the more necessary as the Olympic games were held during the hottest part of the year. The cesti, of which there were several varieties, were bound on the boxers' hands and wrists by attendants or teachers acting as seconds. On account of the weight of the gloves worn, the style of boxing differed from that now in vogue (see BOXING), the modern straight-from-the-shoulder blow having been little used. Both Homer and Virgil speak of "falling blows," and this was the common method of attack, consisting more in swinging and hammering than in punching. The statue of a Greek boxer in the Louvre shows the right foot forward, the left hand raised as if to ward off a blow from above, and the right hand held opposite the breast, the whole attitude more resembling that of a warrior with sword and shield than of a modern boxer. The pugilists of Rome, who were in many cases Greeks and employed Greek methods, exaggerated the brutality of the fist-fight to please the Roman taste, and the sanguinary contest between Dares and Entellus, described above, although in some respects an anachronism as an account of a pugilistic battle in primitive times, was doubtless an exact portrayal of the encounters to be seen in Virgil's day in the circuses of Rome. Nevertheless it must not be understood that the boxing matches at the Greek games were not themselves severe to the point of brutality, in spite of the fact that style and grace of movement were sedulously taught by the masters of the time. The Greek champions trained for months before the games, but encounters between athletes armed with such terrible weapons as the loaded cestus were bound to result in very serious bruises and even disfigurement. Pluck was as highly thought of as at the present day, and it was related of a certain Eurydamas that, when his teeth were battered in, he swallowed them rather than show that he was hurt, whereupon his antagonist, in despair at seeing his most furious blows devoid of effect, gave up the battle. As, on account of the swinging style of blows, the ears were particularly liable to injury ear-protectors (ἀμφωτιδες) were generally used in practice, though not in serious combats. The so-called "pancratist's ear," swollen and mis-shapen, was a characteristic feature of the Greek boxer. The satirists of the time flung their grim jests at the champion bruisers. Lucilius writing of a Greek boxer of Etruria (*Anthologia epigrammatum graecorum*), says, "Aulos, the pugilist, consecrates to the God of Pisa all the bones of his cranium, gathering up one by one. Let him but return alive from the Nemean Games, O mighty Jupiter, and he will also offer thee, without doubt, the vertebrae of his neck, which is all he has left!"

The rules of Greek boxing were strict. No wrestling, grappling, kicking nor biting were allowed, and the contest ended when one combatant owned himself beaten. On this account pugilism and the *pancratium* (see below) were forbidden by Lycurgus, lest the Spartans should become accustomed to an acknowledgment of defeat (Plutarch, *Lycurgus*). In spite of the terrible injuries which often resulted from these contests it was strictly forbidden to kill an adversary, on pain of losing the prize. Rhodes, Aegina, Arcadia and Elis produced most of the Olympic victors in boxing, which was considered as an excellent training for war. According to Lucan (*Anach.* 3) Solon recommended it for pedagogic purposes, and the contest with the *sphairai*, or studded cesti, was added by Plato to his list of warlike exercises as being the nearest approach to actual battle.

The Greek athletic contest called *pancratium* (παγκράτιον, complete, or all-round, contest), which was introduced into

the Olympic games in the 38th Olympiad, was a combination of boxing and wrestling in which the contestants, who fought naked, not wearing even the cestus, were allowed to employ any means except biting to wring from each other the acknowledgment of defeat. Boxing, wrestling, kicking, dislocation of joints, breaking of bones, pulling of hair and strangling were freely indulged in. The fight began with sparring for openings and was continued on the ground when the contestants fell. Many pancratists excelled in obtaining quick holds of their opponents' fingers, which they crushed and dislocated so completely that all effective opposition ceased. Sudden attacks resulting in the dislocation of an arm or leg were also taught, reminding one of the Japanese jiu-jitsu. The *pancratium* was considered by the Greeks the greatest of all athletic contests and, needless to say, only the most powerful athletes attempted it. It became popular in Rome during the Empire and remained so until the time of Justinian.

Diagoras of Rhodes, his three sons and many grandsons, who were sung by Pindar (*Olymp.* 7), were the most celebrated of the Olympic boxing champions. One of the sons, Dorieus, was three times victorious at Olympia in the *pancratium*, and during his career won eight Olympian, eight Isthmian, seven Nemean and one of the Pythian prizes. Many famous champions also came from the Greek colonies, like the Locrian Euthymus, who conquered three times at Olympia. Another celebrated fighter and wrestler was Milo of Crotona (520 B.C.).

Boxing was evidently in vogue in very ancient times in Italy, imported, in all probability, from Greece, for Livy (i. 35) relates that, at the first celebration of the great Roman games (*ludi, romani magnique varie appellati*) by Tarquinius Priscus (6th century B.C.), boxers were brought from outlying provinces; and there was an old tradition that a school of pugilism flourished in Etruria in heroic times. During the republic boxing was cultivated as a gentlemanly exercise, and we find Cato the Elder giving his son instruction in the art (Plutarch, *Cato Major*). Tacitus (*Ann.* xvi. 3) says that the emperor Caligula imported the best Campanian and African pugilists for the gladiatorial games, and Strabo (iii. 3) records that the Lusitanians and also the Indians, who gave virgins as prizes, boxed. The art remained popular in Italy down to a late period of the Empire.

From the fall of the Roman Empire to the beginning of the 19th century pugilism seems to have been unknown among civilized nations with the single exception of the English.

The first references to boxing in England as a regular sport occur towards the end of the 17th century, but little mention is made of it before the time of George I., when "prize-fighters" engaged in public encounters for money, with the backsword, falchion, foil, quarter-staff and single-stick, and, to a less extent, with bare fists, the last gradually gaining in popularity with the decline of fencing. The most celebrated of these fighters and the one who is generally considered to have been the first champion of England, fighting with the bare fists, was James Figg, who was supreme from 1719 to 1730. Figg was succeeded by Pipes and Gretting, both of whom made way in 1734 for Jack Broughton, who built the amphitheatre for public displays near Tottenham Court Road and who was undisputed champion until 1750. Broughton seems to have been a man of intelligence, and to him is ascribed the scientific development of the art of boxing. During his time the sport became truly national and the prize-fighter the companion of the greatest in the land. Among Broughton's successors were Slack, "Big Ben" Brain, Daniel Mendoza (a Jew who flourished about 1790 and was the proprietor of the Lyceum in the Strand), J. Jackson, Tom Cribb, Jem Belcher, Pearce (called the "Game Chicken"), and John Gully, who afterwards represented Pontefract in Parliament.

To Broughton is ascribed the invention of boxing-gloves for use in practice. All prize-fights, however, took place with bare knuckles in roped-off spaces called rings, usually in the open air. Pugilists toughened their hands by "pickling" them in a powerful astringent solution. A fight ended when one

of the "bruisers," as they were called, was unable to "come to the scratch," i.e. the middle of the ring, at the call of the referee at the beginning of a new round. Each round ended when one fighter fell or was knocked or thrown to the ground, but a pugilist "going down to avoid punishment," i.e. without being struck by the opponent, was liable to forfeit the fight. Wrestling played an important rôle in the old prize-ring, and a favourite method of weakening an adversary was to throw him heavily and then fall upon him, seemingly by accident, as the manœuvre, if done intentionally, was foul. The fighting was of the roughest description, low tricks of all kinds being practised when the referee's attention was diverted, gouging out an adversary's eye being by no means unknown. Until 1795 pugilists wore long hair, but during a fight in that year Jackson caught Mendoza by his long locks and held him down helpless while he hit him. This was adjudged fair by the referee, with the result that prize-fighters have ever since cropped their head. Nevertheless there were rules which no fighter dared to overstep, such as those against kicking, hitting below the belt, and striking a man when he had fallen.

From the time of Cribb the English champions were Tom Spring (1824), Jem Ward (1825), Jem Burke (1833), W. Thompson, called "Bendigo" (1839-1845), Ben Caunt (1841), W. Perry, the "Tipton Slasher" (1850), Harry Broome (1851), Tom Sayers (1857-1860), Jem Mace (1861-1863), Tom King (1863), and again Mace, until 1872.

In America boxing began to be popular about the beginning of the 19th century. The first recognized national champion was Tom Hyer (1841-1848), who was followed by James Ambrose (born in Ireland), called "Yankee Sullivan"; John Morrissey (afterwards elected to the United States Congress); John C. Heenan; Tom Allen (of England); Jem Mace (of England); J. Kilrain; John L. Sullivan (1880-1891); J. J. Corbett (1892-1897); Robert Fitzsimmons (1897-1900) (born in Cornwall); James J. Jeffries. The defeat of the last named by the negro Jack Johnson in 1910 caused a great sensation.

What is still the most celebrated prize-fight of modern times took place at Farnborough in April 1860, between Tom Sayers and the huge youthful American pugilist J. C. Heenan, the "Benicia Boy," who had been defeated in America by Morrissey, but had succeeded to the championship upon the latter's retirement. The English champion was a much smaller and lighter man than his challenger, a fact which increased the popular interest in the fight. Although the local English authorities endeavoured to prevent it taking place, Heenan complaining that he had "been chased out of eight counties," the ring at Farnborough was surrounded by a company containing representatives of the highest classes, and the exaggerated statement was made that "Parliament had been emptied to patronize a prize-fight." The battle lasted for 2 hours and 20 minutes, during which Heenan, owing to his superiority in weight and reach, seemed to have the advantage, although nearly blinded by Sayers's hard straight punches. During one of the opening rounds a tendon in Sayers's right forearm was ruptured in guarding, and he fought the rest of the battle with a pluck which roused the enthusiasm of the spectators. Heenan had neglected to harden his hands properly, with the result that they soon swelled to unnatural proportions, rendering his blows no more effective than if he had worn boxing-gloves. Nevertheless towards the close of the fight Heenan repeatedly threw Sayers violently, and held him on the ropes enclosing the ring, which, just as the police interfered, were cut by persons who asserted that Heenan was on the point of strangling Sayers. In spite of the indecisive outcome of the battle both fighters claimed the victory, but the match was officially adjudged a draw. This was the last great prize-fight with bare fists on English soil, as public opinion was aroused, and orders were given to the police thenceforth to regard prize-fights as illegal, as tending to a "breach of the peace." Several surreptitious prize-fights did indeed occur within a few years after the Sayers-Heenan battle; but more than once, notably in the fight between Heenan and Tom King, one of the participants

was "doctored," i.e. drugged, and this lack of fairplay, added to the brutality of fist-fights, gave the death-blow to pugilism of the old kind. In its place came fighting and boxing with padded gloves, small ones weighing about 4 oz. being used by professionals, while amateurs, who boxed and sparred rather than fought (see BOXING), made use of larger and softer gloves.

An added impetus was given to boxing as well as pugilism in 1866 by the founding of the "Amateur Athletic Club" by John C. Chambers, who, assisted by the marquess of Queensberry, drew up the code of rules for competitions still in vogue and called after that nobleman, who, in 1867, presented cups for the amateur championships at the different weights. These rules prohibit all rough and unfair fighting, as well as wrestling, and divide a match into rounds of three (or two) minutes each, with half a minute rest between the rounds. It is a matter of agreement in professional battles whether in "breaking away" after a clinch blows may be struck or not. When a contestant is knocked down (a man on one knee is technically down) he is allowed ten seconds, usually counted aloud by the referee, in which to rise and renew the fight. Should he be unable to do so he is "counted out" and loses the match.

See *Fistiana* (London, 1868); *American Fistiana* (New York, 1876); Egan, *Boxiana* (London, 1818-1824); *Fencing, Boxing and Wrestling*, in the Badminton Library (London, 1889); R. G. A. Winn, *Boxing*, Isthmian Library (London, 1897).

PUGIN, AUGUSTUS WELBY NORTHMORE (1812-1852), English architect, son of Augustus Charles Pugin (1762-1832), a Frenchman by birth who settled in London as an architectural draughtsman and had several pupils who rose to fame, was born in Store Street, Bedford Square, on the 1st of March 1812. After an education at Christ's Hospital he entered his father's office, where he displayed a remarkable talent for drawing. His father was for many years engaged in preparing a large series of works on the Gothic buildings of England, almost, if not quite, the first illustrated with accurate drawings of medieval buildings; and the son's early youth was mostly occupied in making minute measured drawings for these books. In this way his enthusiasm for Gothic art was first aroused. All through his life, both in England and during many visits to Germany and France, he continued to make great numbers of drawings and sketches, in pen and ink or with sepia monochrome, perfect in their delicacy and precision of touch, and masterpieces of skilful treatment of light and shade. At first he acted as assistant in his father's work, and his own independent efforts to obtain business were not very successful. In 1827 he was employed to design furniture in a medieval style for Windsor Castle; and in 1831—the year he married his first wife, Ann Garnett, who died in childbirth a year later—he designed scenery for the new opera of *Kenilworth* at Her Majesty's theatre. But he got into money difficulties, and soon after his marriage he was imprisoned for debt. When he came out he again incurred serious losses over an attempt to start a shop for supplying architectural accessories of his own designing, which he had to give up. But after his second marriage in 1833 to Louisa Burton (d. 1844), and his reception into the Roman Catholic Church shortly afterwards, he began to obtain more steady architectural practice and by degrees he acquired the reputation which has made his name stand foremost among those responsible for the English Gothic revival (see ARCHITECTURE: *Modern*: "The Gothic Revival"). No man had so thoroughly mastered the principles of the Gothic style in its various stages, both in its leading lines and in the minutest details of its mouldings and carved enrichments. In 1837-1843 he assisted Sir Charles Barry by working out the details of the designs for the new Houses of Parliament at Westminster; and though his exact share in the designs was subsequently the subject of bitter controversy after both he and Barry were dead, there is no doubt that, while he was working as Barry's paid clerk, a great deal in the excellence of the details was due to him and to his training of the masons and carvers. His conversion to Roman Catholicism, while part and parcel of his

devotion to Gothic art, naturally brought him employment as an architect mainly from Roman Catholics; and many of his executed works suffered from the fact that his designs were not fully carried out, owing to a desire to save money or to spend it so as to make the greatest possible display. For this reason his genius is often more fairly displayed by his drawings than by the buildings themselves. In almost every case his design was seriously injured, both by cutting down its carefully considered proportions and by introducing shams (above all things hateful to Pugin), such as plaster groining and even cast-iron carving. The cathedral of St George at Southwark, and even the church in Farm Street, Berkeley Square, London, are melancholy instances of this. Thus his life was a series of disappointments; no pecuniary success compensated him for the destruction of his best designs, as in him the man of business was thoroughly subordinate to the artist. He himself used to say that the only church he had ever executed with unalloyed satisfaction was the one at Ramsgate, which he not only designed but paid for. Pugin was very broad in his love for the medieval styles, but on the whole preferred what is really the most suited to modern requirements, namely the Perpendicular of the 15th century, and this he employed in its simpler domestic form with much success both in his own house at Ramsgate and in the stately Adare Hall in Ireland built for Lord Dunraven. The cathedral of Killarney and the chapel of the Benedictine monastery of Douai were perhaps the ecclesiastical buildings which were carried out with least deviation from Pugin's original conception.

Apart from his work as an architect, his life presents little of detail to record. In 1836 he published his *Contrasts; or a Parallel between the Architecture of the 15th and 19th centuries*, in which he seriously criticized the architecture of Protestantism. His other principal publications were *True Principles of Christian Architecture* (1841); *Glossary of Ecclesiastical Ornament* (1844); and *Treatise on Chancel Screens and Rood Lofts* (1851). He was a skilful etcher, and illustrated in this way a number of his works, which were written with much eloquence, great antiquarian knowledge and considerable humour. This last gift is exemplified in a series of etched plates in his *Contrasts*; on one side is some noble structure of the middle ages, and on the other an example of the same building as erected in the 19th century. In 1849 he married a third wife, daughter of Thomas Knill. Early in 1852 he was attacked by insanity, and he died on the 14th of September that year. His eldest son by his second wife, Edward Welby Pugin (1834-1875), was also an accomplished architect, who carried on his father's work.

See B. Ferrez, *Recollections of A. W. Pugin and his Father* (London, 1861).

PUISNE (from O. Fr. *puisné*, modern *puîné*, later born, inferior; Lat. *postea*, afterwards, and *natus*, born), a term in law meaning "inferior in rank." It is pronounced "puny," and the word, so spelt, has become an ordinary adjective meaning weak or undersized. The judges and barons of the common law courts at Westminster, other than those having a distinct title, were called *puisne*. By the Supreme Court of Judicature Act 1877, a "puisne judge" is defined as a judge of the High Court other than the lord chancellor, the lord chief justice of England, the master of the rolls, the lord chief justice of the common pleas, and the lord chief baron, and their successors respectively.

PUJAH, or **POOJA**, the Hindu ceremonies in idol-worship. Colloquially the word has come to be applied by Anglo-Indians to any kind of rite; thus "pujah of the flag" is the sepoy term for trooping of the colours.

PUKET (also known by the Chinese name *Tongkah*), the first Siamese port on the west coast of the Malay Peninsula, situated on the eastern side of the island of Junk Ceylon (Malay, "Ujong Salang") in 7° 50' N. and 98° 24' E. It is the headquarters of the high commissioner of the Siamese administrative division of the same name, and has a population of about 30,000, of which more than a third is Chinese. Beneath the town and around it lie deposits of tin ore which have been worked by Chinese from ancient times, and the extraction of which still furnishes

occupation for the majority of the inhabitants. In 1907, dredging for tin in the harbour was undertaken by a European company. Puket has been a resort of European merchants since the 16th century. During the ancient wars between Siam and Burma it was more than once attacked by the latter, but was relieved by forces from Nakhon Sri Tammarat (Ligore) on the mainland. The Siamese mining department has a branch at Puket under control of European officers.

PULASKI, CASIMIR, COUNT (1748-1779), Polish soldier, was born in Podolia in 1748, and took a prominent share, under his father Count Joseph Pulaski, in the formation of the confederation of Bar and in the military operations which followed, becoming ultimately commander-in-chief of the Polish patriot forces. Driven into exile about 1772, Pulaski went to America and joined the army of Washington in 1777. He distinguished himself at once in the battle of Brandywine, was made a brigadier-general and chief of cavalry by Congress, and fought at Germantown, and in the battles of the winter 1777-78, after which he raised a mixed corps called the Pulaski legion. At the head of this force he won further distinction in the southern theatre of war, and successfully defended Charleston in May 1779. He was mortally wounded soon afterwards at the unsuccessful attack on Savannah (Oct. 9) and died two days later on board ship. Congress voted a monument to his memory; and though this vote has never been carried into execution, Lafayette laid the corner-stone of a monument in Savannah in 1824, and this was completed in 1855.

PULCI, LUIGI (1431-1487), Italian poet, was born at Florence, of a well-connected family. His elder brother Luca (d. 1470) was also a poet, author of *Pistole*, *Driadeo d'amore*, and *Ciriffo Calvaneo*. Luigi was patronized by Cosimo, Piero, and Lorenzo de' Medici, and was the author of various works in poetry and prose. He is famous, however, as the first to bring artistic romance into Italian literature in his heroic poem *Morgante Maggiore* (Venice, 1481), an epic of a giant converted to Christianity, who accompanies Orlando (Roland). (See ITALIAN LITERATURE.)

PULGAR, HERNANDO DE (1436-c. 1492), Spanish prose-writer, was born at Pulgar (near Toledo) in 1436 and was educated at the court of John II. Henry IV. made him one of his secretaries, and under Isabella he became councillor of state, was charged with a mission to France, and in 1482 was appointed historiographer-royal. He is said to have died in 1492. His *Crónica de los Reyes Católicos*, wrongly ascribed in the first edition (1565) to Antonio de Lebrija, is often inaccurate and always obsequious; but the record is not without value as regards events within the author's personal experience. Pulgar's *Claros Varones de Castilla* (1486), an account of celebrities at the court of Henry IV., is interesting in matter and style. He compiled a commentary (1485?) on the *Coplas de Mingo Revulgo*. His *Letters*, written to various persons of eminence, were first published in 1485-1486.

PULICAT, a town of British India, in Chingleput district, Madras, 25 m. N. of Madras city. Pop. (1901), 5448. The Dutch built a fort here as early as 1609, and it was for a long time their chief settlement on the Coromandel coast. Repeatedly captured, it did not finally become British until 1825. It gives its name to the Pulicat lake, a shallow lagoon stretching for about 37 m. along the coast. The seaward side is formed by the island of Sriharikot, which supplies firewood to Madras city.

PULKOVO, or **PULKOWA**, a village of Russia, in the government of St Petersburg, 10 m. S. of the city of St Petersburg. Pop. 2000. It contains the Pulkovo observatory, on a hill 248 ft. high, in 59° 46' 18" N. and 30° 19' 40" E. It was built in 1833-1839.

PULLEY, a wheel, either fixed to a turning axle or carried freely on a stationary one, the periphery of which is adapted to receive some form of wrapping connector. A pulley carried on a rotating shaft and connected to another pulley on a second shaft by an endless band consisting of a flat belt, rope, chain or similar connector serves for the transmission of power from the one shaft to the other and is known as a driving pulley;

while combinations of pulleys or "sheaves," mounted in fixed or movable frames or "blocks," constitute mechanisms used to facilitate the raising of heavy weights. The word appears in Mid. Eng. as *pulley* or *polley* (late), also as *poleyne* (*Prompt. Parul.*). The first forms seem to be from the O. Fr. *poulic*, which itself is regarded as coming from the O. Eng. *pullēan*, to pull. The Low Lat. forms *polea*, *polegia*, whence Span. *polea* and Ital. *poleggia*, are apparently from the Fr. *poulic*. The earliest form, *poleyne*, is represented in Fr. by *poulain*, literally a colt, Low Lat. *pullanus*, *pullus*, the young of any animal, the root of which is seen in English "foal." *Poulain* was used of a rope to let casks down into a cellar or to raise heavy weights. The use of the name of an animal for a mechanical device is not uncommon, cf. "crane," or "casel," from Du. *exel*, literally "little ass."

Driving pulleys are usually constructed of cast iron, and are of circular form, having a central nave by which they are secured to the shaft by keys or other fastenings, and straight or curved arms connecting the nave to the rim, which latter is of a form adapted to the connector. Pulleys are usually cast in one piece, and the proportions of the various parts are designed to resist the unknown stresses due to contraction of the casting in cooling, in addition to the stresses to which pulleys are subjected in use. The rim is slightly wider than the belt, and is of such a section as will suffice to resist the stress due to the pull of the belt, which is commonly taken as 80 lb per inch of width for single belting and 140 lb per inch of width for double belting. The rim is also subject to a centrifugal tension of amount w^2/g pounds per square inch of section, where w is the weight in pounds of a length of one foot of the pulley rim one square inch in section, and v is the velocity of the rim in feet per second. This stress amounts to 1043 lb per square inch, if the velocity is 100 ft. per second. The combination of these stresses generally limits the rim velocity of cast-iron pulleys to 80 or 100 ft. per second. The dimensions of the nave depend to a large extent on the method of keying or otherwise securing the pulley to the shaft. The number of the arms is arbitrary, and they may be curved to diminish the liability to fracture from contraction in the cooling of the cast iron, but in other respects are preferably straight, since they are then lighter and stronger. The arms are elliptical in cross-section, diminishing from the nave to the rim, and are usually designed as equally loaded cantilevers, fixed at the nave and free at the rim. These assumptions are probably not nearly correct and, as the stresses caused by the cooling of the casting are unknown, it is necessary to choose a low working stress of about one ton per square inch. The statical experiments of C. H. Benjamin (*American Machinist*, 1898) on cast-iron pulleys loaded by a belt to imitate the conditions in practice led him to the conclusion that the rim is usually not sufficiently rigid to load the arms equally, and that the ends of the arms are subjected to bending movements of opposite sign, that at the nave being almost invariably the greater.

Pulleys are also built up of wrought iron and steel, and can then be constructed entirely free from internal stress; they are thus much lighter and stronger, and are not liable to fly to pieces like cast iron if they break.

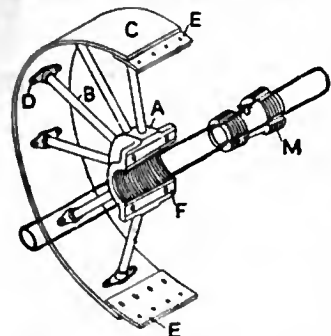

FIG. 1.—Built-up Pulley.
passing through the flanges F, and the pulley is connected to the

shaft by a sunk key or by conical keys driven in between the shaft and the boss, which latter is bored to suit. A modified form of this arrangement of cone keys is shown in the figure, in which a screwed conical bush M, divided into several parts longitudinally, is clamped round the shaft, and screwed into the corresponding part of the nave until the grip is sufficient. The parts of the bush are glued to a sheet of emery paper, so that its rough side may give a better grip on the shaft.

Pulleys are also made of paper, wood and other materials. Wooden pulleys are preferably made of maple, the rim being formed of small sections morticed, pinned and glued together, with the grain set in such directions that any warping of the material will leave the cylindrical form practically unaltered. Wooden pulleys are generally made in two halves, bolted together at the rim and nave, and are provided with wooden spokes dovetailed into the rim and secured by keys. The pulley is secured to the shaft by conical keys, to give a frictional grip on both the shaft and the pulley; these keys may have their exterior surfaces eccentric to the shaft, with corresponding recesses in the nave, so that the pulley and keys virtually form one piece.

If the centre of gravity of a pulley is on the axis of rotation, and the whole mass is distributed so that the axis of inertia coincides with the axis of rotation, there can be no unbalanced force or unbalanced couple as the pulley revolves. The magnitude of the unbalanced force, for a mass of w pounds at a radius of r feet and a velocity of v feet per second, is expressed by wv^2/gr lb; and, since the force varies as the square of the velocity, it is necessary carefully to balance a pulley running at a high speed to prevent injurious vibrations. This can be accomplished by attaching balance-weights to the pulley until it will remain stationary in all positions, when its shaft rests on two horizontal knife-edges in the same horizontal plane, or, preferably, the pulley and shaft may be supported on bearings resting on springs, and balanced by attached masses until there is no perceptible vibration of the springs at the highest speed of rotation.

The rims of pulleys, round which flat bands are wrapped, may be truly cylindrical, in which case the belt will run indifferently at any part of the pulley, or the rim may be swelled towards the centre, when the central line of the band will tend to run in the diametral plane of the pulley. This self-guiding property may be explained by the tendency which a flat band has, when running upon a conical pulley in a direction normal to its axis, to describe a spiral path as it wraps on to the surface because of the lateral stiffness of the material; the advancing side therefore tends to rise towards the highest part of the cone. If two cones are placed back to back the belt tends to rise to the ridge and stay there. In practice the pulley rim is curved to a radius of from three to five times its breadth, and this not only guides the belt, but allows the line of direction of the advancing side to deviate to a small extent, depending on the elasticity of the material.

Parallel shafts may be driven by flexible bands or connectors passing over pulleys, the central planes of which coincide, without any guiding arrangements for the belting. The shafts revolve in the same or opposite directions, according as the belt is open or crossed. Means of changing the relative speeds of rotation are furnished by pulleys of continuously varying diameter, or by speed cones (see *MECHANICS: Applied*). A common arrangement for driving a lathe spindle, in either direction at several definite speeds, is to provide a countershaft on which are mounted two fixed pulleys and two loose pulleys to accommodate two driving belts from the main shaft, one of which is open and the other crossed. The belts are moved laterally by the forks of a striking gear pressing on the advancing sides of the belts, and the pulleys are arranged so that the belts either wrap round the loose pulleys, or can be shifted so that one wraps round a fixed pulley, while the other still remains on its loose pulley. Motion in either direction is thereby obtained, and a considerable variation in the speed of rotation can be obtained by providing a cone pulley on the countershaft, which drives the cone pulley secured to the lathe

spindle by a separate band. The dimensions of the pulleys are generally so arranged that the return motion of the lathe spindle is faster than the forward motion. An alternative arrangement consists in providing two loose pulleys on the counter-shaft, driven by open and crossed belts respectively, and arranging two clutches on the shaft, so that by the movement of a sliding block, controlled by hand, one or other of the clutches can be put in gear.

The proportions of cone pulleys for open or crossed belts may be determined by considering the expression for the half length (l) of a belt wrapping round pulleys of radius r_1 and r_2 respectively, and with centres distant c apart. The value of l may be easily shown to be $(r_1+r_2)\pi/2+(r_1-r_2)a+c \cos a$, where the positive sign is to be taken for a crossed belt and the negative sign for an open belt. In determining the dimensions of corresponding drums of cone pulleys it is evident that for a crossed belt the sum of the radii of each pair remains a constant, since the angle a is constant, while for an open belt a is variable and the values of the radii are then obtained by solving the equations

$$r_1 = l/\pi - c(a \sin a + \cos a) + \frac{1}{2}c \sin a,$$

$$r_2 = l/\pi - c(a \sin a + \cos a) - \frac{1}{2}c \sin a.$$

The value of a is in general small, and an approximate solution may be obtained by substituting two or three terms of the expansions for $\sin a$ and $\cos a$. This, however, leads to a troublesome numerical solution. An accurate geometrical solution by C. Culmann gives

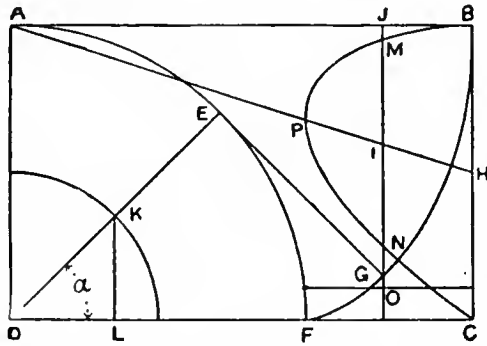

FIG. 2.

the linear equivalents of the above equations in the following manner. A rectangle ABCD (fig. 2), with side $AB = \pi c/2$ and $AD = c$, is constructed, and the quadrant AEF is drawn with centre D and radius DA. FB is the evolute of this circle, and for any radius DE at an angle a and corresponding tangent EG terminated by the evolute, the perpendicular distance of G from the line AD is $c(\cos a + a \sin a)$. If now a line be drawn from A to the bisector H of the side BC, it will meet the vertical through G in I and $IJ = c(\cos a + a \sin a)/\pi$. A circular arc, centre D and radius $c/2$, meets DE in K, and the perpendicular KL gives $\frac{1}{2}c \sin a$. This distance is marked off from the point I in each direction, whereby the points M and N are obtained, the distance apart of which represents the value $r_1 - r_2$. If now the value $l/\pi = OJ$ be marked off, and a horizontal line be drawn through the point O, the line OM represents $r_1 + r_2$. Repeating this construction for all values of a between 0° and 90° , we obtain a curve BPC, which can be used for determining the ratios of corresponding drums of cone pulleys or of conical drums for open belts. The curve BPC is generally used with the abscissae spaced more conveniently for practical applications, and a modification of the diagram by J. F. Klein (*Journ. Franklin Inst.*, vol. lxxix.) is often used instead.

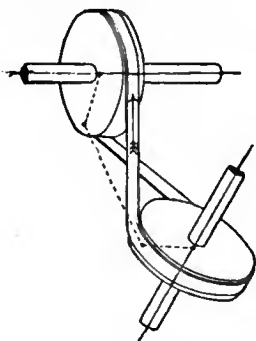

FIG. 3.

When pulleys are mounted on shafts which are parallel to one another, the band will retain its position, provided that its central line advances towards each pulley in the diametral plane of this latter. This condition is fulfilled in the example shown by fig. 3, in which the central planes of each pulley pass through the points of delivery of the other pulley for the given direction of motion. If the motion is reversed the condition is no longer satisfied and the belt will leave the pulleys. In more complicated cases guide pulleys must be used. In the most general case for inclined pulleys, any two points may be chosen on the line

of intersection of the diametral planes, and tangents drawn to the pitch circles of the pulleys. Guide pulleys are set with their diametral planes in the planes containing corresponding pairs of tangents, and a continuous belt wrapped round these pulleys in due order can then be run in either direction.

The rims of pulleys for hemp or other ropes or cords are grooved, and the sides are usually either inclined at 45° or curved to give a sharper angle at the outside than at the bottom of the groove; in the latter case, as the rope wears it engages in a groove of greater angle and less effective grip. Wire ropes are injured by the lateral crushing of the material, and in this case the grooves are wide enough to allow the rope to rest on the rounded bottom, which is lined with leather or wood to diminish the wear and increase the friction. In English practice there are as many separate endless ropes as there are pairs of grooves in the two pulleys to be connected, but in cases of American practice the rope is continuously wound round the two pulleys, and the free end passes over a pulley mounted on a movable weighted carriage to adjust the tension. It is of considerable importance that the effective radius of action of the rope remain constant throughout each pulley, otherwise the wear on the rope becomes very great and its life is diminished. The grooves must be turned exactly alike, and the rope must be of the same diameter throughout to diminish slip.

Pulleys may be detachably connected to a shaft by friction clutches, so that they may be thrown in and out of engagement at will. The section, fig. 4, shows a clutch for a rope-driven pulley A, which runs freely on a bush B on the shaft, and is provided with an enlarged cylindrical nave or clutch box C. A split ring D, carried by the clutch and turning with it, can be thrust against the clutch box by right- and left-handed screws E, so that a sufficient grip is obtained to cause the clutch and the pulley to turn as one piece. The engagement of the pulley and clutch is determined by a hand-controlled block F sliding on the shaft, the movement of which is communicated to the right- and left-handed screw shafts by links G connected to the levers H.

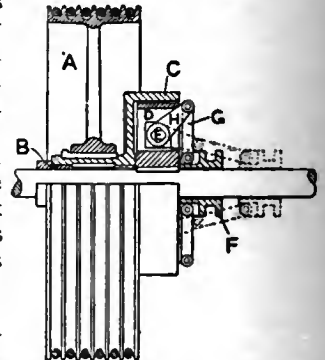

FIG. 4.

The resistance to slipping of a flat belt on a pulley may be obtained by considering the equilibrium of a small arc of the pulley surface subtending an angle $d\theta$ at the centre, and having tensions T and $T+dT$ at its extremities. Neglecting quantities of the second order, the pressure on the pulley is $Td\theta$, and the friction is $\mu Td\theta$ where μ is the coefficient of friction between the belt and the pulley. We have therefore $dT = \mu Td\theta$ and $dT/T = \mu d\theta$. Integrating the expression for an angle of wrapping θ , we obtain the relation $\log_e T_1/T_2 = \mu\theta$, where T_1 and T_2 are the end tensions. For leather belts on cast-iron pulleys the value of μ may be taken as 0.4, giving a ratio of the tensions on the tight and slack sides of $T_1/T_2 = 3.514$, when the angle of wrapping is 180° . For ropes in the grooves of cast-iron pulleys, where ϕ is the inclination of the sides of the grooves, the value of the normal pressure is increased in the ratio of $\text{cosec } \frac{1}{2}\phi = 1$. A usual value of μ for hemp ropes on cast-iron pulleys is 0.3, and the exponential log ratio is therefore $0.3\pi \text{ cosec } \frac{1}{2}\phi$ when $\theta = \pi$. At high speeds the centrifugal tension of the belt or rope, of amount wv^2/g , may be considerable, and must be subtracted from the end tensions.

Pulley Blocks.—Frames or blocks containing pulleys or sheaves are used in combination for lifting heavy weights. There are usually two blocks, of which one A (fig. 5) is fixed, and the other B is movable, and a rope or chain, with one end secured to one of the blocks at C, passes round the sheaves in a continuous coil, leaving a free end D at which the effort is applied. In the arrangement shown there are three equal sheaves in each block, and each set turns on a pin secured in the framing. The load, supported by the lower hook, is raised by hauling on the free end and, neglecting any slight obliquity of the plies of rope, the free end moves six times as fast

as the lower block carrying the weight, and in the absence of friction and other resistances the mechanical advantage will be in the same ratio of the effort to the resistance. In practice the full advantage of this or any other similar combination is not realized, because of the friction of the sheaves against the pin or shaft, and more important still is the stiffness of the rope, which requires work to be done upon it to bend it round the sheave and straighten it again. The effect of pin friction is equivalent to diminishing the radius of the effort and increasing that of the resistance.

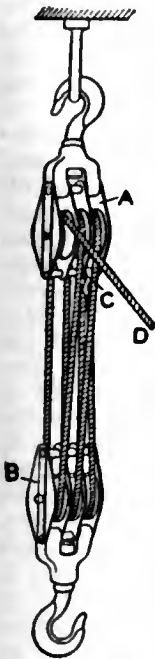

FIG. 5.—Sheave Pulley Block.

For a single pulley of diameter D , turning on a fixed pin of diameter d , the relation of the effort E to the load W , where f is the coefficient of friction, is expressed by $E/W = (D + fd)/(D - fd) = 1 + 2fd/D$ approximately. The resistance of the rope to bending causes an additional resistance, which experiment shows can be expressed in the form Wd^3/cD where c is a coefficient. Hence $E = W(1 + 2fd/D + d^3/cD) = kW$ for a single pulley. In a six-sheaved pulley tackle the relation between E and W may be expressed as $W = E(1/k + 1/k^2 + 1/k^3 + 1/k^4 + 1/k^5 + 1/k^6) = E(k^6 - 1)/k^6(k - 1)$, and with a probable value of $k = 1.1$ this gives $W = 4.355 E$ instead of $W = 6E$. If the free end of the rope is released the weight will descend, and the tackle is then said to overhaul. The conditions which enable a pulley tackle to sustain a weight when the effort is removed may be examined, to a first approximation, if we assume that the internal friction acts in such a way as virtually to diminish the effort E and to increase the resistance R by amounts proportional to the magnitude of each, and in addition to cause a loss M due to the weights of the parts themselves. We may therefore express the relation in the form $(1 - a)E = (1 + b)R + M$, whence we obtain $R/E = (1 - a)/(1 + b + M/R)$. If now the machine be reversed and R becomes an effort corresponding to a resistance E' then we have $R(1 - b) = (1 + a)E' + M$, giving

$$E'/R = (1 - b - M/R)/(1 + a). \tag{1}$$

If the load is self-sustaining E' is zero or negative, and hence $b + M/R$ must be equal to or greater than unity, and therefore it is impossible for the ratio of R/E to rise to a greater value than $(1 - a)/2$, and hence at least half the effort is wasted if the tackle

or greater than unity when the load is self-sustained, and we thus obtain a relation between R and E in the form $1 - a/2 - c$, which shows to a first approximation, that as c approaches unity a high efficiency is obtainable, while the self-sustaining power of the tackle is retained.

In order to obtain a greater ratio of R to E , without using a large number of sheaves, various arrangements are used, of which the Weston differential pulley block is a typical example. The upper block carries a pair of chain pulleys A (fig. 6), secured together and of slightly different effective diameters D and d . An endless chain B , passing through guides C and D , encircles these pulleys and the single loose pulley E of the lower block, as indicated. With this arrangement a single revolution of the upper sheave causes the endless chain to wind up on the one side by an amount πD , and to unwind an amount πd on the other side, and in consequence the lower sheave is raised by $\pi(D - d)/2$. Hence, neglecting friction, $E/D = \frac{1}{2}\pi(D - d)$, i.e. $E = \frac{1}{2}\pi R(1 - d/D)$. The value d/D usually lies between the limits $10/11$ and $15/16$, and, if a greater difference of E from R is required, a further mechanical advantage can be obtained by employing a separate hand-wheel and chain, or by forming the upper sheave with an annular spur-wheel gearing with a pinion driven by a hand-wheel and chain, as in the Tangeye form of Weston pulley-block. The efficiency of the Weston pulley-block is less than 50%, and it does not therefore overhaul. An objection to this form of block is the great length of the endless chain, which may drag on the ground and pick up dirt and grit, and thereby interfere with the smooth working of the mechanism. Other forms, which do not require so lengthy a chain, sometimes employ an epicyclic train to obtain the reduced velocity of the load. The Moore and Head block has two equal chain-wheels A, B , fig. 7, loosely mounted on an axle C , and provided with annular toothed gear-wheels which usually differ by one tooth. A spur pinion D , gearing with both wheels, is carried loosely upon an eccentric E forming part of the central pin, so that when this latter is turned by the hand-wheel F and chain G the axis of the pinion describes a circle the diameter of which equals the throw of the eccentric, and a small relative motion of the two sheaves takes place, depending on the number of the teeth of the annular wheels. The motion obtained is divided between the two vertical parts of the chain H , which is wrapped round each sheave in opposite directions, with a free loop I between, while the ends are attached to the lifting hook. This form is self-sustaining at all loads.

In order to obtain a self-sustaining pulley tackle, which will have an efficiency of more than 50%, various arrangements are

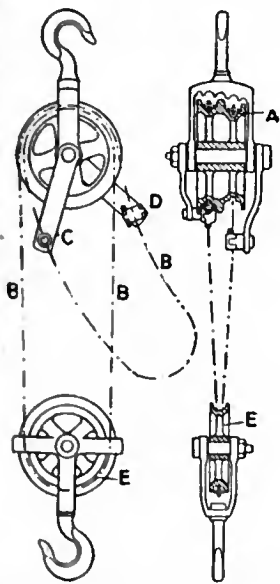

FIG. 6.—Weston Differential Pulley Block.

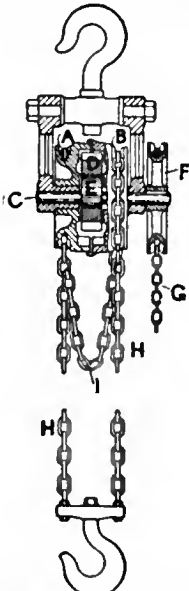

FIG. 7.—Moore and Head Pulley Block.

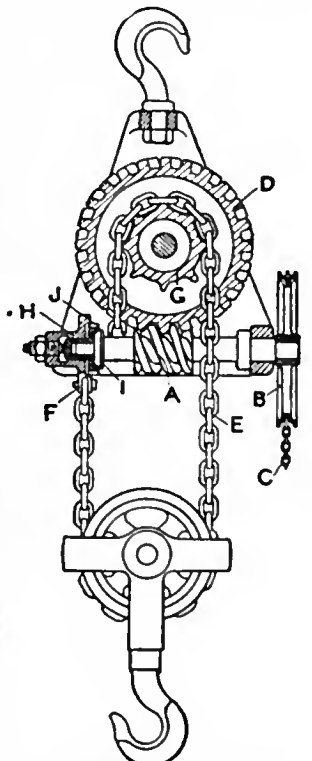

FIG. 8.—Worm-gear Pulley Block with Automatic Brake.

has the valuable property of sustaining a load when the effort is removed. If, however, an artificial resistance can be introduced, to come into action only when the effort is removed, it is possible to obtain a tackle of greater efficiency. As an example we may take the case where a brake is provided offering a resistance, $c R$, proportional to the load sustained, and where the values a and b are small compared with unity. Equation (1) becomes $E/R = (1 - b - c - M/R)/(1 + a)$, and hence $b + c + M/R$ is equal to

Blocks, for lifting very heavy weights, are sometimes provided with an electric motor for driving the worm. The worm-wheel shaft then sometimes carries a spur-pinion gearing with a spur-wheel on the lifting shaft, whereby a much greater mechanical advantage is obtained with a small loss by friction of the spur gearing.

REFERENCES.—W. J. M. Rankine, *Machinery and Millwork and Applied Mechanics*; W. C. Unwin, *Machine Design*; Ad. Ernst,

Die Hebezeuge; A. Ritter, *Lehrbuch der technischen Mechanik*; J. Weisbach and G. Herrmann, *The Mechanics of Hoisting Machinery*; F. Reuleaux, *Der Constructeur*; A. B. W. Kennedy, *Mechanics of Machinery*; J. Perry, *Applied Mechanics*; W. E. Dalby, *Balancing of Engines*.
(E. G. C.)

PULLMAN, formerly a town of Cook county, Illinois, U.S.A., and now a part of the city of Chicago. Here are the works of the Pullman Palace Car Company, steel forging plants, and other factories. The place was founded in 1880 by George Mortimer Pullman (1831-1897), the inventor of the Pullman sleeping car, and the founder (1867) of the Pullman Palace Car Company, who attempted to make it a "model town." Even the public works were the property of the Pullman Company and were managed as a business investment. Popular discontent with the conditions led to the annexation of Pullman to Chicago in 1889, but until 1910 the corporation held most of the property. In June and July 1894 a bitter railway strike developed from a controversy between employed and employers in the Pullman works. (See CHICAGO and ILLINOIS: *History*.)

PULPIT (from Lat. *pulpitum*, a staging, platform: equivalents are Fr. *chaire d'église*, Ital. *pulpito*, Ger. *Kanzel*), a raised platform with enclosed front, whence sermons, homilies, &c., were delivered. Pulpits were probably derived in their modern form from the *ambons* in the early Christian Church (see AMBO). There are many old pulpits of stone, though the majority are of wood. Those in churches are generally hexagonal or octagonal; and some stand on stone bases, and others on slender wooden stems, like columns. The designs vary accordingly to the periods in which they were erected, having panelling, tracing, cuspings, crockets, and other ornaments then in use. Some are extremely rich, and ornamented with colour and gilding. A few also have fine canopies or sounding-boards. Their usual place is in the nave, mostly on the north side, against the second pier from the chancel arch. Pulpits for addressing the people in the open air were common in the medieval period, and stood near a road or cross. Thus there was one at Spital Fields, and one at St Paul's, London. External pulpits still remain at Magdalen College, Oxford, and at Shrewsbury. Pulpits, or rather places for reading during the meals of the monks, are found in the refectories at Chester, Beaulieu, Shrewsbury, &c., in England; and at St Martin des Champs, St Germain des Prés, &c., in Paris; also in the cloisters at St Dié and St Lo. Shortly after the Reformation the canons ordered pulpits to be erected in all churches where there were none before. It is supposed that to this circumstance we owe many of the time of Elizabeth and James. Many of them are very beautifully and elaborately carved, and are evidently of Flemish workmanship. The pulpits in the Mahomedan mosques, which are known as "mimbars" are quite different in form, being usually canopied and approached by a straight flight of steps. These have a doorway at the foot, with an enriched lintel and boldly moulded head; the whole of the work to this and to the stairs, parapet and pulpit itself being of wood, richly inlaid, and often in part gorgeously painted and gilt.

PULQUE, or **PULQUE FUERTE**, the national beverage of the Mexican natives. It is prepared by fermenting the juice of a number of species of the agave (*agava potalorum, americana, &c.*). The cultivation of the agave for purposes of pulque manufacture constitutes a considerable local industry, the capital invested running into several millions sterling. The juice obtained by tapping the agave is termed *aguamiel*. A quantity of this is allowed to ferment naturally for about ten days, and the product so obtained is termed *madre pulque* (mother of pulque). A small quantity of this is added to fresh *aguamiel*, and thereby a rapid fermentation is induced, the pulque being ready for consumption within a day or two. It has a somewhat heavy flavour, resembling sour milk, but it is much esteemed by the natives on account of its cooling, and according to them wholesome and nutritious, properties.

PULSE. (1) (O. Fr. *pols*, Lat. *puls*, *pullis*, Gr. $\pi\acute{o}\lambda\tau\omicron\varsigma$, a porridge of beans, peas, &c.), in botany, a collective term for

beans, peas, and other members of the order Leguminosae (*q.v.*), which is characterized by having a legume or pod for the fruit. (2) (M. Eng. *pous*, *pouce*, O. Fr. *pous*, mod. *pousse*, Lat. *pulsus*, sc. *venarum*, the beating of the veins, *pellere*, to drive, beat), throbbing or beating; in physiology the rhythmical beating due to the changes of blood-tension in the arteries consequent on the contractions of their elastic tissues (see VASCULAR SYSTEM).

PULSZKY, FERENCZ AUREL (1814-1897), Hungarian politician and author, was born on the 17th of September 1814 at Eperjes. After studying law and philosophy at the high schools of his native town and Miskolcz, he travelled abroad. England particularly attracted him, and his fascinating book, *Aus dem Tagebuch eines in Grossbritannien reisenden Ungarns* (Pesth, 1837), gained for him the membership of the Hungarian Academy. Elected to the Reichstag of 1840, he was in 1848 appointed to a financial post in the Hungarian government, and was transferred in like capacity to Vienna under Esterhazy. Suspected of intriguing with the revolutionists, Pulszky fled to Budapest to avoid arrest. Here he became an active member of the committee of national defence, and when obliged to fly the country he joined Kossuth in England and with him made a tour in the United States of America. In collaboration with his wife he wrote a narrative of this voyage, entitled *White, Red, Black* (3 vols., London, 1853). He was condemned to death (1852) in *contumaciam* by a council of war. In 1860 he went to Italy, took part in Garibaldi's expedition to Aspromonte (1862), and was interned as a prisoner of war in Naples. Amnestied by the emperor of Austria in 1866, he returned home and re-entered public life; was from 1867-1876, and again in 1884, a member of the Hungarian Diet, joining the *Déak party*. In addition to his political activity, he was president of the literary section of the Hungarian Academy, and director of the National Museum at Budapest, where he became distinguished for his archaeological researches. He employed his great influence to promote both art and science and Liberal views in his native country. He died on the 9th of September 1897. Among his writings are *Die Jacobiner in Ungarn* (Leipzig, 1851) and *Eletem és Korom* (Pest, 1880), and many treatises on Hungarian questions in the publications of the Academy of Pest.

Some *Reminiscences* of Kossuth and Pulszky were published by F. W. Newman in 1888.

PULTUSK, a town of Russian Poland, in the government of Warsaw, 33 m. N. of the city of Warsaw, on the right bank of the Narew. Pop. (1897), 15,878. The town was almost entirely destroyed by fire in 1875. It is now well built, and had before the fire a palace (1319) which was formerly a residence of the bishops of Plock. The industries include woollen, linen and hosiery mills, copper works and potteries. In 1703 Charles XII. of Sweden defeated and captured the greater part of a Saxon army near this town, and in the same locality the French defeated the Russians in December 1806. The town was founded as early as 956.

PUMA, a name, probably of native origin, introduced into European literature by the early Spanish writers on South America (as Garcilaso de la Vega and Hernandez) for one of the largest cats (*Felis concolor*) of the New World. It is generally called "cougar" by the French, "leon" by the Spanish Americans, and "panther" by the Anglo-American hunters of the United States (see CARNIVORA). Though often spoken of as the American lion, chiefly on account of its colour, it rather resembles the leopard of the Old World in size and habits: usually measuring from nose to root of tail about 40 in., the tail being rather more than half that length. The head is small compared with that of other cats and has no mane. The ears are large and rounded. The tail is cylindrical, with some bushy elongation of the hairs near the end, but not forming a distinct tuft. The general colour of the upper parts and sides of the adult is a tawny yellowish brown, sometimes having a grey or silvery shade, but in some cases dark or inclining to red; and upon these and other differences, which are probably

constant locally, a number of sub-species have been named. The lower parts, inner surface of the limbs, throat, chin and upper lip are dirty white; the outside of the ears, particularly at their base, and a patch on each side of the muzzle black; the end of the tail dusky. The young are, when first born, spotted with dusky brown and the tail ringed. These markings generally fade, and quite disappear before the animal becomes full grown.

The puma has an exceedingly wide range of geographical distribution, extending over a hundred degrees of latitude, from Canada in the north to Patagonia in the south, and formerly was generally diffused in suitable localities from the Atlantic to the Pacific Ocean, but the advances of civilization have curtailed the extent of the districts which it inhabits. In



The Puma (*Felis concolor*).

Central America it is still common in the dense forests which clothe the mountain ranges as high as 8000 or 9000 ft. above the sea level. Though an expert climber, it is by no means confined to wooded districts, being frequently found in scrub and reeds along the banks of rivers, and even in the open prairie and prairies. Its habits much resemble those of the rest of the group to which it belongs; and, like the leopard, when it happens to come within reach of an abundant and easy prey, as the sheep or calves of an outlying farming station, it kills far more than it can eat, either for the sake of the blood only or to gratify its propensity for destruction. It rarely attacks man, and when pursued escapes if possible by ascending trees. Several instances have occurred of pumas becoming tame in captivity. Edmund Kean, the actor, had one which followed him about like a dog. When caressed pumas purr like domestic cats.

PUMICE (Lat. *pumex*, *spumex*, *spuma*, froth), a very porous, froth-like, volcanic glass. It is an igneous rock which was almost completely liquid at the moment of effusion and was so rapidly cooled that there was no time for it to crystallize. When it solidified the vapours dissolved in it were suddenly released and the whole mass swelled up into a froth which immediately consolidated. Had it cooled under more pressure it would have formed a solid glass or obsidian (*q.v.*); in fact if we take fragments of obsidian and heat them in a crucible till they fuse they will suddenly change to pumice when their dissolved gases are set free. Hence it can be understood that pumice is found only in recent volcanic countries. Artificial substances resembling pumice can be produced by blowing steam through molten glass or slag, and when a mass of slag is suddenly cooled by being tipped into the sea (as is the case at the blast furnaces of Whitehaven in Cumberland) it swells up into a pumiceous form so light and full of vesicles that it will float on water. Any type of lava, if the conditions are favourable, may assume the pumiceous state; but basalts and andesites

do not so often occur in this form as do trachytes and rhyolites. Pumices are most abundant and most typically developed from acid rocks; for which reason they usually accompany obsidians, in fact in Lipari and elsewhere the base of a lava flow may be black obsidian while the upper portion is a snow white pumice.

Small crystals of various minerals occur in many pumices; the commonest are felspar, augite, hornblende and zircon. If they are abundant they greatly diminish the economic value of the rock, as they are hard and wear down more slowly than the glassy material; consequently they produce scratches. The cavities of pumice are sometimes rounded, but may also be elongated or tubular owing to the flowing movement of the solidifying lava. The glass itself forms threads, fibres and thin partitions between the vesicles. Rhyolite and trachyte pumices are white, contain 60 to 75% of silica and the specific gravity of the glass is 2.3 to 2.4; andesite pumices are often yellow or brown; while pumiceous basalts, such as occur in the Sandwich Islands, are pitch black when perfectly fresh.

Good pumice is found in Iceland, Hungary, Nevada, Teneriffe, New Zealand, Pantellaria and the Lipari Islands. The last-named are the chief sources of pumice for the arts and manufactures. At Campo Bianco in Lipari there is an extinct volcanic cone with a breached crater from which a dark stream of obsidian has flowed. For industrial purposes the best varieties are obtained from Monte Pelato and Monte Chirica. The pumice is extracted by means of shafts and tunnels driven through the soft incoherent stone. It is brought out in blocks of irregular shape and size and is trimmed into slabs and graded into several qualities before it is exported to Canneto, which is the centre of the pumice trade. The workmen say that the good pumice occurs in beds or veins, which are probably lava flows and are separated by valueless rock or by obsidian. The value depends entirely on the regularity, size and shape of the steam cavities and on the absence of minute crystals. From time immemorial the extraction and sale of pumice have been one of the principal sources of wealth to the inhabitants of this island. An inferior pumice, known in Lipari as Alessandrina, is used for smoothing oilcloth. Though all the Aeolian Isles are volcanic no pumice is exported from any of the others. In Iceland, Teneriffe and Hungary pumice also occurs, but not in sufficient quantity or of such quality as to render it worth working on a large scale. It is estimated that in Lipari there are 170 pumice quarries (or mines) giving employment to 1200 persons and producing 6000 tons of pumice per annum. The price varies with the quality: from 3 lire per 100 kilogrammes for the commonest sorts to 200 or 300 lire for the best pieces, the average being about 15 lire. Much pumice is also used nowadays in the form of a fine powder, produced by crushing the rock, and forms an ingredient of metal polishes and some kinds of soap. It is often confounded with diatom earth or tripoli powder, but can easily be recognized by the aid of the microscope or by simple chemical tests.

Among the older volcanic rocks pumice occurs, but usually has its cavities filled up by deposits of secondary minerals introduced by percolating water; hence it is of no value for industrial purposes. Pumice, in minute fragments, has been shown to have an exceedingly wide distribution over the earth's surface at the present day. It occurs in all the deposits which cover the floor of the deepest portion of the oceans, and is especially abundant in the abyssal red clay. In some measure this pumice has been derived from submarine volcanic eruptions, but its presence is also accounted for by the fact that pumice will float on water for months, and is thus distributed over the sea by winds and currents. After a long time it becomes waterlogged and sinks to the bottom, where it gradually disintegrates and is incorporated in the muds and oozes which are gathering there. After the great eruption of Krakatoa in 1883 banks of pumice covered the surface of the sea for many miles and rose in some cases for four or five ft. above the water level. In addition to this much finely broken pumice was thrown into the air to a great height and was borne away by the winds, ultimately settling down in the most distant parts of the continents and oceans. (J. S. F.)

PUMP,¹ a machine which drives a liquid from one point to another, generally at different levels, the latter being usually the higher; an air-pump is an appliance for exhausting or

¹The word appears apparently first in English in the *Promptorium Parvulorum*, c. 1440, of a ship's pump (*hauritorium*), in Dutch (*pompe*), a little later, dialectically, of a conduit pipe for water, but in the sense of a means of raising water it does not occur in Dutch or Ger. before the 16th century. The Fr. *pompe* is derived from Teut. The Ger. variant of *Pumpe* is *Plumpe*, which is generally taken as being an echoic word, imitating the sound of the plunger, but the primary notion seems to be that of a pipe or tube. Cf. Ital. term, *tromba*, i.e. trumpet, pipe (see the note on the word in the *New English Dictionary*).

removing the air or other gas from a vessel, whilst a compression pump compresses the air. The simplest forms of pumps employed for forcing liquids are "plunger pumps," consisting essentially of a piston moving in a cylinder, provided with inlet and outlet pipes, together with certain valves. The disposition of these valves divides this type of pump into suction pumps and force pumps.

Fig. 1 shows the arrangement in a suction pump. A is the cylinder within which the piston B is moved up and down by the rod C.

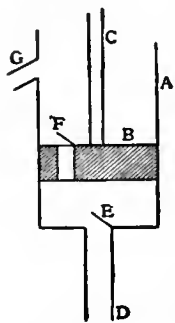

FIG. 1.

D is the inlet pipe (the lower extremity of which is placed beneath the surface of the liquid to be removed), and G is the outlet pipe. E is a valve in the inlet pipe opening into the cylinder; and the piston is perforated by one or more holes, each fitted with valves opening outwards on its upper surface. On raising the piston, the valve F remains closed and a vacuum tends to be created in the cylinder, but the pressure of the atmosphere forces the liquid up the tube D and it raises the valve E and passes into the cylinder. On reversing the motion the valve E closes and the liquid is forced through the valve F to the upper part of the cylinder. On again raising the piston, more liquid enters the lower part of the cylinder, whilst the previously raised liquid is ejected from the delivery pipe. Obviously the action is intermittent. Moreover, the height of the lift is conditioned by the atmospheric pressure, for this is the driving force; and since this equals 34 ft. of water, the lift cannot be theoretically more than this distance when water is being pumped. In practice it may be considerably less, owing to leakage at the valves and between the piston and cylinder.

In the force pump (fig. 2) there is no such limitation to the lift. In this case the piston is solid, and the outlet pipe, G which is placed at the bottom of the cylinder, has a valve F opening outwards, the inlet pipe and valve are the same as before.

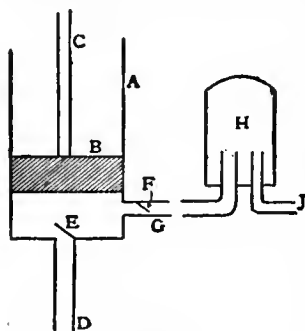

FIG. 2.

On raising the piston the liquid rises in the cylinder, the valve E opening and F remaining shut. On reversing the motion the valve E closes and the liquid is driven past the valve F. On again raising the piston the valve E opens admitting more liquid whilst F remains closed. It is seen that the action is intermittent, liquid only being discharged during a down stroke, but since the driving force is that which is supplied to the piston rod, the lift is only conditioned by the power available and by the strength of the pump. A continuous supply can be obtained by leading the delivery pipe into the base of an air chamber H, which is fitted with a discharge pipe J of such a diameter that the liquid cannot escape from it as fast as it is pumped in during a down stroke. The air inside is compressed in consequence and during an upstroke of the piston this air tends to regain its original volume and so expels the water, thus bringing about a continuous supply. For a description of modern pumps, see HYDRAULICS.

Air-pumps.—Pumps for evacuating vessels may be divided into three classes: (1) mechanical, (2) mercurial, and (3) jet pumps; the last named are treated in HYDRAULICS.

Mechanical. The invention of the mechanical air-pump is generally attributed to Otto von Guericke, consul of Magdeburg, who exhibited his instrument in 1654; it was first described in 1657 by Gaspar Schott, professor of mathematics at Würtemberg, in his *Mechanica hydraulico-pneumatica*, and afterwards (in 1672) by Guericke in his *Experimenta nova Magdeburgica de vacuo spatia*. It consisted of a spherical glass vessel opening below by means of a stop-cock and narrow nozzle into the cylinder of an "exhausting syringe," which inclined upwards from the extremity of the nozzle. The cylinder, in which a well-fitting piston worked, was provided at its lower end with two valves. One of these opened from the nozzle into the cylinder, the other from the cylinder into the outside air. During the down-stroke of the piston the former was pressed home, so that no air entered the nozzle and vessel, while the latter was forced open by the air which so escaped from the cylinder. During the return-stroke the latter was kept closed in virtue of the partial vacuum formed within the cylinder, while at the same time the former

was forced open by the pressure of the denser air in the vessel and nozzle. Thus, at every complete stroke of the piston, the air in the vessel or receiver was diminished by that fraction of itself which is expressed by the ratio of the volume of the available cylindrical space above the outward opening valve to the whole volume of receiver, nozzle and cylinder. The action is essentially that of the common suction pump. The construction was subsequently improved by many experimenters, notably by Boyle, Hawksbee, Smeaton and others; and more recently two pump barrels were employed, so obtaining the same degree of exhaustion much more rapidly. This type of pump is, however, not very efficient, for there is not only leakage about the valves and between the piston and cylinder, but at a certain degree of exhaust the air within the vessel is insufficient to raise the inlet valve; this last defect has been met in some measure by using an extension of the piston to open and close the valve.

The so-called oil air-pumps are much more efficient; the valve difficulty is avoided, and the risk of leakage minimized; whilst in addition there is no air clearance between the piston and the base of the cylinder as in the older mechanical forms. The Fleuss pump may be taken as an example. The piston, provided with a valve opening upwards, is packed in the cylinder by a leather cup which is securely pressed against the sides of the cylinder by the atmospheric pressure. The piston rod passes through a valve in the upper part of the cylinder which is held to its seat by a spring. The inlet pipe enters an elliptical vessel which communicates with the cylinder a little way up from its base, whilst at the base there is a relief tube leading into the elliptical vessel already mentioned. Oil is placed both above the upper valve seating, and also in the cylinder up to the height of the lower edge of the inlet pipe. The action is as follows: On raising the piston it cuts off communication with the inlet pipe and then compresses the air above, forcing it through the upper valve and oil into the atmosphere. Some of the oil is also driven out, but as the valve does not close until the piston has descended a short distance, a certain amount of oil returns. On lowering the piston its valve opens and air passes in from the vessel to be exhausted; this is further rarefied on the next stroke and so on. The Max Kohl pumps are based on the same principle, but are constructed with more elaborate detail, leading to a greater efficiency, an exhaust of 0.0008 mm. being claimed as readily obtainable.

The invention of the barometer and Torricelli's explanation of the vacuity above the mercury column placed before the members of the Florentine academy a ready method of obtaining vacua; for to exhaust a vessel it was necessary only necessary to join, by means of a tube provided with stop-cocks, the vessel to a barometer tube, fill the compound vessel with mercury and then to invert it in a basin containing this liquid, whereupon the mercury column fell, leaving a Torricellian vacuum in the vessel, which could be removed after shutting off the stop-cocks. This was the only method known until the invention of the mechanical air-pumps; it was subsequently employed by Count Rumford, and as late as 1845, Edward A. King patented filament electric lamps exhausted by the same methods. Although modern mercurial pumps have assumed a multiplicity of forms, their actions can be reduced to two principles, one statical, the other hydrodynamical—at the same time instruments have been devised utilizing both these principles.

Statical Pumps.—The earliest mercurial pump, devised by Swedenborg and described in his *Miscellanea observata circa res naturales* (1722), was statical in action, consisting essentially in replacing the solid piston of the mechanical pump by a column of mercury, which by being alternately raised and lowered gradually exhausted a vessel. A more complicated pump, but of much the same principle, was devised in 1784 by Joseph Baader, to be improved by C. F. Hindenburg in 1787, by A. N. Edelerantz in 1804 and by J. H. Patten in 1824; whilst in 1881 Rankine Kennedy resuscitated the idea for the purpose of exhausting filament electric lamps. The pump devised by

H. Geissler of Bonn, and first described in 1858 by W. H. Theo. Meyer in a pamphlet *Ueber das geschichtete elektrische Licht* surpassed all previous forms in both simplicity and efficiency.

The general scheme of Geissler's pump is shown in fig. 3. A and B are pear-shaped glass vessels connected by a long narrow india-rubber tube, which must be sufficiently strong in the body (or strengthened by a linen coating) to stand an outward pressure of 1 to 1½ atmospheres. A terminates below in a narrow vertical tube *c* which is a few inches longer than the height of the barometer, and to the lower end of this tube the india-rubber tube is attached which connects A with B. At the upper end of A is a glass two-way stop-cock, by turning which the vessel A can either be made to communicate with the vessel to be exhausted, or with the atmosphere, or can be shut off from both when the cock holds an intermediate position. The apparatus, after having been carefully cleaned and dried, is charged with pure and dry mercury which must next be worked backwards and forwards between A and B to remove all the air-bells. The air is then driven out of A by lifting B to a sufficient level, turning the cock

so as to communicate with the atmosphere and letting the mercury flow into A until it gets to the other side of the stop-cock, which is then placed in the intermediate position. Supposing the vessel to be exhausted to have already been securely connected to the pump, we now lower the reservoir B so as to reduce the pressure in A sufficiently below the tension in the gas to be sucked in, and, by turning the cock so as to connect A with the vessels to be exhausted, cause the gas to expand into and almost fill A. The cock is now shut against both communications, the reservoir lifted, the gas contents of A discharged and so on, until, when after an exhaustion mercury is let into A, the metal strikes against the top without interposition of a gas-bell. In a well-made apparatus the pressure in the exhausted vessel is now reduced to $\frac{1}{10}$ or $\frac{1}{20}$ of a millimetre, or even less. An absolute vacuum cannot be produced on account of the unavoidable air-film between the mercury and the walls of the apparatus.

As it takes a height of about 30 in. of mercury to balance the pressure of the atmosphere, a Geissler pump necessarily is a somewhat long-legged and unwieldy instrument; in addition, the long tube is liable to breakage. It can be considerably shortened, the two vessels A and B brought more closely together, and the somewhat objectionable india-rubber tube be dispensed with, if we connect the air-space in B with an ordinary air pump, and by means of it do the greater part of the sucking and the whole of the lifting work. An instrument thus modified was constructed by Poggenдорff in 1865.

Even a Geissler's stop-cock requires to be lubricated to be absolutely gas-tight, and this occasionally proves a nuisance. Hence a number of attempts have been made to do without stop-cocks altogether. In the pump generally attributed to Töpler, but which was previously devised by J. Mile of Warsaw in 1828, who termed it a "hydrostatic air-pump without cylinders, taps, lids or stoppers," this is attained by using, both for the inlet and the outlet, vertical capillary glass tubes, soldered, the former to somewhere near the bottom, the latter to the top of the vessel. These tubes, being more than 30 in. high, obviously act as efficient mercury-traps; but the already considerable height of the pump is thus multiplied by two. This consideration led Alexander Mitscherlich, F. Neisen and others to introduce glass valves in lieu of stop-cocks. A pump similar to Töpler's construction was devised by Mendeléeff, and the original device has been much improved by Wiedemann, Bessel-Hagen and others.

The best-known pump of this type was invented in 1865 by H. Sprengel, although the idea had been previously conceived by Magnus and Buff. The instrument, in its original (simplest) form (fig. 4), consists of a vertical capillary glass tube *a* of about 1 mm. bore, provided with a lateral branch *b* near its upper end, which latter, by an india-rubber joint governable by a screw-clamp, communicates with a funnel. The lower end is bent into the shape of a

hook, and dips into a pneumatic trough. The vessel to be exhausted is attached to *b*, and, in order to extract its gas contents, a properly regulated stream of mercury is allowed to fall through the vertical tube. Every drop of mercury, as it enters from the funnel, entirely closes the narrow tube like a piston, and in going past the place where the side tube enters entraps a portion of air and carries it down to the trough, where it can be collected. If the vertical tube, measuring from the point where the branch comes in, is a few inches greater than the height of the barometer, and the glass and mercury are perfectly clean, the apparatus slowly but surely produces an almost absolute vacuum.

The great advantages of Sprengel's pump lie in the simplicity of its construction and in the readiness with which it adapts itself to the collecting of the gas. It did excellent service in the hands of Graham for the extraction of gases occluded in metals. Many improvements upon the original construction have been proposed.

Many other devices have been introduced for facilitating the production of vacua. For example Raps in 1893 described an automatic arrangement to be used in connexion with a Töpler pump; whilst in 1893 Schulze-Berge devised a rotary form. For the description of these forms see Winkelmann, *Handbuch der Physik* (1906), i. 1316. The history of mercurial pumps is treated by S. P. Thompson, *The Development of the Mercurial Air Pump* (1888). For the production of high vacua, see VACUUM TUBE; LIQUID GASES.

PUMPKIN, the fruit of the gourd *Cucurbita Pepo*, well-known in English cottage gardens, and largely cultivated in continental Europe and North America. The pumpkin varies much in form, being sometimes nearly globular, but more generally oblong or ovoid in shape; the rind is smooth and very variable in colour. It is a useful plant to the American backwoods farmer, yielding, both in the ripe and unripe condition, a valuable fodder for his cattle and pigs, being frequently planted at intervals among the maize that constitutes his chief crop. The larger kinds acquire a weight of 40 to 80 lb but smaller varieties are in more esteem for garden culture. When ripe, the pumpkin is boiled or baked, or made into various kinds of pie, alone or mixed with other fruit; while small and green it may be eaten like the vegetable marrow. The name squash is applied in America to this and other species of the genus *Cucurbita*. The name is adapted from an American Indian word (see L. H. Bailey, *Cyclopaedia of American Horticulture*, where is a fuller account of the squashes). Summer squashes are mostly varieties of *C. Pepo*; winter squashes are either *C. maxima* or *C. moschata*, chiefly the former. The varieties of pumpkins and squashes are numerous and of great variety in size and shape; it is difficult to keep them pure if various kinds are grown together, but the true squashes (*C. maxima*) do not hybridize with the true pumpkin species. If carefully handled to avoid cracking of the skin, and kept dry and fairly warm, winter squashes may be kept for months.

PUN, a play upon words, particularly the use of a word in two or more different applications or of two or more words similar in sound but with different meanings by which a humorous or ludicrous effect is produced; thus Charles I.'s Court Jester is said to have made the punning grace "great praise be to God and little Laud to the devil" for which the archbishop dismissed him from his service. Another famous pun was that upon *The Beggar's Opera*, which "made Gay rich and Rich gay." Thomas Hood was the king of pun-makers. "They went and told the sexton, and the sexton toll'd the bell" ("Sally Brown") is one example among the innumerable puns with which his poems are filled. The derivation of the word is not known. It first appears in the second half of the 17th century. Skeat

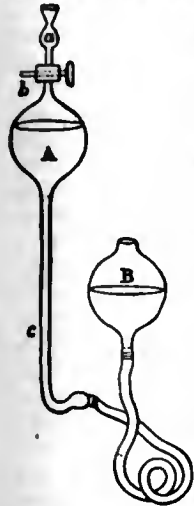

FIG. 3.
Geissler's Air-Pump.

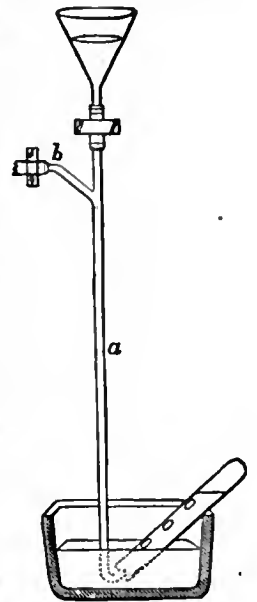

FIG. 4.
Sprengel's Air-Pump.

(*Elym. Dict.*, 1898) identifies it with an obsolete and dialectal variant of "pound," to beat in the sense of "to pound words, to beat them into new senses, to hammer at forced similes." The *New English Dictionary* considers it was probably one of the shortened words, like "mob," "cit," &c., which were common in slang after the Restoration. In R. L'Estrange, *Counsellor Manners's Last Legacy* (1676), "pun" is found with punnet, pundigrion and quibble, "of which fifteen will not make up one single jest." Possibly these may be all referred to "punctilio" (It. *puntiglio*, dim. of *punto*, point, Lat. *punctum*), a small, fine point, a cavil or quibble. No historical connexion, however, has been found between the words.

PUNCH, the abbreviated form of Punchinello (Ital. *Policinella*, *Pulcinella*), the most popular of the puppets or marionettes (*q.v.*), and the chief figure in the "Punch and Judy" show. It is of Italian origin, though its history is by no means free from obscurity. The earlier etymologists sought to trace the name to various mythical individuals, by whom, it was alleged, the type was first furnished. F. Galiani adopts the theory which derives it from the name of Puccio d'Aniello, a vintager of Acerra near Naples, who, having by his wit and grotesque appearance vanquished some strolling comedians in their own sphere, was induced to join the troop, and whose place, by reason of his popularity, was supplied after his death by a masked actor who imitated his dress and manner. The claims of other individuals—Paolo Cinella, Polliceno, and Pulcinella, a Neapolitan dealer in fowls—have also found supporters, and the derivation of the name and character from some old mystery representing Pontius (O. Eng. *Pownce*; Fr. *Ponce*) Pilate and Judas, or the Jews, was formerly popular. It has even been suggested that the title is a modification of *πολύ κινέω* (I move much) as expressive of the restlessness which is characteristic of the puppet; and the assumption that the character was invariably of diminutive size has given rise to its reference to the word *pollice*, the thumb (*cf.* *Däumling*, Tom Thumb). The most plausible theory, however, regards the name in its Italian form as a diminutive of *pulcino*, fem. *pulcina*, a chicken. It is sometimes stated that, in consequence of the habit of using the word "chicken" as a term of endearment, it came to mean "a little child," and hence "a puppet" (W. Skeat). But this again involves the assumption that the application of the name to the character was in some measure determined by the size of the puppets, whereas it would appear to have been transferred from the comic stage to the puppet show and the Pulcinella of the stage was not necessarily a dwarf. The choice, therefore, seems to lie between the theory of Quadrio, that it was applied on account of the resemblance of the hooked nose to a beak, and that of J. Baretta, which ascribes its employment to the nasal squeak and timorous impotence of the original character. With respect to the development of the modern type, it has been assumed that the whole family of Italian *maschere* (Arlecchino, Brighella, and the like) are modified survivals of the principal Oscan characters of the *Atellanae*, and that PUNCHINELLO is the representative of Maccus, the fool or clown. In proof of this it is urged that Acerra, the supposed residence of Puccio d'Aniello and the traditional source of the character, is in the neighbourhood of Aversa, the old Atella; and reference is also made to a bronze statue of Maccus, discovered at Rome in 1727, an engraving of which has been preserved in Ficoroni's *Le Maschere sceniche e le figure comiche d'antichi Romani*. But the resemblance of the statue to the puppet is scarcely to be termed a striking one, and the large nose and deformed figure are somewhat hazardous ground on which to base a theory—especially in view of the fact that such points of likeness as there are in it to the northern Punch are not to be found in the Neapolitan Pulcinella. It is possible that some relic of the old *Ludi Osci*, transmitted through the Vice of the mystery plays, is to be found in the character; but any direct descent from the Maccus of the *Atellanae* seems precluded by the fact that, while there are traces of the gradual development of the northern Punch from the Neapolitan Pulcinella, the latter with its grey hat, white smock and trousers, masked face, and undistorted body is widely

different from its alleged prototype. It seems necessary, therefore, to regard the Pulcinella as in large part a distinct creation of comparatively modern date. Prior to the 17th century there is no indication in the Italian burlesque poets of the existence of Pulcinella, though L. A. Riccoboni places the creation of the part before 1600.

Andrea Perrucci (1699) and Gimma assert with some show of authority that Silvio Fiorillo, a comedian named after his principal part Captain Matamoros (the Italian *Miles Gloriosus*), invented the Neapolitan Pulcinella. It was afterwards improved by Andrea Calcese, surnamed Ciuccio, who died of the plague in 1656, and who, according to Gimma, imitated in the character the peasants of Acerra. This would place the origin of the Italian Pulcinella somewhere about the commencement of the 17th century, the original character appearing to have been that of a country clown, hook-nosed, shrill-voiced, cowardly, boastful and often stupid, yet given at times to knavish tricks and shrewd sayings. In thorough accordance with this date, we find that the earliest known appearance of Polichinelle in France is at the beginning of the reign of Louis XIV., in the show of the puppet-playing dentist Jean Brioché. It might have been expected that the shrewder and wittier side of the character would most commend itself to the French mind, and there is good reason to believe that the Polichinelle of Brioché was neither a blunderer nor a fool. The puppet was almost immediately seized upon as the medium of political satire of the kind exemplified in the *Letter of Polichinelle to Cardinal Mazarin* (1649), and it is described in the *Combat de Cyrano de Bergerac*, as a "petit Ésope de bois, remuant, tournant, virant, dansant, riant, parlant, petant" and as "cet hétéroclite marmouset, disons mieux, ce drolifique bossu." In this there appears signs of transformation, whether the importation to France took place before or after the alleged improvements of Calcese. The hunchback had been long associated in France with wit and laughter, and there are, therefore, some grounds for C. Magnin's theory that the northern Punch is of French origin, a Gallic type under an Italian name, though there does not seem to be sufficient reason for adopting his suggestion that Polichinelle was a burlesque portrait of Béarnais. The date of its introduction into England has been disputed, J. Payne Collier being of opinion that Punch and King William came together, a second theory suggesting an earlier origin with the Huguenot refugees. In view of its popularity in France prior to the Restoration, however, it would be strange if its migration had been so long delayed, and it is more than probable that it crossed the channel in the wake of the Royalists. Apart from the general references by S. Pepys (1662) and by J. Evelyn (1667) to an Italian puppet-show at Covent Garden, the former makes mention (1669) of some poor people who called their fat child Punch, "that word being become a word of common use for all that is thick and short." An allusion to "Punchinellos" is also to be found in Butler's satire on English imitation of the French, and Aubrey speaks of "a Punchinello holding a dial" as one of the ornaments of Sir Samuel Lely's house at Whitehall. But, though the puppet did not travel in the train of William of Orange, allusions to it became far more frequent after the Revolution of 1688, and the skill of the Dutch in their treatment of puppet mechanism may have enhanced its attractiveness. In 1703 it was introduced at Bartholomew Fair into a puppet play of the creation of the world; in 1709 (*Taller*, No. 16) it was to be found in a representation of the Deluge, though in a different part from that of the Momus Polichinelle of Alexis Piron's *Arlequin-Deucalion* (1722); and in 1710 (*Spectator*, No. 14) it is mentioned as a leading figure in Powell's puppet-show at Covent Garden. The alleged satire on Robert Walpole, entitled *A Second Tale of a Tub, or the History of Robert Powel, the Puppet-Shouman* (1715), furnishes some details of Punch performances, and has an interesting frontispiece representing Powell with Punch and his wife. The Judy (or Joan, as she appears to have been sometimes called) is not of a specially grotesque order, but the Punch is easily recognizable in all but the features, which are of the normal puppet type.

Other allusions are to be found in Gay's *Shepherd's Week—Saturday* (1714) and Swift's *Dialogue between Mad Mullinix and Timothy* (1728). The older Punchinello was far less restricted in his actions and circumstances than his modern successor. He fought with allegorical figures representing want and weariness as well as with his wife and with the police, was on intimate terms with the patriarchs and the seven champions of Christendom, sat on the lap of the queen of Sheba, had kings and dukes for his companions, and cheated the Inquisition as well as the common hangman. Powell seems to have introduced a trained pig which danced a minuet with Punch, and the French (among whom Punch is now usually styled Guignol, originally a puppet hailing from Lyons) having occasionally employed a cat in the place of the dog Toby, whose origin is somewhat uncertain. A typical version of the modern play, with illustrations, was published by Payne Collier and Cruikshank in 1828 (3rd ed., 1844).

(R. M. W.)

PUNCH. (1) To pierce, perforate, make a hole or stamp a mark, &c., with a tool known as a "puncheon" or "punch." The verb is derived from the substantive; the original is Lat. *punctio*, a pricking, from *pungere*, to prick. This gave Ital. *punzione*, O. Fr. *poinson*, mod. *poignon*. Both these French forms mean also a cask, from which the English "puncheon," a liquid measure varying in capacity from 72 to 120 gallons is taken. This is probably the same word as that for the tool, and refers to a mark or sign stamped or "punched" on the cask. The origin may therefore be paralleled by the explanation of "hogshead" as referring to a mark of an "oxhead" branded on the measure. (2) To beat or hit, especially in such colloquialisms, as "to punch one's head." This is not the same word as (1) but is a shortened form of "punish," from Lat. *punire*, of which the ultimate origin is *poena*, penalty, from which is derived "pain." (3) The name of a drink, composed of spirits, water, sliced lemons or limes, or lemon-juice, together with sugar and spice, and served hot. According to the spirit with which it is made, it is known as brandy, whisky, rum punch, &c. Milk-punch is made of milk and spirit, bottled and served cold. The word is the English representative of the Hindostani *panch*, five (from the number of ingredients), and was introduced from the East.

PUNCTUATION (Lat. *punctum*, a point), the theory or art of "pointing" a literary composition so as to divide it properly into sentences and portions of sentences, which the "points" are used to mark at their close, with a view to precision in the meaning of a continuous set of written words, by the indication of what would be pauses or changes of expression if they were spoken. The uses of the chief "points" are explained as follows in the "Rules for Compositors" at the Oxford University Press, compiled by Mr Horace Hart, the university printer:—

The "full stop" or "period" (.) marks the end of a sentence. The "colon" (:)—Greek *κῶλον*, a limb—is at the transition point of the sentence. The "semicolon" (;) separates different statements. The "comma" (,)—Gr. *κόμμα*, from *κόπτειν*, i.e. a piece cut off—separates clauses, phrases and particles. (The terms "period"—Greek *περίοδος*—"colon," "comma," now identified in punctuation with the signs here given, were borrowed from the Greek grammarians, who originally described either the whole sentence or a longer or shorter part of it respectively in this way.) Among other signs, the "dash" (—) marks abruptness or irregularity. The "exclamation" (!) marks surprise. The "interrogation" or "query" (?) asks a question. The apostrophe (') marks elisions or the possessive case. "Quotes," quotation-marks or "inverted commas" (" ") define quoted words. Irregularities or interpolations in a sentence are marked by various forms of bracket () or parenthesis. Literary usage and the practice of printing-houses vary, however, so much that it is impossible to define exactly and shortly the part played by some of these points in a reasonable system of punctuation. The Oxford Rules already mentioned, which deal also with spelling and other pitfalls in literary composition and printing, carry the authority of such experts as Dr J. A. H. Murray and Dr Henry Bradley; and the art of

punctuation may be studied also in such works as H. Beadnell's *Spelling and Punctuation*, P. Allardyce's *Stops: or how to punctuate*, T. L. de Vinne's *Correct Composition*, and T. Lefevre's *Guide pratique du compositeur*. The acceptance of a conventional system of modern punctuation is mainly due to the invention of printing, and to the ingenuity and care of individual typographers. In the earlier forms of writing the letters ran on continuously in lines; it was only by degrees that actual words were divided from one another by spacing within the line; then later came the distribution of words into sentences by means of points, and the introduction by Aldus Manutius in the 16th century of a regular system for these. The chief signs were inherited by the printers from the dots of the Greek grammarians, but often with altered meanings; thus the Greek interrogation mark (;) becomes the modern semicolon. (See PALAEOGRAPHY and TYPOGRAPHY.)

PUNDIT (Hindī *pandit*; Skr. *pandita*), a learned man, a teacher, particularly one skilled in Sanskrit and Hindu law, religion and philosophy. Before the institution of the High Courts in 1862, the Supreme Court of India had a law officer styled the Pundit of the Supreme Court, who advised the English judges on points of Hindu law. The term is frequently applied, somewhat derisively, or humorously, to learned persons, to those who claim by long official or other experience to lay down the law or dictate principles of conduct.

PUNIC WARS, a name specially appropriated to the wars between Rome and Carthage in the 3rd and 2nd centuries B.C. The origin of these conflicts is to be sought in the position which Rome acquired about 275 B.C. as suzerain and protector of all Italy. Her new obligation to safeguard the peninsula against foreign interference made it necessary that she should not allow the neighbouring island of Sicily to fall into the hands of a strong and expansive power. Carthage, on the other hand, had long been anxious to conquer Sicily and so to complete the chain of island posts by which she controlled the western Mediterranean.

First Punic War (264–241 B.C.)—The proximate cause of the first outbreak was a crisis in the city of Messana, commanding the straits between Italy and Sicily. A band of Campanian mercenaries, which had forcibly established itself within the town and was being hard pressed in 264 by Hiero II. of Syracuse, applied for help both to Rome and Carthage and thus brought a force from either power upon the scene. The Carthaginians, arriving first, occupied Messana and effected a reconciliation with Hiero. The Roman commander nevertheless persisted in throwing troops into the city, and by seizing the person of the Carthaginian admiral during a parley induced him to withdraw his garrison. The Romans thus won an important strategic post, but their aggression was met by a declaration of war from Carthage and Syracuse.

Operations began with a joint attack upon Messana, which the Romans easily repelled. In 263 they advanced with a considerable force into Hiero's territory and induced him to seek peace and alliance with them. Having thus secured their foothold on the island they set themselves to wrest it completely from Carthage. In 262 they besieged and captured the enemy's base at Agrigentum, and proved that Punic mercenary troops could not stand before the infantry of the legions. But they made little impression upon the Carthaginian fortresses in the west of the island and upon the towns of the interior which mostly sided against them. Thus in the following campaigns their army was practically brought to a standstill.

In 260 the war entered upon a new phase. Convinced that they could gain no serious advantage so long as the Carthaginians controlled the sea and communicated freely with their island possessions, the Romans built their first large fleet of standard battleships. At Mylae, off the north Sicilian coast, their admiral C. Duilius defeated a Carthaginian squadron of superior manœuvring capacity by a novel application of grappling and

¹ The chronology here given is the traditional one, but recent researches tend to show that many events have been antedated by one year.

boarding tactics. This victory left Rome free to land a force on Corsica and expel the Carthaginians (259), but did not suffice to loosen their grasp on Sicily.

After two more years of desultory warfare the Romans decided to carry the war into the enemy's home territory. A large armament sailed out in 256, repelled a vigorous attack by the entire Carthaginian fleet off Cape Ecnomus (near Agrigentum) and established a fortified camp on African soil at Clypea. The Carthaginians, whose citizen levy was utterly disorganized, could neither keep the field against the invaders nor prevent their subjects from revolting. A single campaign compelled them to sue for peace, but the terms which the Roman commander Atilius Regulus offered were intolerably harsh. Accordingly they equipped a new army in which, by the advice of a Greek captain of mercenaries named Xanthippus, cavalry and elephants formed the strongest arm. In 255, under Xanthippus's command, they offered battle to Regulus, who had taken up position with an inadequate force near Tunes, outmanœuvred him and destroyed the bulk of his army. A second Roman armament, which subsequently reached Africa after defeating the full Carthaginian fleet off Cape Hermaeum, did not venture to reopen the campaign, but withdrew all the remaining troops.

The Romans now directed their efforts once more against Sicily. In 254 they carried the important fortress of Panormus (Palermo) by an attack from the sea; but when Carthage threw reinforcements into the island the war again came to a standstill. In 251 at last the Roman general L. Metellus brought about a pitched battle near Panormus in which the enemy's force was effectively crippled. This victory was followed by an investment of the chief Punic base at Lilybaeum by land and sea. The besiegers met with a gallant resistance, and in 249 were compelled to withdraw by the loss of their fleet in a surprise attack upon the neighbouring harbour of Drepanum (Trapani), in which the admiral Claudius Pulcher was repulsed with a loss of 93 ships. Meanwhile other losses in storms on the high seas so reduced the Roman fleet that the attack upon Sicily had to be suspended. At the same time the Carthaginians, who felt no less severely the financial strain of the prolonged struggle and had a war in Africa on their hands, reduced their armaments and made no attempt to deliver a counter-attack. The only noteworthy feature of the ensuing campaigns is the skilful guerilla war waged by a new Carthaginian commander, Hamilcar Barca, from his strong positions on Mt Ercte (247-244) and Mt Eryx (244-242) in Western Sicily, by which he effectually screened Lilybaeum from the Roman land army.

In 242 Rome resumed operations on sea. By a magnificent effort on the part of private citizens a fleet of 200 warships was equipped and sent out to renew the blockade of Lilybaeum. The Carthaginians hastily collected a relief force, but in a battle fought off the Aegates or Aegusae islands (west of Drepana) their fleet was caught at a disadvantage and mostly sunk or captured (March 10, 241). This victory, by giving the Romans undisputed command of the sea, rendered certain the ultimate fall of the Punic strongholds in Sicily. The Carthaginians accordingly opened negotiations and consented to a peace by which they ceded Sicily and the Lipari Islands to Rome and paid an indemnity of 3200 talents (about £800,000).

The Interval between the First and Second Wars (241-218 B.C.).—The loss of naval supremacy not only deprived Carthage of her predominance in the western Mediterranean, but exposed her oversea empire to disintegration under renewed attacks by Rome. The temper of the Roman people was soon made manifest during a conflict which broke out between the Carthaginians and their discontented mercenaries. Italian traders were allowed to traffic in munitions of war with the mutineers, and a gross breach of the treaty was perpetrated when a Roman force was sent to occupy Sardinia, whose insurgent garrison had offered to surrender the island (239). To the remonstrances of Carthage the Romans replied with a direct declaration of war, and only withheld their attack upon the formal cession of Sardinia and Corsica and the payment of a further indemnity.

From this episode it became clear that Rome intended to

use her victory to the utmost. To avoid complete humiliation Carthage had no resource but to humiliate her adversary. The recent complications of foreign and internal strife had indeed so weakened the Punic power that the prospect of renewing the war under favourable circumstances seemed remote enough. But the scheme of preparing for a fresh conflict found a worthy champion in Hamilcar Barca, who sought to compensate for the loss of Sicily by acquiring a dominion in Spain where Carthage might gain new wealth and form a fresh base of operations against Rome. Invested with an unrestricted foreign command, he spent the rest of his life in founding a Spanish empire (236-228). His work was continued by his son-in-law Hasdrubal and his son Hannibal, who was placed at the head of the army in 220. These conquests aroused the suspicions of Rome, which in a treaty with Hasdrubal confined the Carthaginians to the south of the Ebro, and also guaranteed the independence of Saguntum, a town on the east coast which pretended to a Greek origin. In 219 Hannibal laid siege to Saguntum and carried the town in spite of a stubborn defence. It has always been a debateable point whether his attack contravened the new treaty. The Romans certainly took this view and sent to Carthage to demand Hannibal's surrender. But his defiant policy was too popular to be disavowed; the Carthaginian council upheld Hannibal's action, and drew upon itself an immediate declaration of war.

Second Punic War (218-201 B.C.): a. The "Hannibalic" War.—It seemed as though the superiority of the Romans at sea must enable them to choose the field of battle. They decided to embark one army for Spain and another for Sicily and Africa. But before their preparations were complete Hannibal began that series of operations by which he dictated the course of the war for the greater part of its duration. Realizing that so long as Rome commanded the resources of an undivided Italian confederacy no foreign attack could beat her down beyond recovery, he conceived the plan of cutting off her supply of strength at the source by carrying the war into Italy and causing a disruption of the League. His chances of ever reaching Italy seemed small, for the sea was guarded by the Roman fleets and the land route was long and arduous. But the very boldness of his enterprise contributed to its success; after a six months' march through Spain and Gaul and over the Alps, which the Romans were nowhere in time to oppose, Hannibal arrived in the plain of the Po with 20,000 foot and 6000 horse, the pick of his African and Spanish levies (autumn 218: for details see HANNIBAL).

His further advance was here disputed by some Roman troops which had been recalled from the Spanish expedition. But the superiority of the Carthaginian cavalry and the spread of insurrection among the Gaulish inhabitants forced the defenders to fall back upon the Apennines. At the end of the year the Roman army was reinforced by the division from Sicily and led out to battle on the banks of the Trebia. Hannibal, by superior tactics, repelled the assailants with heavy loss, and thus made his position in north Italy secure.

In 217 the campaign opened in Etruria, into which the invading army, largely reinforced by Gauls, penetrated by an unguarded pass. A rash pursuit by the Roman field force led to its being entrapped on the shore of Lake Trasimene and destroyed with a loss of 40,000 men. This catastrophe left Rome completely uncovered; but Hannibal, having resolved not to attack the capital before he could collect a more overwhelming force, directed his march towards the south of Italy, where he hoped to stir up the peoples who had formerly been Rome's most stubborn enemies. The natives, however, were everywhere slow to join the Carthaginians, and a new Roman army under the dictator Q. Fabius Maximus ("Cunctator"), which, without ever daring to close with Hannibal, persistently dogged his steps on his forays through Apulia and Campania, prevented his acquiring a permanent base of operations.

The eventful campaign of 216 was begun by a new aggressive move on the part of Rome. An exceptionally strong field army, estimated at 85,000 men, was sent forth in order to crush the Carthaginians in open battle. On a level plain near Cannae in

Apulia, which Hannibal had chosen for his battle-ground, the Roman legions delivered their attack. Hannibal deliberately allowed his centre to be driven in by their superior numbers, while Hasdrubal's cavalry wheeled round so as to take the enemy in flank and rear. The Romans, surrounded on all sides and so cramped that their superior numbers aggravated their plight, were practically annihilated, and the loss of citizens was perhaps greater than in any other defeat that befel the Republic. The moral effect of the battle was no less momentous. The south Italian nations at last found courage to secede from Rome, the leaders of the movement being the people of Capua, the second greatest town of Italy. Reinforcements were sent from Carthage, and several neutral powers prepared to throw their weight into the scale on Hannibal's behalf. At first sight it seems strange that the battle of Cannae did not decide the war. But the resources of Rome, though terribly reduced in respect both of men and of money, were not yet exhausted. In north and central Italy the insurrection spread but little, and could be sufficiently guarded against with small detachments. In the south the Greek towns of the coast remained loyal, and the numerous Latin colonies continued to render important service by interrupting free communication between the rebels and detaining part of their forces. In Rome itself the quarrels between the nobles and commons, which had previously unsettled her policy, gave way to a unanimity unparalleled in the annals of the Republic. The guidance of operations was henceforth left to the senate, which by maintaining a firm and persistent policy until the conflict was brought to a successful end earned its greatest title to fame.

The subsequent campaigns of the Italian War assume a new character. Though the Romans contrived at times to raise 200,000 men, they could only spare a moderate force for field operations. Their generals, among whom the veterans Fabius and M. Claudius Marcellus frequently held the most important commands, rarely ventured to engage Hannibal in the open, and contented themselves with observing him or skirmishing against his detachments. Hannibal, whose recent accessions of strength were largely discounted by the necessity of assigning troops to protect his new allies or secure their wavering loyalty, was still too weak to undertake a vigorous offensive. In the ensuing years the war resolved itself into a multiplicity of minor engagements which need not be followed out in detail. In 216 and 215 the chief seat of war was Campania, where Hannibal vainly attempted to establish himself on the coast and experienced a severe repulse at Nola. In 214 the main Carthaginian force was transferred to Apulia in hopes of capturing Tarentum. Though Croton and Locri on the Calabrian coast had fallen into his hands, Hannibal still lacked a suitable harbour by which he might have secured his oversea communications. For two years he watched in vain for an opportunity of surprising the town, while the Romans narrowed down the sphere of revolt in Campania and defeated other Carthaginian commanders. In 212 the greater part of Tarentum and other cities of the southern seaboard at last came into Hannibal's power. But in the same year the Romans found themselves strong enough to place Capua under blockade. They severely defeated a Carthaginian relief force, and could not be permanently dislodged even by Hannibal himself. In 211 Hannibal made a last effort to relieve his allies by a feint upon Rome itself, but the besiegers refused to be drawn away from their entrenchments, and eventually Capua was starved into surrender. Its fall was a sign that no power could in the long run uphold a rival Italian coalition against Rome. After a year of desultory fighting the Romans in 209 gained a further important success by recovering Tarentum. Though Hannibal from time to time still won isolated engagements, yet slowly but surely he was being driven back into the extreme south of the peninsula.

In 207 the arrival of a fresh invading force produced a new crisis. Hasdrubal, who in 209-208 had marched overland from Spain, appeared in north Italy with a force scarcely inferior to the army which his brother had brought in 218. After levying contingents of Gauls and Ligurians he marched down the east

coast with the object of joining hands with his brother in central Italy for a direct attack upon Rome. By this time the drain of men and money was telling so severely upon her confederacy that some of her most loyal allies protested their inability to render further help. Yet by a supreme effort the Romans raised their war establishment to the highest total yet attained and sent a strong field army against either Carthaginian leader. The danger to Rome was chiefly averted by the prompt insight and enterprise of the consul C. Nero, who commanded the main army in the south. Having discovered that Hannibal would not advance beyond Apulia until his brother had established communications with him, Nero slipped away with part of his troops and arrived in time to reinforce his colleague Livius, whose force had recently got into touch with Hasdrubal near Sena Gallica (Sinigaglia). The combined Roman army frustrated an attempt of Hasdrubal to elude it and forced him to fight on the banks of the Metaurus. The battle was evenly contested until Nero by a dexterous flanking movement cut the enemy's retreat. Hasdrubal himself fell and the bulk of his army was destroyed.

The campaign of 207 decided the war in Italy. Though Hannibal still maintained himself for some years in Calabria, this was chiefly due to the exhaustion of Rome after the prodigious strain of past years and the consequent reduction of her armaments. In 203 Italy was finally cleared of Carthaginian troops. Hannibal, in accordance with orders from home, sailed back to Africa, and another expedition under his brother Mago, which had sailed to Liguria in 205 and endeavoured to rouse the slumbering discontent in Cisalpine Gaul and Etruria, was driven back on the coast and withdrawn about the same time.

b. The Subsidiary Campaigns.—Concurrently with the great struggle in Italy the Second Punic War was fought out on several other fields. It will suffice merely to allude to the First Macedonian War (214-205) which King Philip V. commenced when the Roman power seemed to be breaking up after Cannae. The diversions which Roman diplomacy provided for Philip in Greece and the maintenance of a patrol squadron in the Adriatic prevented any effective co-operation on his part with Hannibal.

In view of the complete stagnation of agriculture in Italy the Romans had to look to Sardinia and Sicily for their food supply. Sardinia was attacked by a Carthaginian armament in 215, but a small Roman force sufficed to repel the invasion. In Sicily a more serious conflict broke out. Some isolated attacks by Punic squadrons were easily frustrated by the strong Roman fleet. But in 215 internal complications arose. The death of Hiero II., Rome's steadfast friend, left the kingdom of Syracuse to his inexperienced grandson Hieronymus. Flattered by the promises of Carthaginian emissaries the young prince abruptly broke with the Romans, but before hostilities commenced he was assassinated. The Syracusan people now repudiated the monarchy and resumed their republican constitution, but they were misled by false threats of terrible punishment at the hands of Rome to play into the hands of the Carthaginians. The attacks of a Roman army and fleet under Marcellus which speedily appeared before the town were completely baffled by the mechanical contrivances of the Syracusan mathematician Archimedes (213). Meantime the revolt against Rome spread in the interior, and a Carthaginian fleet established itself in the towns of the south coast. In 212 Marcellus at last broke through the defence of Syracuse and in spite of the arrival of a Carthaginian relief force mastered the town by slow degrees. A guerilla warfare succeeded in which the Carthaginians maintained the upper hand until in 210 they lost their base at Agrigentum. Thereupon they were rapidly dislodged from their remaining positions, and by the end of the year Sicily was wholly under the power of Rome.

The conflict in Spain was second in importance to the Italian War alone. From this country the Carthaginians drew large supplies of troops and money which might serve to reinforce Hannibal; hence it was in the interest of the Romans to challenge their enemy within his Spanish domain.

*Sardinia
and Sicily.*

Spain.

Though the force which Rome at first spared for this war was small in numbers and rested entirely upon its own resources, the generals Publius and Gnaeus Scipio by skilful strategy and diplomacy not only won over the peoples north of the Ebro and defeated the Carthaginian leader Hasdrubal Barca in his attempts to restore communication with Italy, but carried their arms along the east coast into the heart of the enemy's domain. But eventually their successes were nullified by a rash advance. Deserted by their native contingents and cut off by Carthaginian cavalry, among which the Numidian prince Massinissa rendered conspicuous service, the Roman generals were slain and their troops were destroyed in detail (212 or 211).

Disturbances in Africa prevented the Punic commanders from reaping the full fruit of their success. Before long the fall of Capua enabled Rome to transfer troops from Italy to Spain, and in 209 the best Roman general of the day, the young son and namesake of the recently slain P. Scipio, was placed in command. The new leader signalized his arrival by a bold and successful *coup-de-main* upon the great arsenal of Carthago Nova. Though he failed to prevent Hasdrubal Barca from marching away to Italy, Scipio profited by his departure to push back the remaining hostile forces the more rapidly. A last effort by the Carthaginians to retrieve their losses with a fresh army was frustrated by a great victory at Ilipa (near Corduba), and by the end of 206 they were completely driven out of the peninsula.

In 205 Scipio, who had returned to Rome to hold the consulship, proposed to follow up his victories by an attack upon the home territory of Carthage. Though the presence

The War in Africa.

of Hannibal in Italy at first deterred the senate from sanctioning this policy, the general popularity of the scheme overbore all resistance. Scipio was granted a force which he organized and supplemented in Sicily, and in 204 sailed across to Africa. He was here met by a combined levy of Carthage and King Syphax of Numidia, and for a time penned to the shore near Utica. But in the winter he extricated himself by a surprise attack upon the enemy's camp, which resulted in the total loss of the allied force by sword or flame. In the campaign of 203 a new Carthaginian force was destroyed by Scipio on the Great Plains not far from Utica, their ally Syphax was captured, and the renegade Massinissa (*q.v.*) reinstated in the kingdom from which Syphax had recently expelled him. These disasters induced the Carthaginians to sue for peace, but before the very moderate terms which Scipio offered could be definitely accepted a sudden reversal of opinion caused them to recall Hannibal's army for a final trial of war, and to break off negotiations. In 202 Hannibal assumed command of a composite force of citizen and mercenary levies stiffened with a corps of his veteran Italian troops. After an abortive conference with Scipio he prepared for a decisive battle at Zama (an inland site not yet identified with certainty). Scipio's force was smaller in numbers, but well trained throughout and greatly superior in cavalry. His infantry, after evading an attack by the Carthaginian elephants, cut through the first two lines of the enemy, but was unable to break the reserve corps of veterans. The battle was ultimately decided by the cavalry of the Romans and their new ally Massinissa, which by a manœuvre recalling the tactics of Cannae took Hannibal's line in the rear and completely destroyed it. The Carthaginians having thus lost their last army again applied for peace and accepted the terms which Scipio offered. They were compelled to cede Spain and the Mediterranean islands still in their hands, to surrender their warships, to pay an indemnity of 10,000 talents (about £2,400,000) within fifty years and to forfeit their independence in affairs of war and foreign policy.

The Second Punic War, by far the greatest struggle in which either power engaged, had thus ended in the complete triumph of Rome. This triumph is not to be explained in the main by any faultiness in the Carthaginians' method of attack. The history of the First Punic War, and that of the Second outside of Italy, prove that the Romans were irresistible on neutral or Carthaginian ground. Carthage could only hope to win by

invading Italy and using the enemy's home resources against him. The failure of Hannibal's brilliant endeavour to realize these conditions was not due to any strategical mistakes on his part. It was caused by the indomitable strength of will of the Romans, whose character during this period appears at its best, and to the compactness of their Italian confederacy, which no shock of defeat or strain of war could entirely disintegrate. It is this spectacle of individual genius overborne by corporate and persevering effort which lends to the Second Punic War its peculiar interest.

The Third Punic War (149-146 B.C.)—The political power of Carthage henceforth remained quite insignificant, but its commerce and material resources revived in the 2nd century with such rapidity as to excite the jealousy of the growing mercantile population of Rome and the alarm of its more timid statesmen. Under the influence of these feelings the conviction—sedulously fostered by Cato the Elder, the Censor—that “Carthage must be destroyed” overbore the scruples of more clear-sighted statesmen. A *casus belli* was readily found in a formal breach of the treaty, committed by the Carthaginians in 154, when they resisted Massinissa's aggressions by force of arms. A Roman army was despatched to Africa, and although the Carthaginians consented to make reparation by giving hostages and surrendering their arms, they were goaded into revolt by the further stipulation that they must emigrate to some inland site where they would be debarred from commerce. By a desperate effort they created a new war equipment and prepared their city for a siege (149). The Roman attack for two years completely miscarried, until in 147 the command was given to a young officer who had distinguished himself in the early operations of the war—Scipio Aemilianus, the adoptive grandson of the former conqueror of Carthage. Scipio made the blockade stringent by walling off the isthmus on which the town lay and by cutting off its sources of supplies from overseas. His main attack was delivered on the harbour side, where he effected an entrance in the face of a determined and ingenious resistance. The struggle did not cease until he had carried house by house the streets that led up to the citadel. Of a population probably exceeding half a million only 50,000 remained at the final surrender. The survivors were sold into slavery; the city was razed to the ground and its site condemned by solemn imprecations to lie desolate for ever. The territory of Carthage, which had recently been much narrowed by Massinissa's encroachments, was converted into a Roman province under the name of “Africa.”

BIBLIOGRAPHY.—1. *Ancient Authorities.* For the First Punic War Polybius, bk. 1, provides a trustworthy and impartial account, but owing to his conciseness leaves many problems of chronology and strategy unexplained. For the Second War bks. 2 and 3 of Polybius present a complete and detailed record down to Cannae; bks. 7-15 contain fragmentary notices of which the most continuous deal with the campaigns of Scipio. Livy (bks. 23-30) gives a continuous and detailed narrative, partly based upon Polybius and other good authorities, partly upon untrustworthy Roman annalists. The Third War is described in Appian's *Res Libycae*, chs. 67 sqq., and the fragments of Polybius, bks. 36-39.

The subsidiary authorities are: Diodorus, bks. 20-27, 32; Appian, *Res Libycae, Hispanicae, Hannibalicæ*; Zonaras's epitome of Dio Cassius, frs. 43, 54, 57; Plutarch's *Lives of Fabius and Marcellus*; Cornelius Nepos's *Lives of Hamilcar and Hannibal*, and short references in Justin, Eutropius, Aurelius Victor and Orosius. The sources and methods of composition of these authors have been discussed in numerous articles and dissertations, mostly German, of which the most important are mentioned in Niese's work (quoted below). These essays have brought out few certain results, but they tend to show that the narratives, so far as they are not based on Polybius or earlier authorities, are of little value.

2. *Modern Works.* a. For general accounts, see the respective passages in the general histories of Rome, especially Mommsen (Eng. trans., 1894, vol. ii.), and Ihne (Eng. trans., vol. ii.); also C. Neumann, *Das Zeitalter der punischen Kriege* (Breslau, 1883), and R. B. Smith, *Rome and Carthage* (London, 1881).

b. For the First War.—O. Meltzer, *Geschichte der Karthager*, ii. 252-356 (Berlin, 1879-1886); J. Beloch, *Griechische Geschichte*, vol. iii. pt. i. pp. 664-684 (Strassburg, 1893-1904); B. Niese, *Geschichte der griechischen und makedonischen Staaten*, ii. 174-199 (Gotha, 1893-1903); W. W. Tarn, “The Fleets of the First Punic War,” in *Journal of Hellenic Studies* (1907), pp. 48-60. For

the chronology, see F. Reusa, in *Philologus* (1901), pp. 102-148, and especially P. Varese, in *Studi di storia antica*, vol. iii. (Rome, 1902).

c. For the period 241-238.—O. Gilbert, *Rom und Karthago* 513-536 A.U.C. (Leipzig, 1876); Meltzer, *op. cit.* ii. 357-456.

d. For the Second War.—T. Arnold, *The Second Punic War* (ed. W. T. Arnold; London, 1886); T. A. Dodge, *Great Captains, Hannibal* (Boston and New York, 1889); G. Bossi, in *Studi di storia e diritto*, vols. x.-xiii.; P. Cantalupi, *Le Legioni romane nella guerra d'Annibale* (*Studi di storia antica*, 1891, i. 3-48); Th. Zielinski, *Die letzten Jahre des zweiten punischen Krieges* (Leipzig, 1880).

e. Special articles.—On Sicily: Niese, *op. cit.* ii. 505-561. On Spain: J. Frantz, *Die Kriege der Scipionen in Spanien* (Munich, 1883).

For further bibliographical references consult B. Niese, *Grundriss der römischen Geschichte*, pp. 81-88, 94-108, 138-142 (Munich, 1906). See also the articles on chief personages (especially HANNIBAL and SCIPIO), and under ROME: *Ancient History*; CARTHAGE; SICILY. (M. O. B. C.)

PUNISHMENT (from Lat. *punire*, to punish, from *poena*, punishment, Gr. *πῶνις*), the infliction of some kind of pain or loss upon a person for a misdeed, *i.e.* the transgression of a law or command. Punishment may take forms varying from capital punishment, flogging and mutilation of the body to imprisonment, fines, and even deferred sentences which come into operation only if an offence is repeated within a specified time. The progress of civilization has resulted in a vast change alike in the theory and in the method of punishment. In primitive society punishment was left to the individuals wronged or their families, and was vindictive or retributive: in quantity and quality it would bear no special relation to the character or gravity of the offence. Gradually there would arise the idea of proportionate punishment, of which the characteristic type is the *lex talionis*,¹ "an eye for an eye." The second stage was punishment by individuals under the control of the state, or community; in the third stage, with the growth of law, the state took over the primitive function and provided itself with the machinery of "justice" for the maintenance of public order. Henceforward crimes are against the state, and the exaction of punishment by the wronged individual is illegal (*cf.* LYNCH LAW). Even at this stage the vindictive or retributive character of punishment remains, but gradually, and specially after the humanitarian movement under thinkers like Beccaria and Jeremy Bentham, new theories begin to emerge. Two chief trains of thought have combined in the condemnation of primitive theory and practice. On the one hand the retributive principle itself has been very largely superseded by the protective and the reformative; on the other punishments involving bodily pain have become objectionable to the general sense of society. Consequently corporal and even capital punishment occupy a far less prominent position, and tend everywhere to disappear. It began to be recognized also that stereotyped punishments, such as belong to penal codes, fail to take due account of the particular condition of an offence and the character and circumstances of the offender. A fixed fine, for example, operates very unequally on rich and poor.

Modern theories date from the 18th century, when the humanitarian movement began to teach the dignity of the individual and to emphasize his rationality and responsibility. The result was the reduction of punishment both in quantity and in severity, the improvement of the prison system, and the first attempts to study the psychology of crime and to distinguish between classes of criminals with a view to their improvement (see CRIME; PRISON; CHILDREN'S COURTS; JUVENILE OFFENDERS). These latter problems are the province of criminal anthropology and criminal sociology, sciences so called because they view crime as the outcome of anthropological and social conditions. The man who breaks the law is himself a product of social evolution and cannot be regarded as solely responsible for his disposition to transgress. Habitual crime is thus to be treated as a disease. Punishment can, therefore, be justified only in so far as it (1) protects society by removing temporarily or

¹ *Talis*, in juridical Latin, the abstract noun from *talis*, such, alike, hence "retaliation." See Exod. xxi. 24; Lev. xxiv. 20; Deut. xix. 21.

permanently one who has injured it, or acting as a deterrent,² or (2) aims at the moral regeneration of the criminal. Thus the retributive theory of punishment with its criterion of justice as an end in itself gives place to a theory which regards punishment solely as a means to an end, utilitarian or moral, according as the common advantage or the good of the criminal is sought.

AUTHORITIES.—Jeremy Bentham, *An Introduction to the Principles of Morality and Legislation*; Henry Maine, *Ancient Law*; C. B. de Beccaria, *Crimes and Punishments*; also works quoted under CRIMINOLOGY; CAPITAL PUNISHMENT; PRISON; and articles on *e.g.* ROMILLY, SIR SAMUEL and HOWARD, JOHN.

PUNJAB, a province of British India, so named from the "five rivers" by which it is watered: the Jhelum, Chenab, Ravi, Beas and Sutlej, all tributaries of the Indus. Geographically the Punjab is the triangular tract of country of which the Indus and the Sutlej to their confluence form the two sides, the base being the lower Himalaya hills between those two rivers; but the British province now includes a large tract outside those boundaries. Along the northern border Himalayan ranges divide it from Kashmir and Tibet. On the west it is separated from the North-West Frontier province by the Indus, until that river reaches the border of Dera Ghazi Khan district, which is divided from Baluchistan by the Suliman range. To the south lie Sind and Rajputana, while on the east the rivers Jumna and Tons separate it from the United Provinces.

The Punjab includes two classes of territory, that belonging to the British Crown, and that in possession of 34 feudatory chiefs, almost all of whom pay tribute. The total area of the province is 133,741 sq. m., of which 97,209 sq. m. are British territory, and the remainder belongs to native states. The British territory is divided into 29 districts, grouped under the five divisions of Delhi, Lahore, Jullundur, Rawalpindi and Multan; while the native states vary in size from Bahawalpur, with an area of 15,000 sq. m., to the tiny state of Darkoti, with an area of 8 sq. m. and a total population of 518 souls. They may be grouped under three main heads: the Phulkian states of Patiala, Jind and Nabha and the Sikh state of Kapurthala, occupying the centre of the eastern plains; the Mahomedan state of Bahawalpur between the Sutlej and the Rajputana desert; and the hill states, among the Punjab Himalayas held by ancient Rajput families, including Chamba, Mandi, Suket, Sirmur and the Simla states.

Physical Features.—The mountain regions of the Punjab fall under four separate groups. To the north-east of the province lies the Himalayan system, with the fringing range of the Siwaliks at its foot. In the south-eastern corner the Aravalli system sends out insignificant outliers, which run across Gurgaon and Delhi districts and strike the Jumna at Delhi. The lower portion of the western frontier is constituted by the great Suliman chain; while the north-western districts of the province are traversed by the hill system known as the Salt range. The mountain system of the Himalayas, so far as it concerns the Punjab, consists primarily of three great ranges running in a generally north-westerly direction from the head-waters of the Sutlej to the Indus: the western Himalayas or Zanskar or Bara Lacha range, the mid-Himalayas or Pir Panjal range, and the outer or sub-Himalayas. From these three great ranges spring numerous minor ranges, as ribs from a backbone, the whole forming a confused system of mountain chains and valleys, the breadth of which is some 90 m. at its eastern extremity from Lahul to the Siwaliks of Hoshiarpur, and some 150 m. measured at its western extremity across Kashmir.

The "five rivers" of the Punjab are each of large volume; but, on account of the great width of sandy channel in their passage through the plains, their changing courses, and shifting shoals, they are of no value for steam navigation, though they all support a considerable boat-traffic. Of recent years most of them have been utilized for purposes of irrigation, and have turned the sandy desert of

² This idea combined with the retributive is found as early as Deut. xix. 20, "And those which remain shall hear and fear, and shall henceforth commit no more any such evil."

Political
Divisions.

The Five
Rivers.

the Punjab into one of the great wheat fields of the British Empire.

While the general name Punjab is applied to the whole country of the "five rivers," there are distinct names for each of the *doabs* (*do*, two; *ab*, water) or tracts between two adjoining rivers. The country between the Sutlej and the Beas is called the Jullundur Doab; it includes the districts of Jullundur and Hoshiarpur. The long strip between the Beas and the Ravi, containing the greater part of Gurdaspur, Amritsar, Lahore, Montgomery, and Multan districts, is called the Bari Doab. Rechna Doab is the tract between the Ravi and the Chenab, embracing Sialkot and Gujranwala districts, with the trans-Ravi portions of the districts of the Bari Doab. Chaj or Jech is the doab between the Chenab and the Jhelum (Gujrat and Shahpur districts and part of Jhang), and Sind Sagar is the name of the large doab between the Jhelum and the Indus, including Rawalpindi, Jhelum and Muzaffargarh districts, with parts of Shahpur, Bannu and Dera Ismail Khan. The higher and dryer parts of the doabs are called *bar*. They are waste, but not barren, scantily covered with low shrubs, and capable, when watered, of being well cultivated. The *bar* is the great camel-grazing land. Large areas of Muzaffargarh and Multan districts are *thal*, barren tracts of shifting sand. The middle part of the Bari Doab, in Amritsar district, bears the distinctive name of Manjha (middle) as the centre and headquarters of the Sikh nation, containing their two sacred tanks of Amritsar and Taran Taran. The Malwa Sikhs, again, are those of the cis-Sutlej country.

South of the Himalayas stretch the great plains, which constitute by far the larger proportion of the province. With

the exception of the Himalayan and Salt range tracts the Punjab presents, from the Jumna on the east to the Sulimans in the west, one vast level,

unbroken save by the wide eroded channels within which the great rivers ever shift their beds, by the insignificant spurs of the Aravalli range in the south-eastern corner, and the low hills of Chiniot and Kirana in Jhang. The whole of these vast plains is of alluvial formation. Stones are unknown save at the immediate foot of the hills; micaceous river sand is to be found everywhere at varying depths; and the only mineral is nodular accretions of limestone, called *kankar*, which is used for the construction of roads. The soil is a singularly uniform loam, the quality being determined by the greater or smaller proportion of sand present. In the local hollows and drainage lines the constant deposit of argillaceous particles has produced a stiff tenacious soil, especially adapted to rice cultivation, while in the beds of the great rivers, and on the wind-fretted water-sheds pure sand is commonly found. Where neither sand nor the saline efflorescence called *reh* is present, the soil is uniformly fertile, if only the rainfall be sufficient or means of irrigation be available. Throughout the greater part of the western plains, however, the insufficiency of rainfall is a permanent condition; and until recently the uniform aspect of the country was that of wide steppes of intrinsically fertile soil, useful, however, only as grazing grounds for herds of camels or cattle.

The Punjab may be divided into four great natural divisions: the Himalayan tract, the submontane tract, the eastern and western plains and the Salt range tract, which have characteristics widely different from each other. The **Natural Divisions.** Himalayan tract, which includes the Punjab hill states, consists of 20,000 sq. m. of sparsely inhabited mountain, with tiny hamlets perched on the hill-sides or nestling in the valleys. The people consist chiefly of Rajputs, Kanets, Gharaths, Brahmans and Dagsis or menials. The eastern and western plains, which are divided from each other by a line passing through Lahore, are dissimilar in character. The eastern are arable plains of moderate rainfall and almost without rivers, except along their northern and eastern edges. They are inhabited by the Hindu races of India, and contain the great cities of Delhi, Amritsar and Lahore. They formed, until the recent spread of irrigation, the most fertile, wealthy and populous portion of the province. The western plains, except where canal irrigation has been introduced, consist of arid pastures with scanty rainfall, traversed by the five great rivers, of which the broad valleys alone are cultivable. They are inhabited largely

by Mahomedan tribes, and it is in this tract that irrigation has worked such great changes. The Chenab and Jhelum Canal colonies are already pronounced successes, and it is hoped that in process of time the Lower Bari Doab and the Sind-Sagar Doab will be similarly fertilized. The submontane tract, skirting the foot of the hills, has an area of 10,000 sq. m., consisting of some of the most fertile and thickly populated portions of the province. Its population comes midway between the peoples of the hills and of the plains in race, religion and language, Mahomedanism being less prevalent, Hindi more generally spoken, and Rajputs and hill menials more common than in the plains. The Gujars form a special feature of this zone. Its only large town is Sialkot. The Salt range tract includes the districts of Rawalpindi and Jhelum and a small portion of Shahpur district, and consists of some 9000 sq. m. of broken and confused country.

Geology.—By far the greater part of the Punjab is covered by alluvial and wind-blown deposits of the plain of the Indus. The Salt range hills form a plateau with a steeply scarped face to the south, along which there is an axis of abrupt folding, accompanied by faulting. The rocks found in the Salt range belong to the Cambrian, Carboniferous, Permian, Triassic and Jurassic systems, while Tertiary beds cover the plateau behind. The extensive and valuable deposits of salt, from which the range takes its name, occur near the base of the Cambrian beds. Gypsum, kieserite and other salts are also found. Between the Cambrian and the Carboniferous beds there is an unconformity, which, however, is not very strongly marked, in spite of the lapse of time which it indicates. At the bottom of the Carboniferous series there is usually a boulder bed, the boulders in which have been brought from a distance and are scratched and striated as if by ice. It is generally admitted that this deposit, together with contemporaneous boulder beds in the peninsula of India, in Australia and in South Africa, indicate a southern glacial period in late Carboniferous times. Above the sandstone series at the base of which the boulder bed lies, come the *Productus* and *Ceratile* limestones. The former is believed to belong to the Upper Carboniferous and Permian, the latter to the Trias. Jurassic beds are found only in the western portion of the range.

Climate.—Owing to its sub-tropical position, scanty rainfall and cloudless skies, and the wide expanse of untilled plains, the climate of the Punjab presents greater extremes of both heat and cold than any other part of India. From the middle of April to the middle of September it is extremely hot, while from the beginning of October to the end of March there is a magnificent cool season, resembling that of the Riviera, with warm bright days and cool nights. Frosts are frequent in January. In the first three months of the hot season, from April till the end of June, a dry heat is experienced, with a temperature rising to 120° F. in the shade. At the end of June the monsoon arrives, the rains break, and though the heat is less intense the air is moist, and from the middle of August the temperature gradually falls. This is the most unhealthy period of the year, being exceedingly malarious. The Punjab enjoys two well-marked seasons of rainfall; the monsoon period, lasting from the middle of June till the end of September, on which the autumn crops and spring sowings depend; and the winter rains, which fall early in January, and though often insignificant in amount materially affect the prosperity of the spring harvest. Excepting in the Himalayas the rainfall is greatest in the east of the province, as the Bombay monsoon is exhausted in its passage over the great plains of Sind and Rajputana, while the west winds from Baluchistan pass over an arid tract and leave such moisture as they may have collected on the western slopes of the Suliman range; so that the Punjab depends for its rain very largely on the south-east winds from the Bay of Bengal. The submontane tract has an annual average of 36 to 32 in., the eastern plains vary from 20 to 14 in., and the western plains from 10 to 5 in.

Minerals.—Besides rock-salt, the mineral products of the Punjab are not many. Limestone, good for building, is obtained at Chiniot on the Chenab and at a few other places. There are extensive alum-beds at Kalabagh on the Indus. A small quantity of coal is found in the Salt range in disconnected beds, the Dandot colliery in the Jhelum district being worked by the North-Western railway. Petroleum is found in small quantities at a number of places in Rawalpindi, being gathered from the surface of pools or collected in shallow pits. In almost all parts of the Punjab there is *kankar*, rough nodular limestone, commonly found in thick beds, a few feet below the surface of the ground, used for road metal and burned for lime.

Agriculture.—As in other parts of India, there are commonly two harvests in the year. The spring crops are wheat, barley, gram, various vegetables, oil-seeds, tobacco and a little poppy; the autumn crops are rice, millets, maize, pulses, cotton, indigo and sugar-cane. Wheat has become the most important export of the province. In the spring of 1906 an area of 8½ million acres was harvested, producing 3½ million tons. Tea is cultivated in Kangra district. Flax has been produced successfully, but the cultivation has not been extended. Hops have been grown experimentally, for the Murrec brewery, on neighbouring hills; the

cultivation in Kashmir has been more encouraging. Potatoes are grown extensively on cleared areas on the hills. The Punjab produces freely many of the Indian fruits. Grapes are grown in many of the Himalayan valleys where the rain is not excessive; but they are inferior to those brought from Kabul.

Forests.—The forest area of the Punjab consists of 9278 sq. m., of which 1916 sq. m. are reserved and 4909 sq. m. protected. The wasteful destruction of trees is checked in the hill forests rented from native states by the British government. The principal reserved forests are the deodar (*Cedrus Deodara*) and chil (*Pinus longifolia*) tracts in the hills, the plantations of shisham (*Dalbergia Sissu*) and sal (*Shorea robusta*) in the plains, and the fuel *rakhs* or preserves (*Acacia*, *Prosopis*, &c.).

Manufactures.—Most of the native manufactures of the Punjab are those common to other parts of India, such as the ordinary cotton fabrics, plain woollen blankets, unglazed pottery, ropes and cord, grass matting, paper, leather-work, brass vessels, simple agricultural implements and the tools used in trades. Other manufactures, not so general, yet not peculiar to the Punjab, are woollen fabrics, carpets and shawls, silk cloths and embroidery, jewelry and ornamental metal-work, wood and ivory carving, turned and lacquered woodwork, glazed pottery, arms and armour and musical instruments. But some of these classes of manufacture are represented by work of special kinds or special excellence in particular parts of the Punjab, notably the silk fabrics of Multan and Bahawalpur; the carpets of Lahore and Amritsar; the *kashi* or glazed tile-work (an ancient art still practised in a few places); *koft-kari*, inlaid metal-work (gold wire on steel), chiefly made at Gujrat and Sialkot; shawls and other fine woollen fabrics, made by Kashmiri work-people at Ludhiana and Nurpur, as well as in Kashmir; silk embroidery for shawls, scarfs and turbans, at Delhi, Lahore and Multan; embroidery on cloth for elephant-trappings, bed and table covers, &c., at Lahore and Multan; enamelled ornaments, in Kangra and Multan; quill embroidery on leather, in Kangra and Simla; lacquered woodwork, at Pak Pattan. Cotton-weaving gives employment to about a million persons, but the most flourishing industry is the woollen factories of Amritsar, Gurdaspur and elsewhere. Injury has been done to some of the native arts of the Punjab, as of other parts of India, by unwise copying of European patterns. The Lahore School of Art attempts to correct this and promote the study and execution of native forms and designs. The Lahore Museum contains illustrations of the arts and manufactures, as well as raw products, of the Punjab; and also a large collection of the sculptures, mostly Buddhist, and many of Greek workmanship, found in the north-west of the province.

Trade.—The trade of the Punjab is almost wholly dependent upon agriculture. In a normal year the principal feature of the trade is the movement of wheat to Karachi, which is the chief port for the province. But in a bad season, when the rains fail, this movement is at once checked, the wheat is held up in reserve and an eastward movement in cheaper grains begins. In 1904 32½ million maunds of wheat were exported, but 1905 was a bad season and the amount fell to 21 million maunds. The other chief articles of export are pulse and raw cotton. The chief imports are European cotton and woollen piece-goods and yarn, Indian piece-goods, sugar, metals and jute goods. The through trade in the main staples of grain and piece-goods is in the hands of large European and native firms. In addition to the foreign trade there is a considerable provincial trade with the United Provinces, and a trans-frontier trade with Kashmir, Ladakh, Yarkand and Tibet on the north, and with Afghanistan on the west.

Irrigation.—Irrigation for large areas is from canals and from reservoirs, and for smaller areas from wells. The canals are of two kinds: those carrying a permanent stream throughout the year, and those which fill only on the periodical rising of the rivers, the latter being known as "inundation canals." There are only a few parts of the country presenting facilities for forming reservoirs, by closing the narrow outlets of small valleys and storing the accumulated rainfall. The old canals made by the Mahommedan rulers, of which the principal are Feroz's Canal from the Jumna and the Hasli Canal from the Ravi, have been improved or reconstructed by the British government. The principal new canals are the Sirhind, drawn from the Sutlej near Rupa, which irrigates parts of the native states of Patiala, Nabha and Jhind, as well as British territory; the Bari Doab Canal from the Ravi; the Chenab Canal from the Chenab, irrigating the prosperous Chenab colony; and the Jhelum Canal irrigating the Jhelum colony. The total area irrigated by the canals of the province in 1905-1906 was 6,914,500 acres, the eight major works, the Western Jumna, Bari Doab, Sirhind, Lower Chenab, Lower Jhelum, Upper Sutlej, Sidhna and Indus accounting for all but 751,000 acres. The ravages of the boll-worm in the cotton crop made 1906 an unfavourable year; but in spite of that the Lower Chenab Canal paid nearly 21% on the capital invested, the Bari Doab 11% and the Western Jumna nearly 10%.

Railways.—The Punjab is well supplied with railways, which have their central terminus at Delhi. One main line of the North-Western runs from Umballa through Lahore and Rawalpindi towards Peshawar; another main line runs from Lahore to Multan,

and thence to the sea at Karachi; while a third runs along the left bank of the Indus, from Attock southwards. From Delhi to Umballa there are two lines, one of the North-Western through Meerut and Saharanpur in the United Provinces, and a more direct one, which is continued to Kalka, at the foot of the hills, whence a further continuation to Simla has been opened. The south-east of the province is served by two branches of the Rajputana system, which have their termini at Delhi and Ferozepore; and also by the Southern Punjab, which runs from Delhi to Bahawalpur.

Population.—The total population of the Punjab (including native states) according to the census of 1901 was 24,754,737, showing an increase of 6.4% in the decade. The Jats, who number some five millions, form the backbone of the cultivating community. Large numbers of them have become Sikhs or Mahommedans in the tracts where those religions predominate. The Rajputs, with a total of over a million and three-quarters, comprise tribes of different religions, races and social systems. By religion they are mostly Mahommedan, only about one-fourth being Hindus, while a very few are Sikhs. By race they include the ancient ruling tribes of the Jumna valley, the Tomar and Chauhan, which gave Delhi its most famous Hindu dynasties; the Bhattis of the south and centre, which have migrated from Bikanir and Jeysulmere into their present seats; the Sials of Jhang; and the Punwars of the south-west. In the northern or submontane districts the Rajputs also represent the old ruling tribes, such as the Chibbs of Gujrat, the Janjuas of the Salt range and others, while in Kangra district they preserve a very old type of Hindu aristocracy. The Gujars are an important agricultural and pastoral tribe. They are most numerous in the eastern half of the province and in the districts of the extreme north-west, especially in Gujrat, to which they have given their name. Baluchis and Pathans are strongly represented in the south-west. The distinctive religion of the Punjab is Sikhism (*q.v.*), though Sikhs form only 8.5% of the total population. Of the rest, Mahommedans are more numerous than Hindus.

Language.—Of the 24,754,737 people in the Punjab about 18,000,000 speak the provincial language, Punjabi, which varies in character in different parts of the province. About 4,000,000 speak Hindustani (see HINDOSTANI), this number including those whose ordinary vernacular is Hindi, but who understand and are gradually adopting the more comprehensive Hindustani. These two languages are the most generally used throughout the province, but not equally in all parts. The other languages in use are more or less local. The hill dialects, known as Pahari, are akin to the language spoken in Rajputana; and so also is the speech of the Gujars. Hindustani is the language of the law courts and of all ordinary officials and other communications with chiefs and people.

Administration.—The administration is conducted by a lieutenant-governor, who is appointed by the governor-general, subject to the approval of the Crown. Two commissioners take the place of the board of revenue in most other provinces. A survival of the "non-regulation" system is to be found in the title of deputy-commissioner for the district officer elsewhere called collector. The highest judicial authority is styled the chief court, consisting of five judges, which corresponds to the high court elsewhere. A legislative council, first created in 1897, was enlarged in 1900 to 26 members, of whom ten are officials and five are elected. The province is distributed into five divisions or commissionerships. Most of the commissioners also exercise political functions over the native states within their jurisdiction.

Education.—The Punjab University, which was founded in 1882, differs from other Indian universities in being more than a merely examining body. It is responsible for the management of the Oriental College at Lahore, and takes a part in the improvement of vernacular literature. It also conducts Oriental examinations side by side with those in English, and has been the first to introduce a series of examinations in science from matriculation to the degree, as well as a final school examination in clerical and commercial subjects. The higher and special educational institutions are the Lahore Government College, the Cambridge

University Mission College at Delhi, the Medical School and the Mayo School of Art at Lahore; and the Punjab Chiefs' College, also at Lahore.

History.—For the early history of the Punjab from the Aryan immigration to the fall of the Mogul dynasty see INDIA: *History*. It deserves, however, to be noted here that from the time of Alexander onwards Greek settlers remained in the Punjab, and that Greek artists gave their services for Buddhist work and introduced features of their own into Indian architecture. Besides the bases and capitals of large Greek columns at Shahderi (Taxila) and elsewhere, numerous sculptures of Greek workmanship have been found at various places. These are single statues (probably portraits), also figures of Buddha, and representations of scenes in his legendary history, and other subjects. They are obtained from ruins of monasteries and other buildings, from mounds and the remains of villages or monumental topes. Of Buddhist buildings now remaining the most conspicuous as well as distinctive in character are the topes (*stupa*), in shape a plain hemisphere, raised on a platform of two or more stages. One of the largest of these is at Manikiala, 14 m. east of Rawalpindi. These Buddhist buildings and sculptures are all probably the work of the two centuries before and the three or four after the beginning of the Christian era. The character of the sculptures is now well known from the specimens in the India Museum, South Kensington, and both originals and casts of others in the Lahore Museum. Unfortunately they have no names or inscriptions, which give so much value to the sculptures of the Bharhut tope.

The several bodies of settlers in the Punjab from the earliest times have formed groups of families or clans (not identical with Indian castes, but in many cases joining them), which have generally preserved distinct characteristics and followed certain classes of occupation in particular parts of the country. Some of the existing tribes in the Punjab are believed to be traceable to the early Aryan settlers, as the Bhatti tribe, whose special region is Bhattiana south of the Sutlej, and who have also in the village of Pindi Bhattian a record of their early occupation of a tract of country on the left bank of the Chenab, west of Lahore. The Dogras, another Aryan clan, belong to a tract of the lower hills between the Chenab and the Ravi. Others similarly have their special ancient localities. To the earlier settlers—the dark race (*Dasyu*) whom the Aryans found in the country, and who are commonly spoken of as aborigines—belonged, as is supposed, the old tribe called Takka, whose name is found in Taksha-sila or Taxila. And from the later foreigners again, the Indo-Scythians, are probably descended the great Jat tribe of cultivators, also the Gujars and others.

It was during the events which brought Baber, the first of the Mogul dynasty, to the throne, that the sect of the Sikhs was founded by Nanak; and it was under the persecution of Aurangzeb that they were raised into a nation of warriors by Govind Singh, the tenth and last of the *gurus*. For their tenets and history see SIKHISM.

The break-up of the Mogul Empire in the 18th century allowed the Sikhs to establish themselves, as a loosely organized community of marauders, in the eastern plains of the Punjab, on both banks of the Sutlej. Here, after long internecine warfare, one of their chieftains succeeded in enforcing his authority over the rest. This was Ranjit Singh, the "Lion of the Punjab," born in 1780, who acquired possession of Lahore as his capital in 1799. Ranjit was a man of strong will and immense energy, of no education but of great acuteness in obtaining the knowledge that would be of use to him. When he endeavoured to include the Sikh states south of the Sutlej within his jurisdiction, the heads of these states—chiefs of Sirhind and Malwa, as they were called—sought and obtained in 1808 the protection of the British, whose territories had now extended to their neighbourhood. The British were at this time desirous of alliance with Lahore as well as with Kabul, for protection against supposed French designs on India. A British envoy, Charles Metcalfe, was received by Ranjit at Kasur in 1809 and the alliance was formed. Ranjit steadily strengthened himself and extended his dominions.

In 1809 he got possession of Kangra, which the Nepalese were besieging. In 1813 he acquired the fort of Attock on the other side of the Punjab; and in the same year he obtained from Shah Shuja, now a refugee in Lahore, what he coveted as much as territory, the celebrated Koh-i-nor diamond, which had been carried off by Nadir Shah from Delhi. In 1818, after some failures in previous years, he captured Multan. Kashmir, which had successfully opposed him several times, was annexed the following year, and likewise the southern part of the country between the Indus and the hills. The Peshawar valley he succeeded in adding four years later, but he found it best to leave an Afghan governor in charge of that troublesome district. These trans-Indus and other outlying tracts were left very much to themselves, and only received a military visit when revenue was wanted. Peshawar was never really ruled till Avitabile was sent there in later years. When he was gradually raising his large and powerful army Ranjit received into his service certain French and other officers, who drilled his troops and greatly improved his artillery. Whilst he relied on these foreigners for military and sometimes also for administrative services, he drew around him a body of native ministers of great ability, of whom the brothers Gulab Singh and Dhian Singh of Jammu were the most influential.

Ranjit always maintained friendly relations with the British government, and just before his death gave tacit approval to the scheme for placing Shah Shuja on the throne of Kabul. His death in 1839 was followed by six years of internal anarchy, princes and ministers being murdered in quick succession, while all real power passed to the army of 90,000 trained troops. At last this army, unpaid and unmanageable, demanded to be led into British territory, and had their way. They crossed the Sutlej in December 1845. The battles of Moodkee, Ferozeshah and Aliwal were followed by the rout of the Sikh army at Sobraon on the 10th of February 1846, when they were driven back into the Sutlej with heavy loss, and the British army advanced to Lahore. Of the Sikh guns 256 fell into the hands of the British in these actions on the Sutlej. A treaty was made at Lahore on the 9th of March with the chiefs and ministry who were to hold the government on behalf of the young maharaja, Duleep Singh. By this treaty the Jullundur Doab and the hill district of Kangra were ceded to the British, also the possessions of the maharaja on the left bank of the Sutlej. In addition the British demanded a money payment of £1,500,000. The services of Gulab Singh, raja of Jammu, to the Lahore state, in procuring the restoration of friendly relations with the British, were specially recognized. His independent sovereignty in such lands as might be made over to him was granted. The Sikh government, unable to pay the whole of the money demand, further ceded, as equivalent for £1,000,000, the hill country between the Beas and the Indus, including Kashmir and Hazara. Gulab Singh was prepared to give the amount in place of which Kashmir was to have become British, and by a separate treaty with him, on the 16th of March 1846, this was arranged. At the urgent request of the durbar a British force was left at Lahore for the protection of the maharaja and the preservation of peace. To restore order and introduce a settled administration a British resident was appointed, who was to guide and control the council of regency, and assistants to the resident were stationed in different parts of the country.

Peace was not long preserved. The governor of Multan, Diwan Mulraj, desired to resign. Two British officers sent by the resident to take over charge of the fort were murdered, on the 10th of April 1848, and their escort went over to the diwan. Another of the assistants to the resident, Lieutenant Herbert Edwardes, then in the Derajat, west of the Indus, on hearing of their fate, collected a force with which to attack the Multan army while the insurrection was yet local. This he did with signal success. But Multan could not fall before such means as he possessed. The movement spread, the operations widened, and the Sikh and British forces were in the field again. Multan was taken. The severe battle of Chillianwalla on the 13th of January 1849 left the Sikhs as persistent as after the two terrible

days of Ferozeshah in the previous campaign. And it needed the crushing defeat of Gujrat, on the 21st of February 1849, to bring the war to a conclusion, and this time to give the Punjab to England. It was annexed on the 2nd of April 1849.

For the government of the new province, including the Jullundur Doab, previously annexed, and the cis-Sutlej states, a board of administration was appointed consisting of three members. In place of this board a chief commissioner was appointed in 1853, aided by a judicial commissioner and a financial commissioner. British troops, European and native, of the regular army were stationed at the chief cities and other places east of the Indus and at Peshawar. For the rest of the trans-Indus territory a special body of native troops, called the Punjab frontier force, was raised and placed under the orders of the chief commissioner. During the Mutiny of 1857 the Punjab, under Sir John Lawrence as chief commissioner, was able to send important aid to the force engaged in the siege of Delhi, while suppressing the disturbances which arose, and meeting the dangers which threatened, within the Punjab itself. In 1858 the Delhi territory, as it was called, west of the Jumna, was transferred from the North-Western Provinces to the Punjab. The enlarged province was raised in rank, and on the 1st of January 1859 the chief commissioner became lieutenant-governor. In 1901 the frontier districts beyond the Indus were severed from the Punjab and made into a separate province called the North-West Frontier province.

See J. D. Cunningham, *History of the Sikhs* (1849); S. S. Thorburn, *The Punjab in Peace and War* (1904); Sir Lepel Griffin, *Ranjit Singh* ("Rulers of India" series, 1892); P. Gough and A. Innes, *The Sikhs and our Sikh Wars* (1897); Professor Rait, *Life of Lord Gough* (1903); Mahomet Latif, *History of the Punjab* (Calcutta, 1891); and *Punjab Gazetteer* (2 vols., Calcutta, 1908).

PUNKAH (Hindustani *punkha*), strictly a fan. In its original sense the punkah is a portable fan, made from the leaf of the palmyra; but the word has come to be used in a special sense by Anglo-Indians for a large swinging fan, fixed to the ceiling, and pulled by a coolie during the hot weather. The date of this invention is not known, but it was familiar to the Arabs as early as the 8th century, though it does not seem to have come into common use in India before the end of the 18th century. Of recent years it has largely been supplanted by the electric fan in barracks and other large buildings.

PUNSHON, WILLIAM MORLEY (1824-1881), English Non-conformist divine, was born at Doncaster, Yorkshire, on the 29th of May 1824. He was educated in his native town, and, after spending a few years in business, at the Wesleyan College, Richmond. In 1845 he received his first appointment, at Marden, Kent, and soon became famous as a preacher. After serving the usual period of probation he was ordained at Manchester in 1849 and for the next nineteen years travelled in several circuits, including some of the London ones (1858-1864). In 1868 he went to Chicago as the representative of the Wesleyan Methodist conference, and settling in Canada did much to advance the cause of his denomination. His preaching and lecturing drew great crowds both in the Dominion and in the United States, and he was five times president of the Canadian conference. He returned to England in 1873, was elected president of conference 1874, and in 1875 one of the missionary secretaries. He published several volumes of sermons, and a book of verse entitled *Sabbath Chimes* (1867, new edition 1880).

PUNT (from Lat. *ponto*, pontoon; connected with *pons*, bridge), a flat-bottomed boat, used for shallow waters, and propelled by a pole, by paddles, or occasionally by sails. Formerly the word was applied to many such flat boats used for ferries, barges, lighters, &c., but it is now generally confined to a light flat boat very long in proportion to its width, with square ends, both at stem and bow, slightly narrowing from the centre, and propelled by pushing against the bottom of the river or other water by a long pole. Such boats are much used for sport or pleasure on rivers with shallow and hard gravelly beds; a small punt with a mounted duck gun and propelled by paddles or short oars is used for wild-fowling. A professional punting

championship of England was instituted in 1876, and an amateur championship in 1886. Etymologically considered, "punt" certainly was adapted from *ponto*, a word used by Caesar (*Bell. civ.* p. iii. 22) of a light vessel for transport in Gaul. Later (as by Gallius and Ausonius) it was also applied to a floating-raft used as a bridge, a pontoon, and so connected with *pons*, bridge.

There are two other words which must be distinguished from the above. One means, in Rugby football, to catch the ball in the hands, drop and kick it before it reaches the ground, as distinguished from a "drop-kick," where the kick is given half-volley, as it reaches the ground. This word is probably cognate with "bunt," a dialect word meaning to push, and both represent nasalized forms of the onomatopoeic "put" or "but." The second, in the substantive "punter," used in the general sense of a gambler or better, originally referred to one who at card games such as basset, baccarat, &c., stakes against the bank. Both "punt" and "punter" are to be referred to Fr. *pontier*, and *ponte*, which is usually taken as an adaptation of Span. *punto*, a point.

PUNTARENAS, or **PUNTA ARENAS**, a seaport and capital of the district (*comarca*) of Puntarenas, Costa Rica; on the Gulf of Nicoya, an inlet of the Pacific Ocean, and at the western terminus of the interoceanic railway from Limón. Pop. (1904), 3569. Puntarenas is the principal harbour of Costa Rica on the Pacific, and a port of call for the United States liners which ply between San Francisco and Panama. It has an iron pier and ample warehouse accommodation for its large and growing export trade in coffee and bananas. The district of Puntarenas comprises the entire littoral from Burica Point to the Rio de las Lajas, an affluent of the Gulf of Nicoya.

PUPIL (Lat. *pupillus*, orphan, minor, dim. of *pupus*, boy, allied to *puer*, from root *pu-* or *peu-*, to beget, cf. "pupa," Lat. for "doll," the name given to the stage intervening between the larval and imaginal stages in certain insects), properly a word taken from Roman law for one below the age of puberty (*impubes*), and not under *patria potestas*, who was under the protection of a *tutor*, a ward or minor (see INFANT; and ROMAN LAW). The term was thus taken by the Civil Law and Scots Law for a person of either sex under the age of puberty in the care of a guardian. Apart from these technical meanings the word is generally used of one who is undergoing instruction or education by a teacher. In education the term "pupil-teacher" is applied to one who, while still receiving education, is engaged in teaching in elementary schools. The system was introduced into England from Holland about 1840. At first the education which the pupil-teachers received was given at the schools to which they were attached. During the last quarter of the 19th century was developed a system of "pupil-teacher centres" where training and education was given. In 1907 was introduced "bursaries," as an alternative; these enable those intending to become teachers to continue their education at training colleges or selected schools as "student teachers." (See EDUCATION.)

A special use of the Lat. feminine diminutive *pupilla* has been adopted in English and other languages for the central orifice in the iris of the eye, the pupil. The origin of the sense may be found in the parallel use in early English of "baby," referring to small images seen reflected in that part of the eye (see EYE and VISION).

PURBECKIAN, in geology, the highest and youngest member of the Jurassic system of rocks. The name is derived from the district known as the Isle of Purbeck in Dorsetshire where the strata are splendidly exposed in the cliffs west of Swanage. The rocks include clays, shales and marls with marly, tuffaceous and shelly limestones and occasional oolitic and sandy strata. Nodules of chert are present in some of the limestones. The Purbeck beds follow the line of the Jurassic outcrop from Dorsetshire, through the Vale of Wardour, Swindon, Garsington, Brill and Aylesbury; they have been proved by borings to lie beneath younger rocks in Sussex; in Lincolnshire they are represented in part by the Spilsby Sands, and in Yorkshire by portions of the Speeton Clay. The thickness of the series in Wiltshire is 80 to 90 ft., but in Dorsetshire it reaches nearly 400 ft. In most places the Purbeckian rests conformably upon

the Portland beds and it is conformably overlaid by the Wealden formations; but there are in some districts distinct indications that the Portland rocks were uplifted and worn to some extent prior to the deposition of the Purbeck beds. The Purbeckian in England is divisible into three subdivisions, viz. Upper, Middle and Lower. The Upper Purbeck comprises 50–60 ft. of fresh-water clays and shales with limestones, the "Purbeck marble" and *Unio*-bed, in the lower part. The Middle division (50–150 ft.), mainly thin limestones with shaly partings, contains the principal building stones of the Swanage district; near the base of this subdivision there is a 5-in. bed from which an interesting suite of mammalian remains has been obtained; in this portion of the Purbeck series there are some marine bands. The Lower Purbeck (95–160 ft.) consists of fresh-water and terrestrial deposits, marls, and limestones with several fossil soils known as "dirt beds." This division is very extensively exposed on the Isle of Portland, where many of the individual beds are known by distinctive names. The chief building stones of Upway belong to this part of the Purbeckian.

No zonal fossil has been recognized for the British Purbeckian strata, but the horizon is approximately equivalent to that of *Perisphinctes transitorius* of the European continent. The Purbeckian equivalents of Spilsby and Speeton are in the zone of *Belemnites lateralis*. Other marine fossils are *Hemicidaris purbeckensis* and *Ostrea distorta*, the latter being abundant in the "Cinder bed" of the Middle Purbeck. The fresh-water mollusca include *Viviparus (Paludina)*, *Planorbis*, *Melanopsis*, *Unio*, *Cyrena*. A large number of insect genera has been found in the Middle and Lower Purbeck beds. Dinosaurs (*Iguanodon*, *Echinodon*), crocodiles (*Goniopholis*, *Petrosuchus*), *Cimoliosaurus*, the plesiosaurs and the chelonians (*Chelone*, *Pleurosternum*), are representative reptiles. The mammals, mostly determined from lower jaws, found in the beds mentioned above include *Plagiaulax*, *Amblotherium*, *Stylodon*, *Triconodon*, *Spalacotherium* and several others. The isopod crustacean *Archeoniscus Brodei* is very common in the Purbeck of the Vale of Wardour. The silicified stumps and trunks of cycads and coniferous trees, often surrounded by great masses of calcareous concretions (Burrns), are very noticeable in the dirt beds of Portland and near Lulworth. *Chara* is found in the fresh-water cherts of the Middle Purbeck.

Many geologists have ranged the Purbeck beds with the overlying Wealden formation on account of the similarity of their fresh-water faunas; but the marine fossils, including the fishes, ally the Purbeck more closely with the Upper Jurassic rocks of other parts, and it may be regarded as the equivalent of the Upper Volgian of Russia. The Purbeckian is present in the neighbourhood of Boulogne; in Charente it is represented by thin limestones with *Cyrena* and by gypsumiferous marls; in north-west Germany three subdivisions are recognized, in descending order Purbeck Kalk, Serpultit and Munder Mergel.

The building stones of the Purbeck beds have already been mentioned; the Purbeck or Paludina marble, a grey or greenish limestone full of shells, was formerly extensively employed in cathedrals and churches. Stone tiles or "slatts" were once used locally for roofing from the Lower Purbeck of Portland, Swanage and Swindon. Gypsum was formerly worked from the Lower Purbeck at Swanage.

See JURASSIC; also *The Jurassic Rocks of Great Britain* (1895); vol. v. and "The Geology of the Isle of Purbeck and Weymouth," *Memoirs of the Geol. Survey* (1898).

PURCELL, HENRY (1658–1695), English musical composer, was born in 1658 in St Ann's Lane, Old Pye Street, Westminster. His father, Henry Purcell (or Pursell), was a gentleman of the chapel-royal, and in that capacity sang at the coronation of Charles II.; he had three sons, Edward, Henry and Daniel—the last of whom (d. 1717) was also a prolific composer. After his father's death in 1664 young Henry Purcell was placed under the guardianship of his uncle, Thomas Purcell (d. 1682), a man of extraordinary probity and kindness. Through the interest of this affectionate guardian, who was himself a gentleman of His Majesty's chapel, Henry was admitted to the chapel-royal as a chorister, and studied first under Captain Henry Cooke (d. 1672), "master of the children," and afterwards under Pelham Humfrey (1647–1674), his successor, a pupil of Lully. He is said to have composed well at nine years old; but the earliest work that can be certainly identified as his is an ode for the king's birthday, written in 1670. (The dates for his compositions are often uncertain, though recent research has done much to fix them more authoritatively.) After Humfrey's death he continued his studies under Dr John Blow. In 1676 he was appointed copyist at Westminster Abbey—not organist, as has

sometimes been erroneously stated—and in the same year he composed the music to Dryden's *Aurange-Zebe*, and Shadwell's *Epsom Wells* and *The Libertine*.¹ These were followed in 1677 by the music to Mrs Behn's tragedy, *Abdelazor*, and in 1678 by an overture and masque for Shadwell's new version of Shakespeare's *Timon of Athens*. The excellence of these compositions is proved by the fact that they contain songs and choruses which never fail to please, even at the present day. The masque in *Timon of Athens* is a masterpiece, and the chorus "In these delightful pleasant groves" in *The Libertine* is constantly sung with applause by English choral societies. In 1679 he wrote some songs for Playford's *Choice Ayres, Songs and Dialogues*, and also an anthem, the name of which is not known, for the chapel-royal. From a letter written by Thomas Purcell, and still extant, we learn that this anthem was composed for the exceptionally fine voice of the Rev. John Gostling, then at Canterbury, but afterwards a gentleman of His Majesty's chapel. Purcell wrote several anthems at different times for this extraordinary voice, a *basso profundo*, the compass of which is known to have comprised at least two full octaves, from D below the stave to D above it. The dates of very few of these sacred compositions are known; but one, "They that go down to the sea in ships," though certainly not written until some time after this period, will be best mentioned here. In thankfulness for a providential escape of the king from shipwreck Gostling, who had been of the royal party, put together some verses from the Psalms in the form of an anthem, and requested Purcell to set them to music. The work is a very fine one but very difficult, and contains a passage which traverses the full extent of Gostling's voice, beginning on the upper D and descending two octaves to the lower.

In 1680 Dr Blow, who had been appointed organist of Westminster Abbey in 1669, resigned his office in favour of his pupil; and Purcell, at the age of twenty-two, was placed in one of the most honourable positions an English artist could occupy. He now devoted himself almost entirely to the composition of sacred music, and for six years entirely severed his connexion with the theatre. But during the early part of the year, and in all probability before entering upon the duties of his new office, he had produced two important works for the stage, the music for Lee's *Theodosius* and D'Urfey's *Virtuous Wife*. The composition of his opera *Dido and Aeneas*, which forms a very important landmark in the history of English dramatic music (see OPERA), has been attributed to this period, though its earliest production has been shown by Mr W. Barclay Squire to have been between 1688 and 1690. It was written to a libretto furnished by Nahum Tate, at the request of Josiah Priest, a professor of dancing, who also kept a boarding-school for young gentlewomen, first in Leicester Fields and afterwards at Chelsea. It is a musical drama in the strictest sense of the term, a genuine opera, in which the action is entirely carried on in recitative, without a word of spoken dialogue from beginning to end; and the music is of the most genial character—a veritable inspiration, overflowing with spontaneous melody, and in every respect immensely in advance of its age. It never found its way to the theatre, though it appears to have been very popular among private circles. It is believed to have been extensively copied, but one song only was printed by Purcell's widow in *Orpheus Britannicus*, and the complete work remained in manuscript until 1840, when it was printed by the Musical Antiquarian Society, under the editorship of Sir George Macfarren.

In 1682 Purcell was appointed organist of the chapel-royal, vice Edmund Lowe deceased, an office which he was able to hold conjointly with his appointment at Westminster Abbey. He had recently married, his eldest son being born in this year. His first printed composition, *Twelve Sonatas*, was published in 1683. For some years after this his pen was busily employed in the production of sacred music, odes addressed to the king and royal family, and other similar works. In 1685 he wrote two

¹ *The Libertine* was suggested by Tirso de Molina's tale, *El Burlador de Sevilla*, afterwards dramatically treated by Molière and chosen by Da Ponte as the foundation of Mozart's *Don Giovanni*.

of his finest anthems, "I was glad" and "My heart is inditing," for the coronation of James II. In 1687 he resumed his connexion with the theatre by furnishing the music for Dryden's tragedy, *Tyrannic Love*. In this year also Purcell composed a march and quick-step, which became so popular that Lord Wharton adapted the latter to the fatal verses of *Lillibulero*; and in or before January 1688 he composed his anthem "Blessed are they that fear the Lord," by express command of the king. A few months later he wrote the music for D'Urfey's play, *The Fool's Preferment*. In 1690 he wrote the songs for Dryden's version of Shakespeare's *Tempest*, including "Full fathom five" and "Come unto these Yellow Sands," and the music for Betterton's adaptation of Fletcher and Massinger's *Prophesess* (afterwards called *Dioclesian*) and Dryden's *Amphitryon*; and in 1691 he produced his dramatic masterpiece, *King Arthur*, also written by Dryden, and first published by the Musical Antiquarian Society in 1843. In 1692 he composed songs and music for *The Fairy Queen* (an adaptation of Shakespeare's *Midsummer Night's Dream*), the score of which (discovered in 1901) was edited in 1903 for the Purcell Society by J. S. Shedlock.

But Purcell's greatest work is undoubtedly his *Te Deum* and *Jubilate*, written for St Cecilia's Day, 1694, the first English *Te Deum* ever composed with orchestral accompaniments. In this he pressed forward so far in advance of the age that the work was annually performed at St Paul's Cathedral till 1712, after which it was performed alternately with Handel's *Utrecht Te Deum* and *Jubilate* until 1743, when it finally gave place to Handel's *Dettingen Te Deum*. Purcell did not long survive the production of this great work. He composed an anthem for Queen Mary's funeral, and two elegies. He died at his house in Dean's Yard, Westminster, on the 21st of November 1695, and was buried under the organ in Westminster Abbey. He left a widow and three children, three having predeceased him. His widow died in 1706. She published a number of his works, including the now famous collection called *Orpheus Britannicus* (two books, 1698, 1702).

Besides the operas already mentioned, Purcell wrote *Don Quixote*, *Bonduca*, *The Indian Queen* and others, a vast quantity of sacred music, and numerous odes, cantatas and other miscellaneous pieces. (See the list in Grove's *Dictionary of Music*.)

A Purcell Club was founded in London in 1836 for promoting the performance of his music, but was dissolved in 1863. In 1876 a Purcell Society was founded, which has done excellent work in publishing new editions of his works.

PURCHAS, SAMUEL (1575?-1626), English compiler of works on travel and discovery, was born at Thaxted, Essex, and graduated at St John's College, Cambridge, in 1600; later he became B.D., with which degree he was admitted at Oxford in 1615. In 1604 he was presented by James I. to the vicarage of Eastwood, Essex, and in 1614 became chaplain to Archbishop Abbot and rector of St Martin's, Ludgate, London. He had previously spent much time in London on his geographical work. In 1613 he published *Purchas, his Pilgrimage; or, Relations of the World and the Religions observed in all Ages* (4th ed. much enlarged, 1626); in 1619 *Purchas, his Pilgrim. Microcosmus, or the histories of Man. Relating the wonders of his Generation, vanities in his Degeneration, Necessity of his Regeneration*; and in 1625 *Hakluytus Posthumus or Purchas his Pilgrimes, containyng a History of the World in Sea Voyages and Lande Travells, by Englishmen and others* (4 vols.). This continuation of Hakluyt's *Principal Navigations* was partly based on MSS. left by Hakluyt. The fourth edition of the *Pilgrimage* is usually catalogued as vol. v. of the *Pilgrimes*, but the two works are essentially distinct. Purchas died in September or October 1626, according to some in a debtors' prison. None of his works was reprinted till the Glasgow reissue of the *Pilgrimes* in 1905-1907. As an editor and compiler Purchas was often injudicious, careless and even unfaithful; but his collections contain much of value, and are frequently the only sources of information upon important questions affecting the history of exploration.

PURCHASE, in its common sense, that which is acquired by the payment of money or its equivalent. The original

meaning of the word (O. Fr. *purchacier*, *purchasser*, &c., popular, Lat. *pro-captiare*) was to pursue eagerly, hence to acquire. Thus "purchase" was early used by the lawyers (e.g. Britton, in 1292) for the acquirement of property by other means than inheritance or mere act of law, including acquirement by escheat, prescription, occupancy, alienation and forfeiture; more generally, purchase in law means acquisition of land by bargain or sale, according to the law of "vendor and purchaser" (see CONVEYANCING). A later development of meaning is found in the use of the word for a mechanical contrivance by which power can be excited or applied, a hold or fulcrum. This first appears (16th century) in the nautical use of the verb, to haul up a rope or cable by some mechanical device, the root idea being apparently to "gain" advantage over the rope bit by bit.

PURDAH (Pers. *parda*), the curtain which screens women from the sight of men in Eastern countries; a *pardah-nashin* is a woman who sits behind the curtain. The term has passed into common Anglo-Indian usage, and to "lift the purdah" means to reveal a secret.

PURGATORY (Late Lat. *purgatorium*, from *purgare*, to purge), according to Roman Catholic faith, a state of suffering after death in which the souls of those who die in venial sin, and of those who still owe some debt of temporal punishment for mortal sin, are rendered fit to enter heaven. It is believed that such souls continue to be members of the Church of Christ; that they are helped by the suffrages of the living—that is, by prayers, alms and other good works, and more especially by the sacrifice of the Mass; and that, although delayed until "the last farthing is paid," their salvation is assured. Catholics support this doctrine chiefly by reference to the Jewish belief in the efficacy of prayer for the dead (2 Macc. xii. 42 seq.), the tradition of the early Christians, and the authority of the Church.

Irenaeus regards as heretical the opinion that the souls of the departed pass immediately into glory; Tertullian, Cyprian, the Acts of St Perpetua, Clement of Alexandria, Cyril of Jerusalem, Basil, Gregory of Nyassa, Ambrose, Chrysostom and Jerome, all speak of prayer for the dead and seem to imply belief in a purgatory, but their view seems to have been affected by the pre-Christian doctrine of Hades or Sheol. Some of the Greeks, notably Origen, teach that even the perfect must go through fire in the next world. Augustine writes (*De VIII. Dulcitii quaestionibus*) that "it is not incredible" that imperfect souls will be "saved by some purgatorial fire," to which they will be subjected for varying lengths of time according to their needs; but in other passages he expresses conflicting opinions (*De civitate*, xx. 25, xxi. 13, 26; *Enchiridion*, 69). Gregory the Great was the first to formulate the doctrine in express terms, "*de quibusdam levibus culpis esse ante iudicium purgatorius ignis credendus est*" (*Dial.* iv. 39). Thenceforth it became part of the theology of the Western Church, and was definitely affirmed at the councils of Lyons (1274), Florence (1439) and Trent. Concerning the word *purgatory*, Innocent IV. writes: "Forasmuch as (the Greeks) say that this place of purification is not indicated by their doctors by an appropriate and accurate word, we will, in accordance with the tradition and authority of the holy fathers, that henceforth it be called *purgatorium*, for in this temporary fire are cleansed not deadly capital sins, which must be remitted by penance, but those lesser venial sins which, if not removed in life, afflict men after death."

Many points about purgatory, on which the Church has no definition, have been subjects of much speculation among Catholics. Purgatory, for example, is usually thought of as having some position in space, and as being distinct from heaven and hell; but any theory as to its exact latitude and longitude, such as underlies Dante's description, must be regarded as imaginative. Most theologians since Thomas Aquinas and Bonaventura have taught that the souls in purgatory are tormented by material fire, but the Greeks have never accepted this opinion. It must be inferred from the whole practice of indulgences as at present authorized that the pains of purgatory are measurable by years and days; but here also everything is indefinite. The Council of Trent, while it commands all bishops to teach "the sound doctrine of purgatory handed down by the venerable fathers and sacred councils," bids them exclude from popular addresses all the "more difficult and subtle questions relating to the subject which do not tend to edification."

The Eastern Church affirms belief in an intermediate state after death, but the belief is otherwise as vague as the expressions

of the pre-Nicene fathers on the subject. An authoritative statement of the present Eastern doctrine is to be found in the Longer Catechism of the Orthodox Church (Q. 376):—

“Such souls as have departed with faith but without having had time to bring forth fruits meet for repentance may be aided towards the attainment of a blessed resurrection by prayers offered in their behalf, especially such as are offered in union with the oblation of the bloodless sacrifice of the Body and Blood of Christ, and by works of mercy done in faith for their memory.”

The efficacy of prayers for the dead, and indirectly the doctrine of purgatory, were denied by early Gnostic sects, by Aërius in the 4th century, and by the Waldenses, Cathari, Albigenses and Lollards in the middle ages. Protestants, with the exception of a small minority in the Anglican communion, unanimously reject the doctrine of purgatory, and affirm that “the souls of believers are at their death made perfect in holiness and do immediately pass into glory.” Rejection of an intermediate state after death follows the Protestant idea of justification by faith as logically as the doctrine of purgatory results from the Catholic idea of justification by works.

An analogy to purgatory can be traced in most religions. Thus the fundamental ideas of a middle state after death and of a purification preparatory to perfect blessedness are met with in Zoroaster, who takes souls through twelve stages before they are sufficiently purified to enter heaven; and the Stoics conceived of a middle place of enlightenment which they called *ἐμπύρωσις*.

The principal authoritative statements of the Catholic Church on the doctrine of purgatory were made at the Council of Florence (*Decret. unionis*), and at that of Trent (Sess. vi. can. 30; Sess. xxii., c. 2, can. 3; Sess. xxv.). See H. J. D. Denzinger's *Enchiridion*; J. Bautz, *Das Fegfeuer* (Mainz, 1883); and L. Redner, *Das Fegfeuer* (Regensburg, 1856). A very elaborate treatise from the Catholic standpoint is that of Cardinal Bellarmine, *De purgatorio*. The subject is discussed, moreover, in all major works on dogmatic theology. There is a representative Catholic statement by Hense in the *Kirchenlexikon* under the title “Fegfeuer,” 2nd ed., vol. 4, col. 1284–1296; and a corresponding Protestant presentation by Rud. Hoffmann in Hauck's *Realencyklopädie*, 3rd ed. vol. v. pp. 788–792. (C. H. HA.)

PURI, or **JAGANNATH**, a town and district of British India, in the Orissa division of Bengal. The town is on the sea-coast, and has a railway station. Pop. (1901), 49,334, including an exceptional number of pilgrims. As containing the world-famous shrine of Jagannath (see JUGGERNAUT), Puri is perhaps the most frequented of all Hindu places of pilgrimage. Sanitation is effected by the Puri Lodging-House Act, which provides for the appointment of a special health officer, and for the licensing of lodging-houses both in the town and along the pilgrims' route.

The DISTRICT OF PURI has an area of 2499 sq. m. The population in 1901 was 1,017,284, showing an increase of 7.6% in the decade. For the most part the country is flat, the only mountains being a low range which, rising in the west, runs south-east in an irregular line towards the Chilka lake and forms a water-parting between the district and the valley of the Mahanadi. The middle and eastern divisions of the district, forming the south-western part of the Mahanadi delta, consist entirely of alluvial plains, watered by a network of channels through which the most southerly branch of that river, the Koyakhai, finds its way into the sea. The other rivers are the Bhargavi, the Daya and the Nun, all of which flow into the Chilka lake and are navigable by large boats during the rainy season, when the waters come down in tremendous floods, bursting the banks and carrying everything before them. The Chilka lake is one of the largest in India; its length is 44 m., and its breadth in some parts 20 m. It is separated from the sea only by a narrow strip of sand. The lake is saline and everywhere very shallow, its mean depth ranging from 3 to 5 ft. Puri district is rich in historical remains, from the primitive rock-hewn caves of Buddhism—the earliest relics of Indian architecture—to the medieval sun temple at Kanarak and the shrine of Jagannath. The annual rainfall averages 58 in.

Puri first came under British administration in 1803. The only political events in its history since that date have been the rebellion of the maharaja of Khurda in 1804 and the rising of the *paiks* or peasant militia in 1817–18. In the Orissa famine of 1866 more than one-third of the population of Puri is said to have perished. The district suffered from drought in 1897. It is served by the East Coast railway, which was opened

throughout from Calcutta to Madras in 1891, with a branch to Puri town.

See *Puri District Gazetteer* (Calcutta, 1908).

PURIFICATION, in the study of comparative religion, may be defined as the expulsion or elimination by ritual actions and ceremonies from an individual or a community, a place or a dwelling, of the contagion of a taboo (*q.v.*) or ritual pollution, which is often conceived of as due to the presence of or haunting by an unclean spirit, and having for its effect disease, pain and death. In the higher religions the idea of purification has slowly developed into that of ethical liberation from sin and guilt. This development involves a distinction between the outward act and the inner act or motive, which we do not find even in the relatively advanced codes of the ancient Jews or of the Athenians of the 5th century B.C., for in both of these the taboo or guilt of homicide was the same whether accidentally or wilfully committed. It is part of this development that contrition, remorse and repentance come to be recognized, together with merely ritual acts, such as baptism and sacramental meals, as a condition of regaining the lost purity or status. The ethical ideal of atonement and purity of heart is at last attained when, as in the Society of Friends, all ritual acts are abandoned as indifferent to moral progress. The dross of the primitive taboo still encumbers the conscience in churches which insist on outward ritual performances as an element in holiness or moral perfection and purity. The tendency of civilization is more and more to antiquate them as obstacles rather than aids to the formation of character.

In most primitive societies the chief sources of ritual pollution are birth, death, bloodshed, blood, especially menstuous blood. Numberless other things are or have been taboo among different peoples, such as trees, colours, foods and drinks, persons, places, seasons. Persons and things brought even involuntarily into contact or association with these are tabooed, and only recover their normal condition by some rite of purification or *catharsis*. Such rites operate by the transference elsewhere of the stain or impurity contracted. Very generally the impurity is due to the haunting by an unclean spirit or ghost, who must be driven off by exorcists invoking the name of a more powerful and clean spirit, which usually enters the thing or person possessed in place of the unclean. On this side rites of purification may become rites of consecration. In lower civilizations disease and madness are held to be caused by evil spirits which are similarly expelled; and on this side purificatory rites develop into the medical art. It must be borne in mind that a drug was originally not a substance succeeding by dint of its chemical properties and physical reactions on our bodies, but a talisman or charm taken internally and succeeding by reason of its magical properties.

Among the methods of purification used widely among different races and in various religions, the following may be enumerated, though the list might be indefinitely extended.

1. Piacular sacrifices, often recurring annually, intended to renew the life of the god in the worshippers. “Without shedding of blood there is no remission of sins” (Heb. ix. 22).
2. Vicarious sacrifice, whereby the guilt of an individual or of a clan is transferred into an animal, like the Jewish scapegoat, which is forthwith destroyed or sent over the frontier.
3. Washing or sprinkling with water, as a rule previously blessed or exorcised; or with the water of separation (*i.e.* water mixed with ashes of a red heifer).
4. Washing with *gomez*, or urine of the sacred cow.
5. Anointing with holy oil.
6. Smearing with the blood, *e.g.* of the passover lamb or of a pig; or by actual baptism with the blood of an ox as in the Taurobolium (see MITHRAS).
7. Fumigation with smoke of incense used at sacrifices, the incense itself being the gum of a holy tree and gathered with magical precautions.
8. Rubbing with sulphur or other lyes. Use of hellebore, hyssop, &c.
9. Burning with fire objects in which the impurity has been confined.
10. Sprinkling with water in which the cross has been washed (used for flocks and fields in Armenia).
11. Evil spirits are expelled by invocation of the name of a being more powerful than they, and by the introduction of a clean spirit.
12. By fasting.
13. In the old Parsee religion the *drugs* or demons which infect a corpse can be driven off by the look of certain kinds of dogs.
14. An impure contagion may be removable together with hair, nails or bits of clothing. Hence the use of the tonsure and the custom of shaving the head in vows.

15. Houses may be purged of evil spirits by sweeping them out with a broom, or by many of the cathartic media above enumerated for purification of the person.

16. By use of salt.

17. By celibacy, virginity and abstinence from sexual intercourse.

18. By confession or expulsion of the evil in speech.

19. By spitting and blowing the nose in order to evacuate devils harbouring in the head and throat.

20. By spittle, as in the baptismal rite of the Latins.

21. By passing between fires or jumping through fire.

22. By sitting or standing on or wearing the fleece of a holy animal.

23. By beating and stinging with ants, by branding, tattooing, knocking out of teeth.

24. By circumcision and other more serious mutilations.

In many of these rites the old man contaminated in some way is put off and the mystic is reborn. This idea of rebirth is especially prominent in the blood-bath of the Taurobolium (No. 6) and in Christian baptism (q.v.); also in the initiatory rites of various savages who even make a pretence of killing their boys and bringing them back to life again. (F. C. C.)

PURIM, a Jewish festival held on the 14th and 15th of Adar, the last month of the Jewish calendar. According to Jewish tradition it is held in celebration of the deliverance of the Jews from the massacre plotted against them by their enemy Haman in the time of Artaxerxes, who fixed upon the former date by casting "lots" (= Hebrew loan-word *Purim*). It is preceded by a fast on the 13th day of Adar, known as the Fast of Esther, based upon Esther iv. 16.

Purim is the carnival of the Jewish year. Friends exchange gifts, and thus occasion is taken to relieve the necessities of the poor in the most considerate manner under the guise of gifts. The children masquerade, and their parents are enjoined to drink wine until they cannot distinguish between blessing Mordecai and cursing Haman. The Megillah or Roll of Esther is read both at home and in the synagogue, and wherever, during the reading, the name of Haman is mentioned, it is accompanied with tramping the feet. In former times Haman was burnt in effigy, holding on to a ring and swinging from one side of the fire to the other (see L. Ginzberg, *Geonica*, 1909, pp. 1, 419; Davidson, *Parody*, pp. 21-22). This custom, which is still observed among the Jews of Caucasia (Tchorri, *Sepher ha-Masaot*, pp. 191-192), is very ancient, as it is mentioned in the Talmud (Sanhedrin 64). From the 17th century onward Purim plays were performed mostly by the children, who improvised a dramatic version of the story of Esther. This grew to be the characteristic folk-drama of the ghetto, and has not died out in eastern Europe to the present day.

Much ingenuity has been spent upon the name and origin of the feast. As regards the name, we may dismiss at once the suggestions of J. Fuerst (*Kanon des Alten Testaments*) that it is derived from the Persian *bahar*, "spring," and of Hitzig (*Geschichte Israels*), who derives it from the modern Arabic *Phur*, "the New Year." These conjectures were made in the pre-scientific era of philology. Scarcely more is to be said in favour of the suggestion made by Von Hammer; but better known in connexion with the name of Lagarde, who connects the name Purim with the old Zoroastrian festival of the dead, entitled *Farwardigan*. Lagarde, who is followed by Renan, connects this form with the LXX. variant of the Hebrew (*פּוּרְיָל*); but there is absolutely nothing about Purim which suggests any relation with a festival of the dead. Graetz's suggestion (*Monats. Jud.* xxxv. 10 seq.) that it is derived from the Hebrew *purah*, meaning wine-press (Is. lxiii. 3), obviously fails to connect a spring festival of joyousness with the autumn vine harvest. Zimmern (*ZATW* xl. 157 seq.) connects Purim with the *puchru* or assembly of the gods, which forms part of the Babylonian New Year festival *Zagmuku*, but the inserted guttural is against the identification.

The most plausible etymology connects the name with the Assyrian *puru*, either in the sense of "turn" of office at the beginning of the New Year or in that of "pebble" used for votes or lots, as with the Greek *πῦρος*. It is a curious coincidence, to say the least, that Dieulafoy found among the ruins of the Memnonium at Susa (the ancient Shushan, given as the scene of the events narrated in the Book of Esther) a quadrangular prism bearing different numbers on its four faces. This etymological connexion, suggested by Jensen (*Kosmologie*, 84), brings the festival of Purim into close relation with the Babylonian New Year festival known as *Zagmuku*, in which one of the most prominent ceremonials was the celebration of the assembly of the gods under the presidency of Marduk (Merodach) for the purpose of determining the fates of the New Year. Meissner (*ZDMG*, i. 296 seq.) and others have suggested that the drunkenness

and masquerading current at the period of Purim are directly derived from the general period of licence allowed at the Sacaea festival of the Babylonian New Year. Even the fact that this latter was celebrated on the first of Nisan, or a fortnight after the Jewish date for Purim, is confirmed by the Book of Esther itself, which states that "In the first month, which is the month Nisan, they cast Pur, that is, the lot, before Haman" (Esther iii. 7-ix. 26). The change of date may have been made in order not to conflict with the Passover on the 15th of Nisan. The connexion that has been suggested between the names of Mordecai and Esther and those of the Assyrian deities Marduk and Ishtar would be a further strong confirmation of the proposed etymology and derivation of the feast (see ESTHER).

Going still further, J. G. Frazer connects Purim with the whole series of spring festivals current in western Asia, in which the old god of vegetation was put to death and a new human representative of him elected and allowed to have royal and divine rights, so as to promote the coming harvest (*Golden Bough*, 2nd. ed., vol. iii. p. 154 seq.). The death of the god, he suggests, is represented by the Fast of Esther on the 13th of Adar, the day before Purim, while the rejoicing on Purim itself, and the licence accompanying it, recall the union of the god and goddess of vegetation, of which he sees traces in the relations of Mordecai and Esther. There may possibly be "survivals" of the influence of some such celebrations both on the Book of Esther and on the ceremonies of Purim, but there is absolutely no evidence that the Jews took over the interpretation of these festivals with their celebration. Nor is there any record of royal privileges attaching to any person at the period of Purim such as occurs in the festivals with which it is supposed to be connected by Frazer. His further suggestion, therefore, that the ironical crowning of Jesus with the crown of thorns and the inscription over the Cross, together with the selection of Barabbas, had anything to do with the feast of Purim, must be rejected. The connexion of the Passion with the Passover rather than Purim would alone be sufficient to nullify the suggestion. However, it is practically certain, both from the etymology of the word Purim and from the resemblance of the festivals, that the feast, as represented in the Book of Esther, was borrowed from the Persians, who themselves appeared to have adapted it from the Babylonians. This is confirmed by the fact that the Book of Esther contains several Persian words and shows throughout a familiarity with Persian conditions. This renders it impossible to accept Haupt's suggestion that Purim is connected with the celebration of Nicanor's Day, to celebrate the triumph of Judas Maccabaeus over the Syrian general Nicanor at Adasa (161 B.C.) on the 13th of Adar, since this is the date of the Fast of Esther, and, besides, the Second Book of Maccabees, which refers to Nicanor's Day, speaks of it as the day before Mordecai's Day (2 Macc. xvi. 36). If, as seems probable, the earlier Greek version of the Book of Esther was made about 179 B.C. (Swete, *Introduction of the Old Testament in Greek*, p. 25), this suggestion of the connexion of Purim with the Maccabean period made by Haupt and, before him, by Willrich, falls to the ground.

At the same time it is difficult to understand why Jews in Palestine and Egypt should have accepted a purely Persian or Babylonian festival long after they had ceased to be connected with the Persian Empire. One can understand its adoption during, or soon after, the reign of Cyrus, whose policy was so favourable to the Jews, and it might easily have become as popular among them as Christmas tends to become among modern Jews. When the exiles returned from Babylon they probably brought back with them the practice of keeping the festival.

The date at which the feast of Purim was first adopted by the Jews from their Persian neighbours would be definitely determined if we knew the date of the Book of Esther. The festival is first mentioned in 2 Macc. xv. 36, and from that time onwards has formed one of the most popular festivals of the Jewish calendar. It became customary to burn an effigy of Haman at the conclusion of the feast, and this was regarded as in some ways an attack on Christianity and was therefore forbidden by the Theodosian code, XVI. viii. 18. This prohibition may have been due to the fact mentioned by Socrates (*Hist. eccles.* vii.) that, in 416 A.D., the Jews of Inmester, a town in Syria, ill-treated a Christian child during some Purim pranks and caused his death. It has even been suggested that this gave rise to the myth of the blood accusation in which Jews are alleged to sacrifice a Christian child at Passover; but this is unlikely, since it has never been suggested that this crime was committed in connexion with Purim. But Jewish sources of the 10th century state that the custom of burning an effigy of Haman was still kept up at that time (L. Ginzberg, *Geonica*, ii.), and this is confirmed by Albiruni (*Chronology*, tr. Sachau, 273) and Makrizi, and indeed the custom was carried on down to the present century by Jewish children, who treated Haman as a sort of Guy Fawkes. Frazer suggests (*loc. cit.* 172) that this is a survival

acid; and 7-methylxanthine or heteroxanthine, which is found in human urine, may be obtained from theobromine (E. Fischer, *Ber.*, 1897, 30, p. 2400; see also *ibid.*, 1898, 31, p. 117).

Theophylline, $C_7H_{10}N_4O_2$, or 1-3-dimethyl-2-6-dioxypurin, was isolated by A. Kossel from tea-leaves (*Ber.*, 1888, 21, p. 2164). It was synthesized by E. Fischer and L. Ach (*Ber.*, 1895, 28, p. 3135) from 1-3-dimethyl uric acid, which on treatment with phosphorus pentachloride yields chlortheophylline, from which theophylline is obtained by reduction with hydriodic acid. W. Traube (*Ber.*, 1900, 33, p. 3035) formed the nitroso derivative of iminodimethyl barbituric acid (obtained by the action of phosphorus oxychloride on cyanacetic acid and dimethyl urea), and reduced it by ammonium sulphide to 1-3-dimethyl-4-5-diamino-2-6-dioxypyrimidine, the formyl derivative of which, when heated to 250° C., loses the elements of water and yields theophylline (cf. *Xanthine*). It behaves as a weak base. When oxidized by potassium chlorate and hydrochloric acid it yields dimethylalloxan. Its silver salt on methylation yields caffeine.

The isomeric **Paraxanthine**, or 1-7-dimethyl-2-6-dioxypurin, occurs in urine. It has been obtained from theobromine (E. Fischer, *Ber.*, 1897, 30, p. 2400); from 1-7-dimethyl uric acid (E. Fischer and H. Clemm, *Ber.*, 1898, 31, p. 2622); and from 8-chlorcaffeine (E. Fischer, *Ber.*, 1906, 39, p. 423). On methylation it yields caffeine.

A third isomer **Theobromine**, or 3-7-dimethyl-2-6-dioxypurin, is found in the cocoa-bean (from *Theobroma cacao*) and in the kola-nut. It is obtained by methylating xanthine, or from 3-7-dimethyl uric acid (E. Fischer, *Ber.*, 1897, 30, p. 1839). This acid, by the action of phosphorus oxychloride and pentachloride, is converted into 3-7-dimethyl-6-chlor-2-8-dioxypurin, which with ammonia gives the corresponding amino compound. This substance with phosphorus oxychloride yields 3-7-dimethyl-6-amino-2-oxy-8-chlorpurin, which on reduction with hydriodic acid leads to 3-7-dimethyl-6-amino-2-oxypurin, from which theobromine is obtained by the action of nitrous acid. It is also obtained by W. Traube's method (*Ber.*, 1900, 33, p. 3047) from cyanacetyl methyl urea, which gives 3-methyl-4-5-diamino-2-6-dioxypyrimidine, whose formyl derivative yields 3-methylxanthine, from which theobromine is obtained by methylation. It crystallizes in anhydrous needles which sublime at 290-295° C. It behaves as a weak base. Potassium chlorate and hydrochloric acid oxidize it to methylalloxan and methyl urea, chromic acid mixture oxidizes it to carbon dioxide, methylamine and methylparabanic acid. When boiled with baryta it yields carbon dioxide, ammonia, methylamine, formic acid and sarcosine. Methylation of its silver salt yields caffeine.

Caffeine, $C_8H_{10}N_4O_2$, is 1-3,7-trimethyl-2-6-dioxypurin. For its general properties and method of extraction see **CAFFEINE**. It may be synthesized by methylating chlortheophylline and reducing the resulting product (E. Fischer and L. Ach, *Ber.*, 1895, 28, p. 3135); by the action of phosphorus oxychloride on tetramethyl uric acid, the resulting chlorcaffeine being reduced (*Ber.*, 1897, 30, p. 3010); from dimethylalloxan (*Ber.*, 1897, 30, p. 564); from 3-methyl uric acid (*Ber.*, 1898, 31, p. 1980), and from 1-3-dimethyl-4-5-diamino-2-6-dioxypyrimidine (W. Traube, *Ber.*, 1900, 33, p. 3042). The three latter methods may be outlined as follows. Dimethylalloxan (I.) condenses with methylamine in the presence of sulphurous acid to form an addition product (II.), which on hydrolysis yields 1-3-7-trimethyl uramil; this substance gives with potassium cyanate, 1-3-7-trimethyl pseudo-uric acid (III.), which on dehydration yields 1-3-7-trimethyl uric acid (hydroxycaffeine); this substance with phosphorus pentachloride gives chlrcaffeine, which yields caffeine (IV.) on reduction:—

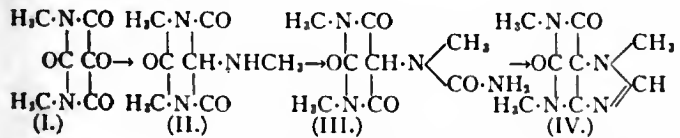

3-Methyl uric acid (I.) (H. Hill, *Ber.*, 1876, 9, p. 370) by the action of phosphorus oxychloride is converted into 3-methyl-2-6-dioxy-8-chlorpurin (3-methyl-chlorxanthine) (II.), which, on treatment with methyl iodide in alkaline solution, gives chlortheobromine (III.), from which chlorcaffeine (IV.) can be obtained by further methylation:—

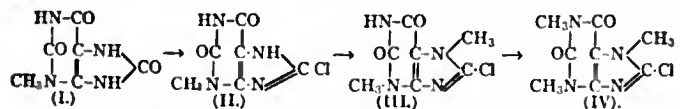

Dimethyl-diamino-dioxypyrimidine (see *Theophyllin* above) yields a formyl derivative which on treatment with sodium ethylate furnishes a sodium salt. This salt heated for some hours with methyl iodide yields caffeine.

The constitution of caffeine was settled by E. Fischer (*Ann.*, 1882, 215, p. 253). Earlier investigations had shown that oxidation with nitric acid gave dimethylparabanic acid or cholesterophane (J. Stenhouse, *Ann.*, 1843, 45, p. 366); that chlorine water oxidized

it to amalic acid or tetramethyl alloxantin (Fr. Rochleder, *Ann.*, 1849, 71, p. 1), and that hydrolysis with baryta gave caffeidine (A. Strecker, *Ann.*, 1862, 123, p. 360), which could be further hydrolysed to sarcosine, methylamine, formic acid and carbon dioxide (O. Schultzen, *Zeit. f. Chemie*, 1867, p. 614). Fischer confirmed these results and showed further that oxidation with chloric water gave monomethyl urea and dimethyl alloxan, pointing to the presence of three methyl groups in the molecule. Further, on bromination, a brom-derivative is obtained which on treatment with alcoholic potash yields ethoxy-caffeine, which readily hydrolyses to hydroxy-caffeine. This substance behaves as an unsaturated compound and combines with a molecule of bromine to form a derivative which on treatment with alcoholic potash yields diethoxy-hydroxy-caffeine. Diethoxy-hydroxycaffeine on hydrolysis with concentrated hydrochloric acid yields apocaffeine, $C_7H_7N_3O_3$, and hypocaffeine, $C_8H_7N_3O_2$:

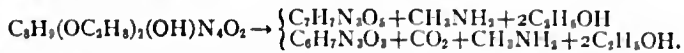

Apocaffeine when boiled with water loses carbon dioxide and yields caffuric acid, $C_6H_5N_3O_4$, which on hydrolysis with basic lead acetate is converted into mesoxalic acid, methylamine and monomethyl urea. Reduction of caffuric acid yields hydrocaffuric acid, $C_6H_5N_3O_3$, which readily hydrolyses to methyl hydantoin. Consequently hydrocaffuric and caffuric acids, apocaffeine and caffeine must contain the grouping (I.). Hypocaffeine on hydrolysis loses carbon dioxide and gives caffolin, $C_8H_9N_3O_2$, which on oxidation with alkaline potassium ferricyanide yields monomethyl urea and methyl oxamic acid, whilst if oxidized by alkaline potassium permanganate it yields dimethyl oxamide. Hence caffolin contains the grouping (II.), and in consequence of its close relationship to hydrocaffuric acid is to be written as (III.). It follows that the caffeine molecule must be written as (IV.), a result confirmed by the later synthesis of caffeine itself from dimethyl alloxan (see above).

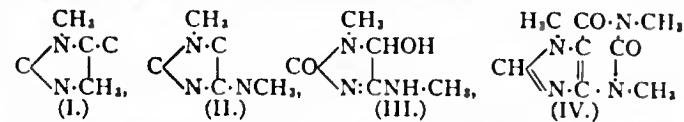

The above decomposition products of caffeine probably possess the following constitutions:—

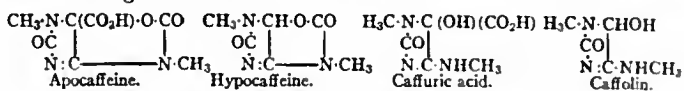

Uric acid, $C_5H_4N_4O_3$, or 2-6-8-trioxypurin, was discovered in 1776 in urinary calculi by Scheele. It is found in the juice of the muscles, in blood, in urine, in the excrement of serpents and birds, and in guano. The determination of the constitution and of the relation of uric acid to the other members of the group has been a process of gradual growth. G. Brugnatelli (*Giornale di fisica, chimica, &c., di Brugnatelli*, 1818, 11, pp. 38, 117) obtained alloxan, and W. Prout (*Phil. Trans.*, 1818, p. 420) obtained ammonium purpurate from uric acid, but the first elaborate investigation on the acid was by J. v. Liebig and F. Wöhler (*Ann.*, 1838, 26, p. 241), who obtained from it allantoin, alloxantin, dialuric acid, parabanic acid, oxaluric acid, mesoxalic acid, &c. Further examination of the group was undertaken by A. Schlieper (*Ann.*, 1845, 55, p. 256; 56, p. 1), who obtained hydrurilic acid and diluric acid, and by A. v. Baeyer (*Ann.*, 1863, 127, pp. 1, 199; 1864, 130, p. 129; 131, p. 291), who showed that uric acid and many of its derivatives may be looked on as derivatives of barbituric acid. In 1875 L. Medicus (*Ann.*, 1875, 175, p. 230) proposed the formula (I.) for the acid, whilst R. Fittig in 1877 (*Traité de chim. org.*, p. 324 [1878]) suggested the formula (II.); subsequent investigations of R. Behrend and

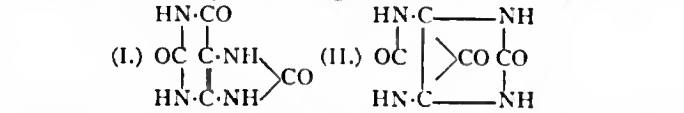

of E. Fischer showed the first formula to be correct. The first syntheses of uric acid are due to J. Horbaczewski (*Monats.*, 1882, p. 796; 1885, p. 356), who obtained very poor yields. These were followed by the more satisfactory methods of R. Behrend and O. Roosen (*Ann.*, 1888, 251, p. 235) of E. Fischer and L. Ach (*Ber.*, 1895, 28, p. 2473) and of W. Traube (*Ber.*, 1900, 33, p. 3035). Horbaczewski obtained the acid by heating urea with amino-acetic acid (glycine) to 200-230° C. and by fusing urea with trichloracetamide. In Behrend's method acetoacetic ester and urea (I.) are condensed and the resulting β -uramidocrotonic ester (II.) on hydrolysis gives methyl uracil (III.), which on treatment with concentrated nitric acid yields nitro-uracil carboxylic acid (IV.). This acid when boiled with water loses carbon dioxide, forming nitro-uracil (V.), which on reduction gives amido-uracil (VI.) and oxy-uracil (VII.). Oxidation of oxy-uracil with bromine water leads to dioxo-uracil (VIII.), which when heated with urea and concentrated sulphuric acid yields uric acid (IX.):—

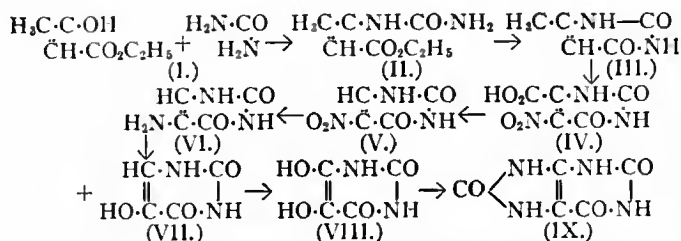

E. Fischer dehydrated pseudo-uric acid (formed from potassium cyanate and uramil) by heating it with anhydrous oxalic acid to 185° C, or with a large excess of 20% hydrochloric acid (*Ber.*, 1897, 30, p. 560), and so obtained uric acid. This method is quite general. W. Traube condenses the sulphate of 4·5-diamino-2·6-dioxy-pyrimidine (I.) (see *Xanthine*, above) with chlorcarbonic ester. The resulting urethane (II.) when heated to 180–190° C loses a molecule of alcohol, giving uric acid (III.).

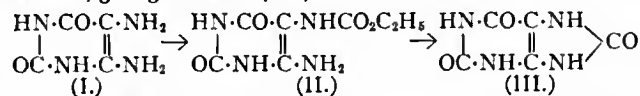

Uric acid is a white, microcrystalline powder. It is odourless and tasteless, and is insoluble in most reagents. Its solubility in water is increased by the presence of various inorganic salts, such as sodium phosphate, sodium acetate, borax, and particularly by lithium carbonate. It dissolves completely in concentrated sulphuric acid, but is reprecipitated on the addition of water. It behaves as a weak dibasic acid. It is decomposed by heat into ammonia, urea, cyanuric acid and carbon dioxide. On fusion with caustic alkalis it yields alkaline cyanide, cyanate, oxalate and carbonate. It may be recognized by means of the "murexide" reaction, which consists in evaporating the acid to dryness with nitric acid, when a yellowish residue is obtained which becomes purple-red if moistened with ammonia. On the quantitative estimation of uric acid see F. W. Tunncliffe (*Chem. Centralb.*, 1897, 11, p. 987; E. H. Bartley, *ibid.*, p. 644 and F. G. Hopkins, *Chem. News*, 1892, 66, p. 106).

Methyl Uric Acids.—1-Methyl uric acid was prepared by E. Fischer and H. Clemm (*Ber.*, 1897, 30, p. 3091) from monomethyl alloxan and ammonium sulphite, which condense together to form 1-methyluramil. This, with potassium cyanate, gives 1-methyl-4ψ-uric acid, which on dehydration gives 1-methyl uric acid. 3- or α-Methyl uric acid was prepared by Hill (*Ber.*, 1876, 9, p. 370) by heating acid lead urate with methyl iodide. It is best obtained by heating 3-methyl chlorxanthine with hydrochloric acid to 125° C. (E. Fischer, *Ber.*, 1898, 31, p. 1984). 7- or γ-Methyl uric acid is prepared by heating 7-methyl-2·6·8-trichlorpurin (which results from phosphorus pentachloride and theobromine) with hydrochloric acid to 130° C., or by the condensation of alloxan with methylamine in the presence of sulphur dioxide (E. Fischer, *Ber.*, 1897, 30, p. 563; cf. 1-methyl uric acid). It is the most soluble in water of the methyl uric acids. 9- or β-Methyl uric acid was obtained by E. Fischer (*Ber.*, 1884, 17, pp. 332, 1777) by heating normal lead urate with methyl iodide to 100° C. The product so obtained was converted by the action of phosphorus oxychloride and pentachloride into 9-methyl-8-oxy-2·6-dichlorpurin, and this when heated with hydrochloric acid to 140° C. gave the required methyl uric acid. It is distinguished from 3-methyl uric acid by its much smaller solubility in water and by the greater stability of its ammonium salt. A fifth isomer, δ-methyl uric acid, has been described by W. v. Loeben (*Ann.*, 1897, 298, p. 181) who obtained it by condensing acetoacetic ester and monomethyl urea according to Behrend's method. The constitution of this acid is not definitely known.

1·3 or γ-Dimethyl uric acid is obtained by converting dimethyl alloxan into dimethyluramil, which with potassium cyanate gives dimethylψ-uric acid; this acid is then dehydrated (E. Fischer, *Ber.*, 1895, 28, p. 2475; 1897, 30, p. 560). 1·7-Dimethyl uric acid is similarly obtained by starting with monomethyl alloxan and methylamine (E. Fischer and H. Clemm, *Ber.*, 1897, 30, p. 3095).

1·9-Dimethyl uric acid is obtained from 9-methyl-8-oxy-2·6-dichlorpurin (see *9-Methyl uric acid* above). By successive treatment with ammonia and nitrous acid this is converted into 9-methyl-6·8-dioxy-2-chlorpurin, which on condensation with formaldehyde in alkaline solution yields 9-methyl-7-oxymethyl-6·8-dioxy-2-chlorpurin. Methylation of this latter compound introduces a methyl group into position 1, and the dimethyl compound so formed on dilution with water and the simultaneous action of superheated steam yields 1·9-dimethyl-6·8-dioxy-2-chlorpurin, from which 1·9-dimethyl uric acid is obtained by hydrolysis with concentrated hydrochloric acid at 100° C. (E. Fischer, and F. Ach *Ber.*, 1899, 32, p. 257). 3·7 or δ-Dimethyl uric acid is prepared by methylating 7-methyl uric acid (E. Fischer, *Ber.*, 1897, 30, p. 564) or by heating bromtheobromine with alkalis (*Ber.*, 1895, 28, p. 2482). 3·9-Dimethyl uric acid is prepared by heating neutral lead urate with methyl iodide (H. B. Hill and C. F. Mabery, *Amer. Chem. Journ.*, 1880–1881, 2,

p. 308) and by methylating 3-methyl uric acid (E. Fischer, *Ber.*, 1899, 32, p. 269). 7·9 or β-Dimethyl uric acid is prepared by heating 7·9-dimethyl-8-oxy-2·6-dichlorpurin with hydrochloric acid to 130° C.

1·3·7-Trimethyl uric acid or hydroxycaffeine, may be prepared from caffeine, or by direct methylation of uric acid at 0° C. (E. Fischer). 1·3·9-Trimethyl uric acid is prepared by methylating 1·3-dimethyl uric acid (E. Fischer and L. Ach, *Ber.*, 1895, 28, p. 2478). 1·7·9-Trimethyl uric acid is prepared by methylating 9-methyl-6·8-dioxy-2-chlorpurin (see *1·9-dimethyl uric acid*, above) and heating the resulting trimethyl dioxychlorpurin with concentrated hydrochloric acid to 110–115° C. (E. Fischer and F. Ach, *Ber.*, 1899, 32, p. 256).

Tetramethyl uric acid was first prepared (*Ber.*, 1884, 17, p. 1784) by methylating 3·7·9-trimethyl uric acid. It may also be obtained by methylating uric acid and the other methyl uric acids. It has a neutral reaction.

Aminopurins.—*Adenine* is 6-aminopurin. It has been found in ox pancreas and also in tea. It is prepared by heating 2·6·8-trichlorpurin with ammonia, and reducing the resulting 6-amino-2·8-dichlorpurin with hydriodic acid; or by heating 8-oxy-2·6-dichlorpurin (from uric acid and phosphorus oxychloride) with alcoholic ammonia to obtain 8-oxy-2-chlor-6-aminopurin, which with phosphorus oxychloride at 140° C., gives 6-amino-2·8-dichlorpurin. Reduction of this compound with hydriodic acid yields adenine (E. Fischer, *Ber.*, 1897, 30, p. 2238; 1898, 31, p. 104). It crystallizes from water in leaflets which contain three molecules of water of crystallization. The anhydrous base melts at 360–365° C. Nitrous acid converts it into hypoxanthine; whilst hydrochloric acid at 180–200° C. decomposes it completely into ammonia, carbon dioxide, formic acid and glycolic acid (A. Kossel, *Ber.*, 1890, 23, p. 225; 1893, 26, p. 1914).

Isoadenine or 2-aminopurin, is obtained from 2·4-dichlor-5-nitropyrimidine (see *Purin*, above) by heating it with ammonia, when 2·4-diamino-5-nitropyrimidine is formed. Reduction of this compound by means of stannous chloride and hydrochloric acid gives 2·4·5-triaminopyrimidine which readily condenses with formic acid to isoadenine (O. Isay, *Ber.*, 1906, 39, p. 250). It has also been obtained by J. Tafel and B. Ach (*Ber.*, 1901, 34, p. 1177) by the electrolytic reduction of guanine to desoxyguanine, the acetate of which is warmed with bromine and subsequently oxidized.

9-Methyl adenine was first obtained by I. Krüger (*Zeit. f. physiol. Chem.*, 1894, 18, p. 434) by methylating adenine, and has been synthesized by E. Fischer (*Ber.*, 1898, 31, p. 104) from 9-methyl-2·6-dichlor-8-oxypurin. For 7-methyl adenine see E. Fischer, *Ber.*, 1898, 31, p. 104.

Guanine, or 2-amino-6-oxypurin, is found in the pancreas of various animals and also very abundantly in guano, from which it was first extracted by B. Unger (*Ann.*, 1844, 51, p. 395; 1846, 58, p. 18). It has been obtained synthetically from 6-oxy-2·8-dichlorpurin (E. Fischer, *Ber.*, 1897, 30, p. 2252) by heating it with alcoholic ammonia to 150° C. and reducing the resulting 6-oxy-2-amino-8-chlorpurin with hydriodic acid. W. Traube (*Ber.*, 1900, 33, p. 1371) condensed cyanacetic ester with guanidine and the resulting compound (I.) with caustic soda gives 2·4-diamino-6-oxypyrimidine (II.). This substance yields an isonitroso-derivative which on reduction with ammonium sulphide gives 2·4·5-triamino-6-oxypyrimidine (III.), from which guanine (IV.) is obtained by heating with concentrated formic acid:—

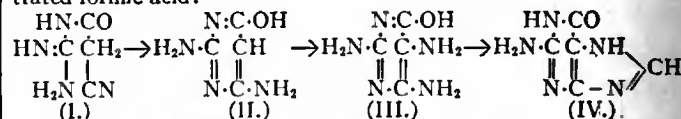

It may also be obtained as follows [E. Merck, German Patents 158591 (1903); 162336 (1904)]. Dicyandiamide (I.) condenses with cyanacetic ester to form 2-cyanamino-4-amino-6-oxypyrimidine (II.). This yields an isonitroso-derivative which on reduction gives 2-cyanamino-4·5-diamino-6-oxypyrimidine (III.). This compound when boiled with a 90% solution of formic acid gives guanine formate:—

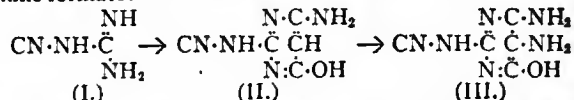

It is an amorphous powder, insoluble in water, alcohol and ether, and has both acid and basic properties. Nitrous acid converts it into xanthine. When oxidized by hydrochloric acid and potassium chlorate it yields guanidine, parabanic acid and carbon dioxide.

6-Amino-2-oxypurin, an isomer of guanine, is prepared by heating dichloradenine or 6-amino-2·6·8-trichlorpurin, obtained from 2·6·8 trichlorpurin and ammonia (Fischer, *Ber.*, 1897, 30, p. 2239) with sodium ethylate to 130° C. and reducing the resulting 6-amino-2-ethoxy-8-chlorpurin with hydriodic acid (E. Fischer, *Ber.*, 1897, 30, p. 2245). 6-Amino-8-oxypurin, another isomer of guanine, is prepared by heating 8-oxy-2·6-dichlorpurin with alcoholic ammonia and reducing the resulting amino-oxy-chlor compound with hydriodic acid (E. Fischer, *loc. cit.*).

7-Methyl guanine is obtained from 7-methyl-6-oxy-2-chlorpurin (see above) by the action of aqueous ammonia at 150° C. It also results instead of the expected 7-methyl-2-oxy-6-aminopurine, when 7-methyl-6-amino-2-chlorpurin is treated with dilute alkalis (E. Fischer, *Ber.*, 1898, 31, p. 542), owing to ring splitting in the 1-6-position, followed by eliminating of halogen acid.

Thiopurins.—W. Traube (*Ann.*, 1904, 331, pp. 66 seq.) has obtained many compounds of the purin group by using thiourea, which is condensed with cyanacetic ester, &c., to form thiopyrimidines. These in turn yield thiopurins, which on oxidation with dilute nitric acid are converted into purin compounds, thus:—

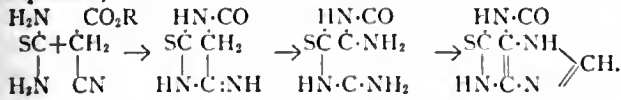

Various thiopurins have been obtained by E. Fischer (*Ber.*, 1898, 31, p. 431), principally by acting with potassium sulphhydrate on chlorinated purin compounds.

2-6-8-Trithiopurine is obtained from the corresponding trichlorpurin and potassium sulphhydrate. It forms a light yellow mass which carbonizes on heating. It is almost insoluble in water and alcohol; but readily dissolves in dilute solutions of the caustic alkalis and of ammonia.

Much work has been done by J. Tafel (*Ber.*, 1900, seq.) on the electrolytic reduction of the members of the purin group. The substance to be reduced is dissolved in a 50-75% solution of sulphuric acid and placed in a porous cell containing a lead cathode, the whole being then placed in a 20-60% solution of sulphuric acid in the anode cell. It is found that xanthine and its homologues take up four atoms of hydrogen per molecule and give rise to the so-called desoxy-compounds, which are stronger bases than the original substances. Uric acid takes up six hydrogen atoms per molecule and gives *purone*, C₅H₄N₂O₂, and it is apparently the oxygen atom attached to the carbon atom number 6 which is replaced by hydrogen, since when purone is heated with baryta, two molecules of carbon dioxide are liberated for one of purone. Consequently purone must contain two urea residues, which necessitates the presence of the >CO groups in positions 2 and 8. (F. G. P. *)

PURITANISM (Lat. *puritas*, purity), the name given—originally perhaps in a hostile sense on the analogy of Catharism (see CATHARS)—to the movement for greater strictness of life and simplicity in worship which grew up in the Church of England in the 16th century among those who thought that there had not been a sufficient divergence from the Roman Church, and which ultimately led to the rise of a number of separatist denominations. Thomas Fuller (*Church History*) traces the earliest use of the term "Puritan" to 1564. The terms "Precisian," "Puritan," "Presbyterian," were all used by Archbishop Parker in his letters about this time as nicknames for the same party, and ten years later the name was in common use.

See ENGLAND, CHURCH OF; CONGREGATIONALISM; PRESBYTERIANISM, &c.; also D. Neal, *History of the Puritans* (ed. Toulmin, 5 vols., 1822); E. Dowden, *Puritan and Anglican* (1901); J. Heron, *A Short History of Puritanism* (1908).

PURLIEU, a word used of the outlying parts of a place or district, sometimes in a derogatory sense. It was a term of the old English forest law (*q.v.*), and meant, as defined by Manwood (*Treatise of the Forest Laws*), "a certain territory of ground adjoining unto the forest, . . . which . . . was once forest-land and afterwards disafforested by the perambulations made for the severing of the new forests from the old." The owner of free-lands in the purlieu to the yearly value of forty shillings was known as a "purlieu-man" or "purley-man." There seems no doubt that "purlieu" or "purley" represents the Anglo-French *purallé*, *puralee* (O. Fr. *poualer*, *puraler*, to go through, Lat. *perambulare*), a legal term meaning properly a perambulation to determine the boundaries of a manor, parish, &c.

PURLIN, a term in architecture for the longitudinal timbers of a roof, which are carried by the principal rafters and the end walls and support the common rafters.

PURNEA or **PURNIAH**, a town and district of British India, in the Bhagalpur division of Bengal. The town is on the left bank of the little river Saura, with a railway station. Pop. (1901), 14,007. It has a bad reputation for fever.

The DISTRICT OF PURNEA has an area of 4994 sq. m. and a population (1901) of 1,874,794, showing a decrease of 3.6%

in the decade. The district extends from the Ganges northwards to the frontier of Nepal. It is a level, depressed tract of country, consisting for the most part of a rich, loamy soil of alluvial formation. It is traversed by several rivers flowing from the Himalayas, which afford great advantages of irrigation and water-carriage; in the west the soil is thickly covered with sand deposited by changes in the course of the Kusi. Among other rivers are the Mahananda and the Panar. Under Mahomedan rule Purnea was an outlying province, yielding little revenue and often in a state of anarchy. Its local governor raised a rebellion against Suraj-ud-daula in 1757, after the capture of Calcutta. The principal crops are rice, pulses and oilseeds. The cultivation of indigo is declining, but that of jute is extending. The district is traversed by branches of the Eastern Bengal railway, which join the Bengal and North-Western railway at Katihar.

PURPLE, a colour-name, now given to a shade varying between crimson and violet. Formerly it was used, as the origin of the name shows, of the deep crimson colour called in Latin *purpura*, *purpureus* and in Greek *πορφύρα*, *πορφύρεος* (from *πορφύρεω*, to grow dark, especially used of the sea). This was properly the name of the shellfish (*Purpura*, *Murex*) which yielded the famous Tyrian dye, the particular mark of the dress of emperors, kings, chief magistrates and other dignitaries, whence "the purple" still signifies the rank of emperors or kings.

The title of *porphyrogenitus* (Gr. *πορφυρογέννητος*) was borne particularly by Constantine VII., Byzantine emperor, but was also used generally of those born of the Byzantine imperial family. This title, generally translated "born in the purple," either refers to the purple robes in which the imperial children were wrapped at birth, or to a chamber or part of the imperial palace, called the *Porphyra* (*πόρφυρα*), where the births took place. Whether this *Porphyra* signified a chamber with purple hangings or lined with porphyry is not known (see Selden, *Titles of Honour*, ed. 1672, p. 60 seq.).

PURPURA, in pathology, a general term for the symptom of purple-coloured spots upon the surface of the body, due to extravasations of blood in the skin, accompanied occasionally with haemorrhages from mucous membranes. The varieties of purpura may be conveniently divided as follows: (a) toxic, following the administration of certain drugs, notably copaiba, quinine, ergot, belladonna and the iodides; also following snake-bite; (b) cachectic, seen in persons suffering from such diseases as tuberculosis, heart disease, cancer, Bright's disease, jaundice, as well as from certain of the infectious fevers, extravasations of the kind above mentioned being not infrequently present; (c) neurotic; (d) arthritic, which includes the form known as "Purpura simplex," in which there may or may not be articular pain, and the complaint is usually ushered in by lassitude and feverishness, followed by the appearance on the surface of the body of the characteristic spots in the form of small red points scattered over the skin of the limbs and trunk. The spots are not raised above the surface, and they do not disappear on pressure. Their colour soon becomes deep purple or nearly black; but after a few days they undergo the changes which are observed in the case of an ordinary bruise, passing to a green and yellow hue and finally disappearing. When of minute size they are termed "petechiae" or "stigmata," when somewhat larger "vibices," and when in patches of considerable size "ecchymoses." They may come out in fresh crops over a lengthened period.

Purpura rheumatica (Schönlein's disease) is a remarkable variety characterized by sore throat, fever and articular pains accompanied by purpuric spots and associated with urticaria and occasionally with definite nodular infiltrations. This is by many writers considered to be a separate disease, but it is usually regarded as of rheumatic origin.

Purpura haemorrhagica (acute haemorrhagic purpura) is a more serious form, in which, in addition to the phenomena already mentioned as affecting the skin, there is a tendency to the occurrence of haemorrhage from mucous surfaces, especially from the nose, but also from the mouth, lungs, stomach, bowels, kidneys, &c., sometimes in large and dangerous amount. Great physical prostration is apt to attend this form of the disease, and a fatal result sometimes follows the successive haemorrhages, or is suddenly precipitated by the occurrence of an extravasation of blood into the brain.

The treatment will bear reference to any causes which may be discovered as associated with the onset of the disease, such as unfavourable hygienic conditions, and nutritive defects should be rectified by suitable diet. The various preparations of iron seem to be the best medicinal remedies in this ailment, while more direct astringents, such as gallic acid, ergot of rye, turpentine or acetate of lead, will in addition be called for in severe cases and especially when haemorrhage occurs. Sir A. Wright considers that in all cases of purpura the coagulation-time of the blood should be estimated. In such cases the time taken for clotting may be increased to three times as long as that taken by normal blood. He therefore advises calcium chloride in order to increase coagulability. In severe haemorrhages, adrenalin is often useful.

PURRAH, PURROH, or PORO, a secret society of Sierra Leone, West Africa. Only males are admitted to its ranks, but two other affiliated and secret associations exist, the Yassi and the Bundu, the first of which is nominally reserved for females, but members of the Purrah are admitted to certain ceremonies. All the female members of the Yassi must be also members of the Bundu, which is strictly reserved to women. Of the three, the Purrah is by far the most important. The entire native population is governed by its code of laws. It primarily represents a type of freemasonry, a "friendly" society to which even infants are temporarily admitted, the ceremony in their case consisting merely of carrying them into the Purrah "bush" and out again. But this side of the Purrah is merged in its larger objects as represented by its two great aspects, the religious and the civil. Under the former, boys join it at puberty, while under the latter it is practically the native governing body, making laws, deciding on war and peace, &c.

The Purrah has its special ritual and language, tattooing and symbols, but details are unknown, as the oath of secrecy is always kept. It meets usually in the dry season, between the months of October and May. The rendezvous is in "the bush," an enclosure, separated into apartments by mats and roofed only by the overhanging trees, serving as a club-house. There are three grades, the first for chiefs and "big men," the second for fetish-priests and the third for the crowd. The ceremonies of the Purrah are presided over by the Purrah "devil," a man in fetish dress, who addresses the meeting through a long tube of wood.

The Purrah can place its taboo on anything or anybody; and as no native would venture to defy its order, much trouble has been caused where the taboo has been laid upon crops. In 1897 the British or local government was compelled to pass a special ordinance absolutely forbidding the imposition of the taboo on all indigenous products. Of the affiliated societies the Yassi appears to some extent to be an association for providing men and women, who believe themselves ill through "fetish," with medical treatment, on payment of certain fees. The women's Bundu is in many ways a replica of the men's Purrah, though without political power.

See T. J. Aldridge, *The Sherbro and its Hinterland* (1901).

PURSE (Late Lat. *bursa*, adapted from Gr. *βύρσα*, hide, skin; possibly O. Eng. *pusa*, bag, has influenced the change from *b* to *p*), a small bag for holding money, originally a leather pouch tied at the mouth, but now of various shapes. The great seal of England is borne by the purse-bearer in a purse, usually styled "burse," decorated with the arms of the kingdom, the "burse" being thus one of the insignia of office of the lord chancellor of England. The "privy purse" is the amount of public money set apart in the civil list for the private and personal use of the sovereign (see PRIVY PURSE).

PURSER, the old name for the paymaster of the British and American navies still used in merchant vessels of to-day. In the British navy he was appointed by a warrant from the admiralty and was paid partly by salary and partly by a percentage (10%) on the value of unexpended stores.

PURSLANE, the common name for a small fleshy annual with prostrate stems, entire leaves and small yellow flowers, known botanically as *Portulaca oleracea*. It is a native of India, which was introduced into Europe as a salad plant, and in some countries has spread so as to become a noxious weed. In certain

parts of the United States the evil qualities of "pussly" have become proverbial. Its juice is refreshing and is used in tropical countries as a refrigerant in fever. Some of the species of the same genus, such as *P. grandiflora* and its varieties, are grown in gardens on rock-work owing to the great beauty and deep colouring of their flowers, the short duration of individual blossoms being compensated for by the abundance with which they are produced.

PURSUIVANT (O. Fr. *porsivant*, *poursivant*, mod. *poursuivant*, strictly an attendant, from *poursuivre*, to follow), the name of a member of the third and lowest rank of heraldic officers, formerly an attendant on the heralds. There are four pursuivants in the English Herald's College, Rouge Croix, Bluemantle, Rouge Dragon and Portcullis; three in the Court of Lyon King of Arms (Scotland), Carrick, Unicorn and March; and four in the court of Ulster King of Arms (Ireland), Athlone and three St Patrick pursuivants. (See HERALD and HERALDRY.)

PURULIA, a town of British India, headquarters of Manbhoom district in Bengal, on the Sini-Asansol branch of the Bengal-Nagpur railway. Pop. (1901), 17,291. It is a growing centre of trade.

PURVEYANCE (Lat. *providere*, to provide), in England in former times the right of the sovereign when travelling through the country to receive food and drink and maintenance generally from his subjects for himself and his retinue. The custom dates from Anglo-Saxon times and is analogous to the right of *fodrum*, or *annona militaris*, exercised by the Frankish kings. Although in early times purveyance was reasonable and necessary, enabling the king to make journeys for the purpose of administering justice and discharging the other duties of government, it was liable to grave abuses, and under the later Plantagenet kings it became very oppressive. Provision for the royal needs was interpreted in the widest possible sense, and the right was exercised, not only on behalf of the king, but on behalf of his relatives. Besides victuals it included the compulsory use of horses and carts and even the enforcement of personal labour. Not infrequently no payment was made; when it was it often took the form of tallies, which gave the recipient the right to deduct the amount from any taxes he might have to pay in the future. Purveyors were appointed to requisition goods, and they also fixed the price. The abuses of purveyance, which appear to have reached their climax during the reign of Edward I., frequently provoked legislation. Chapter xxviii. of Magna Carta is directed against them, while further attempts to curb them were made in the Statute of Westminster of 1275 and in the *Articuli super cartas* of 1300. Purveyance was entirely forbidden by the ordinance of 1311, but in spite of all prohibitions its evils grew and flourished. During the reign of Edward III. ten statutes were directed against it, and by a law of 1362 it was restricted to the personal wants of the king and queen; at the same time the hated name of purveyor was changed to that of buyer, and ready money was ordered to be paid for the articles taken. From this time little was heard about the evils of purveyance until 1604, when the House of Commons petitioned James I., giving some striking illustrations of its hardships. It was asserted that when the royal officials required 200 carts they ordered 800 or 900 to be brought, in order that they might obtain bribes from the owners. Bacon called purveyance "the most common and general abuse of all others in the kingdom." Twice James entered into negotiations with his parliament for commuting his crown rights, of which purveyance was one, for an annual payment, but no arrangement was reached. In 1660, however, the right of purveyance, which had fallen into disuse with the execution of Charles I., was surrendered by Charles II. in return for the grant of an excise on beer and liquors. The custom was exercised by almost all European sovereigns, and in France at least was as oppressive as in England. The word purveyor now means merely a vendor, generally a vendor of food and drink.

See W. Stubbs, *Constitutional History of England* (1896), vol. ii.; H. Hallam, *Constitutional History of England* (1863); and S. R. Gardiner, *History of England* (1905), vol. i.

PUSA, a village of British India, in Darbhanga district, Bengal, near the right bank of the Burhi Gandak River; pop. (1901), 4570. It was acquired as a government estate in 1796, and was long used as a stud *dépôt* and afterwards as a tobacco farm. In 1904 it was selected as the site of a college and laboratory for agricultural research.

PUSEY, EDWARD BOUVERIE (1800–1882), English divine, was born at Pusey near Oxford on the 22nd of August 1800. His father was Philip Bouverie (d. 1828), a younger son of Jacob Bouverie, 1st Viscount Folkestone, and took the name of Pusey on succeeding to the manorial estates at that place. After having been at Eton, he became a commoner of Christ Church, Oxford, and was elected in 1824 to a fellowship at Oriel. He thus became a member of a society which already contained some of the ablest of his contemporaries—among them J. H. Newman and John Keble. Between 1825 and 1827 he studied Oriental languages and German theology at Göttingen. His first work, published in 1828, as an answer to Hugh James Rose's Cambridge lectures on rationalist tendencies in German theology, showed a good deal of sympathy with the German "pietists," who had striven to deliver Protestantism from its decadence; this sympathy was misunderstood, and Pusey was himself accused of holding rationalist views.

In the same year (1828) the duke of Wellington appointed him to the regius professorship of Hebrew with the attached canonry of Christ Church. The misunderstanding of his position led to the publication in 1830 of a second part of Pusey's *Historical Enquiry*, in which he denied the charge of rationalism. But in the years which immediately followed the current of his thoughts began to set in another direction. The revolt against individualism had begun, and he was attracted to its standard. By the end of 1833 he showed a disposition to make common cause with those who had already begun to issue the *Tracts for the Times*. "He was not, however, fully associated in the movement till 1835 and 1836, when he published his tract on baptism and started the Library of the Fathers" (Newman's *Apologia*, p. 136). He became a close student of the fathers and of that school of Anglican divines who had continued, or revived, in the 17th century the main traditions of pre-Reformation teaching. A sermon which he preached before the university in 1843, *The Holy Eucharist a Comfort to the Penitent*, so startled the authorities by the re-statement of doctrines which, though well known to ecclesiastical antiquaries, had faded from the common view, that by the exercise of an authority which, however legitimate, was almost obsolete, he was suspended for two years from the function of preaching. The immediate effect of his suspension was the sale of 18,000 copies of the condemned sermon; its permanent effect was to make Pusey for the next quarter of a century the most influential person in the Anglican Church, for it was one of the causes which led Newman to sever himself from that communion. The movement, in the actual origination of which he had had no share, came to bear his name: it was popularly known as Puseyism (sometimes as Newmanism) and its adherents as Puseyites. His activity, both public and private, as leader of the movement was enormous. He was not only on the stage but also behind the scenes of every important controversy, whether theological or academical. In the Gorham controversy of 1850, in the question of Oxford reform in 1854, in the prosecution of some of the writers of *Essays and Reviews*, especially of Benjamin Jowett, in 1863, in the question as to the reform of the marriage laws from 1849 to the end of his life, in the Farrar controversy as to the meaning of everlasting punishment in 1877, he was always busy with articles, letters, treatises and sermons. The occasions on which, in his turn, he preached before his university were all memorable; and some of the sermons were manifestoes which mark distinct stages in the history of the High Church party of which he was the leader. The practice of confession in the Church of England practically dates from his two sermons on *The Entire Absolution of the Penitent*, in 1846, in which the revival of high sacramental doctrine is complemented by the advocacy of a revival of the penitential system which medieval theologians had appended to

it. The sermon on *The Presence of Christ in the Holy Eucharist*, in 1853, first formulated the doctrine round which almost all the subsequent theology of his followers revolved, and which revolutionized the practices of Anglican worship. Of his larger works the most important are his two books on the Eucharist—*The Doctrine of the Real Presence* (1855) and *The Real Presence . . . the Doctrine of the English Church* (1857); *Daniel the Prophet* in which he endeavours to maintain the traditional date of that book; *The Minor Prophets, with Commentary*, his chief contribution to the study of which he was the professor; and the *Eirenicon*, in which he endeavoured to find a basis of union between the Church of England and the Church of Rome.

In private life Pusey's habits were simple almost to austerity. He had few personal friends, and rarely mingled in general society; though bitter to opponents, he was gentle to those who knew him, and his munificent charities gave him a warm place in the hearts of many to whom he was personally unknown. In his domestic life he had some severe trials; his wife died, after eleven years of married life, in 1839; his only son, who was a scholar like-minded with himself, who had shared many of his literary labours, and who had edited an excellent edition of St Cyril's commentary on the minor prophets, died in 1880, after many years of suffering. From that time Pusey was seen by only a few persons. His strength gradually declined, and he died on the 16th of September 1882, after a short illness. He was buried at Oxford in the cathedral of which he had been for fifty-four years a canon. In his memory his friends purchased his library, and bought for it a house in Oxford, known as the Pusey House, which they endowed with sufficient funds to maintain three librarians, who were charged with the duty of endeavouring to perpetuate in the university the memory of the principles which he taught.

Pusey is chiefly remembered as the eponymous representative of the earlier phase of a movement which carried with it no small part of the religious life of England in the latter half of the 19th century. His own chief characteristic was an almost unbounded capacity for taking pains. His chief influence was that of a preacher and a spiritual adviser. As a preacher he lacked all the graces of oratory, but compelled attention by his searching and practical earnestness. His correspondence as a spiritual adviser was enormous; his deserved reputation for piety and for solidity of character made him the chosen confessor to whom large numbers of men and women unburdened their doubts and their sins. But if he be estimated apart from his position as the head of a great party, it must be considered that he was more a theological antiquary than a theologian. Pusey in fact was left behind by his followers even in his lifetime. His revival of the doctrine of the Real Presence, coinciding as it did with the revival of a taste for medieval art, naturally led to a revival of the pre-Reformation ceremonial of worship. With this revival of ceremonial Pusey had little sympathy: he at first protested against it (in a university sermon in 1859); and, though he came to defend those who were accused of breaking the law in their practice of it, he did so on the express ground that their practice was alien to his own. But this revival of ceremonial in its various degrees became the chief external characteristic of the new movement; and "Ritualist" thrust "Puseyite" aside as the designation of those who hold the doctrines for which he mainly contended. On the other hand, the pivot of his teaching was the appeal to primitive antiquity; and in this respect he helped to start inquiry which has since gone far beyond the materials which were open to one of his generation.

See J. Rigg, *Character and Life-Work of Dr Pusey* (1883); B. W. Savile, *Dr Pusey, an Historic Sketch, with Some Account of the Oxford Movement* (1883), and especially the *Life* by Canon Liddon, completed by J. C. Johnston and R. J. Wilson (5 vols., 1893–1899). Newman's *Apologia*, and other literature of the Oxford Movement.

Pusey's elder brother, PHILIP PUSEY (1799–1855), was a member of parliament and a friend and follower of Sir Robert Peel. He was one of the founders of the Royal Agricultural Society, and was chairman of the implement department of the great exhibition of 1851. He was a fellow

of the Royal Society, a writer on varied topics to the reviews and the author of the hymn "Lord of our Life and God of our Salvation."

PUSHBALL, a game played by two sides on a field usually 140 yds. long and 50 yds. wide, with a ball 6 ft. in diameter and 50 lb in weight. The sides usually number eleven each, there being five forwards, two left-wings, two right-wings and two goal-keepers. The goals consist of two upright posts 18 ft. high and 20 ft. apart with a crossbar 7 ft. from the ground. The game lasts for two periods with an intermission. Pushing the ball under the bar counts 5 points; lifting or throwing it over the bar counts 8. A touchdown behind goal for safety counts 2 to the attacking side. The game was invented by M. G. Crane, of Newton, Massachusetts, in 1894, and was taken up at Harvard University the next year, but has never attained any considerable vogue. In Great Britain the first regular game was played at the Crystal Palace in 1902 by teams of eight. The English rules are somewhat different from those obtaining in the United States. Pushball on horseback was introduced in 1902 at Durland's Riding Academy in New York, and has been played in England at the Military Tournament.

PUSHKAR, a town of British India, in Ajmere district, Rajputana, 7 m. N. of Ajmere town. Pop. (1901), 3831. It derives its name from a small lake among the hills, 2389 ft. above the sea, in which Brahma is once said to have bathed as a penance. It contains one of the very few temples, in all India, dedicated to Brahma. At the annual celebration (Oct.-Nov.) about 100,000 pilgrims come to bathe in the lake.

PUSHKIN, ALEXANDER (1799-1837), Russian poet, was born at Moscow, on the 7th of June 1799. He belonged to an ancient family of boyars; his maternal great-grandfather, a favourite negro ennobled by Peter the Great, bequeathed to him curly hair and a somewhat darker complexion than falls to the lot of the ordinary Russian. In 1811 the future poet entered the newly founded lyceum of Tsarskoe Selo, situated near St Petersburg. On quitting the lyceum in 1817 he was attached to the ministry of foreign affairs, and in this year he began the composition of his *Ruslan and Lyudmila*, a poem which was completed in 1820. Meanwhile Pushkin mixed in all the gayest society of the capital, and it seemed as if he would turn out a mere man of fashion instead of a poet. But a very daring *Ode to Liberty* written by him had been circulated in manuscript in St Petersburg. This production having been brought to the notice of the governor, the young author only escaped a journey to Siberia by accepting an official position at Kishinev in Bessarabia, in southern Russia. If we follow the chronological order of his poems, we can trace the enthusiasm with which he greeted the ever-changing prospects of the sea and the regions of the Danube and the Crimea.

At this time Pushkin was, or affected to be, overpowered by the Byronic "Weltschmerz." Having visited the baths of the Caucasus for the re-establishment of his health in 1822, he felt the inspiration of its magnificent scenery, and composed *The Prisoner of the Caucasus*, narrating the story of the love of a Circassian girl for a youthful Russian officer. This was followed by the *Fountain of Bakhchisarai*, which tells of the detention of a young Polish captive, a Countess Potocka, in the palace of the khans of the Crimea. About the same time he composed some interesting lines on Ovid, whose place of banishment, Tomi, was not far distant. To this period belongs also the *Ode to Napoleon*, which is inferior to the fine poems of Byron and Manzoni, or indeed of Lermontov, on the same subject. In the *Lay concerning the Wise Oleg* we see how the influence of Karamzin's *History* had led the Russians to take a greater interest in the early records of their country. The next long poem was the *Gipsies* (Tzuigani), an Oriental tale of love and vengeance, in which Pushkin has admirably delineated these nomads, whose strange mode of life fascinated him. During his stay in southern Russia he allowed himself to get mixed up with the secret societies then rife throughout the country. He also became embroiled with his chief, Count Vorontzov, who sent him to report upon the damages which had been committed by locusts

in the southern part of Bessarabia. Pushkin took this as a premeditated insult, and sent in his resignation; and Count Vorontzov in his official report requested the government to remove the poet, "as he was surrounded by a society of political and literary fanatics, whose praises might turn his head and make him believe that he was a great writer, whereas he was only a feeble imitator of Lord Byron, an original not much to be commended." The poet quitted Odessa in 1824, and on leaving wrote a fine *Ode to the Sea*. Before the close of the year he had returned to his father's seat at Mikhailovskoe, near Pskov, where he soon involved himself in trouble on all sides. In his retirement he devoted a great deal of time to the study of the old Russian popular poetry, the *bulinas*, of which he became a great admirer. Recollections of Byron and André Chenier gave the inspiration to some fine lines consecrated to the latter, in which Pushkin appeared more conservative than was his wont, and wrote in a spirit antagonistic to the French Revolution. In 1825 he published his tragedy *Boris Godunov*, a bold effort to imitate the style of Shakespeare. Up to this time the traditions of the Russian stage, such as it was, had been French.

In 1825 the conspiracy of the Dekabrists broke out. Many of the conspirators were personal friends of Pushkin, especially Küchelbecker and Pustchin. The poet himself was to a certain extent compromised, but he succeeded in getting to his house at Mikhailovskoe and burning all the papers which might have been prejudicial to him. Through influential friends he succeeded in making his peace with the emperor, to whom he was presented at Moscow soon after his coronation. The story goes that Nicholas said to Count Bludov on the same evening, "I have just been conversing with the most witty man in Russia." In 1828 appeared *Poltava*, a spirited narrative poem, in which the expedition of Charles XII. against Peter and the treachery of the hetman Mazepa were described. In 1829 Pushkin again visited the Caucasus, on this occasion accompanying the expedition of Prince Paskevich. He wrote a pleasing account of the tour; many of the short lyrical pieces suggested by the scenery and associations of his visit are delightful, especially the lines on the Don and the Caucasus. In 1831 Pushkin married Natalia Goncharov, and in the following year was again attached to the ministry of foreign affairs, with a salary of 5000 roubles. He now busied himself with an historical account of the revolt of the Cossack Pugachev, who almost overthrew the empire of Catherine and was executed at Moscow in the latter part of the 18th century. While engaged upon this he wrote *The Captain's Daughter*, one of the best of his prose works. In 1832 was completed the poem *Eugene Onyegin*, in which the author modelled his style upon the lighter sketches of Byron in the Italian manner. Yet no one can accuse Pushkin of want of nationalism in this poem: it is Russian in every fibre.

In 1837 the poet, who had been long growing in literary reputation, fell mortally wounded in a duel with Baron George Heckeren d'Anthès, the adopted son of the Dutch minister then resident at the court of St Petersburg. D'Anthès, a vain and frivolous young man, had married a sister of the poet's wife. Notwithstanding this he aroused Pushkin's jealousy by some attentions which he paid Natalia; but the grounds for the poet's anger, it must be confessed, do not appear very great. Pushkin died, after two days' suffering, on the afternoon of Friday the 10th of February. D'Anthès was tried by court-martial and expelled the country. In 1880 a statue of the poet was erected at the Tver Barrier at Moscow, and fêtes were held in his honour, on which occasion many interesting memorials of him were exhibited to his admiring countrymen and a few foreigners who had congregated for the festivities. Pushkin left four children; his widow was afterwards married to an officer in the army, named Lanskoï; she died in 1863.

Pushkin's poetical tales are spirited and full of dramatic power. The influence of Byron is undoubtedly seen in them, but they are not imitations, still less is anything in them plagiarized. *Boris Godunov* is a fine tragedy; on the whole *Eugene Onyegin* must be considered Pushkin's masterpiece. Here we have a great variety of styles—satire, pathos and humour mixed

together. The character-painting is good, and the descriptions of scenery introduced faithful to nature. The poem in many places reminds us of Byron, who himself in his mixture of the pathetic and the humorous was a disciple of the Italian school. Pushkin also wrote a great many lyrical pieces. Interspersed among the poet's minor works will be found many epigrams, but some of the best composed by him were not so fortunate as to pass the censorship, and must be read in a supplementary volume published at Berlin. As a prose writer Pushkin has considerable merits. Besides his *History of the Revolt of Pugachev*, which is perhaps too much of a compilation, he published a small volume of tales under the *nom de plume* of Ivan Byelkin. These all show considerable dramatic power: the best are *The Captain's Daughter*, a tale of the times of Catherine II.; *The Undertaker*, a very ghostly story, which will remind the English reader of some of the tales of Edgar Poe; *The Pistol Shot*; and *The Queen of Spades*.

The academy of St Petersburg has recently issued a complete edition of the works of Pushkin, including his letters. See the bibliography in the editions of Gennadi (7 vols., St Petersburg, 1861) and Annenkov (6 vols., St Petersburg, 1855). (W. R. M.)

PUSHTU, the language of the Pathan races of Afghanistan and the North-West Frontier province of India. It belongs to the Iranian group of the Indo-European languages, but possesses many Panjabi words. In Afghanistan it is the dominant language, but is not spoken west of the Helmund. In India it has two main dialects, the northern, hard or Pukhtu, and the southern, soft or Pushtu. The dividing line of the two dialects runs eastwards from Thal through the Kohat district almost to the Indus, but it then turns northwards, as the speech of the Akhora Khattaks belongs to the Pushtu or southern dialect. Thus Pukhtu is spoken in Bajour, Swat and Buner, and by the Yusufzais, Bangash, Orakzais, Afridis and Mohmands; while Pushtu is spoken by the Waziris, Khattaks, Marwats and various minor tribes in the south. The language division corresponds roughly with the tribal system of the Pathans, who are aristocratic in the north and democratic in the south. The classical dialect of Pukhtu is that of the Yusufzais, in which the earliest works in the language were composed. The Orakzai dialect differs from that of the Afridis, in that it is broader but less guttural and spoken more rapidly. The standard dialect is that of Peshawar. The literature is richest in poetry, Abdur Rahman, of the 17th century, being the best-known poet. Pushtu was spoken in the North-West Frontier province in 1901 by 1,142,011 persons, or 54% of the population.

See Grierson, *Linguistic Survey of India*; Roos-Keppel, *Manual of Pushtu* (1901); Lorimer, *Grammar of Waziri Pushtu* (1902).

PUTEAUX, a north-western suburb of Paris, on the left bank of the Seine, $4\frac{1}{2}$ m. from the centre of the city. Pop. (1906), 28,718. Puteaux has a church of the 16th century with good stained glass windows. There is a fort on the Seine.

PUTEOLI (mod. *Pozzuoli*, *q.v.*), an ancient town of Campania, Italy, on the northern shore of the Bay of Puteoli, a portion of the Bay of Naples, from which it is 6 m. W. The statement made by Stephanus of Byzantium and Jerome, that the city was founded under the name of Dicaearchia by a colony of Samians about 520 B.C., is probably correct, for, though in the territory of Cumae, it does not appear to have been occupied previous to 520, Misenum having been the original port of Cumae. On the other hand, Cumae probably extended her supremacy over it not long after. Its history in the Samnite period is unknown; but the coins of Fistelia (or Fistlus in Oscan) probably belong to Putcoli, as Mommsen thought. Nor do we know anything of its history between 334 (when it probably became a *civitas sine suffragio* under Roman domination, shortly afterwards receiving, in 318, a *praefectus iure dicundo*) and 215, when the Romans introduced a garrison of 6000 men to protect the town from Hannibal, who besieged it in vain for three days in 214. In 104 a Roman colony of 300 men was established. The *lex parieti faciundo*, an interesting inscription of 105 B.C. relating to some building works in front of the temple of Serapis, shows that Puteoli had

considerable administrative independence, including the right to date such a public document by the names of its own magistrates. Sulla retired to Puteoli after his resignation of the dictatorship in 79, and ten days before his death reconciled the disputes of the citizens by giving them a constitution. Cicero had a house in Puteoli itself, and a villa on the edge of the Lucrine lake (which, though nearer to Putcoli, was in the territory of Cumae), and many prominent men of the republic possessed country houses in the neighbourhood of Puteoli (see *BAIAE*; *AVERNUS LACUS*; *LUCRINUS LACUS*; *MISENUM*). In the Civil War it sided with Pompey, and later on with Brutus and Cassius. Nero admitted the old inhabitants to the privileges of the colony, thus uniting in one the two previously distinct communities. In 61 St Paul landed here, and spent seven days before leaving for Rome (Acts xxviii. 13). Vespasian, as a reward for its having taken his part, gave the town part of the territory of Capua, and installed more colonists there—whence it took the title *Colonia Flavia*, which it retained till the end of the empire.

The remains of Hadrian, who died at the neighbouring town of Baiac, were buried at Puteoli, and Antoninus Pius, besides erecting a temple to his memory on the site of Cicero's villa, instituted sacred games to be held in the city every five years. Commodus held the title of *duumvir quinquennalis*. It was mainly, however, as a great commercial port that Puteoli was famous in ancient times. It joined with Naples to erect one of the finest porticoes of Constantinople at the time of its construction. A letter of Symmachus gives us interesting details as to public corn distributions of the 4th century, throwing some light on the population. Like Ostia, Putcoli was considered a special port of Rome, and, on account of the safety and convenience of its harbour, it was preferred to Ostia for the landing of the more costly and delicate wares. As at Ostia, the various guilds were of considerable importance, but we find no *centonarii* or *fabri*, perhaps owing to its relations with the East, where these popular guilds were prohibited. Puteoli was preferred to Naples, (a) as being in Roman territory, (b) because the customs duty was only leviable once, not twice as it would have been at Naples—once by the local authorities, and once by the Roman authorities on entrance into Roman territory.¹ It exported iron from Elba, mosaics, pottery, manufactured locally with earth from Ischia (which was in considerable demand until 1883), sulphur (which indeed was extracted in the neighbourhood until the 18th century), probably alum (which is still worked), perfumes, pozzolana earth (taking its name from the place), cretaceous earth for mixing with grain (*alica*) from the Leucogacian hills, glass cups engraved with views of Puteoli, mineral dyes (the blue invented by one Vestorius is mentioned by Vitruvius and the purple of Puteoli by Pliny, as being of special excellence), &c., but not agricultural products, except certain brands of Campanian wine; but its imports were considerably greater. During the Punic Wars it was still a naval port, but in the latter part of the 2nd century B.C. it became the greatest commercial harbour of Italy and we find Lucilius about 125 B.C. placing it next in importance to Delos, then the greatest harbour of the ancient world. We note a little later the existence of merchants of Puteoli in the East. Under the empire we find Eastern cults taking root here sooner than in Rome. The construction of the harbour of Claudius at the mouth of the Tiber adversely affected Puteoli. Nero's scheme for the construction of a canal from Lake Avernus to Ostia would have restored the balance in its favour (though it certainly could not have been continuous all the way to Rome with the means of engineering then available).

The corn supply of Rome came partly through Putcoli, partly through Ostia. Seneca (*Epist.* 77) describes the joy of the inhabitants in the spring when the fleet of corn vessels from Alexandria was seen approaching, and Statius tells us that the crew of the ship which arrived first made libations to Minerva.¹ A mass of pottery débris found in 1875 gave important information as to the local manufacture. Some fragments came from Arretium, others, not quite so good, were of local work, but of the same style.

when passing the promontory which bore her name (the Punta Campanella at Sorrento). It is uncertain what official had the charge of the corn supply at Puteoli under the Republic, but in the time of Antoninus Pius we find an *Augusti dispensator a frumento Puteolis et Ostis* dependent no doubt on a *procurator annonae* of the two ports.

Claudius established here, as at Ostia, a cohort of *vigiles* as a fire-brigade. Brundisium was similarly protected. There was also a station of the imperial post, sailors of the imperial fleet at Misenum being apparently employed as couriers. The artificial mole was probably of earlier date than the reign of Augustus (possibly 2nd century B.C.); and by that time at any rate there were docks large enough to contain the vessels employed in bringing the obelisks from Egypt. Remains of the piles of the mole still exist, and are popularly known as Caligula's Bridge, from the mistaken idea that they belong to the temporary structure which that emperor flung across the bay from the mole at Puteoli to the shore at Baiæ. Inscriptions record repairs to the breakwater by Antoninus Pius in 139 in fulfilment of a promise made by Hadrian before his death. Alaric (410), Genseric (455) and Totila (545) successively laid Puteoli in ruins. The restoration effected by the Byzantines was partial and short-lived.

The original town of Puteoli was situated on the narrow hill of the Castello. Scanty traces of fortifications of the Roman period seem to have come to light in recent tunnelling operations. The streets of the old town probably, as at Naples, preserve the ancient alignment. There are also traces of the division of the lands in the immediate vicinity of the town into squares by parallel paths (*decumani* and *cardines*) at regular intervals of 111½ Roman feet, postulating as the basis of the division a square with a side of 10,000 Roman feet, divided into 81 smaller squares—an arrangement which could not have existed at Puteoli, and must have arisen elsewhere. It is remarkable as being contrary to Roman surveyors' practice, according to which the basis of division is the intersection at right angles of the *cardo* and *decumanus*, which would give an even (not an odd) number of smaller squares. The size of the ancient town at its largest can be roughly fixed by its tombs. Inscriptions show that it was divided into *regiones*. The market hall (*macellum*) (compare the similar buildings at Pompeii and elsewhere), generally known as the temple of Serapis, from a statue of that deity found there, was excavated in 1750. It consisted of a rectangular court surrounded by chambers on the outside and with a colonnade of thirty-six columns of cipollino (Carystian) marble and grey granite. The three columns still standing, some 39 ft. high, belong to a façade of four still higher columns erected in front of the absidal *cella* or sanctuary, with three niches for statues—no doubt of the protecting deities. The borings of marine shellfish visible in these columns between 11 and 19 ft. from the ground, and the various levels of pavement in the macellum help to indicate, according to Günther's researches (*Archæologia*, lvii. 499; *Earth Movements in the Bay of Naples*, 1903), that the level of the shore fell very slightly during the Roman period, when it was some 20 ft. higher than at present; that it fell more rapidly during the middle ages, was then raised again early in the 16th century (before the upheaval of the Monte Nuovo in 1538) and has since been sinking gradually. In the centre was a round colonnade with sixteen columns of Numidian marble (*giallo antico*) now in the theatre of the palace at Caserta. Dubois (*op. cit.*, 286 sqq.) reproduces important drawings and a description made by the architect Caristie in 1820. The well-preserved amphitheatre, the subterranean parts of which below the arena are intact, with a main passage down the centre, a curved passage all round with holes for trap doors in its roof, and numerous small chambers, also with trap doors in their vaulted roofs for admitting the wild beasts, whose cages were on the other side of the curved passage, to the arena, are especially interesting. There were also arrangements for flooding the arena, but these can only have been in use before the construction of the greater part of the subterranean portion with its cages, &c. The whole amphitheatre measures 489 by 381 ft., and the arena 245 by 138 ft. Of the upper portion the interior is well preserved, but very little of the external arcades remains. It was not constructed before the reign of Vespasian, for inscriptions record that it was built by the *Colonia Flavia*. There was, however, an amphitheatre in the reign of Nero, who himself fought in games given there, and the glass cup of Odemira shows two. A ruin still exists which may be doubtfully attributed to the latter (Dubois, p. 192). Remains of *thermae* also exist in various places, the mineral springs having been much used in Roman times. The cathedral of S. Proculus (containing the tomb of the musician Pergolesi, d. 1736) is built into a temple of Augustus, erected by L. Calpurnius, 6 columns of which, with their Corinthian capitals, still exist. Other ruins—of a circus, of tombs, &c., exist, and there are also considerable remains of villas in the neighbourhood.

Puteoli was supplied with water by two aqueducts, both subter-

anean, one of which, bringing water from springs in the immediate neighbourhood, is still in use, while the other is a branch of the Serino aqueduct, which was probably taken to Misenum by Agrippa. Several remains of reservoirs exist; one very large one is now called Piscina di Cardito.

Among the inscriptions one of the most interesting is the letter of the Tyrian merchants resident at Puteoli to the senate of Tyre, written in 174, asking the latter to undertake the payment of the rent of their factory, and the reply of the senate promising to do so. (This is the interpretation adopted by Dubois, pp. 86, 92, following Dittenberger.) We find other Eastern merchants resident here—merchants from Heliopolis, Berytus (Beirut), Nabataea, Palestine, and from Asia Minor, Greece, &c. We find far less trace of commercial relations with the West, though there was considerable importation of commodities from southern Spain—wine, oil, metals, salt fish, &c., while a good deal of pottery was exported to Spain and southern Gaul. We find, indeed, two cases of men who held municipal honours at Puteoli and in the Rhone valley. Puteoli was reached direct by a road from Capua traversing the hills to the north by a cutting (the *Montagna Spaccata*), which went on to Neapolis, and by the *Via Domitiana* from Rome and Cumæ. There was also a short cut from Puteoli to Neapolis by the tunnel of Pausilipon, made under Augustus. It is not possible to trace the episcopal see of Puteoli with any certainty further back than the beginning of the 4th century. In 305, S. Januarius (S. Gennaro, the patron saint of Naples), bishop of Beneventum, S. Proculus, patron of Puteoli, and others, suffered martyrdom at Puteoli.

See the careful study by C. Dubois, *Pouzzoles antique* (Paris, 1907) (*Bibliothèque des écoles françaises d'Athènes et de Rome*, fasc. 98). (T. As.)

PUTLITZ, GUSTAV HEINRICH GANS, EDLER ZU (1821–1890), German author, was born at Retzien near Perleberg in West Prignitz, on the 20th of March 1821. He studied law at Berlin and Heidelberg, and was attached to the provincial government at Magdeburg from 1846–1848. In 1853 he married Gräfin Elisabeth von Königsmark, and lived on his estate until 1863, when he became director of the Court theatre at Schwerin. This post he left in 1867, was for a short time chamberlain to the crown prince of Prussia, afterwards the emperor Frederick, and from 1873 to 1889 successfully directed the Court theatre at Karlsruhe. He died at Retzien on the 5th of September 1890. Putlitz made his debut as a writer with a volume of romantic stories, *Was sich der Wald erzählt* (1850), which attained great popularity (fifty editions) and found many imitators; but he was most successful in his comedies, notably *Badekuren* (1859); *Das Herz vergessen* (1853); and *Spielt nicht mit dem Feuer!* (1887), while of his narratives *Die Alpenbraut* (1870) and *Walpurgis* (1870) are distinguished by refined terseness of style and delicacy of portraiture.

A selection of his works, *Ausgewählte Werke*, was published in 6 vols. in Berlin (1872–1877), and a supplementary volume in 1888; his comedies, *Lustspiele*, appeared in two series of 4 vols. each (1851–1860 and 1860–1872). See E. zu Putlitz, *Gustav zu Pullitz. Ein Lebensbild aus Briefen* (3 vols., 1894–1895).

PUTNAM, ISRAEL (1718–1790), American soldier, was born in Salem Village (now Danvers), Massachusetts, on the 7th of January 1718. His first American ancestor (of the same family as George Puttenham), came from Aston Abbots, Bucks, and was one of the first settlers of Salem Village. In 1740 he removed to a farm in the present townships of Pomfret and Brooklyn, Connecticut. Here in the winter of 1742–1743 he went down into a wolf den (still shown in Pomfret) and at close quarters killed a huge wolf. Putnam took an active part in the French and Indian War, enlisting as a private in 1755 and rising to the rank of major in March 1758. He was conspicuous for personal courage and for skill in Indian warfare, and was the hero of numerous exploits. In 1764, during Pontiac's conspiracy, he commanded the Connecticut troops (five companies) in the expedition under Colonel John Bradstreet for the relief of Detroit. He was a prominent member of the Sons of Liberty and a leader in the opposition to the Stamp Act; was elected to the general assembly of Connecticut in 1766 and 1767; and increased his political influence by opening a tavern, "The General Wolfe," in Brooklyn, Conn. In August 1774, as chairman of the committee of correspondence for Brooklyn parish, he went with the committee's message and contributions to the Boston Patriots; and in October became lieutenant-colonel of the 11th regiment of Connecticut militia. News of the fighting at

Lexington and Concord reached him while he was ploughing on his farm; he instantly left the plough in the furrow and hastened to Cambridge; and he was later made second brigadier of the Connecticut forces. He was with the force, commanded by Colonel William Prescott, which on the night of the 16th of June fortified Breed's Hill, and on the next day he took a conspicuous part in resisting the British attack¹ (see BUNKER HILL). Soon afterward, on his own authority, he occupied Prospect Hill, an important point for the siege of Boston, in which he commanded the centre (two brigades) of the American army at Cambridge. After the evacuation of Boston he was in command of New York City till Washington's arrival (April 13, 1776), and then was put in general charge of the city's fortifications. Immediately before the battle of Long Island he succeeded General John Sullivan in command of the troops on Brooklyn Heights, and in the battle of Long Island (of Aug. 27) he was in immediate command of the American side. In the retreat from New York City he commanded one of the three grand divisions, and took part in the battle of Harlem Heights (September 16). His attempt to close the Hudson by sinking vessels in the channel was unsuccessful. In December he was ordered to Philadelphia to superintend the fortification of the city, was stationed at Princeton, New Jersey, from January to May 1777, and in May took command of the Hudson Highlands at Peekskill, which with Forts Montgomery and Clinton he abandoned in October, being out-maneuvred by the British, and having been weakened by Washington's repeated demands for reinforcements. In the spring of 1778 he was superseded by General Alexander McDougall, but in April a court of inquiry acquitted him of "any fault, misconduct or negligence" in connexion with the loss of Forts Montgomery and Clinton. After a few months' recruiting service in Connecticut he returned to the main army at White Plains. In the winter of 1778-1779 he commanded the troops quartered near Redding, Conn., where Putnam Memorial Park now is.² In May he took command of the right wing on the west side of the Hudson. An attack of paralysis in December 1779 terminated his active service in the war. He spent his last years on his farm in Brooklyn, Conn., where he died on the 29th of May 1790. A bronze equestrian statue by Karl Gerhardt, over a sarcophagus, was erected at Brooklyn, Conn., by the state in 1888, and there is another statue (1874) in Bushnell Park, Hartford, by J. Q. A. Ward.

Putnam was a brave, intrepid and very industrious soldier rather than a great general, but his fame in the Indian wars, his personal courage, his bluff heartiness and his good-fellowship made him an idol of the rank and file; and he is one of the popular heroes in American history. He seems to have taken no part in the political manœuvres and cabals which busied many of the officers of the American army.

See W. F. Livingston, *Israel Putnam, Pioneer, Ranger and Major-General* (New York, 1901) in the "American Men of Energy" series; I. N. Tarbox, *Life of Israel Putnam* (Boston, 1876); and *Essay on the Life of the Honorable Major-General Israel Putnam* (Hartford, 1788; enlarged ed., Boston, 1818), by David Humphreys, for a time Putnam's aide-de-camp.

PUTNAM, RUFUS (1738-1824), American soldier and pioneer, was born in Sutton, Massachusetts, on the 9th of April 1738 (O.S.). His grandfather was a half brother to Israel Putnam's father. He served in the French and Indian War in 1757-60; was a millwright in New Braintree in 1761-1768, during which time he studied surveying; and from 1769 until the War of Independence was a farmer and surveyor. In 1773, with Israel

¹ So loose was the army's organization that it is impossible to settle the question whether Putnam or Prescott was in command at Bunker Hill. Apparently their authority did not clash and was practically independent. See Justin Winsor in his *Narrative and Critical History*, vi. 190-191 (reprinted in Livingston's *Israel Putnam*, as app. ii.).

² On the 26th of February 1779, with a small outpost, he was surprised near Greenwich by a superior force under General William Tryon. He ordered a retreat, started to Stamford for reinforcements and, being closely pursued by several dragoons, is said to have ridden down a steep hill (marked in 1900 with a granite monument), and thus escaped. From Stamford he hastened back with reinforcements and took thirty-eight prisoners from Tryon.

Putnam and two others, he visited West Florida to examine lands which, it was expected, were to be granted to the provincial troops for their services against the French and Indians, and which he charted (see MISSISSIPPI). He became lieutenant-colonel in one of the first regiments raised after the battle of Lexington, and served before Boston; in March 1776 he was made chief engineer of the works at New York; in August he was appointed engineer with the rank of colonel; and when Congress did not act on his plan (submitted in Oct. 1776) for the establishment of a distinct engineer corps he resigned (Dec. 1776), and in 1777 served in the northern army under Major-General Horatio Gates, commanding two regiments in the second battle of Saratoga. In 1778 he laid out fortifications, including Fort Putnam, at West Point, and in 1779 he served under Major-General Anthony Wayne after the capture of Stony Point. For the remainder of the war he saw little active service. In January 1783 he was commissioned brigadier-general. After the war he returned to Rutland, Mass., where he had bought a confiscated farm in 1780. In March 1786 he founded, with other officers of the War of Independence, the Ohio Company of Associates for the purchase and settlement of Western lands. In November 1787, after Congress had made its grant to the Ohio Company, he was appointed by the company superintendent of its proposed settlement on the Ohio, and in 1788 he led the small party which founded Marietta, Ohio. He was a judge of the court of the North-West Territory in 1790-1796; was a brigadier-general in the army and a commissioner to treat with the Indians in 1792-1793; was surveyor-general of the United States in 1796-1803; and in 1802 was a member of the Ohio state constitutional convention. He died, in Marietta, on the 4th of May 1824. He has been called "The Father of Ohio," and he contributed greatly toward the material building up of the North-West Territory.

See John W. Campbell, *Biographical Sketches* (Columbus, Ohio, 1838); Sidney Crawford, "Rufus Putnam, and his Pioneer Life in the North-West," vol. xii., new series, pp. 431-454, *Proceedings of the American Antiquarian Society* (Worcester, 1899), and Rowena Buell (ed.), *The Memoirs of Rufus Putnam* (Boston, 1903), in which his autobiography, his journal and other papers, now in the library of Marietta College, are reprinted. His *Journal, 1757-1760*, dealing with his experiences in the French and Indian War, was edited with notes by E. C. Dawes (Albany, New York, 1886).

PUTNAM, a city and the county-seat of Windham county, Connecticut, U.S.A., in the township of Putnam, on the Quinebaug river, at the mouth of the Mill river, in the N.E. part of the state, about 6 m. from the Rhode Island boundary and about 7½ m. from that of Massachusetts. Pop. (1900), of the township (including the city), 7348; of the city, 6667 (2012 being foreign born); (1910) 6637. Putnam is at the intersection of two branches of the New York, New Haven & Hartford railway, and is connected by electric line with Worcester, Norwich and Providence. The city is the seat of two Roman Catholic institutions, St Mary's Convent and Notre Dame Academy, and has a public library and an endowed hospital. The Quinebaug and Mill rivers provide excellent water-power. The township (named in honour of General Israel Putnam) was incorporated in 1855, and the city was chartered in 1895.

PUTTEE, or **PUTTIE**, the name, adapted from the Hindi *patti*, bandage (Skr. *patta*, strip of cloth), for a covering for the lower part of the leg from the ankle to the knee, consisting of a long narrow piece of cloth wound tightly and spirally round the leg, and serving both as a support and protection, worn especially by riders, and taking the place of the leather or cloth gaiter. It has been adopted as part of the uniform of the mounted soldier in the British army.

PUTTENHAM, GEORGE (d. 1590), the reputed author of *The Arte of English Poesie* (1589). The book was entered at Stationers' Hall in 1588, and published in the following year with a dedicatory letter to Lord Burghley written by the printer Richard Field, who professed ignorance of the writer's name and position. There is no contemporary evidence for the authorship, and the name of Puttenham is first definitely associated with it in the *Hypercritica* of Edmund Bolton, published in 1722, but

written in the beginning of the 17th century, perhaps as early as 1605. The writer of the *Art of English Poesie* supplies certain biographical details. He was educated at Oxford, and at the age of eighteen he addressed an eclogue entitled *Elpine* to Edward VI. In his youth he had visited Spain, France and Italy, and was better acquainted with foreign courts than with his own. In 1579 he presented to Queen Elizabeth his *Partheniades* (printed in a collection of *MSS. Ballads* by F. J. Furnivall), and he wrote the treatise in question especially for the delectation of the queen and her ladies. He mentions nine other works of his, none of which are extant. There is no direct evidence beyond Bolton's ascription to identify the author with George or Richard Puttenham, the sons of Robert Puttenham and his wife Margaret, the sister of Sir Thomas Elyot, who dedicated his treatise on the *Education or Bringing up of Children* to her for the benefit of her sons. Both made unhappy marriages, were constantly engaged in litigation, and were frequently in disgrace. Richard was in prison when the book was licensed to be printed, and when he made his will in 1597 he was in the Queen's Bench Prison. He was buried, according to John Payne Collier, at St Clement Danes, London, on the 2nd of July 1601. George Puttenham is said to have been implicated in a plot against Lord Burghley in 1570, and in December 1578 was imprisoned. In 1585 he received reparation from the privy council for alleged wrongs suffered at the hands of his relations. His will is dated the 1st of September 1590. Richard Puttenham is known to have spent much of his time abroad, whereas there is no evidence that George ever left England. This agrees better with the writer's account of himself; but if the statement that he addressed *Elpine* to Edward VI. when he was eighteen years of age be taken to imply that the production of this work fell within that king's reign, the date of the author's birth cannot be placed anterior to 1529. At the date (1546) of his inheritance of his grandfather, Sir Thomas Elyot's estates, Richard Puttenham was proved in an inquisition held at Newmarket to have been twenty-six years old.

Whoever the author may have been, there is no doubt about the importance of the work, which is the most systematic and comprehensive treatise of the time on its subject. It is "contrived into three bookes: the first of poets and poesies, the second of proportion, the third of ornament." The first section contains a general history of the art of poetry, and a discussion of the various forms of poetry; the second treats of prosody, dealing in turn with the measures in use in English verse, the caesura, punctuation, rhyme, accent, cadence, "proportion in figure," which the author illustrates by geometrical diagrams, and the proposed innovations of English quantitative verse; the section on ornament deals with style, the distinctions between written and spoken language, the figures of speech; and the author closes with lengthy observations on good manners. It is interesting to note that in his remarks on language he deprecates the use of archaisms, and although he allows that the purer Saxon speech is spoken beyond the Trent, he advises the English writer to take as his model the usual speech of the court, of London and the home counties.

Many later "poetics" are indebted to this book. The original edition is very rare. Professor Edward Arber's reprint (1869) contains a clear summary of the various documents with regard to the authorship of this treatise. The history of the Puttenham is discussed in H. H. S. Croft's edition of Elyot's *Boke called the Governour*. A careful investigation brought him to the conclusion that the evidence was in favour of Richard. There are other modern editions of the book, notably one in J. Haslewood's *Ancient Critical Essays* (1811-1815).

PUTTING THE SHOT (or WEIGHT), a form of athletic sports (*q.v.*). It is the only weight event now remaining in the championship programme which requires a "put" as distinct from a throw, a put being a fair and square push straight from the shoulder, quite distinct from throwing or bowling, which are not allowed in putting the shot. The exercise originated in Great Britain, where, before the formation of the Amateur Athletic Association, the shot (a round weight of 16 lb) was put from a joist about 6 ft. long with a run of 7 ft., the distance being measured

from the impression made by the falling missile to the point on the joist, or a line continuing it, opposite the impression. Hence the putter failed to get the full benefit of any put save a perfectly straight one. The present British rule is that the put shall be made from a 7-ft. square, and the distance taken from the first pitch of the shot to the front line of the square or that line produced, as by the old method. In America the put is made from a 7-ft. circle, and the distance measured from the pitch to the nearest point of the circle, which has a raised edge in front to prevent overstepping and consequent fouls. Individual putters have slight variations of method, but the following description is substantially good for all. The putter stands in the back part of the square or circle with his weight entirely upon his right leg, which is bent. The body is inclined slightly backward, the left arm stretched out in front as a balance, and the right hand, the shot resting in the palm, is held against, or an inch or two from, the neck below and behind the right ear. From this position a hop forward is made with the right leg, the foot landing in the middle of the square and the balance being preserved, so that the right shoulder is kept well back. Then, letting the right leg bend well down, the athlete springs up with a rapid twist of the body, so that the right shoulder is brought forward, and the right arm is thrust forward with all possible force, the secret being to throw all the weight and power of the body and arm into the put at the very moment of delivery. Mere brute strength and weight have less to do with successful shot-putting than in hammer-throwing or throwing the 56-lb weight, and on this account some comparatively light men have repeatedly beaten larger and taller putters. Thus G. R. Gray, a Canadian by birth, who for many years held the world's record of 47 ft. for the 16-lb shot, was a smaller and less powerful man than several whom he defeated; and another champion of light weight was W. F. Robertson of Scotland, who weighed only 150 lb. Among the best putters of earlier times were E. J. Bor, London Athletic Club, who made a put of 42 ft. 5 in. in 1872; W. Y. Winthrop and G. Ross. The talent of Irish athletes both in Great Britain and America for weight putting and throwing is remarkable, among the most famous of Irish putters being W. J. M. Barry and Denis Hogan, the latter of whom won the amateur championship in seven consecutive years from 1893, and again in 1904 and 1905. The record in 1910 for the 16-lb shot was 51 ft., made at San Francisco in 1909 by R. Rose.

PUTTKAMMER, ROBERT VON (1828-1900), Prussian statesman, was born at Frankfort-on-the-Oder on the 5th of May 1828. His father, Eugen von Puttkammer, *Oberpräsident* of Posen, belonged to a widely extended noble family, of which Bismarck's wife and Robert von Puttkammer's own wife were also members. Robert von Puttkammer, after a short course of law, began his official career in 1850 as *Auskultator* in the courts at Danzig; but in 1852 entered the civil service, receiving after his promotion to the rank of *Assessor* in 1854 a post in the railway department of the ministry for trade and industry. In 1859 he became a member of the presidial council (*Oberpräsidialrat*) at Coblenz, capital of the Prussian Rhine province, and from 1860 to 1866 was *Landrat* at Demmin in Pomerania. During the war with Austria he acted as civil commissary in Moravia. From 1867 to 1871 he was a councillor in the chancery of the North German Confederation. In 1871 he was appointed president of the governmental district of Gumbinnen in East Prussia, in 1875 district president (*Bezirkspräsident*) in Lorraine, and in 1877 *Oberpräsident* in Silesia. From 1874 onward he was frequently elected to the *Reichstag* and the Prussian Chamber of Deputies, in which he attached himself to the German Conservative party. Puttkammer was the chosen instrument of the Clerical Conservative policy initiated by Bismarck when the Socialist peril made it expedient to conciliate the Catholic Centre. As *Oberpräsident* of Silesia he had already done much to mitigate the rigour of the application of the "May Laws," and as minister of public worship and of the interior he continued this policy. He is also remembered as the author of the ordinance of the 21st of January 1880 on the simplification of German orthography. This was at first vigorously opposed, not least by Bismarck himself; but its

convenience soon became evident, it was increasingly put into practice, and was so well based that later reformers have only needed to follow the lines laid down by Puttkammer. As minister of the interior Puttkammer's activities were less commendable. His reactionary conservative temper was in complete harmony with the views of Bismarck and the emperor William, and with their powerful support he attempted, in defiance of modern democratic principles and even of the spirit of the constitution, to re-establish the old Prussian system of rigid discipline from above. He was above all concerned to nip in the bud any tendencies in the bureaucracy to revolt, and it was on his initiative that, on the 4th of January 1882, a royal ordinance laid it down as the duty of all officials to give the government their unconditional support at political elections. Similarly though he carried out many useful administrative reforms, in a vain effort to combat Social Democracy he seriously interfered with the liberty of public meeting and attempted the forcible suppression of strike movements. This "Puttkammer régime" was intensely unpopular; it was attacked in the *Reichstag* not only by Radicals like Richter and Rickert, but by National Liberals like Bennigsen, and when the emperor Frederick III., whose Liberal tendencies were notorious, succeeded to the throne, it was clear that it could not last. In spite of Bismarck's support Puttkammer was forced to resign on the 8th of June 1888. Under William II., however, whose principles were those of his grandfather, Puttkammer was largely rehabilitated. On the 1st of January 1889 he received the Order of the Black Eagle. He was appointed a secular canon (*Domherr*) of Merseburg, and in 1891 became *Oberpräsident* of Prussian Pomerania. In this office, which he held till 1899, he did very useful work in collaboration with the provincial estates. He died on his property at Karzin in Pomerania on the 15th of March 1900. (J. H.N.)

PUTTY, originally tin oxide in a state of fine division used for polishing glass, granite, &c., now known as "putty powder" or "polisher's putty" (from O. Fr. *potée*, a potful, hence brass, tin, pewter, &c., calcined in a pot). More commonly the term is applied to a kind of cement composed of fine powdered chalk intimately mixed with linseed oil, either boiled or raw, to the consistency of a tough dough. It is principally used by glaziers for bedding and fixing sheets of glass in windows and other frames, and by joiners and painters for filling up nail-holes and other inequalities in the surface of woodwork. The oxidation of the oil gradually hardens the putty into a very dense adherent mass, but when it is required to dry quickly, boiled oil and sometimes litharge and other driers are used. The word is also used of a fine lime cement employed by masons.

PUVIS DE CHAVANNES, PIERRE CÉCILE (1824-1898), French painter, was born at Lyons on the 14th of December 1824. His father was a mining engineer, the descendant of an old family of Burgundy. Pierre Puvis was educated at the Lyons College and at the Lycée Henri IV. in Paris, and was intended to follow his father's profession when a serious illness interrupted his studies. A journey to Italy opened his mind to fresh ideas, and on his return to France he announced his intention of becoming a painter, and went to study first under Henri Scheffer, and then under Couture. On leaving this master in 1852 he established himself in a studio in the Place Pigalle (which he did not give up till 1897), and there organized a sort of academy for a group of fellow students who wished to work from the living model. Puvis first exhibited in the Salon of 1850 a "Pietà," and in the same year he painted "Mademoiselle de Sombreuil Drinking a Glass of Blood to Save her Father," and "Jean Cavalier by his Mother's Deathbed," besides an "Ecce Homo," now in the church of Champagnat (Saône-et-Loire). In 1852 and in the two following years Puvis's pictures were rejected by the Salon, and were sent to a private exhibition in the Galeries Bonne Nouvelle. The public laughed at his work as loudly as at that of Courbet, but the young painter was none the less warmly defended by Théophile Gautier and Théodore de Banville. For nine years Puvis was excluded from the Salons. In 1857 he had painted a "Martyrdom of St Sebastian," "Meditation," "Village Firemen," "Julie," "Herodias," and "Saint Camilla"—

compositions showing a great variety of impulse, still undecided in style and reflecting the influence of the Italian masters as well as of Delacroix and Couture. In 1859 Puvis reappeared in the Salon with the "Return from Hunting" (now in the Marseilles Gallery). But not till he produced "Peace" and "War" did he really impress his critics, inaugurating a vast series of decorative paintings. For these two works a second-class medal was awarded to him, and the state offered to purchase the "Peace." Puvis, not choosing to part the pair, made a gift of "War" to the state. He then set to work again, and in 1864 exhibited "Autumn" and "Sleep," but found no purchasers. One of these pictures is now in the Lyons Museum, and the other at Lille. "Peace" and "War" were placed in the great gallery of the museum at Amiens, where Puvis completed their effect by painting four panels—a "Standard-Bearer," "Woman Weeping over the Ruins of her Home," a "Reaper," and a "Woman Spinning." These works were so much admired that further decorations were ordered for the same building, and the artist presented to the city of Amiens "Labour" and "Repose," for which the municipality could not afford to pay. At their request Puvis undertook another work, intended for the upper landing of the staircase, and in 1865 a composition entitled "Ave Picardia Nutrix," allegorical of the fertility of the province, was added to the collection. In 1879 the city wished to complete the decoration of the building, and the painter, again at his own expense, executed the cartoon of "Ludus pro patria," exhibited in the Salon of 1881 and purchased by the state, which at the same time gave him a commission for the finished work. While toiling at these large works, Puvis de Chavannes rested himself by painting easel pictures. To the salon of 1870 he had sent a picture called "Harvest;" the "Beheading of John the Baptist" figured in the Great Exhibition of 1889; then followed "Hope" (1872), the "Family of Fisher-Folk" (1875), and "Women on the Seashore" (1879). But these canvases, however interesting, are not to be named by the side of his grand decorative works. Two paintings in the Palais Longchamp at Marseilles, ordered in 1867, represent "Marseilles as a Greek Colony" and "Marseilles, the Emporium of the East." After these, Puvis executed for the town-hall of Poitiers two decorative paintings of historical subjects: "Radegund," and "Charles Martel." The Panthéon in Paris also possesses a decorative work of great interest by this painter: "The Life of Saint Geneviève," treated in three panels. In 1876 the Department of Fine Arts in Paris gave the artist a commission to paint "Saint Geneviève giving Food to Paris" and "Saint Geneviève watching over Sleeping Paris," in which he gave to the saint the features of Princess Cantacuzene, his wife, who died not long before he did. At the time of his death—on the 24th of October 1898—the work was almost finished. After completing the first paintings in the Panthéon, which occupied him for three years and eight months, Puvis de Chavannes undertook to paint the staircase leading to the gallery of fine arts in the Lyons Museum, and took for his subjects the "Vision of the Antique," a procession of youths on horseback, which a female figure standing on a knoll points out to Pheidias; the "Sacred Grove"; and two allegorical figures of "The Rhône" and "The Saône." It was in the same mood of inspiration by the antique that he painted the hemicycle at the Sorbonne, an allegory of "Science, Art, and Letters," a work of great extent, for which he was paid 35,000 francs (£1400). At the Hôtel de Ville in Paris, again, Puvis decorated the grand staircase and the first reception-room. These works employed him from 1880 till 1893. In the reception-room he painted two panels, "Winter" and "Summer"; the mural paintings on the staircase, which had previously been placed in the hands of Baudry and of Delaunay, are devoted to the glory of the attributes of the city of Paris. On the ceiling we see Victor Hugo offering his lyre to the city of Paris. The pictures in the Rouen Museum (1890-1892) show a different vein, and the artist's power of conceiving and setting forth a plastic scheme enabling him to decorate a public building with beautiful human figures and the finest lines of landscape. We see here toilers raising a

colossal monolith, part of some ancient monument, to add it to other architectural pieces; then the busy scene of a pottery; and finally artists painting in the open air. Puvis, as a rule, adhered to the presentment of the nude or of the lightest drapery; here, however, in response to some critical remarks, he has clad his figures exclusively in modern dress. After prolonged negotiations, begun so early as in 1891, with the trustees of the Boston Library, U.S.A., Puvis de Chavannes accepted a commission to paint nine large panels for that building, to be inserted in separate compartments, three facing the door, three to the right and three to the left. These pictures, begun in 1895, were finished in 1898. In these works of his latest period Puvis de Chavannes soars boldly above realistic vision. In the figures which people the walls with poetic images he endeavours to achieve originality of the embodying forms, and at the same time a plastic expression of ideas born of a mind whose conceptions grew ever loftier, while yet the artist would not abandon the severe study of nature. Such works as the great paintings at Amiens, Rouen, Marseilles, the Panthéon, the Sorbonne, and the Hôtel de Ville are among the most important productions of French art in the 19th century. Puvis de Chavannes was president of the National Society of Fine Arts (the New Salon). His principal pupils and followers are Ary Renan (d. 1900), Baudouin, J. F. Auburtin and Cottet.

See A. Michel, "Exposition de M. Puvis de Chavannes," *Gazette des beaux-arts* (1888); Marius Vachon, *Puvis de Chavannes* (1900); J. Buisson, "Puvis de Chavannes, Souvenirs Intimes," *Gazette des beaux-arts* (1899). (H. FR.)

PUY, a geological term used locally in Auvergne for a volcanic hill. Most of the puy of central France are small cinder-cones, with or without associated lava, whilst others are domes of trachytic rock, like the domite of the Puy-de-Dôme. The puy may be scattered as isolated hills, or, as is more usual, clustered together, sometimes in lines. The chain of puy in central France probably became extinct in late prehistoric time. Other volcanic hills more or less like those of Auvergne are also known to geologists as puy; examples may be found in the Eifel and in the small cones on the Bay of Naples, whilst the relics of denuded puy are numerous in the Swabian Alps of Württemberg, as pointed out by W. Branco. Sir A. Geikie has shown that the puy type of eruption was common in the British area in Carboniferous and Permian times, as abundantly attested in central Scotland by remains of the old volcanoes, now generally reduced by denudation to the mere neck, or volcanic vent, filled with tuff and agglomerate, or plugged with lava.

See Sir A. Geikie, *Ancient Volcanoes of Great Britain* (1897).

PUY-DE-DÔME, a department of central France, four-fifths of which belonged to Basse-Auvergne, one sixth to Bourbonnais, and the remainder to Forez (Lyonnais). Area, 3,094 sq. m. Pop. (1906), 535,419. It is bounded N. by Allier, E. by Loire, S. by Haute-Loire and Cantal, and W. by Corrèze and Creuse. The highest point of the department, the Puy de Sancy (6188 ft.), is also the most elevated peak of central France; it commands the group of the volcanic Monts Dore, so remarkable for their rocky corries, their erosion valleys, their trap dykes and *orgues* of basalt, their lakes sleeping in the depths of ancient craters or confined in the valleys by streams of lava, and their wide plains of pasture-land. The Puy de Sancy, forming part of the watershed, gives rise on its northern slope to the Dordogne, and on the east to the Couze, a sub-tributary of the Loire, through the Allier. The Monts Dore are joined to the mountains of Cantal by the non-volcanic group of the Cézallier, of which the highest peak, the Luguet (5102 ft.), rises on the confines of Puy-de-Dôme and Cantal. On the north the Monts Dore are continued by a plateau of a mean height of from 3000 to 3500 ft., upon which are seen sixty cones raised by volcanic outbursts in former times. These are the Monts Dôme, which extend from south to north as far as Riom, the most remarkable being the Puy-de-Dôme (4800 ft.), from which the department takes its name, and the Puy-de-Parou, the latter having a crater more than 300 ft. in depth. A meteorological observatory occupies the summit of the Puy-de-Dôme, which was once crowned by a Roman temple, the ruins of which still exist. To the east of the depart-

ment, along the confines of Loire, are the Monts du Forez, rising to 5380 ft. and continued north by the Bois Noirs. Between these mountains and the Dôme extends the fertile plain of Limagne. The drainage of Puy-de-Dôme is divided between the Loire, by its affluents the Allier and the Cher, and the Gironde, by the Dordogne. The Allier traverses the department from south to north, receiving on its right the Dore, which falls into the Allier at the northern boundary and lowest level of the department (879 ft.); on its left are the Alagnon from the Cantal, the two Couzes from the Luguet and the Monts Dore, and the Sioule, the most important of all, which drains the north-west slopes of the Monts Dore and Dôme, and joins the Allier beyond the limits of the department. The Cher forms for a short space the boundary between the departments of Puy-de-Dôme and Creuse, close to that of Allier. The Dordogne, while still scarcely formed, flows past Mont-Dore-les-Bains and La Bourboule and is lost in a deep valley which divides this department from that of Corrèze. None of these streams is navigable, but boats can be used on the Allier during floods. The climate of Puy-de-Dôme is usually very severe, owing to its high level and its distance from the sea; the mildest air is found in the northern valleys, where the elevation is least. During summer the hills about Clermont-Ferrand, exposed to the sun, become all the hotter because their black volcanic soil absorbs its rays. On the average 25 or 26 in. of rain fall in the year; in the Limagne around which the mountains arrest the clouds rainfall is less. Nevertheless the soil of this plain, consisting of alluvial deposits of volcanic origin, and watered by torrents and streams from the mountains, makes it one of the richest regions of France. In the highest altitudes the rainfall attains 64 in.

About two-thirds of the inhabitants of Puy-de-Dôme are engaged in agriculture. The Limagne yields a variety of products and the vine flourishes on its hill-sides. The high mountains provide pasture for large flocks of cows and sheep, and cheese-making is an industry of much importance. The intermediate region is cultivated chiefly for cereals, the chief of which are rye, wheat, oats and barley. Potatoes are largely grown, and, to a less extent, peas, beans, beetroot and colza. The Limagne produces fruits of all kinds—apricots, cherries, pears, walnuts and apples, from which considerable quantities of cider are made. The department possesses considerable mineral wealth. There are important coal-mines at Brassac on the Allier, on the borders of Haute-Loire, at St Éloy near the department of Allier, and at Bourg-Lastic on the borders of Corrèze. Peat, asphalt, bituminous schists, antimony, mispickel and argentiferous lead are also worked. Of the last named there are mines and foundries at Pontgibaud on the Sioule. Amethysts and other rare minerals are found and there are numerous stone-quarries. The watering-places of Mont Dore, Royat and La Bourboule receive separate notice. The springs of St Nectaire, containing sodium and iron chlorides and bicarbonates, are efficacious in liver complaints, rheumatism and gravel. The waters of Châteauneuf (on the Sioule), also known to the Romans, contain iron bicarbonates and are resorted to for skin diseases. Those of Châtelguyon, like the waters of Carlsbad and Marienbad, are used for disorders of the digestive organs, congestions of the liver, rheumatism, &c. There are many other mineral springs of varied character. Manufactures are for the most part grouped around Thiers, which produces a large amount of cheap cutlery, paper and leather, and Clermont-Ferrand, the capital. The department contains factories for lace and braid (in the mountains), for buntings and camlets and wool, cotton and hemp mills. There are wool-carding works and factories for linens, cloths and counterpanes, also silk-mills, tanneries, manufactories for chamois and other leathers, for caoutchouc (Clermont-Ferrand), sugar-works, manufactories of edible pastes with a reputation as high as those of Italy, and manufactories of fruit-preserved. The department exports grain, fruits, cattle, wines, cheese, wood, mineral waters, cutlery, &c. It is served by the Orléans and Paris-Lyon railway companies. Many thousands of the inhabitants, belonging chiefly to the district of Ambert, leave it during winter and find work elsewhere as navvies, chimney-sweepers, pit-sawyers, &c. The department comprises 5 arrondissements—Clermont-Ferrand, Ambert, Issoire, Riom, Thiers—5 cantons and 471 communes. It is included in the bishopric and *académie* (educational division) of Clermont-Ferrand and the region of the XIII. army corps, of which the headquarters are in the same town; the appeal court is at Riom.

The more noteworthy places in the department are Clermont-Ferrand, Issoire, Thiers, Riom, Ambert, Mont-Dore-les-Bains, La Bourboule and Royat (all separately noticed). Near Clermont-Ferrand is Mont Gergovie (see GERGOVIA) the scene of the victory of Vercingetorix over Julius Caesar. Other places of

interest are Billom, Chamalières, Courpière, Orcival, St Nectaire and St Saturnin, which possess churches in the Romanesque style of Auvergne. There are ruined feudal strongholds of great interest at Murols and Tournôl (near Volvic). Vic-le-Comte has a sainte-chapelle which is a beautiful example of the transition from Gothic to Renaissance architecture, and Aigueperse has a Gothic church of the 13th to the 15th century. Near Pontgibaud are the ruins (13th century) of the Carthusian abbey of Port St Marie.

PUYLAURENS, ANTOINE DE LAAGE, Duc DE (d. 1635), French courtier, was born of an old Languedoc family. Attached to the household of Gaston, duke of Orleans, brother of Louis XIII., he gained a complete ascendancy over the weak prince by pandering to his pleasures, and became his adviser in the intrigues against Cardinal Richelieu. It was Puylaurens who arranged the escape of Gaston to Brussels in 1632 after the capture of Henri, duc de Montmorency, and then negotiated his return with Richelieu, on condition that he should be reconciled to the king. As a reward Richelieu gave him Aiguillon, erected into a duchy. But he plunged into new intrigues, and was imprisoned first in the Louvre in 1635, then in Vincennes, where he died the same year.

PUZZLE, a perplexing question, particularly a mechanical toy or other device involving some constructional problem, to be solved by the exercise of patience or ingenuity. Some of the oldest mechanical puzzles are those of the Chinese, one of the most familiar being that known as the *langram* (*chi ch'iao t'ue*), which consists of a square of wood or other material cut into five triangles, of different sizes, a small square and a lozenge, which can be so placed as to form over 300 different figures. This puzzle is sometimes made of ivory carved with the delicate workmanship for which the Chinese craftsmen are renowned, and is enclosed in a carved box. Another well-known puzzle is known as the "Chinese rings," consisting of a series of rings running linked together on a bar, the problem being to take them off the bar and replace them. The commonest of all puzzles are coloured maps, pictures ("jig-saw") or designs, dissected into numerous variously shaped pieces, to be fitted together to form the complete design. A great number of puzzles are based on mathematical principles, such as the "fifteen puzzle," the "railway shunting puzzle," and the like.

See W. W. Rouse Ball, *Mathematical Recreations and Amusements* (1892).

The etymology of the word "puzzle" is disputed. It has been usual to consider that the verb, which appears first at the end of the 16th century, is derived from the substantive, and that this is an aphetic form of "apposal" or "opposal" *i.e.* opposition, hence a question for solution, cf. Lydgate, *Fall of Princes*, quoted by Skeat (*Etym. Dict.* 1898). The *New English Dictionary*, however, takes it as clear from the chronological evidence and sense-development that the substantive is derived from the verb, which, in its earliest examples, means to put in embarrassing material circumstances, to bewilder, to perplex. This seems against making "to puzzle" a derivative of "to pose," *i.e.* "oppose," to examine by putting questions. Some connexion may be found with a much earlier word "poselet," confused, bewildered, which does not occur later than the end of the 14th century.

PWLLHELI ("salt pit," or "pool"), a municipal and contributory parliamentary borough (Carnarvon district), seaport and market-town of Carnarvonshire, North Wales, 20 m. S. of Carnarvon and 270 m. from London by rail. Pop. (1901), 3675. It is on the north side of Cardigan Bay, on the shore of Tremadoc Bay, with a sandy beach 4 m. in length and good bathing. It is the terminus of the Cambrian railway (the London & North-Western railway being 4 m. distant at Afonwen junction). Pwllheli commands a good view of Merionethshire and of the Snowdon range, with the entire sweep of Cardigan Bay, Carreg yr ymbill (gimlet stone) at the mouth of the harbour, Abersoch and St Tudwal's Islands. Many hundred acres of land have been reclaimed from the sea here and along the coast of the bay; there are costly embankments and good harbourage. The coast

is locally noted for fisheries (especially of lobsters and oysters) and some ship-building is carried on. Pwllheli was incorporated by Edward the Black Prince. At Nevin (*Nefyn*), 6 m. distant, Edward I. held a tournament or revel, in 1284, on a magnificent scale, to commemorate his conquest of Wales.

PYANEPSIA, or PYANOPSIA (from Gr. *πύανος* = *κύανος*, bean, and *ἔβω*, to boil), an ancient festival in honour of Apollo, held at Athens on the 7th of the month Pyanepsion (October). A hodge-podge of pulse was prepared and offered to Apollo (in his capacity as sun god and ripener of fruits) and the Horae, as the first-fruits of the autumn harvest. Another offering on this occasion was the *eiresiōnē*. This was a branch of olive or laurel, bound with purple or white wool, round which were hung various fruits of the season, pastries, and small jars of honey, oil and wine. It was intended as a thank-offering for blessings received, and at the same time as a prayer for similar blessings and protection against evil in future; hence, it was called a "suppliant" branch (*ἰκετηρία*). The name is generally derived from *εἶπος* (wool) in reference to the woollen bands, but some connect it with *εἶπεω* (to speak), the *eiresiōnē* being regarded as the "spokesman" of the suppliants. It was carried in procession by a boy whose parents were both alive to the temple of Apollo, where it was suspended on the gate. The doors of private houses were similarly adorned. The branch was allowed to hang for a year, when it was replaced by a new one, since by that time it was supposed to have lost its virtue. During the procession a chant (also called *eiresiōnē*) was sung, the text of which has been preserved in Plutarch (*Theseus*, 22):—

"Eiresiōnē carries figs and rich cakes;
Honey and oil in a jar to anoint the limbs;
And pure wine, that she may be drunken and go to sleep."

The semi-personification of *eiresiōnē* will be noticed; and, according to Mannhardt, the branch "embodies the tree-spirit conceived as the spirit of vegetation in general, whose vivifying and fructifying influence is thus brought to bear upon the corn in particular."

Aetiologists connected both offerings with the Cretan expedition of Theseus, who, when driven ashore at Delos, vowed a thank-offering to Apollo if he slew the Minotaur, which afterwards took the form of the *eiresiōnē* and Pyanopsia. To explain the origin of the hodge-podge, it was said that his comrades on landing in Attica gathered up the scraps of their provisions that remained and prepared a meal from them.

See W. Mannhardt, *Wald- und Feldkulte* (1905), ii. 214, for an exhaustive account of the *eiresiōnē* and its analogies; J. G. Frazer, *The Golden Bough* (1900), i. 190; J. E. Harrison, *Prolegomena to Greek Religion* (1908), ch. 3; L. R. Farnell, *Cults of the Greek States* (1907), iv. 286.

PYAPON, a town and district of Lower Burma. The town is situated on a river of the same name, one of the numerous mouths of the Irrawaddy, about 12 m. from the sea. Pop. (1901), 5883. The district, which was only formed in 1903, lies within the delta of the Irrawaddy. It is a vast plain, intersected by tidal creeks and subject to inundation at high spring tides. The swampy jungle is being rapidly reclaimed for rice cultivation, which is the sole crop. Area, 2137 sq. m.; pop. (1901), 226,443, showing an increase of 63% in the decade.

PYAT, FELIX (1810-1889), French Socialist, was born at Vierzon (Cher) on the 4th of October 1810, the son of a Legitimist lawyer. Called to the bar in Paris in 1831, he threw his whole energies into journalism. The violent personalities of a pamphlet entitled *Marie Joseph Chénier et le prince des critiques* (1844), in reply to Jules Janin, brought him a six months' sojourn in La Pélagie, in the cell just quitted by Lamennais. He worked with other dramatists in a long series of plays, with an interval of six years on the *National*, until the revolution of 1848. George Sand, whom he had introduced in 1830 to the staff of the *Figaro*, now asked Ledru-Rollin to make him commissary-general of the Cher. After three months' tenure of this office he was returned by the department to the Constituent Assembly, where he voted with the Mountain, and brought forward the celebrated motion for the abolition of the presidential office. About this time he fought a duel with Proudhon, who

had called him the "aristocrat of the democracy." He joined Ledru-Rollin in the attempt of the 13th of June 1849, after which he sought refuge in Switzerland, Belgium, and finally in England. For a glorification of regicide on the occasion of the Orsini attempt against Napoleon III. he was brought before an English court, but acquitted, and the general amnesty of 1869 permitted his return to France, but further outbursts against the authorities, followed by prosecution, compelled him to return to England. The revolution of the 4th of September brought him back to Paris, and it was he who in his paper *Le Combat* displayed a black-edged announcement of the *pourparlers* for the surrender of Metz. After the insurrection of the 31st of October he was imprisoned for a short time. In January 1871, *Le Combat* was suppressed, only to be followed by an equally virulent *Vengeur*. Elected to the National Assembly, he retired from Bordeaux with Henri Rochefort and others until such time as the "parricidal" vote for peace should be annulled. He returned to Paris to join the committee of public safety, and, in Hanotaux's words, was the *âme ulcérée* of the Commune, but was blamed for the loss of the fort of Issy. He was superseded there by Delescluze, but he continued to direct the violent acts of the Commune, the overthrow of the Vendôme column, the destruction of Thiers's residence and of the expiatory chapel built to the memory of Louis XVI. He escaped the vengeance of the Versailles government, crossed the frontier in safety, and, though he had been condemned to death in his absence in 1873, the general amnesty of July 1880 permitted his return to Paris. He was returned to the Chamber of Deputies for the department of Bouches-du-Rhône in March 1888 and took his seat on the extreme Left, but died at Saint-Gratien on the 3rd of August 1889.

PYATIGORSK, a town and watering-place of Russian Caucasia, in the province of Terek, 141 m. by rail N.W. of Vladikavkaz. Pop. (1882), 13,670; (1897), 18,638. It owes its origin to its mineral waters, which have long been known to the inhabitants of Caucasia. The sulphur springs, about fifteen in number, come from a great depth, and vary in temperature from 75° to 96° F.; they are used both for drinking and for bathing. The first buildings were erected in 1812, and in 1830 the name of Pyatigorsk ("town of the five mountains") was given to the new settlement. Its subsequent rapid increase was greatly stimulated by the completion of the railway connexion with Rostov-on-the-Don. The town is charmingly situated on a small plateau, 1680 ft. above sea-level, at the foot of the Beshtau, Mashuk and three other outliers of the Caucasia range, which protect it on the north. The snow-covered summits of the Elbruz are visible to the south. The most noteworthy features are a cathedral, a monument to the poet M. Y. Lermontov (1814-1841), and a hydropathic.

PYCNOGONIDA, or PANTOPODA, marine Arachnida (*q.v.*) remarkable for the reduction of the opisthosoma or abdomen to an insignificant tubercular or rod-like process (whence their trivial name of "nobody crabs"), and for the development of the oral region into a relatively immense suctorial proboscis. They form a compact group, differing from all the other orders of Arachnida in certain structural characters of such morphological importance that it is impossible to affiliate them closely with any group of that class. For instance, in all typical existing Arachnida the ganglionic centres which innervate the ambulatory appendages are coalesced to form a single nervous mass, whereas in the Pycnogonida the ganglia supplying these limbs retain their original distinctness. More important still is the circumstance that in the Pycnogonida there may be as many as seven pairs of leg-like limbs behind the mouth; but in the typical Arachnida there are never more than five such pairs. Curiously enough, too, although the number of these appendages, in all the orders of typical Arachnida is, with the exception of some degenerate Acari, a quite constant character, the number in the Pycnogonida is very variable. In most cases there are four pairs of ambulatory limbs, but in two antarctic genera, namely *Pentanympion*, belonging to the family Nymphonidae and *Decalopoda*, probably belonging to the Colossendeioide, they

are increased to five pairs. In front of these four or five pairs of ambulatory limbs there may be two pairs of longish post-oral limbs, called respectively the ovigerous legs and the palpi; but these may be totally absent. Finally, the single pair of pre-oral appendages may be well developed, three-jointed and chelate, or reduced in size and complexity, or altogether suppressed.

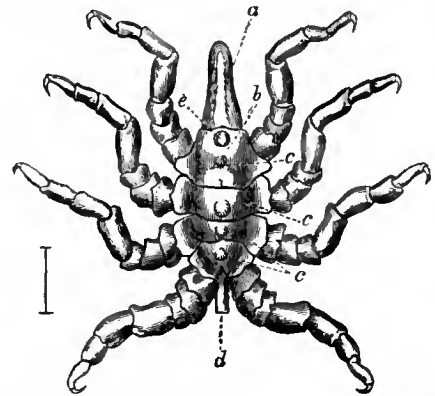

FIG. 1.—Male of *Pycnogonum littorale*, Müller.

a, Parts of mouth forming a beak.
b, Cephalic area.
c, Thoracic segments.
d, Rudimentary abdomen.
e, Eyes.

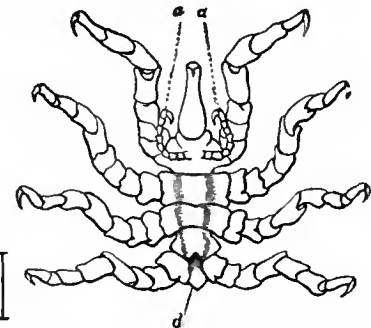

FIG. 2.—The same; under size.
a, a, Ovigerous legs.

As examples of this class exhibiting extremes of variation in the development and reduction of the appendages may be cited *Decalopoda*, which has the full complement of eight pairs of appendages, and the female of *Pycnogonum littorale*, in which all the appendages are aborted save four pairs of ambulatory limbs.

All the principal organs of the body are concentrated in that part which bears the appendages. The generative glands are lodged on each side, sending prolongations into the appendages, and their ducts open upon the second segments of more or fewer of them. The alimentary canal, beginning with the mouth at the extremity of the proboscis and terminating with the anus at the extremity of the tail-like opisthosoma, also sends long saccular prolongations into the limbs. Food is imbibed by means of the suctorial pharynx lodged in the proboscis, the sucking action being effected by means of muscles radiating from the wall of the pharynx to that of the inner surface of the exoskeleton of the proboscis. The circulatory system, where it has been observed, consists of a heart formed of about three chambers communicating with each other. In each chamber there is a pair of orifices for the entry of the blood; and the fluid is expelled through an orifice at the anterior extremity of the first chamber. No organs of respiration are known, the integument being the medium for the oxygenation of the blood.

The sexes are distinct, but commonly there is little external difference between the males and the females. Sometimes the female is considerably the larger of the two; and frequently the ovigerous legs are less well developed than in the male. Sometimes indeed these limbs are entirely wanting in the female, whereas this is never the case in the male. Finally, in the females the generative orifices are much more conspicuous than in the males, and the fourth joint of the legs is often swollen. The invariable presence of the ovigerous appendages in the males is correlated with the habit practised by this sex of carrying the fecundated eggs. The eggs are usually aggregated in two spherical masses round the middle of each of the ovigerous legs; sometimes, however, there are two such masses on

each leg, or as many as four or five, whereas occasionally there is but one on the right or left side. More rarely, as in some species of *Pallene*, there are few very large eggs attached separately to the legs, or the eggs may be carried in a single mass attached to the underside of the body, as in some species of *Pycnogonum*. Cases have been recorded of the females carrying their own eggs, as has been observed in a specimen of *Nymphon brevicaudatum*, but this seems to be a rare phenomenon.

The newly-hatched young frequently differs greatly from the adult. The body, which is oval, subquadrate and unsegmented, has the proboscis well developed, but bears only three pairs of appendages; those of the first pair are large, three jointed and chelate, the basal segment containing a large so-called byssus gland, the duct of which opens at the tip of a spiniform or setiform process; these appendages are the mandibles of the adult. The appendages of the next two pairs are simple and small, and are generally held to be the palpi and ovigerous legs. This first larval stage, sometimes called the protonymphon, may be free living or may be retained within the egg-shell. In the second stage, which may also be contained in the egg, two or three of the remaining pairs of appendages have appeared, those representing the first pair of ambulatory limbs of the adult being as a rule better developed than the next. In the third stage the fourth pair of ambulatory limbs and the abdomen of the adult have begun to develop and gradually increase in size until the adult form is attained. But even within the limits of a single genus, e.g. *Nymphon*, the stage at which the young emerges from the egg is subject to considerable specific variation.

Pycnogonida vary greatly in size, the span of legs when extended ranging from about 2 in. in *Pycnogonum littorale* to 2 ft. in *Colossendeis gigas*. They are wholly marine and occur at depths varying from only a few fathoms to over 2500 fathoms. One of the best known British species is *Pycnogonum littorale*, a stoutly built form with only four pairs of appendages in the female. It occurs between tide marks on British coasts, but recedes to considerable depths, and on the Atlantic coast of America has been dredged at a depth of 430 fathoms. It is also wide-ranging, and has been recorded even from the coast of Chile. As a rule, but by no means an invariable rule, deep-water species have smoother bodies and much longer and thinner legs than shallow-water forms. The latter also commonly have four distinct eyes, whereas the former met with at a depth of over 400 fathoms not uncommonly have the eyes obsolete. There are many exceptions, however, to these rules. The habits of all Pycnogonida appear to be very similar. They are not swimmers, but crawl slowly over the bottom of the sea or amongst the fronds of seaweed, and they have been met with in polar, temperate and tropical seas. (R. I. P.)

PYCNOSTYLE (Gr. *πυκνός*, close, compact, and *στυλος*, column), the architectural term given by Vitruvius to the intercolumniation of the columns of a temple, when this was equal to 1½ diameters.

PYE, HENRY JAMES (1745–1813), English poet laureate, was born in London on the 20th of February 1745, and educated at Magdalen College, Oxford. His father, a Berkshire landowner, died in 1766, leaving him a legacy of debt amounting to £50,000, and the burning of his home at Great Faringdon further increased his difficulties. In 1784 he was elected M.P. for Berkshire. He was obliged to sell the paternal estate, and, retiring from Parliament in 1790, became a police magistrate for Westminster. Although he had no command of language and was destitute of poetic feeling, his ambition was to obtain recognition as a poet, and he published many volumes of verse. Of all he wrote his prose *Summary of the Duties of a Justice of the Peace out of Sessions* (1808) is most worthy of record. He was made poet laureate in 1790, perhaps as a reward for his faithful support of Pitt in the House of Commons. The appointment was looked on as ridiculous, and his birthday odes were a continual source of contempt. His most elaborate poem was an epic, *Alfred* (1801). He was the first poet laureate to receive a fixed salary of £27 instead of the historic tierce of Canary wine. He died at Pinner, Middlesex, on the 11th of August 1813.

PYGMALION, in Greek mythology, son of Cilix, and grandson of Agenor, king of Cyprus. He fell in love with an ivory statue he had made; Aphrodite granted life to the image, and Pygmalion married the miraculously-born virgin (Ovid, *Metam.* x. 243). There is no ancient authority for the introduction of the name

Galatea into the story. Pygmalion is also the name given in Virgil (*Aeneid*, i, 347) to a king of Tyre, who murdered Sychaeus, the husband of his sister Dido.

PYGMY, or ΠΙΓΜΥ (Gr. *πυγμαῖος*, from *πυγμή*, a Greek measure of length corresponding to "the distance between the elbow and knuckles" of a man of average size), a term for a diminutive human being. We owe the word to Homer, who in the *Iliad* (iii. 6) uses it to describe a race of tiny folk dwelling in a far southern land, whither the cranes fly when inclement winters and piercing frosts visit the northern shores. Fierce battles were often mentioned by later writers as occurring between the pygmies and cranes, and were even represented on their vases. On these the pygmies were depicted as dwarfs with large heads, negro features, close, curly hair, and sometimes armed with lances. Aristotle firmly believed in the existence of these pygmies, whom he characterized as a race of men of small stature inhabiting the marshes of upper Egypt towards the sources of the Nile. That their existence was a matter of common knowledge and speculation is indicated by the fact that Philostratus describes the sleeping Hercules beset by swarms of pygmies. Herodotus (ii. 32), relying apparently on authentic information, describes graphically how a party of five Nasamonians, while journeying through the African desert, came at last to a plain where fruit-trees grew. While gathering the fruit they were seized by some dwarfish men of strange speech, who led them across forest marshes to a town, where dwelt people of a similar appearance, and near which a great river flowed from west to east containing crocodiles. This river was probably the Niger, and the people referred to were no doubt the ancestors of the existing pygmies of equatorial Africa. Representations of these pygmies have been found sculptured on the tombs at Sakkarah, which are referred to the Vth Dynasty of Egypt, 3366 B.C. The pygmies depicted in bas-relief on these tombs faithfully reproduce the racial characteristics of the present race of pygmies inhabiting the Ituri and Semliki forests. They no doubt served in the households of the Egyptian kings, and figured both in Egyptian and Roman triumphs.

Various writers have localized pygmies in different portions of the earth's surface. Pliny makes mention of dwarfed races in both Asia and Africa. Reference is made to the Catizi dwarfs in Thrace, and to a similar race dwelling in Caria. Ctesias, a century after Herodotus, wrote of a race of pygmies in the heart of India, describing them as black and ugly, and only two *pygmai* in height. The Chinese author, Chao Fu-Kua, in the beginning of the 13th century, described a tribe of black pygmies dwelling in the Philippine Islands; in the depth of the valleys there lived, he said, a tribe of men called Hai-tan, small in size, with round, yellow eyes, curly hair, and with the teeth showing through their lips. These were no doubt the ancestors of the present Aëtas. Relics of a pygmy race are supposed to exist now in Sicily and Sardinia, i.e. along the high road between Pleistocene Africa and Europe. Near Schaffhausen, Dr Kollman found skeletal remains of small human beings, which have been regarded by some authorities as belonging to the European pygmies of the Neolithic period. Some anthropologists of authority, indeed—in spite of the absence of definite data in support of such a view—believe that a dwarf negroid race at one time existed in northern Europe, and may have given rise to the traditional tales of elves, goblins, gnomes and fairies.

At the present time the existing pygmy races may be subdivided into two main groups or sub-races: (a) the African pygmies (Negrilloes), (b) the Asiatic pygmies (Negritoos).

a. The African pygmies are dispersed over a large zone extending right across equatorial Africa, from Uganda to the Gaboon, the width of this zone being about six degrees, i.e. three degrees north and south of the equator. In Uganda they are now principally confined to a belt of forest lying to the east and west of the Semliki River, though many centuries ago these forest dwarfs must have been the principal inhabitants of the whole of the Uganda Protectorate. They are much more abundant in the forests of the Belgian Congo, being found as far south as the range of the Angola, and to the north and north-west as far as the Bahr-el-Ghazal and the German Cameroons. They are also found in the interior of the French Congo and in the Gaboon. They comprise the *Akkas*

(Tiky-Tiky) of the upper Nile, and of the Niam-Niam country; the *Wambutti* (Mbuti, Mambute, Bambute) of the great Ituri forest, and the *Batua* (Watwa) living to the south of the great curve of the Congo river. In the vast forest tract lying between the region of the great lakes and the Atlantic Ocean there are other scattered tribes of pygmies differing in no essential particulars from these, and severally known as *Affii* (of the Momfu country); *Obongo*, *Wochua*, *Akua*, *Achango* (of the French Congo), *Ba-Bengaye* (of Sanga), *Boyaeli* and *Bayago* (of the Cameroons). Negrilloes have also been noted outside these limits, e.g. in the basin of the upper Kasai, as far east as Lake Tanganyika, and even to the north of Lakes Stefanie and Rudolf in British East Africa. There has been considerable mixture of the Negrilloes with the neighbouring Bantu peoples, e.g. *Adumas*, &c.

b. The distribution of the Asiatic pygmies is mainly Oceanic. The following are the three principal tribes. (1) *The Aëtas* (Philippine Islands). The name "Aëtas" is derived from the Malay word *hitam*, meaning black. These little folk dwell in small groups in the interior of Luzon Island, and are to be met with also in the islands of Mindoro, Panay and Negros, and in the north-east of Mindanao. The total number of Philippine Negrilloes is about 20,000. (2) *The Andamanese* (Andaman Islands). These live in isolated groups of fifty to eighty persons. They appear to be dying out, and in 1891 numbered less than 4000. The term *Mincopis* has sometimes been applied to these Negrilloes. (3) *The Sakai* (interior of the Malay Peninsula). Some of these Malay Negrilloes are also known as *Semangs*, *Menik*, *Sen-oi* and *Jembe*. They live for the most part in small groups of from two to three families. In the Ulu-Papung district alone the pure Negrilloes in 1890 numbered over 5000. There is much mixture, however, with the surrounding Malay population. Thus the *Mintra* and *Jakhuns* are *Sakai-Malay* cross-breeds. In Malacca the *Pangyans* of Kelantan and *Petani* and the neighbouring *Tumiors* are pure Negrilloes, while the *Belendas* are probably cross-breeds. Some anthropologists believe that the *Sakas* of the islands on the north-east coast of Sumatra are also derived from Negrilloes.

A group of Negrilloes—the *Karons*—has also been discovered in a small area in the north-west coast of New Guinea.¹ Here also there are *Negrilo-Papuan* cross-breeds. There is much diversity of opinion as to whether the recently extinct *Kalangs* of Java—in some respects the most ape-like of all human beings—did or did not belong to the true Negrilo race.

There seems little doubt that at one time the Negrilo element was fairly widespread throughout Malaysia, though there is no positive evidence in support of de Quatrefages's contention that the Negrilo race once inhabited a vast domain in Indo-oceanic Asia, extending from New Guinea up to the Persian Gulf, and from the Malay Archipelago to Japan. The Malay Peninsula, and possibly some parts of India, are the only portions of the Asiatic mainland where traces of a distinct negroid substratum have been discovered.

A passing reference may here be made to the *Bushmen* of South Africa, whose average height (4 ft. 8 in.) approximates to that of the true pygmies. Some authorities believe that there is a distinct ethnical relationship between the Negrilloes and the *Bushmen*, though in many respects the forest pygmies seem more closely allied to the West African Bantu negroes than to the *Bushmen-Hottentot* group. Professor Elliot-Smith is, indeed, of opinion that the pygmies of Central Africa are essentially dwarfed negroes. Schweinfurth, who rediscovered the *Akka* pygmies of equatorial Africa, believed that they and the *Bushmen* of South Africa were the remnants of the aboriginal population of the continent, now becoming extinct. The *Bushmen* have totally different characteristics from the true pygmies. The *steatopygia*, the *dolichocephalic* cranium, the lozenge-shaped face with its deep wrinkles, the high protruding cheek-bones, the narrow oblique eyes, the peculiar speech with its marvellous "clicks," the fawn-yellow skin, the absence of downy hair on the body, and other characteristics of the *Bushmen*, sharply differentiate them from the true forest pygmies.

Consideration of the distribution and general characteristics of the existing pygmy races—Negrilloes and Negrilloes—has induced many anthropologists to conclude that we are dealing with the but little modified descendants of an extremely ancient race—the ancestors possibly of all the negro tribes. Sir W. H. Flower himself, as far back as 1880, stated that he was inclined to regard the Negrilloes as representing an infantile, undeveloped, or primitive form of the type from which the African negroes on the one hand, and the Asiatic Melanesians on the other, with all their various modifications, may have sprung. If this view be correct, it seems probable that the members of the pygmy races are the existing human beings which most closely resemble primitive man. On the other hand, there are those who regard

¹ In *The Times* of June 3, 1910, was reported a discovery, made by an expedition organized by the British Ornithologists' Union, of a tribe of pygmy people (probably Negrilloes) in the great snow mountains of Dutch New Guinea, at an altitude of about 2000 ft. The average height of these pygmies is about 4 ft. 3 in.

the pygmies as a retrograde and degenerative type of the negro race and therefore of comparatively recent growth. Though the balance of evidence seems in favour of the former hypothesis, the question must still be regarded as *sub judice*. The first hypothesis would certainly go far to explain the present distribution of the pygmy races. If we regard, as many authorities do, the Indo-African continent, submerged in comparatively recent geological times by the waters of the Indian Ocean, as being the original home of primitive man, then it is easy to understand how he migrated from the subsiding Indo-African continent westward into the heart of Africa, and eastward to the Malay Peninsula by way of the Eastern Archipelago, at that time forming part of the mainland. Those members of the primitive race who migrated westward are supposed to have spread over the larger portion of the continent of Africa. They appear to have divided off into two main branches, the Negrillo pygmies of central Africa and the *Bushmen* of the southern portion of the continent. These two sub-races appear to have been the aboriginal inhabitants of the country, though their direct descendants have now been driven into the great forest fastnesses by the more powerful Bantu races which sprang from the parent stem at a later date. A. H. Keane, who considers the recently extinct *Kalang* pygmies as the aborigines of Java, thinks it probable that this island was the first region reached by primitive man and his Miocene precursor during the eastward migration from the subsiding Indo-African continent.

General Characters of the Pygmy Races.—As regards *stature*, the smallest are the African Negrilloes, their average height being 1.38 m. (4½ ft.). One of the six Mambute Negrilloes brought to England by Colonel Harrison in 1906 measured just over 3½ ft. Individuals not exceeding 3 ft. are met with, though the midgets of one or two *pygmai* in height, whose existence is indicated in the early Greek writings, must be relegated to the realm of mythology.

The Philippine Aëtas measure 1.47 m., while the average height of the *Sakai* and *Andamanese* is 1.49 m.

The present writer estimated the *weight* of six adult Mambute pygmies (four males and two females) from the Ituri forest, and found the average weight to be seventy-seven pounds. Two of these, one man and one woman, each weighed only fifty-three pounds. All the pure pygmy tribes—whether Negrilloes or Negrilloes—in addition to their small size have certain well-marked characters in common. The most notable of these are *crisp, closely-curved hair*, *flattened nose*, broad at the base, deeply depressed at the root and with exaggerated development of the *alae nasi*, long upper lip with the mucous membrane moderately everted, large ape-like mouth, receding chin, pronounced prognathism, abundant fine woolly hair on the body, brachycephalic cranium, proportionately long arms and short legs, and a general simian appearance.

The *colour* of the skin shows considerable variation. The pure-blooded African *Akkas* are of a peculiar dirty reddish-yellow colour, the Mambute pygmies of the Ituri forest have a skin of a deep chocolate-brown hue, while that of the Oceanic Negrilloes is of a dark brown or blackish colour, differing but little from that of the surrounding Papuans and Melanesians. The eyes of the pygmies are often large and staring, giving a characteristic "wild appearance."

The abdomen is protuberant in the case of the African pygmies, but not so in the case of the Oceanic Negrilloes. The mid-point of the body is above the umbilicus, instead of being below as in the case of Europeans and Asiatics. There is no definite *steatopygia*, though in a few individual cases among the black Negrillo women the buttocks attain considerable dimensions.

The feet are large and turned slightly inwards, while the toes are relatively longer than those of Europeans. In some there is a tendency for the four smaller toes to diverge from the great toe. Being wonderfully adroit climbers, they sometimes make use of their feet by grasping branches between the great toe and the rest of the toes.

Their clothing is chiefly conspicuous by its absence. The African pygmies go about, for the most part, quite naked, except for the occasional presence of a small covering over the *pubenda*, the men wearing a small piece of deer-skin, and the women one or two bunches of green leaves, which they renew daily. The resemblance to the traditional fig-leaf covering is obvious. The *Andamanese* wear practically no clothing. The *Karons* of New Guinea wear a few strips of bark dangling from a string round the loins. The Negrilloes seldom, if ever, tattoo their body. They are fond of beads and other articles of adornment; the upper lips are often pierced with holes, through which quills are thrust. They cut their short curly hair into all sorts of fantastic patterns, and often twist some of it into peaks into which they plait feathers.

Pygmy dwellings are extremely primitive structures. In Africa they are simply arbours constructed of bent interlaced branches and plantain leaves, about 7 ft. in diameter and 4 ft. high, with a

small hole near the bottom, through which the pygmy crawls on all fours. Ten or twelve of these arbours constitute a village. These arbours are only temporary habitations, as the pygmies are always moving on to different portions of the forest in pursuit of game. The Philippine Aëtas show the same nomadic tendencies. The dwellings of the Malay Semangs are mere lean-to's, constructed of matted palm-leaves, while the Karons of New Guinea live in wretched hovels of foliage and branches, and in some districts have no habitations whatever.

The pygmies are seldom if ever tillers of the soil. The African forest dwarfs live mainly on the flesh of birds, deer and other animals, which they shoot with bows and arrows. They eat white ants, bee grubs and the larvae of beetles, also honey, wild beans and mushrooms. They are fond of fruits, particularly bananas, which they obtain from their bigger neighbours by barter or by plunder. They eat the vegetables raw, while the meat is broiled in the ashes of the fire until quite dry. Their utensils consist solely of a few clay cooking-pots and gourds for water. There is no record of cannibalism among the pygmy races. The six Mambute pygmies brought to England in 1906 soon became acclimatized. They took most kindly to European diet and clothing. At the expiry of eighteen months they went back to the Ituri forest much improved in health, having each gained on an average 9½ lb in weight.

They are most daring hunters, and marvellously skilful archers. Though of small size they are well made and agile, and are able to dart in and out with the greatest of ease amongst the tall tangled vegetation of the tropical woodlands. The Batwa, from the south of the Congo, successfully attack elephants, shooting them with their tiny poisoned arrows. The poison is obtained from the juice of certain plants, and also from decaying animal matter derived from the putrefaction of ants. The Andaman pygmies live exclusively by hunting and fishing.

The African pygmies marry at a very early age, often when only nine or ten years old. Marriage is simply a question of the purchase of the girl from her father; the purchase-price being from ten to fifteen arrows, occasionally supplemented, in the case of a desirable wife, by one or two spears or some tobacco. A man may have as many wives as he can afford to buy. A mother gives birth to her offspring in the forest, severing the navel-cord with her teeth, and burying the placenta in the ground. The families are usually small, rarely exceeding three in number. There is great rejoicing when a boy is born, while the unlucky girl baby is beaten by her father with plantain leaves. The boys are often circumcised. There is great affection between the husband and the wife and between the parents and the children. The duration of life is short in the equatorial forests, death usually taking place before the age of forty. The dead are buried in graves, the chief's wives being sometimes killed and buried along with him.

The African pygmies have little if any belief in life after death. They say death is the end of everything. They have a vague belief in "Oudah," a sort of pygmy devil, who is responsible for sudden death and such-like calamities. There is no trace of spirit or ancestor worship. The Andaman Islanders have a vague belief in a sort of god—"Püluga"—an invisible being who lives in a large stone house in the sky, and who made all things. They also believe in an evil one, to whom they attribute sickness and death.

There is no hereditary chief. In many cases a group of pygmies simply cluster round a skilful hunter. In the case of the Mambute pygmies, a chief is succeeded, not by his son, but by his best friend. There are no governmental laws. Murder in the Ituri forest is punished by the next-of-kin lying in wait for the culprit and killing him.

The Negrilloes are fond of music and have numerous folk-songs. They also twang on stringed bows, and beat drums made of hollowed-out tree trunks covered in at the ends with antelope skin. They are also great dancers, keeping perfect time to the beating of the drums their bodies going through the most extraordinary contortions. They all dance together in a long line, which twists about like a snake.

The forest dwarfs have some idea of drawing, each arrow shaft having its distinctive carving. The Andamanese display a considerable degree of intelligence. The Karons of New Guinea, on the other hand, seem to be of a low type of intelligence.

The Negrilloes have acquired a great reputation among the neighbouring tribes for their knowledge of poisons and their antidotes. Their treatment of all pains and inflammations consists in linear scarification of the skin of the affected part. They invariably use sharpened arrow-heads for this purpose.

Close observation has convinced the present writer that the African pygmies are endowed with a high degree of intelligence. Sir Harry Johnston believes them to be the intellectual superiors of the big negroes. They exhibit vivacity and adroitness, quickness in picking up information and languages, and surprising readiness in grasping the salient points of a subject. They are wonderful mimics, and have a marked sense of humour, making witty remarks which set the others off into peals of laughter. They are as a rule bright and cheerful in disposition, will sometimes fly into sudden fits of ill temper and as quickly recover their good humour. They are cleanly in their habits, have a natural sense of

modesty and refinement, and punctiliously observe the ordinary decencies of life.

The pygmies of the Malay Peninsula have a perfectly distinct language of their own. A glossary and grammar with phonetic rules of the Sen-oi dialect has been published, showing no connexion with any other known language.

The African pygmies, for the most part, speak a more or less corrupt form of the language of the adjacent negro tribes, e.g. Keswahili, Bantu, Momfu. They have some words, however, peculiar to themselves, which may be the fragments of their own original language. (R. M. L.)

PYLE, HOWARD (1853-), American artist and writer, was born at Wilmington, Delaware, on the 5th of March 1853. He was a pupil of the Art Students' League, New York, and first attracted attention by his line drawings after the manner of Albrecht Dürer. His brilliant work as an illustrator made him one of the foremost of American artists, his drawings to illustrate American colonial life, particularly in New England and New Amsterdam, being especially noteworthy; and he published a number of books of fiction, written and illustrated by himself. He also became prominent in decorative painting, his works including "The Battle of Nashville" for the capitol at St Paul, Minnesota, and "The Landing of Carteret" for the Essex county court house, Newark, New Jersey. At his home in Wilmington, Delaware, he established a school of art, instruction being gratuitous, and many successful American illustrators were educated there. In 1907 Howard Pyle was elected a member of the National Academy of Design.

PYLOME, in Zoology, the name given to the principal opening (or openings) of the shell (theca, test) of such Protozoa as possess one. (See FORAMINIFERA, RADIOLARIA.)

PYLOS (mod. Navarino), in ancient geography a town and bay on the west coast of Messenia, noted chiefly for the part it played in the Peloponnesian War. The bay, roughly semi-circular in shape, is protected by the island of Sphacteria (mod. Sphagia), over 2½ m. long from N. to S., and is entered by two channels, that on the S., some 1,400 yds. wide, and that on the N., 220 yds. wide and now almost silted up. To the north lies an extensive shallow basin, called the lagoon of Osman Aga, originally part of the great harbour but now cut off from it by a narrow sandbank. North of Sphagia is the rocky headland of Pylos or Coryphasium, called in modern times Palæo-Navarino or Palæokastro, from the Venetian ruins on its summit. Originally an island, this headland was in classical times, as now, connected by a narrow bar with the lower promontory of Hagios Nikolaos on the north; it is now united to the mainland also by the sandbar already mentioned. Most scholars, ancient and modern, have identified this with the Homeric Pylos, the home of Neleus and Nestor, and a cave on the north slope of Coryphasium is pointed out as that in which Hermes hid the stolen cattle of Apollo. But this view presents considerable difficulties, and Strabo (viii. 348 sqq.) argued that the Pylos of Nestor must be the place of that name in Triphylia. After the Dorian migration Pylos declined, and it is referred to by Thucydides (iv. 3) as a deserted headland in 425 B.C. In May of that year, the seventh of the Peloponnesian War, the Athenians sent an expedition to Sicily under command of Eurymedon and Sophocles. With them was the general, Demosthenes, who landed at Coryphasium with a body of Athenian troops and hastily fortified it. The Spartans, who were then invading Attica, withdrew their forces and attacked them vigorously by sea and land, but were repulsed, and the Athenians were enabled by the arrival and victory of their fleet to blockade on the island of Sphacteria a body of 420 Spartiates with their attendant helots. A truce was concluded, but peace negotiations were defeated by Cleon (q.v.), who was himself appointed to conduct operations with Demosthenes. A large body of light troops was landed and drove the Spartans from their encampment by a well in the middle of the island to its northern extremity. Their heroic resistance was overcome by a rear attack directed by a Messenian, who led a body of men by a difficult path along the cliffs on the east, and the 292 Spartan survivors laid down their arms 72 days after the beginning of the blockade. Their surrender made a deep impression on the whole Greek world, which had learned to regard

a Spartan surrender as inconceivable, and to Sparta their loss was so serious that the Athenians might have concluded the war on very favourable terms had they so wished. Though Pylos should have been ceded to Sparta under the terms of the peace of Nicias (421 B.C.) it was retained by the Athenians until the Spartans recaptured it early in 409 B.C. (Diodorus xiii. 64).

In the middle ages the name Pylos was replaced by that of Avarino (*Ἀβαρινός*) or Navarino, derived from a body of Avars who settled there; the current derivation from the Navarrese Company, who entered Greece in 1381 and built a castle at this spot, cannot now be maintained (*Eng. Hist. Review*, xx. 307, xxi. 106; *Hermathena*, xxxi. 430 sqq.). From 1498 to 1821 Navarino was in the hands of the Turks, save at two periods when it was held by the Venetians, who named it Zonklon. In 1821 the Greeks captured the town, situated near the southern extremity of the bay, but in 1825 they had to retire before Ibrahim Pasha. On the 20th of October 1827, however, his fleet of 82 vessels was annihilated in the Bay of Navarino by 26 British, French and Russian ships under Admiral Codrington (see NAVARINO, THE BATTLE OF).

See W. M. Leake, *Travels in the Morea*, i. 398 sqq. (London, 1830), and *Peloponnesiaca*, 190 sqq. (London, 1846); E. Curtius, *Peloponnesos*, ii. 173 sqq. (Gotha, 1852); C. Bursian, *Geographie von Griechenland*, ii. 175 sqq. (Leipzig, 1868); Pausanias iv. 36, and the commentary in J. G. Frazer, *Pausanias's Description of Greece*, iii. 456 sqq., v. 608 sqq. (London, 1898); W. G. Clark, *Peloponnesus*, 214 sqq. (London, 1858); W. Vischer, *Erinnerungen und Eindrücke aus Griechenland*, 431 sqq. (Basel, 1857); G. Grote, *History of Greece*, pt. ii. ch. 52; G. Busolt, *Griechische Geschichte*, iii. 1086 sqq.; F. M. Cornford, *Thucydides mythistoricus*, 82 sqq. (London, 1907). The operations at Pylos, described by Thucydides iv. 2-41, have been discussed on the basis of personal observation by Dr G. B. Grundy (*Journal of Hellenic Studies*, xvi. 1 sqq.; *Classical Review*, x. 371 sqq., xi. 155 sqq., 448; *J.H.S.*, xviii. 232 sqq.) and Professor R. M. Burrows (*J.H.S.*, xvi. 55 sqq.; *C.R.* xi. 1 sqq.; *J.H.S.*, xviii. 147 sqq., 345 sqq.; *C.R.* xix. 129 sqq.). Though differing on many points, they agree in thinking (1) that the island of Sphagia is the ancient Sphacteria, Palaeokastro the ancient Coryphasium or Pylos; (2) that in 425 B.C. the lagoon of Osman Aga was navigable and communicated by a navigable channel with the Bay of Navarino; (3) that Thucydides, if the MS. reading is correct, underestimates the length of the island, which he gives as 15 stades instead of 24 (nearly 3 m.), and also the breadth of the southern channel between it and the mainland. Cf. *J.H.S.*, xx. 14 sqq., xxvii. 274 sqq., and Frazer's summary (*op. cit.* v. 608 sqq.). (M. N. T.)

PYM, JOHN (1584-1643), English statesman, was the son and heir of Alexander Pym, of Brymore, Somersetshire, a member of an ancient family which had held this seat in direct male descent from the time of Henry III. He matriculated as a commoner at Broadgates Hall (now Pembroke College), Oxford, in 1599, and entered the Middle Temple in 1602. He acquired a sound knowledge of the law, and became receiver-general of the king's revenue for Wilts., thus gaining a valuable insight into business and finance. He was returned to parliament as member for Calne in 1614 and again in 1621. He at once became conspicuous in the struggle between Crown and parliament. To the committee appointed to consider the state of religion he made his first great speech on the 28th of November 1621. He held fast to the Elizabethan principle that the Roman Catholics should be subjected to disabilities, not because of their religion, but because of their politics. He, therefore, moved that a special commission for the suppression of recusancy should be appointed, and that an association, after the model of those formed under Elizabeth, should be entered into for defence of the king's person and for the execution of the laws concerning religion. Pym supported Sir Edward Coke in the remonstrance on the prevailing discontents, and was a chief promoter of the petition which incurred James's violent displeasure, and of the Commons' answer defending their privileges, which was afterwards torn from the records by the king's own hand. On the dissolution of parliament which immediately followed, Pym, with other "ill-tempered spirits," was arrested in January 1622, and was confined first to his house in London, and then to Brymore. He associated himself with the party of Francis, 4th earl of Bedford, was returned for Tavistock in 1624, and represented this borough in all the ensuing parliaments. He

supported Eliot in urging war against Spain for the defence of Protestantism and the Palatinate, and showed throughout his career, as far as his attention was ever directed to foreign policy, a steady inclination in favour of France.

In the parliament of 1625 he continued his campaign against the Roman Catholics, and drew up with Sir Edwin Sandys the articles against them, and the petition to the king for the direct execution of the penal laws. In the parliament of 1626 he was the chief mover, in April, in the prosecution of Richard Montagu, who had advocated Romish doctrines. On the 8th of May he was manager of Buckingham's impeachment, when it was his special duty to press articles ix., x., xi., relating to the improper distribution of rewards and honours. In the third parliament of Charles I., in 1628, Pym overruled Eliot in deciding that Buckingham's impeachment should now be subordinated to the struggle on general grievances. He zealously pushed on the Petition of Right, resisting on the 20th of May the clause added by the Lords to safeguard the king's "sovereign power," declaring that "he knew not what it was." On the 9th of June he carried up to the Lords the impeachment of Roger Manwaring, and delivered a famous speech in which he expounded the fundamental principles which guided his policy.

"Histories," he said, "are full of the calamities of whole states and nations . . . [when] one part seeks to uphold the old form of government and the other part to introduce a new . . . But it is equally true that time must needs bring about some alterations. . . . Those things only are eternal which are constant and uniform. Therefore it is observed by the best writers on this subject, that those commonwealths have been most durable and perpetual which have often reformed and recompensed themselves according to their first institution and ordinance."

On the 11th of June he joined in the attack upon Buckingham, whom he regarded as the "cause of all these grievances." On the 27th of January 1629 he was reporter of the committee on religion, and declared that convocation was dependent upon parliament. He again, in February 1629, differed from Eliot, who treated the dispute about tonnage and poundage as a point of privilege, declaring that "the liberties of this house are inferior to the liberties of the kingdom," and desiring to deal with it on higher ground as a breach of law and the constitution. He took no part in the subsequent disturbance in the house, and his name is not mentioned as actively resisting Charles's arbitrary government during the eleven years which followed the dissolution. At this period the state of public affairs may well have appalled the most hopeful and the most patriotic, but there seems no sufficient authority for the belief that Pym, with Hampden and Cromwell, actually embarked for New England and were prevented from sailing by orders from the government. An allusion, however, to a similar plan formed "by some very considerable personages," "diverted by a miraculous providence," is made in a sermon by Thomas Cave in 1642. Pym himself was directly interested in the colonies, being patentee of Connecticut and Providence, and of the latter company also treasurer, and there can be little doubt that like other leaders of the opposition during this period, he regarded America as a possible refuge.

On the assembly of the Short Parliament on the 13th of April 1640, Pym was the acknowledged leader. "Whilst men gazed upon each other," says Clarendon (*Hist.* ii. 68), "looking who should begin (much the greater part having never before sat in parliament), Mr Pym, a man of good reputation . . . who had been as long in these assemblies as any man there living, broke the ice." On the 17th of April he made a great speech of nearly two hours, in which he enumerated the national grievances, deplored almost in the words of Bacon "the interruption of that sweet communion which ought to be betwixt the king and his people in matters of grant and supply," pointed out the practical injury inflicted on commerce and every sort of enterprise including colonial expansion by illegal and arbitrary taxation, and concluded by asking the Lords to join in finding out causes and remedies. His words made a deep impression. On the 27th of April he resisted the grant of supply, and when the Lords passed a resolution that supply should precede the

discussion of grievances, Pym, as manager of the Commons, on the 1st of May, read them a severe lecture on the breach of privilege they had committed. Finally, on the 4th, it was resolved that Pym should next day petition the king to make terms with the Scots, to avoid which Charles summarily dissolved the parliament.

All the energies of Pym were now concentrated on obliging Charles to summon another parliament. He was the author of the petition of the twelve peers to the king for redress of grievances and for calling a new parliament, by the wide distribution of which an appeal was made to the nation, and he was the promoter of the petition signed by 10,000 citizens of London. In company with Hampden he rode through the provinces, rousing and organizing public opinion. Meanwhile Charles's attempt to implicate Pym in treasonable communications with the Scots, though there is little doubt that they existed, met with complete failure. Thus, when the king was forced to call the Long Parliament on the 3rd of November, Pym was its acknowledged author and leader. His great work was now, as he conceived it, to save the national liberties and the national religion. Clarendon (*Hist.* iii. 2) records some "sharp discourse" of Pym with himself at this time, "that they had now an opportunity to make their country happy by removing all grievances and pulling up the causes by the roots, if all men would do their duties." He had seen Vane's notes of Strafford's speeches at the council when he had advised the subduing of "this kingdom" by the Irish army, and on the 7th of November, after declaring to the house the dangerous designs then on foot, Pym moved for a sub-committee to examine into Strafford's conduct in Ireland. The latter's sudden arrival at London on the 9th with the intention of instantly impeaching the popular leaders of treason was met by Pym with corresponding quickness and resolution. On the 11th, after a debate of four hours in the Commons, by his directions with locked doors, he carried up Strafford's impeachment to the Lords, and by this great stroke rendered him at once powerless.

On the 16th of December he moved the impeachment of Laud, whom he joined with Strafford as conspiring to subvert the government of the kingdom, and carried up the articles to the Lords on the 26th of February 1641. He was the chief promoter of the case against Strafford, while the attempts of the queen to gain him over were without result, and on the 28th of January 1641 he brought up to the Lords the list of charges. On the 23rd of March he opened the case, when he argued that to attempt to subvert the laws of the kingdom was high treason, and delivered a violent denunciation against the fallen minister, attributing to him systematic cruelty, avarice and corruption. He soon afterwards heard of the army plot, and the necessity of destroying Strafford became more apparent. He now disclosed Vane's notes. To the attainder, which was at this stage resolved upon, he was opposed (since he clung to the more judicial procedure by impeachment), but when overruled he supported it, at the same time procuring that the legal arguments should not be interrupted. He delivered his final speech on the 13th of April, a great oratorical performance, when he again appealed to the Elizabethan political faith and to that of Bacon, who had so severely censured any action which divided the king from the nation. The man who violated this union was guilty of the blackest treason. "Shall it be treason," he asked, "to embase the King's coin though but a piece . . . of sixpence . . . and not to embase the spirits of his subjects; to set a stamp and character of servitude upon them?" Towards the end of his tremendous indictment of Strafford, Pym broke down, fumbled among his papers, and lost the thread of his argument. But his temporary failure did not diminish the force and effect of his words, all the more impressive because actually spoken in the presence of the sovereign. "I believe," wrote Bailie (*Letters*, i. 348) "the king never heard a lecture of so free language against that his idolized prerogative."

Attempts were now once more made to gain over Pym to the administration. He had two interviews with the king, but without result, and Charles again determined to resort to

force. On the 2nd of May he endeavoured to get possession of the Tower. On the 3rd the Protestation, on Pym's motion, was taken by the Commons within closed doors, and afterwards circulated in the country, and on the 5th Pym disclosed the army plot. These incidents decided the struggle and Strafford's fate. The Lords immediately passed the attainder, together with the bill for making parliaments indissoluble without their own consent. Soon afterwards were swept away those institutions of Tudor growth which had become the chief instruments of oppression, the council of the North, the court of high commission, and the star chamber, while the Crown abandoned the claim to levy customs without consent of parliament. Meanwhile Pym had also taken the lead in the religious controversy. During the dispute between the two houses on this question on the 8th and 9th of February 1641, while supporting the London petition for the abolition of the bishops, he had declared his opinion that "it was not the intention of the House to abolish episcopacy or the Book of Common Prayer, but to reform both wherein offence was given to the people." This, no doubt, expressed his real intentions and policy. When, however, it became clear that the bishops were merely the nominees of the king to carry out "innovations in religion" and preach arbitrary government, Pym was easily persuaded to support their abolition, and voted in opposition to the moderate party for the *Root and Branch* Bill of May 1641, and again for taking away their votes in October. But in his "Vindication," published in March 1643, he especially states that his action with regard to the bishops in "no way concluded me guilty of revolt from the orthodox doctrine of the Church of England."

The first act in the great political struggle had ended in the complete triumph of Pym. His chief care now was to defend the parliament from violence, since this was the only method of retaliation left at the king's disposal. Through the medium of the countess of Carlisle, Charles's plans were regularly disclosed to Pym. In June he heard of the second army plot, and on the 22nd he carried up the ten propositions to the Lords, requesting their concurrence in effecting the disbandment of the armies and the removal of evil counsellors. After Charles's departure for Scotland, Pym served on the committee for defence, appointed on the 14th of August, and was chairman of the committee which sat during the recess from the 9th of September to the 20th of October to watch the progress of affairs and communicate with Scotland. On the latter day letters arrived from Hampden, who had accompanied Charles, with news of the "incident," and immediate measures were taken to guard the parliament, by bringing up the train-bands. On the 30th Pym revealed his knowledge of the second army plot. On the 1st of November came news of the Ulster insurrection, which created a serious difficulty for the parliament, when it was finally declared, at Pym's instance, that if the king did not change his advisers parliament would provide for the needs of Ireland independently. On the 22nd of November Pym made a great speech on the Grand Remonstrance, of which he was the chief promoter, when he referred to plots "very near the king, all driven home to the court and popish party."

Charles returned on the 25th. He immediately substituted a force commanded by Dorset for the guard already placed at Westminster, but was compelled to withdraw it, and on Pym's motion the house appointed its own watch. Everything now pointed to the advent of a frightful catastrophe. Charles appointed Lunsford to the Tower, rejected the Grand Remonstrance and the Impressment Bill, and began to assemble an armed force. In consequence Pym urged, but unsuccessfully, on the 30th of December the summoning of the train-bands to guard the parliament, and moved the impeachment of the bishops, who had declared the proceedings of the parliament to be sinful and illegal. At the critical moment, however, Charles wavered. He renewed his offer to Pym of the exchequer on the 1st of January 1642, and this meeting with a refusal, or again drawing back himself, he determined on the impeachment of the five members on the 3rd of January. The latter had been

forewarned of the king's plans, and when on the 5th he entered the House of Commons with an armed band to seize them, they had removed themselves in safety (see LENTHAL, WILLIAM). Charles's first look on entering was for his great opponent, and he was greatly disconcerted at not finding him in his usual place. To his question "Is Mr Pym here?" there was no answer, and nothing remained but to retreat with his mission completely unachieved.

The second act in the great national drama had thus, as the first, ended in a victory for Pym. On the 11th, with the other members, he was escorted in triumph back to Westminster, and while the other four stood uncovered, Pym returned thanks from his place to the citizens. On the 25th of January he delivered a great speech to the Lords on the perils attending the kingdom, and referring to their hesitation on the subject of the militia, declared that he should be sorry that history should have to relate that the House of Peers had had no part in the preservation of the state in the present extremity of danger. The Commons ordered his speech to be printed, and it provided the chief material for the paper war between Charles and the parliament which now followed. Still endeavouring to avoid a complete breach of constitutional forms, Pym caused to be added to the resolution of the Commons on the 20th of May 1642, which declared that "the king intends to make war against the parliament," the words "seduced by wicked counsel."

When war broke out, Pym remained at headquarters in control of the parliament and executive, and on the 4th of July was appointed to the committee of safety which directed the movements of the parliamentary forces. His attitude was firm but moderate. He opposed the attempt to prevent Colepepper giving the king's message to the house on the 27th of August. On the 20th of October, upon Charles refusing to accept the petition of the parliament and advancing towards London, Pym proposed the parliamentary covenant, and that those who refused it should be "cast out of the House." He succeeded in overcoming the opposition in the city to the heavy taxation now imposed. On the 10th of November, after Edgehill, he spoke in support of the negotiations for peace, at the same time warning the citizens that "to have printed liberties and not to have liberty in truth and realities is but to mock the kingdom." In February 1643 he still showed an inclination for peace, and during the negotiation of the treaty at Oxford supported the disbandment of the armies. When it was evident that peace would not be secured, he proposed in order to carry on the war an excise, hitherto unknown in England, which met with the same violent hostility afterwards aroused by Walpole's scheme. In March he published a "Declaration and Vindication" of his public conduct, in which he threw the whole blame of the appeal to arms on the opposite party, and expressed his fidelity to the Church and constitution. In May he entered, together with the other leaders, into resultless negotiations with the queen, and on the 23rd he took up her impeachment to the Lords. In June he reported on Waller's plot, which exposed the insincerity of Charles's negotiations, and on the 26th of June wrote a "sharp letter" to Essex on his inaction. In July, after the defeat at Adwalton Moor, he prevented the house from again initiating negotiations for peace, which he declared "full of hazard and full of danger," and on the 3rd of August, after having visited Essex at Kingston, persuaded him to separate himself from the peace propositions of the Lords and to march to relieve Gloucester. He thus incurred the hatred of the peace party, and on the 9th of August a mob of women surrounded the house calling for Pym's destruction, and were not dispersed without some bloodshed.

Pym had already, on the 3rd of January, proposed to the house an alliance with the Scots, and the Royalist victories now induced parliament to consent to what had before been rejected. The establishment of Presbyterianism was accepted by Pym as a disagreeable necessity, and he was one of the first to take the covenant on the 25th of September. This alliance, which was afterwards destined to have so decisive an influence

on the military campaign, and was the first occasion on which the two nations had united in public action, closes Pym's great career. He was made master of the ordnance on the 8th of November, but died on the 8th of December at Derby House, where he resided. On the 15th of December he received a public funeral in Westminster Abbey, whence his body was ejected at the Restoration. A sum of £10,000 was voted by the parliament to pay Pym's debts and provide for his family. About 1614 Pym married Anne Hooke, or Hooker (d. 1620), by whom he had five children, including two sons, Alexander, who died unmarried, and Charles, who was created a baronet; this title, together with Pym's male line, became extinct in the person of Pym's grandson Charles in 1688, Brymore then passing to his sister Mary, wife of Sir Thomas Hales, Bart.

Pym had little of the Puritan in his character or demeanour. His good humour, humanity and cheerfulness in all circumstances, "his pleasant countenance and sweet behaviour," were marked characteristics; the aspersions, however, on his morals, as well as the accusations of bribery, are completely unsubstantiated and discredited. His death came as an irreparable loss to the parliamentary cause. "Since Pym died," writes Baillie (*Letters*, ii. 216), "not a state head among them; many very good and able spirits, but not any of so great and comprehensive a brain as to manage the multitude of weighty affaires as lyes on them." He was one of the greatest leaders that the House of Commons has produced, a most capable man of business, and indefatigable in assiduous attention to its details. He possessed great tact in influencing the conduct of the house and in removing personal jealousies on critical occasions, and he excelled as a party leader in choosing and directing the course of policy, and in keeping his followers united and organized in its prosecution, as well as in stimulating and guiding popular opinion outside in its support. The frequent appeals to the nation by protestations, oaths of association and popular petitions, were a very striking feature in Pym's policy, one of the chief sources of his strength, and new in English history. We may indeed perhaps see in these and in the canvassing of constituencies conducted by Pym and Hampden the beginnings of party government. His eloquence lay rather in the clearness of his expression and in the depth and solidity of his ideas than in the more showy arts of oratory. Much of his success as a leader was the result of the confidence inspired by his high character, his well-tryed courage and resolution at critical moments, his skill and vigilance in unmasking and frustrating the designs of the opposite faction. But Pym was not only great as a party leader; he had the real instinct of construction, the true test of the statesman. This construction, he believed, in the spirit of genuine conservatism, must always be progress along the lines of natural development, and not by the methods of revolutionary or extraneous innovation. It was Pym's chief charge against Charles, Strafford and Laud that they had arrested this progress, and were thus leading the nation to ruin and dissolution. Such was the theory and conviction, inherited from Bacon and passed on to Halifax and Burke, which underlay and inspired Pym's policy.

The article on Pym by S. R. Gardiner, in the *Dict. Nat. Biog.* with its references to authorities, must be supplemented by the same author's *Hist. of England and of the Civil War*. Pym's life has also been written at length by J. Forster in Lardner's *Cabinet Cyclopaedia*, *Eminent British Statesmen*, vol. iii., and by Wood in *Ath. oxon.* iii. 72, who adds a list of Pym's printed speeches. His character, drawn by Clarendon, *Hist.* iii. 30 and vii. 409, is inaccurate and obviously prejudiced. See also J. Forster's *Grand Remonstrance, Arrest of the Five Members, Life of Sir J. Eliot*; Verney's *Notes of the Long Parliament*; Whitelocke's *Memorials*, (needing corroboration of other authorities); R. Baillie's *Letters*; *Eng. Hist. Rev.* xvii. 736; Rushworth's *Collections*; *Thomason Tracts*, E 153 (10), 63 (8), 172 (14), 164 (3), 200 (13) (26) (37) (49) (65), 199 (24) (49), 78 (13); *Somers Tracts* iv. 217, 355, 461, 466; *Affanae and Death's Sermon*, by C. Fitzgeffrey; *Add. MSS.* Brit. Mus. 14,827; 11,692; *Lords and Commons Journals*. There are a large number of references to Pym in *Calendars of State Papers Dom.* 1619-1643, and *Colonial Series* 1574-1660, and in the *Hist. MSS. Comm. Series*; but the supposed notebook of Pym mentioned in *Rep.* x. app. vi. 82, has been shown by Gardiner to be that of another person (*Eng. Hist. Rev.*, Jan. 1895, p. 105). (P. C. Y.)

PYRAMID, the name for a class of buildings, first taken from a part of the structure,¹ and mistakenly applied to the whole of it by the Greeks, which has now so far acquired a more definite meaning in its geometrical sense that it is desirable to employ it in that sense alone. A pyramid therefore should be understood as meaning a building bounded by a polygonal base and plane triangular sides which meet in an apex.² Such a form of architecture is only known in Middle Egypt, and there only during the period from the IVth to the XIIth Dynasty (before 3000 B.C.)—having square bases and angles of about 50°. In other countries various modifications of the tumulus, barrow or burial-heap have arisen which have come near to this type; but these when formed of earth are usually circular, or if square have a flat top, and when built of stone are always in steps or terraces. The imitations of the true Egyptian pyramid at Thebes, Meroe and elsewhere are puny hybrids, being merely chambers with a pyramidal outside and porticos attached; and the structures found at Cenchreae, or the monument of Caius Sestius at Rome, are isolated and barren trials of a type which never could be revived: it had run its course in a country and a civilization to which alone it was suitable.

The origin of the pyramid type has been entirely explained by the discovery of the various stages of development of the tomb. In prehistoric times a square chamber was sunk in the ground, the dead placed in it, and a roof of poles and brushwood overlaid with sand covered the top. The Ist Dynasty kings developed a wooden lining to the chamber; then a wooden chamber free-standing in the pit, with a beam roof, then a stairway at the side to descend; then a pile of earth held in by a dwarf wall over it. By the IIIrd Dynasty this dwarf wall had expanded into a solid mass of brickwork, about 280 by 150 ft. and 33 ft. high. This was the *mastaba* type of tomb, with a long sloping passage descending to the chamber far below it. This pile of brickwork was then copied in stonework early in the IIIrd Dynasty (Saqqara). It was then enlarged by repeated heightening and successive coats of masonry. And lastly a smooth casing was put over the whole, and the first pyramid appeared (Medum).

It is certain that the pyramids were each begun with a definite design for their size and arrangement; at least this is plainly seen in the two largest, where continuous accretion (such as Lepsius and his followers propound) would be most likely to be met with. On looking at any section of these buildings it will be seen how impossible it would have been for the passages to have belonged to a smaller structure (Petrie, 165). The supposition that the designs were enlarged so long as the builder's life permitted was drawn from the compound mastabas of Saqqara and Medum; these are, however, quite distinct architecturally from true pyramids, and appear to have been enlarged at long intervals, being elaborately finished with fine casing at the close of each addition.

Around many of the pyramids peribolus walls may be seen, and it is probable that some enclosure originally existed around each of them. At the pyramids of Gizeh the temples attached to these mausolea may be still seen. As in the private tomb, the false door which represented the exit of the deceased person from this world, and towards which the offerings were made, was always on the west wall in the chamber, so the pyramid was placed on the west of the temple in which the deceased king was worshipped. The temple being entered from the east (as in the Jewish temples), the worshippers faced the west, looking towards the pyramid in which the king was buried. Priests of the various pyramids are continually mentioned during the old kingdom, and the religious endowments of many of the priesthoods of the early kings were revived under the Egyptian renaissance of the XXVIth Dynasty and continued during Ptolemaic times. A list of the hieroglyphic names of nineteen

¹The vertical height was named by the Egyptians *pir-em-us* (see E. Revillout, *Rev. Ég.*, 2nd year, 305-309), hence the Greek form *pyramis*, pl. *pyramides* (Herod.), used unaltered in the English of Sandys (1615), from which the singular *pyramid* was formed.

²For figures of geometrical pyramids see CRYSTALLOGRAPHY, and for their mensuration see MENSURATION.

of the pyramids which have been found mentioned on monuments (mostly in tombs of the priests) is given in Lieblein's *Chronology*, p. 32. The pyramid was never a family monument, but belonged—like all other Egyptian tombs—to one person, members of the royal family having sometimes lesser pyramids adjoining the king's (as at Khufu's); the essential idea of the sole use of a tomb was so strong that the hill of Gizeh is riddled with deep tomb-shafts for separate burials, often running side by side 60 or 80 ft. deep, with only a thin wall of rock between; and in one place a previous shaft has been partially blocked with masonry, so that a later shaft could be cut partly into it, macled with it like a twin-crystal.

The usual construction of pyramids is a mass of masonry composed of horizontal layers of rough-hewn blocks, with a small amount of mortar; and this mass in the later forms became more and more rubbly, until in the VIth Dynasty it was merely a cellular system of retaining walls of rough stones and mud, filled up with loose chips, and in the XIIth Dynasty the bulk was of mud bricks. Whatever was the hidden material, however, there was always on the outside a casing of fine stone, elaborately finished, and very well jointed; and the inner chambers were of similarly good work. Indeed the construction was in all cases so far sound that, had it not been for the spite of enemies and the greed of later builders, it is probable that every pyramid would have been standing in good order at this day. The casings were not a mere "vener" or "film," as they have been called, but were of massive blocks, usually greater in thickness than in height, and in some cases (as at South Dahshur) reminding the observer of horizontal leaves with sloping edges.

Inside of each pyramid, always low down, and usually below the ground level, was built a sepulchral chamber; this was reached in all cases by a passage from the north, sometimes beginning in the pyramid face, sometimes descending into the rock on which the pyramid was built in front of the north side. This chamber, if not cut in the rock altogether (as in Menkaura's), or a pit in the rock roofed with stone (as in Khafra's), was built between two immense walls which served for the east and west sides, and between which the north and south sides and roofing stood merely in contact, but unbonded. The gable roofing of the chambers was formed by great sloping cantilevers of stone, projecting from the north and south walls, on which they rested without pressing on each other along the central ridge; thus there was no thrust, nor were there any forces to disturb the building; and it was only after the most brutal treatment, by which these great masses of stone were cracked asunder, that the principle of thrust came into play, though it had been provided for in the sloping form of the roof, so as to delay so long as possible the collapse of the chamber. This is best seen in the pyramid of Pepi (Petrie), opened from the top right through the roof. See also the Abusir pyramids (Howard Vyse) and the king's and queen's chambers of the great pyramid (Howard Vyse, Piazza Smyth, Petrie). The roofing is sometimes, perhaps usually, of more than one layer; in Pepi's pyramid it is of three layers of stone beams, each deeper than their breadth, resting one on another, the thirty stones weighing more than 30 tons each. In the king's chamber (Gizeh) successive horizontal roofs were interposed between the chamber and the final gable roof, and such may have been the case at Abu Roash (Howard Vyse).

The passages which led into the central chambers have usually some lesser chamber in their course, and are blocked once or oftener with massive stone portcullises. In all cases some part, and generally the greater part, of the passages slopes downwards, usually at an angle of about 26°, or 1 in 2. These passages appear to have been closed externally with stone doors turning on a horizontal pivot, as may be seen at South Dahshur, and as is described by Strabo and others (Petrie). This suggests that the interiors of the pyramids were accessible to the priests, probably for making offerings; the fact of many of them having been forcibly entered otherwise does not show that no practicable entrance existed, but merely that it was unknown, as,

for instance, in the pyramids of Khufu and Khafra, both of which were regularly entered in classical times, but were forced by the ignorant Arabs.

The pyramids of nearly all the kings of the IVth, Vth and VIth Dynasties are mentioned in inscriptions, and also a few of later times. The first which can be definitely attributed is that of Khufu (or Cheops), called "the glorious," the great pyramid of

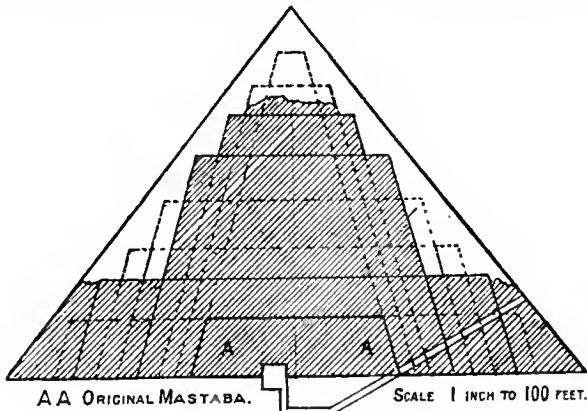

FIG. 1.—Pyramid of Medum (Meidoun).

Gizeh. Dad-ef-ra, who appears next to Khufu in the lists, had his pyramid at Abu Roash. Khafra rested in the pyramid now known as the second pyramid of Gizeh. Menkaura's pyramid was called

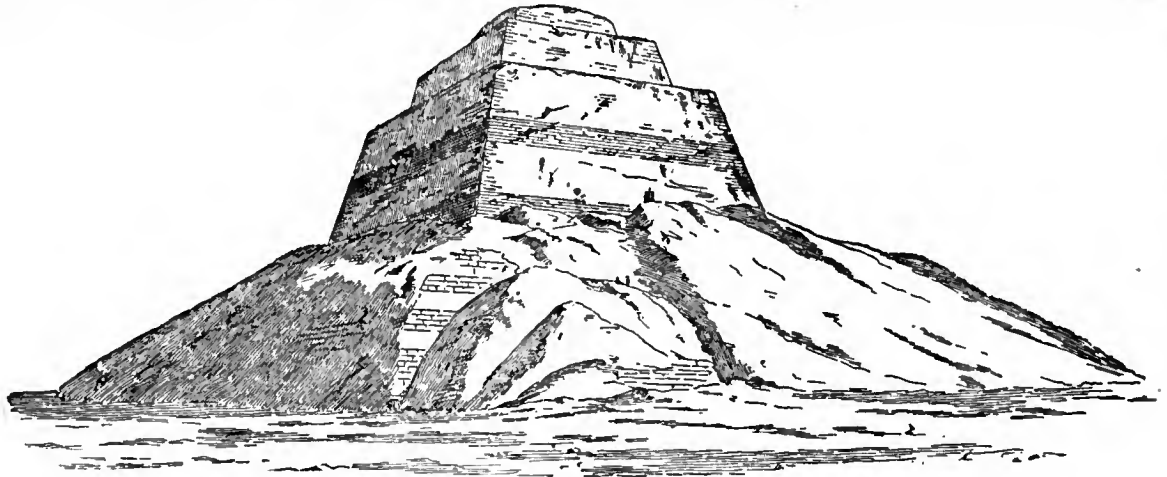
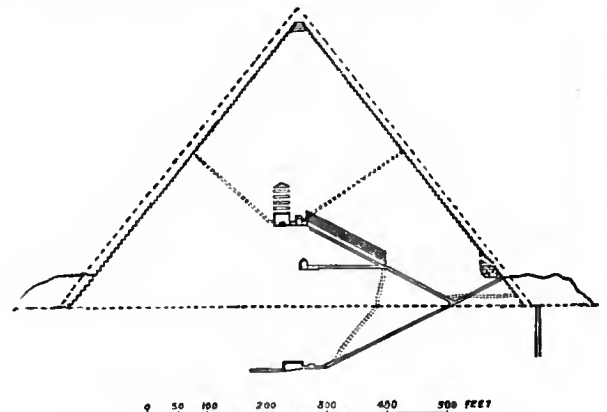

FIG. 2.—Pyramid of Medum.

"the upper," being at the highest level on the hill of Gizeh. The lesser pyramids of Gizeh, near the great and third pyramids, belong respectively to the families of Khufu and Khafra (Howard Vyse). The pyramid of Aseskaf, called "the cool," is unknown, so also is that of Userkaf of the Vth Dynasty, called the "holiest of buildings." Sahura's pyramid, the north one of Abusir, was named "the rising soul," much as Neferarkara's at Abusir was named "of the soul." Raenuser's pyramid, "the firmest of buildings," is the middle pyramid of Abusir. The pyramid of Menkauhor, called "the most divine building," is somewhere at Saqqara. Assa's pyramid is unidentified; it was "the beautiful." Unas not only built the mastaba Farun, long supposed to be his pyramid, but had a pyramid called "the most beautiful of buildings" at Saqqara, which was opened in 1881 (see *Recueil des travaux*, by M. Maspero, iii., for those opened at Saqqara). In the VIth Dynasty the "pyramid of souls," built by Ati (Rauserka), is unknown. That of Teta, "the most stable of buildings," was opened at Saqqara in 1881, as well as that of Pepi (Rameri), "the firm and beautiful." The pyramids of Rameren, "the beautiful rising," and of Neferarkara, "the firm life," are unknown. Haremsaf's pyramid was opened at Saqqara in 1881. Of the last two kings of the VIth Dynasty we know of no pyramids. In the VIIth or VIIIth Dynasty most probably the brick pyramids of Dahshur were erected. In the XIth Dynasty the pyramid, "the most glorious building," of Mentuhotep II. is at Deir el Bahri, and the mud pyramid of one of the Antef kings is known at Thebes. In the XIIth Dynasty the pyramids, the "lofty and beautiful" of Amenemhat I. and "the bright" of Useratesen II., are known in inscriptions, while the pyramid of Senusert I. is at Lisht, that of Senusert II. is at Illahun, that of Senusert III. at Dahshur (N. brick), and the brick pyramid at Howara is of Amenemhat III., who built the adjoining temple.

Of the architectural peculiarities of some particular pyramids some notice must now be given. The pyramid of Medum (figs. 1, 2) was the first true pyramid. It was begun as a mastaba, AA, like other such tombs, such as that of King Neter-khet at Beyt Khalaf. This mastaba was then enlarged by heightening it and adding a coating, and this process, repeated seven times, resulted in a high stepped mass of masonry. Such had been made before, at the step pyramid of Saqqara; but for the first time it was now covered with one uniform slope of masonry from base to top, and a pyramid was the result. The chamber is peculiar for being entered by a vertical shaft in the floor. The great pyramid (fig. 3) of Gizeh (Khufu's) is very different in its internal arrangements from any other known. The pyramid covers upwards of 13 acres, and is about 150 ft. higher than St Paul's Cathedral. As compared with St Peter's, Rome, it covers an area which is as 29 to 11, or nearly three times as much, and it is 50 ft. higher. The greater number of passages and chambers, the high finish of parts of the work, and the accuracy of construction all distinguish it. The chamber which is most normal in its situation is the subterranean chamber; but this is quite unfinished, hardly more than begun. The upper chambers, called the "king's" and "queen's," were completely hidden, the ascending passage to them having been closed by plugging blocks, which concealed the point where it branched upwards out of the roof of the long descending passage. Another passage, which in its turn branches from the ascending passage to the queen's chamber, was also completely blocked up. The object of having two highly-finished chambers in the mass may have been to deceive the king and his co-regent (of whom there is some historical evidence) and there is very credible testimony to a sarcophagus having existed in the queen's chamber, as well as in the king's chamber. On the details of construction in the great pyramid it is needless to enter here; but it may be stated that the accuracy of work is such that the four sides of the base have only a mean error of six-tenths of an inch in length and 12 seconds in angle from a perfect square.

The second pyramid of Gizeh, that of Khafra, has two separate entrances (one in the side, the other in the pavement) and two



From Vyse's *Pyramids of Gizeh*.

FIG. 3.—Section of Great Pyramid.

¹ With respect to the construction of this and other pyramids, see Howard Vyse; on measurements of the inside of the great pyramid and descriptions, see Piazzi Smyth; and on measurements in general mechanical means, and theories, see Petrie.

chambers (one roofed with slabs, the other all rock-hewn), these chambers, however, do not run into the masonry, the whole bulk of which is solid so far as is known. This pyramid has a part of the original casing on the top; and it is also interesting as having the workmen's barracks still remaining at a short distance on the west side, long chambers capable of housing about 4000 men. The great bulk of the rubbish from the work is laid on the south side, forming a flat terrace level with the base, and covering a steep rock escarpment which existed there. The waste heaps from the great pyramid were similarly tipped out over the cliff on its northern side. Thus the rubbish added to the broad platform which set off the appearance of the pyramids; and it has remained undisturbed in all ages, as there was nothing to be got out of it. The third pyramid, that of Menkaura, was cased around the base with red granite for the sixteen lowest courses. The design of it has been enlarged at one bound from a small pyramid (such as those of the family of Khufu) to one eight times the size, as it is at present, the passages needed therefore to be altered. But there is no sign of gradual steps of enlargement: the change was sudden, from a comparatively small design to a large one. The basalt sarcophagus of this pyramid was ornamented with the panel decoration found on early tombs, unlike the granite sarcophagi of the two previous pyramids, which are plain. Unhappily it was lost at sea in 1838.

An additional interest belongs to the third pyramid (of Menkaura) owing to its chamber being ceiled with a pointed arch (fig. 4).

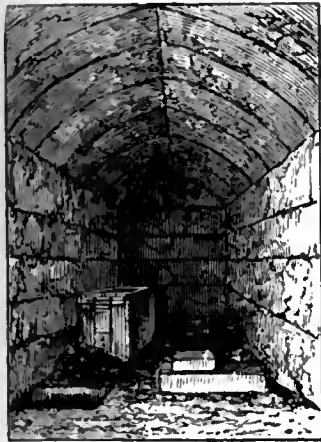

From Vyse.

FIG. 4.—Sepulchral Chamber, Third Pyramid.

But it is not a true arch, the stones being merely cantilevers opposite to each other, with the underside cut to the above form (see fig. 5).

Farther south are the pyramids of Abusir, described in the work of Colonel Howard Vyse, and since excavated by the Germans. Next come those of Saqqara. The construction of the step-pyramid or cumulative mastaba has been noticed above; its passages are very peculiar and intricate, winding around the principal chamber, which is in the centre, cut in the rock, very high, and with a tomb-chamber built in the bottom of it, which is closed with a great plug of red granite, a circular stopper fitting into a neck in the chamber roof. A doorway faced with glazed tiles bearing the name of King Neter-khet of the IIIrd Dynasty existed here;

the tiles were taken to Berlin by Lepsius. The other pyramids of Saqqara are those of Unas, Pepi, Haremsaf, &c. They are distinguished by the introduction of very long religious texts, covering the whole inside of the chambers and passages; these are carefully carved in small hieroglyphics, painted bright green, in the white limestone. Beyond these come the pyramids of Dahshur, which are in a simple and massive style, much like those of Gizeh. The north pyramid of Dahshur has chambers roofed like the gallery in the great pyramid by successive overlappings of stone, the roof rising to a great height, with no less than eleven projections on each side. The south pyramid of Dahshur has still the greater part of its casing remaining, and is remarkable for being built at two different angles, the lower part being at the usual pyramid angle, while the upper part is but 43°.

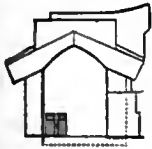

From Vyse.

FIG. 5.—Section of Sepulchral Chamber, Third Pyramid.

also remarkable for having a western passage to the chambers, which was carefully closed up. Beyond the Memphitic group are the scattered pyramids of Lisht (Senusert I.), Illahun (Senusert II.), and Howara (Amenemhat III.), and the earliest pyramid of Medum (Sneferu). Illahun is built with a framework of stone filled up with mud bricks, and Howara is built entirely of mud bricks, though cased with fine stone like the other pyramids.

The dimensions of the pyramids that are accurately known are in inches:—

Place.	King.	Date B.C.	Base.	Error.	Angle.	Height.	Azimuth.
Medum . . .	Sneferu	4750	5682.0	6.2	51° 52'	3619	24° 25' W.
Gizeh . . .	Khufu	4700	9068.8	.65	51° 52'	5776	3° 43' W.
"	Khafra	4600	8474.9	1.5	53° 10'	5664	5° 26' W.
"	Menkaura	4550	4153.6	3.0	51° 10'	2581	14° 3' E.
Dahshur S. . .	?	?	7459.0	3.7	43° 5' } 55° 1' }	4134	9° 12' W.
Dahshur Small .	?	?	2064.6	1.1	44° 34'	2034	10° 12' W.

The first two closely agree to the proportion of 7 high on 11 base, approximately the ratio of a radius to its circle. And on dividing the base at Medum by 11 the modulus is 515.64, and the base of Khufu ÷ 11 is 824.44. These moduli are 25 cubits of 20.625 and 40 cubits of 20.611; so it appears that the form was of the same type, but with moduli of 25 and 40 cubits respectively.

Beyond these already described there are no true pyramids, but we will briefly notice those later forms derived from the pyramid. At Thebes some small pyramids belong to the kings of the XIth Dynasty; the tomb-chamber is in the rock below. The size is under 50 ft. square. These are not oriented, and have a horizontal entrance, quite unlike the narrow pipe-like passages sloping down into the regular pyramids (see Mariette, in *Bib. arch. trans.* iv. 193). In Ethiopia, at Gebel Barkal, are other so-called pyramids of a very late date. They nearly all have porches; their simplicity is lost amid very dubious decorations; and they are not oriented. They are all very acute, and have flat tops as if to support some ornament. The sizes are but small, varying from 23 to 88 ft. square at Gebel Barkal and 17 to 63 ft. square at Meroc. The interior is solid throughout, the windows which appear on the sides being useless architectural members (see Hoskin's *Ethiopia*, 148, &c.). The structures sometimes called pyramids at Biahmu in the Fayum have no possible claim to such a name; they were two great enclosed courts with sloping sides, in the centres of which were two seated statues raised on pedestals high enough to be seen over the walls of the courts. This form would appear like a pyramid with a statue on the top; and a rather similar case in early construction is shown on the sculptures of the old kingdom. Obelisks then were single monuments (not in pairs) and stood in the midst of a great courtyard with sides sloping like a mastaba; such open courtyards on a small scale are found in the mastabas at Gizeh, and are probably copied from the domestic architecture of the time.

On the vexed question of inscriptions on the pyramids it will suffice to say that not one fragment of early inscription is known on the casing of any pyramid, either *in situ* or broken in pieces. Large quantities of travellers' "graffiti" doubtless existed, and some have been found on the casing of the great pyramid; these probably gave rise to the accounts of inscriptions, which are expressly said to have been in many different languages.

The mechanical means employed by the pyramid-builders have been partly ascertained. The hard stones, granite, diorite and basalt were in all fine work sawn into shape by bronze saws set with jewels (either corundum or diamond), hollows were made (as in sarcophagi) by tubular drilling with tools like our modern diamond rock-drills (which are but reinvented from ancient sources, see *Engineering*, xxxvii. 282). The details of the questions of transport and management of the large stones remain still to be explained.

See Colonel Howard Vyse, *Operations at the Pyramids* (1840); Professor C. Piazzi Smyth, *Life and Work at the Great Pyramid* (1867); W. M. Flinders Petrie, *Pyramids and Temples of Gizeh*, (1883). (W. M. F. P.)

PYRAMIDION (diminutive of "pyramid"), an architectural term for the copper-gilt casing covering the apex of an obelisk, and generally extended to its upper termination of pyramidal form.

PYRAMUS AND THISBE, the hero and heroine of a Babylonian love-story told by Ovid (*Metam.* iv. 55-465). Their parents refused to consent to their union, and the lovers used to converse through a chink in the wall separating their houses. At last they resolved to flee together, and agreed to meet under a mulberry tree near the tomb of Ninus. Thisbe was the first to arrive, but, terrified by the roar of a lion, took to flight. In her haste she dropped her veil, which the lion tore to pieces with jaws stained with the blood of an ox. Pyramus, believing that she had been devoured by the lion, stabbed himself. Thisbe returned to the rendezvous, and finding her lover mortally wounded, put an end to her own life. From that time the fruit of the mulberry, previously white, was always black.

See G. Hart, *Die Ursprung und Verbreitung der Pyramus- und Thisbesage* (1889-1892).

PYRARGYRITE, a mineral consisting of silver sulphantimonite, Ag₃SbS₃, known also as dark red silver ore, an important source of the metal. It is closely allied to, and isomorphous with, the corresponding sulpharsenite known as proustite (*q.v.*) or light red silver ore. "Ruby silver" or red silver ore (German *Rotgültigerz*) was mentioned by G. Agricola in 1546, but the two species so closely resemble one another that they were not completely distinguished until chemical analyses of both were made by J. L. Proust in 1804.

Both crystallize in the ditrigonal pyramidal (hemimorphic-hemihedral) class of the rhombohedral system, possessing the same degree of symmetry as tourmaline. Crystals are perfectly developed and are usually prismatic in habit; they are frequently attached at one end, the hemimorphic character being then evident by the fact that the oblique striations on the prism faces are directed towards one end only of the crystal. Twinning according to several laws is not uncommon. The angles are nearly the same in the two species; the rhombohedral angle α' being $71^\circ 22'$ in pyrrargyrite and $72^\circ 12'$ in proustite. The hexagonal prisms of pyrrargyrite are usually terminated by a low hexagonal pyramid (310) or by a drusy basal plane. The colour of pyrrargyrite is usually greyish-black and the lustre metallic-adamantine; large crystals are opaque, but small ones and thin splinters are deep ruby-red by transmitted light, hence the name, from Gr. $\pi\upsilon\rho$ (fire) and $\alpha\rho\rho\upsilon\rho\varsigma$ (silver), given by E. F. Glocker in 1831. The streak is purplish-red, thus differing markedly from the scarlet streak of proustite and affording a ready means of distinguishing the two minerals. The hardness is 2½, and the specific gravity 5.85; the refractive indices and birefringence are very high, $\omega = 3.084$, $\epsilon = 2.881$. There is no very distinct cleavage and the fracture is conchoidal. The mineral occurs in metalliferous veins with calcite, argentiferous galena, native silver, native arsenic, &c. The best crystallized specimens are from St Andreasberg in the Harz, Freiberg in Saxony, and Guanajuato in Mexico. It is not uncommon in many silver mines in the United States, but rarely as distinct crystals; and it has been found in some Cornish mines.

Although the "red silver ores" afford a good example of isomorphism, they rarely form mixtures; pyrrargyrite rarely contains as much as 3% of arsenic replacing antimony, and the same is true of antimony in proustite. Dimorphous with pyrrargyrite and proustite respectively are the rare monoclinic species pyrostilpnite or fireblende (Ag_2SbS_2) and xanthoconite (Ag_2AsS_2): these four minerals thus form an isodimorphous group. (L. J. S.)

PYRAZINES, PIAZINES, or PARADIAZINES, in organic chemistry, a group of compounds containing a ring system composed of 4 carbon atoms and 2 nitrogen atoms, the nitrogen atoms being in the para position. The di- and tri-methyl derivatives are found in the fusel oil obtained by fermentation of beet-root sugar (E. C. Morin, *Comptes rendus*, 1888, 106, p. 360). They were first prepared synthetically by reducing the isonitrosoketones. They may also be prepared by the inner condensation of α -aminoaldehydes or α -aminoketones in the presence of a mild oxidizing agent, such as mercuric chloride or copper sulphate in boiling alkaline solution (L. Wolff, *Ber.*, 1893, 26, p. 1830; S. Gabriel, *ibid.* p. 2207); and by the action of ammonia on α -halogen ketonic compounds (W. Staedel and L. Rugheimer, *Ber.*, 1876, 9, p. 563; V. Meyer and E. Braun, *Ber.*, 1888, 21, p. 19). They are also formed when grape sugar is heated with ammonia or when glycerin is heated with ammonium chloride and ammonium phosphate (C. Stoehr, *Journ. prakt. Chem.*, 1895 (2), 51, p. 450; 1896 (2), 54, p. 481). They are feeble basic compounds which distil unchanged. They are mostly soluble in water and somewhat hygroscopic in character. Their salts are easily dissociated. They form characteristic compounds with mercuric and auric chlorides. Their alkyl derivatives readily oxidize to pyrazine carboxylic acids.

Pyrazine, $\text{C}_4\text{H}_4\text{N}_2$, crystallizes from water in prisms, which have a heliotrope odour. It melts at 55°C . and boils at 115°C . It may also be obtained by elimination of carbon dioxide from the pyrazine dicarboxylic acid formed when quinoxaline is oxidized with alkaline potassium permanganate (S. Gabriel). 2.5-Dimethylpyrazine, or ketine, $\text{C}_6\text{H}_2(\text{CH}_3)_2\text{N}_2$, is obtained by reducing isonitrosoacetone, or by heating glycerin with ammonium chloride and ammonium phosphate. It boils at 153°C .

Two classes of dihydropyrazines are known, namely the 1.4 and 2.3 dihydro-compounds, corresponding to the formulae II. and III., pyrazine being I.:

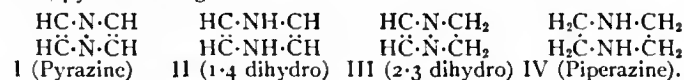

Those of the former type are obtained by condensing α -bromoketones with primary amines (A. T. Mason, *Journ. Chem. Soc.*, 1893, 63, p. 1355); the latter type result on condensing alkylene diamines with α -diketones. The 2.3 derivatives are somewhat unstable compounds, since on heating they readily give up two hydrogen atoms. *Tetrahydropyrazines* of the 1.2.3.4 type have also been obtained (L. Garzini, *Ber.*, 1891, 24, 956 R). *Hexahydropyrazine* or *piperazine* (formula IV. above), also known as diethylene diamine, may be prepared by reducing pyrazine, or, better, by combining aniline and ethylene bromide to form diphenyl diethylene diamine, the dinitroso compound of which hydrolyses to para-dinitrosophenol and piperazine.

It is a strong base, melting at 104° and boiling at 145° – 146° . It is used in medicine on account of the high solubility of its salt with uric acid.

PYRAZOLES, in organic chemistry, a series of heterocyclic compounds containing a five-membered ring consisting of three carbon atoms united to two nitrogen atoms, thus: the derivatives are orientated from the imino group, the second position being at the other nitrogen atom. *Pyrazole*, $\text{C}_3\text{H}_4\text{N}_2$, was obtained by E. Buchner (*Ber.*, 1889, 22, p. 2165) by heating pyrazole 3.4.5-tricarboxylic acid; and by L. Balbiano (*Ber.*, 1890, 23, p. 1103), who condensed epichlorhydrin with hydrazine hydrate in the presence of zinc chloride:

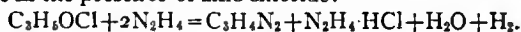

It may also be prepared by the union of diazomethane with acetylene (H. v. Pechmann, *Ber.*, 1897, 31, p. 2950), and by warming the acetal of propargyl aldehyde with an aqueous solution of hydrazine sulphate (*Ber.*, 1903, 36, p. 3662). It crystallizes in colourless needles, is very stable and behaves as a weak base. It does not combine with the alkyl iodides. Ammoniacal silver nitrate gives a precipitate of pyrazole silver.

The homologues of pyrazole may be obtained by digesting β -diketones or β -keto-aldehydes with phenylhydrazine; by heating the phenylhydrazones of some monoketones with acetic anhydride; by elimination of hydrogen from pyrazolones, and by distilling pyrazolones and pyrazolidones over zinc dust. They are all weak bases, which combine directly with the alkyl iodides and form double salts with mercuric and platinum chlorides. On oxidation with potassium permanganate the *C*-alkyl-derivatives give carboxylic acids, whilst the *N*-phenyl derivatives frequently split off the phenyl group (especially if it be amidated) and have it replaced by hydrogen. On reduction, the pyrazoles with a free :NH group are scarcely affected, whilst the *N*-phenyl derivatives give pyrazolines, or by the use of very strong reducing agents the ring is ruptured and trimethylenediamine derivatives are formed. They yield substitution derivatives with the halogens, bromine being the most effective. The chloro-derivatives are most readily prepared from the pyrazolones by the action of phosphorus oxychloride.

The pyrazole carboxylic acids may also be obtained by condensing β -diketone or oxymethylene ketone carboxylic esters with hydrazines, or the diazo fatty esters with acetylene dicarboxylic esters: $\text{N}_2\text{CH}\cdot\text{CO}_2\text{R} + \text{C}_2(\text{CO}_2\text{R})_2 = \text{C}_3\text{HN}_2(\text{CO}_2\text{R})_{3[3.4.5]}$; by heating β -diketones and diazo-acetic ester with sodium hydroxide (A. Klages, *Ber.*, 1903, 36, p. 1128), and from the diazo-anhydrides of β -diketones or β -ketoic acids. These acids all split CO_2 readily when heated, most easily from the carboxyl group in position 3, and with most difficulty from the group in position 4.

The *dihydropyrazoles* or *pyrazolines* are less stable than the pyrazoles and are more like unsaturated compounds. They may be obtained by the reduction of pyrazoles (especially *N*-phenyl derivatives) with sodium in alcoholic solution; by condensing diazo-acetic ester or diazomethane with ethylenic compounds (fumaric ester, &c.) (E. Buchner, *Ber.*, 1890, 23, p. 703; *Ann.*, 1895, 284, p. 212; H. v. Pechmann, *Ber.*, 1894, 27, p. 1891), and by rearrangement of the hydrazones of α -olefine aldehydes or ketones on warming or on distillation. They are weak bases which are only soluble in concentrated acids. On reduction they yield pyrazolidines, or the ring is broken; and when oxidized they form blue or red colouring matters. The carboxylic acids show a remarkable behaviour on heating, the nitrogen is entirely eliminated, and trimethylene carboxylic acids are obtained (see POLYMETHYLENES). Pyrazoline is a colourless liquid which boils at 144°C . It may be prepared by the action of diazomethane on ethylene (E. Azzarello, *Gazz.*, 1906, 36, (i), p. 628).

The *pyrazolones* (ketodihydropyrazoles), first prepared by L. Knorr in 1883, result from the elimination of the elements of alcohol from the hydrazones of β -ketoic acids; or on the oxidation of the pyrazolidones with ferric chloride. Three types are possible with the formulae:

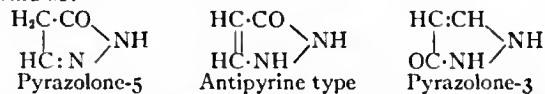

They form salts with both acids and bases, and yield benzylidine and isonitroso derivatives. Pyrazolone is obtained by the condensation of hydrazine with formylacetic ester. It is a colourless crystalline solid which melts at 164°C . 1-Phenyl-3-methylpyrazolone-5 is antipyryne (*q.v.*). The isomeric 1-phenyl-5-methylpyrazolone-3 is formed by condensing aceto-acetic ester with acetophenylhydrazine in the presence of phosphorus oxychloride, or by the action of ferric chloride on the corresponding pyrazolidone, which is produced by condensing phenylhydrazine with a β -halogen butyric acid. When methylated it yields *isoantipyryne*, an isomer of antipyryne, which is more poisonous.

The pyrazolidines are tetrahydropyrazoles. The *N*-phenyl derivative, from sodium phenylhydrazine and trimethylene bromide, is an oil which readily oxidizes to phenylpyrazoline on exposure. The corresponding keto-derivatives, or *pyrazolidones*, are produced by the action of hydrazines on the β -haloid acids or $\alpha\beta$ -olefine dicarboxylic acids. Isomeric compounds may arise here when phenylhydrazine is used, the keto-group taking either the 3 or 5 position; thus with β -iodopropionic acid 1-phenylpyrazolidone-5 is formed, whilst potassium β -iodopropionate gives the 3-compound. Isomers of this type may be distinguished by the fact that the pyrazolidone-5 compounds are basic, whilst the 3-compounds are acidic. The simplest member of the series, pyrazolidone-5, is a liquid which is formed by the action of hydrazine on acrylic acid. The 3-5-pyrazolidones are the cyclic hydrazides of the malonic acid series.

Thiopyrazoles have been obtained by A. Michaelis (*Ann.*, 1904, 331, p. 197; *Ber.*, 1904, 37, p. 2774) by the action of an aqueous or alcoholic solution of the methyl chloride or iodide of phenylmethylchloropyrazole on a solution of an alkaline hydrosulphide into which carbon bisulphide has been passed; or by the action of sodium thiosulphate on antipyrine hydrochloride or a similar compound. The simplest member of the group is probably to be represented as

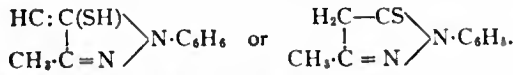

PYRENE, $\text{C}_{16}\text{H}_{10}$, a hydrocarbon found together with chrysene in the last portion of the coal tar distillate, and also in "Stupp" fat.

The crude solid product from the tar distillate is digested with carbon bisulphide to dissolve the pyrene, the solution filtered and the solvent evaporated. The residue is dissolved in alcohol and to the cold saturated solution a cold alcoholic solution of picric acid is added. The picrate so formed is then decomposed by ammonia. On its separation from "Stupp" fat see E. Bamberger and M. Philip, *Ann.*, 1887, 240, p. 161. It crystallizes in monoclinic tables which melt at 148–149° C. Chromic acid oxidizes it to pyrene quinone, $\text{C}_{16}\text{H}_8\text{O}_2$, and pyrenic acid, $\text{C}_{16}\text{H}_8\text{O}_6$. The *picrate*, which is easily soluble in benzene, crystallizes in long red needles melting at 222°. When heated with hydriodic acid and phosphorus to 200° C. it yields a hexahydride. It has been obtained synthetically by M. Freund and H. Michaels (*Ber.*, 1897, 30, p. 1383) by distilling thebenol over zinc dust in a stream of hydrogen, or by the action of hydriodic acid and phosphorus at 220° C. on thebenol.

PYRENEES [Span. *Pirinéos*, Fr. *Pyrenées*], a range of mountains in south-west Europe, separating the Iberian Peninsula from France, and extending for about 240 m., from the Bay of Biscay to Cape Creus, or, if only the main crest of the range be considered, to Cape Cerhère, on the Mediterranean Sea. For the most part the main crest constitutes the Franco-Spanish frontier; the principal exception to this rule is formed by the valley of Aran, which belongs orographically to France but politically to Spain. The Pyrenees are conventionally divided into

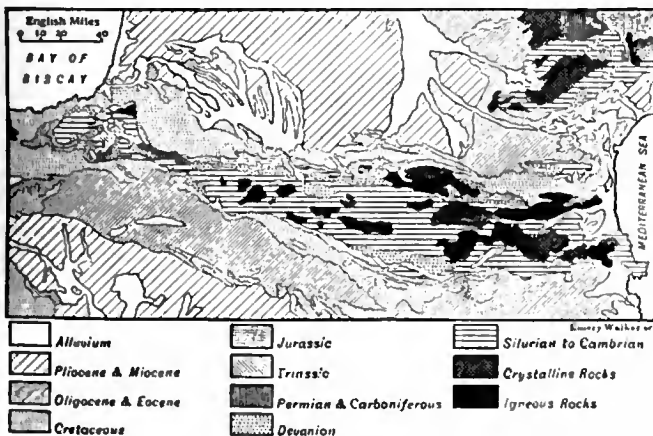

three sections, the central, the Atlantic or western, and the eastern. The central Pyrenees extend eastward from the Port de Canfranc to the valley of Aran, and include the highest summits of the whole chain, Aneto or Pic de Néthou (11,168 ft.), in the Maladetta ridge, Posets (11,047 ft.), and Mont Perdu or Monte Perdido (10,907 ft.). In the Atlantic Pyrenees the average altitude gradually diminishes westward; while in the eastern Pyrenees, with the exception of one break at the eastern

extremity of the Pyrénées Ariégeoises, the mean elevation is maintained with remarkable uniformity, till at last a rather sudden decline occurs in the portion of the chain known as the Albères. This threefold division is only valid so far as the elevation of the Pyrenean chain is concerned, and does not accurately represent its geological structure or general configuration. The careful examination of the chain by members of the English and French Alpine Clubs has since 1880 considerably modified the views held with respect to its general character; the southern versant, formerly regarded as inferior in area, has been proved to be the more important of the two. It has been recognized, as shown in the maps of MM. Schrader, de St Sand and Wallon, that, taken as a whole, the range must be regarded, not as formed on the analogy of a fern-frond or fish-bone, with the lateral ridges running down to the two opposite plains, but rather as a swelling of the earth's crust, the culminating portion of which is composed of a series of primitive chains, which do not coincide with the watershed, but cross it obliquely, as if the ground had experienced a sidewise thrust at the time when the earth's crust was ridged up into the long chain under the influence of contraction. Both the orderly arrangement of these diagonal chains and the agreement which exists between the tectonic and geological phenomena are well shown in the geological and hypsometrical maps published in the *Annuaire du Club Alpin français* for 1891 and 1892 by MM. Schrader and de Margerie. The primitive formations of the range, of which little beyond the French portions had previously been studied, are shown to be almost all continued diagonally on the Spanish side, and the central ridge thus presents the appearance of a series of wrinkles with an inclination (from north-west to south-east) greater than that of the chain as a whole. Other less pronounced wrinkles run from south-west to north-east and intersect the former series at certain points, so that it is by alternate digressions from one to the other series that the irregular crest of the Pyrenees acquires its general direction. Far from having impressed its own direction on the orientation of the chain at large, this crest is merely the resultant of secondary agencies by which the primitive mass has been eroded and lessened in bulk, and though its importance from a hydrographic point of view is still considerable, its geological significance is practically nil.

Geology.—The Pyrenees are divided by E. de Margerie and F. Schrader into a number of longitudinal zones. The central zone consists of Primary rocks, together with great masses of granite. It forms most of the higher summits, but west of the Pic d'Anie it disappears beneath an unconformable covering of Cretaceous deposits. On the French side the central zone is followed by (1) the zone of Ariège, consisting of Lower Cretaceous and Jurassic beds, together with granitic masses; (2) the zone of the Petites Pyrénées, Upper Cretaceous and Eocene; and (3) the zone of the Corbières, consisting of Eocene and Primary rocks. On the Spanish side, from north to south, are (1) the zone of Mont Perdu, Upper Cretaceous and Eocene; (2) the zone of Aragon, Eocene; and (3) the zone of the Sierras, Trias, Cretaceous and Eocene. In France the zones are clearly defined only in the eastern part of the chain, while towards the west they merge into one another. In Spain, on the other hand, it is in the central part of the chain that the zones are most distinct. Although the number of zones recognized is the same on the two flanks, they do not correspond. The zone of the Corbières has no equivalent in Spain, while in France there is no definite zone of Eocene like that of Aragon. The zone of the Petites Pyrénées, however, is clearly homologous with that of the Sierras. On the northern side granitic masses occur in the zone of Ariège amongst the Jurassic and Lower Cretaceous beds. On the southern side they are not found except in the axial zone, and the Jurassic and Lower Cretaceous deposits are reduced to a narrow band. In spite of these differences between the two flanks, the structure is to some extent symmetrical. On the north the greater number of the overfolds lean towards the north, while on the south they lean towards the south. Thus the chain shows the typical fan-structure which has long been recognized in the western Alps.

Since the publication of the maps by de Margerie and Schrader it has been shown that the phenomena of "recouvrement" play almost as large a part in the Pyrenees as in the Alps themselves. Large masses of rock have been brought upon nearly horizontal faults (thrust-planes) over the edges of either beds with which they originally had no connexion. In the region of Salies-du-Salat, for example, patches of Trias lie discordantly upon the edges of the Cretaceous and Tertiary beds. Several other similar cases

have been described; but denudation has been carried further than in the western Alps, and accordingly the masses overlying the thrust-planes have been more completely removed (q.v.).

The earth movements which raised the Pyrenees appear to have begun in the Eocene period, but it was in Oligocene times that the principal folding took place. The Pyrenees are therefore contemporaneous with the Alps; but they appear to have escaped the Miocene disturbances which affected the latter.

The arrangement of the Pyrenees in chains gently inclined near the centre but longitudinal everywhere else, is illustrated by the courses of the streams which flow down towards Spain. On the French side most of the longitudinal valleys have disappeared; and this is why the range has so long been described as sending out transverse spurs, the more important slope remaining unknown. It is, however, still possible to distinguish some traces of this formation towards the east, where atmospheric denudation has been less active. On the south the principal streams, after cutting their way through the highest zone at right angles to the general direction of the range, become involved half-way to the plains in great longitudinal folds, from which they make their escape only after traversing long distances without finding an outlet.

The importance shown to attach to the Spanish versant has greatly modified the values formerly assigned to the area and mean elevation of the Pyrenees. Instead of the 13,440 sq. m. formerly put down for the total, M. Schrader found the area to be 21,044 sq. m. Of this total 6390 sq. m. fall to the northern slope and 14,654 sq. m., i.e. more than double, to the southern, the difference being mainly due to the zone of plateaux and sierras. The mean elevation, estimated by Élie de Beaumont at 1500 metres (4900 ft.), has been sensibly diminished by the addition of that zone to the system, and it must now be placed at only 1200 metres (3930 ft.) for the range as a whole; so important a part is played by the above-mentioned plateaux of small elevation in a chain whose highest summit reaches 11,168 ft., while the passes show a greater altitude than those of the Alps.

Four conspicuous features of Pyrenean scenery are the absence of great lakes, such as fill the lateral valleys of the Alps; the rarity and great elevation of passes; the large number of the mountain torrents locally called *gaves*, which often form lofty waterfalls, surpassed in Europe only by those of Scandinavia; and the frequency with which the upper end of a valley assumes the form of a semicircle of precipitous cliffs, locally called a *cirque*. The highest waterfall is that of Gavarnie (1515 ft.), at the head of the Gave de Pau; the Cirque de Gavarnie, in the same valley, is perhaps the most famous example of the cirque formation. Not only is there a total lack of those passes, so common in the Alps, which lead across the great mountain chains at a far lower level than that of the neighbouring peaks, but between the two extremities of the range, where the principal highroads and the only railways run between France and Spain, there are only two passes practicable for carriages—the Col de la Perche, between the valley of the Tet and the valley of the Segre, and the Col de Somport or Pot de Canfranc, on the old Roman road from Saragossa to Oloron.

Projects for further railway construction, including the building of tunnels on a vast scale, have been approved by the French and Spanish governments (see SPAIN: Communications).

The metallic ores of the Pyrenees are not in general of much importance, though there are considerable iron mines at Vic de Sos in Ariège and at the foot of Canigou in Pyrénées-Orientales. Coal deposits capable of being profitably worked are situated chiefly on the Spanish slopes but the French side has numerous beds of lignite. Mineral springs are abundant and very remarkable, and specially noteworthy are the hot springs, in which the Alps, on the contrary, are very deficient. The hot springs, among which those of Bagnères de Luchon and Eaux-Chaudes may be mentioned, are sulphurous and mostly situated high, near the contact of the granite with the stratified rocks. The lower springs, such as those of Bagnères de Bigorre (Hautes-Pyrénées), Rennes (Aude) and Campagne (Aude), are mostly selenitic and not very warm.

The amount of the precipitation, including rain and snow, is much greater in the western than in the eastern Pyrenees, which leads to a marked contrast between these sections of the chain in more than one respect. In the first place, the eastern Pyrenees are without glaciers, the quantity of snow falling there being insufficient to lead to their development. The glaciers are confined to the northern slopes of the central Pyrenees, and do not descend, like those of the Alps, far down in the valleys,

but have their greatest length in the direction of the mountain-chain. They form, in fact, a narrow zone near the crest of the highest mountains. Here, as in the other great mountain ranges of central Europe, there are evidences of a much wider extension of the glaciers during the Ice age. The case of the glacier in the valley of Argelès in the department of Hautes-Pyrénées is the best-known instance. The snow-line varies in different parts of the Pyrenees from 8800 to 9200 ft. above sea-level.

A still more marked effect of the preponderance of rainfall in the western half of the chain is seen in the aspect of the vegetation. The lower mountains in the extreme west are very well wooded, but the extent of forest declines eastwards, and the eastern Pyrenees are peculiarly wild and naked, all the more since it is in this part of the chain that granitic masses prevail. There is a change, moreover, in the composition of the flora in passing from west to east. In the west the flora, at least in the north, resembles that of central Europe, while in the east it is distinctly Mediterranean in character, though the difference of latitude is only about 1°, on both sides of the chain from the centre whence the Cobières stretch north-eastwards towards the central plateau of France. The Pyrenees are relatively as rich in endemic species as the Alps, and among the most remarkable instances of that endemism is the occurrence of the sole European species of *Dioscorea* (yam), the *D. pyrenaica*, on a single high station in the central Pyrenees, and that of the monotypic genus *Xatardia*, only on a high alpine pass between the Val d'Eynes and Catalonia. The genus most abundantly represented in the range is that of the saxifrages, several species of which are here endemic.

In their fauna also the Pyrenees present some striking instances of endemism. There is a distinct species of ibex (*Capra pyrenaica*) confined to the range, while the Pyrenean desman or water-mole (*Mygale pyrenaica*) is found only in some of the streams of the northern slopes of these mountains, the only other member of this genus being confined to the rivers of southern Russia. Among the other peculiarities of the Pyrenean fauna are blind insects in the caverns of Ariège, the principal genera of which are *Anophthalmus* and *Adelops*.

The ethnology, folk-lore, institutions and history of the Pyrenean region form an interesting study: see ANDORRA; ARAGON; BASQUES; BEARN; CATALONIA; NAVARRE.

See H. Beraldi, *Cent ans aux Pyrénées* (1901), *Les Sierras, cent ans après Ramond* (1902), *Après cent ans. Les Pics d'Europe* (1903), and *Les Pyrénées orientales et l'Ariège* (1904); P. Joanne, *Pyrénées* (1905); H. Belloc, *The Pyrenees* (1909); for geology, in addition to the papers cited above, A. Bresson, *Études sur les formations des Hautes et Basses Pyrénées* (Paris, Ministère des Travaux Publics, 1903); L. Carez, *La Géologie des Pyrénées françaises* (Paris, Min. des Tr. P., 1903, &c.); J. Roussel, *Tableau stratigraphique des Pyrénées* (Paris, Min. des Tr. P., 1904); and for climate and flora T. Cook, *Handbook to the Health Resorts on the Pyrenees*, &c. (1905), and J. Bentham, *Catalogue des plantes indigènes des Pyrénées et de Bas-Languedoc* (1826).

PYRÉNÉES-ORIENTALES, a department of south-western France, bordering on the Mediterranean and the Spanish frontier, formed in 1790 of the old province of Roussillon and of small portions of Languedoc. The population, which includes many Spaniards, numbered 213,171 in 1906. Area, 1599 sq. m.

The department is bounded N. by Ariège and Aude, E. by the Mediterranean, S. by Catalonia and W. by the republic of Andorra. Its borders are marked by mountain peaks, on the north by the Corbières, on the north-west and south-west by the eastern Pyrenees, on the extreme south-east by the Albères, which end in the sea at Cape Cerbera. Spurs of these ranges project into the department, covering its whole surface, with the exception of the alluvial plain of Roussillon, which extends inland from the sea-coast. Deep and sheltered bays in the vicinity of Cape Cerbera are succeeded farther north by flat sandy beaches, along which lie lagoons separated from the sea by belts of sand. The lagoon of St Nazaire is 2780 acres in extent, and that of Leucate on the borders of Aude is 19,300 acres. Mont Canigou (9137 ft.), though surpassed in height by the Carlitte Peak (9583 ft.), is the most remarkable mountain in the eastern Pyrenees, since it stands out to almost its full height above the plain, and exhibits with great distinctness the succession of zones of vegetation. From the base to a height of 1400 ft. are found the orange, the aloe, the oleander, the pomegranate

and the olive; the vine grows to the height of 1800 ft.; next come the chestnut (2625 ft.), the rhododendron (from 4330 to 8330 ft.), pine (6400), and birch (6560); while stunted junipers grow to the summit.

The drainage of the department is shared by the Tet and the Tech, which rise in the Pyrenees, and the Agly, which rises in the Corbières. All three flow eastwards into the Mediterranean. The Aude, the Ariège (an affluent of the Garonne) and the Sègre (an affluent of the Ebro) also take their rise within the department and include a small part of it in their respective basins. The Tet rises at the foot of the Carlitte Peak and descends rapidly into a very narrow valley before it debouches at Ille (between Prades and Perpignan) upon the plain of Roussillon, where it flows over a wide pebbly bed and supplies numerous canals for irrigation. It is nowhere navigable, and its supply of water varies much with the seasons, all the more that it is not fed by any glacier. The Agly, which soon after its rise traverses the magnificent gorge of St Antoine de Galamus and, nearing its mouth, passes Rivesaltes (famous for its wines), serves almost exclusively for irrigation. The Tech, which after the Tet is the most important river of the department, flows through Vallespir (*vallis aspera*.) which, notwithstanding its name, is a green valley, clothed with wood and alive with industry; in its course the river passes Prats de Mollo and Arles-sur-Tech, before reaching Amélie-les-Bains and Céret. In the lowlands the climate is that of the Mediterranean, characterized by mild winters, dry summers and short and sudden rain-storms. Amélie-les-Bains is much frequented on account of its mild climate and sheltered position. The thermometer ranges from 85° to 95° F. in summer, and in winter only occasionally falls as low as 26° or 27°. The mean amount of the rainfall is 27 in. on the coast, but increases towards the hills. The most common wind is the *tramontane* from N.N.W., as violent as the mistral of Provence and extremely parching. The *marinada* blows from the S.S.E.

The cultivated land in Pyrénées-Orientales is devoted to wine-growing, market-gardening and fruit culture, the production of cereals being comparatively unimportant. The main source of wealth to the department is its wine, of which some kinds are strongly alcoholic and others are in request as liqueur wines (Rivesaltes, Banyuls). The cultivation of early vegetables (artichokes, asparagus, tomatoes, green peas), which is specially flourishing in the irrigated lowlands, and fruit-growing (peaches, apricots, plums, pears, quinces, pomegranates, almonds, apples, cherries, walnuts, chestnuts), which is chiefly carried on in the river valleys, yield abundant returns. The woods produce timber for the cabinet-maker, cork, and bark for tanning. Large flocks of sheep feed in the pastures of the Pyrenees and Corbières; the keeping of silkworms and bees is also profitable. In iron Pyrénées-Orientales is one of the richest departments in France, the greater part of the ore being transported to the interior. Lignite and various kinds of stone are worked. The mineral waters are much resorted to. Amélie-les-Bains has hot springs, chalybeate or sulphurous. In the arrondissement of Céret there are also the establishments of La-Preste-les-Bains, near Prats de Mollo, with hot sulphurous springs, and of Le Boulou, the Vichy of the Pyrenees. Near Prades are the hot sulphurous springs of Molitg, and a little north of Mont Canigou are the hot springs of Vernet, containing sodium and sulphur. In the valley of the Tet the sulphurous and alkaline springs of Thuès reach a temperature of 172° F. The baths of Les Escaldas, near Montlouis, are hot, sulphurous and alkaline. There are oil-works and sawmills, and the manufactures of the department include the making of whip-handles, corks, cigarette paper, barrels, bricks, woollen and other cloths, and *espadrilles* (a kind of shoe made of coarse cloth with esparto soles). Of the ports of the department Port Vendres alone has any importance. Imports include timber, Spanish and Algerian wine, cereals, coal; among the exports are wine, timber, vegetables, fruit, honey, oil and manufactured articles. The department is served by the Southern railway. The chief route across the Pyrenees is from Perpignan by way of Montlouis, a fortified place, to Puigcerda, in the Spanish province of Gerona, through the pass of La Perche, skirting in the French department an enclave of Spanish territory. Three other roads run from Perpignan to Figueras through the passes of Perthus (defended by the fort of Bellegarde), Banyuls and Balistres, the last-named being traversed by a railway. The chief towns of the three arrondissements are Perpignan, Céret and Prades; there are 17 cantons and

232 communes. The department constitutes the diocese of Perpignan, and is attached to the appeal court and the academy of Montpellier and to the region of the XVI. army corps, of which Perpignan is the headquarters.

Perpignan, the capital town and a fortress of the first class, Amélie-les-Bains and Elne are the more noteworthy places, and are treated separately. Rivesaltes (5448) is the most populous town after Perpignan. Other places may be mentioned. Planès has a curious church, triangular in shape, and of uncertain date. Popular tradition ascribes to it a Moslem origin. The church and cloister at Arles-sur-Tech are also of the 12th century. Boule-d'Amont has a Romanesque church which once belonged to the Augustine abbey of Serrabona. It is peculiar in that its aisles open out into lateral porches, instead of communicating with the nave. The church of Casteil, which is of the 11th century, is a relic of the ancient abbey of St Martin de Canigou. At St Michel-de-Guxa, near Prades, are fine ruins of a Benedictine abbey. The hamlet of Fontromeu, near Odeillo, has a chapel with a statue of the Virgin, which is visited by numerous pilgrims.

PYRETHRUM. The pyrethrum or "feverfew" (nat. ord. Compositae), now regarded as a section of the genus *Chrysanthemum*, flowers in the early summer months, and is remarkable for its neat habit and the great variety of character and colour which it presents. The type form is the Caucasian species *P. roseum* of botanists, hardy perennial, with finely cut leaves and large flower heads, having a ray of deep rose-coloured ligulate florets surrounding the yellow centre or disk. They bloom during the months of May and June, as well as later, and are always most welcome ornaments for the flower borders, and useful for cutting for decorative purposes. There are now many excellent varieties, both single and double-flowered, in cultivation.

The pyrethrum grows best in soil of a loamy texture; this should be well manured and deeply trenched up before planting, and should be mulched in the spring by a surface dressing of half-decayed manure. The plants may be increased by division, the side shoots being taken off early in spring rather than in autumn, with a portion of roots attached. Plants disturbed in autumn frequently die during the winter. They may be placed either in separate beds or in the mixed flower border as may be required. In beds they can be supplemented as the season passes on by the intermixture of later blooming subjects, such as gladioli. Slugs are often destructive to the young shoots, but may be checked by a few sprinklings of soot or lime. Seeds should be sown in spring in a cold frame, and the young plants should be put out into beds when large enough, and should flower the following May. New varieties are being constantly introduced; the reader is referred to the catalogues of nurserymen for named kinds. The powdered root of *P. roseum* and other species is used in the manufacture of insect powders. *P. parthenifolium* var. *aureum* is the "golden-feather" of gardens, so much employed as an edging to flower-beds. *P. parthenium*, pellitory or "feverfew," was formerly used in medicine. Its double-flowered form is well worth growing. *P. uliginosum* is the "great ox-eye daisy" that flowers in September and October.

PYRGI (mod. S. SEVERA), an ancient town of Etruria, Italy, on the south-west coast, 9 m. W.N.W. of Caere. The name is Greek (*πύργοι*, towers), and the place of considerable antiquity. Remains of its defensive walls exist in polygonal blocks of limestone and sandstone, neatly jointed. They enclosed a rectangular area some 200 yds. in width and at least 220 yds. in length. The south-west extremity has probably been destroyed by the sea. It contained a rich temple of Leucothea, the foundation of which was ascribed to the Pelasgi. It was plundered by Dionysius in 384 B.C. Later it became dependent on Caere, though it is not probable that it was originally merely the harbour of Caere; Alsium (q.v.) is a good deal nearer (5 m. south). The Romans planted a colony here, which is first mentioned in 191 B.C. Later still it supplied fish to the capital, and became a favourite summer resort, as did also Punicum (S. Marinella) 5 m. to the north-west, where are many remains of villas. Both were stations on the coast road (Via Aurelia).

See H. Dennis, *Cities and Cemeteries of Etruria*, i. 289. (London 1883). (T. As.)

PYRGOS, a town of Greece, in the province of Elis and Achaëa, 43 m. S.S.W. of Patras. It is the third town in importance in the Peloponnesus, and is connected with its harbour, Katakolon, $7\frac{1}{2}$ m. distant, and also with Patras and Olympia, by rail. It has frequently been injured by earthquakes. Pop. (1907), 13,690.

PYRIDINE, C_5H_5N , an organic base, discovered by T. Anderson (*Trans. Roy. Soc. Edin.*, 1851, 20, p. 251) in bone oil. It is also found among the distillation products of bituminous coal, lignite, and various shales, and has been detected in fusel oil and crude petroleum. It is a decomposition product of various alkaloids (nicotine, sparteine, cinchonine, &c.), being formed when they are strongly heated either alone or with zinc dust. It may be synthetically prepared by distilling allyl ethylamine over heated lead oxide (W. Königs, *Ber.*, 1879, 12, p. 2341) by passing a mixture of acetylene and hydrocyanic acid through a red-hot tube (W. Ramsay, *Ber.*, 1877, 10, p. 736); by heating pyrrol with sodium methylate and methylene iodide to 200° C. (M. Dennstedt and J. Zimmermann, *Ber.*, 1885, 18, p. 3316); by heating isoamyl nitrate with phosphorus pentoxide (E. T. Chapman and M. H. Smith, *Ann.*, 1868, *Suppl.* 6, p. 329); and by heating piperidine in acetic acid solution with silver acetate (J. Tafel, *Ber.*, 1892, 25, p. 1619). The amount of pyridine produced in most of these processes is very small, and the best source for its preparation is the "light-oil" fraction of the coal-tar distillate. The basic constituents are removed by dilute sulphuric acid, the acid layer removed, and the bases liberated by alkali, separated, dried, and fractionally distilled.

Pyridine is a colourless liquid of a distinctly unpleasant, penetrating odour. It boils at 114.5° C., and is miscible with water in all proportions. It is a tertiary base, and combines readily with the alkyl halides to form pyridinium salts. Nascent hydrogen reduces it to piperidine, $C_5H_{11}N$ (see below), whilst hydriodic acid above 300° C. reduces it to *n*-pentane (A. W. Hofmann, *Ber.*, 1883, 16, p. 590). It is a very stable compound, chromic and nitric acids being without action upon it, whilst the halogens only yield substitution derivatives with difficulty. It reacts with sulphuric acid only at high temperatures, yielding a sulphonic acid. It forms addition compounds with mercuric and auric chlorides. On the constitution of the pyridine nucleus, see Körner, *Gior. dell' acad. di Palermo*, 1869, and C. Riedel, *Ber.*, 1883, 16, p. 1609. As regards the isomerism of the pyridine substitution products, three mono-derivatives are known, the different positions being indicated by the Greek

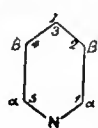

letters α , β and γ , as shown in the inset formula. This formula also allows of the existence of six di-derivatives, six tri-derivatives, three tetra- and one penta-derivative, when the substituent groups are identical; all of which are in agreement with known facts.

The three monochlorpyridines are known, the α and γ compounds resulting from the action of phosphorus pentachloride on the corresponding oxy-pyridines, and the β compound from the action of chloroform on potassium pyrrol. *α -Aminopyridine*, $C_5H_4N \cdot NH_2$, is formed by heating 5-aminopyridine-2-carboxylic acid. It is a crystalline solid which melts at 56° C. and boils at 204° C. It can only be diazotized in the presence of concentrated sulphuric acid, and even then the free diazonium sulphate is not stable, readily passing in the presence of water to α -oxy-pyridine. *β -Aminopyridine* is obtained by heating β -pyridyl urethane with fuming hydrochloric acid until no more carbon dioxide is liberated (T. Curtius and E. Mohr, *Ber.*, 1898, 31, p. 2493), or by the action of bromine and caustic soda on the amide of nicotinic acid (F. Pollak, *Monats.*, 1895, 16, p. 54). It melts at 64° C. and boils at 250 – 252° C. The aminopyridines are readily soluble in water, and resemble the aliphatic amines in their general chemical properties.

The *oxy-pyridines* may be prepared by distilling the corresponding oxy-pyridine carboxylic acids with lime, or by fusing the pyridine carboxylic acids with caustic potash. The mono-oxy-pyridines are easily soluble in water and possess only feeble basic properties. The β compound is hydroxylic in character, whilst the α and γ derivatives behave frequently as if they possess the tautomeric keto-structure, yielding according to the conditions of the experiment either *N*- or *O*-ethers (H. v. Pechmann, *Ber.*, 1895, 28, p. 1624), thus corresponding to the formulæ—

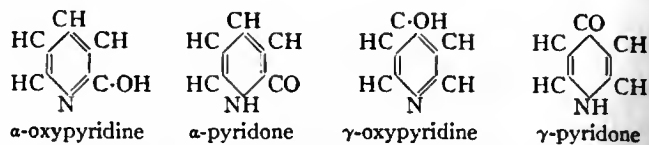

The homologues of pyridine may be synthesized in various ways. One of the most important is the so-called "collidine" synthesis of A. Hantzsch (*Ann.*, 1882, 215, p. 1; *Ber.*, 1882, 15, p. 2914) which consists in the condensation of two molecules of aceto-acetic ester with one of an aldehyde and one of ammonia:—



The resulting dihydro-compound is then oxidized with nitrous acid, the ester hydrolysed and the resulting acid heated with lime; carbon dioxide is eliminated and a trisubstituted pyridine of the type is obtained. The reaction is apparently a general one for all aldehydes. On the course of the reaction see also C. Beyer, *Ber.*, 1891, 24, p. 1662, and E. Knoevenagel, *Ber.*, 1898, 31, p. 738. In this reaction the proportions of aldehyde and aceto-acetic ester may be interchanged and $\alpha\gamma$ disubstituted pyridines are then obtained. Of the other methods for preparing pyridine homologues mention may be made of the discovery by A. Ladenburg that the pyridinium alkyl iodides rearrange themselves when strongly heated and yield α and γ alkyl pyridines (*Ber.*, 1883, 16, p. 1410 seq.; *Ann.*, 1888, 247, p. 1). S. Ruhemann prepared γ -substituted dioxypyridines by condensing alkyl-dicarboxy-glutaconic esters with ammonia.

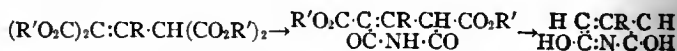

M. Scholtz (*Ber.*, 1895, 28, p. 1726) prepared $\alpha\alpha$ -methylphenyl-pyridine by distilling cinnamylidene acetoxime,

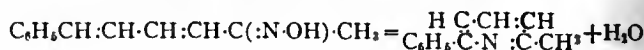

The 1.5 diketones of the type inset, when heated with ammonia, also yield pyridine derivatives. Alkyl pyridines are also obtained by heating aldehyde ammonias alone or with aldehydes and ketones (A. v. Baeyer, *Ann.*, 1870, 155, pp. 281, 294; J. Plöchl, *Ber.*, 1887, 20,

p. 722).

The subjoined table shows the chief homologues of pyridine:—

Name.	Formula.	Position of Substituent.	Remarks.
<i>Picolines</i>	$C_6H_4(CH_3)N$	α	Liquid, b.p. 129° . Oxidizes to picolinic acid. Condenses readily with aldehydes.
		β	Liquid, b.p. 143° . Oxidizes to nicotinic acid. Does not condense with aldehydes.
<i>Lutidines</i>	$C_6H_4(C_2H_5)N$	γ	Liquid, b.p. 144 – 145° .
		α, β, γ	Three isomers. All liquids. The β compound is a decomposition product of cinchonine, quinine, strychnine and brucine.
<i>Collidines</i>	$C_6H_3(CH_3)_2N$	$\alpha\alpha', \alpha\gamma, \alpha\beta'$	Five isomers. All liquids.
	$C_6H_4(C_2H_5)_2N$	$\beta\beta', \beta\gamma$	Liquids. The α compound is a decomposition product of conine. Both contain the normal propyl group.
		α, β	Containing the isopropyl group.
	$C_6H_3(CH_3)(C_2H_5)N$	$\alpha', \alpha\gamma, \alpha\beta'$	Liquids.
$C_6H_2(CH_3)_3N$	$\alpha\gamma\alpha'$	Liquid, b.p. 171 – 172° . Prepared by the Hantzsch synthesis.	
		$\alpha\gamma\beta'$	Found in coal-tar.

Pyridine carboxylic acids are usually prepared by oxidizing the homologues of the base; they also result as decomposition products of various alkaloids. The more important are shown in the table.

Name.	Formula.	Position of Substituent.	Remarks.
Picolinic acid.	$C_6H_4(CO_2H)N$	α	M.p. 137°. Easily soluble in water. Yellow coloration with $FeSO_4$. Position of carboxyl group determined by synthesis from α -naphthylamine (Z. Skraup and A. Cobenzl, <i>Monats.</i> , 1883, 4, p. 436).
Nicotinic acid.	$C_6H_4(CO_2H)N$	β	M.p. 228-229°. An oxidation product of nicotine, hydrastine and berberine. Constitution determined by synthesis from β -naphthylamine (Skraup).
Quinolinic acid.	$C_8H_5(CO_2H)_2N$	$\alpha\beta$	M.p. 192-195° with decomposition into nicotinic acid. Formed by oxidation of quinoline.
Cinchomeric acid.	$C_8H_7(CO_2H)_2N$	$\beta\gamma$	M.p. 258-259°. Formed by oxidation of quinine, cinchonine, and of isoquinoline.
α -Carbo-cinchomeric acid.	$C_8H_7(CO_2H)_2N$	$\alpha\beta\gamma$	M.p. 249-250°. Crystallizes with $\frac{1}{2}H_2O$. An oxidation product of cinchonine, quinine and papaverine.
Berberonic acid.	$C_8H_7(CO_2H)_2N$	$\alpha\gamma\beta'$	M.p. 243°. An oxidation product of berberine. Gives a red coloration with $FeSO_4$. Boiling with glacial acetic acid gives cinchomeric acid.

Trigonelline, $C_7H_7NO_2$, the methyl betaine of nicotinic acid, was discovered in 1885 by E. Jahns (*Ber.*, 1885, 18, p. 2518), and is found in the seeds of *Trigonella* and *Strophanthus hispidus*. It is very soluble in water. With baryta it yields methylamine, and when heated with concentrated hydrochloric acid to 260° C. it yields methyl chloride and nicotinic acid. It was synthesized by A. Hantzsch (*Ber.*, 1886, 19, p. 31) by condensing methyl iodide and potassium nicotinate at 150° C. the resulting iodide being then decomposed by moist silver oxide. A. Pictet (*Ber.*, 1897, 30, p. 217) obtained it by oxidizing nicotine methyl hydroxide with potassium permanganate. *Apophyllenic acid*, $C_8H_7NO_4 \cdot H_2O$, the methyl betaine of cinchomeric acid, was synthesized by W. Roser (*Ann.*, 1886, 234, p. 118).

Piperidine or hexa-hydropyridine, $C_5H_{11}N$, was first obtained in 1848 by distilling piperine with lime. It is formed in the hydrolysis of piperine by alcoholic potash, by the reduction of trimethylene cyanide (A. Ladenburg) and by the action of alkalis on ϵ -chloramylamine, $Cl(CH_2)_5NH_2$ (S. Gabriel, *Ber.*, 1892, 25, p. 421). It is also produced in the electrolytic oxidation of *N*-nitroso piperidine in sulphuric acid solution (F. B. Ahrens, *Ber.*, 1898, 31, p. 2275). It is a liquid which boils at 105-106° C., and possesses an ammoniacal smell. It is readily soluble in water, alcohol and ether, and is a very powerful base. It is oxidized to pyridine by heating with concentrated sulphuric acid to 300° C., or with nitrobenzene to 250° C., or with silver acetate to 180° C. Being an imide it readily yields a nitroso derivative, and *N*-alkyl and acetyl derivatives. The piperidine ring is easily split. When heated with fuming hydriodic acid to 300° C. it yields normal pentane and ammonia, and hydrogen peroxide oxidizes it to glutarimide and to a piperidinium oxide or oxime (R. Wolfenstein, *Ber.*, 1904, 37, p. 3228). A. W. Hofmann (*Ber.*, 1881, 14, p. 660), by a process of exhaustive methylation and distillation, obtained the unsaturated hydrocarbon *piperylene*, $CH_2:CH \cdot CH_2 \cdot CH : CH_2$, from piperidine (see also A. Ladenburg, *Ann.*, 1894, 279, p. 344).

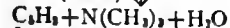
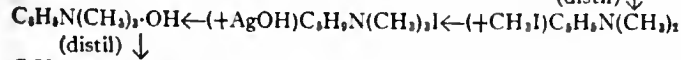
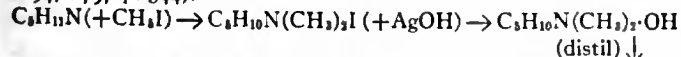

J. v. Braun (*Ber.*, 1904, 37, p. 2915) showed that benzoyl piperidine, when heated with phosphorus pentachloride to 200° C. in sealed tubes, yields benzonitrile, and pentamethylene dichloride, thus leading to a simple method of preparing pentamethylene

compounds. At 125-130° C. the compound $C_6H_5C \cdot Cl : N(CH_2)_5 \cdot Cl$ is obtained; this with water yields benzoylamidochloramylamine, $C_6H_5CONH(CH_2)_5Cl$, which when heated with hydrochloric acid to 170-180° C. furnishes ϵ -chloramylamine, $NH_2(CH_2)_5Cl$. α -Propyl-piperidine is the alkaloid conine (*q.v.*).

PYRIMIDINES, METADIAZINES or MIAZINES, in organic chemistry, a series of heterocyclic compounds containing a ring complex, composed of four carbon atoms and two nitrogen atoms, the nitrogen atoms being in the meta-position. The oxyderivatives of the tetrahydro- and hexahydro-pyrimidines are the uracils and the ureides of malonic acid (see PURIN). The purins themselves may be considered as a combination of the pyrimidine and glyoxaline ring systems. For formulae see below; the numbers about the first ring explain the orientation of pyrimidine derivatives.

The pyrimidines may be obtained by condensing 1,3-diketones with the amidines (A. Pinner, *Ber.*, 1893, 26, p. 2125).

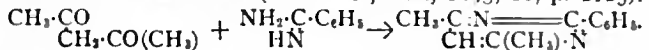

The β -ketic esters under like treatment yield oxypyrimidines, whilst if cyanacetic ester be employed then amino-oxypyrimidines are obtained. By using urea, guanidine, thiourea and related compounds instead of amidines, one obtains the uracils. The *cyanalkines* (aminopyrimidines) were first obtained, although their constitution was not definitely known, by E. Frankland and H. Kolbe (*Ann.* 1848, 65, p. 269) by heating the nitriles of acids with metallic sodium or with sodium ethylate between 130° C. and 180° C.

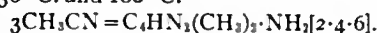

Pyrimidine, $C_4H_4N_2$, itself is a water-soluble base which melts at 21° C. and possesses a narcotic smell. Its methyl derivatives yield the corresponding carboxylic acids when oxidized by potassium permanganate. The amino derivatives are stable bases which readily yield substitution derivatives when acted upon by the halogen elements. *Cyanmethine*, $C_4H_5N_3$ (dimethyl-aminopyrimidine-2,4,6), melts at 180-181° C. The simple oxypyrimidines are obtained by the action of nitrous acid on the amino derivatives, or by heating these latter with concentrated hydrochloric acid to 180° C. They show both basic and phenolic properties and are indifferent to the action of reducing agents. Acid oxidizing agents, however, completely destroy them. By the action of phosphorus pentachloride, the hydroxyl group is replaced by chlorine.

Hydropyrimidines.—The dihydro derivatives are most probably those compounds which are formed in the condensation of acetyl derivatives of acetone, with urea, guanidine, &c. Tetrahydropyrimidines are obtained by the action of amidines on trimethylene bromide:



The 2,6-diketo-tetrahydropyrimidines or uracils may be considered as the ureides of β -aldehydo, and β -ketic acids. Uracil and its homologues may be obtained in many cases from the hydrouracils by the action of bromine, and subsequent elimination of the elements of hydrobromic acid; or by the condensation of aceto-acetic ester and related substances with urea, thiourea, guanidine, &c. *Uracil*, $C_4H_4O_2N_2$, crystallizes in colourless needles, is soluble in hot water and melts with decomposition at 335° C. *Hydrouracil*, $C_4H_6O_2N_2$, is obtained by the action of bromine and caustic alkalis on succinamide (H. Weidel and E. Roithner, *Monats.*, 1896, 17, p. 172); by the fusion of β -aminopropionic acid with urea; by the electrolytic reduction of barbituric acid (J. Tafel, *Ber.*, 1900, 33, p. 3385), and by the condensation of acrylic acid with urea at 210-220° C. (E. Fischer, *Ber.*, 1901, 34, p. 3759). It crystallizes in needles and is soluble in water. It melts at 275° C. *4-Methyluracil*, $C_5H_6O_2N_2$, has long been known, having first been synthesized by R. Behrend (see PURIN). It crystallizes in needles which melt at 320° C. and is soluble in caustic alkalis. On oxidation with potassium permanganate it is converted into acetyl urea, together with other products. *5-Methyluracil* (Thymin) is obtained from the corresponding methyl bromhydrouracil (E. Fischer); or from 2,4,6-trichloro-5-methylpyrimidine by the action of sodium methylate. This yields a 2,4-dimethoxy-5-methyl-6-chloropyrimidine, which on reduction and subsequent treatment with hydrochloric acid is converted into thymin (O. Gerngross, *Ber.*, 1905, 38, p. 3394). For methods of preparation and properties of numerous other pyrimidine compounds see T. B. Johnson, *Journ. Biol. Chem.*, 1906, &c.; *Amer. Chem. Journ.*, 1906, &c.; W. Traube, *Ber.*, 1900, &c.; O. Isay, *ibid.*, 1906, 39, p. 251.

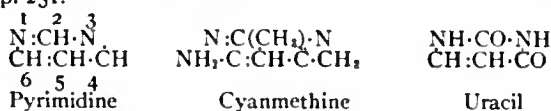

PYRITES, a term applied to iron disulphide when crystallized in the cubic system, but used also in a general sense to designate a group of metallic sulphides of which this mineral is the most characteristic example. When employed as a group-name the constituent species are distinguished by prefixes: thus the type is called iron pyrites, whilst other species are known as copper pyrites, arsenical pyrites, &c. The original word pyrites (from Gr. *πῦρ*, fire) had reference to the fact that sparks might be elicited on striking the mineral violently, as with flint, so that *πυρίτης λίθος* meant a stone which struck fire. Hence the name seems to have been applied also to flint, and perhaps to emery and other hard stones. Nodules of pyrites have been found in prehistoric barrows and elsewhere under conditions suggesting their use as a primitive means of producing fire. Even in late historic time it was employed in some of the old wheel-lock guns. Iron-pyrites was formerly called marcasite, a word variously written *marcasin*, *marchasite*, *marchesite*, *marquesite*, &c. The two names are now applied to distinct mineral species. The compound FeS_2 is dimorphous, and the modern practice is to distinguish the cubic forms as pyrites and the orthorhombic as marcasite (*q.v.*). Sometimes, however, the term pyrites is loosely applied to both species, and the cubic pyrites is then differentiated by the name "pyrite"—a form which brings the last syllable into harmony with the spelling of the names of most minerals.

Iron pyrites, or pyrite, belongs crystallographically to the parallel-faced hemihedral class of the cubic system. Its common forms are

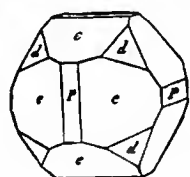

FIG. 1.

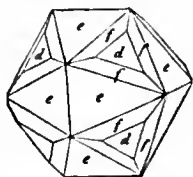

FIG. 2.

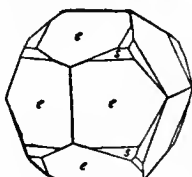

FIG. 3.

the cube, the octahedron, and the pentagonal dodecahedron. Fig. 1 shows *P* the cube {100}, *d* the octahedron {111}, and *e* the pentagonal dodecahedron π {210}.

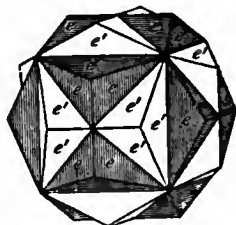

FIG. 4.

In fig. 2 π {210} and {111} are associated with *f* the dyakis-dodecahedron π {321}; whilst fig. 3 shows a combination of π {210} and π {421}. The faces of the cube are sometimes striated parallel to the edges between *P* and *e* (fig. 1), the striae on each face being therefore at right angles to those of the adjoining faces, and indicating an oscillatory combination of the cube and pentagonal dodecahedron. Fig. 4 illustrates a characteristic twin, formed by two interpenetrating pentagonal dodecahedra. Such supplementary twins, known in Germany as "twins of the Iron Cross," are commonly

brown by superficial conversion into limonite.

Pyrites presents a conchoidal fracture, and a very indistinct cubic cleavage. Its hardness is about 6, and its specific gravity 4.9 to 5.2, being rather more than that of marcasite. Moreover, the colour of pyrites is pale brass-yellow, whilst that of marcasite when untarnished may be almost tin-white. From copper-pyrites (chalcopyrite) iron-pyrites is distinguished by its superior hardness and by its paler colour. On exposure to meteoric influences pyrites commonly becomes brown, by formation of ferric hydrate or limonite, whence the change is called "limonitization." Such a change is very common on the outcrop of mineral veins, forming what miners call "gozzan." Another kind of alteration which pyrites may suffer has been termed "vitrification," since the products are ferrous sulphate, with free sulphuric acid and sometimes a basic ferric sulphate. It is often said that this saline change is more characteristic of marcasite than of pyrite, but according to H. N. Stokes this statement is incorrect. Contrary, too, to popular belief, he has found a fibrous structure more common in pyrite than in marcasite. In some cases the two forms of iron disulphide occur in intimate association and are difficult to distinguish.

According to the formula FeS_2 , pyrites contains theoretically 46.67% of iron and 53.33 of sulphur. Practically, however, it frequently contains other metals, such as copper, cobalt and nickel. Gold is often present, and in many gold-mining districts the precious metal is obtained mainly from auriferous pyrites. As pyrites, from its brass-yellow colour, is sometimes mistaken for gold, it has been vulgarly called "fool's gold." Traces of thallium, which are present in some pyrites, may be detected in the fumes of the furnaces where the metal is roasted. Arsenic is an impurity which may be of

serious consequence in some of the purposes to which pyrites is applied. The presence of copper, nickel and arsenic is possibly due in many cases to traces of kindred minerals, like chalcopyrite, pentlandite and mispickel.

Pyrites is a mineral of very wide distribution, occurring under varied conditions and probably originating in various ways. It is common in mineral-veins, usually associated with quartz, and is often known to miners as "mundic." It occurs crystallized, commonly in cubes, in schistose and slaty rocks, and less abundantly in the younger sedimentary deposits. In coal it not infrequently forms bands and nodules known as "brasses," and may also be finely disseminated through the coal as "black pyrites"; but much of the so-called pyrites of coal is really marcasite. Films of pyrites sometimes coat the joint-planes of coal. It is believed that the bluish colour of many clays and limestones is referable to the presence of finely divided pyrites, and it is known that certain deposits of blue mud now forming around continental shores owe their colour, in part, to disseminated iron sulphide. Pyritous shales have been largely used in the manufacture of alum, and are therefore known as "alum-shales." Many fossils are mineralized with pyrites, which has evidently been reduced by the action of decomposing organic matter on a solution of ferrous sulphate, or perhaps less directly on ferrous carbonate dissolved in water containing carbonic acid, in the presence of certain sulphates. A similar action probably explains the origin of pyrites and marcasite in coal and lignite, in clay and shales, and in limestone like chalk.

Pyrites is largely worked for sake of the sulphur which it contains, and in many cases it has displaced brimstone in the manufacture of sulphuric acid. For this purpose its value depends on the proportion of sulphur present. Pyrites low in sulphur is incapable of sustaining its own combustion without the aid of an external source of heat, and 45% of sulphur is, for economic reasons, usually regarded as the lowest admissible for sulphuric acid manufacture. It is also important for this purpose that the ore should be as free as possible from arsenic (see SULPHURIC ACID).

An extremely important variety of pyrites is that which is more or less cupriferous, and is commonly known commercially as "copper-pyrites" (*q.v.*), though distinct mineralogically from that mineral. It consists, indeed, mainly of iron-pyrites, with a notable but variable proportion of copper, sometimes with silver and gold, and not infrequently associated with lead and zinc sulphides. The copper probably exists as disseminated chalcopyrite. Deposits of such cupriferous pyrites are widely distributed and are often of great magnitude. They are generally of lenticular form, and usually occur in or near the contact of eruptive rocks with schists or slates; the presence of the igneous rock being probably connected genetically with their origin. Among the best-known deposits of this character are those in the Huelva district, in the south-west of Spain, including the mines of Rio Tinto, Tharsis, Calañas, &c.; with those of San Domingos in Portugal. At Rio Tinto the ore is divided into three classes:—

- (1) The poorest, containing an average of about 1½% of copper, which is treated locally by leaching with water and liquor containing ferric sulphate, whereby the copper is dissolved out and afterwards precipitated by pig-iron, whilst the residue is exported as ordinary iron-pyrites.
- (2) Export ore, with from 2 to 5% of copper, in which the sulphur, copper and precious metals are utilized, and the residual iron oxide then sold as "purple ore" for use in iron manufacture.
- (3) Smelting ore, which averages about 6% of copper, and is treated metallurgically as described under COPPER.

The world's annual production of iron-pyrites is about 1,700,000 tons. The largest producer is Spain, with upwards of 350,000 tons, including the cupriferous pyrites. France yields about 300,000 tons, largely from the Sain Bel mines, department of the Rhône. Then follows Portugal, with its important output of cupreous pyrites. In the United States the production of pyrites now reaches more than 200,000 tons per annum. The state of Virginia is the chief producer, followed successively by Georgia, North Carolina, Colorado, Massachusetts, California, Missouri, New York, &c. From Indiana and

Ohio a quantity of pyrites is obtained as a by-product in coal-mining. Newfoundland yields cupreous pyrites, worked at Pilley's Island, whilst the nickeliferous pyrites of Sudbury in Ontario is partly magnetic (see PYRRHOTITE). Magnetic pyrites of commercial importance occurs also in Virginia and Tennessee. The United Kingdom yields but little pyrites, the annual output being not more than about 10,000 tons. Large quantities of "sulphur ore" were, however, formerly worked in the Vale of Avoca, Co. Wicklow, Ireland. Finely crystallized specimens of pyrite are obtained from many other localities, especially from Cornwall, Elba and Traversella, near Ivrea, in Piedmont.

See, for the early history of pyrites, J. F. Henckel's *Pyritologia, oder Kieselhistorie* (Leipzig, 1725); of which an English translation appeared in 1757, entitled *Pyritologia; or a History of the Pyrites, the Principal Body in the Mineral Kingdom*. For a modern description of the deposit of pyrites of economic importance reference may be made to *A Treatise on Ore Deposits*, by J. A. Phillips (2nd ed. by H. Louis, 1896). For chemical means of distinguishing pyrite from marcasite consult H. N. Stokes, "On Pyrite and Marcasite," *Bull. U. S. Geol. Surv. No. 186* (1901). (F. W. R. *)

PYRITZ, a town of Germany, in the Prussian province of Pomerania, 16 m. S.W. of Stargard by the railway to Cüstrin. Pop. (1905), 8600. It is still surrounded by walls with towers, and has two Evangelical churches. There are small manufactures of machinery, bricks and sugar. Excellent wheat is grown in the vicinity, while another industry is the breeding of cattle. Near the town is a fountain, erected to mark the spring in which Otto, bishop of Bamberg, baptized the first Pomeranian converts to Christianity in 1124. Pyritz became a town in 1150.

PYROCATECHIN, or **PYROCATECHOL**, ortho-dioxybenzene, $C_6H_4(OH)_2$, first prepared in 1839 by H. Reinsch on distilling catechin (the juice of *Mimosa catechu*); occurs free in kino and in beechwood tar; its sulphonic acid is present in the urine of the horse and man. It results in the alkaline fusion of many resins, and may be prepared by fusing ortho-phenolsulphonic acid, *o*-chlorphenol, *o*-bromphenol, and *o*-phenoldisulphonic acid with potash, or, better, by heating its methyl ether, guaiacol, $C_6H_4(OH)(OCH_3)$, a constituent of beechwood tar, with hydriodic acid.

Pyrocatechin crystallizes in white rhombic prisms, which melt at 104° and boil at 245° ; it is readily soluble in water, alcohol and ether. Ferric chloride gives a green coloration with the aqueous solution, whilst the alkaline solution rapidly changes to a green and finally to a black colour on exposure to the air. It reduces silver solutions in the cold and alkaline copper on heating.

Guaiacol may be obtained directly from beechwood tar, from pyrocatechin by methylation with potash and potassium methyl sulphate at 180° , or from anisol by nitration, reduction of the ortho-nitroanisol to amino-anisol, which is then diazotized and boiled with water. It melts at 28° and boils at 250° . It is employed in medicine as an expectorant. The dimethyl ether or veratrol is also used in medicine. Many other pyrocatechin derivatives have been suggested for therapeutic application. Guaiacol carbonate is known as duotal, the phosphate as phosphatol, the phosphate as guaiaco-phosphal; phosphotal is a mixture of the phosphites of creosote phenols. The valerianic ester of guaiacol is known as geosote, the benzoic as benzosol, the salicylic as guaiacolsalol, while the glycerin ether appears as guaiamar.

Pyrocatechin readily condenses to form heterocyclic compounds; cyclic esters are formed by phosphorus trichloride and oxychloride, carbonyl chloride, sulphuryl chloride, &c.; whilst ortho-phenylenediamine, *o*-aminophenol, and *o*-aminothiophenol give phenazine, phenoxazine and thiodiphenylamine.

PYROGALLOL, or **PYROGALLIC ACID**, a trioxybenzene, $C_6H_3(OH)_3$ (1 : 2 : 3), prepared by Scheele in 1786 by heating gallic acid, $C_6H_2(OH)_3CO_2H$. It is also obtained by heating para-chlorphenoldisulphonic acid with potassium hydroxide.

It forms white plates, melting at 132° , readily soluble in water, and subliming without decomposition. It is an energetic reducing agent, a property utilized in its application in gas analysis to absorb oxygen, and in photography (*q.v.*) as a developer. The aqueous solution is turned bluish black by ferrous sulphate containing a ferric salt. It does not combine with hydroxylamine, as does the isomeric phloroglucin which yields a trioxime (see POLYMETRYLENES). Pyrogallol dimethyl ether is found in beechwood tar. Pyrogallol has antiseptic properties and is employed medicinally in the treatment of psoriasis. Eugallol, or monacetyl pyrogallol and leuogallol, or triacetyl pyrogallol, are also used.

PYROLUSITE, a mineral consisting essentially of manganese dioxide (MnO_2), of importance as an ore of manganese. It is a soft, black, amorphous mineral, often with a granular, fibrous or columnar structure, and sometimes forming reniform crusts. It has a metallic lustre, and a black or bluish-black streak, and readily soils the fingers. The specific gravity is about 4.8.

Supposed crystals of pyrolusite have been proved to be pseudomorphs after manganite; in fact the mineral often results by the dehydration and oxidation of manganite ($Mn_2O_3 \cdot H_2O$), and for this reason it frequently contains a little water. True crystals of manganese dioxide are referred to the rare species polianite; they are tetragonal and isomorphous with cassiterite. Pyrolusite is an alteration product of other manganese minerals—manganite, rhodochrosite, rhodonite, &c. It occurs as irregular masses and nodules in the residual clayey materials resulting from the decomposition of various rocks, for example, limestone. That it is readily deposited from solution is shown by the frequent occurrence of black dendritic markings in the crevices of rocks, excellent examples of which are seen in mocha stone (*q.v.*) and in the lithographic stone of Solenhofen in Bavaria. It is deposited from the waters of some springs, and manganese nodules are dredged from the floor of the deep sea.

As an ore it is extensively mined at Ilmenau and several other places in Thuringia, at Vorderchrensdorf near Prossnitz in Moravia, Platten in Bohemia, in North Wales, at several places in the United States (Vermont, Virginia, Arkansas, &c.), Nova Scotia and Brazil. Pyrolusite, together with the rather less important ore, psilomelane, has various economic applications. It is extensively used for the manufacture of spiegeleisen and ferromanganese, and of various alloys, such as manganese-bronze. As an oxidizing agent it is used in the preparation of chlorine and disinfectants (permanganates), and for decolorizing glass: when mixed with molten glass it oxidizes the ferrous iron to ferric iron, and so discharges the green and brown tints, hence the name pyrolusite, from Gr. $\pi\upsilon\rho$ (fire) and $\lambda\epsilon\omega$ (to wash). As a colouring material, it is used in calico printing and dyeing; for imparting violet, amber and black colours to glass, pottery and bricks; and in the manufacture of green and violet paints. (L. J. S.)

PYROMETER (Gr. $\pi\upsilon\rho$, fire, $\mu\epsilon\tau\rho\upsilon$, a measure), an instrument for measuring high temperatures. The term was first used by Musschenbroek to denote an instrument wherein the expansion of a metal rod measured the temperature. Discontinuous thermoscopes, depending on the fusion of a metal or salt, are also employed. Prinsep prepared a series of alloys of silver and gold, and of gold and platinum, whose melting points, as determined by accurate instruments, covered a range of temperature from 954° to 1775° , at intervals of from 25° to 30° . By placing ingots in a furnace and observing which one melted a fair idea of the temperature was obtained. Carnelley and Williams employed certain salts of known melting point; whilst the Seger's cones, employed in porcelain manufacture, depend on the fusion of small cones made of clay. (See THERMOMETRY for scientific forms.)

PYROMORPHITE, a mineral species composed of lead chlorophosphate ($PbCl$) $Pb_3(PO_4)_3$, sometimes occurring in sufficient abundance to be mined as an ore of lead.

Crystals are common, and have the form of a hexagonal prism terminated by the basal planes, sometimes combined with narrow faces of a hexagonal pyramid. Crystals with a barrel-like curvature are not uncommon. Globular and reniform masses are also found. As proved by the etched figures on the faces, crystals possess the same parallel-faced hemihedrism as apatite, with which mineral pyromorphite and also mimetite are isomorphous. Between pyromorphite and the corresponding chloro-arsenate (mimetite, *q.v.*) the resemblance in external characters is so close that, as a rule, it is only possible to distinguish between them by chemical tests; and they were formerly confused under the names "green lead ore" and "brown lead ore" (German, *Grünbleierz* and *Braunbleierz*). The phosphate was first distinguished chemically by M. H. Klaproth, in 1784, and it was named pyromorphite by J. F. L. Hausmann in 1813, being so named from the Gr. $\pi\upsilon\rho$ (fire) and $\mu\omicron\rho\rho\eta$ (form), because when a fragment of the mineral is fused the globule assumes a faceted form on solidifying. The colour of the mineral is usually some bright shade of green, yellow or brown, and the lustre is resinous. The hardness is $3\frac{1}{2}$ and the specific gravity 6.5-7.1. Owing to isomorphous replacement of the phosphorus by arsenic there may be a gradual passage from pyromorphite to mimetite. Varieties containing calcium isomorphously replacing lead are lower in density (specific gravity 5.9-6.5) and usually lighter in colour; they bear the names "polyspharicite" (because of the globular form), "miesite" from Mies in Bohemia, "nussierite" from Nussière near Beaujeu, Rhône, France, and "cherokine" from Cherokee county in Georgia.

Pyromorphite has resulted from the alteration of galena in the oxidized portions of metalliferous veins, and is frequently met with in the upper levels of lead mines. Finely crystallized specimens have been found at Braubach and Ems in Nassau, Wheal Alfred in Cornwall, Roughten Gill in Cumberland, Leadhills in Scotland, Phoenixville in Pennsylvania, Huelgoat in Finistère, Brittany, &c. At the last-named locality, as well as at Wheal Hope, near Truro in Cornwall, there were formerly found curious pseudomorphs of galena after pyromorphite, known as "blue lead ore."

(L. J. S.)

PYRONES, in chemistry, a group of heterocyclic compounds, containing a six-membered ring composed of five carbon atoms and one oxygen atom. Two types are known, namely, the α -pyrones, which may be regarded as the lactones of δ -oxydiolefine carboxylic acids, and the γ -pyrones, which may be regarded as anhydrides of diolefine dioxyketones:—

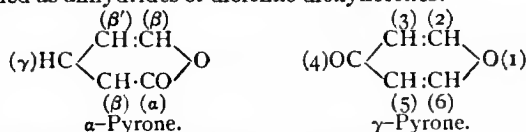

As a class, the pyrones are rather unstable compounds, the ring being readily broken. When digested with ammonia, the oxygen atom is replaced by the imino (:NH) group, and pyridones or oxypyridines are formed.

α -Pyrones.—The coumalic compounds belong to this series, and were first obtained by A. Hantzsch in 1884 (*Ann.* 222, p. 1) and H. v. Pechmann (*Ber.*, 1884, 17, p. 936).

α -Pyrone or coumalin, $C_5H_4O_2$, is obtained by distilling the mercury salt of coumalic acid (from malic acid and sulphuric acid) in a current of hydrogen. It is an oily liquid which boils at 206–209° C., and with alkalis it gives formyl crotonic acid, $HO_2C:CH:CH_2:CHO$. α' -*Dimethyl- α -pyrone* or mesitene lactone, $C_7H_8O_2$, is obtained from iso-dehydracetic acid (from aceto-acetic ester and sulphuric acid). *Phenylcoumalin* or α' -*phenyl- α -pyrone*, $C_8H_8(C_6H_5)O_2$, is found in coto-bark. When heated with alkalis it yields benzoic acid and acetophenone; reduction by hydriodic acid gives δ -phenyl valeric acid, and when heated with ammonium acetate and ammonia it yields phenylpyridone. It forms an addition product with phenol and with aniline; the latter gives diphenylpyridone when boiled with concentrated hydrochloric acid. *Paracotoin*, $C_{18}H_{16}O_4$, which also occurs in coto-rind, appears to be a bisoxymethylene phenylpyrone, $C_8H_8O_2 \cdot C_8H_8(CH_2)_2O_2$.

Various *pyronones* (keto-dihydropyrones) derived from the compound having formula I. (below) are known, the most important of which is *dehydracetic acid*, $C_5H_6O_4$, first obtained by Geuther (*Jena'sche Zeit.*, 1866, p. 8). It may be prepared by distilling aceto-acetic ester alone, by heating it with acetic anhydride to 200° C. or by heating acetyl chloride with pyridine to 200–220° C. J. N. Collie regards it as having formula II., whilst Feist (*Ann.* 1890, 257, p. 253) favours formula III.

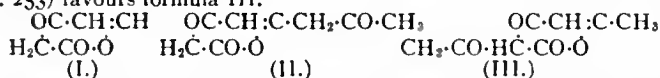

It crystallizes in tables which melt at 108–109° C., and is a weak acid. Alcoholic potash converts it into aceto-acetic ester, and with concentrated aqueous caustic potash it is completely decomposed into acetone, acetic acid and carbon monoxide.

γ -Pyrones.—Many of these compounds are found as naturally occurring substances: thus chelidonic acid is found in *Chelidonium majus* and meconic acid in opium, and the more complex flavone and flavonol derivatives are also found in various plants. The γ -pyrones may be synthesized by eliminating water from the 1.3.5 triketones:—

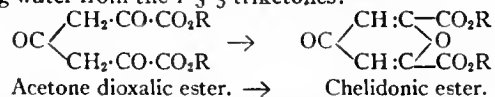

γ -Pyrone or pyrocumane, $C_8H_8O_2$, melting at 32° C. and boiling at 210–215° C., is obtained by eliminating carbon dioxide from chelidonic acid (obtained as above), or from comanic acid, obtained by heating chelidonic acid. $\alpha\alpha'$ -*Dimethyl- γ -pyrone*, $C_8H_8(CH_3)_2O_2$, is obtained by the action of hydriodic acid on the ester of the corresponding acid (Feist, *Ann.*, 1890, 257, p. 272); by the action of carbonyl chloride on the copper derivative of acetoacetic ester, and by the action of concentrated hydrochloric acid on dehydracetic acid. It forms a barium salt which with an acid yields diacetyl acetone. The most striking property of this compound is that it forms salts with mineral acids (J. N. Collie and Tickle, *Journ. Chem. Soc.*, 1899, p. 710). For example, hydrochloric acid adds on at the oxygen atom, since the salts so formed are relatively unstable and undergo complete hydrolysis in dilute aqueous solution. The oxygen

atom is probably tetravalent, and the salts are to be regarded as oxonium salts (see OXYGEN). Collie (*Journ. Chem. Soc.*, 1904, 85, p. 971) is of the opinion that both oxygen atoms are to be regarded as tetravalent in these salts and gives the second formula below for the molecule:—



Meconic acid, or oxypyrene tricarboxylic acid (3.2.6) $C_8H_6O_2(OH)(CO_2H)_2$, found in opium, crystallizes in prisms and gives a characteristic deep red colour with ferric chloride. On heating to 200° it gives comenic acid, $C_8H_8O_2(OH)(CO_2H)$, and on distillation pyromeconic acid or β -oxypyrene. On comenic acid see A. Peratoner, *Gazz.*, 1906, 36 (i.), p. 1.

The tetrahydro- γ -pyrones may be obtained by the condensation of aldehydes with acetone-dicarboxylic ester in the presence of hydrochloric acid.

Benzopyrones.

Compounds of this type are known in both the α and γ series, the former including the coumarins (*q.v.*) and isocoumarins, and the latter a number of naturally occurring dyestuffs which may be considered as derivatives of flavone (see under).

The *isocoumarins* (annexed formula) may be prepared by the action of acid chlorides or anhydrides on orthocyanbenzyl cyanide (*Ber.*, 1892, 25, p. 3563); by the molecular rearrangement of the benzal or alkylidene phthalides (S. Gabriel, *Ber.*, 1885, 18, p. 2443; 1887, 20, p. 2363), and by the action of manganese dioxide and hydrochloric acid on β -naphthoquinone.

The parent substance of the γ -group, namely *benzo- γ -pyrone* (chromone), was obtained in 1900 by S. Ruhemann (*Journ. Chem. Soc.*, 77, p. 1179) by heating its carboxylic acid (formed by the action of concentrated sulphuric acid on phenoxyfumaric acid) *in vacuo*. It crystallizes in colourless needles, and its solution in concentrated sulphuric acid is yellow with a blue fluorescence. The naturally occurring compounds, chrysin, galanzin, quercetin, apigenine, &c., are considered to be derivatives of flavone (or flavonol), which is a phenyl-2-benzo- γ -pyrone (S. Kostanecki, *Ber.*, 1898–1906). Flavone and flavonol possess the following constitutions, the positions of the substituents being indicated by the numbers:—

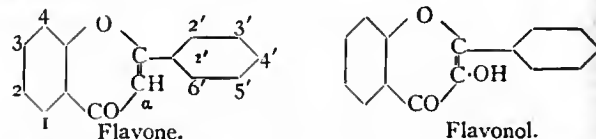

Flavone, $C_{15}H_{10}O_2$, is obtained by the action of potassium hydroxide on the acetyl derivative of benzylidene-ortho-oxyacetophenone. It forms colourless needles, which dissolve in concentrated sulphuric acid with a yellow colour and show a faint blue fluorescence. On fusion with caustic alkalis it yields salicylic acid, acetophenone, ortho-oxyacetophenone and benzoic acid, the latter two products being also formed by its hydrolysis with sodium ethylate. *Chrysin* or 1.3-dioxyflavone, $C_{15}H_{10}O_4$, is a yellow dye, which may be obtained from the buds of different varieties of the poplar. On hydrolysis it yields phloroglucin and benzoic and acetic acids. It has been synthesized by heating trimethoxy benzoyl acetophenone (from ethyl benzoate and phloracetophenone trimethyl ether) with hydriodic acid, and also by the action of hydriodic acid on 2.4-dibromo-1.3-dimethoxyflavone. *Galanzin* or α' 1.3-trioxyflavone or 1.3-dioxyflavonol, $C_{15}H_{10}O_6$, crystallizes in yellow needles. It has been synthesized from hydroxydimethoxy-chalkone, $C_8H_8:CH:CH:CO[r]:C_6H_5(OH)(OCH_3)_2[2'4'6']$, the resulting 1.3-dimethoxy-flavanone compound yielding a nitroso-compound from which galanzin is obtained by the action of concentrated hydriodic acid. *Apigenine* or 1.3.4'-trioxyflavone, $C_{15}H_{10}O_6$, found in woad and in parsley, crystallizes in pale yellow needles. On fusion at moderate temperatures with caustic alkalis it gives phloroglucin and para-oxyacetophenone, whilst at higher temperatures it yields protocatechuic and para-oxybenzoic acids and phloroglucin. It is obtained synthetically by brominating 1.3.4'-trimethoxyflavone, the resulting tribromo-compound by the consecutive reactions of alcoholic potash and hydriodic acid yielding apigenine. *Kaempferol* or 1.3.4'-trioxyflavonol, $C_{15}H_{10}O_6$, is found in the blossoms of *Delphinium consolida* and *D. zasil*. It is obtained by the action of hydriodic acid on kaempferid, and crystallizes in yellowish needles, which on fusion with caustic alkalis give para-oxybenzoic acid and phloroglucin. It is obtained synthetically from hydroxy-trimethoxy-chalkone, $CH_3O[4]C_6H_4[1]:CH:CH:CO[r]:C_6H_5(OH)(OCH_3)_2[2'4'6']$ by a method similar to that used for galanzin. *Kaempferid* occurs together with galanzin and alpinin in galganta root. It crystallizes in pale yellow needles, which dissolve in the caustic alkalis with an intense yellow colour, and in concentrated sulphuric acid with a

yellow colour and blue fluorescence. *Fisetin* or 3·3'·4'-trioxyflavonol, $C_{15}H_{10}O_7$, occurs in the wood of *Quebracho colorado*, and can be obtained by heating fustic with dilute acids. It crystallizes in pale yellow needles. In dilute alcoholic alkalis it shows a dark green fluorescence. On fusion with caustic alkalis it yields phloroglucin, resorcin and protocatechuic acid, whilst if air be passed through its alcoholic solution it yields protocatechuic acid and resorcin. It is obtained synthetically from 2-oxy-3·4-dimethoxy-4-ethoxy-chalkone. The various steps in this synthesis are shown below, since the method employed is applicable to other members of the group.

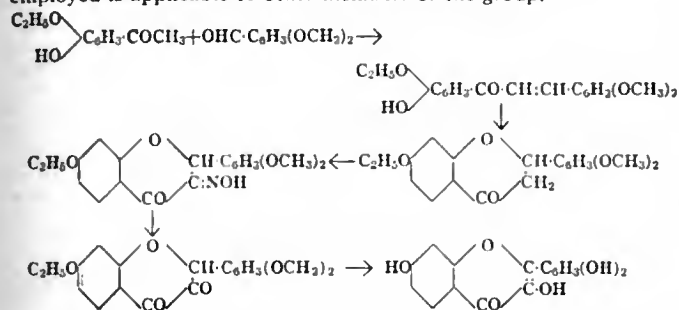

This structure of the fisetin molecule was confirmed by Herzig (*Monats.*, 1891, 12, p. 177), who showed that the tetraethyl ether of fisetin on hydrolysis with alcoholic potash gave diethylprotocatechuic acid and diethylfisetol, the latter on oxidation yielding ethyl-β-resorcylic acid, which had been previously obtained by oxidizing resacetophenone ethyl ether. *Luteolin* or 1·3·3'·4'-tetraoxyflavone, $C_{15}H_{10}O_6$, is found in the weld obtained from *Reseda luteola*. It crystallizes in small yellow needles, which dissolve in solutions of the caustic alkalis with a bright yellow colour. On fusion with caustic alkalis it yields phloroglucin and protocatechuic acid. It is obtained synthetically from 1·3·3'·4'-tetramethoxy-flavanone by bromination, the tribromo-compound being decomposed by the successive use of alcoholic potash and concentrated hydriodic acid. *Quercetin* or 1·3·3'·4'-tetraoxyflavonol, $C_{15}H_{10}O_7$, is a decomposition product of quercitrin rind, and is found in many plants. It is obtained by the hydrolysis of quercitrin with dilute sulphuric acid. It is a pale yellow crystalline powder. Alcohol hydrolyses it to protocatechuic acid and phloroglucin. It is prepared synthetically from 2-hydroxy-3·4·4'·6'-tetramethoxy-chalkone. *Rhamnetin*, $C_{15}H_{10}O_6\cdot\text{OCH}_3$, the monomethyl ether, is a pale yellow powder. *Rhamnazin*, $C_{15}H_{10}O_6(\text{OCH}_3)_2$, the dimethyl ether, crystallizes in yellow needles. *Morin* or 1·3·2'·4'-tetraoxyflavonol, $C_{15}H_{10}O_7$, occurs in the wood of *Auscocypis integrifolia*, and crystallizes in long yellow needles, which on fusion with caustic alkali decompose into phloroglucin, resorcin and oxalic acid. On reduction with sodium amalgam in alkaline solution it yields phloroglucin and β-resorcylic acid. It yields a tetramethyl ether and a penta-acetate. It has been synthesized from 1·3·2'·4'-tetramethoxy flavanone by converting this into its isonitroso compound, which yields morin trimethyl ether on hydrolysis by sulphuric acid. *Myricetin* or 1·3·3'·4'·5'-penta-oxy flavonol, $C_{15}H_{10}O_8$, found in the rind of *Myrica naga* and also in Sicilian sumach, crystallizes in yellow needles which dissolve with a green colour in dilute alkalis. On fusion with caustic alkalis it yields gallic acid and phloroglucin.

The parent substance of the group, namely *chroman* (annexed formula), was obtained by J. v. Braun and A. Steindorff in 1905 (*Ber.*, 38, p. 850) by diazotizing ortho-amino-γ-chlorpropylbenzene and heating the resulting chlorpropylphenol with a caustic alkali. It is a colourless oil which boils at 214–215° C. and possesses a characteristic peppermint odour.

For the dibenzo-pyrones see XANTHIONE.

PYROPE (pronounced pīrōp), a deep red variety of garnet, named from the Gr. πυρρός (fiery) in allusion to its colour. It is used, like almandine (*q.v.*), as a gem-stone, but may be distinguished by the absence of any tinge of violet in its colour and by its lower specific gravity (3·7 or 3·8, while that of almandine is 4·1 to 4·3). The typical colour of pyrope is blood-red, though sometimes a trace of orange gives rise to a hyacinthine hue: occasionally the mineral becomes nearly black, as seen in the pyrope of Arendal in Norway. Crystals are rare, but cubic forms have been observed. Pyrope may be regarded as a magnesium-aluminium garnet (see GARNET), but it usually contains more or less calcium, iron, manganese and chromium; and the rich colour of the mineral seems due to the presence of some of the last three metals, though their exact condition in the mineral has not been determined.

Pyrope generally occurs in grains embedded in peridotites (olivine rocks) or in serpentine resulting from their alteration, or it is found

as loose grains in detritus due to the disintegration of the matrix. The grains may be surrounded by a chloritic rind, or by a crust of a fibrous mineral called by A. Schrauf kelyphite (from the Gr. κελύφος, a nut-shell), which seems in some cases to be an amphibole. In the serpentine of Zöblitz and of Greifendorf near Leipzig, in Saxony, pyrope is characteristically developed; and the Saxon garnets, found loose in gravels, were referred to by G. Agricola as far back as 1546. Several localities in Bohemia are famous for yielding pyrope, and from its characteristic occurrence here it is often known, even when found elsewhere, as Bohemian garnet. The garnet-bearing district is a tract of about 70 square kilometres in the north of Bohemia, the chief locality being Meronitz near Bilin. It is notable that the pyrope is found at Meronitz in a clayey calcareous tufa or conglomerate, with opal and serpentine, products of the decomposition of a peridotite. It occurs also in sands and gravels near Chrastian, Lobositz, Tribnitz, Podseditz, Chodolitz, and at several other localities in the Mittel Gebirge, between Teplitz and Leitmeritz. It is believed that the original pyrope-bearing rocks resulted from the eruptive activity which gave rise to Linhorka Hill, near Starrey. The garnets in the detritus are accompanied by zircon, spinel, corundum, cyanite, tourmaline, olivine, &c. Though generally very small, they are abundant, and are used not only as ornamental stones, but as a counterpoise in delicate weighing and as an abrasive agent. To obtain the stones the detritus is washed, and the garnets picked out by hand and then sized through sieves. The pyrope is generally rose-cut or step-cut, and often mounted with a foil. Beads are faceted all over. Some pyrope is cut *en cabochon*, forming, like almandine, carbuncle, and if very dark the stone is hollowed at the back so as to form a "garnet-shell." The industry of cutting Bohemian garnets is centred in Turnau on the Iser, near Reichenberg; but there are also works at other localities. Large stones are very rare, but a Bohemian pyrope as large as a hen's egg is preserved in the Imperial treasury at Vienna; and another the size of a pigeon's egg in the Grüne Gewölbe of Dresden.

Pyrope occurs in many localities in the western part of the United States, especially in Colorado, Arizona and New Mexico, where it is often called "ruby." It is found loose in sand accompanied by olivine, and has resulted from the alteration of a peridotite. The Navajo Indians of New Mexico collect the garnet from the sands of the ant-hills and scorpion-holes. Very fine pyrope occurs in the diamond-fields of South Africa, having been derived from olivine-bearing rocks. It occurs in the blue-ground and in the detritus of the river-diggings. The Cape garnets have usually a rich colour, but some stones incline to an orange hue. The finest pyrope is often cut as a brilliant, and passes under the misleading name of "Cape ruby." A pyrope-bearing rock, rather like that of South Africa, occurs in Elliott county, Kentucky, U.S.A.; it is notable, too, that pyrope is found near Elie in Fife, in Scotland, where it occurs in volcanic agglomerates and in basaltic dikes. Sir A. Geikie has pointed out the suggestive resemblance of the occurrence there to that in South Africa.

See "Bohemian Garnets," by G. F. Kunz, *Trans. Amer. Inst. Mining Eng.* (1893), xxi. 241; and "Die böhmischen Granatlagerstätten," by Dr Hans Oehmichen, *Zeit. f. prakt. Geol.* (1900), viii. 1. Both papers contain bibliographical lists. (F. W. R.)

PYROPHORUS (Gr. πῦρ, fire, φέρειν, to bear), a substance which spontaneously inflames on contact with the air. One of the earliest known is that of Homberg, prepared by heating a mixture of alum and finely divided carbon to redness in a closed tube. On opening the tube and emptying out the black residue (consisting of potassium sulphide, aluminium sulphate and carbon) it promptly catches fire. Many readily oxidizable substances, especially when very finely divided, have the same property. Metallic iron and cobalt, when prepared under certain conditions, are pyrophoric, as is also ferrous oxide. Spontaneously inflammable liquids are also known, *e.g.* certain alkyl metallic compounds, phosphorus dihydride, &c.

PYROPHYLLITE, a mineral species belonging to the clay family, and composed of hydrous aluminium silicate $\text{HAl}(\text{SiO}_3)_2$. It occurs in two more or less distinct varieties, namely, as crystalline folia and as compact masses; distinct crystals are not known.

The folia have a pronounced pearly lustre, owing to the presence of a perfect cleavage parallel to their surfaces: they are flexible but not elastic, and are usually arranged radially in fan-like or spherical groups. This variety, when heated before the blowpipe, exfoliates and swells up to many times its original volume, hence the name pyrophyllite, from the Greek πῦρ (fire) and φύλλον (a leaf), given by R. Hermann in 1829. The colour of both varieties is white, pale green, greyish or yellowish; they are very soft ($H=1-2$) and are greasy to the touch. The specific gravity is 2·8–2·9. The two varieties are thus very similar respectively to talc (*q.v.*) and its compact variety steatite, which is, however, a hydrous magnesium

silicate. The compact variety of pyrophyllite is used for slate pencils and tailors' chalk ("French chalk"), and is carved by the Chinese into small images and ornaments of various kinds. Other soft compact minerals (steatite and pinitite) used for these Chinese carvings are included with pyrophyllite under the terms agalmatolite and pagodite.

Pyrophyllite occurs in schistose rocks, often associated with cyanite, of which it is an alteration product. Pale green foliated masses, very like talc in appearance, are found at Beresovsk near Ekaterinburg in the Urals, and at Zermatt in Switzerland. The most extensive deposits are in the Deep river region of North Carolina, where the compact variety is mined, and in South Carolina and Georgia.

PYROXENE, an important group of rock-forming minerals, very similar in chemical composition and general characters to the amphiboles (*q.v.*). Although crystallizing in three different systems, they all possess distinct prismatic cleavages, the angles between which are about 87° (the cleavage angle in the amphiboles being 56°). They are metasilicates, but, as shown in the following table, the composition varies widely in the different species, with corresponding differences in the various physical characters. The name pyroxene was originally given by R. J. Haüy in 1796 to the black crystals of augite found in the lavas of Vesuvius and Etna: he derived the name from the Greek $\pi\upsilon\rho$ (fire) and $\xi\nu\omicron\varsigma$ (a stranger), because he thought that the crystals had been accidentally caught up by the lavas which contained them. As a matter of fact, the pyroxenes are, next to the feldspars, the commonest constituents of igneous rocks of almost all kinds, being especially characteristic of those of basic composition. An igneous rock composed almost wholly of pyroxene is known as a pyroxenite. Besides being minerals of primary origin in igneous rocks, the pyroxenes are also of frequent occurrence in metamorphic rocks, for example, in crystalline limestones, being then of secondary origin.

At the present day the name pyroxene is used as a group name for all the minerals enumerated below, though sometimes it is also applied as a specific name to include the monoclinic members diopside, hedenbergite, schefferite and augite.

Orthorhombic Series.	
Enstatite	$MgSiO_3$.
Bronzite	$(Mg,Fe)SiO_3$.
Hypersthene	$(Fe,Mg)SiO_3$.
Monoclinic Series.	
Diopside	$CaMg(SiO_3)_2$.
Hedenbergite	$CaFe(SiO_3)_2$.
Schefferite	$(Ca,Mg)(Fe,Mn)(SiO_3)_2$.
Augite	$\left\{ \begin{array}{l} Ca(Mg,Fe)(SiO_3)_2 \text{ with} \\ (Mg,Fe)(Al,Fe)_2SiO_6. \end{array} \right.$
Acmite	$NaFe^{III}(SiO_3)_2$.
Spodumene	$LiAl(SiO_3)_2$.
Jadeite	$NaAl(SiO_3)_2$.
Wollastonite	$CaSiO_3$.
Pectolite	$HNaCa_3(SiO_3)_3$.
Rosenbuschite	$Na_2Ca_4(Si,Zr,Ti)O_8$.
Anorthic Series.	
Rhodonite	$MnSiO_3$.
Babingtonite	$(Ca,Fe,Mn)SiO_3 \cdot Fe_2^{III}(SiO_3)_3$.
Hiortdahlite	$(Ca,Na)_2F(Si,Zr)O_4$.

For details respecting the special characters and modes of occurrence of most of these species reference may be made to the respective headings: others not so treated are briefly mentioned below. Hedenbergite, or calcium iron pyroxene, is a black mineral closely allied to diopside (*q.v.*) and, owing to the isomorphous replacement of iron by magnesium, there is no sharp line of division between them. Schefferite, or manganese pyroxene, is a brown mineral found in the manganese mines of Sweden. Pectolite is a secondary mineral occurring as white masses with a radially fibrous structure in the veins and cavities of basic igneous rocks. Babingtonite is found as small black crystals on felspar in the granite of Bavaria in Italy, and in the Haytor iron mine in Devonshire. Rosenbuschite, hiortdahlite, and some other rare members containing zirconium and fluorine, occur as accessory constituents in the nepheline-syenite of southern Norway.

PYROXENITE, a rock consisting essentially of minerals of the pyroxene group, such as augite and diallage, hypersthene, bronzite or enstatite. Names have been given to members of this group according to their component minerals, *e.g.* pyroxenite (augite), diallagite (diallage), hypersthene (hypersthene), bronzitites (bronzite), websterite (diallage and hypersthene). Closely allied to this group are the hornblendites, consisting

essentially of hornblende. The term perknite (Gr. $\pi\epsilon\rho\kappa\acute{\nu}\omicron\varsigma$, dark) has also been used to designate the whole series.

They are essentially of igneous origin, though some pyroxenites are included in the metamorphic complex of the Lewisian of Scotland; those pyroxene rocks which result from the contact alteration of impure limestones are described as pyroxene hornfels (calc-silicate hornfels). The pyroxenites are closely allied to the gabbros and norites, from which they differ by the absence of felspar, and to the peridotites, which are distinguished from them by containing olivine. This connexion is indicated also by their mode of occurrence, for they usually accompany masses of gabbro and peridotite and seldom are found by themselves. They are strictly plutonic and often very coarse-grained, containing individual crystals which may be several inches in length. The principal accessory minerals, in addition to olivine and felspar, are chromite and spinels, garnet, iron oxides, rutile, scapolite. They frequently occur in the form of dikes or segregations in gabbro and peridotite: *e.g.* in Shetland, Cortlandt on the Hudson river, North Carolina (websterite), Baltimore, New Zealand, and in Saxony. The component minerals often have a close resemblance to those of the surrounding rock. By decomposition the rocks consisting of pyroxene pass into serpentines, which sometimes preserve the original structures of the primary minerals, such as the lamination of hypersthene and the rectangular cleavage of augite. Under pressure-metamorphism hornblende is developed and various types of amphibolite and hornblende-schist are produced. Occasionally rocks rich in pyroxene are found as basic facies of nepheline-syenite; a good example is provided by the melanite pyroxenites associated with borolanite (*q.v.*) at Ledbeg in Sutherlandshire.

(J. S. F.)

PYRRHO OF ELIS (*c.* 360–270 B.C.), a Greek sceptic philosopher and founder of the school known as Pyrrhonism. Diogenes Laërtius (ix. 61), quoting from Apollodorus, says that he was at first a painter, and that pictures by him were in existence in the gymnasium at Elis. Later he was diverted to philosophy by the works of Democritus, and became acquainted with the Megarian dialectic through Bryson, pupil of Stilpo. With Anaxarchus, he went to the East in the train of Alexander, and studied in India under the Gymnosophists (*q.v.*) and under the Magi in Persia. From the Oriental philosophy he seems to have adopted a life of solitude. Returning to Elis, he lived in poor circumstances, but highly honoured by the Elians and also by the Athenians, who gave him the rights of citizenship. His doctrines are known mainly through the satiric writings ($\Sigma\iota\lambda\lambda\omicron\iota$) of his pupil Timon of Phlius (the Sillographer). The main principle of his thought is expressed in the word *acatalepsia*, which implies the impossibility of knowing things in their own nature. Against every statement the contradictory may be advanced with equal reason (*ισοσθενεια των λογων*). Secondly, it is necessary in view of this fact to preserve an attitude of intellectual suspense (*εποχη*), or, as Timon expressed it, *ουδεν μαλλον* (*i.e.* no assertion more valid than another). The same idea is expressed also by the terms *αρρηβια* (equilibrium) and *αφασια* (refusal to speak, non-committal silence). Thirdly, these results are applied to life in general. Pyrrho concludes that, since nothing can be known, the only proper attitude is imperturbability (*ataraxia*). The impossibility of knowledge, even in regard to our own ignorance or doubt, should induce the wise man to withdraw into himself, avoiding the stress and emotion which belong to the contest of vain imaginings. This drastic scepticism is the first and the most thorough exposition of agnosticism in the history of thought. Its ethical results may be compared with the ideal tranquillity of the Stoics and the Epicureans. (For its relation to the New Academy and to scepticism in general see SCEPTICISM and MEGARIAN SCHOOL OF PHILOSOPHY.)

See histories of philosophy by Zeller, Erdmann, Ueberweg; Ritter and Preller, § 364; Waddington, *Pyrrhon et le pyrrhonisme* (1877); Zimmermann, *Darstellung d. pyrrh. Phil.* (1841) and *Ueber Ursprung und Bedeutung d. pyrrh. Phil.* (1843); Wachsmuth, *De Timone Phliasio* (1859).

PYRRHOTITE, a mineral species consisting of iron sulphide and crystallizing in the hexagonal system. The formula is $Fe_n S_{n+1}$ where n may vary from 5 to 16; usually it is $Fe_7 S_8$ or $Fe_{11} S_{12}$, the latter being also the composition of the artificially prepared compound. Small amounts of nickel and cobalt are often present.

Crystals have the form of hexagonal plates bounded at their edges by faces of a hexagonal prism and pyramids, which are deeply striated horizontally. More frequently, however, the mineral is massive, with a laminar or granular structure. The colour is bronze-yellow and the lustre metallic; the streak is greyish-black. The hardness is 4 and the specific gravity 4.58-4.64. The mineral is magnetic, sometimes with polarity, and it is therefore often called "magnetic pyrites."

Pyrrhotite occurs in metalliferous veins, and as grains and plates disseminated through various rocks. In the gabbros and norites of Norway and Sweden it has been concentrated by magmatic differentiation at the margins of the igneous masses. Large bodies of massive pyrrhotite occur at Bodenmais in Bavaria and in Wheal Jane near Truro in Cornwall. Crystallized specimens are from the metalliferous veins at Morro Velho in Brazil, Kongsberg in Norway, and Andreasberg in the Harz. Crystals of pyrrhotite have also been observed in meteoric stones; but iron sulphide appears more commonly in meteorites, especially in meteoric irons, as troilite (FeS), which, if really distinct from pyrrhotite, has not been met with in terrestrial rocks. (L. J. S.)

PYRRHUS (c. 318-272 B.C.), king of Epirus, son of Aeacides, and a member of the royal family of the Molossians. He claimed descent from Pyrrhus, the son of Achilles, and was also connected with the royal family of Macedonia through Olympias, the mother of Alexander the Great. When a mere lad he became king of the wild mountain tribes of Epirus, and learned the art of war in the school of Demetrius Poliorcetes and his father Antigonus. He fought by their side at the battle of Ipsus (301) in Phrygia, in which they were decisively defeated by the combined armies of Seleucus Nicator and Lysimachus. Soon afterwards he was sent to the court of Ptolemy of Egypt at Alexandria as a pledge for the faithful carrying out of a treaty of alliance between his brother-in-law Demetrius and Ptolemy. Through Ptolemy, whose step-daughter Antigone he married, Pyrrhus was enabled to establish himself firmly on the throne of Epirus, and became a formidable opponent to Demetrius, who was now king of Macedonia and the leading man in the Greek world. He defeated one of Demetrius's generals in Aetolia, invaded Macedonia, and forced Demetrius to conclude a truce with him. For about seven months Pyrrhus was in possession of a large part of Macedonia, Demetrius finding it convenient to make this surrender on condition that Pyrrhus did not meddle with the affairs of Peloponnesus. But in 286 he was defeated by Lysimachus at Edessa, driven out of Macedonia, and compelled to fall back on his little kingdom of Epirus. In 281 came the great opportunity of his life. An embassy was sent to him from the Greek city Tarentum in southern Italy with a request for aid against Rome, whose hostility the Tarentines had recklessly provoked. After some hesitation on the part of the Tarentines, Pyrrhus's conditions were accepted, and a treaty was concluded. His general Milo crossed with a body of troops and occupied the citadel. Pyrrhus soon followed with a miscellaneous force of about 25,000 men (partly furnished by Ptolemy Ceraunus of Macedonia) and some elephants. The Tarentines and Italian Greeks shrank, however, from anything like serious effort, and resented his calling upon them for men and money. Rome meantime levied a special war contribution, called on her subjects and allies for their full contingent of troops, and posted strong garrisons in all towns of doubtful fidelity. She was now the dominant power in Italy, but her position was critical, as in the north she had had trouble with the Etruscans and the Gauls, while in the south the Lucanians and the Bruttians were making common cause with Tarentum and the Greek cities. For the first time in history Greeks and Romans met in battle at Heraclea near the shores of the Gulf of Tarentum, and the cavalry and elephants of Pyrrhus secured for him a complete victory over the consul M. Valerius Laevinus, though at so heavy a cost as to convince him of the great uncertainty of final success (hence is derived the phrase of a Pyrrhic victory). Although he now had the Samnites as well as the Lucanians and the Bruttians and all the Greek cities of southern Italy with him, he found every city closed against him as he advanced on Rome through Latium. The peace negotiations, carried on by the skillful diplomatist Cineas, the minister of Pyrrhus, led to no result; the senate seemed inclined to come to terms, but

the fiery and patriotic eloquence of the aged and blind Appius Claudius (the censor) carried the day. Cineas was ordered to leave the city at once and to tell his master that Rome could not negotiate so long as foreign troops remained on the soil of Italy. In the second year of the war (279), Pyrrhus again defeated a Roman army at Asculum (mod. Ascoli) in Apulia, but Rome still had armies in the field and her Italian confederation was not broken up. For a while he quitted Italy for Sicily, at the invitation of the Syracusans, with the idea of making himself the head of the Sicilian Greeks and driving the Carthaginians out of the island. In his military operations he was on the whole successful; and Rome and Carthage, in face of the common danger, concluded an offensive and defensive alliance against him. He passed three years in Sicily, but offended the Greek cities, which he governed in the fashion of a despot. Finding that he could no longer hold Sicily in face of the ill feeling thus aroused, and reproached by the Samnites for having deserted them, he decided to return to Italy. On the voyage he was attacked by the Carthaginians and lost several vessels. When he reached Italy, the Tarentines and the other Greek cities, having lost confidence in him, refused to supply him with men or money. Thoroughly disheartened, he made one more effort and engaged a Roman army at Beneventum (275) in the Samnite country, but his arrangements miscarried, and he was defeated with the loss of his camp and the greater part of his army. Nothing remained but to go back to Greece. He left a garrison in Tarentum and returned the following year to his home in Epirus after a six years' absence. The brief remainder of his life was passed in camps and battles, without any glorious result. He gained a victory on Macedonian soil over Antigonus Gonatas, king of Macedonia, whose troops hailed him as king. In 273 he was invited into Peloponnesus by Cleonymus to settle by force of arms a dispute about the royal succession at Sparta. He besieged the city, but was repulsed with great loss. Next, at the invitation of a political faction, he went to Argos, where, during a fight by night in the streets, he was struck on the head by a huge tile. He fell from his horse, and was put to death by one of the soldiers of Antigonus.

Pyrrhus was a brilliant and dashing soldier, but he was aptly compared to a gambler who made many good throws with the dice, but could not make proper use of them in the game. He obtained no lasting results, and was never more than a captain of mercenaries, yet there was something chivalrous about him which seems to have made him a general favourite. After his death Macedonia had, for a time at least, nothing to fear, and the liberty of Greece was quite at the mercy of that power. Pyrrhus wrote a history of the art of war, which is praised by Cicero, and quoted by Dionysius of Halicarnassus and Plutarch.

The chief ancient authority for the life of Pyrrhus is Plutarch; see also Polybius xviii. 11, and elsewhere; Dion. Halic. xviii. 1, xix. 6-9; Pausanias i. 13; Justin xviii. 1, 2, xxiii. 3, xxv. 4, 5. Modern monographs by G. F. Hertzberg, "Rom und König Pyrrhus" (popular: in Ö. Jäger's *Darstellungen aus der römischen Geschichte*, 1870); R. von Scala, *Der Pyrrhische Krieg* (1884), with map of Roman garrison system in 281; R. Schubert, *Geschichte des Pyrrhus* (1894), with full list of authorities; also *ROME: History*, "The Republic."

PYRROL, C_4H_5N or C_4H_7NH , an organic base found in coal-tar and Dippel's oil. It may be synthetically prepared by the dry distillation of ammonium mucate, or, better, by heating it with glycerin to 180-200° C. (H. Schwanert, *Ann.*, 1860, 116, p. 257); by passing the vapour of diethylamine through a red-hot tube; by distilling succinimide with zinc dust (C. A. Bell, *Ber.*, 1880, 13, p. 877); by distilling calcium pyroglutamate: $HO_2C \cdot CH(NH_2) \cdot CH_2 \cdot CH_2 \cdot CO_2H = C_4H_7NH + CO_2 + 2H_2O$ (L. Haitinger, *Monats.*, 1882, 3, p. 228); and by boiling succinic dialdehyde with ammonia and glacial acetic acid (C. Harries, *Ber.*, 1901, 34, p. 1407). It is a feebly basic, colourless liquid which boils at 130° C., and possesses a smell resembling that of chloroform. It is slightly soluble in water, and turns brown on exposure to air. It has to some extent the character of a secondary amine; the hydrogen of the imino group can be replaced by potassium. It is resinified by the action of concentrated mineral acids. On warming solutions of pyrrol in

dilute acid, ammonia is evolved, and an amorphous powder of variable composition, known as *pyrrol-red*, separates out. The pyrrol ring is easily broken, e.g. hydroxylamine gives the dioxime of succinic aldehyde. Pyrrol is readily converted into pyridine derivatives by acting with bromoform, chloroform, or methylene iodide on its potassium salt, β -brom- and β -chloropyridine being obtained with the first two compounds, and pyridine itself with the last. Iodine in alkaline solution converts pyrrol into *iodol* (tetra-iodopyrrol), crystallizing in yellowish-brown needles, which decompose on heating. It may also be prepared by heating tetra-brom- or tetra-chloropyrrol with potassium iodide in alcoholic solution (German patent, 38423, 1886). It is used as an antiseptic.

Zinc dust and hydrochloric acid reduce pyrrol to *pyrrolin* (dihydro-pyrrol), C_4H_6NH , a liquid which boils at $90^\circ C.$ (748 mm.); it is soluble in water and has strongly basic properties and an alkaline reaction. Hydriodic acid at high temperature reduces pyrrol to *pyrrolidine* (tetra-hydropyrrol), C_4H_8NH . Pyrrolidine has also been prepared by A. Thiele (*Ber.*, 1905, 38, p. 4154) from β -chloropropionic aldehyde diethyl acetal. The chlorine atom in this compound is replaced by the cyano-group, which is then reduced to the CH_2NH_2 group and coupled up with benzene sulphochloride to form the compound $C_6H_5SO_2NH(CH_2)_2CH(OC_2H_5)_2$. This substance easily splits out alcohol, and the ring compound then formed yields pyrrolidine on reduction by sodium in amyl alcohol solution. An α -pyrrolidine carboxylic acid and its hydroxy derivatives have been detected by E. Fischer among the products of hydrolysis of proteids. R. Willstätter (*Ber.*, 1900, 33, p. 1164) obtained this acid by the action of a methyl alcoholic solution of ammonia on dibromopropylmalonic ester at $140^\circ C.$, the diamide formed being then hydrolysed either by hydrochloric acid or baryta water:—

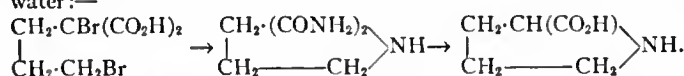

Numerous substitution derivatives of pyrrol are known. The *N*-derivatives are prepared by the action of alkyl halides and acid chlorides on potassium pyrrol. The *C*-derivatives have been prepared in various ways. L. Knorr, by the action of ammonia on aceto-acetic ester, obtained β -imidobutyric ester, which with nitrous acid yields α -isonitroso- β -imidobutyric ester, $CH_3 \cdot C(:NH) \cdot C(:N \cdot OH) \cdot CO_2C_2H_5$. Reduction of this ester leads to the formation of ammonia, hydroxylamine, and dimethyl pyrrol dicarboxylic ester,

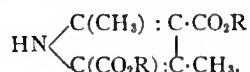

He also found that diaceto succinic ester reacts with compounds of the type NH_2R ($R=H, CH_2, OH, NHC_6H_5, \&c.$) to form pyrrol derivatives:—

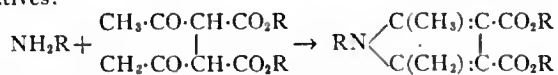

By using compounds of the type NH_2R and acetophenone aceto-acetic ester $C_6H_5CO \cdot CH_2 \cdot CH(COCH_3) \cdot CO_2R$, C. Paal obtained similar results. For the benzo-pyrrols see **INDOLE**.

PYRUVIC ACID, or **PYRORACEMIC ACID**, $CH_3CO \cdot CO_2H$, an organic acid first obtained by J. Berzelius by the dry distillation of tartaric or racemic acids (*Pogg. Ann.*, 1835, 36, p. 1). It may be prepared by boiling α -dichloropropionic acid with silver oxide; by the hydrolysis of acetyl cyanide with hydrochloric acid (J. Claisen and J. Shadwell, *Ber.*, 1878, 11, pp. 620, 1563); and by warming oxalacetic ester with a 10% solution of sulphuric acid. It is usually made by distilling tartaric acid with potassium bisulphate at about $200\text{--}250^\circ C.$, the crude product being afterwards fractionated. It is a liquid which boils at about $165^\circ C.$ (with partial decomposition); it may be solidified, and when pure melts at $13.6^\circ C.$ (L. Simon *Bull. Soc. Chim.*, 1895 [3], 13, p. 335). It is readily soluble in water, alcohol and ether. It reduces ammoniacal silver solutions. When heated with hydrochloric acid to $100^\circ C.$ it yields carbon dioxide and pyrotartaric acid, $C_6H_8O_4$, and when warmed with dilute sulphuric acid to $150^\circ C.$ it gives carbon dioxide and acetaldehyde. Sodium amalgam or zinc and hydrochloric acid reduce it to lactic acid, whilst hydriodic acid gives propionic acid. It readily condenses with aromatic hydrocarbons in the presence of sulphuric acid. It is somewhat readily oxidized; nitric acid gives carbonic and oxalic acids, and chromic acid, carbonic and acetic acids. It forms a well-crystallized hydrazone with phenylhydrazine; and α -nitroso

propionic acid with hydroxylamine. It is monobasic and yields salts which only crystallize with great difficulty; when liberated from these salts by a mineral acid it forms a syrupy non-volatile mass. In aqueous solution it gives a red colour with ferric chloride. It shows characteristic ketone reactions, yielding a bisulphite compound and combining with hydrocyanic acid to form the nitrile of α -oxyisobutyric acid. When warmed with baryta water it gives uvicitic acid.

Pyruvic nitrile, or acetyl cyanide, $CH_3CO \cdot CN$, may be prepared by the action of silver cyanide on acetyl chloride; or of acetyl chloride on nitrosoacetone (L. Claisen and O. Manasse, *Ber.*, 1887, 20, p. 2196). It is a liquid which boils at $93^\circ C.$ and with caustic alkalis polymerizes to diacetyldicyanide.

PYTHAGORAS (6th century B.C.), Greek philosopher, was, in all probability, a native of Samos or one of the neighbouring islands (others say a Tyrrhenian, a Syrian or a Tyrian), and the first part of his life may therefore be said to belong to that Ionian seaboard which had already witnessed the first development of philosophic thought in Greece (see **IONIAN SCHOOL**). The exact year of his birth has been variously placed between 586 and 569 B.C., but 582 may be taken as the most probable date. He was a pupil of Pherecydes (*q.v.*), and later of Hermodamas (Diog. Laërt. viii. 2). He left in Ionia the reputation of a learned and universally informed man. "Of all men Pythagoras, the son of Mnesarchus, was the most assiduous inquirer," says Heraclitus, and then proceeds in his contemptuous fashion to brand his predecessor's wisdom as only eclectically compiled information or polymathy (*πολυμαθία*). This accumulated wisdom, as well as most of the tenets of the Pythagorean school, was attributed in antiquity to the extensive travels of Pythagoras, which brought him in contact (so it was said) not only with the Egyptians, the Phoenicians, the Chaldaeans, the Jews and the Arabians, but also with the Druids of Gaul, the Persian Magi and the Brahmans. But these tales represent only the tendency of a later age to connect the beginnings of Greek speculation with the hoary religions and priesthoods of the East. There is no intrinsic improbability, however, in the statement of Isocrates (*Laud. Busir.* 28, p. 227 Steph.) that Pythagoras visited Egypt and other countries of the Mediterranean, for travel was one of the few ways of gathering knowledge. Some of the accounts (e.g. Callimachus) represent Pythagoras as deriving much of his mathematical knowledge from Egyptian sources, but, however it may have been with the practical beginnings of geometrical knowledge, the scientific development of mathematical principles can be shown to be an independent product of Greek genius. Some of the rules of the Pythagorean ritual have their Egyptian parallels, as Herodotus points out, but it does not necessarily follow that they were borrowed from that quarter, and he is certainly wrong in tracing the doctrine of metempsychosis (*q.v.*) to Egypt.

The historically important part of his career begins with his migration to Crotona, one of the Dorian colonies in the south of Italy, about the year 529. According to tradition, he was driven from Samos by the tyranny of Polycrates. At Crotona Pythagoras speedily became the centre of a widespread and influential organization, which seems to have resembled a religious brotherhood or an association for the moral reformation of society much more than a philosophic school. Pythagoras appears, indeed, in all the accounts more as a moral reformer than as a speculative thinker or scientific teacher; and the doctrine of the school which is most clearly traceable to Pythagoras himself in the ethico-mystical doctrine of transmigration. The Pythagorean brotherhood had its rise in the wave of religious revival which swept over Hellas in the 6th century B.C., and it had much in common with the Orphic communities which sought by rites and abstinences to purify the believer's soul and enable it to escape from "the wheel of birth." Its aims were undoubtedly those of a religious order rather than a political league. But a private religious organization of this description had no place in the traditions of Greek life, and could only maintain itself by establishing "the rule of the saints" on a political basis. The Pythagoreans appear to have established their supremacy for a time over a considerable part of Magna Graecia,

but this entanglement with politics led in the end to the dismemberment and suppression of the society. The authorities differ hopelessly in chronology, but according to the balance of evidence the first reaction against the Pythagoreans took place in the lifetime of Pythagoras after the victory gained by Crotona over Sybaris in 510. Dissensions seem to have arisen about the allotment of the conquered territory, and an adverse party was formed in Crotona under the leadership of Cylon. This was probably the cause of Pythagoras's withdrawal to Metapontum, which an almost unanimous tradition assigns as the place of his death in the end of the 6th or the beginning of the 5th century. The order appears to have continued powerful in Magna Graecia till the middle of the 5th century, when it was violently trampled out. The meeting-houses of the Pythagoreans were everywhere sacked and burned; mention is made in particular of "the house of Milo" in Crotona, where fifty or sixty leading Pythagoreans were surprised and slain.

The persecution to which the brotherhood was subjected throughout Magna Graecia was the immediate cause of the spread of the Pythagorean philosophy in Greece proper. Philolaus, who resided at Thebes in the end of the 5th century (cf. Plato, *Phaedo*, 61 D), was the author of the first written exposition of the system. Lysis, the instructor of Epaminondas, was another of these refugees. This Theban Pythagoreanism had an important influence upon Plato's thought, and Philolaus had also disciples in the stricter sense. But as a philosophic school Pythagoreanism became extinct in Greece about the middle of the 4th century. In Italy—where, after a temporary suppression, it attained a new importance in the person of Archytas of Tarentum—the school finally disappeared about the same time.

Aristotle in his accounts of Pythagorean doctrines never refers to Pythagoras but always with a studied vagueness to "the Pythagoreans" (οἱ καλοῦμενοι Πυθαγόρειοι). Nevertheless, certain doctrines may be traced to the founder's teaching. Foremost among these is the theory of the immortality and transmigration of the soul (see METEMPSYCHOSIS). Pythagoras's teaching on this point is connected by one of the most trustworthy authorities with the doctrine of the kinship of all living beings; and in the light of anthropological research it is easy to recognize the close relationship of the two beliefs. The Pythagorean rule of abstinence from flesh is thus, in its origin, a taboo resting upon the blood-brotherhood of men and beasts; and the same line of thought shows a number of the Pythagorean rules of life which we find embedded in the different traditions to be genuine taboos belonging to a similar level of primitive thought. The moral and religious application which Pythagoras gave to the doctrine of transmigration continued to be the teaching of the school. The view of the body (σῶμα) as the tomb (σῆμα) of the soul, and the account of philosophy in the *Phaedo* as a meditation of death, are expressly connected by Plato with the teaching of Philolaus; and the strain of asceticism and other worldliness which meets us here and elsewhere in Plato is usually traced to Pythagorean influence. Plato's mythical descriptions of a future life of retribution and purificatory wandering can also be shown to reproduce Pythagorean teaching, though the substance of them may have been drawn from a common source in the Mysteries.

The scientific doctrines of the Pythagorean school have no apparent connexion with the religious mysticism of the society or their rules of living. They have their origin in the same disinterested desire of knowledge which gave rise to the other philosophical schools of Greece, and the idea of "philosophy" or the "theoretic life" as a method of emancipation from the evils of man's present state of existence, though a genuine Pythagorean conception, is clearly an afterthought. The discourses and speculations of the Pythagoreans all connect themselves with the idea of number, and the school holds an important place in the history of mathematical and astronomical science. An unimpeached tradition carries back the Pythagorean theory of numbers to the teaching of the founder himself. Working on hints contained in the oldest traditions, recent investigators have shown that the discoveries attributed to Pythagoras connect themselves with a primitive numerical symbolism, according to which numbers were represented by dots arranged in symmetrical patterns, such as are still to be seen in the marking of dice or dominoes. Each pattern of units becomes on this plan a fresh unit. The "holy tetractys," by which the later Pythagoreans used to swear, was a figure of

this kind $\begin{matrix} & & \cdot & & \\ & \cdot & & \cdot & \\ \cdot & & \cdot & & \cdot \\ & \cdot & & \cdot & \\ & & \cdot & & \end{matrix}$ representing the number 10 as the triangle of 4, and showing at a glance that $1 + 2 + 3 + 4 = 10$. The sums of the series of any successive numbers may be graphically

represented in a similar way, and are hence spoken of as "triangular numbers," while the sums of the series of successive odd numbers are called "square numbers," and those of successive even numbers "oblong numbers"; thus 3 and 5 added to the unit give a figure

of this description $\begin{matrix} \cdot & & \cdot & & \cdot \\ \cdot & & & & \cdot \\ \cdot & & \cdot & & \cdot \\ \cdot & & & & \cdot \\ \cdot & & \cdot & & \cdot \end{matrix}$ while 4 and 6, added to 2, are thus

represented $\begin{matrix} & & \cdot & & \\ & \cdot & & \cdot & \\ \cdot & & \cdot & & \cdot \\ & \cdot & & \cdot & \\ & & \cdot & & \end{matrix}$ Such a method of representing number

in areas leads naturally to problems of a geometrical nature, and as the practical use of the right-angled triangle was already familiar in the arts and crafts, there is no reason to dispute the well-established tradition which assigns to Pythagoras the discovery of the proposition that in such a triangle the square on the hypotenuse is equal to the sum of the squares on the other two sides. And it is probably also correct to attribute to him the discovery of the harmonic intervals which underlie the production of musical sounds. Impressed by this reduction of musical sounds to numbers and by the presence of numerical relations in every department of phenomena, Pythagoras and his early followers enunciated the doctrine that "all things are numbers." Numbers seemed to them, as Aristotle put it, to be the first things in the whole of nature, and they supposed the elements of numbers to be the elements of all things, and the whole heaven to be a musical scale and a number (*Meta. A. 986a*). Numbers, in other words, were conceived at that early stage of thought not as relations or qualities predicable of things, but as themselves constituting the substance or essence of the phenomena—the rational reality to which the appearances of sense are reducible.

But the development of these ideas into a comprehensive metaphysical system was no doubt the work of Philolaus in the latter part of the 5th century. His formulation of the theory implies a knowledge of the teaching of Parmenides and Empedocles, and had itself in turn a great influence upon Plato. The "elements of numbers," of which Aristotle speaks in the passage quoted above, were, according to the Pythagoreans, the Odd and the Even, which they identified with the Limit and the Unlimited; and Aristotle distinctly says that they did not treat these as "priorities of certain other substances" such as fire, water or anything else of that sort, but that the unlimited itself and the one were the reality of the things of which they were predicated, and that is why they said that number was "the reality of everything" (*Meta. A. 587*). Numbers, therefore, are spatially conceived, "one" being identified with the point in the sense of a unit having position and magnitude. From combinations of such units the higher numbers and geometrical figures arise—"two" being identified with the line, "three" with the surface, and "four" with the solid—and the Pythagoreans proceeded to explain the elements of Empedocles as built up out of geometrical figures in the manner followed by Plato in the *Timæus*. The identification of the numerical opposites, the Odd and the Even, with the Limit and the Unlimited—otherwise difficult to explain—may perhaps be understood, as Burnet suggests, by reference to the arrangement of the units or "terms" (ἄρτοι) in patterns. "When the odd is divided into two equal parts," he quotes from Stobæus, "a unit is left over in the middle; but when the even is so divided, an empty field is left over, without a master and without a number, showing that it is defective and incomplete." The idea of opposites, derived, perhaps, originally from Heraclitus, was developed by the Pythagoreans in a list of ten fundamental oppositions, bearing a certain resemblance to the tables of categories framed by later philosophers, but in its arbitrary mingling of mathematical, physical and ethical contrasts characteristic of the uncritical beginnings of speculative thought: (1) limited and unlimited, (2) odd and even, (3) one and many, (4) right and left, (5) male and female, (6) rest and motion, (7) straight and curved, (8) light and darkness, (9) good and evil, (10) square and oblong. To the Pythagoreans, as to Heraclitus, the universe was in a sense the realized union of these opposites, but interpretations of Pythagoreanism which represent the whole system as founded on the opposition of unity and duality, and proceed to identify this with the opposition of form and matter, of divine activity and passive material, betray on the surface their post-Platonic origin. Still more is this the case when in Neoplatonic fashion they go on to derive this original opposition from the supreme unity or God. The further speculations of the Pythagoreans on the subject of number rest mainly on analogies, which often become capricious and tend to lose themselves at last in a barren symbolism. "Seven" is called *καρθίνοσ* and *Ἀθήνη*, because within the decade it has neither factors nor product. "Five," on the other hand, signifies marriage, because it is the union of the first masculine with the first feminine number (3+2, unity being considered as a number apart). The thought already becomes more fanciful when "one" is identified with reason, because it is unchangeable; "two" with opinion, because it is unlimited and indeterminate; "four" with justice, because it is the first square number, the product of equals.

The astronomy of the Pythagoreans was their most notable contribution to scientific thought, and its importance lies in the fact that they were the first to conceive the earth as a globe.

self-supported in empty space, revolving with the other planets round a central luminary. They thus anticipated the heliocentric theory, and Copernicus has left it on record that the Pythagorean doctrine of the planetary movement of the earth gave him the first hint of its true hypothesis. The Pythagoreans did not, however, put the sun in the centre of the system. That place was filled by the central fire to which they gave the names of Hestia, the hearth of the universe, the watch-tower of Zeus, and other mythological expressions. It had then been recently discovered that the moon shone by reflected light, and the Pythagoreans (adapting a theory of Empedocles), explained the light of the sun also as due to reflection from the central fire. Round this fire revolve ten bodies, first the Antichthon or counter-earth, then the earth, followed in order by the moon, the sun, the five then known planets and the heaven of the fixed stars. The central fire and the counter-earth are invisible to us because the side of the earth on which we live is always turned away from them, and our light and heat come to us, as already stated, by reflection from the sun. When the earth is on the same side of the central fire as the sun, the side of the earth on which we live is turned towards the sun and we have day; when the earth and the sun are on opposite sides of the central fire we are turned away from the sun and it is night. The distance of the revolving orbs from the central fire was determined according to simple numerical relations, and the Pythagoreans combined their astronomical and their musical discoveries in the famous doctrine of "the harmony of the spheres." The velocities of the bodies depend upon their distances from the centre, the slower and nearer bodies giving out a deep note and the swifter a high note, the concert of the whole yielding the cosmic octave. The reason why we do not hear this music is that we are like men in a smith's forge, who cease to be aware of a sound which they constantly hear and are never in a position to contrast with silence.

AUTHORITIES.—Zeller's account of Pythagoreanism in his *Philosophie der Griechen* gives a full account of the sources, with critical references in the notes to the numerous monographs on the subject, but the labour and ingenuity of more recent scholars has succeeded in clearing up a number of points since he wrote. Diels, *Doxographi graeci* (1879), and *Die Fragmente der Vorsokratiker*, vol. i. (2nd ed., 1906). Gomperz, *Greek Thinkers*, vol. i., and especially Burnet's *Early Greek Philosophy* (2nd ed., 1908), give the results of the latest investigations. Tannery's *Science hellène*; Milhaud's *La Science grecque* and *Philosophes géomètres*; Cantor's *History of Mathematics*; and Gow's *Short History of Greek Mathematics*, refer to the mathematical and physical doctrines of the school.

(A. S. P.-P.)

PYTHAGOREAN GEOMETRY

As the introduction of geometry into Greece is by common consent attributed to Thales, so all are agreed that to Pythagoras is due the honour of having raised mathematics to the rank of a science. We know that the early Pythagoreans published nothing, and that, moreover, they referred all their discoveries back to their master (see PHILOLAUS). Hence it is not possible to separate his work from that of his early disciples, and we must therefore treat the geometry of the early Pythagorean school as a whole. We know that Pythagoras made numbers the basis of his philosophical system, as well physical as metaphysical, and that he united the study of geometry with that of arithmetic.

The following statements have been handed down to us. (a) Aristotle (*Meta.* i. 5, 985) says "the Pythagoreans first applied themselves to mathematics, a science which they improved; and, penetrated with it, they fancied that the principles of mathematics were the principles of all things." (b) Eudemus informs us that "Pythagoras changed geometry into the form of a liberal science, regarding its principles in a purely abstract manner, and investigated its theorems from the immaterial and intellectual point of view (*ἀλόως καὶ νοερώς*)."¹ (c) Diogenes Laërtius (viii. 11) relates that "it was Pythagoras who carried geometry to perfection, after Moeris² had first found out the principles of the elements of that science, as Anticlistides tells us in the second book of his *History of Alexander*; and the part of the science to which Pythagoras applied himself above all others was arithmetic." (d) According to Aristoxenus, the musician, Pythagoras seems to have esteemed arithmetic above everything, and to have advanced it by diverting it from the service of commerce and by likening all things to numbers.³ (e) Diogenes Laërtius (viii. 13) reports on the same authority that Pythagoras was the first person who introduced measures and weights among the Greeks. (f) He discovered the numerical relations of the musical scale (Diog.

Laërt. viii. 11). (g) Proclus⁴ says that "the word 'mathematics' originated with the Pythagoreans." (h) We learn also from the same authority⁵ that the Pythagoreans made a fourfold division of mathematical science, attributing one of its parts to the "how many" (*τὸ πῶσον*) and the other to the "how much" (*τὸ πηλίκον*); and they assigned to each of these parts a twofold division. They said that discrete quantity or the "how many" is either absolute or relative, and that continued quantity or the "how much" is either stable or in motion. Hence they laid down that arithmetic contemplates that discrete quantity which subsists by itself, but music that which is related to another; and that geometry considers continued quantity so far as it is immovable, but that astronomy (*ἡ σφαιρική*) contemplates continued quantity so far as it is of a self-motive nature. (i) Diogenes Laërtius (viii. 25) states, on the authority of Favorinus, that Pythagoras "employed definitions in the mathematical subjects to which he applied himself."

The following notices of the geometrical work of Pythagoras and the early Pythagoreans are also preserved. (1) The Pythagoreans define a point as "unity having position" (Procl. *op. cit.* p. 95). (2) They considered a point as analogous to the monad, a line to the dyad, a superficies to the triad, and a body to the tetrad (*ibid.* p. 97). (3) They showed that the plane around a point is completely filled by six equilateral triangles, four squares, or three regular hexagons (*ibid.* p. 305). (4) Eudemus ascribes to them the discovery of the theorem that the interior angles of a triangle are equal to two right angles, and gives their proof, which was substantially the same as that in Euclid I. 32⁶ (*ibid.* p. 379). (5) Proclus informs us in his commentary on Euclid I. 44 that Eudemus says that the problems concerning the application of areas—where the term "application" is not to be taken in its restricted sense (*παραβολή*), in which it is used in this proposition, but also in its wider signification, embracing *ὑπερβολή* and *ἄλλειψις*, in which it is used in Book VI. Props. 28, 29—are old, and inventions of the Pythagoreans⁷ (*ibid.* p. 419). (6) This is confirmed by Plutarch,⁸ who says, after Apollodorus, that Pythagoras sacrificed an ox on finding the geometrical diagram, either the one relating to the hypotenuse, viz. that the square on it is equal to the sum of the squares on the sides, or that relating to the problem concerning the application of an area.⁹ (7) Plutarch¹⁰ also ascribes to Pythagoras the solution of the problem, To construct a figure equal to one and similar to another given figure. (8) Eudemus states that Pythagoras discovered the construction of the regular solids (Procl. *op. cit.* p. 65). (9) Hippasus, the Pythagorean, is said to have perished in the sea on account of his impiety, inasmuch as he boasted that he first divulged the knowledge of the sphere with the twelve pentagons (the inscribed ordinate dodecahedron): Hippasus assumed the glory of the discovery to himself, whereas everything belonged to Him—"for thus they designate Pythagoras, and do not call him by name."¹¹ (10) The triple interwoven triangle or pentagram—star-shaped regular pentagon—was used as a symbol or sign of recognition by the Pythagoreans and was called by them "health" (*ὑγιεῖα*).¹² (11) The discovery of the law of the three

⁴ Procl. *op. cit.* p. 45.

⁵ *Op. cit.* p. 35.

⁶ We learn from a fragment of Geminus, which has been handed down by Eutocius in his commentary on the *Conics* of Apollonius (Apoll. *Conica*, ed. Halleus, p. 9), that the ancient geometers observed two right angles in each species of triangle, in the equilateral first, then in the isosceles, and lastly in the scalene, whereas later writers proved the theorem generally thus—"The three internal angles of every triangle are equal to two right angles."

⁷ The words of Proclus are interesting. "According to Eudemus the inventions respecting the application, excess and defect of areas are ancient, and are due to the Pythagoreans. Moderns, borrowing these names, transferred them to the so-called conic lines, the parabola, the hyperbola, the ellipse, as the older school, in their nomenclature concerning the description of areas in *plano* on a finite right line, regarded the terms thus: An area is said to be *applied* (*παραβάλλειν*) to a given right line when an area equal in content to some given one is described thereon; but when the base of the area is greater than the given line, then the area is said to be in *excess* (*ὑπερβάλλειν*); but when the base is less, so that some part of the given line lies without the described area, then the area is said to be in *defect* (*ἐλλείπειν*). Euclid uses in this way in his sixth book the terms *excess* and *defect*. . . . The term *application* (*παραβάλλειν*), which we owe to the Pythagoreans, has this signification."

⁸ *Non posse suaviter vivi sec. Epicurum*, c. xi.

⁹ *Ἐπεὶ πρόβλημα περὶ τοῦ χωρίου τῆς παραβολῆς*. Some authors, rendering the last five words "concerning the area of the parabola," have ascribed to Pythagoras the quadrature of the parabola, which was one of the great discoveries of Archimedes.

¹⁰ *Symp.* viii., Quaest. 2, c. 4.

¹¹ Iamblichus, *De vit. Pyth.* c. 18, § 88.

¹² Lucian, *Pro lapsu in salut.* § 5; also schol. on Aristoph. *Nub.* 611. That the Pythagoreans used such symbols we learn from Iamblichus (*De vit. Pyth.* c. 33, §§ 237 and 238). This figure is referred to Pythagoras himself, and in the middle ages was called *Pythagorae figura*; even so late as Paracelsus it was regarded by

¹ Proclus Diadochus, *In primum Euclidis elementorum librum commentarii*, ed. Friedlein, p. 65.

² Moeris was a king of Egypt who, Herodotus tells us, lived 900 years before his visit to that country.

³ Aristox. *Fragm.* ap. Stob. *Eclog. Phys.* i. 2, 6.

squares (Euclid I. 47), commonly called the "theorem of Pythagoras," is attributed to him by many authorities, of whom the oldest is Vitruvius.¹ (12) One of the methods of finding right-angled triangles whose sides can be expressed in numbers (Pythagorean triangles)—that setting out from the odd numbers—is referred to Pythagoras by Heron of Alexandria and Proclus.² (13) The discovery of irrational quantities is ascribed to Pythagoras by Eudemus (Procl. *op. cit.* p. 65). (14) The three proportions—arithmetical, geometrical and harmonical—were known to Pythagoras.³ (15) Iamblichus⁴ says, "Formerly, in the time of Pythagoras and the mathematicians under him, there were three means only—the arithmetical, the geometrical and the third in order, which was known by the name sub-contrary (*ὕπερσπαστα*), but which Archytas and Hippasus designated the harmonical, since it appeared to include the ratios concerning harmony and melody." (16) The so-called most perfect or musical proportion, e.g. 6 : 8 :: 9 : 12, which comprehends in it all the former ratios, according to Iamblichus,⁵ is said to be an invention of the Babylonians and to have been first brought into Greece by Pythagoras. (17) Arithmetical progressions were treated by the Pythagoreans, and it appears from a passage in Lucian that Pythagoras himself had considered the special case of *triangular numbers*: Pythagoras asks some one, "How do you count?" He replies, "One, two, three, four." Pythagoras, interrupting, says, "Do you see? what you take to be four, that is ten and a perfect triangle and our oath."⁶ (18) The odd numbers were called by the Pythagoreans "gnomons,"⁷ and were regarded as generating, inasmuch as by the addition of successive gnomons—consisting each of an odd number of unit squares—to the original square unit or monad the square form was preserved. (19) In like manner, if the simplest oblong (*ἑτερομήκης*), consisting of two unit squares or monads in juxtaposition, be taken and four unit squares be placed about it after the manner of a gnomon, and then in like manner six, eight . . . unit squares be placed in succession, the oblong form will be preserved. (20) Another of his doctrines was, that of all solid figures the sphere was the most beautiful, and of all plane figures the circle.⁸ (21) According to Iamblichus the Pythagoreans are said to have found the quadrature of the circle.⁹

him as a symbol of health. It is said to have obtained its special name from the letters $\nu, \gamma, \iota, \theta (= \epsilon)$, α having been written at its prominent vertices.

¹ *De arch.* ix.; Praef. 5, 6, 7. Amongst other authorities are Diogenes Laërtius (viii. 11), Proclus (*op. cit.*, p. 426), and Plutarch (*ut supra*, 6). Plutarch, however, attributes to the Egyptians the knowledge of this theorem in the particular case where the sides are 3, 4, and 5 (*De Is. et Osir.* c. 56).

² Heron Alex. *Geom. et stereom. rel.*, ed. F. Hultsch, pp. 56, 146; Procl. *op. cit.* p. 428. The method of Pythagoras is as follows: he took an odd number as the lesser side; then, having squared this number and diminished the square by unity, he took half the remainder as the greater side, and by adding unity to this number he obtained the hypotenuse, e.g. 3, 4, 5; 5, 12, 13.

³ Nicom. *Ger. Introd. Ar. c.* xxii.

⁴ *In Nicomachi arithmetica*, ed. S. Tennulius, p. 141.

⁵ *Op. cit.* p. 168. As an example of this proportion Nicomachus and, after him, Iamblichus give the numbers 6, 8, 9, 12, the harmonical and arithmetical means between two numbers forming a geometric proportion with the numbers themselves ($a : \frac{2ab}{a+b} :: \frac{a+b}{2} : b$).

Iamblichus further relates (*loc. cit.*) that many Pythagoreans made use of this proportion, as Aristaeus of Crotona, Timaeus of Locri, Philolaus and Archytas of Tarentum and many others, and after them Plato in his *Timaeus* (see Nicom. *Insl. arithm.*, ed. Ast, p. 153, and *Animadversiones*, pp. 327-329; and Iamb. *op. cit.* p. 172 seq.).

⁶ *Βίων πρόβας*, 4, i. 317, ed. C. Jacobitz.

⁷ *Γνώμων* means that by which anything is known or "criterion"; its oldest concrete signification seems to be the carpenter's square (*norma*) by which a right angle is known. Hence it came to denote a perpendicular, of which, indeed, it was the archaic name (Proclus, *op. cit.* p. 283). Gnomon is also an instrument for measuring altitudes, by means of which the meridian can be found; it denotes, further, the index or style of a sundial, the shadow of which points out the hours. In geometry it means the square or rectangle about the diagonal of a square or rectangle, together with the two complements, on account of the resemblance of the figure to a carpenter's square; and then, more generally, the similar figure with regard to any parallelogram, as defined by Euclid II. def. 2. Again, in a still more general signification, it means the figure which, being added to any figure, preserves the original form. See Heron, *Definitiones* (59). When gnomons are added successively in this manner to a square monad, the first gnomon may be regarded as that consisting of three square monads, and is indeed the constituent of a simple Greek fret; the second of five square monads, &c.; hence we have the gnomonic numbers.

⁸ *Diag. Laërt. De vit. Pyth.* viii. 19.

⁹ Simplicius, *In Aristotelis physicorum libros quatuor priores commentaria*, ed. H. Diels, p. 60.

On examining the purely geometrical work of Pythagoras and his early disciples, as given in the preceding extracts, we observe that it is much concerned with the geometry of areas, and we are indeed struck with its Egyptian character. This appears in the theorem (3) concerning the filling up a plane with regular figures—for floors or walls covered with tiles of various colours were common in Egypt; in the construction of the regular solids (8), for some of them are found in Egyptian architecture; in the problems concerning the application of areas (5); and lastly, in the theorem of Pythagoras (11), coupled with his rule for the construction of right-angled triangles in numbers (12). We learn from Plutarch that the Egyptians were acquainted with the geometrical fact that a triangle whose sides contain three, four and five parts is right-angled, and that the square of the greatest side is equal to the squares of the sides containing the right angle. It is probable too that this theorem was known to them in the simple case where the right-angled triangle is isosceles, inasmuch as it would be at once suggested by the contemplation of a floor covered with square tiles—the square on the diagonal and the sum of the squares on the sides contain each four of the right-angled triangles into which one of the squares is divided by its diagonal. It is easy now to see how the problem to construct a square which shall be equal to the sum of two squares could, in some cases, be solved numerically. From the observation of a chequered board it would be perceived that the element in the successive formation of squares is the gnomon or carpenter's square. Each gnomon consists of an odd number of squares, and the successive gnomons correspond to the successive odd numbers, and include, therefore, all odd squares. Suppose, now, two squares are given, one consisting of sixteen and the other of nine unit squares, and that it is proposed to form from them another square. It is evident that the square consisting of nine unit squares can take the form of the fourth gnomon, which, being placed round the former square, will generate a new square containing twenty-five unit squares. Similarly it may have been observed that the twelfth gnomon, consisting of twenty-five unit squares, could be transformed into a square each of whose sides contains five units, and thus it may have been seen conversely that the latter square, by taking the gnomonic or generating form with respect to the square on twelve units as base, would produce the square of thirteen units, and so on. This method required only to be generalized in order to enable Pythagoras to arrive at his rule for finding right-angled triangles whose sides can be expressed in numbers, which, we are told, sets out from the odd numbers. The n th square together with the n th gnomon forms the $(n+1)$ th square; if the n th gnomon contains m^2 unit squares, m being an odd number, we have $2n+1=m^2$, $\therefore n=\frac{1}{2}(m^2-1)$, which gives the rule of Pythagoras.

The general proof of Euclid I. 47 is attributed to Pythagoras, but we have the express statement of Proclus (*op. cit.* p. 426) that this theorem was not proved in the first instance as it is in the *Elements*. The following simple and natural way of arriving at the theorem is suggested by Bretschneider after Camerer.¹⁰ A square can be dissected into the sum of two squares and two equal rectangles, as in Euclid II. 4; these two rectangles can, by drawing their diagonals, be decomposed into four equal right-angled triangles, the sum of the sides of each being equal to the side of the square; again, these four right-angled triangles can be placed so that a vertex of each shall be in one of the corners of the square in such a way that a greater and less side are in continuation. The original square is thus dissected into the four triangles as before and the figure within, which is the square on the hypotenuse. This square, therefore, must be equal to the sum of the squares on the sides of the right-angled triangle.

It is well known that the Pythagoreans were much occupied with the construction of regular polygons and solids, which in their cosmology played an essential part as the fundamental forms of the elements of the universe. We can trace the origin of these mathematical speculations in the theorem (3) that "the plane around a point is completely filled by six equilateral triangles, four squares, or three regular hexagons." Plato also makes the Pythagorean Timaeus explain—"Each straight-lined figure consists of triangles, but all triangles can be dissected into rectangular ones which are either isosceles or scalene. Among the latter the most beautiful is that out of the doubling of which an equilateral arises, or in which the square of the greater perpendicular is three times that of the smaller, or in which the smaller perpendicular is half the hypotenuse. But two or four right-angled isosceles triangles, properly put together, form the square; two or six of the most beautiful scalene right-angled triangles form the equilateral triangle; and out of these two figures arise the solids which correspond with the four elements of the real world, the tetrahedron, octahedron, icosahedron and the cube"¹¹ (*Timaeus*, 53, 54, 55). The construction of the regular solids is distinctly ascribed to Pythagoras himself by Eudemus (8). Of these five

¹⁰ See Bretsch. *Die Geom. vor Euklides*, p. 82; Camerer, *Euclidis elem.* i. 444, and the references given there.

¹¹ The dodecahedron was assigned to the fifth element, *quinta pars aether*, or, as some think, to the universe. (See PHILOLAUS.)

solids three—the tetrahedron, the cube and the octahedron—were known to the Egyptians and are to be found in their architecture. Let us now examine what is required for the construction of the other two solids—the icosahedron and the dodecahedron. In the formation of the tetrahedron three, and in that of the octahedron four, equal equilateral triangles had been placed with a common vertex and adjacent sides coincident; and it was known that if six such triangles were placed round a common vertex with their adjacent sides coincident, they would lie in a plane, and that, therefore, no solid could be formed in that manner from them. It remained, then, to try whether five such equilateral triangles could be placed at a common vertex in like manner; on trial it would be found that they could be so placed, and that their bases would form a regular pentagon. The existence of a regular pentagon would thus become known. It was also known from the formation of the cube that three squares could be placed in a similar way with a common vertex; and that, further, if three equal and regular hexagons were placed round a point as common vertex with adjacent sides coincident, they would form a plane. It remained in this case, too, only to try whether three equal regular pentagons could be placed with a common vertex and in a similar way; this on trial would be found possible and would lead to the construction of the regular dodecahedron, which was the regular solid last arrived at.

We see that the construction of the regular pentagon is required for the formation of each of these two regular solids, and that, therefore, it must have been a discovery of Pythagoras. If we examine now what knowledge of geometry was required for the solution of this problem, we shall see that it depends on Euclid IV. 10, which is reduced to Euclid II. 11, which problem is reduced to the following: To produce a given straight line so that the rectangle under the whole line thus produced and the produced part shall be equal to the square on the given line, or, in the language of the ancients, To apply to a given straight line a rectangle which shall be equal to a given area—in this case the square on the given line—and which shall be *excessive* by a square. Now it is to be observed that the problem is solved in this manner by Euclid (VI. 30, 1st method), and that we know on the authority of Eudemos that the problems concerning the *application* of areas and their *excess* and *defect* are old, and inventions of the Pythagoreans (5). Hence the statements of Iamblichus concerning Hippasus (9)—that he divulged the sphere with the twelve pentagons—and of Lucian and the scholiast on Aristophanes (10)—that the pentagram was used as a symbol of recognition amongst the Pythagoreans—become of greater importance.

Further, the discovery of irrational magnitudes is ascribed to Pythagoras by Eudemos (13), and this discovery has been ever regarded as one of the greatest of antiquity. It is commonly assumed that Pythagoras was led to this theory from the consideration of the isosceles right-angled triangle. It seems to the present writer, however, more probable that the discovery of incommensurable magnitudes was rather owing to the problem: To cut a line in extreme and mean ratio. From the solution of this problem it follows at once that, if on the greater segment of a line so cut a part be taken equal to the less, the greater segment, regarded as a new line, will be cut in a similar manner; and this process can be continued without end. On the other hand, if a similar method be adopted in the case of any two lines which can be represented numerically, the process would end. Hence would arise the distinction between commensurable and incommensurable quantities. A reference to Euclid X. 2 will show that the method above is the one used to prove that two magnitudes are incommensurable; and in Euclid X. 3 it will be seen that the greatest common measure of two commensurable magnitudes is found by this process of continued subtraction. It seems probable that Pythagoras, to whom is attributed one of the rules for representing the sides of right-angled triangles in numbers, tried to find the sides of an isosceles right-angled triangle numerically, and that, failing in the attempt, he suspected that the hypotenuse and a side had no common measure. He may have demonstrated the incommensurability of the side of a square and its diagonal. The nature of the old proof—which consisted of a *reductio ad absurdum*, showing that, if the diagonal be commensurable with the side, it would follow that the same number would be odd and even¹—makes it more probable, however, that this was accomplished by his successors. The existence of the irrational as well as that of the regular dodecahedron appears to have been regarded by the school as one of their chief discoveries, and to have been preserved as a secret; it is remarkable, too, that a story similar to that told by Iamblichus of Hippasus is narrated of the person who first published the idea of the irrational, viz. that he suffered shipwreck, &c.²

Eudemos ascribes the problems concerning the application of figures to the Pythagoreans. The simplest cases of the problems,

Euclid VI. 28, 29—those, viz. in which the given parallelogram is a square—correspond to the problem: To cut a given straight line internally or externally so that the rectangle under the segments shall be equal to a given rectilinear figure. The solution of this problem—in which the solution of a quadratic equation is implicitly contained—depends on the problem, Euclid II. 14, and the theorems, Euclid II. 5 and 6, together with the theorem of Pythagoras. It is probable that the finding of a mean proportional between two given lines, or the construction of a square which shall be equal to a given rectangle, is due to Pythagoras himself. The solution of the more general problem, Euclid VI. 25, is also attributed to him by Plutarch (7). The solution of this problem depends on that of the particular case and on the application of areas; it requires, moreover, a knowledge of the theorems: Similar rectilinear figures are to each other as the squares on their homologous sides (Euclid VI. 20); and, If three lines are in geometrical proportion, the first is to the third as the square on the first is to the square on the second. Now Hippocrates of Chios, about 440 B.C., who was instructed in geometry by the Pythagoreans, possessed this knowledge. We are justified, therefore, in ascribing the solution of the general problem, if not (with Plutarch) to Pythagoras, at least to his early successors.

The theorem that similar polygons are to each other in the duplicate ratio of their homologous sides involves a first sketch, at least, of the doctrine of proportion and the similarity of figures.³ That we owe the foundation and development of the doctrine of proportion to Pythagoras and his school is confirmed by the testimony of Nicomachus (14) and Iamblichus (15 and 16). From these passages it appears that the early Pythagoreans were acquainted not only with the arithmetical and geometrical means between two magnitudes, but also with their harmonic mean, which was then called "subcontrary." The Pythagoreans were much occupied with the representation of numbers by geometrical figures. These speculations originated with Pythagoras, who was acquainted with the summation of the natural numbers, the odd numbers and the even numbers, all of which are capable of geometrical representation. See the passage in Lucian (17) and the rule for finding Pythagorean triangles (12) and the observations thereon *supra*. On the other hand, there is no evidence to support the statement of Montucla that Pythagoras laid the foundation of the doctrine of *isoperimetry*, by proving that of all figures having the same perimeter the circle is the greatest, and that of all solids having the same surface the sphere is the greatest. We must also deny to Pythagoras and his school a knowledge of the conic sections, and in particular of the quadrature of the parabola, attributed to him by some authors; and we have noticed the misconception which gave rise to this erroneous inference.

Certain conclusions may be drawn from the foregoing examination of the mathematical work of Pythagoras and his school, which enable us to form an estimate of the state of geometry about 480 B.C. First, as to *matter*. It forms the bulk of the first two books of Euclid, and includes a sketch of the doctrine of proportion—which was probably limited to commensurable magnitudes—together with some of the contents of the sixth book. It contains, too, the discovery of the irrational (*ἄλογον*) and the construction of the regular solids, the latter requiring the description of certain regular polygons—the foundation, in fact, of the fourth book of Euclid. Secondly, as to *form*. The Pythagoreans first severed geometry from the needs of practical life, and treated it as a liberal science, giving definitions and introducing the manner of proof which has ever since been in use. Further, they distinguished between *discrete* and *continuous* quantities, and regarded geometry as a branch of mathematics, of which they made the fourfold division that lasted to the middle ages—the *quadrivium* (fourfold way to knowledge) of Boetius and the scholastic philosophy. And it may be observed that the name of "mathematics," as well as that of "philosophy," is ascribed to them. Thirdly, as to *method*. One chief characteristic of the mathematical work of Pythagoras was the

³ It is agreed on all hands that these two theories were treated at length by Pythagoras and his school. It is almost certain, however, that the theorems arrived at were proved for commensurable magnitudes only, and were assumed to hold good for all. The Pythagoreans themselves seem to have been aware that their proofs were not rigorous, and were open to serious objection; in this we may have the explanation of the secrecy which was attached by them to the idea of the incommensurable and to the pentagram which involved, and indeed represented, that idea. Now it is remarkable that the doctrine of proportion is *twice* treated in the *Elements* of Euclid—first, in a general manner, so as to include incommensurables, in book v., which tradition ascribes to Eudoxus, and then arithmetically in book vii., which, as Hankel has supposed, contains the treatment of the subject by the older Pythagoreans.

¹ For this proof, see Euclid X. 117; see also Aristot. *Analyt. Pr. i.* c. 23 and c. 44.

² Knoche, *Untersuchungen über die neuaufgefundenen Scholien des Proklus Diadochos zu Euclids Elementen*, pp. 20 and 23 (Herford, 1865).

combination of arithmetic with geometry. The notions of an equation and a proportion—which are common to both, and contain the first germ of algebra—were introduced among the Greeks by Thales. These notions, especially the latter, were elaborated by Pythagoras and his school, so that they reached the rank of a true scientific method in their theory of proportion. To Pythagoras, then, is due the honour of having supplied a method which is common to all branches of mathematics, and in this respect he is fully comparable to Descartes, to whom we owe the decisive combination of algebra with geometry.

See G. J. Allman, *Greek Geometry from Thales to Euclid* (Cambridge, 1889); M. Cantor, *Vorlesungen über Geschichte der Mathematik* (Leipzig, 1894); James Gow, *Short History of Greek Mathematics* (Cambridge, 1884). (G. J. A.)

PYTHAGORAS, of Rhegium, a noted Greek sculptor of the 5th century B.C., a contemporary of Myron and Polyclitus, and their rival in making statues of athletes. He was born at Samos and migrated in his youth to Rhegium in Italy. He made a statue of Philoctetes notable for the physical expression of pain, an Apollo shooting the Python at Delphi, and a man singing to the lyre. He is said to have introduced improvements in the rendering of muscles, veins and hair.

PYTHEAS, of Massilia (*Massilia*), a celebrated Greek navigator and geographer, from whom the Greeks apparently derived their earliest definite information concerning western Europe, and especially the British Islands. He was probably contemporary with Alexander the Great; he certainly wrote before Dicaearchus, a pupil of Aristotle who died about 285 B.C. His work is lost, and we are left almost wholly in the dark as to its form and character, but the various titles under which it is quoted (e.g. *Ἦς περίοδος*, or *Τὰ περὶ τοῦ Ὠκεανοῦ*) point to a geographical treatise, in which Pytheas had embodied the results of his observations, rather than to a continuous narrative of his voyage.

Some modern writers have supposed Pytheas to have been sent out, at public expense, in command of an expedition organized by the republic of Massilia; but there is no ancient authority for this, and Polybius, who had unquestionably seen the original work, expressly states that he had undertaken the voyage in a private capacity and with limited means. All that we know concerning the voyage of Pytheas (apart from detached notices) is contained in a brief passage of Polybius, cited by Strabo, in which he tells us that Pytheas, according to his own statement, had not only visited Britain, but had personally explored a large part of it ("travelled all over it on foot," according to one reading of the text in Strabo, bk. iv. ch. i.), and estimated its circumference at more than 40,000 stadia (4000 geographical miles). To this he added the account of Thule (which he placed six days' voyage north of Britain) and the adjoining regions, in which there was no longer any distinction between air, earth and sea, but a kind of mixture of all three, resembling the gelatinous mollusc known as *pulmo marinus*, which rendered all navigation and progress in any other mode alike impossible. This substance Pytheas had himself seen, according to Strabo (bk. iv. ch. i.), but the other phenomena he described only from hearsay. After this he visited "the whole of the coasts of Europe" (i.e. those bordering on the ocean) as far as the *Tanais* (Strabo, bk. ii. ch. iv. § 1). This last sentence has led some modern writers to suppose that he made two different voyages; but this is improbable; the expressions of Polybius imply that his explorations in both directions, first towards the north and afterwards towards the east, formed part of the same voyage.

The countries visited, and to a certain extent explored, by Pytheas, were previously unknown to the Greeks—except, perhaps, by vague accounts received through the Phoenicians—and were not visited by any subsequent authority during more than two centuries. Hence some of the later Greek geographers altogether disregarded his statements, and treated his voyage as a fiction. Eratosthenes, indeed (276–196 B.C.), attached great value to his authority as to Britain and Spain, though doubting some of his statements; but Polybius (c. 204–122 B.C.) considered the whole work of Pytheas a tissue of fables, like that of Euhemerus concerning Panchaea; and even Strabo, in whose time the western regions of Europe were comparatively well known, adopted to a great extent the view of Polybius.

In modern times a critical examination has arrived at a more favourable judgment, and though Gosselin in his *Recherches sur la géographie des anciens* (iv. 168–180) and Sir G. C. Lewis in his *History of Ancient Astronomy* (pp. 466–481) revived the sceptical view, the tendency of modern critics has been rather to exaggerate than to depreciate the value of what was really added by Pytheas to knowledge. Our information concerning him is so imperfect, and the scanty notices preserved to us from his work are so meagre and discordant, that it is difficult to arrive at anything like a sound conclusion. It may, however, be considered as fairly established that Pytheas made a voyage round the western coasts of Europe, proceeding from Gades, the great Phœnician emporium, and probably the farthest point familiar to the Greeks, round Spain and Gaul to the British Islands, and that he followed the eastern coast of Britain for a considerable distance to the north, obtaining information as to its farther extension in that direction which led him greatly to exaggerate its size. At the same time he heard vaguely of the existence of a large island to the north of it—probably derived from the fact of the Orkneys and Shetlands being really found in that position—to which he gave the name of *Thule*.

The most important statement made by Pytheas in regard to Thule was that connected with the astronomical phenomena affecting the duration of day and night therein. Unfortunately the reports transmitted to us differ so widely that it is almost impossible to determine what Pytheas himself stated. It is, however, probable that the version given in one passage by Pliny (*H.N.* iv. 16, 104) correctly represents his authority. According to this, the days at the summer solstice were twenty-four hours in length, and conversely at the winter solstice the nights were of equal duration. Of course this would be true had Thule been situated under the Arctic Circle, which Pytheas evidently considered it to be, and his skill as an astronomer would lead him to accept as a fact what he knew must be true at some point as a voyager proceeded onwards towards the north.

Still more difficult is it to determine the extent and character of Pytheas's explorations towards the east. The statement that he proceeded along the coasts of Europe "from Gades to the Tanais" is evidently based upon the supposition that this would be a simple and direct course along the northern shores of Germany and Scythia—Polybius himself, in common with the other Greek geographers till a much later period, being ignorant of the projection of the Danish or Cimbric peninsula, and the circumnavigation that it involved—of all which no trace is found in the extant notices of Pytheas. Notwithstanding this, some modern writers have supposed him to have entered the Baltic and penetrated as far as the *Vistula* (his *Tanais*). The only foundation for this is to be found in the fact that in a passage cited by Pliny (*H. N.* xxxvii. 2, 35) Pytheas is represented as stating that amber was brought from an island called *Abalus*, distant a day's voyage from the land of the Guttones, a German nation who dwelt on an estuary of the ocean called *Mentonomus*, 6000 stadia in extent. It was a production thrown up by the waves of the sea, and was used by the inhabitants to burn instead of wood. It has been conjectured that the "estuary" here mentioned refers to the Baltic, the existence of which as a separate sea was unknown to all ancient geographers; but the obscure manner in which it is indicated, as well as the inaccuracy of the statements concerning the place from whence the amber was actually derived, both point to the sort of hearsay accounts which Pytheas might readily have picked up on the shores of the German Ocean, without proceeding farther than the mouth of the Ems, Weser or Elbe, which last is supposed by Ukert to have been the limit of his voyage in this direction. It must be observed also that amber is found in Friesland and on the west coast of Schleswig, as well as in the Baltic, though not in equal abundance.

As to the Cassiterides, or Tin Islands, the exploration of which would naturally be one of the chief objects of Pytheas, he seems to have furnished Timæus, who wrote less than a century after him, with details upon the same, especially in regard to the commercial centre of Iktis (St Michael's Mount in Cornwall?), which are preserved by Diodorus. The trade with these regions was probably at this period in Phœnician hands, but we know that at a later time a considerable portion of the supply was carried overland through Gaul to Massilia.

Pytheas certainly had one merit which distinguished him from almost all his contemporaries—he was a good astronomer, and was one of the first who made observations for the determination of latitudes, among others that of his native place Massilia, which he fixed with remarkable accuracy; his result, which was within a few miles of the truth, was adopted by Ptolemy, and became the basis of the Ptolemaic map of the western Mediterranean. His calculations of the length of the longest day at four different points in the neighbourhood of Britain are probably based on native reports. If these figures (16, 17, 18 and 19 hours) are to be pressed, they would refer to, say, Ushant (48° N.), Flamborough Head (54°), Tarbet Ness in Ross (58°) and the northernmost Shetlands (61°). Pytheas was also the first among the Greeks who arrived at any correct notion of the tides, and not only indicated their connexion with the moon, but pointed out their periodical fluctuations in accordance with the phases of that luminary. Other observations concerning the manners and customs of the inhabitants

of remote northern regions prove that he had himself really visited them. Among these are the gradual disappearance of various kinds of grain as one advanced towards the north; the use of fermented liquors made from corn and honey; and the habit of threshing out their corn in large covered barns, instead of on open threshing-floors as in Greece and Italy, on account of the want of sun and abundance of rain. Pytheas's notice of the depth of the Bay of Biscay, of the length of the projection of Brittany, of Ushant under the name of *Uxisama*, and of three promontories of Britain, two of which seem to correspond to Land's End (*Belerion*), and North Foreland (*Kantion*), must not be forgotten.

The fragments of Pytheas have been collected by Arvedson (Upsala, 1824), and by Fuhr (*De Pythea massiliensi*, Darmstadt, 1835). Of the numerous treatises and dissertations on the subject, see Ukert, "Bemerkungen über Pytheas," in vol. i. of his *Geog. d. Griechen u. Römer*, pp. 298-309, which contains an excellent summary of all that is known concerning Pytheas; Sir George C. Lewis, *Historical Survey of the Astronomy of the Ancients*, pp. 466-480 (London, 1862); Sir Edward H. Bunbury, *History of Ancient Geography*, vol. i. ch. xv. § 2 (London, 1883); C. I. Elton, *Origins of English History*, cf. especially app. i. pp. 400, &c. (London, 1882); Hugo Berger, *Geschichte der wissenschaftlichen Erdkunde der Griechen*, pt. 3 (2nd ed., Leipzig, 1903). A very elaborate investigation of the whole subject will be found in Müllenhoff, *Deutsche Alterthumskunde*, i. 211-497 (Berlin, 1870). See also Sir Clements Markham's paper, "Pytheas, the Discoverer of Britain," in the *Geographical Journal* (June 1893); and H. F. Tozer, *History of Ancient Geography*, pp. 152-164 (Cambridge, 1897). (E. H. B.; C. R. B.)

PYTHIS, or **PYTHIUS**, one of the most noted Greek architects of the later age. He cultivated the Ionic style, in which he constructed the temple of Athena at Priene. The dedicatory inscription, which is in the British Museum, records that the founder was Alexander the Great. Pythis also made a great marble quadriga which surmounted the Mausoleum.

PYTHON, in Greek mythology, son of Gaea, an enormous serpent, said to have been produced from the mud after the flood of Deucalion. Its haunt was a cavern near Mt Parnassus. Four days after its birth it was slain by Apollo (Apolodorus i. 4), who was hence surnamed Pythius. According to Ephorus (in Strabo ix. 646), Python, surnamed Dracon (serpent), was a brigand near Delphi. The python in reality represents the pestilential vapours rising from stagnant lakes and pools, which are dispersed by Apollo and his arrows—that is, the shafts of the sun. The old derivation (Homeric *Hymn to Apollo*, 371), according to which Delphi was originally called Pytho, because the slain serpent was left there to "rot" (*πίθεσθαι*), points to this explanation.

See C. Pascal, *Studi di antichità e mitologia* (1896).

PYTHON, a genus of very large snakes of the family Boidae (see SNAKES) inhabiting the tropical parts of Africa, Asia and

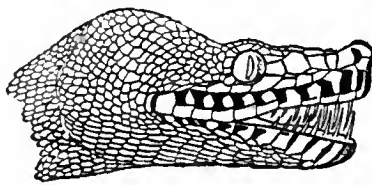

FIG. 1.—Head of *Boa conarina*.

pits in some of the upper and lower labial shields.

Python reticulatus is the commonest species in Indo-China and the Malay Islands; four upper labial shields on either side are pitted. It is, next to the *Anaconda*, one of the largest of all snakes, some specimens being known which measured about 30 ft. in length. *P. molurus*, scarcely smaller, is the python or rock-snake of India and Ceylon. The African species are much smaller, up to 15 ft. in length, e.g. *P. sebae* of tropical and southern Africa and the beautiful *P. regius* of West Africa. *P. spilotes* is the "carpet-snake" of Australia and New Guinea. A small relative of pythons is *Loxocemus bicolor* of South Mexico, the only New World example.

The giant pythons could no doubt overpower and kill by constriction almost any large mammal, since such snakes weigh

many hundredweights and possess terrific strength, but the width of their mouth—although marvellously distensible—has, of course, a limit, and this is probably drawn at the size of a goat. Before a python swallows such large prey, its bones are crushed and the body is mangled into the shape of a sausage.

The snake begins with the head, and a great quantity of saliva is discharged over the body of the victim as it is hooked into the throat by the alternately right and left forward motions of the distended well-toothed jaws. If for any reason a snake should disgorge its prey, this will be found smothered with slime. Hence the fable that they cover it with saliva before deglutition.

Most pythons are rather ill-tempered, differing in this respect from the boas. They are chiefly arboreal, and prefer localities

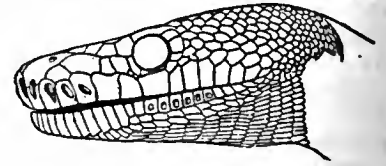

FIG. 2.—Head of *Python reticulatus*.



FIG. 3.—*Python reticulatus* (India).

in the vicinity of water to which mammals and birds, their usual prey, resort. They move, climb and swim with equal facility. The female collects her eggs, sometimes as many as one hundred, into a heap, round which she coils herself, covering them so that her head rests in the centre on the top. In this position the snake remains without food throughout the whole period of incubation, or rather keeping guard, for about two months. (H. F. G.)

PYX (Gr. *πυξίς*, a box or chest), a term for various forms of receptacle. In ecclesiastical usage it is the sacred vase or tabernacle in which the Host is reserved. In the English Mint the pyx is the chest in which are placed one coin from every 15 lb of newly coined gold and one from every 60 lb of newly coined silver to await the "trial of the pyx" (see MINT). This chest was formerly kept in the Chapel of the Pyx in Westminster Abbey.

Q the letter which immediately succeeds P in the alphabet of Latin and the modern languages of western Europe. It represents the Koppa of the earliest Greek alphabets surviving in that form of the Ionic alphabet, which ultimately superseded all others, merely as the numerical symbol for 90. In the Phoenician alphabet a sibilant Zade (Tzaddi) stands between *q* and *p*. Hence Q is the nineteenth letter in the Phoenician alphabet, the eighteenth in the Greek numerical alphabet, which alone contains it, the sixteenth (owing to the omission of *theta* and *xi*) in the Latin, and (from the addition of J) the seventeenth in the English alphabet. Its earliest form is a rough ellipse transfixted by an upright line, ϕ . In various Semitic alphabets this has been altered out of recognition, apparently from the writing of the symbol in cursive handwriting without lifting the pen. As a result forms like P , P , P , T , are developed. In Greece the head of the symbol is generally circular, and only in a few early inscriptions is the upright carried through the circle, ϕ . The common form is Q with the upright stem short. This is also the earliest form in the Latin alphabet, but forms with the upright turned to the right as in a modern Q are found in the Republican period, while this tail becomes longer and curved in the early Empire. The pronunciation of the Semitic Koph (Qōf) was that of a velar guttural produced against the back part of the soft palate with great energy (hence called an "emphatic" sound). In Greek there is no evidence that Q was pronounced differently from K; hence no doubt its early disappearance in most dialects. It survived longest when followed by *o* or *v*, as at the beginning of the name of the town of Corinth. In Latin it is regularly used in combination with *u*. In classical Latin its use is confined to the cases where, as in English *quill*, &c., the *u* is pronounced as *w* before a following vowel, but, in old Latin it is found also in other combinations. Many languages find the combination *qu*, when both sounds are consonantal (*qw*), difficult; *q* being the deepest guttural while *u* (English *w*) is a lip sound, the points of production are nearly as far separate as they can be. There is thus a tendency to assimilation, and instead of a guttural followed by a labial semi-vowel, a new labial consonant *p* is produced. In Greek this is common when the combination is followed by the vowel *o*, as in $\pi\omega$, $\pi\omicron$, &c., from the same stem as the Latin *quō*, *quī*, &c. This, however, is not found in all dialects alike (see GREEK LANGUAGE). In other languages, like Oscan and Umbrian which are closely akin to Latin, or the Welsh branch of the Celtic languages, *p* occurs regularly without regard to the nature of the vowel following. Thus, corresponding to the Latin *quattuor*, we find the Oscan *petora*, the Gaulish *petor-ritum*, "four-wheeler," the Welsh *pedwar*, "four," &c., while the Irish *ceithir*, "four," corresponds more closely to the Latin. (P. Gr.)

QARAITES, or **KARAITES**, a Jewish sect of the middle ages, claiming to be distinguished by adherence to Scripture as contrasted with oral tradition, whence the name (from קרא *qara*, to read, as if "readers," *scripturarii*; sometimes also קרי קראי "children of the Text" as read). They have frequently been identified with the Sadducees or with the Samaritans, with neither of whom have they any historical connexion or much spiritual affinity. The schism arose at Bagdad about the middle of the 8th century, when the hereditary claims of Anan, a learned Talmudist, to the office of Resh Galutha were set aside by the Gaonim (heads of rabbinical schools) at Sura and Pumbeditha, because he was believed to undervalue the authority of the Talmud. Anan, nevertheless, allowed himself to be proclaimed Exilarch by his followers, a step construed into treason by the Mahomedan government. He was sentenced to death, but his life was saved by his fellow prisoner, Abu Hanifa, the founder of the great school of Moslem theology and jurisprudence. Ultimately he and his followers were permitted to migrate to Palestine. They erected a synagogue in Jerusalem

which continued to be maintained until the time of the Crusades. From this centre the sect diffused itself thinly over Syria, spread into Egypt, and ultimately reached S.E. Europe.

Anan, who is said to have died in A.D. 765, was the author of a commentary on the Pentateuch and other works in Talmudic Hebrew and Arabic. Most of these are lost, and we are thus left chiefly dependent on the hostile indications of opponents. His code was recovered in Egypt by the Qaraite Moses b. Elijah Bashyazi (1544-1572). Fragments were published by Harkavy (Voskhod 1897-1898). It is clear that Anan, although theoretically antagonistic to rabbinic methods, was in the end compelled to incline towards them. Considerable influence, too, was exercised on his theology by Abu Hanifa. In general we know that he showed great bitterness against the Talmud and its upholders (the "Rabbanites") for their modification of the written law by arbitrary additions and subtractions, but there is nothing to indicate that he himself had the insight or the fervour by which he could have become the pioneer of a really great reformation. The questions appear to have turned entirely on points of minute detail. Several of them related to the regulation of the calendar, the new moon, for example, being fixed by the Qaraites by direct observation, not by astronomical calculation, and the intercalary year also being determined empirically; others related to paschal and pentecostal ritual, such as the precise hour for killing the lamb or for burning its remains. The differences which affected social life most deeply were those relating to Sabbath observance and the forbidden degrees of marriage, the Qaraites not recognizing any distinction between relationships of consanguinity and those of affinity, while in their zeal to avoid all risk of infringement of the sacredness of the day of rest they prohibited the burning of any light at all in their houses from sunset to sunset.

Of late years much Qaraite literature has been published. The most valuable contribution to learning made by it is in the direction of Hebrew philology and the natural exegesis of the scriptural text. Little information as to the Qaraites can be derived from their liturgies; they differ fundamentally from those used by Rabbanites in being composed almost entirely of scriptural versicles and in containing practically no *Piyyutim* (liturgical poems). The controversies as to the rule of faith which so deeply divided the Christian Church in the 16th century gave to this obscure sect an illusory and passing importance, the Catholics frequently hurling the epithet Karai, in token of contempt, at the Protestants, who in their turn willingly accepted it as sufficiently descriptive of their attitude towards Scripture. The Qaraites never have been numerous; in 1904 their total number was estimated at 12,000, 10,000 being found in Russia: the present community in Jerusalem numbers only a few families. They occur in Constantinople and elsewhere in Turkey, and in Egypt, but are chiefly met with in southern Russia, and especially in the Crimean districts of Eupatoria, Theodosia and Sevastopol. Here their historical capital and chief synagogue was formerly the "Jews' Castle" (*Tshuful-Kale*), near Bakh-chisarai. The place is now deserted; its cemetery was the seat of Firkowitsch's notorious forgeries (inscriptions of 1st century), by which he sought to establish a fabulous antiquity for his sect. According to Strack (*A. Firkowitsch u. seine Entdeckungen*, 1876) the oldest tombstones do not go back beyond the 14th century. The modern Qaraites are generally well spoken of for their honesty, perseverance and simple habits of life; they are gradually approximating to the Rabbanites, with whom, in some places, they are on terms of social intimacy. The Russian government exempts the Qaraites from the restrictions to which the rest of the Jews are subject; this circumstance is probably due to the insignificance of the Qaraites numerically.

Among the older authorities may be mentioned Morinus, *Exercit. Bibl. lib. ii. ex. 7* (1669); and Triglandius, *Diatrise de Secta Karaeorum*

(1703). See Grätz, *Gesch. der Juden*, especially in vol. v. (1806), with the additions and corrections of Harkavy in the Hebrew translation; and Fürst, *Gesch. des Karäerthums* (1865); S. Pinsker, *Liqqute Qadmoniyot*: articles by A. Harkavy and by S. Poznanski in the *Jewish Quarterly Review* (e.g. x. 238-276, and vols. xviii.-xx.). See also *Jewish Encyclopedia*, s.v. "Anan," "Karaites," &c.

(I. A.)

QARO (or **CARO**), **JOSEPH BEN EPHRAIM** (1488-1575), codifier of Jewish law, whose code is still authoritative with the mass of Jews, was born in 1488. As a child he shared in the expulsion from Spain (1492), and like most prominent Jews of the period was forced to migrate from place to place. In 1535 he settled in Safed, Palestine, where he spent the rest of his life. Safed was then the headquarters of Jewish mysticism. Qaro was himself a mystic, for the tribulations of the time turned many men's minds towards Messianic hopes; nor was he by any means the only great Jewish legalist who was also a mystic. Mysticism in such minds did not take the form of a revolt against authority, but was rather the spiritual flower of pietism than an expression of antinomianism. It is, however, as a legalist that Qaro is best known. In learning and critical power he was second only to Maimonides in the realm of Jewish law. He was the author of two great works, the second of which, though inferior as an intellectual feat, has surpassed the first in popularity. This was inevitable, for the earlier and greater book was designed exclusively for specialists. It was in the form of a commentary (entitled *Beth Yoseph*) on the *Turim* (see ASHER BEN YEHI'EL). In this commentary Qaro shows an astounding mastery over the Talmud and the legalistic literature of the middle ages. He felt called upon to systematize the laws and customs of Judaism in face of the disintegration caused by the Spanish expulsion. But the *Beth Yoseph* is by no means natic.

Qaro's real aim was effected by his second work, the *Shulhan 'Arukh* ("Table Prepared"). Finished in 1555, this code was published in four parts in 1565. The work was not accepted without protest and criticism, but after the lapse of a century, and in consequence of certain revisions and amplifications, it became the almost unquestioned authority of the whole Jewish world. Its influence was to some extent evil. It "put Judaism into a strait-jacket." Independence of judgment was inhibited, and the code stood in the way of progressive adaptation of Jewish life to the life of Europe. It included trivialities by the side of great principles, and retained elements from the past which deserved to fall into oblivion. But its good effects far outweighed the bad. It was a bond of union, a bar to latitudinarianism, an accessible guide to ritual, ethics and law. Above all, it gave a new lease of life to the great theory which identified life with religion. It sanctified the home, it dignified common pursuits. When, however, the era of reform dawned in the 19th century, the new Judaism found itself impelled to assume an attitude of hostility to Qaro's code.

See Graetz, *Geschichte der Juden*, vol. ix. (English trans. vol. iv.); Ginzberg, in *Jewish Encyclopedia*, arts. "Caro" and "Codification"; Schechter, *Studies in Judaism*, second series, pp. 202 seq. (I. A.)

QUACK, one who pretends to knowledge of which he is ignorant, a charlatan, particularly a medical impostor. The word is a shortened form of "quacksalver" (Du. *kwaksalver*), in which form it is common in the 17th century, "salver" meaning "healer," while "quack" (Du. *kwakken*) is merely an application of the onomatopoeic word applied to the sounds made by a duck, i.e. gabble or gibberish. In English law, to call a medical practitioner a "quack" is actionable *per se* without proof of special damage (*Allen v. Eaton* (1630), 1 Roll. Abs. 54). The often-quoted legal definition of a "quack" is "a boastful pretender to medical skill," but a "quack" may have great skill, and it is the claim to cure by remedies which he knows have no efficacy which makes him a "quack" (see *Dakhyl v. Labouchere*, *The Times*, 20th of July 1904, and 5th and 9th of November 1907).

QUADRATRIX (from Lat. *quadrator*, squarer), in mathematics, a curve having ordinates which are a measure of the area (or quadrature) of another curve. The two most famous curves

of this class are those of Dinostratus and E. W. Tschirnhausen, which are both related to the circle.

The quadratrix of Dinostratus was well known to the ancient Greek geometers, and is mentioned by Proclus, who ascribes the invention of the curve to a contemporary of Socrates, probably Hippias of Elis. Dinostratus, a Greek geometer and disciple of Plato, discussed the curve, and showed how it effected a mechanical solution of squaring the circle. Pappus, in his *Collections*, treats of its history, and gives two methods by which it can be generated. (1) Let a spiral line be drawn on a right circular cylinder; a screw surface is then obtained by drawing lines from every point of this spiral perpendicular to its axis. The orthogonal projection of a section of this surface by a plane containing one of the perpendiculars and inclined to the axis is the quadratrix. (2) A right cylinder having for its base an Archimedean spiral is intersected by a right circular cone which has the generating line of the cylinder passing through the initial point of the spiral for its axis. From every point of the curve of intersection, perpendiculars are drawn to the axis. Any plane section of the screw (*plectoidal* of Pappus) surface so obtained is the quadratrix. Another construction is shown in fig. 1. ABC is a quadrant in which the line AB and the arc AC are divided into the same number of equal parts. Radii are drawn from the centre of the quadrant to the points of division of the arc, and these radii are intersected by the lines drawn parallel to BC and through the corresponding points on the radius AB. The locus of these intersections is the quadratrix. A mechanical construction is as follows: Let AMP be a semicircle with centre O (fig. 2). Let PQ be the ordinate of the point P on the circle, and let M be another point on the circle so related to P that the ordinate PQ moves from A to O in the same time as the vector OM describes a quadrant. Then the locus of the intersection of PQ and OM is the quadratrix of Dinostratus.

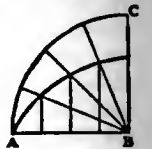

FIG. 1.

The cartesian equation to the curve is $y = x \cot \frac{\pi x}{2a}$, which

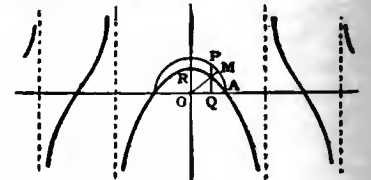

FIG. 2.

shows that the curve is symmetrical about the axis of y , and that it consists of a central portion flanked by infinite branches (fig. 2). The asymptotes are $x = \pm 2na$, n being an integer. The intercept on the axis of y is $2a/\pi$; therefore, if it were possible to accurately construct the curve, the quadrature of the circle would be effected. The curve also permits the solution of the problems of duplicating a cube (*q.v.*) and trisecting an angle.

The quadratrix of Tschirnhausen is constructed by dividing the arc and radius of a quadrant in the same number of equal parts as before. The mutual intersections of the lines drawn from the points of division of the arc parallel to AB, and the lines drawn parallel to BC through the points of division of AB, are points on the quadratrix (fig. 3). The cartesian equation is $y = a \cos \pi x/2a$. The curve is periodic, and cuts the axis of x at the points $x = \pm (2n-1)a$, n being an integer; the maximum values of y are $\pm a$. Its properties are similar to those of the quadratrix of Dinostratus.

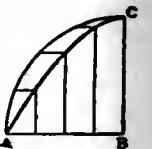

FIG. 3.

QUADRATURE (from Lat. *quadratura*, a making square), in astronomy, that aspect of a heavenly body in which it makes a right angle with the direction of the sun; applied especially to the apparent position of a planet, or of the moon at first and last quarters. In mathematics, quadrature is the determination of a square equal to the area of a curve or other figure.

QUADRIGA, the ancient four-horsed chariot (Lat. *quadrigae*, contracted from *quadrijugae*), which was regarded as one of the seven sacred features in Rome. It was chiefly used as the triumphal car of generals or emperors. The earliest example mentioned is that which was modelled in terra-cotta and raised on the pediment of the temple of Jupiter Capitolinus. In later time it formed the chief decorative feature which crowned the triumphal arches, and there are numerous representations of it on coins.

QUADRILATERAL, in geometry, a figure enclosed by four straight lines. It is also a military term applied to a combination of four fortresses mutually supporting one another. The fortresses of Namur, Liège, Maastricht, and Louvain, and also those of Silistria, Rustchuk, Shumla, and Varna, were so called. But the most famous quadrilateral was that of the four fortified towns of north Italy—Mantua, Peschiera, Verona, and Legnago,

the two former of which are situated on the Mincio and the two latter on the Adige. The real value of the quadrilateral, which gave Austria such a firm hold on Lombardy, lay in the great natural strength of Mantua and in the readiness with which troops and supplies could be poured into Verona from the north.

QUADRILLE, the name of a game of cards and of a dance. The game, played by four persons with a pack of forty cards, was a variation of the Spanish game of ombre (*q.v.*) and superseded it in popularity about 1725, to give way in turn to whist. The dance is of French origin and is usually danced by four couples in square. In the 18th century the *contredanse* was introduced into the ballet, and groups of four, eight or twelve dancers dressed alike performed different figures; these were first called *quadrilles des contredanses*, later shortened to *quadrilles*. The dance became popular outside the ballet, and its figures, five in number, with a finale, bore the names of the different *contredanses*, *Le Pantalon*, *l'Été*, *La Poule*, *La Trénitz*, *La Pastourelle*. The dance was introduced into England in 1815. The word in both its applications comes through Ital. *quadriglio* or Span. *cuadrilla* from Lat. *quadra*, a square, four-sided figure (*quattuor*, four).

QUADROON (a corruption of *quarteroon*, Span. *cuarteron*, from *cuarto*, Lat. *quartus*, fourth), strictly a person having one-fourth negro blood, the offspring of a mulatto and a white. The children of a mulatto and a negro are called in America *zambos* or *sambos* (possibly from Span. *zambro*, Lat. *scambus*, bow-legged), and the use of Sambo as a proper name for a black servant may have thus originated.

QUAESTOR (from Lat. *quaero*, investigate), a Roman magistrate whose functions, at least in the later times of the republic, were mainly financial, though he was originally concerned chiefly with criminal jurisdiction. The origin of the quaestorship is obscure, but it was probably instituted simultaneously with the consulship in 509 B.C.¹ The number of the quaestors was originally two, but this was successively increased to four (in 421 B.C.), eight (in 267 or 241 B.C.), and by Sulla (in 81 B.C.) to twenty. Julius Caesar raised the number to forty (in 45 B.C.), but Augustus reduced it again to twenty, which remained the regular number under the empire. The original quaestors were afterwards distinguished by the title of urban quaestors (*quaestores urbani*). When the number was raised from two to four in 421 B.C. the office was thrown open to the plebeians. It was the lowest of the great offices of state and hence it was regularly the first sought by aspirants to a political career (*cursus honorum*). Towards the close of the republic, if not earlier, the successful candidate was bound to have completed his thirtieth year before he entered on office, but Augustus lowered the age to twenty-five. Originally the quaestors seem to have been nominated by the consuls, but later, perhaps from the fall of the decemvirs (449 B.C.), they were elected by the people assembled in tribes (*comitia tributa*) under the presidency of a consul or another of the higher magistrates. The quaestors held office for one year, but, like the consuls and praetors, they were often continued in office with the title of proquaestor. Indeed it was a rule that the quaestor attached to a higher magistrate should hold office as long as his superior; hence, when a consul regularly presided over the city for one year, and afterwards as proconsul governed a province for another year, his quaestor also regularly held office for two years. Before the election of the quaestors the senate decided the duties to be undertaken by them, and after election these duties were distributed amongst the new quaestors either by lot or by the choice of the higher magistrates to whom quaestors were assigned. A peculiar burden laid on the quaestors, not as an official duty, but rather as a sort of fee exacted from all who entered on the political career, was the paving of the high roads, for which Claudius substituted the exhibition of gladiatorial games.

¹ Plutarch (*Popl.* 12) states that the office was instituted by the first consul. Tacitus, on the other hand (*Ann.* xi. 22), says that it dated from the time of the kings, but his ground is merely that they were mentioned in the *Lex Curia* of the consul Brutus, which Tacitus assumes to have been identical with that of the kings.

Various classes of quaestors may be distinguished according to the duties they had respectively to discharge.

1. *The Urban Quaestors*.—Originally the duties of the quaestors, like those of the consuls, were undefined; the consuls were the superior magistrates of the republic, the quaestors their assistants. From a very early time, however, the quaestors possessed criminal jurisdiction. In the code of the Twelve Tables they are designated *quaestores parricidii*, "inquisitors of parricide or murder";² and perhaps originally this was their full title, which was afterwards abbreviated into quaestors when their functions as criminal judges fell into the background. In addition to parricide or murder we can hardly doubt that all other crimes fell within the jurisdiction of the quaestors; political crimes only seem to have been excepted. The criminal jurisdiction of the quaestors appears only to have terminated when towards the close of the republic trial by permanent courts (*quaestiones perpetuae*) was extended to criminal cases.³

The quaestors had also charge of the public treasury (*aerarium*) in the temple of Saturn, and this was in the later times of the republic their most important function. They kept the keys of the treasury and had charge of its contents, including not only coin and bullion but also the military standards and a large number of public documents, which in later times comprised all the laws as well as the decrees of the senate. Their functions as keepers of the treasury were withdrawn from the urban quaestors by Augustus and transferred to other magistrates, but the office itself continued to exist into the 3rd century, though as to the nature of the duties attached to it we have little or no information.

2. *The Military Quaestors*.—These were instituted in 421 B.C., when two new quaestors were added to the original two. They never had a distinctive appellation like that of the urban quaestors, from whom however, they were clearly distinguished by the fact that, while the urban quaestors did not stand in a special relation of subordination to any particular magistrate, a non-urban quaestor was regularly assigned as an indispensable assistant or adjutant to every general in command, whose name or title the quaestor usually added to his own.⁴ Originally they were the adjutants of the consuls only, afterwards of the provincial praetors, and still later of the proconsuls and propraetors. The dictator alone had no military commanders had no quaestor, because a quaestor would have been a limitation to his powers. The governor of Sicily had two quaestors; all other governors and commanders had but one. Between the quaestor and his superior a close personal relation, analogous to that between a son and his father, existed, and was not severed when their official connexion ceased. Not till the close of the republic do cases occur of a quaestor being sent to a province invested with praetorial and even consular powers; in one case at least the quaestor so sent had a second quaestor placed under him. The duties of the military quaestor, like those of the treasury quaestor, were primarily financial. Moneys due to a provincial governor from the state treasury were often, perhaps regularly, received and disbursed by the quaestor; the magazines seem to have been under his charge; he coined money, on which not unfrequently his name appears alone. The booty taken in war was not necessarily under the control of the quaestor, but was dealt with, especially in later times, by inferior officers called *praefecti fabrum*. But, though his duties were primarily financial, the quaestor was after all the chief assistant or adjutant of his superior in command, and as such he was invested with a certain degree of military power; under the republic his military rank was superior to that of the legates, though under the empire this relation was reversed. When the general left his province before the arrival of his successor he usually committed it to the care of his quaestor, and, if he died or was incapacitated from naming his successor, the quaestor acted as his representative. Unlike the urban quaestor, the military quaestor possessed not a criminal but a civil jurisdiction corresponding to that of the aediles at Rome.

3. *The Italian Quaestors*.—The subjugation of Italy occasioned the institution (in 267 u.c.) of four new quaestors, who appear to have been called *quaestores classici* because they were originally intended to superintend the building of the fleet (*classis*); their functions, however, are very imperfectly known. Though no doubt intended to assist the consuls, they were not subordinated (like the military quaestors) to a special consul. They were stationed at Ostia, at Cales in Campania, and in Gaul about the Padus (Po). The station of the fourth is not mentioned; perhaps it was Lilybaeum in Sicily.

² The etymology and original meaning of *parricidium* are doubtful. In the latter part of the word we have, of course, the same root as in *caedere*, "to kill," but whether or not the former part is from *pater*, "a father," or from the same root that we have in *per-peram*, *per-jurium*, is a moot point. Mommsen takes the latter view.

³ It is often supposed that the *quaestores parricidii* were an old magistracy quite distinct from the ordinary quaestors. For the identification of the two, see Mommsen, *Römisches Staatsrecht*, ii. pt. I, p. 506.

⁴ Thus Cicero speaks of the *provincia consularis* of the quaestor, and we find *quaestor Cn. Pompei*, &c.

LITERATURE.—For a fuller treatment of all these points see Momm- sen, *Staatsrecht*, ii. p. 523 foll.; for the existence of the quaestorship under the monarchy, and a different view of the second station of the Italian quaestors, see A. H. J. Greenidge, *Roman Public Life*, pp. 63, 215.

QUAGGA, or **COUAGGA**, an animal of the genus *Equus* (see HORSE), nearly allied to Burchell's zebra, formerly met with in vast herds on the great plains of South Africa between the Cape Colony and the Vaal river, but now completely extinct. Generally speaking, the colour of the head, neck, and upper-parts of the body was reddish-brown, irregularly banded and marked with dark brown stripes, stronger on the head and neck and gradually becoming fainter until lost behind the shoulder. There is a broad dark median dorsal stripe. The under surface of the body, the legs, and tail are nearly white, without stripes. The crest is very high, surmounted by a standing mane, banded

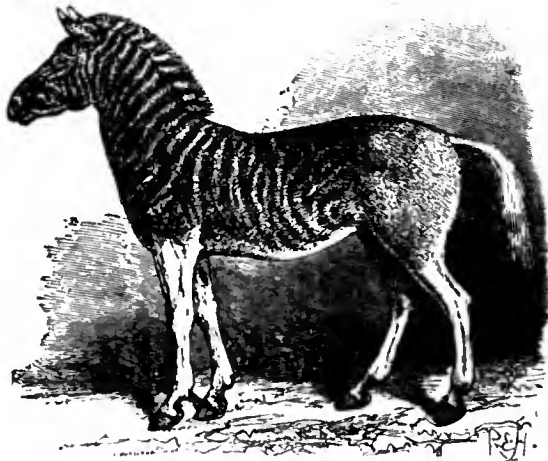

The Quagga (*Equus quagga*).

alternately brown and white. It is, however, not improbable that there were two or more local races, for which separate names have been proposed. Though never really domesticated, quaggas have occasionally been trained to harness. The accompanying illustration is reduced from a painting made from one of two which were driven in Hyde Park by Mr. Sheriff Parkins in the early part of the 19th century. The name is an imitation of the shrill barking neigh of the animal, "oug-ga, oug-ga," the last syllable very much prolonged; it is also commonly applied to the bonnte-quagga, or Burchell's zebra (see HORSE and ZEBRA).

QUAGMIRE, a bog or marsh, a piece of ground so saturated with water that it cannot support any weight. The word is composed of "quag" or "quake" (O.E. *cwacian*; cf. "quaver," "quiver") and "mire," mud (Icel. *myri*, Swed. *myr*).

Skeat suggests that quag may be connected with the root seen in "quick," and quotes (*Etym. Dict.* 1898) *Piers Plowman*, c. xxi. 64, of an earthquake, the earth "quook as it quyke were," i.e. shook as if it were alive.

QUAICH, or **QUAIGH**, a form of Scottish drinking vessel. The word is an adaptation of the Gaelic *cuach*, cup, bowl; cf. Welsh *cawg*, and is usually referred to the Gr. *καῦκος*, *καῦκα*, through Lat. *caucus*. In the 18th century it is sometimes spelled "quaff," and a connexion has been suggested with "quaff," to drink with a large or at a single draught; the *New English Dictionary*, however, considers this doubtful. The "quaich" was doubtless inspired by the low silver bowls with two flat handles, frequently used as bleeding vessels in England and Holland in the 17th century. The earliest quaichs were made of a solid block of wood, or of small staves of wood, often of different colours, supported by hoops, like barrels. They are generally fitted with two, and, more rarely, three short projecting handles. In addition to wood, they are made of stone, brass, pewter, horn, and of silver. The latter were often engraved with lines and bands in imitation of the staves and hoops of the wooden quaichs. The origin of these vessels in Scotland is

traced to the Highlands; it was not until the end of the 17th century that they became popular in such large centres as Edinburgh and Glasgow. The silversmiths of such local gilds as Inverness and Perth frequently mounted them in silver, as may be seen from the hall-marks on the existing examples. They are found, of silver and pewter, in use as communion cups in various parts of Scotland; four, with the Edinburgh hall-mark for 1722, belong to Ayr parish church; and a large one with the same hall-mark for 1663-1684 is used as an alms-dish at Alvah, Banffshire. The loving cup at Donaldson's hospital, Edinburgh, is a large silver quaich, with the Edinburgh stamp for 1724, which belonged to the founder of that hospital. The finest collection of these vessels is in the possession of the marquess of Breadalbane. (E. A. J.)

QUAIL (O. Fr. *Quaille*, Mod. Fr. *Caillie*, Ital. *Quaglia*, Low Lat. *Quaquila*, Du. *Kwakkel* and *Kwariel*, Ger. *Wachtel*, Dan. *Vagtel*), a well-known bird throughout almost all countries of Europe, Asia and Africa—in modern ornithology the *Coturnix communis* or *C. dactylisonans*. This last epithet was given from the peculiar three-syllabled call-note of the cock, which has been grotesquely rendered in several European languages, and in some parts of Great Britain the species is popularly known by the nickname of "wet-my-lips" or "wet-my-feet." The quail varies somewhat in colour, and the variation is rather individual than attributable to local causes; but generally the plumage may be described as reddish-brown above, almost each feather being transversely patched with dark brown interrupted by a longitudinal stripe of light buff; the head is dark brown above, with three longitudinal streaks of ochreous-white; the sides of the breast and flanks are reddish-brown, distinctly striped with ochreous-white; the rest of the lower parts are pale buff, clouded with a darker shade, and passing into white on the belly. The cock, besides being generally brighter in tint, not unfrequently has the chin and a double-throat band of reddish or blackish-brown, which marks are wanting in the hen, whose breast is usually spotted. Quails breed on the ground, and lay from nine to fifteen eggs of a yellowish-white, blotched and spotted with dark brown. Though essentially migratory by nature, not a few quails pass the winter in the northern hemisphere and even in Britain, and many more in southern Europe. In March and April they cross the Mediterranean from the south on the way to their breeding homes in large bands, but these are said to be as nothing compared with the enormous flights that emigrate from Europe towards the end of September. During both migrations immense numbers are netted for the market, since they are almost universally esteemed as delicate meat. The flesh of quails caught in spring commonly proves dry and indifferent, but that of those taken in autumn, especially when they have been kept long enough to grow fat, as they quickly do, is excellent. In no part of the British islands at present do quails exist in sufficient numbers to be the especial object of sport. In old days they were taken in England in a net, attracted thereto by means of a quail-call—a simple instrument,¹ the use of which is now wholly neglected—on which their notes are easily imitated. In South Africa and India allied species, *C. delegorguii* and *C. coromandelica*, the latter known as the Rain-Quail, respectively occur, as well as the commoner one, which in Australia and Tasmania is wholly replaced by *C. pectoralis*, the Stubble-Quail of the colonists. In New Zealand another species, *C. novae-zelandiae*, was formerly very abundant in some districts. Some fifteen or perhaps more species of quails, inhabiting the Indian and Australian regions, have been separated, perhaps unnecessarily, to form the genera *Synaeocus*, *Pardicula*, *Excalphatoria*, and so forth.

America has some fifty or sixty species of birds which are commonly deemed quails, though by some authors placed in a distinct family or sub-family Odontophorinae.² The best

¹ One is figured in Rowley's *Ornithological Miscellany* (ii. p. 363).

² They form the subject of a monograph in folio by J. Gould, published between 1844 and 1850. See also S. D. Judd, *Bulletin* 21 of U.S. Dept. of Agriculture (1905); D. G. Elliot, *Game Birds of North America* (1897).

known is the Virginian Quail, or Colin, as it is sometimes called—that being, according to Hernandez, its old Mexican name. It is the *Ortyx* (or *Colinus*) *virginianus* of modern ornithology, and has a wide distribution in North America, being called "partridge" in the Southern states, and elsewhere being known by the nickname of "Bob-White," aptly bestowed upon it from a call-note of the cock. Many unsuccessful attempts have been made to introduce this bird to England (as indeed similar trials have been made in the United States with quails from Europe). The beautiful tufted Quail of California, *Lophortyx californica*, has also been tried at large in Europe without success; but it is well established as an aviary bird. A few of the American Quails or Colins roost in trees.

Interesting from many points of view as is the group of birds last mentioned, there is another which, containing a score of species (or perhaps more) often termed Quails or Button-Quails, is of still greater importance in the eyes of the systematist. This is that comprehended by the genus *Turnix*, or *Hemipodius* of some authors, the anatomical structure of which removes it far from the genera *Coturnix*, *Ortyx*, and their allies, and even from any of the normal *Gallinae*. T. H. Huxley regarded it as the representative of a generalized stock from which the *Charadriomorphae* and *Alectoromorphae*, to say nothing of other groups, have sprung. The button-quails are now placed as a separate sub-order, *Turnices*, of the order *Galliformes* (see BIRD). One species, *T. sylvatica*, inhabits Barbary and southern Spain, and under the name of Andalucian Hemipode has been included (though on evidence not wholly satisfactory) among British birds as a reputed straggler. The rest are natives of various parts of the Ethiopian, Indian and Australian regions. It is characteristic of the genus *Turnix* to want the hind toe; but the African *Ortyxelus* and the Australian *Pedionomus*, which have been referred to its neighbourhood, have four toes on each foot. (A. N.)

QUAIN, SIR RICHARD, BART. (1816–1898), Irish physician, was born at Mallow-on-the-Blackwater, Co. Cork, on the 30th of October 1816. He received his early education at Cloyne, and was then apprenticed to a surgeon-apothecary in Limerick. In 1837 he entered University College, London, where he graduated with high honours as M.B. in 1840, and as M.D. (gold medal) in 1842. Six years later he was chosen an assistant-physician to the Brompton Hospital for Diseases of the Chest, and with that institution he retained his connexion until his death, first as full (1855) and subsequently as consulting physician (1875). He became a fellow of the Royal College of Physicians in 1851, and filled almost every post of honour it could offer except the presidency, in the contest for which he was beaten by Sir Andrew Clark in 1888. He became physician-extraordinary to Queen Victoria in 1890, and was created a baronet in the following year. He died in London on the 13th of March 1898. Quain, who was elected a fellow of the Royal Society in 1871, was the author of several memoirs, dealing for the most part with disorders of the heart, but his name will be best remembered by the *Dictionary of Medicine*, the preparation of which occupied him from 1875 to 1882 (2nd edition, 1894; 3rd, 1902). He sat on the Royal Commission on Rinderpest (cattle plague) in 1865. He was a cousin of Jones Quain (1796–1865), the author of *Quain's Elements of Anatomy*, and of Richard Quain (1800–1887), who was president of the Royal College of Surgeons in 1868, and left £75,000 to University College, London, with which the Quain professorships of botany, English language and literature, law, and physics were endowed. A half-brother of the last two, Sir John Richard Quain (1816–1876), was appointed a judge of the Queen's Bench in 1871.

QUAINT (O. Fr. *cointe*, from Lat. *cognitus*, known, probably influenced by association with Lat. *complus*, neat), an adjective meaning unusual or fanciful, often applied to things with a sense of old-fashioned charm or prettiness. "Queer," which has much the same meaning, is of doubtful etymology, but is generally taken as adapted from Ger. *quer*, crooked.

QUAKERS, originally a cant name applied in derision to the members of the Society of Friends, but now used without any

contemptuous significance. It was said to have originated in the saying of Justice Bennet at Derby in 1650, "Tremble (or quake) at the word of the Lord," but it is now certain that it was used as early as 1647, and arose from the physical manifestations of religious emotion characteristic of many of the early Friends. (See FRIENDS, SOCIETY OF.)

QUANTUM MERUIT (Lat. for "as much as he has deserved"), in the law of contract, originally a form of action on the case, grounded on a promise to pay the plaintiff for work done as much as it was worth. It has been abolished as a special form of action, but the term is still in use where, in cases of special contract, there has been a breach amounting to a discharge by one party before the other party has done all that he was bound to do. In such a case the plaintiff sues for a *quantum meruit* or the value of so much as he has done.

QUARANTINE (Fr. *quarantaine*, a period of forty days¹), a term originally applied to the old sanitary preventive system of detention of ships and men, unloading of cargo in lazarets, fumigation of susceptible articles, &c., which was practised at seaports on account of the plague, in connexion with the Levantine trade. It is now a thing of the past in the United Kingdom and in the majority of other states. But, in common usage, the same word is applied to the sanitary rules and regulations which are the modern substitutes for quarantine.

The plague was the only disease for which quarantine was practised (not to mention the earlier isolation of lepers, and the attempts to check the invasion of syphilis in northern Europe about 1490) down to the advent of yellow fever in Spain at the beginning of the 19th century, and the arrival of Asiatic cholera in 1831. Venice took the lead in measures to check the spread of plague, having appointed three guardians of the public health in the first years of the Black Death (1348). The next record of preventive measures comes from Reggio in Modena in 1374. The first lazaret was founded by Venice in 1403, on a small island adjoining the city; in 1467 Genoa followed the example of Venice; and in 1476 the old leper hospital of Marseilles was converted into a plague hospital—the great lazaret of that city, perhaps the most complete of its kind, having been founded in 1526 on the island of Pomègue. The practice at all the Mediterranean lazarets was not different from the English procedure in the Levantine and North-African trade. On the approach of cholera in 1831 some new lazarets were set up at western ports, notably a very extensive establishment near Bordeaux, afterwards turned to another use.

The plague had disappeared from England, never to return, for more than thirty years before the practice of quarantine against it was definitely established by an act of Parliament of Queen Anne's reign (1710). The first act was called for, owing to an alarm lest plague should be imported from Poland and the Baltic; the second act of 1721 was due to the disastrous prevalence of plague at Marseilles and other places in Provence; it was renewed in 1733 owing to a fresh outbreak of the malady on the continent of Europe, and again in 1743 owing to the disastrous epidemic at Messina. In 1752 a rigorous quarantine clause was introduced into an act regulating the Levantine trade; and various arbitrary orders were issued during the next twenty years to meet the supposed danger of infection from the Baltic. Although no plague cases ever came to England all those years, the restrictions on traffic became more and more stringent (following the movements of medical dogma), and in 1788 a very oppressive Quarantine Act was passed, with provisions affecting cargoes in particular. The first year of the 19th century marked the turning-point in quarantine legislation; a parliamentary committee sat on the practice, and a more reasonable act arose on their report. In 1805 there was another new act, and in 1823–24 again an elaborate inquiry followed by an act making the quarantine only at discretion of the privy council, and at the same time recognizing yellow fever "or other highly infectious disorder" as calling for quarantine measures along

¹ The strict sense of the term is also preserved in the "widows' quarantine," the right of a widow to remain in the principal house belonging to her husband for forty days after his death.

with plague. The steady approach of cholera in 1831 was the last occasion in England of a thoroughgoing resort to quarantine restrictions. The pestilence invaded every country of Europe despite all efforts to keep it out. In England the experiment of hermetically sealing the ports was not seriously tried when cholera returned in 1849, 1853 and 1865-66. In 1847 the privy council ordered all arrivals with clean bills from the Black Sea and the Levant to be admitted to free pratique, provided there had been no case of plague during the voyage; and therewith the last remnant of the once formidable quarantine practice against plague may be said to have disappeared.

For a number of years after the passing of the first Quarantine Act (1710) the protective practices in England were of the most haphazard and arbitrary kind. In 1721 two vessels laden with cotton goods, &c., from Cyprus, then a seat of plague, were ordered to be burned with their cargoes, the owners receiving £23,935 as indemnity. By the clause in the Levant Trade Act of 1752 vessels for the United Kingdom with a foul bill (*i.e.* coming from a country where plague existed) had to repair to the lazarets of Malta, Venice, Messina, Leghorn, Genoa or Marseilles, to perform their quarantine or to have their cargoes "sufficiently opened and aired." Since 1741 Stangate Creek (on the Medway) had been made the quarantine station at home; but it would appear from the above clause that it was available only for vessels with clean bills. In 1755 lazarets in the form of floating hulks were established in England for the first time, the cleansing of cargo (particularly by exposure to dew) having been done previously on the ship's deck. There was no medical inspection employed, but the whole routine left to the officers of customs and quarantine. In 1780, when plague was in Poland, even vessels with grain from the Baltic had to lie forty days in quarantine, and unpack and air the sacks; but owing to remonstrances, which came chiefly from Edinburgh and Leith, grain was from that date declared to be a "non-susceptible article." About 1788 an order of council required every ship liable to quarantine, in case of meeting any vessel at sea, or within four leagues of the coast of Great Britain or Ireland, to hoist a yellow flag in the daytime and show a light at the maintopmast head at night, under a penalty of £200. After 1800, ships from plague-countries (or with foul bills) were enabled to perform their quarantine on arrival in the Medway instead of taking a Mediterranean port on the way for that purpose; and about the same time an extensive lazaret was built on Chetney Hill near Chatham at an expense of £170,000, which was almost at once condemned owing to its marshy foundations, and the materials sold for £15,000. The use of floating hulks as lazarets continued as before. In 1800 two ships with hides from Mogador (Morocco) were ordered to be sunk with their cargoes at the Nore, the owners receiving £15,000. About this period it was merchandise that was chiefly suspected: there was a long schedule of "susceptible articles," and these were first exposed on the ship's deck for twenty-one days or less (six days for each instalment of the cargo), and then transported to the lazaret, where they were opened and aired forty days more. The whole detention of the vessel was from sixty to sixty-five days, including the time for reshipment of her cargo. Pilots had to pass fifteen days on board a "convalescent ship." The expenses may be estimated from one or two examples. In 1820 the "Asia," 763 tons, arrived in the Medway with a foul bill from Alexandria, laden with linseed; her freight was £1475 and her quarantine dues £610. The same year the "Pilato," 495 tons, making the same voyage, paid £200 quarantine dues on a freight of £1060. In 1823 the expenses of the quarantine service (at various ports) were £26,090, and the dues paid by shipping (nearly all with clean bills) £22,000. A return for the United Kingdom and colonies in 1849 showed, among other details, that the expenses of the lazaret at Malta for ten years from 1839 to 1848 had been £53,553. From 1846 onwards the establishments in the United Kingdom were gradually reduced, while the last vestige of the British quarantine law was removed by the Public Health Act 1896, which repealed the Quarantine Act 1825 (with dependent clauses of other acts), and transferred

from the privy council to the Local Government Board the powers to deal with ships arriving infected with yellow fever or plague, the powers to deal with cholera ships having been already transferred by the Public Health Act of 1875.

The existing British regulations are those of 9th November 1896; they apply to yellow fever, plague and cholera. Officers of the Customs, as well as of Coast Guard and Board of Trade (for signalling), are empowered to take the initial steps. They certify in writing the master of a supposed infected ship, and detain the vessel provisionally for not more than twelve hours, giving notice meanwhile to the port sanitary authority. The medical officer of the port boards the ship and examines every person in it. Every person found infected is certified of the fact, removed to a hospital provided (if his condition allow), and kept under the orders of the medical officer. If the sick cannot be removed, the vessel remains under his orders. Every person suspected (owing to his or her immediate attendance on the sick) may be detained on board forty-eight hours, or removed to the hospital for a like period. All others are free to land on giving the addresses of their destinations to be sent to the respective local authorities, so that the dispersed passengers and crew may be kept individually under observation for a few days. The ship is disinfected, dead bodies buried at sea, infected clothing, bedding, &c., destroyed or disinfected, and bilge-water and water-ballast (subject to exceptions) pumped out at a suitable distance before the ship enters a dock or basin. Mails are subject to no detention. A stricken ship within 3 miles of the shore must fly at the main a yellow and black flag borne quarterly from sunrise to sunset.

International Conventions.—Since 1852 several conferences have been held between delegates of the Powers, with a view to uniform action in keeping out infection from the East and preventing its spread within Europe; all but that of 1897 were occupied with cholera. No result came of those at Paris 1852, Constantinople 1866, Vienna 1874, and Rome 1885, but each of the subsequent ones has been followed by an international convention on the part of nearly one-half of the Powers represented. The general effect has been an abandonment of the high quarantine doctrine of "constructive infection" of a ship as coming from a scheduled port, and an approximation to the principles advocated by Great Britain for many years. The principal States which retain the old system are Spain, Portugal, Turkey, Greece and Russia (the British possessions Gibraltar, Malta and Cyprus being under the same influence). The aim of each international sanitary convention has been to bind the Powers to a uniform minimum of preventive action, with further restrictions permissible to individual States. The minimum is now very nearly the same as the British practice, which has been in turn adapted to continental opinion in the matter of the importation of rags.

The Venice convention of 1892 was on cholera by the Suez Canal route; that of Dresden, 1893, on cholera within European countries; that of Paris, 1894, on cholera by the pilgrim traffic; and that of Venice, in 1897, was in connexion with the outbreak of plague in the East, and the conference met to settle on an international basis the steps to be taken to prevent, if possible, its spread into Europe.

One of the first points to be dealt with in 1897 was to settle the incubation period for this disease, and the period to be adopted for administrative purposes. It was admitted that the incubation period was, as a rule, a comparatively short one, namely, of some three or four days. After much discussion ten days was accepted by a very large majority. The principle of notification was unanimously adopted. Each Government is to notify to other Governments the existence of plague within their several jurisdictions, and at the same time state the measures of prevention which are being carried out to prevent its diffusion. The area deemed to be infected is limited to the actual district or village where the disease prevails, and no locality is deemed to be infected merely because of the importation into it of a few cases of plague while there has been no diffusion of the malady. As regards the precautions to be taken on land frontiers, it was decided that during the prevalence of plague every country had the inherent right to close its land frontiers against traffic. As regards the Red Sea, it was decided after discussion that a healthy vessel may pass through the Suez Canal, and continue its voyage in the Mediterranean during the period of incubation of the disease the prevention of which is in question. It was also agreed that vessels passing through the Canal in quarantine might, subject to the use of the electric light, coal in quarantine at Port Said by night as well as by day, and that passengers might embark in quarantine at that port. Infected vessels, if these carry a doctor and are provided with a disinfecting stove, have a right to navigate the Canal in quarantine, subject only to the landing of those who are suffering from plague, and of

such persons as have been in actual contact with the sick or with infected articles, together with the disinfection of the infected compartment of the vessel. Passing on to the conclusions dealing with regulations to be imposed "in Europe," the following are the chief points to be noted:—As regards measures to be adopted at ports of arrival, the conclusions of the Dresden convention were as far as practicable adhered to. In the case of healthy vessels, i.e. those on board of which there is no illness, though they have sailed from an infected port, it was decided that they should at once have free *pratique*, but at the option of the local authority certain measures of disinfection of soiled articles may be required. For suspected vessels, viz. those on board of which there has been plague, but no fresh case within twelve days, some limited processes of disinfection, &c., as defined, having been complied with, it is recommended that the crew and passengers should be subject to surveillance for a period of ten days from the date of the arrival of the vessel. In the case of infected vessels, viz. those on which plague is actually present, or on which that disease has occurred ten days before arrival, the sick are to be landed and isolated, and the remainder of those on board are to be subjected, at the discretion of the local authority, to "observation" or "surveillance" for a period not exceeding ten days from the date of the occurrence of the last case of plague. In this convention the terms "observation" and "surveillance" are for the first time clearly defined; the definition as to the latter stating that under that system passengers are not to be isolated, but are to be allowed at once to proceed to their homes, where they can remain under medical supervision so long as may be deemed necessary by the local authority. The results of this conference indicated a great advance on the part of the nationalities represented towards a liberal and truly scientific conception of the means to be adopted by their respective Governments for the prevention and control of infective diseases.

LITERATURE.—A quarantine committee of the Social Science Association collected, in 1860–61, valuable consular returns on the practice of quarantine in all parts of the world; these were edited by Milroy and ordered to be printed (with the report and summary) as three parliamentary papers communicated to the board of trade. The third paper (6th August 1861, No. 544) contains, in an appendix, an *Historical Sketch of Quarantine Legislation and Practice in Great Britain*, by Dr Milroy. Russell's *Treatise of the Plague* (4to, London, 1791) contains "remarks on quarantines, lazarettoes, &c.," and an account of the mode of "shutting up" practised by households in Aleppo on the outbreak of plague in the town. The inexpediency of quarantine in the United Kingdom is discussed by John Simon in the eighth *Report of the Medical Officer of the Privy Council* for 1865, p. 35, and also in *Report (Medical) of Local Government Board*, xxiv. 1892–93.

QUARE IMPEDIT, in English law, a form of action by which the right of presentation to a benefice is tried. It is so called from the words of the writ formerly in use, which directed the sheriff to command the person disturbing the possession to permit the plaintiff to present a fit person, or to show cause "why he hinders" the plaintiff in his right. The action was one of the few real actions preserved by the Real Property Limitation Act 1833, and survived up to 1860. The effect of the Common Law Procedure Act 1860, § 26, was to assimilate proceedings in *quare impedit* as far as possible to those in an ordinary action. It is now usually brought against a bishop to try the legality of his refusal to institute a particular clerk. The bishop must fully state upon the pleadings the grounds on which he refuses. *Quare impedit* is peculiarly the remedy of the patron; the remedy of the clerk is the proceeding called *duplex querela* in the ecclesiastical court. The action is not barred till the expiration of sixty years, or of three successive incumbencies adverse to the plaintiff's right, whichever period be the longer (Real Property Limitation Act, 1833, § 29). Where the patron of a benefice is a Roman Catholic, one of the universities presents in his place (1689, 1 Will. & Mary, sess. 1, c. 29). By 13 Anne c. 13 (1714), during the pendency of a *quare impedit* to which either of the universities is a party in right of the patron being a Roman Catholic, the court has power to administer an oath for the discovery of any secret trust, and to order the *cestui que trust* to repeat and subscribe a declaration against transubstantiation. In Scotland the effect of a *quare impedit* is attained by action of declarator. In the United States, owing to the difference of ecclesiastical organization, the action is unknown.

QUARITCH, BERNARD (1819–1890), English bookseller and collector, was born at Worbis, Germany, on the 23rd of April 1819. After being apprenticed to a bookseller, he went to London in 1842, and was employed by Bohn the publisher. In

1847 he started a bookseller's business off Leicester Square, becoming naturalized as a British subject. In 1848 he started to issue a monthly *Catalogue of Foreign and English Books*. About 1858 he began to purchase rare books, one of the earliest of such purchases being a copy of the Mazarine Bible, and within a period of forty years he possessed six separate copies of this rare and valuable edition. In 1860 he removed to Piccadilly. In 1873 he published the *Bibliotheca Xylographica, Typographica et Palaeographica*, a remarkable catalogue of early productions of the printing press of all countries. He became a regular buyer at all the principal book-sales of Europe and America, and from time to time published a variety of other catalogues of old books. Amongst these may be mentioned the *Supplemental Catalogue* (1877), and in 1880 an immense catalogue of considerably over 2000 pages. The last complete catalogue of his stock was published in 1887–88 under the title *General Catalogue of Old Books and Manuscripts*, in seven volumes, increased with subsequent supplements to twelve. All these catalogues are of considerable bibliographical value. By this time Quaritch had developed the largest trade in old books in the world. Among the books that he published was Fitzgerald's *Omar Khayyám*, and he was the agent for the publications of the British Museum and the Society of Antiquaries. He died at Hampstead on the 17th of December 1899, leaving his business to his son.

QUARLES, FRANCIS (1592–1644), English poet, was born at Romford, Essex, and baptized there on the 8th of May 1592. His father, James Quarles, held several places under Elizabeth, and traced his ancestry to a family settled in England before the Conquest. He was entered at Christ's College, Cambridge, in 1608, and subsequently at Lincoln's Inn. He was made cup-bearer to the Princess Elizabeth, Electress Palatine, in 1613, remaining abroad for some years; and before 1629 he was appointed secretary to Ussher, the primate of Ireland. About 1633 he returned to England, and spent the next two years in the preparation of his *Emblems*. In 1639 he was made city chronologer, a post in which Ben Jonson and Thomas Middleton had preceded him. At the outbreak of the Civil War he took the Royalist side, drawing up three pamphlets in 1644 in support of the king's cause. It is said that his house was searched and his papers destroyed by the Parliamentarians in consequence of these publications. He died on the 8th of September in that year.

Quarles married in 1618 Ursula Woodgate, by whom he had eighteen children. His son, John Quarles (1624–1665), was exiled to Flanders for his Royalist sympathies and was the author of *Fons Lachrymarum* (1648) and other poems.

The work by which Quarles is best known, the *Emblems*, was originally published in 1635, with grotesque illustrations engraved by William Marshall and others. The forty-five prints in the last three books are borrowed from the *Pia Desideria* (Antwerp, 1624) of Herman Hugo. Each "emblem" consists of a paraphrase from a passage of Scripture, expressed in ornate and metaphorical language, followed by passages from the Christian Fathers, and concluding with an epigram of four lines. The *Emblems* was immensely popular with the vulgar, but the critics of the 17th and 18th centuries had no mercy on Quarles. Sir John Suckling in his *Sessions of the Poets* disrespectfully alluded to him as he "that makes God speak so big in's poetry." Pope in the *Dunciad* spoke of the *Emblems*,

"Where the pictures for the page atone
And Quarles is saved by beauties not his own."

The works of Quarles include: *A Feast for Wormes. Set forth in a Poeme of the History of Jonah* (1620), which contains other scriptural paraphrases, besides the one that furnishes the title; *Hodassa; or the History of Queene Ester* (1621); *Job Militant, with Meditations Divine and Morall* (1624); *Sions Elegies, wept by Jeremie the Prophet* (1624); *Sions Sonets sung by Solomon the King* (1624), a paraphrase of the Canticles; *The Historie of Samson* (1631); *Alphabet of Elegies upon . . . Dr Aylmer* (1625); *Argalus and Parthenia* (1629), the subject of which is borrowed from Sir Philip Sidney's *Arcadia*; four books of *Divine Fancies digested into Epigrams, Meditations and Observations* (1632); a reissue of his scriptural paraphrases and the *Alphabet of Elegies as Divine Poems* (1633); *Hieroglyphikes*

of the *Life of Man* (1638); *Enchyridion, containing Institutions Divine and Moral* (1640-41), a collection of four "centuries" of miscellaneous aphorisms; *Observations concerning Princes and States upon Peace and Warre* (1642), and *Boanerges and Barnabas—Wine and Oyle for . . . afflicted Soules* (1644-46), both of which are collections of miscellaneous reflections; three violent Royalist tracts (1644), *The Loyall Convert*, *The Whipper Whipt*, and *The New Distemper*, reissued in one volume in 1645 with the title of *The Profest Royalist; his quarrell with the Times*, and some elegies, *Solomon's Recantation . . .* (1645) contains a memoir by his widow. Other posthumous works are *The Shepherds' Oracles* (1646), a second part of *Boanerges and Barnabas* (1646), a broadside entitled *A Direfull Anathema against Peace-haters* (1647), and an interlude, *The Virgin Widow* (1649).

An edition of the *Emblems* (Edinburgh, 1857) was embellished with new illustrations by C. H. Bennett and W. A. Rogers. These are reproduced in the complete edition (1874) of Quarles included in the "Chertsey Worthies Library" by Dr A. B. Grosart, who provides an introductory memoir and an appreciation which greatly overestimates Quarles's value as a poet.

QUARREL. (1) (Through Fr. *querelle* from Lat. *querela*, complaint), originally a complaint against a person, particularly a legal accusation or charge, hence a ground or cause for complaint or anger, or, more generally, an outbreak of anger or violent dispute. (2) (Through O. Fr. *quarrel* or *quarel*, from med. Lat. *quadrellus*, diminutive of *quadrus*, square), a heavy short bolt or arrow with a square head, used in a cross-bow or arbalest. In architecture this term (and also the doublet "quarry") is applied to any square-shaped opening, in the Beauchamp Roll to the quatrefoils in Perpendicular windows, sometimes to squares of paving, but most commonly to the lozenge-shaped pieces of glass in lead casements (see GLASS, STAINED).

QUARRY. (1) (Through Fr. from med. Lat. *quarria* for *quadraria*; *quadrare*, to square or hew stone), a place from which stones are dug, the term being usually confined to a place where such operation is carried on in the open air, as opposed to a "mine" (see QUARRYING). (2) (Through O. Fr. *cuirée*, *cuir*, skin, leather, Lat. *corium*; cf. mod. Fr. *curée*, spoils), properly certain parts of a deer or other beast of chase given as a reward to the hounds and placed upon the hide of the animal, also parts of a bird given similarly to a hawk or falcon. The word is thus applied to the animal hunted or the bird killed by the hawk, and generally to any object of the chase.

QUARRYING, the art of winning or obtaining from the earth's crust the various kinds of stone used in construction, the operation being, in most cases, conducted in open workings.

According to their composition, building stones are broadly classed as granites, sandstones, limestones and slates. Under the first of these heads is included a number of crystalline rock species, such as granite, syenite, gneiss, &c., which to the geologist are quite distinct, but which in commerce are all spoken

Kinds of stone quarried. of as granite. They are chiefly composed of one or more minerals of the felspar group mingled with one or more of the micas or with hornblende, and usually contain quartz. Sandstones are chiefly composed of fragments of quartz cemented into solid rock by silica and oxide of iron. Of these there are many varieties, including flagstone used for foot-pavements. Limestones consist principally of carbonate of lime. Their chief variations are the crystalline form known as marble and the deposit from mineral springs known as Mexican onyx. Slates are mudstones or shales hardened by heat and pressure, and rendered fissile by the latter agent. Chemically they consist chiefly of hydrous silicate of alumina. Theoretically, granites are massive, and have no bedding or stratification like sandstones and limestones; but all rock masses are usually found to be more or less shattered by movements of the earth's crust which occur as a result of its constant readjustment to the cooling and shrinking interior, so that the rocks are divided by cracks or fissures, which are commonly known as joints. In the massive granites these joints, which usually occur in two or more planes at right angles to one another, are of the greatest importance to the quarryman, as they enable him to separate masses of stone with approximately parallel faces. In gneisses the parallel arrangement of the minerals usually coincides with a direction of easy cleavage,

known to quarrymen as the "rift"; at right angles to this direction is usually one less easy parting, known as the "grain." Sandstones and limestones are stratified rocks which have been formed as sediments in bodies of water; and whether their beds are found in the normal position of horizontality, or whether they have been tilted and folded by earth movements, the direction of easiest separation is coincident with the original planes of sedimentation and parallel to them. This is therefore called the "rift," while the "grain" is at right angles to it. In gneisses, sandstones and limestones joints also occur; and while frequently convenient for the division of the beds into masses of useful size, they may be a detriment, as when they occur so close together as to fall within the limits of a block available for commercial purposes. In commerce the various kinds of building stone are usually designated by the name of the locality or region in which the quarry is situated. In the case of the more important varieties this geographic name usually conveys to the architect or builder full information concerning the colour, texture and other properties of the material. For example, the names Hallowell or Quincy granite, Medina or Berea sandstone, and Vermont or Tennessee marble, convey in the United States full information to those interested.

The methods of quarrying vary with the composition and hardness of the rocks, their structure, cleavage, and other physical properties; also with the position and character of the deposits or rock-masses. The general purpose of the work is to separate the material from its bed in masses of form and size adapted to the intended use. Cutting the stone to accurate dimensions, dressing, rubbing and polishing are subsequent operations not involved in quarrying.

Methods employed.

The practice of quarrying consists in uncovering a sufficient surface of the rock by removing superficial soil, sand or clay, or by sinking a shaft or slope, and then with proper tools and, when necessary, with explosives, detaching blocks of form and size adapted to the purpose in view. Frequently the outer portion of the rock has been affected by the action of the weather and other atmospheric agencies, so that it has become discoloured or softened by decay. This weathered material must be removed before stone can be obtained for use.

A quarry should, if possible, be opened on a hillside, for in this case it is usually much easier to dispose of the water which necessarily collects in any deep excavation, and which, if drainage by gravity is not afforded, must be removed by pumping, at considerable expense. As it is generally most convenient to operate on a vertical face of rock, the preliminary work of opening a quarry is usually directed toward the production of this result; but its accomplishment involves the waste of a certain amount of stone, which must be broken into irregular and useless pieces. The separation of blocks of building stone is effected ordinarily by drilling holes along the outlines of the block to be removed, and then, by exploding blasting-powder in the holes, or by driving wedges into them, exerting sufficient force to overcome the cohesion of the rock and rend it asunder. In many quarries it is found most convenient to separate a large mass and afterwards divide it into blocks of the required size. When the rock is stratified, or has an easily determined "rift," the holes are drilled at right angles to the plane of separation. When there is no stratification or "rift," or these natural planes of separation are too far apart, or when the position of the joints is not advantageous, a row of horizontal holes must be drilled into the face or "breast" of the quarry, along which separation is effected by the use of wedges. Of late at certain American quarries, in a granite which has no rift or direction of ready cleavage, compressed air has been brought into service to effect the separation of extensive layers. A hole is drilled as deep as the desired thickness of the layer to be separated, and a small charge of dynamite is exploded at the bottom of it. This develops a cavity in which a small charge of powder is next exploded, producing a crack or crevice parallel to the surface of the rock. A pipe for conveying compressed air is now sealed into the opening, and gradually increasing pressure is introduced. This results in the gradual extension of the crevice developed by

the explosion of the powder. In the absence of compressed air, water under pressure may be used and also small powder charges exploded at intervals of a few days. In thinly bedded sandstones, where vertical joints are frequent, it is often possible to separate the desired slabs and flagstones with crowbars and wedges, without drilling or the use of explosives. When blasting is necessary, some form of gunpowder is generally used, rather than a violent explosive like dynamite, in order to avoid shattering the rock. This, however, applies only to dimension stone. When the production of broken stone for road-making, concrete, or similar purposes is the sole end in view, violent explosives are preferred. In limestones and marbles and in the softer sandstones, channelling machines, driven by steam, are employed, by which vertical or oblique grooves or channels can be cut with great rapidity to a depth of several feet. A level bed of rock is cleared, and on this are laid rails, along which the machine moves. After the channels are cut, a row of holes is bored perpendicular to the former at the desired distance below the surface of the bed, and by driving wedges into these the required blocks are separated.

When the beds of stone to be quarried are thin, and when to remove the whole of the overlying mass of earth or rock would be too expensive, it is found convenient to treat the quarry as if it were a mine, and to rely upon methods similar to those practised in mining. A horizontal bed of rock is usually opened at its outcrop on some hillside, or if this is impracticable, as shaft or slope is excavated to reach it. If dimension stone is required, a deep horizontal groove is cut near the top or the bottom of the bed. The quarry face is then divided into blocks by saw-cuts, channels, or rows of drill-holes, and the blocks are separated by wedging or blasting. As the excavation or stoping progresses, portions of the rock are left in place as pillars to support the roof. At many localities in Europe where roofing slate is quarried, it is found in beds dipping more or less from the horizontal. These deposits are worked by stopes which follow the inclination of the bed, from which, at convenient intervals, levels are driven across, to take advantage of the cleavage of the slate. As in other subterranean quarries, pillars of rock are left to support the roof, since artificial supports would be more expensive. At some of the marble quarries in Vermont, U.S.A., where the strata are very nearly vertical, the beds are worked to a great depth with a comparatively small surface opening.

See G. P. Merrill, *Stones for Building and Decoration* (New York, 1898); C. Le N. Foster, *A Text-Book of Ore and Stone Mining* (London and Philadelphia, 1894); O. Herrman, *Steinbruchindustrie und Steinbruchgeologie* (Berlin, 1899). (F. J. H. M.)

QUARTER (through Fr. from Lat. *quartarius*, fourth part), a word with many applications of its original meaning, namely, one of the four divisions of anything; thus as a measure of weight a quarter equals 28 lb, one-fourth of the hundredweight of 112 lb; as a measure of capacity for grain it equals 8 bushels; similarly in liquid measure the shorter form "quart" is a quarter of a gallon = 2 pints, so "quartern" is a quarter of a pint (a gill), or, as a measure for bread, 4 lb. "Quarter" is also used of the fourth part of the moon's monthly revolution, and of a fourth part of the legal year, marked off by the "quarter-days" (see below). For the division of the heraldic shield into four "quarters" and the use of the term "quartering," the marshalling of several coats on one shield, see **HERALDRY**. From the four principal points of the compass and the corresponding division of the horizon, &c., the word is used generally of direction or situation, and hence of a district in a town, &c., especially when assigned to or occupied by a particular class. It has thus become the usual term applied to stations, buildings, lodgings, &c., in the regular occupation of military troops (see **BARRACKS**, **CAMP**, and **CANTONMENTS**).

There are many technical uses of the word, in which the original meaning has been lost or obscured; thus in carpentry and architecture it is applied to the main upright posts in framing, sometimes called "studs"; the filling in quarters were formerly named "prick posts"; in farriery, to one side

of the "coffin" of a horse's foot; in bootmaking, to the side piece of leather reaching from the vamp to the heel. The "quarter" of a ship is the after part of her side from the main-chains to the stern (see **QUARTERDECK**).

There has been much discussion as to the origin of the use of the word "quarter" in the sense of mercy, clemency, the sparing of the life of a beaten enemy and the acceptance of his surrender. The same use is found in Fr. *quartier*. Cotgrave explains this word as "faire war, wherein souldiers are taken prisoners and ransomed at a certaine rate." The real origin cannot be, as has often been repeated, following De Brieux (*Origines de plusieurs façons de parler*, 1672), that it was due to a supposed agreement between the Dutch and Spaniards for ransoming officers and men at one quarter of their pay. The true source is either the assignment of "quarters," i.e. lodgings, to captured prisoners whose lives were spared, or the use of the word, now obsolete, for relations with or conduct towards another, often in the sense of fair treatment; thus in Bacon's *Essay on Cunning*, "two, that were competitors, . . . kept good quarter between themselves."

Quarter days are the days that begin each quarter of the year. In England they are the 25th of March (Lady Day), the 24th of June (Midsummer Day), the 29th of September (Michaelmas Day) and the 25th of December (Christmas Day). They are the days on which it is usually contracted that rents should be paid and houses or lands entered upon or quitted. In Scotland there are two legal terms, the 15th of May (Whitsunday) and the 11th of November (Martinmas); these, together with the two conventional terms, 2nd of February (Candlemas) and the 1st of August (Lammas), make up the Scottish quarter days. In the Scottish burghs, however, the removal terms are the 28th of May and the 28th of November. In the United States the quarter days are, in law, the 1st of January, April, July and October.

QUARTERDECK, the after part of the upper deck of a ship. In former times the upper deck of a line-of-battle ship or frigate ended at the mainmast, and was connected with the forecabin by two narrow passages, or gangways running along the sides. The quarterdeck is the residence and symbol of authority in a warship. The starboard, or right side looking forward, is reserved to the senior officer. A sailor who had a complaint to make was said to come to the mainmast, because he placed himself at the forward end of the quarterdeck near the mast. According to the ancient custom of the sea, the quarterdeck is to be saluted by all who come upon it, and the salute is returned by all officers present.

QUARTER SESSIONS, COURT OF, in English law, the name for the justices of the peace of any county, riding, parts, division or liberty of a county, or of any county of a city or county of a town, in general or quarter sessions assembled; it includes the court of the recorder of a municipal borough having a separate court of quarter sessions. The word "general" in this context is contrasted with "special" or "petty." The court is a local court of record having a limited criminal jurisdiction, and also to some extent civil jurisdiction. As a court of record it has, in addition to its other jurisdiction, power to punish summarily without the assistance of a jury contempts committed in its presence, such as insults to the justices or disturbance of its proceedings. At the present time the whole of England and Wales is within the local jurisdiction of some court of quarter sessions. But the history of the court in counties is quite distinct from its history in boroughs.

Counties.—As regards counties the court originated in statutes of 1326, 1344 and 1360, which provided for justices in counties, and the commission of the peace. The court derived its name from the direction in a statute of 1388 that the "justices shall keep their sessions in every quarter of the year at the least." By a statute of 1414 they were directed to make their sessions four times in the year: that is to say, in the first week after the feasts of St Michael, the Epiphany, the clause of Easter and the translation of St Thomas the Martyr, and more often if need be.¹ These dates have only been slightly varied, first in 1814 in consequence of the adoption of the Gregorian calendar, later in 1830 by specifying the first week after the 11th of October, 28th of December, 31st of March and 24th of June respectively, instead of the church feasts; and in 1894 by

¹ An earlier statute not repealed (36 Edw. III. c. 12) fixes the third and fourth sessions differently, viz. second week of mid-Lent, and between Whit Sunday and Midsummer Day

giving the justices a limited power of fixing their sessions so as not to clash with the assizes. It will be seen that the statutes do not limit the justices to four sessions a year: and they are free to sit oftener by adjournment of the quarterly sessions to another time, and even to another place, in their county, or to hold additional sessions. All the sessions thus held are "general," though not all may be "quarter" sessions. The Assizes and Quarter Sessions Act 1908 gave the useful power of dispensing with the holding of quarter sessions if there is no business to transact.

Constitution of the Court.—Such a court sits for every judicial county in England, and is composed of two or more of the justices in the commission of the peace for the county, including *ex officio* justices. The quorum of the court is fixed by the commission of the peace at two. At one time certain specified justices described as of the quorum must be present, but under the present commission there are no such persons. In certain counties more than one commission of the peace is issued, e.g. for the three ridings of Yorkshire (N. E. and W.) and the liberty of Ripon, the three parts of Lincolnshire (Lindsey, Kesteven and Holland), the isle of Ely and the rest of Cambridgeshire, the soke of Peterborough, and the rest of Northamptonshire.¹ In all counties, &c., except that of London, the justices in the commission elect a chairman and vice-chairman, neither of them necessarily a lawyer, to preside at the sittings of the court. In the county of London there are a paid chairman and deputy chairman, who must be barristers of at least ten years' standing, and are appointed by the crown. There is special legislation as to quarter sessions in the county palatine of Lancaster; and in the Salford Hundred of that county there is a paid chairman. There is also special legislation as to Kent, and arrangements have been made by which in Sussex and Suffolk the quarter sessions for the east and west divisions are virtually distinct courts. Under the Quarter Sessions Act 1858 the court may sit in two divisions of at least two justices at the same time and place, but not simultaneously in separate parts of the same county except under statutory authority as in London.

The court may sit while the assizes for the county are being held, but usually refrains from doing so because of the inconvenience which would be occasioned, and adjusts its sittings so as to avoid clashing with the assizes. The chief officer of the court is the clerk of the peace, who acts as clerk to the court, records its proceedings, calls and swears the juries, draws many of the indictments, receives the bills returned by the grand jury, arraigns the prisoners and taxes the costs. In a county he is appointed by a standing joint-committee of the quarter sessions and the county council, and has charge of, and responsibility for, the records and documents of the county subject to the directions of the *custos rotulorum* or the quarter sessions or the county council (Local Govt. Act 1888, s. 83).

Boroughs.—The jurisdiction of the court of quarter sessions of a borough does not depend upon the commission of the peace, but upon the Municipal Corporations Act 1882. Many boroughs have a separate commission of the peace (which does not contain the words of the county commission giving jurisdiction to try indictments), but have not received the grant of a separate court of quarter sessions: and such boroughs are within the jurisdiction of the court of quarter sessions for the county within which the borough lies. Before the Municipal Corporations Act 1835, many boroughs had criminal jurisdiction under their charters. Under that act and the act of 1882 a grant of quarter sessions to a city or borough is made by the crown in council on petition of the town council. The recorder, a barrister of not less than five years' standing appointed by the crown, is sole judge of the court, though the mayor can adjourn it in the absence of the recorder; he has a discretion to fix his own dates for the holding of the court, so long as he holds it once in every quarter of a year; and it may be held more frequently if he think fit, or a secretary of state so directs; he has no power to allow, apportion, make or levy a borough rate or to grant a licence for the sale of excisable liquors by retail; a deputy may be appointed by the recorder, or in the event of his being unable to make the appointment by a secretary of state. Subject to these qualifications the court has the same jurisdiction as county quarter sessions.

The city of London is not subject to the Municipal Corporations Act 1882, and its court of quarter sessions is created by the city charters, and is held before the mayor and aldermen with

¹ In the soke of Peterborough commissions of oyer and terminer, and gaol delivery, as well as a commission of the peace, are issued.

the recorder. It does not now sit to try indictments, which all go to the Central Criminal Court.

There is special legislation as to quarter sessions in the Cinque Ports. In a borough the clerk of the peace is appointed by the town council and holds office during good behaviour (Municipal Corporations Act 1882, s. 164).

Criminal Jurisdiction, Original.—Courts of quarter sessions in counties and boroughs have both original and appellate jurisdiction depending on the commission of the peace and on legislation beginning in 1344. This jurisdiction is derived in counties from the commission of the peace, which directs the justices "to inquire the truth more fully by the oath of good and lawful men of the county, by whom the truth of the matter shall be better known of all manner of crimes, trespasses, and all and singular other offences of which the justices of our peace may or ought lawfully to inquire," "and to hear and determine all and singular the crimes, trespasses and offences aforesaid" "according to the laws and statutes of our realm." "Provided always that if a case of difficulty upon the determination of any of the premises before you shall happen to arise then let judgment in no wise be given" "unless in the presence of one of the justices of assize for the county." This proviso has been read as requiring the justices to reserve the graver felonies for trial at the assizes, or to transmit to assizes indictments found at quarter sessions which raised difficult questions. Quarter sessions never dealt with forgery or perjury, but at one time assumed jurisdiction over almost every other form of crime. By the Quarter Sessions Act 1842 and subsequent legislation, they are forbidden to try the following offences: treason or misprision of treason; murder, capital felony or any felony (except burglary) which is punishable on a first conviction by penal servitude for life; offences against the king's title, prerogative, person or government, or against either House of parliament; offences against the Official Secrets Act 1889; offences subject to the penalties of *praemunire*; blasphemy and offences against religion, and composing or publishing blasphemous, seditious or defamatory libels; administering and taking unlawful oaths; perjury and subordination and making or suborning another to make a false oath, declarations or affirmations punishable as perjury or as a misdemeanour; abduction of women and girls and offences under the Criminal Law Amendment Act 1885; bigamy and offences against the laws of marriage; concealment of birth; bribery and corruption at elections or of agents or public officials (but they can try offences against the Public Bodies Corrupt Practices Act 1889); setting fire to crops, woods and heaths; stealing or destroying certain classes of documents; offences against the factor sections (ss. 75-85) of the Larceny Act as amended by the Larceny Act 1901; and conspiracies to commit offences which the court could not try if committed by one person. Trials before the court with a jury are governed by the same procedure as trials on indictment in a court of assize. Under the Vagrancy Act 1823 and amending acts, they have special powers of sentencing incorrigible rogues sent to them by courts of summary jurisdiction, and under the act of 1360 and the commission of the peace they can, but now rarely do, exercise an original and summary jurisdiction as to articles of the peace (see *RECOGNIZANCE*). They have power to estreat recognizances entered into before themselves or before courts of summary jurisdiction and returned to them for record or forfeiture, but by the Summary Jurisdiction Act 1879 the exercise of the latter power has been rendered unnecessary.

Appellate.—An appeal lies to quarter sessions from convictions by a court of summary jurisdiction only where such an appeal is expressly given by statute. The number of statutes giving such right of appeal is very great. The appellate jurisdiction has been considerably increased by the Summary Jurisdiction Act 1879, which allows (s. 19) an appeal (with certain exceptions) from every conviction or order of a court of summary jurisdiction inflicting imprisonment without the option of a fine. The appeal may be brought in accordance with the act giving the appeal or the Summary Jurisdiction Acts. Most of the special procedure in statutes giving the right to appeal has been swept away by the Summary Jurisdiction Act 1884.

Civil Jurisdiction, Original.—Originally the county justices were confined to the exercise in or out of sessions of the powers given by the commission of the peace and of certain statutory duties as to rioters, &c. Under the Tudors and Stuarts the justices acting under the supervision of the Privy Council and the court of king's bench gradually became the rulers of the county in administrative and social as well as judicial matters (F. W. Maitland, *Justice and Police*, 1885, p. 80). The process by which this result was attained is traced in Webb's *English Local Government* (1907, vol. i.). The effect of the change was the supersession by nominees of the crown of the common law authorities and officers of county, hundred and township. But the change extended only to a small extent to municipal boroughs. By legislation in and since 1888 most of the administrative powers and duties of justices in general and quarter sessions have been transferred to the incorporated and elective councils of counties, boroughs and urban and rural districts. But the justices still possess certain original, civil or quasi-civil

jurisdiction with respect to the extinction of licences to sell intoxicants, and jointly with the county councils over the county police, and as to closing highways, and also powers as to fixing the petty sessional divisions of their county.

Appellate.—Theoretically quarter sessions have original jurisdiction in any matter as to which two justices have jurisdiction, unless the statute giving the jurisdiction gives an appeal to quarter sessions as a result of this rule. Most of the civil jurisdiction of quarter sessions is now appellate, *i.e.* with reference to orders made by justices out of quarter sessions as to the settlement and removal of paupers, or under the Highway, Licensing and Bastardy Acts, or as to appeals against assessments or rating. The procedure as to each form of appeal depends partly on the statute by which it is given and partly on the general provisions of the Summary Jurisdiction Acts 1879 and 1884. In substance their only original jurisdiction in civil or quasi-civil matters is now in cases of apprenticeship (5 Eliz. c. 4) and articles of the peace (1 Edw. III. st. 2, c. 16).

Appeal from Quarter Sessions.—There is no appeal properly so called from quarter sessions to the High Court either on facts or law. But decisions on law may be reviewed by the High Court (king's bench division) by means of *certiorari*, *mandamus* or prohibition; convictions on indictment before courts of quarter sessions are within the provisions of the Criminal Appeal Act 1907 (see **APPEAL**), except convictions on indictments for obstruction or non-repair of a public bridge, highway or river, from which an appeal lies to the court of appeal in the same way as in the case of civil actions tried at assizes. Quarter sessions have also power to reserve a special case for the High Court on conviction or indictment (Crown Cases Act 1848), and also in other cases to consult the High Court by special case stated under the commission or under the Quarter Sessions Act 1849. Questions of law alone can be referred by special case, and there is no means of compelling the court to state a case. The procedure as to cases not within the acts of 1848, 1849 and 1907 is regulated by the Crown Office Rules of 1906, and s. 2 of the Judicature Act 1894, which gives the High Court certain powers of drawing inferences of fact from the evidence taken in the court below.

Scotland.—Justices of the peace were established in Scotland by act of 1587, c. 82, and quarter sessions by act of 1661, c. 338 (12mo edition, c. 38), which directs that the justices of peace in each respective shire shall meet and convene together four times in the year, on the first Tuesday of March, May and August, and the last Tuesday of October, to administer justice to the people on things that are within their jurisdiction, and punish the guilty for faults and crimes done and committed in the preceding quarter. The obsolete details in this act were repealed in 1906, but the power of requiring law burrows, *i.e.* sureties to keep the peace, is preserved. By the Union with Scotland Amendment Act 1707 provision was made for appointing justices of the peace in shires, stewardries and burghs in Scotland; and the justices to be appointed are given authority to exercise whatever doth appertain to the office and court of a justice of peace by virtue of the laws and acts of parliament made in England before the Union in relation to and for the preservation of the public peace. "Provided that in the sessions of the peace the methods of trial and judgments shall be according to the law of Scotland." The quarter sessions do not sit for the trial of indictments, but have powers of reviewing the decisions of justices in petty sessions (see **SUMMARY JURISDICTION**). This power extends, *inter alia*, to revenue cases and cases under the Pawnbrokers Acts. Their jurisdiction as to the grant and refusal of liquor licences was taken away by the Licensing Scotland Act 1903, but they still have appellate jurisdiction as to offences under the Licensing Acts, ss. 101-103. An appeal lies to the Circuit Court of Justiciary unless the statute under which they act otherwise provides. In criminal matters their functions are not considerable, most of the work done by justices in England being in Scotland dealt with by the sheriff or his substitutes, or by stipendiaries in the great cities. Their decisions in criminal cases are reviewable by the Court of Justiciary and in revenue cases by the court of exchequer. Their original jurisdiction is very limited and almost wholly civil. Thus they have power to divide a county and to make rules for the purposes of the Justices of the Peace Small Debts Acts 1825 and 1849.

Ireland.—In Irish municipal boroughs a court of quarter sessions may be granted and a recorder appointed under an act of 1840. In the case of Dublin, Cork, Belfast, Londonderry and Galway, the office of recorder may be united with that of chairman of quarter sessions for the adjoining county. The general criminal jurisdiction of the quarter sessions has the same origin and is on the same lines as in England; but the limitations imposed as to offences which may be tried are not so narrow as in England. The sessions, &c., are regulated in the main by an act of 1851. The appellate jurisdiction rests on different statutes from those applicable to England, but is on the same lines (see 14 & 15 Vict. c. 93; 40 & 41 Vict. c. 56). In Ireland quarter sessions courts are held before a salaried officer once styled the assistant barrister and now chairman, who is usually also judge of a civil bill court (the Irish county court), or recorder of a neighbouring city or borough. The appointment and tenure of office of the chairman is regulated by statutes dating from 1851

to 1889. The jurisdiction of the court is not limited by the Quarter Sessions Act 1842.

India.—In India courts of record were established in Madras and Bombay, originally styled mayors' courts and subsequently made recorders' courts, with a jurisdiction corresponding as to criminal matters to that of a borough court of quarter sessions in England. Throughout India there are under the Criminal Procedure Code of 1898 courts of sessions in each province for the purpose of criminal jurisdiction, which take the place of assizes and quarter sessions in England. They are under the supervision of the High Courts; but can try and sentence for any crime, subject as to sentences of death to confirmation by the High Court.

Canada.—In Canada courts of general quarter sessions exist in some provinces, *e.g.* Quebec. In New Brunswick they are replaced by the county court. Their jurisdiction to try indictable offences is defined by Part 42 of the Criminal Code 1892.

Australia.—In Queensland the place of quarter sessions is taken by the district courts, which have a criminal jurisdiction substantially the same as that of the English court of quarter sessions (31 Vict. No. 30, s. 117). In New South Wales quarter sessions continue. In Victoria a court of general sessions has been created by statute with powers closely resembling those of the English court of quarter sessions (*re Dunn*, 1906, Victoria State Rep. 493).

United States.—Courts of quarter sessions exist in many of the states; their jurisdiction is determined by state legislation, and extends as a rule only to the less grave crimes. They are in most, if not all, states held before professional judges. (W. F. C.)

QUARTER-STAFF, a staff of wood from 6 to 9 ft. in length, used as a means of attack and defence; originally no doubt it was the cudgel or sapling with which many heroes are described by early writers as being armed. The quarter-staff attained great popularity in England in the middle ages. It was usually made of oak, the ends often shod with iron, and it was held with both hands, the right hand grasping it one quarter of the distance from the lower end (whence the name) and the left at about the middle.

Egerton Castle (*Schools and Masters of Fence*) says that the staff was the "foil," or practice-substitute for the *long sword*, or *two-hander*. In earlier times it may also have been used as a practice weapon for the spear and bill. In the prints illustrative of the life of Richard Beauchamp, earl of Warwick (1382-1430), reproduced in Joseph Strutt's *Manners, Customs, Arms, Habits, &c. of the Inhabitants of England*, may be seen a combat between two knights after they have splintered their lances and dismounted, in which both are fighting with pointed staves about as long as a quarter-staff and held in the same manner. In the 17th century the staff was still popular in England.

At the present time the quarter-staff is used to a limited extent in military circles as a school for bayonet play. It is somewhat lighter than the old weapon, being usually made of bamboo and about 8 ft. long. Sabre-masks, gloves, padded jackets and shin-guards are worn. Another kind of staff, called by Captain A. Hutton (*Cold Steel*) the Great Stick, about 5 ft. long and made of stout rattan, is used in the French and Italian armies in general gymnastic exercises and as a school for bayonet play. The Italian method rather resembles that of the old two-handed sword, while the French approaches more closely to English quarter-staff play.

See *Quarter-Staff*, by T. A. McCarthy (London, 1883); *Broadsword and Singlestick*, by R. G. Allanson-Winn and C. Phillips-Wolley (London, 1898).

QUARTO, a shortened form of Lat. *in quarto*, "in a fourth," *i.e.* of a sheet of paper, applied to a size of paper, and to a size of a printed volume. Paper is *in quarto* when a whole single sheet is folded twice so as to form four leaves; a book is technically termed of "quarto" size when made up of sheets folded twice.

QUARTZ, a widely distributed mineral species, consisting of silicon dioxide, or silica (SiO₂). It is the commonest of minerals, and is met with in a great variety of forms and with very diverse modes of occurrence. The various forms of silica have attracted attention from the earliest times, and the water-clear crystallized variety was known to the Greeks as *κρυσταλλος* (clear ice), being supposed by them to have been formed from water by the intense cold of the Alps; hence the name "crystal," or more commonly rock-crystal, applied to this variety. The name quartz is an old German word of uncertain origin: it was used by G. Agricola in 1529.

Quartz is a mineral which is put to many uses. Several of the varieties are cut into gems and ornaments, balance weights, pivot supports for delicate instruments, agate mortars, &c.; or used for engraving, for instance, cameos and the elaborately carved crystal vases of ancient and medieval times. Clear transparent rock-crystal is used for optical purposes and spectacle lenses. Fused quartz has recently been used for the construction of lenses and laboratory vessels, or it may be drawn out into the finest elastic fibres and used for suspending mirrors, &c., in physical apparatus. For striking fire, flint is used even to the present day. Buhrstone, a cellular variety of chalcedonic quartz from the Tertiary strata of the Paris basin, is largely used for millstones. Quartz is a valuable grinding and polishing material, and is used for making sand-paper and scouring-soap. It is also largely used in the manufacture of glass and porcelain, "silver sand" being a pure quartz sand.

Quartz crystallizes in the trapezohedral-hemihedral class of the rhombohedral division of the hexagonal system. Crystals of this class possess neither planes nor centre of symmetry, but only axes of symmetry; perpendicular to the principal triad axis there are three uniterminal dyad axes of symmetry. Usually, however, this lower degree of symmetry is not indicated by the faces developed on the crystals. The majority of crystals of quartz are bounded only by the faces of a hexagonal prism $m[2\bar{1}1]$ and a hexagonal bipyramid (fig. 1), though sometimes the prism is absent (fig. 2). Frequently the faces are of different sizes (fig. 3): mis-shapen crystals

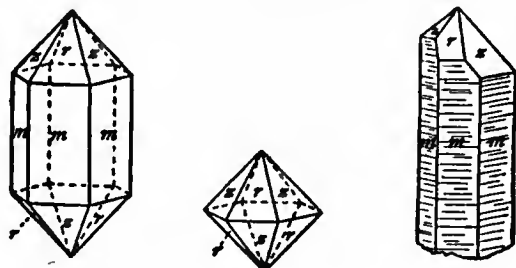

FIG. 1.

FIG. 2.

FIG. 3.

are common and sometimes very puzzling, but they can always be orientated by the aid of the very characteristic striations on the prism faces, which serve also to distinguish quartz from other minerals of similar appearance. These striations (fig. 3) are horizontal in direction, being parallel to the edges of intersection between the prism and pyramid faces, and are due to the frequent oscillatory combination of these faces. The apparent hexagonal bipyramid is really a combination of two rhombohedra, the direct rhombohedron $r[100]$ and the inverse rhombohedron $z[2\bar{2}1]$. The faces of these two rhombohedra exhibit differences in surface characters, those of r being usually brighter in lustre than those of z ; further, the former often predominate in size (figs. 4 and 5), and the latter may sometimes be completely absent. When both the prism and the rhombohedron z are absent, the crystals resemble cubes in appearance, since the angles between the faces of the rhombohedron are $85^\circ 46'$. The additional faces s and x (figs. 4 and 5), which indicate the true degree of symmetry of quartz, are of comparatively rare occurrence except on crystals from certain localities. The six small faces $s[4\bar{1}2]$ situated on alternate corners at each end of the crystal, are called the "rhomb" faces, because of their shape; if extended they would give a trigonal bipyramid. The "trapezohedral," or "plagihedral," faces $x[4\bar{1}\bar{2}]$ belong to a trigonal trapezohedron. The two crystals shown in figs. 4 and 5 are

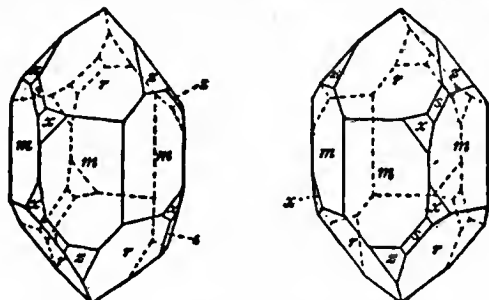

FIG. 4.

FIG. 5.

enantiomorphous, *i.e.* they are non-superposable, one being the mirror reflection of the other: they are left-handed and right-handed crystals respectively. The faces s are striated parallel to their edge

of intersection with r ; this serves to distinguish r and z , and thus, in the absence of x faces, to distinguish left- or right-handed crystals. Numerous other faces have been observed on crystals of quartz, but they are of rare occurrence. The basal plane, so common on calcite and many other rhombohedral minerals, is of the greatest rarity in quartz, and when present only appears as a small rough face formed by the corrosion of the crystal. Faces of prisms other than m are also small and of exceptional occurrence.

Twinned crystals of quartz are extremely common, but are complex in character and can only be deciphered when the faces s and x are present, which is not often the case. Usually they are interpenetration twins with the principal axis as twin-axis; the prism planes of the two individuals coincide, and the faces r and z also fall into the same plane. Such twins may therefore be mistaken for simple crystals unless they are attentively studied; but the twinning is often made evident by the presence of irregularly bounded areas of the duller z faces coinciding with the brighter r faces. In a rarer type of twinning, in which the twin-plane is $[5\bar{2}1]$ (a plane truncating the edge between r and z), the two individuals are united in juxtaposition with their principal axis nearly at right angles ($84^\circ 33'$). A few magnificent specimens of rock-crystal twinned according to this law have been found at La Gardette in Isère, and in Japan they are somewhat abundant.

The pyro-electric characters of quartz are closely connected with its peculiar type of symmetry and especially with the three uniterminal dyad axes. A crystal becomes positively and negatively electrified in alternate prism edges when its temperature changes. A similar distribution of electric charges is produced when a crystal is subjected to pressure; quartz being thus also piezo-electric. Etched figures, both natural and artificial (in the latter case produced by the action of hydrofluoric acid), on the faces of the crystals are in accordance with the symmetry, and may serve to distinguish left- and right-handed crystals.

In its optical characters, quartz is also of interest, since it is one of the two minerals (cinnabar being the other) which are circularly polarizing. This phenomenon is connected with the symmetry of the crystals, and is also shown by the crystals of certain other substances in which there are neither planes nor centre of symmetry. A ray of plane-polarized light traversing a right-handed crystal of quartz in the direction of the triad axis has its plane of polarization rotated to the right, while a left-handed crystal rotates it to the left. A section 1 mm. thick, cut perpendicular to the principal axis of a quartz crystal, rotates the plane of yellow (D) light through 22° , and of blue (G) light through 43° . Such a section when examined in the polariscope shows an interference figure with a coloured centre, there being no black cross inside the innermost ring (this is not shown in very thin sections). Superimposed sections of right- and left-handed quartz, as may sometimes be present in sections of twinned crystals, exhibit Airy's spirals in the polariscope. The indices of refraction of quartz for yellow (D) light are $\omega = 1.5442$ and $\epsilon = 1.5533$; the optic sign is therefore positive.

Quartz has a hardness of 7 (being chosen as No. 7 on Mohs' scale), and it cannot be scratched with a knife; its specific gravity is 2.65. There is no distinct cleavage; though an imperfect cleavage may sometimes be developed parallel to the faces of the rhombohedron r by plunging a heated crystal into cold water. The glassy conchoidal fracture is a characteristic feature of the crystallized mineral. A peculiar rippled or "thumb-marked" fracture is sometimes to be seen, especially in amethyst (*q.v.*), and is due to repeated intergrowths of right- and left-handed material. The mineral is a non-conductor of electricity; it is unattacked by acids with the exception of hydrofluoric acid, and is only slightly dissolved by solutions of caustic alkalis. It is infusible before the gas blowpipe, but in the oxyhydrogen flame fuses to a clear colourless glass, which has a hardness of 5 and specific gravity 2.2.

Many peculiarities of the growth of crystals are well illustrated by the mineral quartz. Thus in "ghost quartz," in which one crystal is seen inside another, the stages of growth are marked out by thin layers of enclosed material. In "capped quartz" these layers are thicker, and the successive shells of the crystal may be easily separated. "Sceptre quartz," in which a short thick crystal is mounted on the end of a long slender prism, indicates a change in the conditions of growth. Crystals with a helical twist are not uncommon. Enclosures of other minerals (rutile, chlorite, haematite, göthite, actinolite, asbestos and many others) are extremely frequent in crystals of quartz. Cavities, either rounded or with the same shape ("negative crystals") as the surrounding crystal, are also common; they are often of minute size and present in vast numbers. Usually these cavities contain a liquid (water, a saline solution, carbon dioxide or petroleum) and a movable bubble of gas. The presence of these enclosed impurities impairs the transparency of crystals. Crystals of quartz are usually attached at one end to their rocky matrix, but sometimes, especially when embedded in a soft matrix of clay, gypsum or salt, they may be bounded on all sides by crystal faces (fig. 1). In size they vary between wide limits, from minute sparkling points encrusting rock surfaces and often so thickly clustered together as to produce a drusy effect, to large single crystals measuring a yard in length and diameter and weighing half a ton.

The characters as given above apply more particularly to crystals of quartz, but in the various massive and compact varieties the material may be quite different in general appearance. Thus in the microcrystalline chalcedony (*q.v.*) the lustre is waxy, the fracture fibrous to even, and the external form botryoidal or stalactitic: flint and chert are compact and have a splintery fracture: jasper (*q.v.*) is a compact variety intermixed with much iron oxide and clay and has a dull and even fracture. Further, these varieties may be of almost any colour, whereas transparent crystals have only a limited range of colour, being either colourless (rock-crystal), violet (amethyst), brown (smoky quartz) or yellow (citrine).

Quartz occurs as a primary and essential constituent of igneous rocks of acidic composition such as granite, quartz-porphiry and rhyolite, being embedded in these either as irregularly shaped masses or as porphyritic crystals. In pegmatite (graphic granite) and granophyre it often forms a regular intergrowth with feldspar. It is also a common constituent, as irregular grains, in many gneisses and crystalline schists, a quartz-schist being composed largely of quartz. By the weathering of silicates, silica passes into solution and quartz is deposited as a secondary product in the cavities of basic igneous rocks, and in fact in the crevices and along the joints of rocks of almost all kinds. Extensive veins of quartz are especially frequent in schistose rocks. Vein-quartz, often of economic importance as a matrix of gold, may, however, in some cases have been of igneous origin. In mineral veins and lodes crystallized quartz is usually the most abundant gangue mineral; the crystals are often arranged perpendicular to the walls of the lode, giving rise to a "comby" structure. In limestones of various kinds it occurs as nodules and bands of chert and flint, being in this case of organic origin. Quartz being a mineral very resistant to weathering agencies, it forms the bulk of sands and sandstones; and when the sand grains are cemented together by a later deposit of secondary quartz a rock known as quartzite results. Pseudomorphous quartz, *i.e.* quartz replacing other minerals, is of frequent occurrence, and as a petrifying material replacing organic remains it is often met with. As a deposit from hot springs, quartz is much less common than opal. Crystals of quartz may be readily prepared artificially by a number of methods; for example, by heating glass or gelatinous silica with water under pressure.

For particulars respecting the special characters, modes of occurrence and localities of the more important varieties of quartz, reference may be made to the following articles: AGATE, AMETHYST, AVENTURINE, BLOODSTONE, CAIRNGORM, CARNELIAN, CAT'S-EYE, CHALCEDONY, CHRYSOPRASE, FLINT, HELIOTROPE, JASPER, MOCHA-STONE, ONYX, ROCK-CRYSTAL, SARD, SARDONYX. For other forms of silica see OPAL and TRIDYMITÉ. (L. J. S.)

QUARTZITE, in petrology, a sandstone which by the deposit of crystalline quartz between its grains has been compacted into a solid quartz rock. As distinguished from sandstones, quartzites are free from pores and have a smooth fracture, since when struck with the hammer they break through the sand grains, while in sandstones the fracture passes through the cementing material and the rounded faces of the grains are exposed, giving the broken surface a rough or granular appearance. The conversion of sandstone into quartzite is sometimes the work of percolating water under ordinary conditions. In the Reading beds of England, which are for the most part loose sands, there are often many large blocks of quartzite which weather out and are exposed at the surface, being known as grey-wethers. The silicification of these rocks must have taken place at no great depth and under ordinary pressures. Most quartzites, however, are found among ancient rocks, such as the Cambrian or Pre-Cambrian. Instances are the Lickey quartzite of Shropshire, the Holyhead quartzite of Anglesey, the Durness quartzite of Sutherlandshire, the Banffshire and Perthshire quartzites and the Cherbourg quartzite. As these rocks lie in regions where there has been a considerable amount of metamorphism we may infer that (in addition to time and pressure) folding and rise of temperature favour the production of rocks of this type.

A normal quartzite has in microscopic section its elastic structure well preserved; the rounded sand grains are seen with patches of new quartz in the interspaces, and the latter is often deposited in crystalline continuity, so that the optical properties of the grains are similar to those of the material which surrounds them: a line of iron oxides or other impurities often indicates the boundary of the original sand grain. As might be expected, however, many of the oldest quartzites have been crushed by folding movements and the quartz consists in large part of a mosaic of small crystalline fragments of irregular shape with interlocking margins; these are called "sheared quartzites," and when they contain white mica in parallel crystalline flakes they become more fissile and pass into quartz-schists. Where sandstones are baked by intrusive

granite or diabase they are often converted into pure quartzite, the heat evidently occasioning the deposit of interstitial quartz.

The commonest minerals in quartzite, in addition to quartz, are feldspar (microcline, orthoclase, oligoclase), white mica, chlorite, iron oxides, rutile, zircon and tourmaline. Except feldspar they are usually present only in small quantity; the less frequent accessories include hornblende, sillimanite, garnet, biotite, graphite, magnetite and epidote. In colour quartzites are often snowy white; they frequently have a fine angular jointing and break up into rubble under the action of frost. Quartzites are too hard and splintery to be used as building stones to any large extent: they furnish a thin and very barren soil, and because they weather slowly tend to project as hills or mountain masses. They are rarely fossiliferous (*e.g.* Gorran in Cornwall), though many of them contain worm casts which may be dragged out into long sinuous markings when the rock is much folded (Durness quartzite). Although much used as road stones, being very hard, they are readily crushed to powder unless well embedded in the road surface; the Cherbourg and Emborough (near Bristol) stones are employed for this purpose. Quartzite blocks may be used in tube mills for crushing and grinding ores, cements, &c.; rarely they have been adopted as a substitute for flint by Palaeolithic man for the fabrication of weapons and tools. (J. S. F.)

QUARTZ-PORPHYRY, in petrology, the name given to a group of hemi-crystalline acid rocks containing porphyritic crystals of quartz in a more fine-grained matrix which is usually of micro-crystalline or felsitic structure. In the hand specimens the quartz appears as small rounded, clear, greyish, vitreous blebs, which are crystals (double hexagonal pyramids) with their edges and corners rounded by resorption or corrosion. Under the microscope they are often seen to contain rounded enclosures of the ground-mass or fluid cavities, which are frequently negative crystals with regular outlines resembling those of perfect quartz crystals. Many of the latter contain liquid carbonic acid and a bubble of gas which may exhibit vibratile motion under high magnifying powers. In addition to quartz there are usually phenocrysts of feldspar, mostly orthoclase, though a varying amount of plagioclase is often present. The feldspars are usually full and cloudy from the formation of secondary kaolin and muscovite throughout their substance. Their crystals are larger than those of quartz and sometimes attain a length of two inches. Not uncommonly scales of biotite are visible in the specimens, being hexagonal plates, which may be weathered into a mixture of chlorite and epidote. Other porphyritic minerals are few, but hornblende, augite and bronzite are sometimes found, and garnet, cordierite and muscovite may also occur. The garnets are small, of rounded shape and red or brownish colour; in some cases they appear to have been corroded or absorbed. Cordierite forms six-sided prisms with flat ends; these divide, between crossed nicols, into six triangular areas radiating from a centre, as the crystals, which belong to the rhombic system, are not simple but consist of three twins interpenetrating and crossing. In the vast majority of cases the cordierite has weathered to an aggregate of scaly chlorite and muscovite; this is known as pinite and is of dark green colour and very soft. The quartz-porphyrines or elvans which occur as dikes in Cornwall and Devon frequently contain this mineral. The augite and hornblende of these rocks are in most cases green, and are frequently decomposed into chlorite, but even then can usually be identified by their shape. A colourless rhombic pyroxene (enstatite or bronzite) occurs in a limited number of the rocks of this group and readily weathers to bastite. Apatite, magnetite, and zircon, all in small but frequently perfect crystals, are almost universal minerals of the quartz-porphyrines.

The ground-mass is finely crystalline and to the unaided eye has usually a dull aspect resembling common earthenware; it is grey, green, reddish or white. Often it is streaked or banded by fluxion during cooling, but as a rule these rocks are not vesicular. Two main types may be recognized by means of the microscope—the felsitic and the microcrystalline. In the former the ingredients are so fine-grained that in the thinnest slices they cannot be determined by means of the microscope. Some of these rocks show perlitic or spherulitic structure, and such rocks were probably originally glassy (obsidians or pitchstones), but by lapse of time and processes of alteration have slowly passed into very finely crystalline state. This change is called devitrification; it is common in glasses, as these are essentially unstable. A large number of the finer quartz-porphyrines are also in some degree silicified or

impregnated by quartz, chalcedony and opal, derived from the silica set free by decomposition (kaolinization) of the original felspar. This re-deposited silica forms veins and patches of indefinite shape or may bodily replace a considerable area of the rock by metasomatic substitution. The opal is amorphous, the chalcedony finely crystalline and often arranged in spherulitic growths which yield an excellent black cross in polarized light. The microcrystalline ground-masses are those which can be resolved into their component minerals in thin slices by use of the microscope. They prove to consist essentially of quartz and felspars, which are often in grains of quite irregular shape (microgranitic). In other cases these two minerals are in graphic intergrowth, often forming radiate growths of spherulites consisting of fibres of extreme tenuity; this type is known as granophyric. There is another group in which the matrix contains small rounded or shapeless patches of quartz in which many rectangular felspars are embedded; this structure is called micropoikilitic, and though often primary is sometimes developed by secondary changes which involve the deposit of new quartz in the ground-mass. As a whole those quartz-porphyrries which have microcrystalline ground-masses are rocks of intrusive origin. Elvan is a name given locally to the quartz-porphyrries which occur as dikes in Cornwall; in many of them the matrix contains scales of colourless muscovite or minute needles of blue tourmaline. Fluorite and kaolin appear also in these rocks, and the whole of these minerals are due to pneumatolytic action by vapours permeating the porphyry after it had consolidated but probably before it had entirely cooled.

Many ancient rhyolitic quartz-porphyrries show on their weathered surfaces numerous globular projections. They may be several inches in diameter, and vary from this size down to a minute fraction of an inch. When struck with a hammer they may detach readily from the matrix as if their margins were defined by a fissure. If they are broken across their inner portions are often seen to be filled with secondary quartz, chalcedony or agate: some of them have a central cavity, often with deposits of quartz crystals; they also frequently exhibit a succession of rounded cracks or dark lines occupied by secondary products. Rocks having these structures are common in N. Wales and Cumberland; they occur also in Jersey, the Vosges and Hungary. It has been proposed to call them *pyromérides*. Much discussion has taken place regarding the origin of these spheroids, but it is generally admitted that most of them were originally spherulites, and that they have suffered extensive changes through decomposition and silicification.

Many of the older quartz-porphyrries which occur in Palaeozoic and Pre-Cambrian rocks have been affected by earth movements and have experienced crushing and shearing. In this way they become schistose, and from their felspar minute plates of sericitic white mica are developed, giving the rock in some cases very much of the appearance of mica-schists. If there have been no phenocrysts in the original rock, very perfect mica-schists may be produced, which can hardly be distinguished from sedimentary schists, though chemically somewhat different on account of the larger amounts of alkalis which igneous rocks contain. When phenocrysts were present they often remain, though rounded and dragged apart while the matrix flows around them. The glassy or felsitic enclosures in the quartz are then very suggestive of an igneous origin for the rock. Such porphyry-schists have been called porphyroids or porphyroid-schists, and in America the name *apophylite* has been used for them. They are well known in some parts of the Alps, Westphalia, Charnwood (England), and Pennsylvania. The *hällflintas* of Sweden are also in part acid igneous rocks with a well-banded schistose or granulitic texture.

The quartz-porphyrries are distinguished from the rhyolites by being either intrusive rocks or Palaeozoic lavas. All Tertiary acid lavas are included under rhyolites. The intrusive quartz-porphyrries are equally well described as granite-porphyrries. The palaeozoic effusive quartz-porphyrries (or acid lavas) would be called rhyolites by many English petrologists, who regard geological age as of no importance in petrological classifications. But the name quartz-porphiry, though somewhat ambiguous, is so expressive and so firmly established by long-continued use that it cannot be discarded, especially as a descriptive name for the use of field geologists. (J. S. F.)

QUASSIA, the generic name given by Linnaeus to a small tree of Surinam in honour of the negro Quassi or Coissi, who employed the intensely bitter bark of the tree (*Quassia amara*) as a remedy for fever. The original quassia was officially recognized in the *London Pharmacopoeia* of 1788. In 1800 it was replaced by the bitter wood or bitter ash of Jamaica, *Picraena excelsa*, which was found to possess similar properties and could be obtained in pieces of much larger size. Since that date this wood has continued in use in Britain under the name of quassia to the exclusion of the Surinam quassia, which, however, is still employed in France and Germany. *Picraena excelsa* is a tree 50 to 60 ft. in height, and resembles the common ash in appearance. It has large compound leaves composed of four

or five pairs, with a terminal odd one, of short-stalked, oblong, blunt, leathery leaflets, and inconspicuous green flowers. The fruit consists of black shining drupes about the size of a pea. It is found also in other West Indian islands, as Antigua and St Vincent. *Quassia amara* is a shrub or small tree belonging to the same natural order as *Picraena*, viz. Simarubaceae, but is readily distinguished by its large handsome red flowers arranged in terminal clusters. It is a native of Panama, Venezuela, Guiana and northern Brazil. Jamaica quassia is imported into England in logs several feet in length and often nearly one foot in thickness, consisting of pieces of the trunk and larger branches. The thin greyish bark is usually removed. The wood is nearly white, or of a yellowish tint, but sometimes exhibits blackish markings due to the mycelium of a fungus. The wood has a pure bitter taste, and is without odour or aroma. It is usually to be met with in the form of turnings or raspings, the former being obtained in the manufacture of the "bitter cups" which are made of this wood. The chief constituent is a bitter neutral principle known as quassin. It exists in the wood to the extent of about 1½%. It forms crystalline needles soluble in alkalis, chloroform and 200 parts of water. There is also present a volatile oil. The wood contains no tannin, and for this reason quassia, like chiretta and calumba, may be preserved with iron. The infusion is useful as a bitter tonic—a group of substances of which calumba is the type—and is also a very efficient anthelmintic for the threadworm (*Oxyuris vermicularis*). It is used by brewers as a substitute for hops.

QUATERNARY, in geology, the time-division which embraces the Pleistocene and Holocene epochs, i.e. the later portion of the Cainozoic era, equivalent to the "Post-Pliocene" or "Post-Tertiary" of certain writers. The term was proposed by J. Desnoyers in 1829 to cover those formations which were formed just anterior to the present. There are other ways of regarding the Quaternary time. Sir A. Geikie (*Text Book of Geology*, 4th ed., 1903) divides it into an upper, post-glacial or Human period, and a lower, Pleistocene or Glacial period; but he subdivides the former into an Historic and a Prehistoric epoch, a scheme presenting difficulties, for the Palaeolithic or lower stage of prehistoric time cannot really be separated from the Pleistocene (*q.v.*). E. Kayser (*Formationskunde*, 3rd ed., 1906), who is in agreement with the definition accepted above, employs a nomenclature which is rarely adopted by British geologists; he divides the *Quartarformation* (Quartär) into a younger, modern epoch, the Alluvium, and an older epoch, the Pleistocene or Diluvium (= Glacial). A. de Lapparent, on the other hand (*Traité de géologie*, 5th ed., 1906), treats the *Era moderne* or *Quaternaire* as a great time division equivalent in value to the Tertiary, Secondary, &c., which is so far represented only by a first epoch, the Pleistocene.

QUATERNIONS, in mathematics. The word "quaternion" properly means "a set of four." In employing such a word to denote a new mathematical method, Sir W. R. Hamilton was probably influenced by the recollection of its Greek equivalent, the Pythagorean Tetractys (*Τετρακτῖς*, the number four), the mystic source of all things. Quaternions (as a mathematical method) is an extension, or improvement, of Cartesian geometry, in which the artifices of co-ordinate axes, &c., are got rid of, all directions in space being treated on precisely the same terms. It is therefore, except in some of its degraded forms, possessed of the perfect isotropy of Euclidian space. From the purely geometrical point of view, a quaternion may be regarded as the quotient of two directed lines in space—or, what comes to the same thing, as the factor, or operator, which changes one directed line into another. Its analytical definition will appear later.

History.—The evolution of quaternions belongs in part to each of two weighty branches of mathematical history—the interpretation of the imaginary (or impossible) quantity of common algebra, and the Cartesian application of algebra to geometry. Sir W. R. Hamilton was led to his great invention by keeping geometrical applications constantly before him while he endeavoured to give a real significance to $\sqrt{-1}$. We will

therefore confine ourselves, so far as his predecessors are concerned, to attempts at interpretation which had geometrical applications in view.

One geometrical interpretation of the negative sign of algebra was early seen to be mere reversal of direction along a line. Thus, when an image is formed by a plane mirror, the distance of any point in it from the mirror is simply the negative of that of the corresponding point of the object. Or if motion in one direction along a line be treated as positive, motion in the opposite direction along the same line is negative. In the case of time, measured from the Christian era, this distinction is at once given, by the letters A.D. or B.C., prefixed to the date. And to find the position, in time, of one event relatively to another, we have only to subtract the date of the second (taking account of its sign) from that of the first. Thus¹ to find the interval between the battles of Marathon (490 B.C.) and Waterloo (A.D. 1815) we have

$$+1815 - (-490) = 2305 \text{ years.}$$

And it is obvious that the same process applies in all cases in which we deal with quantities which may be regarded as of one directed dimension only, such as distances along a line, rotations about an axis, &c. But it is essential to notice that this is by no means necessarily true of operators. To turn a line through a certain angle in a given plane, a certain operator is required; but when we wish to turn it through an equal negative angle we must not, in general, employ the negative of the former operator. For the negative of the operator which turns a line through a given angle in a given plane will in all cases produce the negative of the original result, which is not the result of the reverse operator, unless the angle involved be an odd multiple of a right angle. This is, of course, on the usual assumption that the sign of a product is changed when that of any one of its factors is changed,—which merely means that -1 is commutative with all other quantities.

John Wallis seems to have been the first to push this idea further. In his *Treatise of Algebra* (1685) he distinctly proposes to construct the imaginary roots of a quadratic equation by going out of the line on which the roots, if real, would have been constructed.

In 1804 the Abbé Buée (*Phil. Trans.*, 1806), apparently without any knowledge of Wallis's work, developed this idea so far as to make it useful in geometrical applications. He gave, in fact, the theory of what in Hamilton's system is called Composition of Vectors in one plane—i.e. the combination, by $+$ and $-$, of coplanar directed lines. His constructions are based on the idea that the imaginaries $\pm\sqrt{-1}$ represent a unit line, and its reverse, perpendicular to the line on which the real units ± 1 are measured. In this sense the imaginary expression $a + b\sqrt{-1}$ is constructed by measuring a length a along the fundamental line (for real quantities), and from its extremity a line of length b in some direction perpendicular to the fundamental line. But he did not attack the question of the representation of products or quotients of directed lines. The step he took is really nothing more than the kinematical principle of the composition of linear velocities, but expressed in terms of the algebraic imaginary.

In 1806 (the year of publication of Buée's paper) Jean Robert Argand published a pamphlet² in which precisely the same ideas are developed, but to a considerably greater extent. For an interpretation is assigned to the product of two directed lines in one plane, when each is expressed as the sum of a real and an imaginary part. This product is interpreted as another directed line, forming the fourth term of a proportion, of which the first

¹ Strictly speaking, this illustration of Tait's is in error by unity because in our calendar there is no year denominated zero. Thus the interval between June the first of i B.C. and June the first of 1 A.D. is one year, and not two years as the text implies. (A.M.C.A.)

² *Essai sur une manière de représenter les Quantités Imaginaires dans les Constructions Géométriques*. A second edition was published by J. Houël (Paris, 1874). There is added an important Appendix, consisting of the papers from Gergonne's *Annales* which are referred to in the text above. Almost nothing can, it seems, be learned of Argand's private life, except that in all probability he was born at Geneva in 1768.

term is the real (positive) unit-line, and the other two are the factor-lines. Argand's work remained unnoticed until the question was again raised in Gergonne's *Annales*, 1813, by J. F. Français. This writer stated that he had found the germ of his remarks among the papers of his deceased brother, and that they had come from Legendre, who had himself received them from some one unnamed. This led to a letter from Argand, in which he stated his communications with Legendre, and gave a *résumé* of the contents of his pamphlet. In a further communication to the *Annales*, Argand pushed on the applications of his theory. He has given by means of it a simple proof of the existence of n roots, and no more, in every rational algebraic equation of the n th order with real coefficients. About 1828 John Warren (1796-1852) in England, and C. V. Mourey in France, independently of one another and of Argand, reinvented these modes of interpretation; and still later, in the writings of Cauchy, Gauss and others, the properties of the expression $a + b\sqrt{-1}$ were developed into the immense and most important subject now called the *theory of complex numbers* (see NUMBER). From the more purely symbolical view it was developed by Peacock, De Morgan, &c., as *double algebra*.

Argand's method may be put, for reference, in the following form. The directed line whose length is a , and which makes an angle θ with the real (positive) unit line, is expressed by $a(\cos\theta + i\sin\theta)$, where i is regarded as $+\sqrt{-1}$. The sum of two such lines (formed by adding together the real and the imaginary parts of two such expressions) can, of course, be expressed as a third directed line—the diagonal of the parallelogram of which they are conterminous sides. The product, P , of two such lines is, as we have seen, given by

$$1: a(\cos\theta + i\sin\theta) :: a'(\cos\theta' + i\sin\theta'): P,$$

or $P = aa'\{\cos(\theta + \theta') + i\sin(\theta + \theta')\}$. Its length is, therefore, the product of the lengths of the factors, and its inclination to the real unit is the sum of those of the factors. If we write the expressions for the two lines in the form $A + Bi$, $A' + B'i$, the product is $AA' - BB' + i(AB' + BA')$; and the fact that the length of the product line is the product of those of the factors is seen in the form

$$(A^2 + B^2)(A'^2 + B'^2) = (AA' - BB')^2 + (AB' + BA')^2.$$

In the modern theory of complex numbers this is expressed by saying that the *Norm* of a product is equal to the product of the norms of the factors.

Argand's attempts to extend his method to space generally were fruitless. The reasons will be obvious later; but we mention them just now because they called forth from F. J. Servois (Gergonne's *Annales*, 1813) a very remarkable comment, in which was contained the only yet discovered trace of an anticipation of the method of Hamilton. Argand had been led to deny that such an expression as i^3 could be expressed in the form $A + Bi$,—although, as is well known, Euler showed that one of its values is a real quantity, the exponential function of $-\pi/2$. Servois says, with reference to the general representation of a directed line in space:—

"L'analogie semblerait exiger que le trinôme fût de la forme $p \cos \alpha + q \cos \beta + r \cos \gamma$: α, β, γ étant les angles d'une droite avec trois axes rectangulaires; et qu'on eût

$$(p \cos \alpha + q \cos \beta + r \cos \gamma)(p' \cos \alpha + q' \cos \beta + r' \cos \gamma) = \cos^2 \alpha + \cos^2 \beta + \cos^2 \gamma = 1.$$

Les valeurs de p, q, r, p', q', r' , qui satisfaiseraient à cette condition seraient *absurdes*; mais seraient-elles imaginaires, reductibles à la forme générale $A + B\sqrt{-1}$? Voilà une question d'analyse fort singulière que je soumetts à vos lumières. La simple proposition que je vous en fais suffit pour vous faire voir que je ne crois point que toute fonction analytique non réelle soit vraiment reductible à la forme $A + B\sqrt{-1}$."

As will be seen later, the fundamental i, j, k of quaternions, with their reciprocals, furnish a set of six quantities which satisfy the conditions imposed by Servois. And it is quite certain that they cannot be represented by ordinary imaginaries.

Something far more closely analogous to quaternions than anything in Argand's work ought to have been suggested by De Moivre's theorem (1730). Instead of regarding, as Buée and Argand had done, the expression $a(\cos\theta + i\sin\theta)$ as a directed line, let us suppose it to represent the operator which, when applied to any line in the plane in which θ is measured, turns it in that plane through the angle θ , and at the same time increases its length in the ratio $a : 1$. From the new point of view we see at once, as it were, why it is true that

$$(\cos\theta + i\sin\theta)^m = \cos m\theta + i\sin m\theta.$$

For this equation merely states that m turnings of a line through successive equal angles, in one plane, give the same result as a single turning through m times the common angle. To make this process applicable to any plane in space, it is clear that we must have a special value of i for each such plane. In other words, a unit line, drawn in any direction whatever, must have -1 for its square. In such a system there will be no line in space specially distinguished as the *real unit line*: all will be alike imaginary, or rather alike real. We may state, in passing, that every quaternion can be represented as $a(\cos \theta + \pi \sin \theta)$,—where a is a real number, θ a real angle, and π a directed unit line whose square is -1 . Hamilton took this grand step, but, as we have already said, without any help from the previous work of De Moivre. The course of his investigations is minutely described in the preface to his first great work (*Lectures on Quaternions*, 1853) on the subject. Hamilton, like most of the many inquirers who endeavoured to give a real interpretation to the imaginary of common algebra, found that at least two kinds, orders or ranks of quantities were necessary for the purpose. But, instead of dealing with points on a line, and then wandering out at right angles to it, as Buée and Argand had done, he chose to look on algebra as the science of “pure time,”¹ and to investigate the properties of “sets” of time-steps. In its essential nature a set is a linear function of any number of “distinct” units of the same species. Hence the simplest form of a set is a “couple”; and it was to the possible laws of combination of couples that Hamilton first directed his attention. It is obvious that the way in which the two separate time-steps are involved in the couple will determine these laws of combination. But Hamilton’s special object required that these laws should be such as to lead to certain assumed results; and he therefore commenced by assuming these, and from the assumption determined how the separate time-steps must be involved in the couple. It we use Roman letters for mere numbers, capitals for instants of time, Greek letters for time-steps, and a parenthesis to denote a couple, the laws assumed by Hamilton as the basis of a system were as follows:—

$$(B_1, B_2) - (A_1, A_2) = (B_1 - A_1, B_2 - A_2) = (a, \beta);$$

$$(a, b)(\alpha, \beta) = (a\alpha - b\beta, b\alpha + a\beta).^2$$

To show how we give, by such assumptions, a real interpretation to the ordinary algebraic imaginary, take the simple case $a=0$, $b=1$, and the second of the above formulae gives

$$(0, 1)(\alpha, \beta) = (-\beta, \alpha).$$

Multiply once more by the number-couple $(0, 1)$, and we have

$$(0, 1)(0, 1)(\alpha, \beta) = (0, 1)(-\beta, \alpha) = (-\alpha, -\beta) = (-1, 0)(\alpha, \beta) = -(\alpha, \beta).$$

Thus the number-couple $(0, 1)$, when twice applied to a step-couple, simply changes its sign. That we have here a perfectly real and intelligible interpretation of the ordinary algebraic imaginary is easily seen by an illustration, even if it be a somewhat extravagant one. Some Eastern potentate, possessed of absolute power, covets the vast possessions of his vizier and of his barber. He determines to rob them both (an operation which may be very satisfactorily expressed by -1); but, being a wag, he chooses his own way of doing it. He degrades his vizier to the office of barber, taking all his goods in the process; and makes the barber his vizier. Next day he repeats the operation. Each of the victims has been restored to his former rank, but the operator -1 has been applied to both.

Hamilton, still keeping prominently before him as his great object the invention of a method applicable to space of three dimensions, proceeded to study the properties of triplets of the form $x+iy+jz$, by which he proposed to represent the directed line in space whose projections on the co-ordinate axes are x, y, z . The composition of two such lines by the algebraic

addition of their several projections agreed with the assumption of Buée and Argand for the case of coplanar lines. But, assuming the distributive principle, the product of two lines appeared to give the expression

$$xx' - yy' - zz' + i(yx' + xy') + j(xz' + zx') + ij(yz' + zy').$$

For the square of j , like that of i , was assumed to be negative unity. But the interpretation of ij presented a difficulty—in fact the main difficulty of the whole investigation—and it is specially interesting to see how Hamilton attacked it. He saw that he could get a hint from the simpler case, already thoroughly discussed, provided the two factor lines were in one plane through the real unit line. This requires merely that

$$y : z :: y' : z' ; \text{ or } yz' - zy' = 0;$$

but then the product should be of the same form as the separate factors. Thus, in this special case, the term in ij ought to vanish. But the numerical factor appears to be $yz' + zy'$, while it is the quantity $yz' - zy'$ which really vanishes. Hence Hamilton was at first inclined to think that ij must be treated as nil. But he soon saw that “a less harsh supposition” would suit the simple case. For his speculations on sets had already familiarized him with the idea that multiplication might in certain cases not be commutative; so that, as the last term in the above product is made up of the two separate terms $ijyz'$ and $jizy'$, the term would vanish of itself when the factor-lines are coplanar provided $ij = -ji$, for it would then assume the form $ij(yz' - zy')$. He had now the following expression for the product of any two directed lines:—

$$xx' - yy' - zz' + i(yx' + xy') + j(xz' + zx') + ij(yz' - zy').$$

But his result had to be submitted to another test, the Law of the Norms. As soon as he found, by trial, that this law was satisfied, he took the final step. “This led me,” he says, “to conceive that perhaps, instead of seeking to *confine* ourselves to triplets, . . . we ought to regard these as only *imperfect forms* of Quaternions, . . . and that thus my old conception of sets might receive a new and useful application.” In a very short time he settled his fundamental assumptions. He had now three distinct space-units, i, j, k ; and the following conditions regulated their combination by multiplication:—

$$i^2 = j^2 = k^2 = -1, \quad ij = -ji = k, \quad jk = -kj = i, \quad ki = -ik = j.^3$$

And now the product of two quaternions could be at once expressed as a third quaternion, thus—

$$(a + ib + jc + kd)(a' + ib' + jc' + kd') = A + iB + jC + kD,$$

where

$$\begin{aligned} A &= aa' - bb' - cc' - dd', \\ B &= ab' + ba' + cd' - dc', \\ C &= ac' + ca' + db' - bd', \\ D &= ad' + da' + bc' - cb'. \end{aligned}$$

Hamilton at once found that the Law of the Norms holds,—not being aware that Euler had long before decomposed the product of two sums of four squares into this very set of four squares. And now a directed line in space came to be represented as $ix + jy + kz$, while the product of two lines is the quaternion

$$-(xx' + yy' + zz') + i(yz' - zy') + j(xz' - zx') + k(xy' - yx').$$

To any one acquainted, even to a slight extent, with the elements of Cartesian geometry of three dimensions, a glance at the extremely suggestive constituents of this expression shows how justly Hamilton was entitled to say: “When the conception . . . had been so far unfolded and fixed in my mind, I felt that the *new instrument for applying calculation to geometry*, for which I had so long sought, was now, at least in part, attained.” The date of this memorable discovery is October 16, 1843.

Suppose, for simplicity, the factor-lines to be each of unit length. Then x, y, z, x', y', z' express their direction-cosines. Also, if θ be the angle between them, and x'', y'', z'' the direction-cosines of a line perpendicular to each of them, we have $xx' + yy' + zz' = \cos \theta$, $yz' - zy' = x'' \sin \theta$, &c., so that the product of two unit lines is now expressed as $-\cos \theta + (ix'' + jy'' + kz'') \sin \theta$. Thus, when the factors

³ It will be easy to see that, instead of the last three of these, we may write the single one $ijk = -1$.

¹ *Theory of Conjugate Functions, or Algebraic Couples, with a Preliminary and Elementary Essay on Algebra as the Science of Pure Time*, read in 1833 and 1835, and published in *Trans. R. I. A.* xvii. ii. (1835).

² Compare these with the long-subsequent ideas of Grassmann.

are parallel, or $\theta=0$, the product, which is now the square of any (unit) line is -1 . And when the two factor lines are at right angles to one another, or $\theta=\pi/2$, the product is simply $ix'+jy'+kz'$, the unit line perpendicular to both. Hence, and in this lies the main element of the symmetry and simplicity of the quaternion calculus, all systems of three mutually rectangular unit lines in space have the same properties as the fundamental system i, j, k . In other words, if the system (considered as rigid) be made to turn about till the first factor coincides with i and the second with j , the product will coincide with k . This fundamental system, therefore, becomes unnecessary; and the quaternion method, in every case, takes its reference lines solely from the problem to which it is applied. It has therefore, as it were, a unique internal character of its own.

Hamilton, having gone thus far, proceeded to evolve these results from a characteristic train of a priori or metaphysical reasoning.

Let it be supposed that the product of two directed lines is something which has quantity; i.e. it may be halved, or doubled, for instance. Also let us assume (a) space to have the same properties in all directions, and make the convention (b) that to change the sign of any one factor changes the sign of a product. Then the product of two lines which have the same direction cannot be, even in part, a directed quantity. For, if the directed part have the same direction as the factors, (b) shows that it will be reversed by reversing either, and therefore will recover its original direction when both are reversed. But this would obviously be inconsistent with (a). If it be perpendicular to the factor lines, (a) shows that it must have simultaneously every such direction. Hence it must be a mere number.

Again, the product of two lines at right angles to one another cannot, even in part, be a number. For the reversal of either factor must, by (b), change its sign. But, if we look at the two factors in their new position by the light of (a), we see that the sign must not change. But there is nothing to prevent its being represented by a directed line if, as further applications of (a) and (b) show we must do, we take it perpendicular to each of the factor lines. Hamilton seems never to have been quite satisfied with the apparent heterogeneity of a quaternion, depending as it does on a numerical and a directed part. He indulged in a great deal of speculation as to the existence of an extra-spatial unit, which was to furnish the *raison d'être* of the numerical part, and render the quaternion homogeneous as well as linear. But for this we must refer to his own works.

Hamilton was not the only worker at the theory of sets. The year after the first publication of the quaternion method, there appeared a work of great originality, by Grassmann,¹ in which results closely analogous to some of those of Hamilton were given. In particular, two species of multiplication ("inner" and "outer") of directed lines in one plane were given. The results of these two kinds of multiplication correspond respectively to the numerical and the directed parts of Hamilton's quaternion product. But Grassmann distinctly states in his preface that he had not had leisure to extend his method to angles in space. Hamilton and Grassmann, while their earlier work had much in common, had very different objects in view. Hamilton had geometrical application as his main object; when he realized the quaternion system, he felt that his object was gained, and thenceforth confined himself to the development of his method. Grassmann's object seems to have been, all along, of a much more ambitious character, viz. to discover, if possible, a system or systems in which every conceivable mode of dealing with sets should be included. That he made very great advances towards the attainment of this object all will allow; that his method, even as completed in 1862, fully attains it is not so certain. But his claims, however great they may be, can in no way conflict with those of Hamilton, whose mode of multiplying couples (in which the "inner" and "outer" multiplication are essentially involved) was produced in 1833, and whose quaternion system was completed and published before Grassmann had elaborated for press even the rudimentary portions of his own system, in which the veritable difficulty of the whole subject, the application to angles in space, had not even been attacked. Grassmann made in 1854 a somewhat savage onslaught on Cauchy and De St Venant, the former of whom had invented, while the latter had exemplified in application, the system of "*clefs algébriques*," which is almost precisely

¹ *Die Ausdehnungslehre*, Leipzig, 1844; 2nd ed., vollständig und in strenger Form bearbeitet, Berlin, 1862. See also the collected works of Möbius, and those of Clifford, for a general explanation of Grassmann's method.

that of Grassmann. But it is to be observed that Grassmann, though he virtually accused Cauchy of plagiarism, does not appear to have preferred any such charge against Hamilton. He does not allude to Hamilton in the second edition of his work. But in 1877, in the *Mathematische Annalen*, xii., he gave a paper "On the Place of Quaternions in the *Ausdehnungslehre*," in which he condemns, as far as he can, the nomenclature and methods of Hamilton.

There are many other systems, based on various principles, which have been given for application to geometry of directed lines, but those which deal with products of lines are all of such complexity as to be practically useless in application. Others, such as the *Barycentrische Calcul* of Möbius, and the *Méthode des equipollences* of Bellavitis, give elegant modes of treating space problems, so long as we confine ourselves to projective geometry and matters of that order; but they are limited in their field, and therefore need not be discussed here. More general systems, having close analogies to quaternions, have been given since Hamilton's discovery was published. As instances we may take Goodwin's and O'Brien's papers in the *Cambridge Philosophical Transactions* for 1849. (See also ALGEBRA: *spectral kinds*.)

Relations to other Branches of Science.—The above narrative shows how close is the connexion between quaternions and the ordinary Cartesian space-geometry. Were this all, the gain by their introduction would consist mainly in a clearer insight into the mechanism of co-ordinate systems, rectangular or not—a very important addition to theory, but little advance so far as practical application is concerned. But, as yet, we have not taken advantage of the perfect symmetry of the method. When that is done, the full value of Hamilton's grand step becomes evident, and the gain is quite as extensive from the practical as from the theoretical point of view. Hamilton, in fact, remarks,² "I regard it as an inelegance and imperfection in this calculus, or rather in the state to which it has hitherto been unfolded, whenever it becomes, or seems to become, necessary to have recourse . . . to the resources of ordinary algebra, for the solution of equations in quaternions." This refers to the use of the x, y, z co-ordinates,—associated, of course, with i, j, k . But when, instead of the highly artificial expression $ix+jy+kz$, to denote a finite directed line, we employ a single letter, a (Hamilton uses the Greek alphabet for this purpose), and find that we are permitted to deal with it exactly as we should have dealt with the more complex expression, the immense gain is at least in part obvious. Any quaternion may now be expressed in numerous simple forms. Thus we may regard it as the sum of a number and a line, $a+a$, or as the product, $\beta\gamma$, or the quotient, $\delta\epsilon^{-1}$, of two directed lines, &c., while, in many cases, we may represent it, so far as it is required, by a single letter such as q, r , &c.

Perhaps to the student there is no part of elementary mathematics so repulsive as is spherical trigonometry. Also, everything relating to change of systems of axes, as for instance in the kinematics of a rigid system, where we have constantly to consider one set of rotations with regard to axes fixed in space, and another set with regard to axes fixed in the system, is a matter of troublesome complexity by the usual methods. But every quaternion formula is a proposition in spherical (sometimes degrading to plane) trigonometry, and has the full advantage of the symmetry of the method. And one of Hamilton's earliest advances in the study of his system (an advance independently made, only a few months later, by Arthur Cayley) was the interpretation of the singular operator $q(\)q^{-1}$, where q is a quaternion. Applied to any directed line, this operator at once turns it, conically, through a definite angle, about a definite axis. Thus rotation is now expressed in symbols at least as simply as it can be exhibited by means of a model. Had quaternions effected nothing more than this, they would still have inaugurated one of the most necessary, and apparently impracticable, of reforms.

The physical properties of a heterogeneous body (provided they vary continuously from point to point) are known to depend, in the neighbourhood of any one point of the body, on a quadric function of the co-ordinates with reference to that point. The

² *Lectures on Quaternions*, § 513.

same is true of physical quantities such as potential, temperature, &c., throughout small regions in which their variations are continuous; and also, without restriction of dimensions, of moments of inertia, &c. Hence, in addition to its geometrical applications to surfaces of the second order, the theory of quadric functions of position is of fundamental importance in physics. Here the symmetry points at once to the selection of the three principal axes as the directions for i, j, k ; and it would appear at first sight as if quaternions could not simplify, though they might improve in elegance, the solution of questions of this kind. But it is not so. Even in Hamilton's earlier work it was shown that all such questions were reducible to the solution of linear equations in quaternions; and he proved that this, in turn, depended on the determination of a certain operator, which could be represented for purposes of calculation by a single symbol. The method is essentially the same as that developed, under the name of "matrices," by Cayley in 1858; but it has the peculiar advantage of the simplicity which is the natural consequence of entire freedom from conventional reference lines.

Sufficient has already been said to show the close connexion between quaternions and the theory of numbers. But one most important connexion with modern physics must be pointed out. In the theory of surfaces, in hydrokinetics, heat-conduction, potentials, &c., we constantly meet with what is called

"Laplace's operator," viz. $\frac{d^2}{dx^2} + \frac{d^2}{dy^2} + \frac{d^2}{dz^2}$. We know that this

is an invariant; i.e. it is independent of the particular directions chosen for the rectangular co-ordinate axes. Here, then, is a case specially adapted to the isotropy of the quaternion system;

and Hamilton easily saw that the expression $i \frac{d}{dx} + j \frac{d}{dy} + k \frac{d}{dz}$

could be, like $ix+jy+kz$, effectively expressed by a single letter. He chose for this purpose ∇ . And we now see that the square of ∇ is the negative of Laplace's operator; while ∇ itself, when applied to any numerical quantity conceived as having a definite value at each point of space, gives the direction and the rate of most rapid change of that quantity. Thus, applied to a potential, it gives the direction and magnitude of the force; to a distribution of temperature in a conducting solid, it gives (when multiplied by the conductivity) the flux of heat, &c.

No better testimony to the value of the quaternion method could be desired than the constant use made of its notation by mathematicians like Clifford (in his *Kinematic*) and by physicists like Clerk-Maxwell (in his *Electricity and Magnetism*). Neither of these men professed to employ the calculus itself, but they recognized fully the extraordinary clearness of insight which is gained even by merely translating the unwieldy Cartesian expressions met with in hydrokinetics and in electrodynamics into the pregnant language of quaternions. (P. G. T.)

Supplementary Considerations.—There are three fairly well-marked stages of development in quaternions as a geometrical method. (1) Generation of the concept through imaginaries and development into a method applicable to Euclidean geometry. This was the work of Hamilton himself, and the above account (contributed to the 9th ed. of the *Ency. Brit.* by Professor P. G. Tait, who was Hamilton's pupil and after him the leading exponent of the subject) is a brief *résumé* of this first, and by far the most important and most difficult, of the three stages. (2) Physical applications. Tait himself may be regarded as the chief contributor to this stage. (3) Geometrical applications, different in kind from, though more or less allied to, those in connexion with which the method was originated. These last include (a) C. J. Joly's projective geometrical applications starting from the interpretation of the quaternion as a point-symbol;¹ these applications may be said to require no addition to the quaternion algebra; (b) W. K. Clifford's bi-quaternions and G. Combebiac's tri-quaternions, which require the addition of quasi-scalars, independent of one another and of true scalars, and analogous to true scalars. As an algebraic

¹ It appears from Joly's and Macfarlane's references that J. B. Shaw, in America, independently of Joly, has interpreted the quaternion as a point-symbol.

method quaternions have from the beginning received much attention from mathematicians. An attempt has recently been made under the name of multenions to systematize this algebra.

We select for description stage (3) above, as the most characteristic development of quaternions in recent years. For (3) (a) we are constrained to refer the reader to Joly's own *Manual of Quaternions* (1905).

The impulse of W. K. Clifford in his paper of 1873 ("Preliminary Sketch of Bi-Quaternions," *Mathematical Papers*, p. 181) seems to have come from Sir R. S. Ball's paper on the *Theory of Screws*, published in 1872. Clifford makes use of a quasi-scalar ω , commutative with quaternions, and such that if $p, q, \&c.$, are quaternions, when $p+\omega q = p'+\omega q'$, then necessarily $p=p', q=q'$. He considers two cases, viz. $\omega^2=1$ suitable for non-Euclidean space, and $\omega^2=0$ suitable for Euclidean space; we confine ourselves to the second, and will call the indicated bi-quaternion $p+\omega q$ an *octonion*. In octonions the analogue of Hamilton's vector is localized to the extent of being confined to an indefinitely long axis parallel to itself, and is called a *rotor*; if ρ is a rotor then $\omega\rho$ is parallel and equal to ρ , and, like Hamilton's vector, $\omega\rho$ is not localized; $\omega\rho$ is therefore called a vector, though it differs from Hamilton's vector in that the product of any two such vectors $\omega\rho$ and $\omega\sigma$ is zero because $\omega^2=0$. $\rho+\omega\sigma$ where ρ, σ are rotors (i.e. ρ is a rotor and $\omega\sigma$ a vector), is called a *motor*, and has the geometrical significance of Ball's wrench upon, or twist about, a screw. Clifford considers an octonion $p+\omega q$ as the quotient of two motors $\rho+\omega\sigma, \rho'+\omega\sigma'$. This is the basis of a method parallel throughout to the quaternion method; in the specification of rotors and motors it is independent of the origin which for these purposes the quaternion method, pure and simple, requires.

Combebiac is not content with getting rid of the origin in these limited circumstances. The fundamental geometrical conceptions are the point, line and plane. Lines and complexes thereof are sufficiently treated as rotors and motors, but points and planes cannot be so treated. He glances at Grassmann's methods, but is repelled because he is seeking a unifying principle, and he finds that Grassmann offers him not one but many principles. He arrives at the *tri-quaternion* as the suitable fundamental concept.

We believe that this tri-quaternion solution of the very interesting problem proposed by Combebiac is the best one. But the first thing that strikes one is that it seems unduly complicated. A point and a plane fix a line or axis, viz. that of the perpendicular from point to plane, and therefore a calculus of points and planes is *ipso facto* a calculus of lines also. To fix a weighted point and a weighted plane in Euclidean space we require 8 scalars, and not the 12 scalars of a tri-quaternion. We should expect some species of bi-quaternion to suffice. And this is the case. Let η, ω be two quasi-scalars such that $\eta^2=\eta, \omega\eta=\omega, \eta\omega=\omega^2=0$. Then the bi-quaternion $\eta q + \omega r$ suffices. The plane is of vector magnitude $\frac{1}{2}Vq$, its equation is $\frac{1}{2}Spq = Sr$, and its expression is the bi-quaternion $\eta Vq + \omega Sr$; the point is of scalar magnitude $\frac{1}{2}Sq$, and its position vector is β , where $\frac{1}{2}V\beta q = Vr$ (or what is the same, $\beta = [Vr + q.Vr.q^{-1}]/Sq$), and its expression is $\eta Sq + \omega Vr$. (Note that the $\frac{1}{2}$ here occurring is only required to ensure harmony with tri-quaternions of which our present bi-quaternions, as also octonions, are particular cases.) The point whose position vector is Vrq^{-1} is on the axis and may be called the centre of the bi-quaternion; it is the centre of a sphere of radius Srq^{-1} with reference to which the point and plane are in the proper quaternion sense polar reciprocals, that is, the position vector of the point relative to the centre is $Srq^{-1}.Vq/Sq$, and that of the foot of perpendicular from centre on plane is $Srq^{-1}.Sq/Vq$, the product being the (radius)², that is $(Srq^{-1})^2$. The axis of the member $xQ+x'Q'$ of the second-order complex Q, Q' (where $Q=\eta q+\omega r, Q'=\eta q'+\omega r'$ and x, x' are scalars) is parallel to a fixed plane and intersects a fixed transversal, viz. the line parallel to $q'q^{-1}$ which intersects the axes of Q and Q' ; the plane of the member contains a fixed line; the centre is on a fixed ellipse which

intersects the transversal; the axis is on a fixed ruled surface to which the plane of the ellipse is a tangent plane, the ellipse being the section of the ruled surface by the plane; the ruled surface is a cylindroid deformed by a simple shear parallel to the transversal. In the third-order complex the centre locus becomes a finite closed quartic surface, with three (one always real) intersecting nodal axes, every plane section of which is a trinodal quartic. The chief defect of the geometrical properties of these bi-quaternions is that the ordinary algebraic scalar finds no place among them, and in consequence Q^{-1} is meaningless.

Putting $1-\eta=\xi$ we get Combebiac's tri-quaternion under the form $Q = \xi p + \eta q + \omega r$. This has a reciprocal $Q^{-1} = \xi p^{-1} + \eta q^{-1} - \omega p^{-1} r q^{-1}$, and a conjugate KQ (such that $K[QQ'] = KQ'KQ$, $K[KQ] = Q$) given by $KQ = \xi Kq + \eta Kp + \omega Kr$; the product QQ' of Q and Q' is $\xi p p' + \eta q q' + \omega (p r' + r q')$; the quasi-vector $\frac{1}{2}(1-K)Q$ is Combebiac's linear element and may be regarded as a point on a line; the quasi-scalar (in a different sense from the rest of this article) $\frac{1}{2}(1+K)Q$ is Combebiac's scalar $(Sp + Sq) + \text{Combebiac's plane}$. Combebiac does not use K ; and in place of ξ, η he uses $\mu = \eta - \xi$, so that $\mu^2 = 1, \omega \mu = -\omega = \omega, \omega^2 = 0$. Combebiac's tri-quaternion may be regarded from many simplifying points of view. Thus, in place of his general tri-quaternion we might deal with products of an odd number of point-plane-scalars (of form $\mu q + \omega r$) which are themselves point-plane-scalars; and products of an even number which are octonions; the quotient of two point-plane-scalars would be an octonion, of two octonions an octonion, of an octonion by a point-plane-scalar or the inverse a point-plane-scalar. Again a unit point μ may be regarded as by multiplication changing (a) from octonion to point-plane-scalar, (b) from point-plane-scalar to octonion, (c) from plane-scalar to linear element, (d) from linear element to plane-scalar.

If $Q = \xi p + \eta q + \omega r$ and we put $Q = (1 + \frac{1}{2}\omega t)(\xi p + \eta q) \times (1 + \frac{1}{2}\omega t)^{-1}$ we find that the quaternion t must be $2f(r)/f(q-p)$, where $f(r) = r q - K p r$. The point $\rho = Vt$ may be called the centre of Q and the length St may be called the radius. If Q and Q' are commutative, that is, if $QQ' = Q'Q$, then Q and Q' have the same centre and the same radius. Thus $Q^{-1}, Q, Q^2, Q^3, \dots$ have a common centre and common radius. Q and KQ have a common centre and equal and opposite radii; that is, the t of KQ is the negative conjugate of that of Q . When $Su = 0, (1 + \frac{1}{2}\omega u) () (1 + \frac{1}{2}\omega u)^{-1}$ is an operator which shifts (without further change) the tri-quaternion operand an amount given by u in direction and distance.

BIBLIOGRAPHY.—In 1904 Alexander Macfarlane published a *Bibliography of Quaternions and allied systems of Mathematics* for the International Association for promoting the study of Quaternions and allied systems of Mathematics (Dublin University Press); the pamphlet contains 86 pages. In 1899 and 1901 Sir W. R. Hamilton's classical *Elements of Quaternions* of 1866 was republished under C. J. Joly's editorship, in two volumes (London). Joly adds valuable notes and thirteen important appendices. In 1890 the 3rd edition of P. G. Tait's *Elementary Treatise on Quaternions* appeared (Cambridge). In 1905 C. J. Joly published his *Manual of Quaternions* (London); the valuable contents of this are doubled by copious so-called examples; every earnest student should take these as part of the main treatise. The above three treatises may be regarded as the great storehouses; the handling of the subject is very different in the three. The following should also be mentioned: A. McAulay, *Octonions, a development of Clifford's Bi-quaternions* (Cambridge, 1898); G. Combebiac, *Calcul des tri-quaternions* (Paris, 1902); Don Francisco Pérez de Muñoz, *Introducción al estudio del cálculo de Cuaterniones y otras Álgebras especiales* (Madrid, 1905); A. McAulay, *Algebra after Hamilton, or Multenions* (Edinburgh, 1908). (A. MCA.)

QUATORZAIN (from Fr. *quatorze*, fourteen), the term used in English literature, as opposed to "sonnet," for a poem in fourteen rhymed iambic lines closing (as a sonnet strictly never does) with a couplet. The distinction was long neglected, because the English poets of the 16th century had failed to apprehend the true form of the sonnet, and called Petrarch's and other Italian poets' sonnets quatorzains, and their own incorrect quatorzains sonnets. Almost all the so-called sonnets of the Elizabethan cycles, including those of Shakespeare,

Sidney, Spenser and Daniel, are really quatorzains. They consist of three quatrains of alternate rhyme, not repeated in the successive quatrains, and the whole closes with a couplet. A more perfect example of the form could hardly be found than the following, published by Michael Drayton in 1602:—

Dear, why should you commend me to my rest,
When now the night doth summon all to sleep?
Methinks this time becometh lovers best;
Night was ordained together friends to keep.
How happy are all other living things
Which though the day conjoin by several flight,
The quiet evening yet together brings,
And each returns unto his love at night,
O thou that art so courteous unto all,
Why should'st thou, Night, abuse me only thus,
That every creature to his kind dost call,
And yet 'tis thou dost only sever us?
Well could I wish it would be ever day,
If, when night comes, you bid me go away.

Donne, and afterwards Milton, fought against the facility and incorrectness of this form of metre and adopted the Italian form of sonnet. During the 19th century, most poets of distinction prided themselves on following the strict Petrarchan model of the sonnet, and particularly in avoiding the final couplet. In his most mature period, however, Keats returned to the quatorzain, perhaps in emulation with Shakespeare; and some of his examples, such as "When I have fears," "Standing aloof in giant ignorance," and "Bright Star," are the most beautiful in modern literature. The "Fancy in Nubibus," written by S. T. Coleridge in 1819, also deserves notice as a quatorzain of peculiar beauty.

QUATRIN, sometimes spelt *Quartain* (from Fr. *quatre*, four), a piece of verse complete in four rhymed lines. The length or measure of the verse is immaterial, but they must be bound together by a rhyme-arrangement. This form has always been popular for use in the composition of epigrams, on account of its brevity and neatness, and may be considered as a modification of the Greek or Latin epigram at its concisest.

QUATREFAGES DE BRÉAU, JEAN LOUIS ARMAND DE (1810-1892), French naturalist, was born at Berthezènc, near Vallerangue (Gard), on the 10th of February 1810, the son of a Protestant farmer. He studied medicine at Strassburg, where he took the double degree of M.D. and D.Sc., one of his theses being a *Théorie d'un coup de canon* (November 1829); next year he published a book, *Sur les aérolithes*, and in 1832 a treatise on *L'Extraversion de la vessie*. Removing to Toulouse, he practised medicine for a short time, and contributed various memoirs to the local *Journal de médecine* and to the *Annales des sciences naturelles* (1834-36). But being unable to continue his researches in the provinces, he resigned the chair of zoology to which he had been appointed, and in 1839 settled in Paris, where he found in H. Milne-Edwards a patron and a friend. Elected professor of natural history at the Lycée Napoléon in 1850, he became a member of the Academy of Sciences in 1852, and in 1855 was called to the chair of anthropology and ethnography at the Musée d'histoire naturelle. Other distinctions followed rapidly, and continued to the end of his otherwise uneventful career, the more important being honorary member of the Royal Society of London (June 1879), member of the Institute and of the Académie de médecine, and commander of the Legion of Honour (1881). He died in Paris on the 12th of January 1892. He was an accurate observer and unwearied collector of zoological materials, gifted with remarkable descriptive power, and possessed of a clear, vigorous style, but somewhat deficient in deep philosophic insight. Hence his serious studies on the anatomical characters of the lower and higher organisms, man included, will retain their value, while many of his theories and generalizations, especially in the department of ethnology, are already forgotten.

The work of de Quatrefages ranged over the whole field of zoology from the annelids and other low organisms to the anthropoids and man. Of his numerous essays in scientific periodicals, the more important were: *Considérations sur les caractères zoologiques des rongeurs* (1840); "De l'organisation des animaux sans vertèbres des Côtes de la Manche" (*Ann. Sc. Nat.*, 1844); "Recherches sur

le système nerveux, l'embryogénie, les organes des sens, et la circulation des annélides" (Ibid., 1844-50); "Sur les affinités et les analogies des lombrics et des sangsues" (Ibid.); "Sur l'histoire naturelle des taretés" (Ibid., 1848-49). Then there is the vast series issued under the general title of "Études sur les types inférieurs de l'embranchement des annélés," and the results of several scientific expeditions to the Atlantic and Mediterranean coastlands, Italy and Sicily, forming a series of articles in the *Revue des deux mondes*, or embodied in the *Souvenirs d'un naturaliste* (2 vols., 1854). These were followed in quick succession by the *Physiologie comparée, métamorphoses de l'homme et des animaux* (1862); *Les Polynésiens et leurs migrations* (1866); *Histoire naturelle des annélés marins et de l'eau douce* (2 vols., 1866); *La Rochelle et ses environs* (1866); *Rapport sur les progrès de l'anthropologie* (1867); *Ch. Darwin et ses précurseurs français* (1870), a study of evolution in which the writer takes somewhat the same attitude as A. R. Wallace, combating the Darwinian doctrine in its application to man; *La Race prussienne* (1871); *Crania Ethnica*, jointly with Dr Hamy (2 vols., with 100 plates, 1875-82), a classical work based on French and foreign anthropological data, analogous to the *Crania Britannica* of Thurnam and Davis, and to S. G. Morton's *Crania Americana* and *Crania Aegyptiaca*; *L'Espèce humaine* (1877); *Nouvelles Études sur la distribution géographique des nègres* (1882); *Hommes fossiles et hommes sauvages* (1884); and *Histoire générale des races humaines* (2 vols., 1886-89), the first volume being introductory, while the second attempts a complete classification of mankind.

QUATREFOIL, in Gothic architecture, the piercing of tracery in a window or balustrade with small semicircular openings known as "foils"; the intersection of these foils is termed the cusp.

QUATREMÈRE, ÉTIENNE MARC (1782-1857), French Orientalist, the son of a Parisian merchant, was born in Paris on the 12th of July 1782. Employed in 1807 in the manuscript department of the imperial library, he passed to the chair of Greek in Rouen in 1809, entered the Academy of Inscriptions in 1815, taught Hebrew and Aramaic in the Collège de France from 1819, and finally in 1827 became professor of Persian in the School of Living Oriental Languages.

Quatremère's first work was *Recherches . . . sur la langue et la littérature de l'Égypte* (1808), showing that the language of ancient Egypt must be sought in Coptic. His translation of Makrizi's Arabic history of the Mameluke sultans (2 vols., 1837-41) shows his erudition at the best. He published among other works *Mémoires sur les Nabatéens* (1835); a translation of Rashid al-Din's *Hist. des Mongols de la Perse* (1836); *Mém. géog. et hist. sur l'Égypte* (1810); the text of Ibn Khaldūn's *Prolegomena*; and a vast number of useful memoirs in the *Journal asiatique*. His numerous reviews in the *Journal des savants* should also be mentioned. Quatremère made great lexicographic collections in Oriental languages, fragments of which appear in the notes to his various works. His MS. material for Syriac has been utilized in Payne Smith's *Thesaurus*; of the slips he collected for a projected Arabic, Persian and Turkish lexicon some account is given in the preface to Dozy, *Suppl. aux dict. arabes*. They are now in the Munich library.

A biographical notice by M. Barthélemy Sainte-Hilaire is prefixed to Quatremère's *Mélanges d'histoire et de philologie orientale* (1861).

QUAY, MATTHEW STANLEY (1833-1904), American political "boss," was born in Dillsburg, York county, Pennsylvania, on the 30th of September 1833. He graduated at Jefferson College (now Washington and Jefferson College) in 1850 and was admitted to the bar in 1854. He served in various capacities in the Civil War, and in 1865-1867 was a member of the state House of Representatives, becoming secretary of the commonwealth in 1873-1878 and again in 1879-1882, recorder of Philadelphia in 1878-1879, and state treasurer in 1886-1887. He was chairman of the Republican national executive campaign committee in 1888, and was a member of the United States Senate in 1887-1899 and again in 1901-1904. For nearly twenty years he dominated the government of Pennsylvania, and also played a very prominent part in national affairs. In 1899 he was brought to trial on a charge of misappropriating state funds, and, although he was acquitted, the feeling among the reform element in his own party was so bitter against him that the legislature was deadlocked and his re-election was postponed for two years. He died on the 28th of May 1904.

QUAY, a wharf or landing-place for the loading and unloading of water-borne cargo. The word, now pronounced like "key,"

takes the form of Fr. *quai*, older *cay* or *caye*, cf. Spanish *cayo*, a bar, barrier or reef. The earlier form in English is "kay," and it was so pronounced. "Key" was also earlier pronounced "kay," and the change in pronunciation in the one was followed also in the other. In spelling also the word was assimilated to "key," in the sense of a reef, or, especially, of the low range of reefs or islets on the coasts of Spanish America, e.g. on the coast of Florida, the chain of islets known as Florida Keys.

QUEBEC, a province of the Dominion of Canada, bounded S. by New Brunswick and the United States, W. by Ontario, N. by the district of Ungava, and E. by the gulf of St Lawrence and the strip of eastern Labrador which belongs to Newfoundland. If Ungava be considered as added to the province of Quebec, Hudson Strait is the northern boundary. The province includes the island of Anticosti, the Bird Islands and the Magdalen Islands, in the gulf of St Lawrence. The western boundary, separating Quebec from Ontario, extends through Point au Baudet on the river St Lawrence to Point Fortune on the Ottawa river, from which place the boundary follows the Ottawa to Lake Temiscaming. From the north end of this latter lake it runs due north to Hudson Bay. The province of Quebec thus extends from Blanc Sablon, a fishing harbour at the western end of the Strait of Belle Isle (which separates Canada from Newfoundland) in 59° 7' W. to Lake Temiscaming in 79° 40' W., a distance of about 1350 miles. The area of the province is 351,873 sq. m. The general direction of the province is north-east and south-west, following the course of its chief physical feature, the river St Lawrence. Speaking generally, it may be said that the province of Quebec comprises the hydrographical basin of the river St Lawrence as far west as the intersection of the parallel of 45° N. with the latter. The St Lawrence flows near the southern edge of its basin, only some 50,000 sq. m. of the area of the province lying south of the river.

The province of Quebec falls into three main physiographical divisions, viz.: (1) the Laurentian Highlands, (2) the Valley of the St Lawrence, and (3) the Notre Dame Mountains and the rolling country lying to the south-east of this range.

(1) The Laurentian Highlands are sometimes referred to as the "Laurentian Mountains," as they appear to constitute a mountain range when viewed from the gulf or the river St Lawrence. This portion of the province, however, is really a plateau having an elevation of 1000 to 2000 ft. above sea level, but this plateau north of latitude 55° falls away to lower levels toward Hudson Bay and Hudson Strait. Along the extreme eastern border of these Laurentian Highlands on the coast of Labrador, however, the country rises to much greater altitudes, forming an extremely rugged district which attains in places an elevation of 6000 ft. above sea-level. This plateau forms what is known as the Laurentian peneplain and is hummocky in character, the surface, however, being but slightly accentuated and the sky line seen from the higher points in the area being nearly level. It is densely wooded and everywhere abounds in lakes, great and small, lying either in basins etched in the rock surface by glacial action or else bounded by the irregularly distributed drift which more or less completely covers the surface of the underlying rocks. From these lakes issue very numerous streams tributary to the larger rivers. These lakes and rivers form so continuous a series of waterways that a traveller who knows their courses, and the portages connecting them, can traverse this immense tract of country in any direction by canoe. These streams also, cascading down from the elevated surface of the plateau to sea-level, afford immense water power, which is used to an increasing extent as the methods of long-distance electrical transmission of power become more and more perfect. These waters are, moreover, clear and pure, and the country is one in which malaria and similar diseases are unknown. Some of the rivers draining the Laurentian country run in very deep, high-walled valleys or fjords cut in the solid rock; a number of which, comparable in character although perhaps not in depth to those of Norway and Greenland, pass outward from the central portion of the peneplain north, east and south. As an example of such fjords in the province of Quebec, those occupied by the waters of the Hamilton, Mingan and Saguenay rivers may be cited as well as that, now partially silted up, which is occupied by Lake Temiscaming and the Mattawa river. The walls of solid gneiss between which the Saguenay flows are in places from 1500 to 1800 ft. in height, while the waters of the river in places reach a depth of 1400 ft.

This Laurentian country in the province of Quebec and its continuation into the adjacent province contain the chief timber

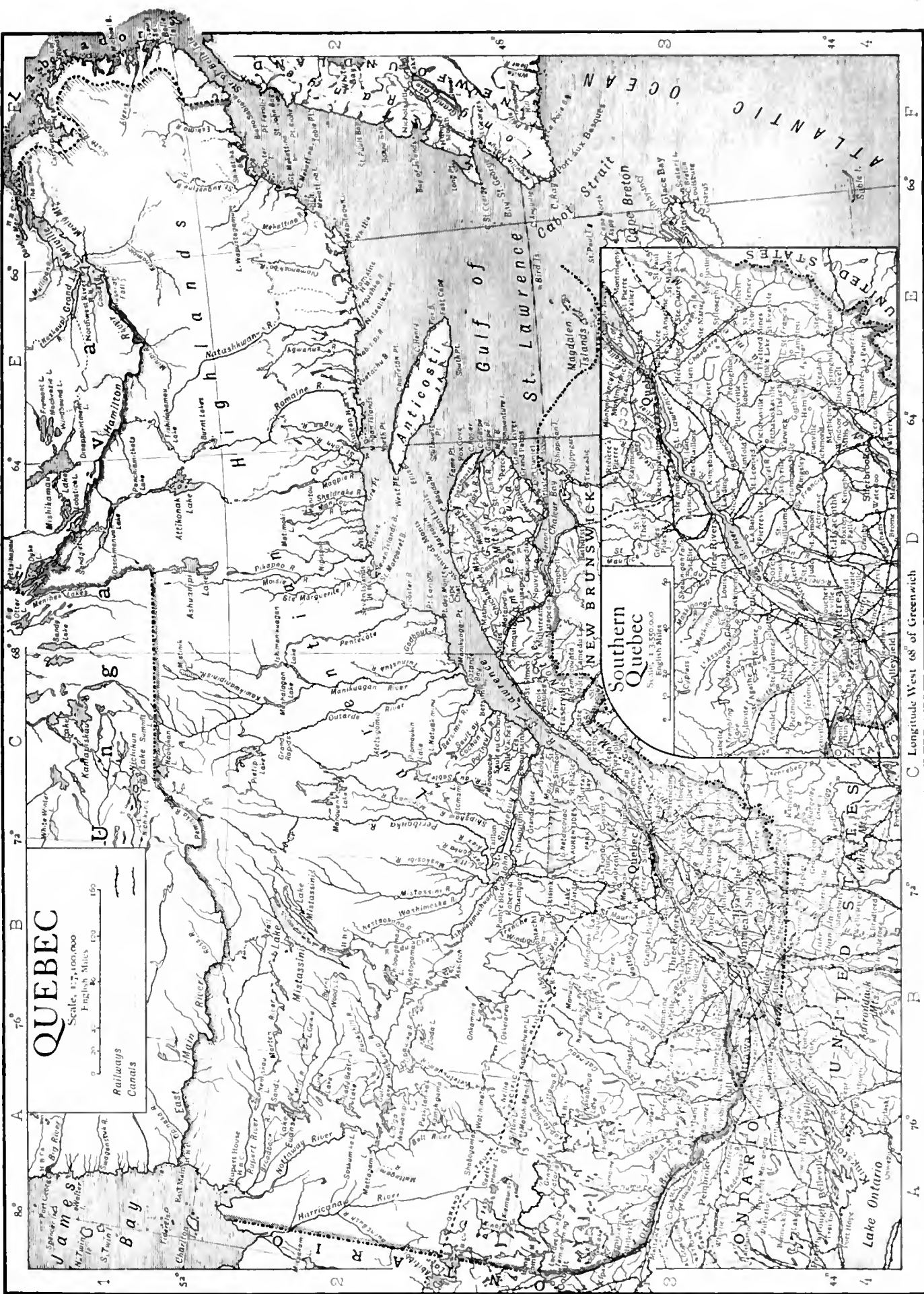

QUEBEC

Scale, 1:7,100,000
English Miles 129 150

Railways
Canals

Longitude West 68° of Greenwich

Latitude 44° 46° 68° 70° 72° 74° 76° 78° 80°

Emery Water Co.

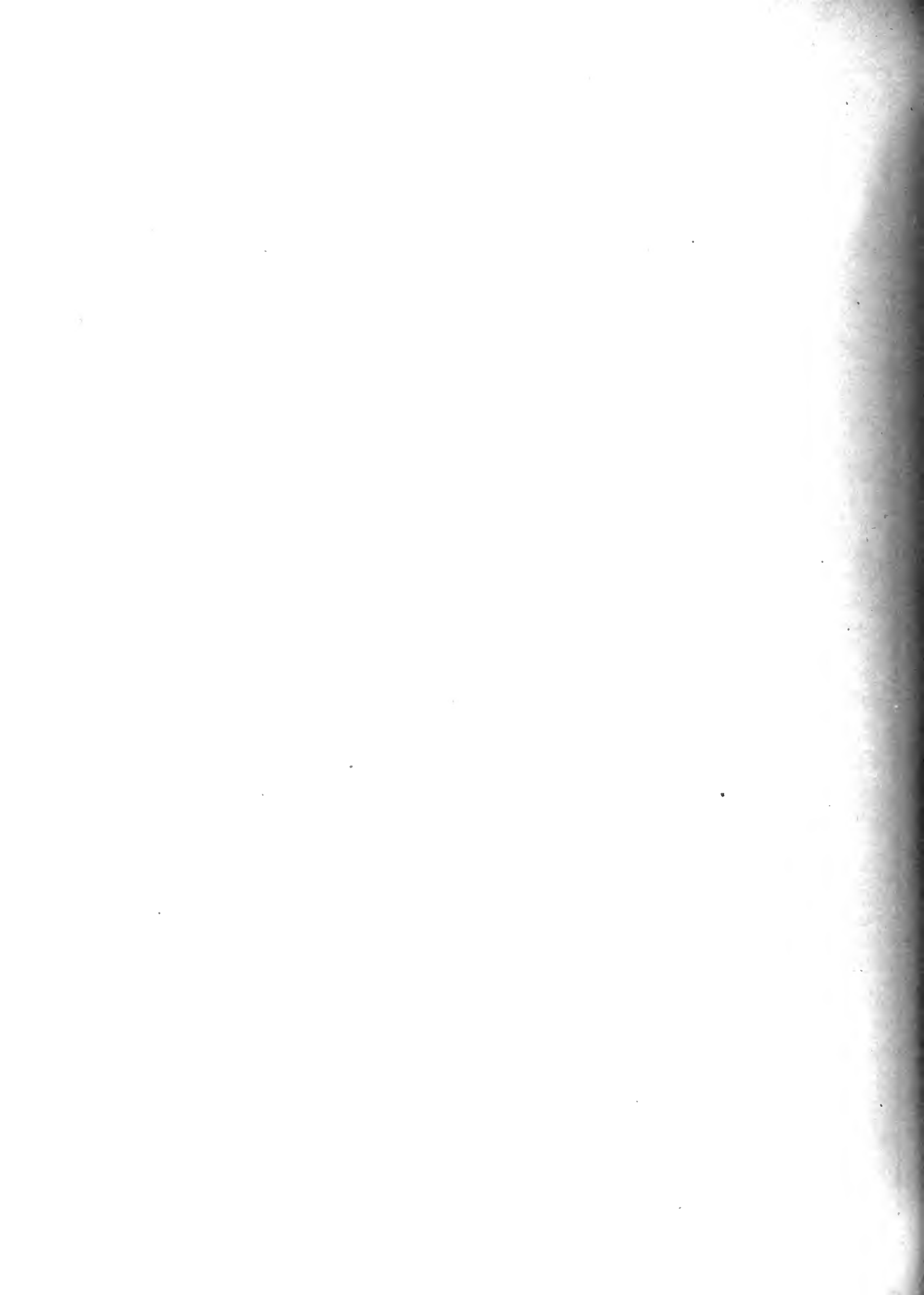

supplies of the Dominion, supplies which with a little husbanding on the part of the government could be made to afford a bountiful supply of timber for all future generations. The country also contains valuable mineral deposits, and is the great home of the fur-bearing animals of the Dominion. While, however, along the southern border it supports a considerable agricultural population, the Laurentian country cannot be considered as one which in respect to its agricultural capabilities can ever take rank with the southern portions of eastern Canada or with the great plains and British Columbia which lie to the west.

(2) That portion of the lowlands of the St Lawrence valley which belongs to the province of Quebec forms a wedge-shaped area extending along the river from a short distance below the city of Quebec to the western border of the province. It is throughout a practically level plain of very fertile land, on which are situated the chief towns and cities of the province, and on it also are settled the majority of the rural population. These lowlands are bounded on the north by the Laurentian plateau, and on the south by the Notre Dame Mountains, which physical features gradually converge, the latter mountains reaching the shore of the river St Lawrence a short distance to the east of the city of Quebec. The plain in this way gradually narrows on going to the north-east, and is finally closed off in that direction. It was a portion of this plain that was first occupied by the early French settlers. Much of its surface, as has been said, is absolutely level, and it nowhere exceeds an elevation of a few hundred feet. Its uniform expanse, however, is broken by a line of eight isolated hills composed of rocks of igneous origin, being a series of eroded remnants of ancient volcanoes which now rise abruptly from the plain and constitute the most striking features of the landscape. They are known as the Monteregian Hills and rise to elevations of 560 ft. to 1600 ft. above sea-level. From the summit of Mount Royal, at the foot of which lies the city of Montreal, all the other Monteregian Hills are plainly visible, and the margin of the Laurentian Highlands may be seen bounding the horizon some 30 m. to the north, while southward the Green Mountains, and the Adirondacks in the state of New York, are distinctly visible on a clear day.

(3) The Notre Dame Mountains and the Eastern Townships. The Appalachian Mountain range, passing out of the state of Vermont, where it is known as the Green Mountains, crosses into the province of Quebec between Lake Champlain and Lake Memphremagog, and becoming lower and less rugged continues in a north-easterly direction to a point about 30 m. south of the city of Quebec. Thence it pursues its course, following the general trend of the river St Lawrence at a varying distance from its southern margin, and reaches the latter river near Metis. From the border to this point the range is known as the Notre Dame Mountains. The highest peak in the Notre Dame Mountains is Sutton Mountain—3100 ft. Continuing on to the north-east it develops into the high land of the Gaspé Peninsula, of which the most elevated portion constitutes the Shickshock Mountains, the higher summits of which rise to elevations of 3000 to 4000 ft. above sea-level. The whole central area of the Gaspé Peninsula is a forest-clad wilderness.

To the south-east of the Notre Dame Mountains is an undulating country known as the "Eastern Townships." These hills, as mentioned above, are lower and less rugged than the Green Mountains, the general elevation of the country being from 500 to 1000 ft. above sea-level. There are a number of large and fine lakes in this district, among which may be mentioned lakes Metapedia, Temiscouata, Memphremagog, Aylmer, St Francis and Megantic.

In the belt of the Notre Dame Mountains the country is not in the strict sense of the term a mountainous one, but rather a rolling country containing much good farming and pasture land, while the Eastern Townships is a fine agricultural country, embracing some of the best farming and grazing land in the Dominion. This latter district was originally settled by Loyalists from the United States at the time of the revolt of the colonies, but is now being gradually occupied by French Canadians from the more northern portions of the province, the younger generation of English-speaking Canadians preferring to take up land and settle in Ontario or the western provinces of Manitoba, Saskatchewan, Alberta and British Columbia.

The whole country is exceptionally well watered and abounds in numerous large rivers, bays and lakes. The principal river is the St Lawrence, which flows through the entire length of the province. A short distance above Montreal it receives from the north-west the Ottawa, a large and beautiful river over 600 m. in length with many tributaries, among which the most important are the Gatineau, the Lièvre, the North, the Rouge and the Kinojevis. The St Lawrence is navigable for large ocean steamships as far as Montreal, beyond which place navigation is interrupted by rapids. The St Maurice rises in Lake Oskelaneo, flowing into the St Lawrence at Three Rivers, and is over 400 m. long. It has many tributaries, and drains an area of 21,000 sq. m. Twenty-four miles above Three

Rivers on the St Maurice are the falls of Shawinigan, 150 ft. high, from which a large amount of electrical power is obtained, a portion of which is used in the production of aluminium, while several thousand horse-power are transmitted to the city of Montreal. The Batiscan river enters the St Lawrence at Batiscan. The Jacques Cartier, the Ste Anne and the Montmorency are northern tributaries of the St Lawrence. The Montmorency is famous for its falls, situated about 8 m. from Quebec city, and 250 ft. high. These beautiful falls, however, have in recent years been greatly reduced in volume, the water being largely employed for the development of electricity, and also for the supply of power to a large cotton-mill in the vicinity. Near these falls is Haldimand House, once the residence of the duke of Kent, father of Queen Victoria. The Saguenay rises in Lake St John and discharges into the St Lawrence at Tadousac after a course of 100 m. On the south side of the St Lawrence is the Richelieu river, which rises in Lake Champlain and enters the St Lawrence at Sorel on Lake St Peter. Champlain sailed up this river in 1609. Other important streams are the St Francis, rising in Lake Memphremagog; the Chaudière, rising in Lake Megantic, with its beautiful falls 125 ft. high about 10 m. above Quebec; the Chateauguay, Yamaska, Etchemin, du Loup, Assomption and Bécancour. Among the largest lakes in the province are Lake St John, which has an area of 360 sq. m.; Lake Temiscaming, having an area of 126 sq. m.; Lake Matapedia, Lake Megantic and Lake Memphremagog.

The largest islands in the province of Quebec are: Anticosti, now used as a game preserve; Bonaventure, an important fishing station to the east of Gaspé; and the Magdalen Islands, situated in the gulf of St Lawrence about 50 m. north of Prince Edward Island.

Geology and Minerals.—Beginning with the oldest rocks, the more northern part of the province of Quebec is underlain by the Laurentian system of Sir William Logan. This includes a great series of very highly altered sediments, largely limestones, known as the Grenville series, which is penetrated by great intrusions of anorthosite, &c., and is invaded by and rests upon enormous batholiths of granite, which are sometimes referred to as the "Fundamental Gneiss." The Grenville series is best developed along the southern margin of the Laurentian Highlands between Three Rivers and the Georgian Bay. Two of the great anorthosite intrusions occur on the margin of the Laurentian country to the north of Montreal and about Lake St John. The Laurentian system is succeeded to the south by the Potsdam sandstone, probably equivalent to the Upper Cambrian of Britain. On this rests a dolomitic limestone—the Calciferous formation—and on this the great and highly fossiliferous limestones known as the Chazy and Trenton formations. These limestones afford the best building stone of the province, while the Potsdam sandstone is also frequently employed for building purposes. Above the Trenton is the Utica shale, rich in graptolites and trilobites. This is succeeded by the Hudson River group composed largely of sandstones and calcareous beds. These constitute the complete Ordovician succession. Upper Silurian and Devonian beds, the latter holding fossil plants and fishes, occur in the south-east portion of the province, while on the shore of Chaleur Bay these are succeeded by the lowest beds of the Carboniferous. No coal occurs in the province of Quebec. In the region of the Notre Dame Mountains and the Eastern Townships there are great intercalations of ancient volcanic rocks and many important mineral deposits. Among these may be mentioned gold, copper, asbestos and chromic iron ore; also serpentine, marble and roofing slates. The asbestos deposits are the most extensive and most productive in the world, the chief centre of asbestos mining being at Thetford Mines. A large part of the country, more especially on the lower levels, is covered with Pleistocene deposits of the so-called Glacial age. Till or boulder clay is usually at the base of these deposits. On this rests a finer stratified blue clay, in some places rich in fossil shells and known as the *Leda* clay. It affords a good material for the manufacture of bricks and tiles. Above the *Leda* clay are sands and gravels known as the *Saxicava* sand. This is also stratified and frequently contains an abundance of fossils. These stratified clays and sands are due to a re-sorting of the boulder clay by the action of water, and imply a submergence at the close of the Glacial period with a subsequent elevation. In certain alluvial deposits in the vicinity of the St Maurice river there occur deposits of bog iron ore which have been worked for many years.

Climate.—The climate of Quebec is variable. In the winter the cold is generally steady and the atmosphere clear and bracing. About Montreal snow lies on the ground from the end of November

until the following April, affording good sleighing for four months in the year. The inhabitants enjoy with zest and spirit all the outdoor sports common in the country, such as skating, curling, tobogganing, snowshoeing, ski-ing and sliding. The snowfall is heavy, and though the winds are often sharp they are not often raw or damp, nor is there any fog. The summer is warm and pleasant. The extreme heat is indicated at 90° F. The finest season of the year is the autumn, which lasts about six or eight weeks. The following is a table of temperatures as recorded by the meteorological stations at certain points in the province:—

Table showing Normal Temperature, Precipitation &c., at various Stations in the Province of Quebec.

	Latitude.	Longitude.	Altitude.	Average Temperature.			Precipitation.
				Summer.	Winter.	Year.	
			Feet.				Inches.
Anticosti, W. Pt. . .	49° 52'	64° 32'	15	55° 8'	14° 2'	35° 4'	35.89
Bird Islands . . .	47° 51'	61° 8'	125	55° 4'	20° 7'	38° 2'	28.76
Chicoutimi . . .	48° 25'	71° 5'	150	61° 7'	6° 1'	35° 3'	20.38
Quebec . . .	46° 48'	71° 13'	206	63° 6'	12° 3'	38° 4'	41.98
Brome . . .	45° 10'	72° 36'	678	63° 6'	14° 8'	40° 2'	35.35
Montreal . . .	45° 30'	73° 35'	187	66° 9'	15° 6'	42° 0'	39.24
Cape Magdalen . .	49° 16'	65° 20'	93	57° 8'	13° 9'	37° 1'	31.55

The normal percentage of bright sunshine at Montreal is 41 and at Quebec 39, a higher average than northern Europe. (F. D. A.)

Area and Population.—The boundaries of Quebec have been more than once enlarged since 1867. By the extension given to them in 1898, the province has an area of 351,873 sq. m., of which 341,756 sq. m. are land and 10,117 sq. m. are water. This estimate includes the islands of Orleans, Anticosti, and the Magdalen group, but not the gulf of St Lawrence or the territorial seas. In 1901 the population was 1,648,898, 992,667 being classed as rural and 656,231 as urban. Since 1891 the rural population has increased but little, but there has been a growth of about 11% in the population of the towns and cities. No province has taken so small a share in the development of the West. True to his ancestral instincts, the French-Canadian remains close to the place of his birth. If he emigrates, it is to the neighbouring cities of New England or to the eastern districts of the province of Ontario. On the other hand, in the rural parts of the province, the French are driving out the English-speaking settlers, especially in the south-western counties, settled by Loyalists at the close of the War of American Independence, and known as the Eastern Townships. Nearly 98% of the population are Canadian-born. Of these over 80% are of French descent; of the remainder about 7% are English, 7% Irish and 4% Scots. Save to the city of Montreal there is little immigration; but so prolific are the French that the population of the province increases as fast as that of the rest of the Dominion, in which to the natural increase is added a large immigration. The census gives the number of the average family as 5.36, but families with twelve and eighteen children are not uncommon. The English-speaking population is almost wholly confined to the towns, especially Montreal, in which city it controls the chief shipping and commercial interests. Of the original inhabitants about 8000 Indians remain, chiefly on reserves in the neighbourhood of Montreal and Quebec. Though quite peaceful, they are on the whole less civilized than those of eastern and southern Ontario. The capital is Quebec, with a population of about 70,000, which increases but slowly. The largest city is Montreal, the commercial and shipping centre of the Dominion, at the head of ocean steamship navigation, with a population of about 350,000. Other cities are Hull (practically a suburb of Ottawa; pop. in 1901, 13,993); Sherbrooke (11,765); Three Rivers (9981); Lévis (7783).

The French, Irish and Indians are almost entirely of the Roman Catholic faith; a majority of the English are Anglican, with some Methodists; the Scots are Presbyterian. The Roman Catholic Church enjoys extensive rights and privileges, and nowhere in the world is devotion to that faith more widespread or more unquestioning.

Administration.—As in all the provinces, the executive power is nominally vested in a lieutenant-governor, appointed for five years by the federal government, and assisted by an executive

council (or cabinet) who have seats in, and are responsible to, the local legislature. In reality the lieutenant-governor is a figure-head, and power is in the hands of the legislature, which consists of two houses, a Legislative Council, appointed nominally by the lieutenant-governor, really by the premier, and an Assembly, chosen by what is practically manhood suffrage. Either French or English may be used in addressing either house. The municipalities have large powers of local government, which are used with more or less efficiency, the predatory tendencies of the ward-politician being sometimes apparent, though of late years an improvement has been effected. The finances of the province are drawn from the same sources as those of Ontario (*q.v.*). Their administration has not been so economical as in the sister province, and there is a net provincial debt of over £4,000,000.

Education.—In primary education Quebec is still behind the other provinces, but great progress has been made since Federation; illiteracy is decreasing, and 80% of the population over five years of age can read and write. The Council of Public Instruction is divided into two committees of equal number, a Catholic and a Protestant, and all ratepayers are allowed to state whether they prefer their taxes to go to the Protestant or to the Catholic school. Both religious bodies have combined to carry out this system with very little friction or proselytizing. The Catholic schools are controlled by the clergy, the episcopate forming, *ex officio*, one-half of the Catholic section of the council. In the cities of Quebec and Montreal the schools are efficient and the teachers well paid; but in the rural districts the schools, especially those of the Catholics, are often inadequate, the buildings being poor, and the teachers receiving a mere pittance, in some cases less than £20 per annum. Over 95% of the teachers in the primary schools are women. The great majority of the schools are controlled by the council, but there are also a number of independent schools, primary and secondary, usually under religious control; of these the so-called "Collèges Classiques," supported by the Catholic Church, are the most important. The chief universities are McGill (undenominational), at Montreal (founded 1820), and Laval (Roman Catholic) (founded 1852), with its headquarters at Quebec, and with a large branch at Montreal. (See MONTREAL and QUEBEC CITY). There is also a small Anglican university, that of Bishop's College, Lennoxville (founded 1853), in connexion with which is Bishop's College school, on the model of the public schools of England. To McGill is affiliated a well-equipped Agricultural College established at Ste Anne de Bellevue by Sir William Macdonald (b. 1832), at a cost of over £2,000,000; and to Laval an Agricultural School at Oka, founded in 1893 by the Trappist Fathers. There are numerous normal and model schools, the most important being that of Ste Anne de Bellevue in connexion with Macdonald College.

Agriculture.—The French Canadian is a thrifty though somewhat unprogressive farmer, and loves the land with an even greater attachment than do the peasants of old France. Till recently his agriculture was of a very domestic character. He grew enough wheat to grind into flour, and enough oats to feed his horses; raised sheep whose wool his wife spun into rough cloth in the winter evenings; and even grew his own tobacco. Now his horizon is widening, and his imports and exports are increasing. The general climatic conditions are much the same as in Ontario, and the crops are similar. All the chief cereals are successfully cultivated, oats being the chief crop. The wise care of both federal and provincial governments has fostered the dairy farming of the province. In 1906 over £4,200,000 of cheese was produced, and over £5,200,000 of butter. Most of the butter is made in well-equipped creameries, in the number of which Quebec exceeds any other province; in exports of cheese she equals Ontario. In the production of fruit she ranks second to Ontario, Nova Scotia coming third. Perhaps the most typical Canadian industry, the making of syrup and sugar from the sap of the maple tree as it rises in the spring, centres in this province. Over two-thirds of the tobacco grown in the Dominion is raised in Quebec, about 10,000 acres being under cultivation. At first of a coarse character, it is improving in quality. The total annual value of the agricultural produce of the province is about £18,000,000, about half that of Ontario. Several agricultural and dairy schools are supported or assisted by the provincial government, and much good is being done by the Agricultural College at Ste Anne de Bellevue.

The province still possesses large areas of crown land, which is sold at a nominal price to *bona fide* settlers. In the northern part of the province new and fertile areas have been opened up by the Grand Trunk Pacific railway.

Forests.—Next to agriculture in importance are the various industries which depend on the products of the forest. Over 150,000 sq. m. of forest land are still uncleared, chiefly in the northern part of the province, though the best timber is said to grow south of the watershed. In the north, pine, spruce, and fir predominate, and, farther south, the maple; spruce, lime (linden, bass-wood,

Tilia Americana) and poplar, are used extensively in the making of paper pulp. The annual value of the wood cut in the province is about £4,000,000, rather less than that of Ontario, and not quite two-fifths that of the whole Dominion. An export duty is levied on all pulp wood exported.

Fur and Fish.—The value of the annual catch of fish is estimated at £450,000, most of which consists of the product of the cod and herring fisheries in the gulf of St Lawrence. From Isle Verte eastward almost all the settlers along the coast depend largely on the produce of this industry. It is carried on mainly in small boats, which put out in the morning and return at nightfall, few large vessels being employed. Throughout the province are numerous trout-streams, and many of the northern lakes are well supplied with trout, bass and pike. In Lake St John is caught the celebrated winninish, a land-locked salmon growing to the size of six or eight pounds, and well known to anglers. Moose, deer, bear and other animals provide excellent shooting in the Laurentian mountains, and in the wooded districts of the north.

Manufactures.—In manufactures Quebec ranks second among the provinces, Ontario coming first. The largest Canadian manufacturing town is Montreal, where most of the industries are controlled by the English-speaking minority. No other part of the Dominion is so rich in water power, which is provided to a limitless extent by the falls of the rivers Montmorenci, St Maurice (Shawinigan Falls), Ste Anne, the rapids on the St Lawrence and the Richelieu, and many others. Tanning, and the making of paper pulp and of furniture, prosper on account of the great forests of the province. The French-Canadian workman is hardy and intelligent, and Quebec may yet become the manufacturing centre of the Dominion, though as yet higher wages are paid in the American cities across the border, and thousands of French-speaking workmen are employed in the factories of Lowell and other American border towns.

Communications.—The rivers were long the chief roads, by water in summer, over the ice in winter; but though the St Lawrence is still the main artery of the province, the bulk of travel and of transport is now done by rail. The first railway in Canada was built in 1830 to carry stone from the wharves to aid in the construction of the citadel of Quebec. The first passenger railway was built in 1836, between Laprairie on the St Lawrence river and St John's on the Richelieu. There is now good railway communication between all the chief points, and branch lines are opening up new areas to settlement. While a few main roads are kept in good condition, those in the country parts are very indifferent.

BIBLIOGRAPHY.—The various departments of the provincial government publish annual reports on a great variety of subjects. The annual *Canada Year Book*, published by the Federal Government, gives much information in a tabular form. Interesting articles are contained in J. Castell Hopkins, *Canada; an Encyclopaedia* (Toronto, 1898-1900). The legal enactments in which the municipal system is embodied are found in the Revised Statutes of the province (Acts 4178-4640). On education and religion A. Siegfried, *Le Canada; les deux races* (1905; translated into English under the title of *The Race Question in Canada*, 1906), is well-informed and impartial. (W. L. G.)

QUEBEC, the capital of the Canadian province of the same name, situated on the north bank of the river St Lawrence, at its junction with the St Charles, about 300 m. from the gulf of St Lawrence and 180 m. by river N.E. of Montreal, in 71° 12' 19" 5 W. and 46° 48' 17" 3 N. The origin of the name Quebec has been much disputed, but it is apparently the Algonkian word for a strait, or sudden narrowing, the river at its junction with the St Charles being about 2500 yds. wide, but narrowing opposite Cape Diamond to 1314.

Quebec is built on the northern extremity of an elevated tableland which forms the left bank of the St Lawrence for a distance of 8 m. The highest part of the headland is Cape Diamond, 333 ft. above the level of the water, and crowned by the citadel; towards the St Lawrence it presents a bold and precipitous front, while on the landward side and towards the St Charles the declivity is more sloping and gradual. The harbour of Quebec is spacious and deep enough to hold the largest ships, and, with the Louise basin and Lorne graving-dock,—the latter on the opposite shore at Lévis,—forms one of the best harbours in America. It is usually open from the end of April to the middle of December, being closed by ice during the winter. The Louise basin consists of twin wet-docks and tidal harbours, with areas of 40 and 20 acres respectively, and a minimum depth of 26 ft. The harbour is protected towards the north-east by the island of Orleans, on either side of which there is an approach, though that to the north of the island is used only by small vessels. The spring tides rise and fall about 18 ft. Quebec is divided into

upper and lower town,—access to the former being obtained by steep and winding streets, by several flights of narrow steps, or by an elevator. Much of the lower town still recalls the older portions of such French provincial towns as Rouen or St Malo. The streets, with one or two exceptions, are narrow and irregular; but it remains the principal business quarter of the city. In the upper town, where the streets are wider and well paved, are the better class of dwelling-houses and public buildings, most of the churches, the public walks and gardens, and many of the retail shops. To the west are the suburbs of St John and St Roch. The latter occupies the lower plain, and is of some commercial importance; the former is on the same level as the upper town. South-west of St John stretch the historic Plains of Abraham. On this battleground stands a simple column 40 ft. high, marking the spot where General Wolfe fell. It was erected in 1849 by the British army in Canada, to replace a monument erected in 1832 by the governor-general, Lord Aylmer, which had been broken and defaced by ruffians. Till 1908 the Plains were also disfigured by a gaol and a rifle factory, but these have been removed, and the battleground converted into a public park. In the governor's garden, which overlooks the St Lawrence, is a monument 65 ft. in height, erected in 1828 under the administration of Lord Dalhousie, dedicated to the memory of Wolfe and Montcalm. An iron pillar surmounted by a bronze statue, the gift of Prince Jerome Napoleon, stands on the Ste Foy road, and was erected in 1855-60 to commemorate the achievements of the British and French troops in the brilliant but fruitless French victory of April 28, 1760. The chief point of interest in the upper town is Dufferin Terrace, a magnificent promenade overlooking the St Lawrence, 1400 ft. long and 200 ft. above the level of the river. Part of this terrace occupies the site of the old Château St Louis, which was destroyed by fire in 1834. At the eastern end of the terrace stands a fine statue of Champlain, erected in 1898. Near by, and conspicuous from the river, is the Hotel Frontenac, erected by the Canadian Pacific railway on the model of an old French château. Nothing remains of the fortifications erected under the French régime. The present walls and the citadel, which covers an area of about 40 acres, were built in 1823-32 at a cost of over £7,000,000. Since then, several of the gates have been destroyed, and others rebuilt, but in other respects the walls are practically intact, and, though obsolete as fortifications, add greatly to the picturesque beauty of the city. Between 1865 and 1871 three forts were built on the Lévis side of the river, but were neither manned nor armed. Quebec's natural position still makes it one of great military strength, though depending on naval control of the sea and of the gulf of St Lawrence.

Besides numerous Protestant churches, including a small Anglican cathedral, there is a Jewish synagogue; but the bulk of the population is Roman Catholic. The cathedral, founded in 1647, and enlarged at intervals, is a large but not very striking building in the upper town. It contains some good oil paintings and some much-prized relics, but is rather garish in its ornamentation. Of the numerous other churches, the most interesting is Notre Dame des Victoires, in the lower town, erected in 1688, and named in honour of the defeat of Phips in 1690 and the shipwreck of Sir Hovenden Walker in 1711. Laval University, which derives its name from François de Montmorency Laval, the first bishop of Quebec, who founded in 1663 a seminary for the training of priests, is under strict Roman Catholic control. It was instituted in 1852 by a royal charter from Queen Victoria and in 1876 received a charter from Pope Pius IX. The building is large and spacious, and the university includes faculties of theology, law, medicine and arts, a library of 125,000 volumes, a museum and a picture gallery. A large branch of the university has been established at Montreal, and has often, but vainly, sought permission to become an independent Catholic university. In connexion with Laval are the grand seminary founded in 1663, where theology is taught, and the minor seminary for literature and

philosophy. Other Roman Catholic institutions are Laval Normal and Model School, the Ursuline Convent, the Convent of the Good Shepherd and several nunneries. The convent and church of the Ursulines, founded in 1641, contains nearly 100 nuns and lay sisters, and nearly 600 pupils. It possesses some excellent paintings and a number of relics, among which is the skull of the French general, Montcalm. Morrin College, founded in 1859 by Dr Morrin, was for some years an efficient college in arts and theology, under Presbyterian control, but is now defunct. High schools for boys and girls and numerous academies are supported by the Protestants, under the dual system of education in the province. The Literary and Historical Society—the oldest chartered institution of the kind in Canada, founded by Lord Dalhousie in 1824—the Canadian Institute, the Geographical Society, the Young Men's Christian Association, the Advocates' Library and the Parliamentary Library, have valuable collections of books, the latter containing 70,000 volumes, and numerous MSS. chiefly relating to the early history of the province. The principal benevolent institutions are the marine hospital, the Hôtel Dieu, founded in 1639 by the duchess of Aiguillon, the general hospital (1693), the Jeffrey Hale Hospital, and the lunatic asylum at Beauport controlled by the Grey Nuns (sisters of charity). The provincial parliament buildings, erected in 1878-92, are situated in extensive grounds on Grande Allée. The main building is quadrangular in form, and is ornamented with numerous statues. The seat of the lieutenant-governor is at Spencerwood, a pleasant country estate outside the city. Other prominent buildings are the palace of the Roman Catholic Archbishop, which adjoins Laval University, the court house, post office, custom house, city hall (1890-95) and masonic hall. Quebec is well lighted with gas and electric light, and has a system of electric tramcars, a plentiful supply of power being obtained from the Montmorency Falls (268 ft. in height), 6 m. N.E. The climate is severe, but bracing, the mean temperature in winter being 10°, in summer 68°, and the mean of the year 39°. The main lines of the Grand Trunk, Canadian Pacific and Intercolonial railways are on the south bank of the St Lawrence, but branch lines connect the city with Montreal, and it is the headquarters of the Quebec and Lake St John, and various smaller railways. Steam ferries connect the city with Lévis on the opposite bank, but the project of a bridge, though of great importance to the city, has been in various ways delayed. In August 1907 the portion completed fell into the St Lawrence.

The city returns three members to the Canadian House of Commons, and three to the Provincial House of Assembly. It is governed by a mayor and council of aldermen, who hold office for two years, and are usually re-elected, one mayor having held office for eleven successive years. Quebec is the seat of a Roman Catholic archbishop and of an Anglican bishop. Economically, Quebec was long the chief port of Canada. A series of strikes almost ruined its export trade, and numerous severe fires, of which that of 1845 was the chief, also lessened its importance. For many years the export trade passed almost entirely to Montreal, but the increasing size of sea-going vessels makes navigation above Quebec more and more difficult, especially for fast passenger steamships, and for such vessels Quebec is again becoming the terminus. Quebec's staple export is timber, the greater portion of which comes from the Ottawa and St Maurice districts. Formerly the rafts floating down the river were collected in the coves which extend along both sides of the river, above the city, and were fastened by booms along the banks. Now much of the timber is sent by rail. On the right bank of the stream, not far from Quebec, are extensive sawmills. Deals and square timber form the bulk of the export, but some furniture is also sent, and an increasing quantity of wheat is shipped. The building of wooden ships was formerly one of the chief industries of Quebec. The principal manufactures are iron castings, machinery, cutlery, nails, leather, rifles, gunpowder, musical instruments, boots and shoes, paper, india-rubber goods, ropes, tobacco, steel. The population increases but slowly, having risen from

59,699 in 1871 to 68,840 in 1901; of these over 60,000 are French and Roman Catholic.

The first known white man to visit Quebec was Jacques Cartier, the French navigator, in 1535, who found on the site a large Indian village, called Stadacona. In July 1608 the present city was founded, and named by Champlain. Its growth was slow, and in 1629 it had but two permanently settled families, with a shifting population of monks, officials and fur traders. In that year it was captured by the English under Sir David Kirke (1597-1656; see H. Kirke, *The First English Conquest of Canada*, London, 1871, reprinted 1908), but in 1632 it was restored to the French by the treaty of St Germain-en-Laye. In 1663 the colony of New France was created a royal province, and Quebec became the capital. In 1690 Sir William Phips, governor of Massachusetts, attempted to reconquer it with a fleet and army fitted out by New England, but was defeated by the French governor, Frontenac. In 1711 a great British expedition sent against it under Sir Hovenden Walker was shipwrecked in the gulf of St Lawrence, and the French held possession till 1759 (see below), when it was captured by the British troops on the 18th of September, five days after the battle of the Plains of Abraham; it was finally ceded to Great Britain by the treaty of Paris in 1763. In 1775 the American generals Montgomery and Benedict Arnold attacked the city, but Montgomery was killed (December 31, 1775) and Arnold was compelled to retreat in the following spring.

In 1763-1841, in 1851-55, and in 1859-65 Quebec was the capital of Canada, and it is still its most historic and picturesque city.

See *Quebec under Two Flags*, by A. G. Doughty and N. E. Dionne (Quebec, 1903). *Canada, an Encyclopaedia*, by J. C. Hopkins (Toronto, 1898-1900), has a good account (vol. v. pp. 241-248). (W. L. G.)

Wolfe's Quebec Expedition, 1759.—Both in itself and also as the central incident of the British conquest of Canada, the taking of Quebec is one of the epics of modern military history. The American campaigns of the Seven Years' War, hitherto somewhat spasmodic, were, after Amherst's capture of Louisburg in 1758, co-ordinated and directed to a common end by that general, under whom James Wolfe, a young major-general of thirty-three years of age, was to command an expedition against Quebec from the lower St Lawrence, while Amherst himself led a force from New England by Lake Champlain on Montreal. Wolfe's column consisted of about 7000 troops, and was convoyed by a powerful fleet under Admiral Saunders. The expedition sailed 300 m. up the St Lawrence, disembarked on the Isle of Orleans and encamped facing the city. The defenders were commanded by Montcalm, a soldier whose character and abilities, like Wolfe's, need no comment here. The French were superior in numbers, though a considerable part of their force was irregular; but they had the defender's difficult task of being strong everywhere. Wolfe began the attack by seizing Point Lévis, and thence bombarding Quebec. This, however, affected the main defences of the upper city but little, and they were moreover protected from closer attack by the St Lawrence and the St Charles. The third side of the triangle was the "plains of Abraham," to which it was thought there was no approach from the river. After wasting some weeks, therefore, Wolfe decided to cross the St Lawrence 7 m. below Quebec and to fight his way to the city by the St Charles side. But Montcalm's fortified posts spread out from Quebec through Beauport as far as the Montmorency, and this formidable obstacle checked the English advance at the outset. No artifice could lure the defenders away, and at last Wolfe attacked the line of the Montmorency and was repulsed with heavy loss (July 31). Wolfe's fragile health gave way under the disappointment, and despondency set in in the English camp. But as soon as the young leader had recovered a little, he summoned his brigadiers and worked out a plan for attacking by the upper waters and the heights of Abraham. Access to the heights could be obtained, it was

found, by a tiny cove (Wolfe's cove), from which a steep footpath led to the summit. It was no place for artillery, and even for infantry the climb was long and exhausting, but the attempt was made. Considered as a way of taking Quebec, it was in the last degree a forlorn hope, but Wolfe, as a true soldier, felt the imperative necessity of preventing his opponent from sending reinforcements to the force opposing Amherst, and staked everything upon achieving this at least. "Happy if our efforts here," as he wrote, "can contribute to the success of His Majesty's arms in any other part of America." What with losses in action and by sickness, and detachments to guard the camps and batteries, only 3600 men could be spared for the attempt. These embarked on the warships on the evening of September 12, and sailed up stream. The watchful Montcalm sent a detachment to observe their movements, but the ships proceeded to a point well above the cove, luring the detachment out of the way. Then at 1 a.m. Wolfe, with half his force, dropped down stream in the boats of the squadron and landed. The path was guarded by a redoubt, but the light infantry which led the advance scarcely attempted to follow it, scrambling up the hillside wherever they could find a foothold. The garrison of the redoubt, startled by the unforeseen attack, abandoned the work, and by daylight Wolfe had assembled his 3600 men on the plains above the city. Montcalm meanwhile had been held in check by a demonstration of part of the fleet under Admiral Saunders on Beauport, but at last, realizing that the real attack was coming from the other flank, he hurried all the troops he could collect over the St Charles and drew them up on the plain, with their backs to the walls of the upper town. He took the offensive at once. He had plenty of militiamen and irregulars, and these rapidly drove the British light infantry on to their main body, which was threatened on both flanks. On so small a battlefield, the troops in Wolfe's line of battle quickly became aware that the enemy was attacking in superior force. But their leader steadied them by his personal example, and when the French came within close range one "perfect volley" from the whole line decided the battle. Then as the French stopped, with great gaps in their lines, Wolfe led on his men to complete the victory. He received two painful wounds and then a shot through the breast. His last order, one rare indeed in the annals of 18th-century fighting, was to send a force to the St Charles bridge to cut off the retreat of the French. Montcalm too was mortally wounded, and died next day. On the 18th of September Quebec surrendered.

QUEBEC ACT, the title usually given to a bill introduced into the House of Lords on May 2, 1774, entitled "An Act for making more Effectual Provision for the Government of the Province of Quebec, in North America." It passed the House of Lords on May 17, was discussed in the Commons from May 26 to June 13, and finally passed with some amendments. These were accepted by the Lords, in spite of the opposition of Lord Chatham, and the bill received the royal assent on June 22. The debates in the House of Commons are not found in the Parliamentary History, but were published separately by J. Wright in 1839. The speech of Lord Chatham is given in the *Chatham Correspondence* (iv. 351-353).

By this act the boundaries of the Canadian province of Quebec were extended so as to include much of the country between the Ohio and the Mississippi. The French inhabitants of the province were granted the liberty to profess "the religion of the Church of Rome"; the French civil law was established, though in criminal law the English code was introduced. Government was vested in a governor and council, a representative assembly not being granted till the Constitutional Act of 1791.

The granting of part of the Western territory to Quebec, and the recognition of the Roman Catholic religion, greatly angered the American colonies. On the other hand, it did much to keep the French Canadians from joining the Americans in the coming struggle. The act is still looked back to by the French in Canada as their great charter of liberty.

QUEDLINBURG, a town of Germany in the Prussian province of Saxony, situated on the Bode, near the N.W. base of the Harz Mountains, 12 miles S.E. by rail from Halberstadt on the line Magdeburg-Thale. Pop. (1905) 24,798, almost all Protestants. It consists of the old town, which is still partly surrounded by a turreted wall, the new town and four suburbs. On the west it is commanded by the castle, formerly the residence of the abbesses of Quedlinburg, connected with which is the interesting Schlosskirche, which was dedicated in 1129 and completely restored in 1862-82. The German king, Henry the Fowler, his wife Matilda, and Aurora, countess of Königsmark, the mistress of Augustus the Strong, are buried in the Schlosskirche. There are many interesting articles in the treasury. The Gothic town hall, a 14th-century building, restored and enlarged in 1900, contains a collection of antiquities, and near it stands a stone figure of Roland. The town also possesses a gymnasium founded in 1540 and now containing the abbey library and a municipal museum. It has a fine memorial of the war of 1870-71. Quedlinburg is famous for its nurseries and market gardens, and exports vegetable and flower seeds to all parts of Europe and America. Its chief manufactures are iron goods, machinery and cloth, and it has a trade in grain and cattle. Near the town is the church of St Wipertus, which dates from the 12th century, and has a crypt of the 10th century.

Quedlinburg was founded as a fortress by Henry the Fowler about 922, its early name being Quitlingen. Soon it became a favourite residence of the Saxon emperors and was the scene of several diets. It afterwards joined the Hanseatic League. The abbey of Quedlinburg was planned by Henry the Fowler, although its actual foundation is due to his son Otto the Great. It was a house for the daughters of noble Saxon families and was richly endowed, owning at one time a territory about 40 sq. m. in area. The abbesses, who were frequently members of the imperial house, the second of them being Otto's daughter Matilda, ranked among the princes of the empire, and had no ecclesiastical superior except the pope. The town at first strove vigorously to maintain its independence of them, and to this end invoked the aid of the bishop of Halberstadt. In 1477, however, the abbess Hedwig, aided by her brothers, Ernest and Albert of Saxony, compelled the bishop to withdraw, and for the next 200 years both town and abbey were under the protection of the elector of Saxony. In 1539 the townsmen accepted the reformed doctrines and the abbey was converted into a Protestant sisterhood. In 1697 the elector of Saxony sold his rights over Quedlinburg to the elector of Brandenburg for 240,000 thalers. The abbesses, however, retained certain rights of jurisdiction, and disputes between them and the Prussian government were frequent until the secularization of the abbey in 1803. The last abbess was Sophia Albertina (d. 1829), sister of King Charles XIII. of Sweden. After forming for a few years part of the kingdom of Westphalia, the abbey lands were incorporated with Prussia in 1815.

See the *Urkundenbuch der Stadt Quedlinburg*, edited by Janicke (Halle, 1873-82); Ranke and Kugler, *Beschreibung und Geschichte der Schlosskirche zu Quedlinburg* (Berlin, 1838); Lorenz, *All-Quedlinburg, 1485-1698* (Halle, 1900); and Huchs, *Führer durch Quedlinburg*. For the history of the abbey see Fritsch, *Geschichte des Reichsstifts und der Stadt Quedlinburg* (Quedlinburg, 1828).

QUEEN (O.E. *cwæn*, wife, related to "quean," O.E. *cwene*, a hussy; cf. Gr. *γυνή*: from root *gan-*, to produce; cf. *genus*, "kin," &c.), the title of the consort or wife of a king ("queen consort"), or of a woman who is herself the sovereign ruler of a state ("queen regnant"); the widow of a former reigning sovereign is a "queen dowager," and, when the mother of the reigning sovereign, a "queen mother."

For the position of the queen in English constitutional law see CONSORT, and for her household see HOUSEHOLD, ROYAL.

QUEEN ANNE'S BOUNTY, the name applied to a perpetual fund of first-fruits and tenths granted by a charter of Queen Anne, and confirmed by statute in 1703 (2 & 3 Anne, c. 11), for the augmentation of the livings of the poorer Anglican

clergy. First-fruits (*annates*) and tenths (*decimae*) formed originally part of the revenue paid by the clergy to the papal exchequer. The former consist of the first whole year's profit of all spiritual preferments, the latter of one-tenth of their annual profits after the first year. In accordance with the provisions of two acts (5 & 6 Anne, c. 24, and 6 Anne, c. 27) about 3900 poor livings under the annual value of £50 were discharged from first-fruits and tenths. The income derived from first-fruits and tenths was annexed to the revenue of the crown in 1535 (26 Hen. VIII. c. 3), and so continued until 1703. Since that date there has been a large mass of legislation dealing with Queen Anne's Bounty, the effect of which will be found set forth in a *Report of a Joint Select Committee on the Queen Anne's Bounty Board*, 1900. The governors consist of the archbishops and bishops, some of the principal officers of the government, and the chief legal and judicial authorities. The augmentation proceeds on the principle of assisting the smallest benefices first. All the cures not exceeding £10 per annum must have received £200 before the governors can proceed to assist those not exceeding £20 per annum. In order to encourage benefactions, the governors may give £200 to cures not exceeding £45 a year, where any person will give the same or a greater sum. The average income from first-fruits and tenths is a little more than £16,000 a year. In 1906 the trust funds in the hands of the governors amounted to £7,023,000. The grants in 1906 amounted to £28,607, the benefactions to £29,888. The accounts are laid annually before the king in council and the houses of parliament. The duties of the governors are not confined to the augmentation of benefices. They may in addition lend money for the repair and rebuilding of residences and for the execution of works required by the Ecclesiastical Dilapidations Acts, and may receive and apply compensation money in respect of the enfranchisement of copyholds on any benefice. The governors are unpaid; the treasurer and secretary receives a salary of £1000 a year. He is appointed by patent under the great seal, and holds office during the pleasure of the crown.

QUEENBOROUGH, a municipal borough in the Faversham parliamentary division of Kent, England, in the Isle of Sheppey, close to the junction of the Swale and Medway, 2 m. S. of Sheerness on the South-Eastern & Chatham railway. Pop. (1901) 1544. The prosperity of the town has been revived in modern times by the establishment by the railway company of a branch line from Sittingbourne in connexion with a service of mail and passenger steamers to Flushing (Holland), which run twice daily. The first copperas factory in England was established at Queenborough in 1579, by Matthias Falconer, of Brabant. In 1890 Portland cement works were built, and there is a large trade in timber. The town is governed by a mayor, 4 aldermen and 12 councillors. Area, 302 acres.

A fortress, called Sheppey Castle, is said to have existed from an early period for guarding the passage of the Swale river. Queenborough Castle was built about 1361 by Edward III., who named the town after Queen Philippa and made it a free borough, with a governing body of a mayor and two bailiffs. Charters were granted by subsequent sovereigns down to Charles I., who reincorporated the town under the title of the mayor, jurats, bailiffs and burgesses of Queenborough. The castle never had any military history, and having been seized by parliament together with the other royal possessions, and being considered of insufficient importance for repair, was demolished during the Commonwealth. The borough subsequently decreased in importance. The chief part of the population were employed in the oyster fishery. The town was first represented in parliament by two members in 1572; it lost its franchise by the Reform Act of 1832.

QUEEN CHARLOTTE ISLANDS, a compact group lying off the northern part of the coast of British Columbia, and forming part of that province of Canada. Geologically the group is composed mainly of Triassic, Cretaceous and Tertiary strata, penetrated by intrusive rocks. It occupies a position similar

to that held by Vancouver Island farther to the south, in regard to the mainland coast and its immediately adjacent islands, but is separated by a somewhat wider sea from the coast. It was named by Captain Dixon, who visited the islands in the "Queen Charlotte" in 1787. Although the islands promise to become important, because of their excellent harbours, the discovery of good seams of bituminous coal (beside the anthracite already known), their abundant timber of certain kinds and their prolific fisheries, but little settlement has taken place. The wonderfully productive halibut fisheries of Hecate Strait, which separates these islands from the mainland and its adjacent islands, have attracted the attention of fishing companies, and great quantities of this fish are taken regularly and shipped across the continent in cold storage. The natives, the Haida people, constitute with little doubt the finest race, and that most advanced in the arts, of the entire west coast of North America. They had developed in its highest degree the peculiar conventional art of the north-west coast Indians, which is found in decreasing importance among the Tsimshians on the west, the Tlingit on the north and the Kwakiutl and other tribes farther south on the Pacific coast. The carved totem posts of the Haida, standing in front of the heavily framed houses, or at a little distance from them, represent the coats of arms of the respective families of the tribes and generally exhibit designs treated in a bold and original manner, highly conventionalized but always recognizable in their purport by any one familiar with the distinctive marks of the animal forms portrayed. These primitive monuments are, however, rapidly falling to decay, and the people who erected them are becoming reduced in number and spirit. The native population of the islands is less than 700.

(F. D. A.)

QUEENSBERRY, EARLS, MARQUESSSES AND DUKES OF. The Queensberry title, one of the many with which the Scottish house of Douglas is associated, originated in the creation of Sir William Douglas (d. 1640) as earl of Queensberry in 1633. He was the eldest son of Sir James Douglas of Drumlanrig (d. 1616). His grandson William, the 3rd earl (1637-1695), was created marquess of Queensberry in 1682 and duke of Queensberry in 1684; he was lord justice general and an extraordinary lord of session. He was also lord high treasurer of Scotland, and served James II. as lord high commissioner to the parliament of 1685, but in 1686 he was deprived of his offices. He had assented to the accession of William and Mary and had again enjoyed the royal favour before he died on the 28th of March 1695. His son James Douglas, the 2nd duke (1662-1711), was born at Sanquhar Castle on the 18th of September 1662, and was educated at the university of Glasgow, afterwards spending some time in foreign travel. At the Revolution of 1688 he sided with William of Orange and was made a privy councillor; after he had become duke of Queensberry in 1695 he was appointed an extraordinary lord of session and keeper of the privy seal. He was the royal commissioner to the famous Scottish parliament which met in 1700, and just after the accession of Anne in 1702 he was made one of the secretaries of state for Scotland. In the latter part of 1703 he came under a temporary cloud through his connexion with the Jacobite intriguer, Simon Fraser, Lord Lovat, who had utilized Queensberry's jealousy of the duke of Atholl to obtain a commission from him to get evidence in France which would implicate Atholl. The plot was betrayed by Robert Ferguson, and Queensberry was deprived of his offices. However, in 1705 he was restored and in 1706 he was again commissioner to the Scottish parliament; in this capacity he showed great ability in carrying through the treaty for the union of the two crowns, which, chiefly owing to his influence and skill, was completed in 1707. For this he was very unpopular in Scotland, but he received a pension of £3000 a year. In 1708 he was created duke of Dover and marquess of Beverley, and he obtained a special remainder by which his titles were to pass to his second surviving son Charles, and not to his eldest son James, who was an idiot. In February 1709 he was appointed third secretary of state, and he died on the 6th of July 1711.

Charles Douglas, the 3rd duke (1698-1778), who had been created earl of Solway in 1706, was lord justice general from 1763 until his death in October 1778. In 1720 he married Catherine, daughter of Henry Hyde, 4th earl of Clarendon; this lady, a famous beauty, although very eccentric, was the friend of many of the wits and writers of her day, notably of Gay, Swift and Walpole. She died on the 17th of July 1777. Their two sons predeceased the duke, and when he died his British titles, including the dukedom of Dover, became extinct, but the Scottish titles passed to his cousin, William, 3rd earl of March (1724-1810).

This William Douglas, who now became the 4th duke of Queensberry, is best known by his soubriquet of "Old Q." On the turf he was one of the most prominent figures of his time, and his escapades and extravagances were notorious. From 1766 to 1776 he was vice-admiral of Scotland, and in 1760 he was made a lord of the bedchamber by George III.; but later he was an associate of the prince of Wales, being removed from his office in the royal household in 1789. A generous patron of the stage and of art, he was to the end of his life a "noble sportsman" of the dissolute type, and his degeneracy was the theme both of Wordsworth and of Burns. He died unmarried, but not without children, in London on the 23rd of December 1810. The dukedom of Queensberry and some of his other titles, together with his fine seat Drumlanrig Castle, now passed to Henry Scott, 3rd duke of Buccleuch, in whose family they still remain; but the marquessate of Queensberry descended to Sir Charles Douglas (1777-1837), the representative of another branch of the Douglas family, who became the 5th marquess.

John Sholto Douglas, 8th marquess of Queensberry (1844-1900), son of Archibald William, the 7th marquess (1818-1858), became a well-known patron of sport and particularly of pugilism. He helped to found the Amateur Athletic Club in 1860, and the new rules for prize-fighting, drawn up in 1867, were called after him the "Queensberry Rules." He married the daughter of Alfred Montgomery, and was succeeded by his son, Percy Sholto, 9th marquess (b. 1868).

QUEENSCLIFF, a town of Grant county, Victoria, Australia, 68 m. by land and 32 by sea S.W. by S. of Melbourne. Pop. (1901) 2025. It lies on Shortlands Bluff, a small peninsula connected with the mainland by the Narrows, a contracted strip of land some 400 yds. broad. Queenscliff is a favourite watering-place, having a fine pier and excellent and safe sea-bathing. It is also a pilot station; and the quarantine station for vessels entering Port Phillip is near the town.

QUEENS'S COUNTY, a county of Ireland, in the province of Leinster, bounded N.W. and N. by King's County, E. by Kildare, S. by Carlow and Kilkenny, and W. by Tipperary; area, 424,723 acres, or about 664 sq. m. The surface is for the most part level or gently undulating, but in the north-west rises into the elevations of the Slieve Bloom Mountains, the highest summit being Arderin, 1733 ft. In the central part of the county there is a large extent of bog. The south-east portion is included in the Leinster coalfield. Nearly the whole of the county is drained either by the Barrow, which has its source in the Slieve Bloom Mountains, and forms at various points the boundary with King's County, Kildare and Carlow, or by the Nore, which enters the county from Tipperary near Borris-in-Ossory, and flows east and then south till it reaches Kilkenny. The lakes are few and small, the largest being Lough Anaghmore on the north-western boundary. The Grand Canal enters the county at Portarlinton, and runs southwards to the Barrow in Kildare, a branch passing westwards 12 miles to Mountmellick.

The limestone plain prevails in this county, but the high coalfield, shared with Kilkenny and Carlow, rises from it in the south; while the Slieve Bloom Mountains, a round-backed Old Red Sandstone mass with Silurian inliers, dominate the lowland west of Maryborough. The limestone itself produces a range of hills near Stradbally, on which the fortress of Dunamase stands conspicuously. Esker-gravels provide sandy soils

in many places. Clay-ironstone was formerly raised in connexion with the anthracite from the coalfield.

The climate is dry and healthy. Originally a great extent of the surface was occupied with bog, but by draining much of it has been converted into good land. For the most part it is very fertile except in the hilly districts towards the north, and there is some remarkably rich land in the south-east. The acreage under pasture is not quite twice that of tillage. Dairy-farming is extensively practised. Agriculture forms the chief occupation, but the manufacture of woollen and cotton goods is carried on to a small extent. The main line of the Great Southern & Western railway traverses the county from N.E. to S.W. by way of Portarlinton and Maryborough; from the latter town branches run N. to Mountmellick and S. to Waterford, and from Ballybrophy a line runs W. to Birr (Parsonstown) and to Limerick.

The population (63,855 in 1801; 57,417 in 1901) decreases in excess of the average of the Irish counties, and emigration is considerable. Of the total about 88% are Roman Catholic, and almost the whole is rural. Maryborough (the county town, pop. 2957), Mountmellick (2407) and Mountrath (1304), with Portarlinton (1943, partly in King's County), are the principal towns. The county is divided into eleven baronies. Ecclesiastically it is in the Protestant dioceses of Dublin, Killaloe and Ossory, and in the Roman Catholic dioceses of Kildare and Leighlin, Ossory and Killaloe. Assizes are held at Maryborough, and quarter sessions at Abbeyleix, Borris-in-Ossory, Graigue (a suburb of Carlow), Maryborough, Mountmellick and Stradbally. The county is divided into the Leix and Ossory parliamentary divisions. To the Irish parliament two members were returned for the county and two each for the boroughs of Ballinakill, Maryborough and Portarlinton.

The territory now included in Queen's County covered the districts of Leix, Slewmary, Irry and part of Glenmaliry, until in 1556 it was made shire ground under the name of Queen's County, in honour of Queen Mary, the place chosen for the county town being named Maryborough. Three miles south of Stradbally is Dun of Clopook, an ancient dun or fort occupying the whole extent of the hill. Aghaboe, where there are the ruins of the abbey, was formerly the seat of the bishopric of Ossory. There are no remains of the abbey of Timahoe founded by St Mochua in the 6th century, but in the neighbourhood there is a fine round tower, 96 ft. high. Abbeyleix, a small market town south of Maryborough, had a famous Cistercian foundation of the 12th century. The church of Killeslin, in the S.E. of the county, exhibits fine carving of the Norman period. Among the principal old castles are the ruined fortress of the O'Mores occupying the precipitous rock of Dunamase, 3 m. E. of Maryborough, Borris-in-Ossory on the Nore, and Lea Castle on the Barrow, near Portarlinton, erected by the Fitzgeralds about 1260, burnt by Edward Bruce in 1315, again rebuilt, and in 1650 laid in ruins by the soldiers of Cromwell.

QUEENSFERRY, a royal and police burgh of Linlithgowshire, Scotland. Pop. (1901) 1850. It is situated on the S. side of the Firth of Forth, 9 m. by road N.W. of Edinburgh and about 1 m. from Dalmeny station on the North British railway, and is sometimes called South Queensferry, to distinguish it from the Queensferry on the opposite shore. Of old it was the ferry giving access to Dunfermline and other places on the north side of the firth, its use in this respect by Margaret, the queen of Malcolm Canmore, originating its name; just as Port Edgar, $\frac{1}{2}$ m. W., was named after her brother, Edgar Atheling. The Hawes Inn, which figures in Scott's *Antiquary*, was the terminus of the run from Edinburgh in the coaching days. Queensferry became a burgh of royalty in 1363, a royal burgh in 1639 and a police burgh in 1882, and belongs to the Stirling district group of parliamentary burghs (with Stirling, Culross, Dunfermline and Inverkeithing). The principal structures include, besides the small parish church of Dalmeny (the best example of pure Norman in Scotland), the Countess of Rosebery Memorial Hall (erected in 1893 by the earl of Rosebery), a library and reading-room, and a public

hall which also does duty as a town hall. A Carmelite friary was converted into an Episcopal chapel in 1890. There is a large oil-works in the parish. Dalmeny House, the seat of the earl of Rosebery, lies in beautifully wooded grounds about 2 m. E. of the ferry. In the park, on the seashore facing Drum Sands, stands Barnbogle Castle, a building of unknown age which became the seat of the Mowbrays in the 12th century. After passing into the hands of the earls of Haddington, it was purchased in 1662 by Sir Archibald Primrose, an ancestor of the earl of Rosebery. The castle was thoroughly restored in 1880. Dundas Castle, $1\frac{1}{2}$ m. S. of Queensferry, was a seat of the Dundases from 1124 to 1875, was besieged in 1449, received a visit from Cromwell in 1651 and was partly rebuilt about 1850. Hopetoun House, nearly 3 m. W. of the ferry, was begun about 1696 from the plans of Sir William Bruce of Kinross and completed by Robert Adam. It is the seat of the marquess of Linlithgow. Abercorn, a little to the west, gave the title of duke to a branch of the Hamiltons. It was the site of an ancient monastery, and from 681 to 685 the see of the earliest bishopric in Scotland.

QUEENSLAND, a state of the Australian commonwealth, occupying the whole of the north-eastern portion of the Australian continent, and comprising also the islands in Torres Strait. (For map, see AUSTRALIA.) It lies between 10° and 29° S., and is bounded on the N. by Torres Strait and the Gulf of Carpentaria, on the W. by South Australia and the Northern Territory, on the S. by New South Wales and on the E. by the Pacific Ocean. It has an area of 668,497 sq. m., a coastline of 3000, is 1250 m. long and 950 m. wide at its widest part.

With so extensive a seaboard Queensland is well favoured with ports on the Pacific side. Moreton Bay receives the Brisbane river, on whose banks Brisbane, the capital, stands. Maryborough port is on the Mary, which flows into Wide Bay; Bundaberg, on the Burnett; Gladstone, on Port Curtis; Rockhampton, up the Fitzroy (Keppel Bay); Mackay, on the Pioneer; Bowen, on Port Denison; Townsville, on Cleveland Bay. Cairns and Port Douglas are near Trinity Bay; Cardwell is on Rockingham Bay; Cooktown, on the Endeavour; Thursday Island port, near Cape York; and Normanton and Burketown near the Gulf of Carpentaria. The quiet Inner Passage, between the shore of the Great Barrier Reef, 1200 m. long, favours the north-eastern Queensland ports. Brisbane was founded in 1826, but colonization was restricted until 1842, when the Moreton Bay district of New South Wales was thrown open to settlers. It was named "Queensland" on its separation from the mother colony in 1859. A broad plateau, from 2000 to 5000 ft. in height, extends from north to south, at from 20 to 100 m. from the coast, forming the Main Range. The Coast Range is less elevated. A plateau goes westward from the Great Dividing Range, throwing most of its waters northward to the gulf. The Main Range sends numerous but short streams to the Pacific, and a few long ones south-westward, lost in earth or shallow lakes, unless feeding the river Darling. Going northward, the leading rivers, in order, are the Logan, Brisbane, Mary, Burnett, Fitzroy, Burdekin, Herbert, Johnstone and Endeavour. The Fitzroy receives the Mackenzie and Dawson; the Burdekin is supplied by the Cape, Belyando and Suttor. The chief gulf streams are the Mitchell, Flinders, Leichhardt and Albert. The great dry western plains have the Barcoo, Diamantina, Georgina, Warrego, Maranoa and Condamine. (T. A. C.)

Geology.—Queensland consists geologically of three areas. The eastern division of the state, including all the Cape York Peninsula and the mountainous areas behind the coast, is occupied by the Queensland Highlands, which are built up of a foundation of Archean and contorted Lower Palaeozoic rocks, upon which rest some sheets of comparatively horizontal Upper Palaeozoic and Mesozoic rocks. The rocks of the Highlands sink to the west below the Western Plains, which consist in the main of a sheet of Cretaceous clays, capped by isolated ridges and peaks of Desert Sandstone. In the far west the plains end against the foot of an Archean tableland, which is the north-eastern projection of the Western Plateau of Australia.

The oldest rocks in Queensland are gneisses and schists, which

appear to underlie the whole of the state. They were originally regarded as metamorphosed Silurian rocks, which had been converted into gneiss, mica-schists and hornblende-schists. Their Silurian age was affirmed owing to their lithological resemblance to rocks in Victoria, which were then regarded as Silurian, but have since been shown to be Archean. The gneisses and schists occupy the Barkly Tableland, the Cloncurry Goldfield and the rocks of the Mackinlay district in the west of the state. The second chief Archean area is around Charters Towers and the Cape Goldfield; it includes quartzites, conglomerates and slates, striking from north-west to south-east. The third Archean area occupies the Gilbert, Woolgar and Etheridge Goldfields, and is composed of schists trending from west to east, and with dikes of diorite and quartz-porphry. Smaller Archean outcrops occur south of Bowen in the Clarke Range and on the Peak Downs. To the Archean series doubtless belong some of the many granitic massifs, including those of Charters Towers, Ravenswood and Croydon; but some of the granitic rocks are of Lower Carboniferous age, and some are apparently Mesozoic.

The Lower Palaeozoic sedimentary rocks are widely distributed, but owing to the rarity of fossils they are not well known. In the south-west of Queensland there are some Ordovician rocks, the eastern continuation of those in the Macdonnell Ranges. Silurian limestones occur in the mining field of Chillagoe and at Mount Wyatt. The Upper Palaeozoic systems are well developed, even when many of the schists, which have been included in the Devonian, are eliminated. The Middle Devonian is represented by the Burdekin limestones, which contain a rich fossil fauna corresponding to the Buchan and Bindi limestones of Victoria. The Middle Devonian limestones occur on the Marble and Hunter Islands in the Northumberland Archipelago. The Devonian rocks in the Pentland and Gilbert district are estimated by Jack to be over 20,000 ft. in thickness; but they probably include some Lower Palaeozoic beds.

The Queensland Carboniferous system is divided into five series—the Gympie, Star and the three divisions of the Bowen beds. The lowest series is the Gympie, which occurs between Brisbane and Maryborough. It consists of shales and sandstones, and is traversed by dikes of diorite, which often contain pyrites and gold. The age of these gold-bearing rocks is proved by the presence of such fossils as *Productus cora* and *Protorelepora ampla*. The Gympie series is well developed in the districts of Burnett, Broad Sound Bay and Wide Bay, along the coast from Port Curtis to the south of Cape Palmerston. The Gympie beds are greatly contorted; and those of the Star series are regarded as younger, because they are less disturbed. They are best known in the basins of the Great and Little Star rivers, tributaries of the Upper Burdekin. They are best developed on the Belyando river and in the Drummond Range, where the shales and sandstones yield abundant fossil fish; on the Star river the shales contain *Lepidodendron*. The Bowen beds are divided into three series which represent the upper part of the Carboniferous. The Lower Bowen series consists of agglomerates and altered rocks exposed in the Toussaint Range; farther south, the Lower Bowen beds consist of grits, sandstones and shales, which have been altered by some granitic intrusions. The Middle Bowen series contains beds with *Productus cora* and *Glossopteris*. The Upper Bowen beds contain coal seams, abundant remains of *Glossopteris* and one marine band. They form the centre of the basin of the Bowen coalfield; while the Middle Bowen beds outcrop in a band around it. The Upper Bowen beds occur also at Townsville and Cooktown in Northern Queensland.

The rocks of the Mesozoic group may be divided into two divisions, of which the lower includes terrestrial deposits containing coal seams; the upper is mainly a marine formation, but it terminates with a further development of terrestrial deposits. The Lower Mesozoic division includes the Burrum and Ipswich series. The Burrum series occurs along the eastern coast from Laguna Bay, through Wide Bay and Maryborough, to Blackwater Creek; and it extends inland for about 30 m., where it is faulted against the Gympie beds. The western edge of the Burrum beds are described as highly altered in places, by contact with granites. The Ipswich series occupies 12,000 sq. m. in the south-eastern corner of Queensland, and is the northern continuation of the Upper Clarence series of New South Wales. It contains coal seams which have been worked, though the coal is of inferior value to that of the Carboniferous of New South Wales. One seam, on Stewarts Creek, near Rockhampton, is 26 ft. thick. Interbedded basalts occur in the Ipswich beds, forming the scarp of the Toowoomba Range. The Burrum and Ipswich beds have been included in the Trias and the Jurassic, or in both systems as the Trias-Jura, but according to A. C. Seward their characteristic fossil, *Taeniopteris daintreei*, is of Lower Oolitic age.

The Cretaceous system is represented by a lower group of marine clays forming the Rolling Downs formation. They are said to rest conformably upon the Ipswich beds, and some of the fossils found in these beds were first described as Upper Oolitic. The affinities of the fauna are in part with Lower Cretaceous and in part with the Cenomanian; so both these series may be represented. The Rolling Downs formation consists in the main of clays, forming the

impermeable cover over the subterranean stores of water, which maintain the flowing wells of central Australia. The Rolling Downs formation underlies the whole of the Western Plains of Queensland, from the foot of the Queensland Highlands, westward to the Barkly Tableland; and it extends from the Gulf of Carpentaria on the north, across the state into South Australia and New South Wales. The Desert Sandstone overlies the Rolling Downs formation. Its age is shown to be Upper Cretaceous by some marine fossils from Maryborough and Croydon, which are said to be from rocks interbedded in it. In the interior, the Desert Sandstone is entirely of terrestrial and lacustrine origin, and the only fossils are obscure plant remains and the silicified trunks of trees. *Glossopteris* has been collected on Betts Creek from a rock identified as Desert Sandstone, which is said to overlie the Rolling Downs formation; but there is probably some mistake in the stratigraphy, as *Glossopteris* is only found in Coal Measures which are clearly of Palaeozoic age. If it had survived into the Cretaceous, some specimens of it would doubtless have been obtained from the coal seams of the Lower Mesozoic. The Desert Sandstone once covered nearly three-quarters of Queensland, having a wider range than the Rolling Downs formation. It was formed partly on land, partly in freshwater lakes and partly in arms of the sea, as at Croydon and Maryborough. There is no trace of volcanic rocks in this period, and the vitreous surface of the Desert Sandstone is due to the deposition of efflorescent chert. The Desert Sandstone formation has now been weathered into isolated plateaus and tent-shaped hills.

The Cainozoic group includes many volcanic rocks, mainly sheets of basalt, as at Townsville and Hughenden. Near Herberton, between the head of the Burdekin and the Einasleigh River, the basalts occupy 2000 sq. m. of country. Their age appears to be Oligocene, as they probably correspond with the oldest Cainozoic basalts of Victoria. Volcanic rocks of a later period occur north of Cooktown, and in the Einasleigh River, where the eruptive centres are recognizable; and a series of hot springs, some of which are described as geysers, represent the last stage of volcanic activity. The most important Cainozoic sedimentary rocks are the bone breccias, made up of bones of extinct marsupials, such as *Diprotodon*, *Thylacoleo* and giant Kangaroos. They appear to have been bogged in the mud by drying water holes, during droughts. The bones also occur in beds of gravel and sand, and they have been found in places covered by 188 ft. of overlying deposits. Caves occur in the limestones, and on their floors there are beds yielding bones of marsupials and extinct birds; but no well authenticated case of the ancient remains of man has yet been established.

The chief mineral product of Queensland is gold, found in veins in Archean, Palaeozoic and Lower Mesozoic rocks. The most famous gold mines are Mount Morgan, now changing into a copper mine, Charters Towers and Gympie. Tin is found in the fields of Herberton, Cooktown and Stannary Hills. Copper occurs near Herberton, Chillagoe and Mungana, coal in southern Queensland in the Upper Carboniferous and Lower Mesozoic deposits.

A full account of the geology of Queensland up to 1892 is given in Jack and Etheridge's *Geology of Queensland*. The tectonic geology of the coast-line has been described by E. C. Andrews, and the general geology is described in the numerous valuable publications of the Geological Survey of Queensland. A summary of the mineral resources was issued by the Queensland government in 1901. Information regarding the artesian water supply is given in the Annual Reports of the Queensland Hydraulic Engineer.

(J. W. G.)

Flora.—The Queensland flora comprehends most of the forms peculiar to Australia, with the addition of about five hundred species belonging to the Indian and Malayan regions. There are no mountain ranges of sufficient altitude to make any appreciable change in the plant-life. Bellenden Ker, the highest mountain in tropical Australia, has a height of only 5200 ft., and the plants growing upon its summit, as well as on the highest parts of the neighbouring mountains, are for the most part similar to those on the low lands in the southern parts of the state, and the plants which may be considered as peculiar to these heights are few in number of species. They consist of a *Leptospermum* and a (?) *Myrtus*, which attain a height of about 30 or 40 ft., and have widespread, densely leaved heads. The most attractive of the tall shrubs are *Dracophyllum Sayeri*, of which there are two forms, *Rhododendron Lochae* and *Orites fragrans*. A few orchids of small growth are met with, but the only large species known to inhabit these localities is the normal form of *Dendrobium speciosum*. These high spots have a few ferns peculiar to them, and of others it is the only known Australian habitat; for instance, the pretty white-fronded Java Bristle-fern (*Trichomanes pallidum*) has only so far in Australia been met on the south peak of Bellenden Ker; here also *Todea Fraseri* may be seen with trunks 2 to 3 ft. high. The sides of these mountains are clothed by a dense forest scrub growth, some of the trees being very tall, but diminishing in height towards the summits. Palms and fern-trees are plentiful, but the greatest variety are met with at about 4000 ft. altitude. So far this is the only known habitat of that beautiful fern-tree *Alsophila Rebeccae* var. *commutata*, peculiar for the wig-like growth at the summit of

its stem, which is formed by the metamorphosed lower pinnae and pinnales.

The Myrtaceous genus *Eucalyptus*, of which sixty species are found, furnishes the greater part of what is designated "Hard-woods," the kinds being variously termed "Box," "Gum," "Iron-bark," "Bloodwood," "Tallow-wood," "Stringy-bark," &c. These are mostly trees of large size. Other large trees of the order which supply hard, durable timber are the broad-leaved tea-tree (*Melaleuca leucadendron* and others), "Swamp Mahogany" (*Tristania suaveolens*), "Brisbane Box" (*T. conferta*), "Turpentine" (*Syncarpia laurifolia*), "Peebeen" (*S. Hillii*), "Penda" (*Xanthostemon oppositifolius*). These are most generally cut at sawmills. Other orders, however, furnish equally serviceable, large-sized timber, particularly the following:—"Sour Plum" (*Owenia venosa*, Meliaceae), "Red Cedar" (*Cedrela Toona*), "Crow's Ash" (*Flindersia australis*, Meliaceae), "Burdekin Plum" (*Pleiogynium Solandri*, Anacardiaceae), "Bean-tree" (*Castanospermum australe*, Leguminosae), "Johnstone River Teak" (*Azelia australis*, Leguminosae), "Ringing Rosewood" (*Acacia glaucescens*, Leguminosae), "Black Walnut" (*Cryptocarya Palmerstoni*, Laurineae), "Hill's Teak" (*Dissiliaria baloghioides*). Many trees yield wood particularly adapted for carving and engraving, such as the "Native Pomegranate" (*Capparis nobilis*), the "Native Orange" (*Citrus australis*), "Sour Plum" (*Owenia acidula*), "Ivorywood" (*Siphonodon australe*). Coachbuilders and wheelwrights use the wood of many myrtaceous trees and several others, with Flindersias (Meliaceae), whilst tool-handles are also formed from these and other trees. There is also a large variety of woods suited for cabinet-making and building. A large number furnish tannin barks, gums, &c. The tannin barks are mostly derived from various kinds of acacia. Three spice barks, locally known as sassafras, are employed for flavouring—in the northern parts, *Daphnandra aromatica*, a Monimiaceous tree, and *Cinnamomum Tamala*; and in the southern parts *Cinnamomum Oliveri*. Many indigenous plants are used in domestic medicines, and several are recognized in the Pharmacopoeia, such as Eucalypts, Cinnamomums, Sideroxylons, Alstonias, Duboisias and Pipers.

With regard to fodder-plants, no country is better furnished; there are many herbs and a large number of salt bushes and other shrubs, which form excellent auxiliaries to the food supply for stock. It is, however, to the grasses that the excellence of the pastures is mainly due. On the extensive plains where the best species abound may be seen a large number of the genus *Panicum*, of which the following are looked upon with the greatest favour:—"Vandyke grass," a form of *P. flavidum*, "Cockatoo grass" (*P. semialatum*), on the roots of which a species of cockatoo, in some parts of North Queensland, feeds; "Barley grass" (*P. decompositum* and *P. distachyum*); "Blue grass" (*Andropogon sericeus*, *A. pertusus*, *A. refractus*, and *A. erianthoides*); "Russell River grass" (*Paspalum galmarra*, nearly allied to the South American species *P. paniculatum*, *P. minutiflorum*, and *P. brevifolium*, *Agropyrum scabrum*); "Tall Oat grass" (*Anthistiria avenacea*); "Landsborough grass" (*Anthistiria membranacea*); *Danthonia racemosa*, *D. pilosa*, *D. pallida*, and *D. semiannularis*; *Sporobolus Benthani*, an excellent species found near the Diamantina and Georgina rivers, and *S. actinocladius*; *Stipa aristiglumis*, *Leptochloa chinensis*, *Microlaena stipoides*; "Early spring grass" (*Eriochloa punctata*), with the following "Love grasses":—*Eragrostis Brownii*, *E. chaetophylla*, *E. pilosa* and *E. tenella*. The "Mitchell grasses" (*Astrelba pectinata*) and its varieties, viz. the Wheat (*triuicoides*), the weeping (*elymoides*) and the curly (*curvisolia*), are those that have the most extraordinary vitality, but some stockholders consider that the "Sugar grass" or "Brown Top" (*Pollinia fulva*) surpasses them in its quickness of bursting into leaf with the first showers of rain.

Amongst the fruits are *Antidesma Bunius*, *A. Dallachyanum*, *A. erostre*, *A. Ghaesembilla*, and *A. parvifolium*, called cherries or currants according to the size of the fruit they bear, the jelly made from the fruit of some species being in nowise inferior to that made from the European red currant. The Kumquat or lime of Southern Downs country (*Atalantia glauca*) makes a peculiarly nice-flavoured preserve. Of the allied genus *Citrus* two species are met with in the south. *C. australis*, which has a round fruit 1 to 2 in. in diameter; the other, *C. australisica*, with long finger-like fruits 3 or more inches long and about 1 in. in diameter; of this a red variety (*C. inodora*), which is only met with in the tropics, bears a fruit often 2½ in. long by 1½ in. in diameter. All these fruits are juicy, and of an agreeably sharp, acid flavour. "Davidson's Plum" (*Davidsonia pruriens*) is a fruit with a sharply acid, rich, plum-coloured juice, sometimes attaining the size of a goose's egg. Of the genus *Eugenia*, over thirty are indigenous, and fully one-third produce more or less useful fruits. One Fig (*Ficus gracilipes*) produces a fruit used for jam and jelly. Two Garcinias are recorded as indigenous, but of one only (*G. Mestoni*) is the fruit known. It is of a depressed globular form, sometimes 3 in. in diameter, very juicy, and of a pleasant flavour. *Leptomeria acida*, one of the very early fruits used by Australian colonists, is met with in some localities. The "Finger Berry" or "Native Loquat" (*Rhodomyrtus macrocarpa*) makes a good jam, but is in bad repute for use in the raw state, perhaps owing to a peculiar fungus at

times found to infest the berries. The Queensland Raspberry (*Rubus rosaefolius*) is widely spread and commonly used, but the fruit is rather insipid. The representatives of the genus *Vitis* all belong to the sub-genus *Cissus*; several of them, although somewhat acid, are useful for jam and jelly; probably the best for the purpose is one met with near the Walsh River, *V. Gardineri*, which is said to bear bunches from 1 lb to 2 lb in weight, the berries being large and of pleasant flavour. A large number of nut-like fruits are used by the aborigines for food, but the only one used by the white population is the fruit of *Macadamia ternifolia*, the Queensland nut.

The foliage of many plants yields by distillation essential oils, particularly Eucalypts, Backhousias and other Myrtaceous plants, as well as some belonging to Rutaceae and Labiatae, especially the genus *Mentha*. Apart from plants of economic value, there is a profusion of ornamental plants, shrubs, trees and parasites. Of ferns, one-half of the kinds met with in Australia are found in Queensland as well as in the other states, one-fourth in Queensland alone, the remaining fourth belonging to the other states, but not to Queensland. The indigenous ferns equal in number those of New Zealand, and are three times the number of those of Great Britain.

Fauna.—The land fauna of Queensland is essentially one with that of the entire continent. But the geographical position of the state, which exposes it to the climatic and transporting influences of the intertropical Pacific, has to a notable extent impressed on its fauna characters of its own. It has thus been made the headquarters of Australian bird-life on land and fish-life at sea, the moisture of its coastal regions and the warmth of its tidal waters being eminently favourable to that wealth of insect and other low types of life which determines the multiplication of the higher. The quadrupeds of Queensland are of the ordinary Australian type already described. Of the predominant class, the marsupials, one of the most interesting forms is the Tree-Kangaroo (*Dendrolagus*), as, apart from the habit of climbing trees, which is shared to some extent by the Rock-Wallabies, they afford a proof of the one-time continuity of the fauna with that of the islands to the north, when land communication still existed between the two areas. Of these curious animals, two species at least are known. As to the rest of the marsupials, there is of course a general resemblance to those of the continent as a whole, but this is accompanied by much evolution of forms, especially among the smaller sorts, recognized by differences which are occasionally sufficient to mark off distinct generic, or even more differentiated groups. The larger Kangaroos are pretty conservative in character everywhere, while the common Wallabies, the Rock-Wallabies and the Kangaroo-Rats exhibit a greater tendency to differ from their southern and western kindred. The Koala, or native Bear, is almost absolutely invariable, a sign of the antiquity of the race. The Opossums and the so-called Flying-Opossums are not many in species, and are dwarfed descendants from a more flourishing ancestry. The Bandicoot family (Peramelidae) is fairly represented; it includes the rabbit-bandicoot, which crosses in its eastern range the western border of the country. Carnivorous marsupials of destructive powers are few; the largest of them, the spotted-tailed native cat (*Dasyurus maculatus*), is the most troublesome. Superior in size to the domestic cat, this pretender to the rank of cat is able to devastate a whole hen-roost in a single night, and is even said by the aborigines to attack their infants. With the exception of a smaller species of the same kind, and a brush-tailed ally very much smaller, but yet able to kill a fowl with a single bite, the rest (marsupial mice) are but partly carnivorous, chiefly insectivorous, and therefore useful. This fauna is now fortunately deprived of the *Thylacinus* (Native Tiger) and *Sarcophilus* (Native Devil), which have been driven by physical changes southwards to Tasmania, and, it was thought until lately, of the Wombats, but a new species of these inoffensive burrowers has recently been discovered within the southern borders of the state. One other peculiarity in the form of a marsupial mammal is the little Musk-Rat (*Hypsiprymnus*), inhabiting those northern scrubs which are so prolific in other animal forms foreign to the rest of Australia, and seem to have received some of their denizens from the Malay Archipelago and some from the Papuan Islands. The remarkable deposits of fossil bones, extending in patches throughout the length of the country, are sufficient proof that in former times a much larger number of animals were supported by it than are now to be found within its borders. Queensland has only one native carnivorous beast, the dingo, not a marsupial. Rats and mice of native origin are in considerable variety; among them are the Jumping Rats (*Haplotis*), Jerboa-like little animals, which are seldom seen. The bats are of several species; the most notorious of them are the great fruit-bats, or flying-foxes, which the fruit grower could well enough spare. The Sirenian mammal, the dugong, haunts nearly the whole of the coast-line. The Echidna, a porcupine ant-eater, and the playtpus are met with in the south. Batrachians are limited to the frogs and their nearest allies—that is, to the tailless division of the order, the tailed batrachians (newts, &c.) being, as far as is known at present, entirely absent. The greater part of the frogs are arboreal in habit, the most familiar being the large Green Tree Frog. The exuberance and diversity of their food have doubtless been the cause of their differentiation into many distinct species, which

enables them to play a very useful part in checking the undue increase of noxious insects. Snakes, on the other hand, are in too great variety for human interests, as they live very largely on insect-feeders. The great majority belong to the venomous Colubridae, but fortunately the kinds of which the bite is more or less deadly are not numerous, and snake-bite is one of the rarest causes of death. Those with the worst reputation are the Black Snake and the Orange-bellied Black Snake (*Pseudechis*), the Brown Snake (*Diemansia*), the Keeled Snake (*Tropidechis*), and the Death Adder (*Acanthopsis*). The principal non-venomous species are the Pythons or constricting snakes, e.g. the common Carpet Snake (*Morelia*), the long lithe Tree Snake (*Dendrophis*) and the Fresh-water Snake (*Tropidonotus*). The Black-headed Rock Snake (*Aspidotes*), one of the Pythons, is said to reach the length of from 20 to 25 ft., but to be perfectly inoffensive. Several kinds of marine snakes occur on the coasts, and all are to be accounted dangerous. Of reptiles, the most numerous group by far is that of the lizards, which have among them representatives of each of the leading families of the class except the Chameleons. Tortoises are exemplified by many forms in the fresh waters; on the coasts by the leather-back, the edible turtle and the tortoise-shell turtle. Queensland waters are not at present infested by any species of alligator, though in times past one of large size was a scourge on the borders of the then inland sea. The crocodilian of its coasts is the crocodile of the Indian Seas, which ranges over the whole of the western tropical Pacific, and wanders south into Queensland waters as far as Keppel Bay. In the fresh-water pools of the northern tableland is found a small and harmless crocodile (*Philas*) of a very uncommon form. The avifauna is to the naturalist exceedingly attractive, for it is full of surprises and interesting lines of research, while to the artist it is a storehouse of form and colour. Where flowering and honey-yielding trees prevail, a profusion of birds seek their food either on the insects attracted by the honey, or, if so fitted, on the honey itself. Accordingly, the most striking feature of the bird-life, amid the forests of eucalypts and acacias, is its richness in honey-eaters and insect destroyers. The former, however, taken as a whole, are not a natural group, but include a family of perching birds and a portion of the parroquet family, both furnished with brush tongues adapted to the extraction of honey. A second characteristic is the great development of that quaint company, the bower birds, among them the regent bird, satin bird, cat birds, &c., constructors of the elaborate playgrounds which have excited so much attention. A third is the presence in one small part of the territory of a cassowary, and on its seaboard of three kinds of rifle birds, both extensions southwards of the tropical families of cassowaries and paradise birds. In the same region of prolific vegetation the handsome fruit-pigeons are also outliers of a large family of such pigeons spread through the Papuan jungles. There is one species of lyre-bird found in the southern highlands; the giant kingfisher, a laughing jackass, is found in the same region. The Scrub-turkey (*Catharturus*) heaps its mound of rotting debris to ferment in the shade of the jungles and give warmth to its eggs; the Scrub-hen (*Megapodius*) piles up sand on the beach for the sun to furnish the necessary temperature. The comparative paucity of birds of prey (Falconidae), and the almost total absence of ratorial game- and poultry-birds, may be noted. Birds pursued for sport or profit, however, are not wanting. The Emu and the Bustard or Plain Turkey afford sport in the open country, Quail and Snipe in or near the timber, while rivers and lakes still unvisited by the gun are covered with Ducks and Geese, Swans and Pelicans. It has been said that Australia has no migratory birds: this is an error, founded upon an undue restriction of the term migratory. Several species could be mentioned which are truly migratory in Queensland, as the Drongo-shrike, Bee-eater, Dollar-bird, &c. On the land surface, among its lowly organized products, interest centres in the multitudinous forms of insect-life, of which, excepting the Butterflies and Moths (Lepidoptera) and Beetles (Coleoptera), comparatively little is known at present. Insects inimical to man, with the exception, in some localities, of ants, flies and mosquitoes, are inconsiderable in number, and possess few hurtful properties. Centipedes, scorpions and leeches are less troublesome than in most other tropical regions. Spiders present themselves in astonishing variety, but only one kind, a small black spider with red spots (*Lathroedectus*), is malignant. Among the larger insects proper, the great-winged Phasmas, the Skeleton or Stick-insects, the Leaf-insects, and the splendid Swallow-tailed Butterflies are especially notable. Many of the Beetles are remarkable for size or brilliancy of colour.

Fishes and Fisheries.—The class fishes is extraordinarily profuse in diversified forms, the coral reefs being the grazing- and hunting-grounds of hosts of gorgeously decorated fish, chiefly of the Wrasse family; these, however, are almost equalled in beauty by the Chaetodonts, Gurnards, &c., of other habitats. Among the Perches are the enormous Groper, which may attain the weight of 4 cwt., the Murray Cod, and the Giant Perch, both excellent food-fish of about 70 lb in weight. Sharks of many species abound. A survival from the Mesozoic period is the *Ceratodus* or Burnett Salmon, which, formerly inhabiting the headwaters of the Murray, still breeds in two of the smaller rivers north of the Bunya Range. This fish possesses a rudimentary lung in addition to ordinary gills. The

barrier reefs are thickets of corals of the most varied forms, in life glowing with colour, in death shrubs of snowy purity. Among the shell-fish conspicuous for beauty or rarity are the exquisitely delicate paper nautilus and Venus comb (*Murex tenuispina*), the orange and other valuable cowries, and the gigantic clam-shell, which may require a ship's tackle to lift it from its bed. The fishery of the trepang, bêche-de-mer or sea slug employs a considerable number of boats about the coral reefs. Boiled, smoke-dried and packed in bags, the trepang sells for exportation to China, though its agreeable and most nourishing soup is relished by Australian invalids. One species of this sea slug—the teat-fish—fetches as much as £240 per ton. The pearl fishery is a prosperous and progressive one in or near Torres Straits. A licence is paid, and the traffic is under government supervision. Thursday Island is the chief seat of this industry. The shells are procured by diving, and fetch from £120 to £200 a ton. Mother-of-pearl and tortoise-shell constitute important exports of the colony, capable of great expansion. Oysters are as fine flavoured as they are abundant. Turtles are caught to the northward. Of the fish which frequent the coast, one of the best known varieties is the sea mullet (*Mugilidae*), large shoals of which strike the Australian coast 100 m. south of Sydney, and travel northwards, arriving on the southern coast-line of Queensland in the months of April and May, crossing bars and ascending rivers on the appearance of south-easterly weather. These magnificent fish often attain a weight of from 10 lb to 12 lb. Small schools of bream succeed the mullet, and are followed in September and October by the poombah or tailor-fish, a fish of exceptional flavour, and much esteemed by epicures. These are succeeded by jewfish, specimens of which caught in southern waters have been known to exceed a weight of 50 lb, whiting, garfish and flatheads, while flounders, black and tongue soles are occasionally caught by seine or hauling nets. White and black trevally, groper and rock cod, and a variety of bonito identical with the tunny of the Mediterranean Sea are also frequently met with. Several species of the tassel fish (*Poly-nemus macrochoir*), from which isinglass is procured, have been taken by fishermen. King-fish, batfish, gurnards and eels of many varieties are also common. Schnapper, bream, rock cod, parrot-fish and groper are caught by hook and line in from 10 to 30 fathoms of water off the rocky headlands of the southern coast. Sardines, whitebait and sprats make their appearance in large shoals on the coast at intervals. The barramundi (*Osteoglossum leichardti*), which occurs in the Dawson and western waters, is found also on the east coast, and is one of the most esteemed fresh-water fish in Queensland. Dugong, which formerly were found in herds along the northern coast and as far south as Moreton Bay, are caught in set nets of 36 in. mesh, 100 fathoms in length. Different varieties of turtle are plentiful, the green edible turtle being caught by large set nets, and preserved and tinned for export. In Torres Strait and the northern coast the hawksbill turtle, yielding the valuable tortoise-shell of commerce, is said to be captured in a peculiar manner, the sucking-fish or remora (*Echeneis naucrates*) being utilized by the islanders for that purpose. The remora is carried alive in the bottom of the canoe, a long thin line being attached to the fish's tail and another usually to the gill. On a turtle being sighted and approached to within the length of the line, the sucking-fish is thrown towards it, and immediately it swims to and attaches itself by its singular head sucker to the under surface of the turtle, which if of moderate size is easily pulled into the canoe.

Amongst the crustacea may be enumerated the gigantic clams which are found on the reefs of the Inner Route. Occasionally some are met with weighing nearly half a ton, embedded in coral. Fresh-water clams are found in the rivers in the northern districts. The edible oyster (*Ostrea graminifora*) has been largely cultivated in southern Queensland. Amongst other crustacea, the squat lobster (*Themis orientalis*) is, with giant prawns and quampi, or small golden-lipped pearl shell, obtained by trawling in the southern waters. Many varieties of crabs are also found on reefs and foreshores at low tide; prawns and shrimps are caught, dried, and form an article for export to China; mussels, pinna or razor-shell cockles, and eugaries (a species of small shell-fish) are also abundant.

Climate.—As one-half of Queensland lies within the tropics the climate is naturally warm, though the temperature has a daily range less than that of other countries under the same isothermal lines. This circumstance is due to the sea breezes, which blow with great regularity. The hot winds which prevail during the summer in some of the other states are unknown in Queensland. Of course, in a territory of such large extent there are many varieties of climate, and the heat is greater along the coast than on the elevated lands of the interior. In the northern parts of the state the high temperature is trying to persons of European descent. The mean temperature at Brisbane during December, January and February is about 76°, while during June, July and August it averages about 60°. In towns farther north, however, the average is higher. Winter in Rockhampton, for instance, averages nearly 65°, while the summer average rises almost to 85°. At Townsville and Normanton the average is higher still. The average rainfall is high, especially along the northern coast, where it ranges from 60 to 70 in. per annum. At Brisbane 50.01 in. is the average of 35 years, and

even on the plains of the interior from 20 to 30 in. usually fall every year. West of the coast range the air is dry and hot, and in summer the thermometer rises frequently to 106° in the shade. The monsoons play an important part in cooling the atmosphere near the coast, and are very regular in the north. The winter climate is perfection, especially in the north, but frosts are frequent and regular west of the coast range. Ice is commonly seen at Herberton, 17° S., during winter, and on the Darling Downs frosts are of nightly occurrence.

Population.—The population of Queensland in 1905 was estimated at 528,048—290,206 males and 237,842 females, the density of population per sq. m. being about 0.79. In 1861, that is, two years after the separation from New South Wales, the population of the colony stood at 34,400; in 1871 it had reached 125,100; in 1881, 227,000; in 1891, 410,300, and at the census of 1901, 498,129. The policy of assisted immigration contributed greatly to Queensland's progress, and people of foreign descent are proportionately more numerous than in any of the other states, though they only amount to 8.71% of the total population. At the census of 1901 there were 13,166 Germans, 3161 Danes, 2142 Scandinavians, and among coloured aliens 8587 Chinese, 2269 Japanese, 939 Hindoos and Cingalese, 9327 Pacific Islanders, and 1787 other races, making a total of 22,909 coloured aliens. It is estimated that the total aboriginal population of Queensland is about 25,000.

The births in 1905 were 13,626, of which 950 were illegitimate, and the deaths 5503, the respective rates per thousand of the population being 25.92 and 10.47. The decline in the birth rate will be gathered from the following table:—

Period.	Birth Rate per 1000 of Population.	Period.	Birth Rate per 1000 of Population.
1861-65	. . . 43.07	1886-90	. . . 38.81
1866-70	. . . 43.91	1891-95	. . . 35.15
1871-75	. . . 40.81	1896-1900	. . . 30.40
1876-80	. . . 36.72	1901-05	. . . 26.60
1881-85	. . . 36.37		

The death rate shows a remarkable diminution: in 1861-65 it averaged 21.06 per 1000; in 1871-75, 17.94; in 1881-85, 19.10; and in 1891-95, 12.82. The marriage rate in 1905 was 6.04 per 1000, being an increase on the figures for 1904 of 95.

The chief cities and towns, with their population in 1905, are:—Brisbane, 128,000; Rockhampton, 15,461; Gympie, 13,200; Maryborough, 12,000; Townsville, 10,950; Toowoomba, 10,700; Ipswich, 8637; Mount Morgan, 8836; Charters Towers, 6000; Bundaberg, 5000.

Administration.—As one of the Commonwealth states Queensland returns six senators and nine representatives to the federal parliament. The state parliament consists of a legislative council of 37 members nominated for life, and a legislative assembly of 72 members, who each receive £300 per annum for their services. For purposes of local government the state in 1905 was divided into 46 municipalities and 125 shires. The boroughs control 354 sq. m. and the shires 667,898 sq. m.; the revenue and expenditure of the former in 1905 being respectively £312,510 and £321,645, and of the latter £190,837 and £180,457. Revenue is mainly derived from rates levied on the capital value of assessed properties, which amounted for the whole state to £42,358,173, representing an annual value of £2,647,400. All improvements are exempt from assessment, and much of the revenue is expended in road-making and the building of bridges. Rates are supplemented by an endowment from the central government.

Education.—Public education is free, unsectarian and compulsory. State or provisional schools are formed wherever an average attendance of twelve children can be got. Theoretically the school age is from six to twelve years, but in practice compulsory attendance is seldom if ever enforced in certain parts, owing mainly to the difficulty of providing suitable schools within reasonable access. In 1905 there were 1044 state schools, with 2382 teachers and 88,903 scholars. Of private schools the number in 1905 was 171, with 739 teachers and 14,891 pupils. Exclusive of coloured aliens almost the whole adult population can read and write. In 1905 the sum spent on education was £281,575. Ten grammar schools are endowed by the state. By a system of competitive scholarships the government gives free education in grammar schools to scholars in state schools, and also three-yearly exhibitions to universities to students who pass an examination of a high standard. State aid is also rendered to schools of art, schools of design, free libraries and technical schools.

There is no state church. Amongst the different denominations the Church of England, at the date of the last census, numbered 37.5% of the population, the Roman Catholic 24.5%, the Presbyterians 11.7, the Methodists 9.5, the Baptists 2.60, the Jews 0.2, other Christian bodies 12.3, Pagans and Mahomedans, 4.43.

Finance.—For the year ending June 1905, the receipts amounted to £3,595,399, equal to £6, 17s. 10d. per inhabitant. The chief items of revenue were: taxation, £454,574; crown lands, £623,416; railways, £1,409,414; balance refunded by the federal government, £752,532. The expenditure for that year was £3,581,403, equal to £6, 17s. 4d. per inhabitant; the chief items being:—interest on public debt, £1,547,091; railways, £812,931; education, £322,496; charitable institutions, £135,338. The public debt of the state at the end of 1905 was £39,068,827, or £74, 6s. 3d. per inhabitant; the bulk of this sum, £23,567,554, having been expended on railways. The following shows the growth of the public indebtedness:—

Year.	Total Debt.	Debt per Inhabitant.
1861	£70,000	£2 0 9
1871	4,047,850	32 6 11
1881	13,245,150	58 7 2
1891	29,457,134	73 12 5
1901	39,338,427	76 8 6
1905	39,068,827	74 6 3

Defence.—The Commonwealth defence forces in Queensland had an actual strength at the end of 1905 of 7212 men, comprising a permanent force of 258, 2486 militia, 959 cadets and 3189 riflemen.

Mining.—In Mount Morgan Queensland possesses one of the chief gold mines of the world, and this mine is also one of the leading copper mines of the Commonwealth. In 1905 the value of the mineral production of the state was £3,726,275, being an excess over that of the previous year of £22,034, the highest in the history of the state. This advance was due, not to any improvement in the gold yield, which, latterly, has receded from the high level of former years, but to the increased output of the industrial metals. The value of the minerals, other than gold, won during 1905 amounted to £1,208,980, almost one-third of the total value of the year's mineral production, in which gold represented £2,517,295; silver, £69,176; copper, £503,547; tin, £297,454, and coal, £155,477.

Agriculture.—The total area under cultivation in Queensland in 1905 was 622,987 acres, the principal crops being:—wheat, 119,356 acres; maize, 113,720 acres; hay, 37,425 acres; green forage, 66,183 acres; potatoes, 7170 acres; barley, 5201 acres. Sugar-cane cultivation is important. The progress of the industry may be gauged from the following figures:—area under cane in 1864, 94 acres; 1871, 9581 acres; 1881, 28,026 acres; 1891, 50,948 acres; 1901, 112,031 acres; 1905, 134,107 acres. The greater part of the field work on the Queensland plantations was long performed by coloured labour, chiefly South Sea islanders. In 1901, however, the federal parliament passed an act under the provisions of which a limited number of Pacific islanders were allowed to enter Australia up to the 31st of March 1904, but after that date their coming was to be prohibited. All agreements for the employment of these Kanakas were to terminate on the 31st of December 1906, after which date all Pacific islanders were to be deported. Fruit cultivation has attained considerable importance. In 1905, 2044 acres were under vines; 6198 under bananas; 1845 under pineapples; 3078 under oranges; 374 under mangoes; 173 under strawberries; 537 under apples. The soil and climate of Queensland are admirably fitted for the production of excellent cotton, but this promise has not been realized. In 1871 the export of this staple was over 2,600,000 lb, valued at £79,000; the production gradually diminished and in 1898 absolutely ceased. The year 1902 saw a revival when 8 acres were planted; and in 1905 171 acres were devoted to cotton-growing. While the area set apart for tobacco cultivation continues to increase, the yield in 1905 being 10,230 cwt. (cured leaf) from 933 acres, the production of coffee dropped from 132,554 lb in 1904 to 82,230 lb in 1905.

Stock-raising is, however, the principal industry of the country. At the close of 1905 the numbers of the principal kinds of stock depastured were: cattle, 2,963,695; sheep, 12,535,231; horses, 430,565; swine, 164,087. The cattle industry has been greatly affected by the ravages of the cattle tick and by a succession of disastrous seasons, and the number in the state in 1905 was considerably less than half the number mustered in 1894. As the state is very lightly stocked a few good seasons will serve to bring the number of cattle up to the previous greatest record. The sheep industry in Queensland though of less importance than the cattle, is still considerable, and of the six states of Australia, Queensland ranks second in the number which it depastures. The sheep depastured in 1905 were some nine millions less than in 1892. The weight of wool exported in 1905 was 53,072,727 lb; in 1892, however, the export was over 105 millions. Good progress has been made in dairying, the production of butter in 1905 being 20,320,000 lb; of cheese, 2,682,089 lb; of bacon and ham, 10,500,335 lb. It is estimated that the annual value of the pastoral and dairying industry of Queensland is about £8,224,000. The export of live cattle in 1905 amounted in value to £1,500,855; of fresh and preserved meat, £707,345; of wool, £2,280,924; of tallow, £183,372—

in 1894 the tallow export was nearly 30,000 tons, valued at £596,000.

Manufactures.—Queensland is not populous enough to have manufactures on a large scale, nevertheless there are 21,705 persons employed in the 1911 establishments of the state. The majority of these persons are engaged in the preparation of natural products for export, such as sugar, preserved meats and the like, or in industries arising out of the domestic requirements of the population. The horse power employed in 1905 was 28,009; the value of plant and machinery was £3,988,056; and of land and premises £2,709,951; while the value of the output stood at £8,130,480.

Commerce.—The shipping entering Queensland ports in 1905 had a tonnage of 1,067,741 as compared with 468,607 in 1890. The imports in 1905 were £6,699,345, which is much less than the average of Australia, but nearly all the Queensland importations are for home consumption, whereas New South Wales, Victoria and South Australia have a large re-export trade. In 1861 the imports were valued at £968,000, or £31 per inhabitant; in 1871, £1,563,000, or £13 per inhabitant; in 1881, £4,064,000, or £18, 6s. per inhabitant; in 1891, £5,079,000, or £12, 13s. per inhabitant; in 1900, £7,184,112, or £14, 13s. 3d. per inhabitant. The disparity between the capitation figures of various years is due chiefly to two causes: the irregularity of the state borrowings, and the manner in which private capital has been sent from England and from the Australian states for investment in Queensland, both the borrowings and the investments appearing in the imports. The important bearing of these two items on the Queensland import trade may be gathered from the fact that, since 1863, there has been an inflow of capital into the state at the rate of about one million and a quarter sterling per annum. The exports from Queensland in 1905 were valued at £11,939,594, which is equal to the very high average of £22, 14s. 3d. per head; nearly the whole amount represents goods and produce of local origin. Going back to 1861 the amount of exports at the various decennial periods was:—

Year.	Value of Total Exports.	Exports per Head.
1861	£709,599	£22 14 8
1871	2,760,045	22 18 8
1881	3,540,366	15 18 6
1891	8,305,387	20 13 6
1901	9,249,366	18 5 10

Brisbane is the chief seat of trade, but this port does not hold so predominating a position as do the chief cities of the other states in regard to their minor ports. In 1905 the trade at the seven principal seaports of Queensland was:—

Port.	Imports.	Exports.
Brisbane	£4,104,574	£3,524,939
Rockhampton	437,068	1,708,489
Townsville	671,853	1,838,055
Bundaberg	121,567	498,381
Maryborough	157,023	248,706
Mackay	80,468	499,034
Cairns	184,716	873,370

Railways.—Up to 1905 the state had expended £21,683,355 upon the construction and equipment of railways. The mileage open for traffic at the end of that year was 3113; there were also 268 m. of privately owned railways. Railway construction in the state commenced in 1864, some five years after the introduction of responsible government. Progress during the early years was very slow; in 1871 only 218 m. had been constructed and in 1881 only 800 m.; between 1881 and 1891 railway construction was pushed on rapidly, an average of 152 m. a year being opened between those dates. In 1891 the length open for traffic was 2320 m., and in 1901 2801 m. The state railways in 1905 earned £1,483,535 and the working expenses were £851,627, leaving the net earnings £631,908, which is equal to 2.91% upon the capital expended. As the rate of interest paid on the outstanding loans of the Queensland government is 3.94, there is an actual loss to the state of 0.30%. This loss, however, is more than counterbalanced by the advantages resulting from the construction of the railways.

Posts and Telegraphs.—There were 1360 post offices in the state in 1905; telegraph stations numbered 515, and there were 19 telephone exchanges. The revenue from these three services in 1905 was respectively £233,523, £88,285 and £31,765—a total of £353,573, as against an expenditure of £415,420.

Banking.—The liabilities of the eleven banks trading in the state in 1905 totalled £13,770,865, and the assets £16,362,292. The deposits amounted to £13,217,084. The banks held coin and bullion to the value of £1,897,576. In the Government Savings Bank there was a sum of £3,992,758 to the credit of 84,163 depositors. The deposits in all banks amounted, therefore, to £17,209,842, which represents £32, 11s. 10d. per head of population.

AUTHORITIES.—*Statistical Register of Queensland* (annual); *Queensland Official Year Book* (1901); *Reports of the Government Statistician*; H. Russell, *Genesis of Queensland* (Sydney, 1888); T. Weedon, *Queensland Past and Present* (Brisbane, 1897); T. A. Coghlan, *Australia and New Zealand* (Sydney, 1904); F. M. Bailey, *Notes on the Flora at Queensland*. (T. A. C.)

HISTORY

The Portuguese may have known the northern shore nearly a century before Torres, in 1605, sailed through the strait since called after him, or before the Dutch landed in the Gulf of Carpentaria. Captain Cook passed along the eastern coast in 1770, taking possession of the country as New South Wales. Flinders visited Moreton Bay in 1802. Oxley was on the Brisbane in 1823, and Allan Cunningham on Darling Downs in 1827. Sir T. L. Mitchell in 1846-47 made known the Maranoa, Warrego, and Barcoo districts. Leichhardt in 1845-47 traversed the coast country, going round the gulf to Port Essington, but was lost in his third great journey. Kennedy followed down the Barcoo, but was killed by the blacks while exploring York Peninsula. Burke and Wills crossed western Queensland in 1860. Landesborough, Walker, M'Kinlay, Hann, Jack, Hodgkinson and Favence continued the researches. Squatters and miners opened new regions. Before its separation in 1859 the country was known as the Moreton Bay district of New South Wales. A desire to form fresh penal depôts led to the discovery of Brisbane river in December 1823, and the proclamation of a penal settlement there in August 1826. The convict population was gradually withdrawn again to Sydney, and in 1842 the place was declared open to free persons only. The first land sale in Brisbane was on August 9, 1843. An attempt was made in 1846, under the colonial ministry of Gladstone, to establish at Gladstone on Port Curtis the colony of North Australia for ticket-of-leave men from Britain and Van Diemen's Land. Earl Grey, when secretary for the Colonies, under strong colonial appeals arrested this policy, and broke up the convict settlement. In 1841 there were 176 males and 24 females; in 1844, 540 in all; in 1846, 1867. In 1834 the governor and the English rulers thought it necessary to abandon Moreton Bay altogether, but the order was withheld. The first stock belonged wholly to the colonial Government, but flocks and herds of settlers came on the Darling Downs in 1841. In 1844 there were 17 squatting stations round Moreton Bay and 26 in Darling Downs, having 13,295 cattle and 184,651 sheep. In 1849 there were 2812 horses, 72,096 cattle, and 1,077,983 sheep. But there were few persons in Brisbane and Ipswich. The Rev. Dr Lang then began his agitation in England on behalf of this northern district.

Some settlers, who sought a separation from New South Wales, offered to accept British convicts if the ministry granted independence. In answer to their memorial a shipload of ticket-of-leave men was sent in 1850. In spite of the objection of Sydney, the Moreton Bay district was separated from New South Wales by an Order in Council of 13th May 1859, and proclaimed the colony of Queensland. The population was then about 20,000, and the revenue £6475.

The constitution, which was based upon the New South Wales Act of 1853, provided for 16 electoral districts, with a representation of 26 members. A Legislative Council was also formed, to which the governor of New South Wales, Sir William Denison, appointed 5 members, to hold office for four years, and Sir George Ferguson Bowen, the first governor of the new colony, 8 life members. Robert (afterwards Sir Robert) George Wyndham Herbert was the first premier and colonial secretary, and held office until 1866. Of the 39 representatives in the first Parliament, 20 were pastoralists; the others may be roughly classed as barristers, solicitors, and merchants. The pastoralists were the pioneers of settlement in the colony; those best known were the Archers of Gracemere, the Bells of Jimboor, the Gores of Yandilla, the Bigges of Mount Brisbane, Mr (afterwards Sir) Arthur Hodgson, Robert Ramsay, Gordon Sandeman, and Messrs Kent and Wienholt. The white population at the end of 1859 was 25,788, and the exports were valued at £500,000.

Herbert's Administration, 1859-1866.—The first Parliament was opened on May 29, 1860. The providing of revenue and the establishment of immigration were the chief matters for consideration. The treasury was practically empty, but Sir

Saul Samuel, treasurer of New South Wales, took a broad and generous view of the situation, and rendered financial aid, whilst in 1861 the first Government loan of £123,800 was authorized, the money being appropriated to public works and European immigration. Labour was so scarce that as early as 1851 the squatters had imported Chinese; various schemes for the introduction of coolies on a large scale were now mooted, but public opinion was decidedly against any increase in the number of coloured aliens then in the colony. In 1859 the educational system was a mixed national and denominational one; there were 10 schools of the latter class, 1 of the former, and 30 private schools. In 1860 a Board of General Education was established, which extinguished the denominational system and placed the schools under State control. In the same year State aid to religion was abolished. The governor, in opening Parliament in 1863, pronounced decisively against the reintroduction of convicts. In that year Queensland boldly grappled with the extension of colonizing, and a settlement was established at the northerly point of Cape York peninsula by Mr Jardine. During the following two years ports were opened along the coast, and pastoral occupation spread far into the northern and western interiors. The first sod of the first railway, from Ipswich to the Darling Downs, was turned on 15th February 1864. On February 1, 1866, Mr Herbert retired, and Mr Macalister became premier and Mr Mackenzie colonial secretary. In the following July the failure of the Overend and Gurney and Agra banks, in the latter of which the Government had public moneys, caused the collapse of a loan which was being negotiated in London. A panic followed: the Government could not pay the railway contractors, and the navvies employed by them started for Brisbane, threatening to hang the ministers and loot the town. On arrival, however, they were easily headed off to a reserve. By this time the treasury was empty, general insolvency prevailed, and the community appeared to be wrecked. Treasury bills to the amount of £300,000 were issued, and the governor in council was authorized to legalize treasury notes, when necessary, as currency, payable in gold on demand, to tide over the crisis. Prior to this, however, the treasurer took preliminary steps to issue £300,000 "Legal Tender Notes"—inconvertible "greenbacks"—but Sir George Bowen informed the premier that he should veto such a scheme, and suggested the issue of treasury bills. Mr Macalister thereupon resigned, and Mr Herbert, who had made arrangements to proceed to England (where subsequently he became permanent secretary of the Colonial Office), took office again to help the colony through the difficulty. His second ministry lasted for eighteen days, and, having passed the Treasury Bills Act, he retired from the public life of Queensland. The only determined opposition the Herbert ministry met with was from the townspeople's representatives, whose contention was that the squatters dipped too deeply into the public purse for public works expenditure; but an important factor in the early parliamentary days was the opposition between the Brisbane and Ipswich parties in the House, the latter town aspiring to be the capital of the colony.

The Discovery of the Goldfields, 1866-1879.—Macalister returned to power in August 1866, and dealt so vigorously with the after-effects of the financial crisis that by the end of 1867 affairs had approached their normal condition. A new era was now opened for Queensland by the discovery of gold. The Gympie field was discovered by Nash in 1867, and a big "rush" resulted. In 1872 Hugh Mosman discovered Charters Towers, the premier goldfield of the colony; and Hann, the rich Palmer diggings. Other important discoveries were also made, and Queensland has ever since been a gold-producing colony. Mining is the foundation upon which much of the progress of the colony has been built, and the legislation and records show continuous traces of the influence of the gold-getter. In 1873 John Murtagh Macrossan, a digger, was returned to Parliament expressly as a mining representative; and other men of a different stamp from the representatives of the squatters and townspeople, who had

hitherto composed the House, now began to enter public life. From 1870 to 1879 progress was satisfactory, trade interests were prosperous, and in this decade the foundations of the public and social structure of Queensland were laid. Agriculture was extended, and sugar-growing took the place of cotton cultivation. (The first crop of sugar was grown by the Hon. Louis Hope at Cleveland, about 1862.) Hitherto politics had been non-partisan, and legislation was chiefly of a domestic character. From the time of Herbert's departure until the appearance of Thomas McIlwraith and Samuel Walker Griffith, the two master-spirits of Queensland parliamentary life, the political history of the colony was composed of short-lived administrations, with Messrs Macalister, Mackenzie, Palmer, Lilley, George Thorn and John Douglas (afterwards Government Resident at Thursday Island) as premiers. Arthur Hunter Palmer (whose administration, from 1870 to 1874, had the longest life), a New South Wales squatter, entered the Queensland Parliament in 1866. He was one of the most popular of Queensland's parliamentary leaders, and has left the impress of his labours on the public works, and educational and defence force systems of the colony. In 1870 Queensland was disappointed in her ambition of becoming the connecting-point for Australia with the European and Eastern cable systems. A company—the British Australian Telegraph Company—was formed in London to connect Australia by cable with Singapore. The plan provided for a land line from the Queensland telegraphs at Burketown to Port Darwin, in the Northern Territory, where the cable was to be landed. Writing on 25th January 1870, the Telegraph Construction and Maintenance Company officially informed the governor of Queensland that it had received a contract from the British Australian Telegraph Company to construct "cables and land lines, to be laid between Singapore and Burketown, in North Australia." The Construction Company deputed Commander Noel Osborn to negotiate with the Governments of South Australia and Queensland in reference to the land line; but on arrival in Adelaide he accepted the offer of the South Australian Government to construct and maintain a telegraph line right across the continent from Port Darwin to Adelaide, and Queensland was informed that the original plan had been abandoned. Although the company was thus saved the expense of making and maintaining the Port Darwin-Burketown line, it was regarded as having broken faith with Queensland, which had specially pushed on her telegraph system to connect with the proposed line. In consequence of this incident Queenslanders have not always had the facilities for cheap cabling to Europe enjoyed by the other colonies, though the subsequent owners of the cable, the Eastern Companies, were in no way responsible for the act of their predecessors.

A resolution in favour of the payment of members was carried in 1871. In 1872 the first Agent-General in London, Richard Daintree, was appointed. The same year the Railways Act Amendment Act was passed, authorizing the construction of railways by private enterprise, land being offered as compensation for the outlay. Electoral representation was increased to forty-two members. In January 1874 Palmer resigned, and Macalister came into power for two years, the most important measure of his Government being the State Education Act of 1875, on which the present educational system is based. Both Messrs McIlwraith and Griffith were members of the Macalister ministry, but the former resigned in October 1874, owing to a difference of opinion as to a proposed land-grant railway from Dalby to Normanton. In 1878 Mr (afterwards Sir) James Francis Garrick first became a cabinet minister, joining the Douglas ministry as secretary for public works and mines.

Active Politics, 1879-1890.—On 21st January 1879 the first McIlwraith administration came into power, and an important extension of local government was one of the early measures passed, divisional boards being formed to take charge of public works in districts not included in municipalities. In the following session, 1880, the Opposition, led by Mr Griffith, bitterly opposed the Government proposals on Kanaka labour,

land-grant railways, and a European mail service via Torres Straits. The Government, however, concluded an agreement with the British India Steam Navigation Company for a monthly mail service between Brisbane and London for an annual subsidy of £55,000. The Railway Companies Preliminary Act, giving the governor in council power to treat with persons willing to construct railways in return for grants of 8000 acres of land for each mile of rails laid, was also passed. This measure was generally unpopular, and no railways were built under its provisions. During the session Mr Griffith impeached the premier in connexion with contracts for the purchase of 15,000 tons of steel railway metals, and their carriage to the colony, made in London whilst McIlwraith was there in January 1880. A select committee in the colony, and afterwards a Royal Commission in London, subsequently reported in the premier's favour. The discovery of the celebrated Mount Morgan gold mine, and the initiation of artesian well-boring by R. L. Jack, Government geologist, took place in 1881. In 1883 a great drought prevailed, and the compulsory stoppage of public works demoralized the labour market. Early in the year information reached the colony that Germany proposed to annex a portion of New Guinea, which, together with other islands in the Papuan Gulf, was becoming of great strategic value to Australia; and the premier, fearing that it would thus be lost to the empire, instructed Mr H. M. Chester, police magistrate at Thursday Island, to proceed to Port Moresby and take possession of the unappropriated portion of the island in the name of the crown. This act was afterwards—to the indignation of Australia—repudiated by Lord Derby; and, eventually, under the Berlin Treaty of 1886, England and Germany entered into joint-possession of that part of New Guinea lying east of 141° E. In July Sir Thomas McIlwraith (created K.C.M.G. in 1882) was defeated by 27 votes to 16 on a proposal to arrange for the construction of a land-grant railway from Charleville to the Gulf of Carpentaria. The general elections which followed were fought mainly on the questions of coloured labour for the sugar plantations and land-grant railways. The Government was defeated, and Griffith formed his first administration. Later in the year the premier drafted the Federal Council Act at Sydney, and through his efforts Queensland eventually joined the Federal Council of Australasia. In 1884 a ten-million Loan Act was passed, intended to secure continuity in borrowing for railway construction, but many of the lines specified were unsurveyed. According to the view now generally held in Queensland, this loan seriously hampered the colony in after years. In 1887 the number of seats in the Assembly was increased to 72 (the present number), and several reforms were effected in the public service, notably the establishment of the department of agriculture. At the general elections in 1888 Sir Thomas McIlwraith was returned for North Brisbane, defeating Sir Samuel Griffith (who had been created K.C.M.G. in 1886) by a large majority, and resumed office as premier and leader of the "National Party." Ill-health, however, soon compelled him to leave the colony, and he was succeeded by Boyd Dunlop Morehead. Sir Thomas McIlwraith's inflexible nature was evidenced all through his public life. On the death of Sir Anthony Musgrave in Brisbane in 1888, he maintained that the Government should be consulted as to the appointment of the new governor. Lord Knutsford declined to accept this view, and appointed Sir Henry Blake. The premier formally protested, and a deadlock ensued, which was only removed by the resignation of the governor-designate. In 1889 payment of members at the rate of £300 a year, plus 1s. 6d. per mile travelling expenses, was established. In 1890 a financial crisis arose. Sir Thomas McIlwraith had returned to the colony and dissociated himself from the ministry. He conferred on the situation with Sir Samuel Griffith, and a want-of-confidence motion was nearly carried. Morehead resigned, and a coalition ministry, with Griffith as premier, chief secretary and attorney-general, and McIlwraith as treasurer, was formed. An agitation for the separation of Queensland into two or three separate colonies—mentioned as early as 1866—was very marked during this

period. It took formidable shape at Townsville in 1882, the chief argument in its favour being that the north and central districts did not get a fair share of the public expenditure. Delegates were sent to London on several occasions to interview the Colonial Secretary, but success did not attend these direct appeals. Sir Samuel Griffith's Decentralization Bill of 1890, which proposed to erect separate legislatures in the three divisions with powers of local government, was a blow to separationists, and the agitation gradually disappeared.

The Labour Party in Politics, 1890-1900.—The decade from 1890 to 1900 was chiefly notable, apart from the accomplishment of Federation, for the rise of the Labour party as a power in politics and the gradual disappearance of the squatter as a dominant factor. In 1890 the old opponents, Sir Samuel Griffith and Sir Thomas McIlwraith, were still working side by side. The revenue for the year fell short of the estimates by half a million sterling, and a heavy accumulated deficit had to be grappled with by Parliament. Sir Thomas McIlwraith, the treasurer, proposed a dividend tax and other imposts, which were agreed to, and a Treasury Bills Act authorizing an issue of £500,000 was also passed. A Constitution Act establishing triennial Parliaments, in place of quinquennial, which had hitherto existed, also went through. In August the great maritime strike spread to Brisbane, and crippled trade and commerce for several months. In 1891 a loan for £2,500,000, which was issued in London under the auspices of the Bank of England, failed. Sir Thomas McIlwraith reflected strongly in Parliament on the conduct of the Bank of England, and the governor of the bank wrote to Sir James Garrick, the agent-general, protesting against Sir Thomas McIlwraith's statements, and breaking off relations with the colony; but mutual explanations afterwards healed the breach.

Litigation was initiated by the London board of the Queensland Investment and Land Mortgage Company against the Queensland directors, on the ground that they had made advances without taking adequate security. The case was tried by the chief justice, Sir Charles Lilley, in 1891 and 1892, the defendants being Sir Thomas McIlwraith, Sir Arthur Palmer, then president of the Legislative Council, and Messrs F. H. Hart and E. R. Drury. The judge submitted 143 questions to the jury, and though these were answered generally in favour of the defendants, judgment was entered largely for the plaintiffs. On appeal, heard before a specially constituted court, presided over by the late Sir William Windeyer of New South Wales, this judgment was reversed, with costs. Lack of employment and a disastrous strike of bush workers paralysed the colony in this year. The strike began in January at Logan Downs station, where 200 shearers refused to sign the Pastoralists' Convention agreement. This strike was remarkable for the determined and aggressive attitude of the men, and the firm, though conciliatory, manner in which it was handled by Mr (afterwards Sir) Horace Tozer, the colonial secretary, who had to provide military forces and artillery to hold the strikers in check. The trouble lasted many months; and after it was over a farcically planned plot to seize the central district and proclaim a republic was revealed in the *Brisbane Courier*. As an outcome of this strike, "New Australia"—a settlement on communistic lines—was founded in Paraguay (*q.v.*). The year 1892 was one of gloom and depression: want of money interfered with public works, and the impending stoppage of Kanaka labour and the low price of sugar almost ruined the planters. Sir Samuel Griffith then announced his conversion to the policy of continuing Kanaka labour for the sugar plantations, and also of land-grant railways. An act was passed authorizing agreements with companies for the extension of the trunk lines on this principle; but the measure was unpopular, and no transactions under the act are recorded. Financial depression reached its height in 1893: the salaries of ministers and civil servants were reduced, and drastic retrenchments were made in every department. In February, 107 in. of rain fell at the head of the Brisbane

river, and enormous losses were caused by the resulting floods; several vessels, including the Queensland Government gunboat *Paluma*, were washed into the Brisbane Botanic Gardens, and left high and dry when the waters subsided. A second flood followed and caused further losses. Rockhampton, Bowen, Townsville, and other places also suffered severely from floods. On 13th March Sir Samuel Griffith was gazetted chief justice, and on the 27th Mr (afterwards Sir) Hugh M. Nelson became premier and treasurer, and Sir Thomas McIlwraith chief secretary and secretary for railways. Parliament was dissolved on 3rd April, and after the general elections the ministry returned with 38 supporters, against Labour, 16, and Opposition and Independent, 18. During the month several financial institutions suspended payment, and on 15th May the Queensland National Bank closed its doors. Parliament was hurriedly summoned to deal with the financial crisis and the question of the Government funds held by the Queensland National Bank. Treasury notes, issued against coin held by the treasurer, were made legal tender throughout the colony; an issue of £1,000,000 treasury bills to retire the treasury notes was authorized, and a series of acts dealing with the suspended banks were passed. To assist the unemployed, labour and co-operative communities were started, but proved failures. An impetus was given to the sugar industry by the Sugar Works Guarantee Act, which authorized the treasurer to guarantee debentures issued by companies for the erection of sugar mills and plant. In 1894 little legislation was achieved, the policy of the Government being directed towards national rehabilitation. In 1895 Sir Thomas McIlwraith left the colony for London, where he died on 17th July 1900. At the general election of 1896 the Labour party slightly improved its position. In that year a committee of investigation reported a heavy deficit in the affairs of the Queensland National Bank, and made certain recommendations. In 1897 the bank was reconstructed a second time upon terms very favourable to the institution. An act was passed granting powers to a company to construct a railway from the rich mining district of Chillagoe to the terminus of the Cairns railway at Marceba; at the end of fifty years the State was to have the right to acquire the line. In April 1898 the Queensland-born statesman, T. J. Byrnes, whose early death in the following September was lamented throughout Australia, succeeded Sir Hugh Nelson as premier. On 24th October the trial of the three ex-directors of the Queensland National Bank, Messrs F. H. Hart, B. D. Morehead and A. B. Webster, was commenced. The prosecution was instituted by the Government, on the advice of three barristers to whom the report of the committee of investigation into the affairs of the bank, which sat in 1897, was submitted. After a trial lasting 12 days, a verdict of "Not guilty" was returned. Proposals for the acquisition of 250,000 acres of land in New Guinea, made by a syndicate of London capitalists, were provisionally agreed to, but were eventually rejected, owing to a popular outcry raised in the colony and in New South Wales and Victoria. In 1896 the first of a series of factory acts was passed, and in 1907 Wages Boards were established for fixing the statutory minimum rate of wages. (See AUSTRALIA.)

Federation was a burning question in the neighbouring colonies during the year, but Queenslanders generally took little interest in the movement, and the colony was not represented at the Federal Convention at Melbourne when the Commonwealth Bill was passed. In 1899 Mr (afterwards Sir J. R.) Dickson, who had succeeded Byrnes as premier, was enlisted on the side of the "Billites," and in June of that year an Enabling Bill was passed. In September the Referendum supported the act by the narrow majority of 7492 votes on a poll of 69,484. Towards the end of the second session the ministry narrowly escaped defeat on the Railway Standing Committees Bill, and resigned. Mr Dawson, leader of the Labour Opposition, then formed a ministry, and held office from 1st December to 7th December 1899. He was then defeated on a motion by R. Philp, and resigned, and Philp

became premier, and was in power when Queensland joined the Commonwealth. The year was shadowed by the continuance of a terrible drought, which towards the end of 1900 became so aggravated that the revenue began to fall off, owing to decreased receipts from railways and land. In that year Philip's chief policy was the passing of legislation to permit of the construction of railways by private enterprise. The Labour party offered vigorous opposition; but notwithstanding this a certain amount of progress was made. The Government appointed Dr Maxwell, an American sugar expert, to superintend the sugar industry in the colony; a State school of mines was established at Charters Towers; and the compulsory clauses of the Education Act were put in force for the first time. Another act of importance was the establishment of a Government land bank. A powerful agitation for the extension or renewal of the leases of pastoral lands was raised, but no legislation resulted. A suggestion that Sir Samuel Griffith should retire from the chief justiceship, on a pension of £1750 a year (to be reduced by any emoluments received), to enable him to enter Federal politics, fell through. Some important discoveries of coal were made during the year, and dredging the northern rivers for gold became an established industry. J. R. Dickson represented the colony in London at the conference of Federal delegates in 1900, when the final details of the Commonwealth were settled. Early in 1901 he was created K.C.M.G., but died somewhat suddenly, at Sydney, on 9th January of that year, shortly after he had been made a member of the first Federal ministry.

Alien Immigration.—The working classes of Queensland have always objected to the presence of coloured aliens, and successive Governments have legislated against indiscriminate immigration into the colony. In 1876 Governor Cairns reserved an act imposing certain disabilities upon Chinese working on goldfields. In that year a poll tax of £10 was imposed upon Chinese arriving. In 1884 another principle was adopted: masters of ships were only allowed to carry to Queensland ports one Chinese for every 50 registered tons, and the poll tax was increased to £30. In 1888 Queensland took the lead in summoning an intercolonial conference on Chinese immigration, the outcome of which was the adoption of uniform legislation: in the Queensland Act passed that year the main provision was that only one Chinese for every 500 registered tons should be permitted to be carried to the colony from Chinese ports. The poll tax was then abolished. This act was also reserved, but received the Royal Assent on 5th February 1890, after slight modification had been made.

Treaty arrangements with Japan had been carried through by the Imperial Government, at the initiation of Queensland, under which the Japanese Government undertook to prevent the emigration of coolies to the colony; and a Pearl Shell Fisheries Act was passed in 1895 placing restrictions upon the acquisition of vested interests in the industry by Japanese and other aliens. At Federation eight acts—two Imperial and six local—regulated the importation of Kanakas from the South Seas: that of 1880 was the basis of the system under which Kanakas were recruited in the islands, brought to the colony in schooners, employed there, and returned to their homes at the end of their three years' engagements. The 1884 act confined Kanakas to field work. In December 1884 a Royal Commission was appointed, consisting of Messrs W. Kinnaird Rose, J. F. Buckland, and Hugh M. Milman, to report upon the system of recruiting Kanakas. Following the report of the Commission, which was in effect that many islanders had been recruited "by force and fraud," Sir Samuel Griffith, then premier, introduced the important Pacific Island Labourers Amendment Act of 1885, which stopped the importation of Kanakas after 1890. It was—and is—an article of faith with the working classes that white labour could be utilized for sugar cultivation. Yet from the passing of the act the sugar industry began to decay, no fresh capital was put into it, plantations dwindled down in value 50 to 75%, mills were closed, and the magnificent industry threatened to die out. Sir Samuel Griffith, being converted by these signs of the times from his position that sugar could flourish in the colony without coloured labour, issued on 12th February 1892 his "Manifesto to the People of Queensland," in which he acknowledged that to prevent the collapse of sugar-growing it was necessary to resume the immigration of Polynesians. This manifesto was the forerunner of the 1892 act, which reintroduced Kanaka labour. Since this time there has been no further State legislation on the subject, but the Federal Parliament has dealt with the matter (see above).

Land Legislation.—In Queensland's early days, with the pre-dominance of the squatting class, the lands were freely leased in large blocks for sheep and cattle grazing. The squatter furnished 50% of the public revenue with his rents, and opened up

the great interior by his pioneering enterprise. As, however, population increased, the necessity for the agriculturist arose, and it became requisite to legislate in the interests of the small holder. Successive Queensland Governments have had some of their hardest work in adapting their land legislation to the needs of the community, recent policy being to reduce large estates and place the cultivator on the soil. At separation from New South Wales the holding of land was regulated by Orders in Council, under an Imperial act of 1846: untransferable leases of "runs" for fourteen years were issued, the minimum size of the run was measured in sheep-carrying capacity—4000 sheep being the least number, and £10 the minimum rent. The lessee was able to buy up his holding in blocks of 160 acres at a time, £1 per acre being the minimum price, and was entitled to a renewal of his lease at its expiry. The minimum lease principle shut out the small agriculturist. The first leading acts passed by Queensland were the Crown Lands Alienation Act of 1868, dealing with the settled districts, and the Pastoral Leases Act of 1869, dealing with the unsettled districts—these divisions were fixed by the first-named measure. The "resumption" principle was introduced by the 1868 act: lands in the settled districts were resumed after twelve months from the passing of the measure, and lessees were granted leases of half of their holdings for ten years; the other moiety was thrown open for settlement. The 1869 act granted new leases for twenty-one years at practically the same low rentals, but 10% was added to the rent after each period of seven years; the area of a run was fixed at from 25 to 100 sq. m. This act greatly pleased the squatters. In 1884 the Dutton Act was passed. Its importance lies in its dealings with the 1869 act leases: on their expiry the State resumed from one-quarter to one-half of the area as crown lands, which were thrown open to selectors, and new leases of from ten to fifteen years were granted for the balance. Grazing farms (20,000 acres) and agricultural farms (1280 acres) were established. This measure was very unpopular with the squatters. With the act of 1897 it forms the basis of the existing land regulations of Queensland. Under the 1897 act the passing of the land into the hands of agriculturists was further marked by the creation of agricultural homesteads (160, 320, or 640 acres), grazing homesteads (20,000 acres), scrub selections (10,000 acres), and unconditional selections (1280 acres). Some of these classes of selections could be purchased right out, and all were leased at extremely moderate rates. Sales of country lands were established. Two measures were passed, in 1894 and 1897—the Agricultural Lands Purchases Acts—under which the State was authorized to purchase suitable estates of specially fertile land already alienated, to be cut up and thrown open as agricultural farms. These measures confirmed Queensland's determination to encourage agriculture. Owing to the expiration of pastoral leases and the fact that no legislation existed for their renewal for a term long enough to encourage the investment of capital, a formidable agitation prevailed in the colony, the lessees bitterly complaining of the uncertainty of their tenure. The British Australasian Society was formed in Great Britain, to protect the interests of British capital invested in the pastoral industry in Queensland. In 1900, out of the total Queensland area of 427,838,080 acres, no less than 411,793,786 acres remained in the hands of the State unalienated. (J. T. Cr.)

QUEENSTOWN, a town of the Cape province, South Africa, in the upper valley of the Great Kei river, 155 m. by rail N.W. of East London. Pop. (1904) 9616, of whom 4157 were white. Founded in 1853 and named after Queen Victoria, it was laid out in an unusual form. From each angle of a central hexagonal-shaped open space there runs one of the main thoroughfares. This arrangement was adopted to facilitate defence in case of an attack by Kaffirs, Queenstown at the time of its foundation being a border settlement. Up to 1868 the burghers held their lands on a military tenure. It contains several fine buildings, including the town hall, court-house and public offices and the Anglican church of St Michael. Many of the streets are lined with oaks and blue gums. Situated on the Karroo, at an elevation of 3500 ft., between the Stormberg and Amatola Mountains, it is the centre of a wheat and sheep-rearing district, and is a busy commercial town. The climate is healthy, and Queenstown has a reputation as a sanatorium.

QUEENSTOWN, a town of Montagu county, Tasmania, on the Queen river, 23 m. by rail by Strahan, and 353 m. W. of Hobart. It is the centre of the Mount Lyell mining district and has numerous smelting works, brick-works, and sawmills. The county is mountainous and finely wooded. Pop. (1901) 5051; of the district, 10,451.

QUEENSTOWN (formerly COVE OF CORK), a seaport, watering-place, and naval station of county Cork, Ireland, picturesquely situated on the south side of Great Island, on the slope of an

eminence rising abruptly above Cork Harbour. Pop. (1901) 7909. It is 12 m. E.S.E. of Cork and 177 m. S.W. of Dublin by the Great Southern & Western railway. It consists chiefly of terraces rising one above another with wide streets and handsome houses. On account of the mildness of the climate it is frequented by visitors both in summer and winter. Previous to the American War, Cove of Cork was a small fishing village, but it subsequently increased rapidly. It received its present name on the occasion of the visit in 1849 of Queen Victoria, being her first landing-place in Ireland. The town is governed by an urban district council. The harbour, which is defended by the Carlisle and Camden Forts at its entrance, and by Fort Westmoreland on Spike Island, can shelter a large fleet. Spike, Rocky and Haulbowline islands are used in the formation of a government dockyard, which with the adjoining victualling yard covers an area of 55 acres. There is an enclosed basin 9 acres in extent, with 32 ft. 8 in. depth over the sill at high-water spring tides; and a dry dock at its southern end has a length of 408 ft. on the blocks. Queenstown is a port of call for American mail steamers, and the mails are transmitted overland by express trains; it is also a port of embarkation for colonial troops, and a government emigration station. The admiral's flagship is stationed here. The oldest yacht club in the United Kingdom, the Royal Cork (founded in 1720 as the Cork Harbour Water Club), has its headquarters here, with a club-house, and holds an annual regatta. Among the principal buildings are the modern Catholic cathedral of St Colman for the diocese of Cloyne, designed by A. W. Pugin, and the Protestant Episcopal church for the united parishes of Clonmel and Temple Robin. A fine promenade, over a mile in length, connects Queenstown with Rushbrook, a favourite watering-place. The picturesque shores of the harbour are dotted with country residences and village-resorts, such as Crosshaven and Church Bay.

QUELPART (CHAI-JU), an island to the south of Korea, used as a Korean penal settlement. In measures 40 m. from E. to W. and 17 from N. to S. It rises gradually from the seaboard, is heavily wooded and is cleared for cultivation to a height of 2000 ft. There are several crateriform hills, and Hali San (Mount Auckland) has an altitude of 6558 ft. The island is entirely volcanic, and the soil is finely disintegrated lava. Broken black lava forms the beach, and blocks of it are the universal building material. There is no good drinking water. The flora and fauna are scarcely investigated. Pines of three species, junipers, larches, oaks, maples, willows and the *Thuja Orientalis* have been identified. The known fauna comprise boars, bears, deer, swans, geese, pheasants and quail. The roads are scarcely passable bridle tracks. Quelpart was introduced to European notice by the Dutchman, Hendrik Hamil, who was shipwrecked there in 1653.

The estimated population is 100,000, Korean by race, language and costume. There are about ninety villages. The valleys and slopes are carefully cultivated in fields divided by stone walls, and produce beans, peas, sweet potatoes, "Russian turnip radish," barley, a little rice and millet, the last being the staple article of diet. Nuts, oranges, limes and plums are grown. Small but strong ponies are bred for export, and small cattle and pigs for home use. Apart from agriculture, the industries consist in the manufacture of fine bamboo hats and mats, and wooden combs for export and local use. For fishing the islanders use double-decked raft boats, similar to those of southern Formosa. Their lucrative pearl fisheries have been practically monopolized by the Japanese, who use proper diving apparatus. A valuable product is a species of clam, the shell of which furnishes a specially iridescent mother-of-pearl, which the natives barter with the Japanese for inlaying lacquer. European goods are not imported, but Japanese articles find ready barter. There are no markets, and only a few poor shops.

Chu-sung, the capital and seat of government, a few miles from Port Pelto, has a black lava wall 25 ft. high, with three gates and towers; an imposing audience-hall in Chinese style;

and a great bell tower, with a fine bronze bell, sounded to drive off "evil dragons." Its population is estimated at 16,000. The governor has a hereditary army for coercive purposes. The uniform is a complete suit of mail, with a helmet, from which leather curtains fall over the shoulders. The weapons are equally antique.

There are no good harbours, and the only anchorage for large vessels is Tai-chung, or Yung-su, at the east end, with 9 to 13 fathoms of water. Pelto has ancient breakwaters for the protection of small boats, erected, as many believe, by the Mongol conqueror, Kublai Khan, who in 1273 built on Quelpart one hundred ships for the invasion of Japan.

QUENSTEDT, FRIEDRICH AUGUST VON (1809-1889), German geologist and palaeontologist, was born at Eisleben in Saxony on the 9th of July 1809. He was educated at Berlin, and after having acted as assistant in the mineralogical museum he was appointed professor of mineralogy and geognosy in the university of Tübingen in 1837, a post which he occupied until his death. His earlier work related chiefly to crystallography and mineralogy, on which subjects he published text-books that were widely used. He became distinguished for his researches on palaeontology, and especially for those on the fossils of the Jurassic system. The museum at Tübingen owed its establishment to his exertions. He died at Tübingen on the 21st of December 1889.

His chief publications were: *Method der Krystallographie* (1840); *Das Flözgebirge Württembergs* (1843); *Petrefactenkunde Deutschlands* (7 vols. and atlases, 1846-84); *Die Cephalopoden* (1846-49); *Handbuch der Petrefactenkunde* (2 vols., 1852, 3rd ed. 1882-85); *Der Jura* (2 vols., 1858); *Handbuch der Mineralogie* (1855, 3rd ed. 1877); *Die Ammoniten des Schwäbischen Jura* (1883-84). Obituary by W. T. Blandford, *Quart. Journ. Geol. Soc.* vol. xlvii., 1890.

QUENTAL, ANTHERO DE (1842-1891), Portuguese poet, was born on the island of St Michael, in the Azores, on the 18th of April 1842. He studied at the university of Coimbra, and soon distinguished himself by unusual talent, as well as turbulence and eccentricity. He began to write poetry at an early age, chiefly, though not entirely, devoting himself to the sonnet. After the publication of one volume of verse, he entered with great warmth into the revolt of the young men which dethroned Castilho, the chief living poet of the elder generation, from his place as dictator over modern Portuguese literature. He then travelled, engaged on his return in political and socialistic agitations, and found his way through a series of disappointments to the mild pessimism, a kind of Western Buddhism, which animates his latest poetical productions. His melancholy was increased by a spinal disease, which after several years of retirement from the world, eventually drove him to suicide in his native island, on the 11th of September 1891. Anthero stands at the head of modern Portuguese poetry after João de Deus. His principal defect is monotony—his own self is his solitary theme, and he seldom attempts any other form of composition than the sonnet. On the other hand, few poets who have chiefly devoted themselves to this form have produced so large a proportion of really exquisite work. The comparatively few pieces in which he either forgets his doubts and inward conflicts, or succeeds in giving them an objective form, are among the most beautiful in any literature. The purely introspective sonnets are less attractive, but equally finely wrought, interesting as psychological studies, and impressive from their sincerity. His mental attitude is well described by himself as "the effect of Germanism on the unprepared mind of a Southerner." He had learned much, and half-learned more, which he was unable to assimilate, and his mind became a chaos of conflicting ideas, settling down into a condition of gloomy negation, save for the one conviction of the vanity of existence, which ultimately destroyed him. A healthy participation in public affairs might have saved him, but he seemed incapable of entering upon any course that did not lead to delusion and disappointment. The great popularity acquired, notwithstanding, by poetry so metaphysical and egotistic is a testimony to the artistic instinct of the Portuguese.

As a prose writer Quental displayed high talents, though he

wrote little. His most important prose work is the *Considerações sobre a philosophia da historia literaria Portuguesa*, but he earned fame by his pamphlets on the Coimbra question, *Bom senso e bom gosto*, a letter to Castilho, and *A dignidade das letras e litteraturas officiaes*.

His friend Oliveira Martins edited the Sonnets (Oporto, 1886), supplying an introductory essay; and an interesting collection of studies on the poet by the leading Portuguese writers appeared in a volume entitled *Anthero de Quental*. In *Memoriam* (Oporto, 1896). The sonnets have been turned into most European languages; into English by Edgar Prestage (*Anthero de Quental, Sixty-four Sonnets*, London, 1894), together with a striking autobiographical letter addressed by Quental to his German translator, Dr Storck.

QUÉRARD, JOSEPH MARIE (1797–1865), French bibliographer, was born at Rennes on the 25th of December 1797. He was apprenticed to a bookseller in his native town, and was sent abroad on business. He remained in Vienna from 1819 to 1824, and there drew up the first volumes of his great work, *La France littéraire, ou Dictionnaire bibliographique des savants, historiens, et gens de lettres de la France, &c.* (10 vols., 1826–1842), dealing especially with the 18th and early 19th centuries, which he was enabled to complete by a government subsidy granted by Guizot in 1830, and by the help of the Russian bibliophile Serge Poltoratzky. The firm of Didot, who were his publishers, took out of his hands the *Littérature française contemporaine* with which he had intended to complete his work, and placed it with Ch. Louandre and F. Bourquelot. Quérard avenged himself by pointing out the errors of his successors. In spite of his claims Quérard was unable to secure a position in any of the public libraries. He died in Paris on the 3rd of December 1865.

Among his other works are: *Les supercheries littéraires dévoilées* (5 vols., 1845–56); *Bibliographie La Ménaisienne* (1849); *Dictionnaire des ouvrages-polyonymes et anonymes de la littérature française, 1700–1850* (1846–47); an additional volume to *La France littéraire* entitled *Ecrivains pseudonymes, &c.* (1854–56). See Mar. Jozon d'Erquar, *Quérard*, in *La France littéraire* (1854), vol. xi.

QUERCITRON, a yellow dyestuff obtained from the bark of the quercitron oak, *Quercus tinctoria*, a fine forest tree indigenous in North America. The name is a shortened form of "quercitron," from Lat. *quercus*, oak, and "citron," and was invented by Dr Edward Bancroft (1744–1821), who by act of parliament in 1785 was granted special privileges in regard to the importation and use of the substance. The dyestuff is prepared by grinding the bark in mills after it has been freed from its black epidermal layer, and sifting the product to separate the fibrous matter, the fine yellow powder which remains forming the quercitron of commerce. The ruddy-orange decoction of quercitron contains quercitannic acid, whence its use in tanning, and an active dyeing principle, quercitrin, $C_{21}H_{22}O_{12}$. The latter substance is a glucoside, and in aqueous solution under the influence of mineral acids it yields quercetin, $C_{15}H_{10}O_7$, which is precipitated, and the pentoside rhamnose. Quercetin is a crystalline powder of a brilliant citron yellow colour, entirely insoluble in cold and dissolving only sparingly in hot water, but quite soluble in alcohol. Either by itself or in some form of its glucoside quercitrin, quercetin is found in several vegetable substances, among others in cutch, in Persian berries (*Rhamnus catharticus*), buckwheat leaves (*Polygonum Fagopyrum*), Zante fustic wood (*Rhus Cotinus*), and in rose petals, &c. Quercitron was first introduced as a yellow dye in 1775, but it is principally used in the form of flavin, which is the precipitate thrown down from a boiling decoction of quercitron by sulphuric acid. Chemically, quercetin is a member of a fairly extensive class of natural colouring matters derived from β phenyl benzo- γ -pyrone or flavone, the constitution of which followed on the researches of St von Kostanecki, A. G. Perkin, Herzig, Goldschmidt and others. Among the related colouring matters are: chrysin from poplar buds, apigenin from parsley, luteolin from weld and dyers' broom, fisetin from young fustic and yellow cedar, galangin from galanga root, and myricetin from *Myrica Nagi*.

QUERCY (Lat. *pagus Caturcinus*, Fr. *Cahorsin*), a county in France before the Revolution. The name is taken from that of a Gallic tribe, the Cadurci, and was applied to a small

district watered by the Dordogne, the Lot and the Tarn. It was bordered by Limousin, Rouergue, Armagnac, Périgord and Agenais. In the middle ages it was divided into upper, or black, Quercy, and lower, or white, Quercy, the capital of the former being Cahors and of the latter Montauban. Its two other chief towns were Figeac and Moissac. Ecclesiastically it was included almost entirely in the diocese of Cahors until 1317, when a bishopric for lower Quercy was established at Montauban. Judicially it was under the authority of the *parlement* of Bordeaux; for financial purposes it was part of the *généralité* of Montauban. The estates of the county had the bishop of Cahors for president; other members were the bishop of Montauban and other ecclesiastics, four viscounts, four barons and some other lords and representatives of eighteen towns.

Under the Romans Quercy was part of *Aquitania prima*, and Christianity was introduced therein during the 4th century. Early in the 6th century it passed under the authority of the Franks, and in the 9th century was part of the Frankish kingdom of Aquitaine. At the end of the 10th century its rulers were the powerful counts of Toulouse. During the wars between England and France in the reign of Henry II., the English placed garrisons in the county, and by the treaty of Paris in 1259 lower Quercy was ceded to England. Both the king of England and the king of France confirmed and added to the privileges of the towns and the district, each thus hoping to attach the inhabitants to his own interest. In 1360, by the treaty of Brétigny, the whole county passed to England, but in 1440 the English were finally expelled. In the 16th century Quercy was a stronghold of the Protestants, and the scene of a savage religious warfare. The civil wars of the reign of Louis XIII. centred around Montauban. Quercy was early an industrial district. It gave its name to *cadurcum*, a kind of light linen, and the bankers of Cahors were famous.

QUERÉTARO, a city of Mexico, capital of the state of Querétaro-Arteaga, 152 m. by rail N.W. of the national capital. Pop. (1900) 33,152, including a large Indian element. Querétaro is served by the Mexican Central railway. The city stands on a plain at the foot of the Cerro de las Campanas, 6168 ft. above sea-level. Among the important buildings are the Cathedral (said to have been built originally about 1535, and subsequently restored at various times), the Iturbide theatre (in which occurred the trial of Maximilian), the government offices, the federal palace and the churches of Santa Rosa, Santa Clara and San Augustin. The federal palace and the church of Santa Rosa are examples of the work of the celebrated Mexican architect, Francisco Eduardo de Trenguerras (1765–1833), who restored the church of Santa Clara also. The gilded wood carvings of Santa Clara are noteworthy; and in the courtyard of the federal palace there are other specimens of the same work. The water-supply is brought over a fine aqueduct 5 m. long, dating from 18th century. Among manufactures are cottons, woollens, pottery and ironwares. Querétaro has one of the oldest and largest cotton factories in Mexico, employing about 2000 operatives, and maintaining a small private military force for protection. It was built in the days when brigandage held the whole country in terror, and was strongly fortified and provided with artillery and garrison. The latter was also used to escort pack trains of goods and supplies before the building of the railway. This old factory has also played its part in the civil wars of the country since 1840, becoming a fortress whenever Querétaro became involved in military operations.

Querétaro occupies the site of an Otomic Indian town dating from about 1400. It was captured by the Spaniards in 1531 and was raised to the rank of a city in 1655. It was the scene of a revolutionary outbreak against Spain in 1810. In 1848 a Mexican congress met here to ratify the treaty of peace with the United States, and in 1867 Querétaro was the scene of Maximilian's last stand against the republicans (under Escobedo), which resulted in his capture and subsequent execution on the Cerro de las Campanas just N. of the city.

QUERÉTARO-ARTEAGA, a central state of Mexico, bounded N. by San Luis Potosí, E. by Hidalgo, S.E. by the state of Mexico, S. by Michoacan and W. by Guanajuato; area, 3556 sq. m. Pop. (1900) 232,389, largely Indian. The state belongs to the elevated plateau region, with its semi-arid conditions. The N. part of the state is traversed from E. to W. by the wooded Sierra Gorda, whose spurs reach southward to the central districts. The central and S. parts are covered by plains, broken by low hills. The rivers are small and flow chiefly to the San Juan, a part of the Panuco drainage basin. There are some small lakes and swamps and a number of mineral springs. Sugar, cotton, Indian corn, beans and considerable quantities of wheat are grown, but agriculture is largely hampered by the uncertainty of the rainfall. The chief wealth of the state is in its mines. Silver, gold, copper, mercury, lead, tin, antimony and precious stones are found, in some cases in very rich deposits. The richest mining districts are those of Cadereyta and Tolimán, where there are metallurgical works for the reduction of ores. The Mexican Central and Mexican National railways cross the S. end of the state and afford transportation facilities for the agricultural districts, but the mining districts of the N. are still dependent upon old methods. The capital of the state is the historic city of Querétaro (*q.v.*), and other important towns, with their populations in 1900, are: San Juan del Rio (8124), Landa (about 7000), Ahuacatlan (5929 in 1895), Jalpan (about 6000), and Tolimán, celebrated for its opals.

QUERFURT, a town of Germany, in the province of Prussian Saxony, situated in a fertile country on the Querne, 18 m. W. from Merseburg, on a branch line from Oberröblingen. Pop. (1905) 4884. Its chief industries are sugar-refining, lime-burning and brewing. Querfurt was for some time the capital of a principality which had an area of nearly 200 sq. m. and a population of about 20,000. The ruling family having become extinct in 1496, it passed to that of Mansfeld. In 1635, by the peace of Prague, it was ceded to the elector of Saxony, John George I., who handed it over to his son Augustus of Saxe-Weissenfels; but in 1746 it was again united with electoral Saxony. It was incorporated with Prussia in 1815.

See Schneider, *Querfurter Stadt- und Kreischronik* (Querfurt, 1902).

QUERN, the primitive form of hand-mill for grinding corn, consisting of two flat circular stones; the lower stone, often shaped with a rim, has a wooden or metal pin in the centre which passes through a hole in the upper stone; the worker pours the grain through the hole with one hand, revolving the upper stone with the other by means of a peg fixed to one side. The Old English word is *cweorn*; it is a word common to Teutonic languages, cf. Du. *kweern*, Swed. *quarn* and various forms in Old German; cognate words are found in Slavonic languages pointing to a pre-Aryan root. It is not related to "churn." (See FLOUR.)

QUESADA Y MATHEUS, JENARO DE (1818-1889), 1ST MARQUIS OF MIRAVALLS, Spanish soldier, was born at Santander, on the 6th of February 1818. He was a son of General Vicente Quesada, a Conservative officer who was murdered and atrociously mutilated in the streets of Madrid by a revolutionary mob in the early days of Queen Isabella's reign. As Quesada belonged to an ancient family connected with the dukes of Fernan Nuñez, he was made a cornet when only six years old, was educated at the seminary for nobles and in 1833 was promoted lieutenant in the 1st Foot Guards. He served from 1833 to 1836 against the Carlists. When his father was assassinated in 1836 he resigned, went to France, got employment in a merchant's office and was only induced to return to the army in 1837 by his relatives, who got him a company in the guards. He distinguished himself often in the Carlist war, but his promotion was slow, and he declined to have anything to do with politics. He confined himself to his duties as a soldier, always fighting on the side of governments against Carlist, Republican and Progressist risings. He only became a general of division in 1853, and at the head of the Madrid garrison he fought hard in 1854 to avert the

triumph of Espartero, O'Donnell and Dulce, who publicly recognized his gallant conduct. When the war in Morocco broke out, Marshal O'Donnell gave Quesada the command of a division, which played so conspicuous a part in that campaign and at the battle of Wad el Ras that its commander was made lieutenant-general and grand cross of Charles III. He was director-general of the Civil Guard when the military rebellion of the 22nd of June 1866 broke out in Madrid, and after he had been wounded in the leg he remained at the head of the loyal troops until the insurgents were crushed. He did not accept any military post during the revolution until Marshal Serrano in 1874 offered him the direction of the staff, and he only accepted it after clearly stating that he was a royalist and partisan of Alfonso XII. In his long and brilliant career he never swerved from his steadfast resolve never to be mixed up in any political or military intrigues or pronunciamientos—to use his own words, "not even to restore my king." As soon as the king was restored, the government of Señor Canovas made Quesada first general-in-chief of the army of Central Spain, and in February 1875 general-in-chief of the army of the North. With the assistance of another officer who also had never dabbled in pronunciamientos, General O'Ryan, Quesada restored discipline in the armies confronting Don Carlos, and for twelve months concerted and conducted the operations that forced the pretender to retire into France and his followers to lay down their arms. The government confided to the marquis of Miravalles the difficult task of ruling the northern provinces for several years after the war, and he succeeded in conciliating the sympathies of the Basques and Navarrese, though the penalty of their last rising had been the loss of most of their ancient liberties or *fueros*. Quesada was made marquis of Miravalles, grandee after the war, minister of war in 1883 and senator. Though he was a strict, stern disciplinarian of the old school and an unflinching Conservative, Catholic and royalist, even his political and military opponents respected him, and were proud of him as an unblemished type of the Castilian soldier and gentleman. He died at Madrid on the 19th of January 1889, and was given full military honours. (A. E. H.)

QUESNAY, FRANÇOIS (1694-1774), French economist, was born at Mérey, near Paris, on the 4th of June 1694, the son of an advocate and small landed proprietor. Apprenticed at the age of sixteen to a surgeon, he soon went to Paris, studied medicine and surgery there, and, having qualified as a master-surgeon, settled down to practice at Mantes. In 1737 he was appointed perpetual secretary of the academy of surgery founded by François la Peyronie, and became surgeon in ordinary to the king. In 1744 he graduated as a doctor of medicine; he became physician in ordinary to the king, and afterwards his first consulting physician, and was installed in the palace of Versailles. His apartments were on the *entresol*, whence the *Réunions de l'entresol* received their name. Louis XV. esteemed Quesnay much, and used to call him his thinker; when he ennobled him he gave him for arms three flowers of the pansy (*pensée*), with the motto *Propter excogitationem mentis*.

He now devoted himself principally to economic studies, taking no part in the court intrigues which were perpetually going on around him. About the year 1750 he became acquainted with Jean C. M. V. de Gournay (1712-1759), who was also an earnest inquirer in the economic field; and round these two distinguished men was gradually formed the philosophic sect of the *Économistes*, or, as for distinction's sake they were afterwards called, the *Physiocrates*. The most remarkable men in this group of disciples were the elder Mirabeau (author of *L'Ami des hommes*, 1756-60, and *Philosophie rurale*, 1763), Nicolas Baudeau (*Introduction à la philosophie économique*, 1771), G. F. Le Trosne (*De l'ordre social*, 1777), André Morellet (best known by his controversy with Galiani on the freedom of the corn trade), Mercier Larivière and Dupont de Nemours. Adam Smith, during his stay on the continent with the young duke of Buccleuch in 1764-66, spent some time in Paris, where he made the acquaintance of

Quesnay and some of his followers; he paid a high tribute to their scientific services in his *Wealth of Nations*. Quesnay died on the 16th of December 1774, having lived long enough to see his great pupil, Turgot, in office as minister of finance. He had married in 1718, and had a son and a daughter; his grandson by the former was a member of the first Legislative Assembly.

The publications in which Quesnay expounded his system were the following:—two articles, on "Fermiers" and on "Grains," in the *Encyclopédie* of Diderot and D'Alembert (1756, 1757); a discourse on the law of nature in the *Physiocratie* of Dupont de Nemours (1768); *Maximes générales de gouvernement économique d'un royaume agricole* (1758), and the simultaneously published *Tableau économique avec son explication, ou extrait des économies royales de Sully* (with the celebrated motto, "Pauvres paysans, pauvre royaume; pauvre royaume, pauvre roi"); *Dialogue sur le commerce et les travaux des artisans*; and other minor pieces. The *Tableau économique*, though on account of its dryness and abstract form it met with little general favour, may be considered the principal manifesto of the school. It was regarded by the followers of Quesnay as entitled to a place amongst the foremost products of human wisdom, and is named by the elder Mirabeau, in a passage quoted by Adam Smith, as one of the three great inventions which have contributed most to the stability of political societies, the other two being those of writing and of money. Its object was to exhibit by means of certain formulas the way in which the products of agriculture, which is the only source of wealth, would in a state of perfect liberty be distributed among the several classes of the community (namely, the productive classes of the proprietors and cultivators of land, and the unproductive class composed of manufacturers and merchants), and to represent by other formulas the modes of distribution which take place under systems of Governmental restraint and regulation, with the evil results arising to the whole society from different degrees of such violations of the natural order. It follows from Quesnay's theoretic views that the one thing deserving the solicitude of the practical economist and the statesman is the increase of the net product; and he infers also what Smith afterwards affirmed, on not quite the same ground, that the interest of the landowner is "strictly and indissolubly connected with the general interest of the society." A small *édition de luxe* of this work, with other pieces, was printed in 1758 in the palace of Versailles under the king's immediate supervision, some of the sheets, it is said, having been pulled by the royal hand. Already in 1767 the book had disappeared from circulation, and no copy of it is now procurable; but the substance of it has been preserved in the *Ami des hommes* of Mirabeau, and the *Physiocratie* of Dupont de Nemours.

His economic writings are collected in the 2nd vol. of the *Principaux économistes*, published by Guillaumin, Paris, with preface and notes by Eugène Daire; also his *Œuvres économiques et philosophiques* were collected with an introduction and note by Aug. Oncken (Frankfort, 1888); a facsimile reprint of the *Tableau économique*, from the original MS., was published by the British Economic Association (London, 1895). His other writings were the article "Évidence" in the *Encyclopédie*, and *Recherches sur l'évidence des vérités géométriques*, with a *Projet de nouveaux éléments de géométrie*, 1773. Quesnay's *Éloge* was pronounced in the Academy of Sciences by Grandjean de Fouchy (see the *Recueil* of that Academy, 1774, p. 134). See also F. J. Marmontel, *Mémoires; Mémoires de Mme. du Hausset*; H. Higgs, *The Physiocrats* (London, 1897).

QUESNEL, PASQUIER (1634–1719), French Jansenist theologian, was born in Paris on the 14th of July 1634, and, after graduating in the Sorbonne with distinction in 1653, joined the French Oratory in 1657. There he soon became prominent; but his Jansenist sympathies led to his banishment from Paris in 1681. He took refuge with the friendly Cardinal Coislin, bishop of Orléans; four years later, however, foreseeing that a fresh storm of persecution was about to burst, he fled to Brussels, and took up his abode with Antoine Arnauld (*q.v.*). There he remained till 1703, when he was arrested by order of the archbishop of Malines. After three months' imprisonment he made a highly dramatic escape, and settled at Amsterdam, where he spent the remainder of his life. After Arnauld's death in 1694 Quesnel was generally regarded as the leader of the Jansenist party; and his *Réflexions morales sur le Nouveau Testament* played almost as large a part in its literature as Jansen's *Augustinus* itself. As its title betokens, this was a devotional commentary on the Scriptures, wherein Quesnel managed to explain the aims and ideals of the Jansenist party better than any earlier writer had done; and it accordingly became the chief object of Jesuit attack. It appeared in many forms and under various

titles, the original germ going back so far as 1668; the first complete edition was published in 1692. The bull *Unigenitus*, in which no fewer than 101 sentences from the *Réflexions morales* were condemned as heretical, was obtained from Clement IX. on the 8th of September 1713. Quesnel died at Amsterdam on the 2nd of December 1719.

See also Mme. Albert Le Roy, *Un Janseniste en exil* (Paris, 1900; and Maulvault, *Répertoire de Port Royal* (Paris, 1902).

(St. C.)

QUETELET, LAMBERT ADOLPHE JACQUES (1796–1874), Belgian astronomer, meteorologist and statistician, was born at Ghent on the 22nd of February 1796, and educated at the lyceum of that town. In 1819 he was appointed professor of mathematics at the athenaeum of Brussels; in 1828 he became lecturer at the newly created museum of science and literature, and he continued to hold that post until the museum was absorbed in the free university in 1834. In 1828 he was appointed director of the new royal observatory which it had been decided to found, chiefly at his instigation. The building was finished in 1832, and the instruments were ready for work in 1835, from which date the observations were published in 4to volumes (*Annales de l'Observatoire Royal de Bruxelles*), but Quetelet chiefly devoted himself to meteorology and statistics. From 1834 he was perpetual secretary of the Brussels Academy, and published a vast number of articles in its *Bulletin*, as also in his journal, *Correspondance mathématique et physique* (11 vols., 1825–39). He died at Brussels on the 17th of February 1874. His son, ERNEST QUETELET (1825–78), was from 1856 attached to the observatory, and on his death succeeded him as director. He made a great number of observations of stars with proper motion.

Quetelet's astronomical papers refer chiefly to shooting stars and similar phenomena. He organised extensive magnetical and meteorological observations, and in 1839 he started regular observations of the periodical phenomena of vegetation, especially the flowering of plants. The results are given in various memoirs published by the Brussels Academy, and in his works *Sur le climat de la Belgique* and *Sur la physique du globe* (the latter forms vol. xiii. of the *Annales*, 1861). He is, however, chiefly known by the statistical investigations which occupied him from 1823 onward. In 1835 he published his principal work, *Sur l'homme et le développement de ses facultés, ou essai de physique sociale* (2nd ed., 1869), containing a résumé of his statistical researches on the development of the physical and intellectual qualities of man, and on the "average man" both physically and intellectually considered. In 1846 he brought out his *Lettres à S. A. R. le duc régnant de Saxe-Coburg, et Gotha sur la théorie des probabilités appliquée aux sciences morales et politiques* (of which Sir J. Herschel wrote a full account in the *Edinburgh Review*), and in 1848 *Du système social et des lois qui le régissent*. In these works he shows how the numbers representing the individual qualities of man are grouped round the numbers referring to the "average man" in a manner exactly corresponding to that in which single results of observation are grouped round the mean result, so that the principles of the theory of probabilities may be applied to statistical researches on the subjects. These ideas are further developed in various papers in the *Bulletin* and in his *L'Anthropométrie, ou mesure des différentes facultés de l'homme* (1871), in which he lays great stress on the universal applicability of the binomial law,—according to which the number of cases in which, for instance, a certain height occurs among a large number of individuals is represented by an ordinate of a curve (the binomial) symmetrically situated with regard to the ordinate representing the mean result (average height). A detailed *Essai sur la vie et les travaux de L. A. J. Quetelet*, by his pupil and assistant E. Mailly, was published at Brussels in 1875.

QUETTA, the capital of British Baluchistan, India, which also gives its name to a district. It rose to prominence in 1876, when Sir Robert Sandeman founded a residency there. The name is a variation of the word *kwat-kot*, signifying a fortress, and the place is still locally known as Shal Kot. Quetta is the southernmost point in the line of frontier posts and system of strategic railways on the north-west frontier of India, 536 m. by rail N. of Karachi. It forms the headquarters of the fourth division of the southern army, with a strong garrison of all arms. The railway was built in 1879, with a view to its continuance to Kandahar; but its present terminus is New Chaman on the Afghan border. A branch line to Nushki was completed in 1905. The cantonment and

civil station of Quetta stand in the open plain about 5500 ft. above sea-level, within a ring of mountains (such as Takatu, Murdar and Chiltan), which overlook it from a height of over 11,000 ft. To the north-west the view is open across the base of the Pishin valley to the Khojak Pass and Kandahar. Southwards is the open valley leading to the Bolan Pass, traversed by the railway. North of Quetta is the open plain leading to Pishin and the Harnai, also traversed by the Sibi-Pishin railway, which passes through the fortifications. These defensive works, stretching from the base of Takatu to the foot of the Mashelak hills on the west, bar the way to advance from the Khojak Pass. During the last quarter of the 19th century Quetta grew from a dilapidated group of mud buildings, with an inferior bazaar and a few scattered remnants of neglected orchard cultivation, into a strong fortress, and one of the most popular stations of the Indian army. Quetta was visited by the prince of Wales (George V.) in 1906, and a staff college for the Indian army was opened here in 1907. It has become the trade mart for western Afghanistan, eastern Persia, and much of central Asia. The population of the town and cantonment in 1901 was 24,584.

The DISTRICT OF QUETTA (including Pishin) has an area of 5127 sq. m. Pop. (1901) 114,087, of whom more than three-fourths are Afghans, showing an increase of 45% in the decade. The general aspect of the country is hilly, rocky and sterile, particularly towards the north; but in many parts the soil is rich and good, yielding wheat, rice, madder, tobacco, and lucerne, besides numerous grasses. The district has abundant orchards, furnishing grapes, apples, pears, pomegranates, figs, &c.; melons and all kinds of English vegetables are also largely cultivated. The valley is watered by the Pishin Lora and by government irrigation works, including artesian wells. Wild sheep and goats abound in the hills of the district. The climate appears to be healthy and the temperature moderate, ranging from 40° F. in the winter to about 78° in the summer. The annual rainfall (including snow) averages about 10 in. The actual line of valley which contains Quetta and the Bolan Pass was originally rented from the khan of Kalat on terms which were changed in 1882 to a quit-rent of Rs25,000 per annum, and a further compensation of Rs30,000 in lieu of transit duties in the Bolan Pass. This perpetual leasehold was afterwards extended so as to include Nushki and give the British government the command of the trade route to Sistan. The Quetta district is now administered, together with the assigned districts of Pishin, Tal Chotiali, and Sibi (assigned by the treaty of Gandamak as being nominally Afghan territory) by a regular staff of civil officials.

See Thornton, *Life of Sir Robert Sandeman* (London, 1896); *Quetta-Pishin District Gazetteer* (Ajmer, 1907). (T. H. H.*)

QUEUE or **CUE** (from Fr. *queue*, O. Fr. *cue*, Lat. *cauda*, tail), a tail of hair, either of the natural hair when so worn or of a wig, plaited together and tied with ribbon, hanging down the back of the neck. In Europe and European colonies and settlements this method of wearing the hair prevailed after the heavy periwig had gone out of fashion. The bob-wig or tie-wig with the queue survives in the English barrister's wig. In the second half of the 18th century the queue was worn thick and short and sometimes encased in leather, when it was termed a "club." In the navy and army the queue survived its disuse in civil life. The three pieces of black velvet sewn on to the collar of the full dress tunic of the officers of the Royal Welsh Fusiliers, and styled the "flash," are said to be a relic of the ribbon which tied the queue. The most familiar use of this fashion of wearing the hair is the pigtail of the Manchus, which was imposed on all Chinese men as a symbol of loyalty and obedience at the conquest of China (see CHINA: *Social Life*). A particular meaning of the word is for the line of persons formed in order awaiting their turn for admission to a theatre or other place. This appears also in French, from which it is borrowed. In the form "cue" (Fr. *queue*) the word is used of the tapering, striking implement in the game of billiards (*q.v.*). It is often stated that the theatrical

use of "cue" for the concluding words of an actor's dialogue or speech which marks the beginning of another actor's part is merely an adaptation of the meaning "tail." The *New English Dictionary* points out that there is no trace of this use in French. In 16th and 17th century plays the endings of parts are marked Q. or qu-, which has been taken to represent Lat. *quando*, when.

QUEVEDO Y VILLEGAS, FRANCISCO GÓMEZ DE (1580-1645), Spanish satirist and poet, was born at Madrid, where his father, who came from the mountains of Burgos, was secretary to Anne of Austria, fourth wife of Philip II. Early left an orphan, Quevedo was educated at the university of Alcalá, where he acquired a knowledge of classical and modern tongues—of Italian and French, Hebrew and Arabic, of philosophy, theology, civil law, and economics. His fame reached beyond Spain; at twenty-one he was in correspondence with Justus Lipsius on questions of Greek and Latin literature. His abstruse studies influenced Quevedo's style; to them are due the pedantic traits and mania for quotations which characterize most of his works.

He betook himself to the court and mingled with the society that surrounded Philip III. The cynical greed of ministers, the meanness of their flatterers, the corruption of the royal officers, the financial scandals, afforded ample scope to Quevedo's talent as a painter of manners. At Valladolid, where the court resided from 1601 to 1606, he mingled freely with these intrigues and disorders, and lost the purity of his morals but not his uprightness and integrity. In 1611 he fought a duel in which his adversary was killed, fled to Italy, and later on became secretary to Pedro Téllez Girón, duke de Osuna, and viceroy of Naples. Thus he learned politics—the one science which he had perhaps till then neglected,—initiated himself into the questions that divided Europe, and penetrated the ambitions of the neighbours of Spain, as well as the secret history of the intriguers protected by the favour of Philip III. The result was that he wrote several political works, particularly a lengthy treatise, *La Política de Dios* (1626), in which he lays down the duties of kings by displaying to them how Christ has governed His church. The disgrace of Osuna (1620) compromised Quevedo, who was arrested and exiled to his estate at La Torre de Juan Abad in New Castile. Though involved in the process against the duke, Quevedo remained faithful to his patron, and bore banishment with resignation. On the death of Philip III. (31st of March 1621) he recommended himself to the first minister of the new king by celebrating his accession to power and saluting him as the vindicator of public morality in an epistle in the style of Juvenal. Olivares recalled him from his exile and gave him an honorary post in the palace, and from this time Quevedo resided almost constantly at court, exercising a kind of political and literary jurisdiction due to his varied relations and knowledge, but especially to his biting wit, which had no respect for persons. General politics, social economy, war, finance, literary and religious questions, all came under his dissecting knife, and he had a dissertation, a pamphlet, or a song for everything. One day he is defending St James, the sole patron of Spain, against a powerful coterie that wished to associate St Theresa with him; next day he is writing against the duke of Savoy, the hidden enemy of Spain, or against the measures taken to change the value of the currency; or once more he is engaged with the literary school of Góngora, whose affectations seem to him to sin against the genius of the Castilian tongue. And in the midst of this incessant controversy on every possible subject he finds time to compose a picaresque romance, the *Historia de la Vida del Buscón, llamado Don Pablos, Exemplo de Vagamundos, y Espejo de Tacaños* (1626); to write his *Sueños* (1627), in which all classes are flagellated; to pen a dissertation on *The Constancy and Patience of Job* (1631), to translate St Francis de Sales and Seneca, to compose thousands of verses, and to correspond with Spanish and foreign scholars.

But Quevedo was not to maintain unscathed the high position won by his knowledge, talent, and biting wit. The government

of Olivares, which he had welcomed as the dawn of a political and social regeneration, made things worse instead of better, and led the country to ruin. Quevedo saw this and could not hold his peace. An anonymous petition in verse enumerating the grievances of his subjects was found, in December 1639, under the very napkin of Philip IV. It was shown to Olivares, who exclaimed, "I am ruined"; but before his fall he sought vengeance on the libeller. His suspicions fell on Quevedo, who had enemies glad to confirm them. Quevedo was arrested on December 7, and carried under a strong escort to the monastery of St Mark at Leon, where he was kept in rigorous confinement till the fall of the minister (January 1643) restored him to light and freedom, but not to the health which he had lost in his dungeon. He had little more than two years to live, and these were spent in inactive retreat, first at La Torre de Juan Abad, and then at the neighbouring Villanueva de los Infantes, where he died September 8, 1645.

As a satirist and humorist Quevedo stands in the first rank of Spanish writers; his other literary work does not count for much. I. I. Chifflet, in a letter of February 2, 1629, calls him "a very learned man to be a Spaniard," and indeed his erudition was of a solid kind, but he merits attention not as humanist, philosopher, and moralist, but as the keen polemic writer, the pitiless mocker, the profound observer of all that is base and absurd in human nature, and at the same time as a finished master of style and of all the secrets of the Spanish tongue. His style, indeed, is not absolutely pure; though he ridiculed so well the bad taste of *culleranism*, he fell himself into the style called *conceptismo*, which strains after ambiguous expressions and alembicated "points." But, though involved and overcharged with ideas, his diction is of singular force and originality; after Cervantes he is the greatest Spanish prose writer of the 17th century.

There is an excellent collected edition of Quevedo's prose works with a good life of the author by D. Aureliano Fernandez-Guerra (*Bibl. Ribadeneyra*, vols. xxiii. and xlvi.); his poetical works in vol. lxix. of the same collection are badly edited by D. Florencio Janer. There is a second edition, enlarged and annotated by Señor Menéndez y Pelayo. E. Mérimée, in *Essai sur la vie et les œuvres de Francisco de Quevedo* (Paris, 1886), has supplied an excellent critical and biographical monograph with a bibliography. (J. F.-K.)

QUEZAL, or **QESAL**, the Spanish-American name for one of the most beautiful of birds, abbreviated from the Aztec or Maya *Quetzal-tototl*, the last part of the compound word meaning fowl, and the first, also written *Cuetzal*, the long feathers of rich green with which it is adorned.¹ The Quetzal is one of the Trogons (*q.v.*), and was originally described by Hernandez (*Historia*, p. 13), whose account was faithfully copied by F. Willughby. Yet the bird remained practically unknown to ornithologists until figured in 1825, from a specimen belonging to Leadbeater,² by C. J. Temminck (*Pl. col.*, 372), who, however, mistakenly thought it was the same as the *Trogon pavoninus*, a congeneric but quite distinct species from Brazil, that had just been described by Spix. The scientific determination of the Quetzal-bird of Central America seems to have been first made by C. L. Bonaparte in 1826, as *Trogon paradiseus*, according to his statement in the Zoological Society's *Proceedings*

¹ The Mexican deity Quetzal-coatl had his name, generally translated "Feathered Snake," from the *quetzal*, feather or bird, and *coatl*, snake, as also certain kings or chiefs, and many places, e.g. Quetzalapan, Quetzaltepec, and Quetzaltenango, though perhaps some of the last were named directly from the personages (cf. Bancroft, *Native Races of the Pacific States*, vol. v., Index). Quetzal-itzli is said to be the emerald.

² This specimen had been given to Canning (a tribute, perhaps, to the statesman who boasted that he had "called a New World into existence to redress the balance of the Old") by Mr Schenley, a diplomatist, and was then thought to be unique in Europe; but, apart from those which had reached Spain, where they lay neglected and undescribed, James Wilson says (*Illustr. Zoology*, pl. vi. text) that others were brought with it, and that one of them was given to the Edinburgh Museum. On the 21st day of the sale of Bullock's Museum in 1819, Lot 38 is entered in the Catalogue as "The Tail Feather of a magnificent undescribed Trogon," and probably belonged to this species.

for 1837 (p. 101); but it is not known whether the fact was ever published. In 1832 the *Registro Trimestre*, a literary and scientific journal printed at Mexico, contained a communication by Dr. Pablo de la Llave, describing this species (with which he first became acquainted before 1810, from examining more than a dozen specimens obtained by the natural-history expedition to New Spain and kept in the palace of the Retiro near Madrid) under the name by which it is now known, *Pharomacrus mocino*.³



Quetzal, male and female.

These facts, however, being almost unknown to the rest of the world, J. Gould, in the *Zoological Proceedings* for 1835 (p. 29), while pointing out Temminck's error, gave the species the name of *Trogon resplendens*, which it bore for some time. Yet little or nothing was generally known about the bird until Delattre sent an account of his meeting with it to the *Echo du monde savant* for 1843, which was reprinted in the *Revue zoologique* for that year (pp. 163-165). In 1860 the nomenclature of the species, about which strange stories had been told to the naturalist last named, was determined, and its eggs, of a pale

³ De la Llave's very rare and interesting memoir was reprinted by M. Sallé in the *Revue et magasin de zoologie* for 1861 (pp. 23-33).

bluish-green, were procured by Robert Owen (*P. Z. S.*, 1860, p. 374; *Ibis*, 1861, p. 66, pl. ii. fig. 1); while further and fuller details of its habits were made known by O. Salvin (*Ibis*, 1861, pp. 138-140), from his own observation of this very local and remarkable species. Its chief home is in the mountains near Coban in Vera Paz, but it also inhabits forests in other parts of Guatemala at an elevation of from 6000 to 9000 ft.

The Quezal is hardly so big as a Turtle-Dove. The cock has a fine yellow bill and a head bearing a rounded crest of filamentous feathers; lanceolate scapulars overhang the wings, and from the rump spring the long flowing plumes which are so characteristic of the species, and were so highly prized by the natives before the Spanish conquest that no one was allowed to kill the bird when taken, but only to divest it of its feathers, which were to be worn by the chiefs alone. These plumes, the middle and longest of which may measure from 3 ft. to 3½ ft., with the upper surface, the throat, and chest, are of a resplendent golden-green,¹ while the lower parts are of a vivid scarlet. The middle feathers of the tail, ordinarily concealed, as are those of the Peacock, by the uropygials, are black, and the outer white with a black base. In the hen the bill is black, the crest more round and not filamentous, the uropygials scarcely elongated, and the vent only scarlet. The eyes are of a yellowish-brown. Southern examples from Costa Rica and Veragua have the tail-coverts much narrower, and have been considered to form a distinct species, *P. costaricensis*. Among other species are *P. antisianus*, *P. fulgidus*, *P. auriceps* and *P. pavoninus*, from various parts of South America, but though all are beautiful birds, none possess the wonderful singularity of the quezal. (A. N.)

QUEZALTENANGO, the capital of the department of Quezaltenango, Guatemala, 70 m. by road W. of Guatemala city and at the terminus of a railway from Champerico on the Pacific coast. Pop. (1905) about 31,000. It is situated on the river Siguila, and at the foot of the volcano of Santa Maria. In size the second city in the republic, it has a large agricultural trade and manufactures of linen, woollen and cotton goods. It contains a fine cathedral and some good public buildings, including two national institutes for higher education; and it is well supplied with water and electricity for light and power. The majority of its inhabitants are Indians or half-breeds of Quiché descent. Quezaltenango was the capital of a Quiché kingdom, and was known as Xelahun or Xelahun until 1524, when it was conquered by the Spaniards under Pedro de Alvarado. In 1902 it was partially destroyed by an earthquake and an eruption of Santa Maria.

QUIBERON, CAMPAIGN AND BATTLE OF. Quiberon Bay, on the S. coast of Brittany, France, was the scene of the great naval battle which defeated the plan laid by the ministers of King Louis XV. of France, for the invasion of England in 1759, during the Seven Years' War (*q.v.*). An army had been collected at Vannes, in the south-east of Brittany, and transports had been brought together in the landlocked waters of the Morbihan which are connected with Quiberon Bay. The scheme of the French ministers was to combine twenty-one ships of the line lying at Brest under the command of M. de Conflans, with twelve which were to be brought round from Toulon by M. de la Clue. The army was then to be carried to some point on the coast of England or Scotland by the united squadrons. The British government was well informed of its enemy's intentions, and took vigorous measures of defence. Admiral Sir E. Hawke, afterwards Lord Hawke, was directed to blockade Brest with a fleet of twenty-five sail of the line, four ships of fifty guns and nine frigates. The four ships of fifty guns together with four frigates were detached, first under Commodore John Reynolds, and then under Commodore Robert Duff, to lie in Quiberon Bay and watch the entry to the Morbihan. During the whole summer, from the beginning of June, Sir E. Hawke kept his station off Brest, and the detached squadron occupied Quiberon Bay. The task of blockading M. de la Clue at Toulon was given

¹ Preserved specimens, exposed to the light, lose much of their beauty.

to Edward Boscawen, who had with him fourteen sail of the line. Boscawen reached his station on the 16th of May 1759. At the beginning of July want of stores and water, together with the injury inflicted on some of his vessels by a French battery, compelled him to go to Gibraltar to provision and refit. He reached the port on the 4th of August. On the 5th M. de la Clue left Toulon, and on the 17th passed the straits of Gibraltar, where he was sighted by the look-out ships of Boscawen. The British fleet hurried out to sea, and pursued in two divisions, separated by a distance of some miles owing to the haste with which they left port. During the night of the 17th and 18th of August five of M. de la Clue's ships lost sight of his flagship, and steered for Cadiz. The other seven, which had been delayed for a time in the hope of rejoining their consorts, were overtaken by Boscawen and attacked in the afternoon of the 18th. One, the "Centaur" (74), was captured after a very gallant resistance, in which the British flagship was severely damaged. During the night of the 18th-19th of August, two of the French ships altered course to the west, and escaped. The remaining four fled to the north, and into Portuguese waters, where two were driven ashore and destroyed, while two were captured near Lagos. The five in Cadiz were blockaded by Boscawen's second-in-command, Admiral Broderick. La Clue was mortally wounded, and died ashore in Portugal. Although the defeat of his squadron had ruined the scheme for the combination of their forces, the French ministers decided to persevere with the invasion. M. de Conflans was ordered to put to sea. On the 9th of November a severe gale forced Sir E. Hawke from in front of Brest, and as his ships were in want of stores he sailed for Torquay. Finding the way clear, Conflans put to sea on the 14th, and steered for Quiberon. Sir E. Hawke left Torquay to resume his station on the same day. On the 15th he learnt from a look-out ship that the French had been seen at sea to the north-west of Belleisle, and steering south-west. Concluding that they were bound for the Morbihan he followed. Calms and contrary winds prevented either fleet from making much progress till the evening of the 19th, when the French were rather over 60 m. to the south-west of Belleisle, which is south of Quiberon. The wind had now changed to the north-west and was beginning to blow hard. M. de Conflans made for Quiberon under reduced canvas for fear of making the land in the night, the coast being one of the most dangerous in the world, on account of the rocky islands of Houat and Hoedik, and the long string of reefs which lie inside Belleisle. Hawke was steering in the same direction farther out at sea. On the morning of the 20th of November, Conflans was nearing the south point of Belleisle. The small squadron of Commodore Duff, warned of his approach, endeavoured to escape to sea before he could shut them in at Quiberon. One of the ships worked out through the very dangerous passage to the north of Belleisle; the others came round the south of the island, where they were nearly cut off and captured. As the pursuers came close to them the sails of Hawke's fleet were seen rising over the horizon. M. de Conflans immediately called off the pursuers, and endeavoured to form his line of battle. By midday he was able to estimate the full strength of Hawke's fleet of twenty-three sail of the line, which with the four 50-gun ships of Commodore Duff made twenty-seven vessels to his twenty-one. He therefore altered his mind, and decided to run inside the islands of Houat and Hoedik, and gain the anchorage of Quiberon. He concluded that as the day was far advanced and the wind was increasing, the British admiral would not dare to follow him into so dangerous a place. But Sir E. Hawke considered that the circumstances justified him in taking all risks, and seeing his enemy in retreat he ordered a pursuit. As the van of the French led by their admiral was turning inside the Cardinal rocks at the southern end of the reefs, his rear was attacked. The two fleets entered the Bay late in the evening, and there followed a battle unique in naval history, for it was fought in the dark, among rocks, in a severe gale, and on a lee shore. Two of the British liners were wrecked on a rock called the Four, but five of the French were taken or

destroyed, among the latter was the flagship of Conflans, who escaped to the shore on a spar. Seven of the French ships ran into the little river Vilaine, being compelled to throw their guns overboard to lighten themselves before crossing the bar. Nine escaped to the south. The small number of prizes taken gives no measure of the importance of the victory, which broke the spirit and strength of the French fleet so effectually that it did not appear at sea again during the rest of the war, *i.e.* until 1763.

See Beatson's *Naval and Military Memoirs of Great Britain*, vol. ii. p. 321 et seq.; Burrows's *Life of Lord Hawke*; Tronde, *Batailles navales de la France*, vol. i. p. 379 et seq. (D. H.)

QUICHÉ or **KICHÉS**, a tribe of Central American Indians of Mayan stock. They inhabited western Guatemala, where their descendants still survive. They were at the time of the conquest the most powerful of the three Mayan peoples in Guatemala, the other two being the Cakchiquel and the Zutugil. Their chronicles are said to date back to the 8th century. Their sacred book, the *Popol Vuh*, containing a mythological cosmogony, survives in a 17th-century manuscript written by a Christianized Guatemalan. To this tradition may be due the remarkable similarity of the Quiché creation story to that of the Old Testament. Their capital was Utatlan, near the site of the modern Santa Cruz Quiché, and was skilfully fortified. They had an elaborate system of government and religion. Records were kept in picture-writing. The Quiché were the first Indians met by Pedro de Alvarado in 1524 on his expedition into Guatemala.

See further CENTRAL AMERICA and MEXICO; for the *Popol Vuh* see English edition by L. Spence (1909); see also Nuttall, *Ancient American Civilizations* (Camb. Mass., 1901), and W. Bollaert in *Proc. Roy. Soc. Lit.* vii. 1862.

QUICHERAT, JULES ÉTIENNE JOSEPH (1814–1882), French historian and archaeologist, was of Burgundian origin. His father, a working cabinet-maker, came from Paray le Monial to Paris to support his large family; Quicherat was born there on the 13th of October 1814. He was fifteen years younger than his brother Louis, a great Latin scholar and lexicographer, who survived him. Although very poor, he was admitted to the college of Sainte-Barbe, where he received a thorough classical education. He showed his gratitude to this establishment by writing its history (*Histoire de Sainte-Barbe, collège, communauté, institution*, 3 vols. 1860–1864). At the end of his studies he hesitated for some time before deciding what career he would follow, until Michelet put an end to his indecision by inspiring him with a taste for history. In 1835 Quicherat entered the École des Chartes; he left two years later at the head of the college. Once more inspired by the example of Michelet, who had just written an admirable work on Joan of Arc (*q.v.*), he published the text of the two trials of Joan, adding much contemporary evidence on her heroism in his *Procès de condamnation et de réhabilitation de Jeanne d'Arc* (5 vols. 1841–1849), as well as half a volume of *Aperçus nouveaux sur l'histoire de Jeanne d'Arc*, in which it seems that the last word has been said on important points. From the 15th century he drew other inspirations. He published memoirs of the adventures of a brigand, *Rodrigue de Villandrando* (1844), which gradually grew into a volume (1877), full of fresh matter. He wrote full biographies of two chroniclers of Louis XI., one very obscure, Jean Castel (in the *Bibliothèque de l'École des Chartes*, 1840), the other, Thomas Basin, bishop of Lisieux, who was, on the contrary, a remarkable politician, prelate and chronicler. Quicherat published the works of the latter, most of which were now brought out for the first time (4 vols. 1855–1859). In addition to these he wrote *Fragments inédits de Georges Chastellain* (1842), *Lettres, mémoires et autres documents relatifs à la guerre du bien public en 1465* (1843, in vol. ii. of *Mélanges historiques*, part of *Documents inédits*), &c. These works did not wholly occupy his time: in 1847 he inaugurated a course of archaeological lectures at the École des Chartes, and in 1849 was appointed professor of diplomacy at the same college. His teaching had exceptionally good results. Although he was not eloquent and had a nasal

voice, his hearers were loth to miss any of his thoughtful teaching, which was unbiased and well expressed. Of his lectures the public saw only some articles on special subjects which were distributed in a number of reviews. Note should be made of a short treatise on *La Formation française des anciens noms de lieu* (1867); a memoir *De l'ogive et de l'architecture dite ogivale* (1850), where he gives his theory on the use of stone arches—important for the history of religious architecture; an article on *L'Âge de la cathédrale de Laon* (1874), in which he fixed the exact date of the birth of Gothic architecture; *Histoire du costume en France* (1875; 2nd ed. 1877), which was first published in the form of anonymous articles in the *Magasin pittoresque*, and which the author wished to retain the character of a popular work. Following the advice of his friends, he began to write out, towards the end of his life, his lectures on archaeology, but only the introductory chapters, up to the 11th century, were found among his papers. On the other hand, the pupils trained by him circulated his principles throughout France, recognizing him as the founder of national archaeology. In one point he seems to have taken a false step; with a warmth and pertinacity worthy of a better cause he maintained the identity of Caesar's *Alesia* with Alaise (Doubs), and he died without becoming a convert to the opinion, now universally accepted, that Alise Sainte-Reine (Côte d'or) is the place where Vercingétorix capitulated. But even this error benefited science; some well directed excavations at Alaise brought many Roman remains to light, which were subsequently sent to enrich the museum at Besançon. After 1871, his course of lectures on diplomacy having been given up, Quicherat, still professor of archaeology, was nominated director of the École des Chartes. He filled this post with the same energy which he had shown in the many scientific commissions in which he had taken part. In 1878 he gave up his duties as professor, which then fell to the most conspicuous of his pupils, Robert de Lasteyrie. He died suddenly at Paris on the 8th of April 1882, a short time after having corrected the proofs of *Supplément aux témoignages contemporains de Jeanne d'Arc*, published in the *Revue historique*. After his death it was decided to bring out his hitherto unpublished papers (*Mélanges d'archéologie et d'histoire*, vol. i., Celtic, Roman and Gallo-Roman antiquities, ed. A. Giry and Aug. Castan, 1885; vol. ii., *Archéologie du moyen âge*, ed. R. de Lasteyrie, 1886); among these are some important fragments of his archaeological lectures, but his *Histoire de la laine*, with which he was occupied for many years, is missing.

BIBLIOGRAPHY.—Two of Quicherat's best pupils published excellent obituary notices of him: Robert de Lasteyrie, in *Jules Quicherat, sa vie et ses travaux* (from *Bulletin du Comité des travaux historiques*, 1883, n. 1); and Arthur Giry, *Jules Quicherat* (in the *Revue historique*, vol. xix.), with a *Bibliographie des œuvres de Jules Quicherat* (in the *Bibliothèque de l'École des Chartes*, vol. xliii. p. 316). (C. B.)*

QUICHUA, a South American Indian tribe and stock, the ruling people of Peru when the Spaniards arrived. The Quichuan stock then included the Quichuas proper and the many vassal tribes of the ancient empire of Peru. To-day it numbers some three millions. The modern Quichuas average a height of 5 ft. to 5 ft. 6 in. They are of slender build, but with well proportioned muscular limbs, and are capable of enduring great fatigue. Their complexions are of a fresh olive colour, the skin very smooth and soft, beardless, hair straight and black, the nose aquiline. They are skilful farmers and herdsmen. (See PERU.)

QUICK, a word which, by origin, and in early and many surviving uses, meant "living," "alive." It is common to Teutonic languages, cf. Ger. *keck*, lively, Du. *kwik*, and Dan. *kvik*; cf. also Dan. *kvæg*, cattle. The original root is seen in Skt. *jiva*; Lat. *vivus*, living, alive; Gr. *βίος*, life. In its original sense the chief uses are such as "the quick and the dead," of the Apostles' Creed, a "quickset" hedge, *i.e.* consisting of slips of living privet, thorn, &c., the "quick," *i.e.* the tender parts of the flesh under hard skin or particularly under the nail. The phrase "quick with child" is a conversion of with a quick, *i.e.* living child. From the sense of having full

vigour, living or lively qualities or movements, the word got its chief current meaning of possessing rapidity or speed of movement, mental or physical. It is thus used in the names of things which are in a constant or easily aroused condition of movement, e.g. "quicksand," loose water-logged sand, readily yielding to weight or pressure, and "quicksilver," the common name of the metal mercury (*q.v.*).

QUIERZY [**KIERSY**]. **CAPITULARY OF**, a capitulary of the emperor Charles the Bald, comprising a series of measures for safeguarding the administration of his realm during his second Italian expedition, as well as directions for his son Louis the Stammerer, who was entrusted with the government during his father's absence. It was promulgated on the 14th of June 877 at Quierzy-sur-Oise in France (dep. of Aisne), the site of a Carolingian royal *palatium*, before a great concourse of lords. In this document Charles takes elaborate precautions against Louis, whom he had every reason to distrust. He forbids him to sojourn in certain palaces and in certain forests, and compels him to swear not to despoil his stepmother Richilde of her allodial lands and benefices. At the same time Charles refuses to allow Louis to nominate to the countships left vacant in the emperor's absence. In principle the *honores* (benefices) and the office of a deceased count must be given to his son, who would be placed provisionally in possession by Louis; the definitive investiture, however, could be conferred only by Charles. The capitulary thus served as a guarantee to the aristocracy that the general usage would be followed in the existing circumstances, and also as a means of reassuring the counts who had accompanied the emperor into Italy as to the fate of their benefices. It cannot, however, be regarded as introducing a new principle, and the old opinion that the capitulary of Quierzy was a legislative text establishing the hereditary system of fiefs has been proved to be untenable. A former capitulary of Charles the Bald was promulgated at Quierzy on the 14th of February 857, and aimed especially at the repression of brigandage.

See E. Bourgeois. *Le Capitulaire de Kiersy-sur-Oise* (Paris, 1885), and "L'Assemblée de Quierzy sur-Oise" in *Études d'histoire du moyen-âge, dédiées à Gabriel Monod* (Paris, 1896). (R. Po.)

QUIETISM, a complicated religious movement that swept through France, Italy and Spain during the 17th century. Its chief apostles were Miguel de Molinos, a Spaniard resident in Rome; Fénelon, the famous French divine, and his countrywoman, Madame Jeanne Marie Guyon. Quietism was essentially a reaction against the bureaucratic ecclesiasticism always latent within the church of Rome, though it had come more especially to the front during the struggles of the counter-Reformation carried through by the Jesuits. A Catholic cut to the orthodox pattern did not look, and would have thought it wrong to look, beyond the spiritual fare provided for him by the ecclesiastical authorities; all his relations with his Maker were conducted through the intermediacy of the Church. In the dogmatic sphere he believed whatever the Church believed, because the Church believed it; to the Church's institutions—the sacraments and the confessional—he looked for guidance in the practical affairs of life. Protestantism had tried to put an end to this state of things by sweeping away the Church altogether, but the Quietists were more tolerant than Luther. They did not wish to abolish the Church; they admitted that it was a necessary stage in the evolution of the human soul; but they insisted that it could only bring a man on to the lowest slopes of Paradise. Those who aspired to be really holy must learn to look beyond the Church, and enter into immediate, personal relations with their Maker. But how were they to do so? Like their contemporaries, the French Jansenists, and the Quakers and Anabaptists of northern Europe, the Quietists fell back on a doctrine of immediate inspiration of the individual conscience. To the many God spoke only in general terms through the Church; but to the few He made His will directly known. But how did He do so? How distinguish the voice of God from the vagaries of our own imagination? Quietism offered an easy test. The less

"sense of proprietorship" a man had in his own good actions—the more they came from a source outside himself—the surer might he be that they were divine. If, on the other hand, they were the fruit of his deliberate thought and will, that was enough to show that they did not come from God, but from his sinful self. Hence the first duty of the Quietist was to be "passive." So far as was possible he must numb all his spontaneous activities of every kind; then he could fold his hands, and wait in dreamy meditation until inspiration came. And since all our activities have their root in desire, the shortest road to passivity was to suppress all desires and wishes of every kind. Thus the great object of the Quietist was to "sell or kill that cruel beast, self-conscious will." Then he would be dead to hope and fear; he would be icily indifferent to his fate, either in this world or the next. Thenceforward no human tastes or affections would stand in the way of his performing the will of God. He was, as Fénelon said, like a feather blown about by all the winds of grace. His mind was a mere *tabula rasa*, on which the Spirit printed any pattern that it chose. Hence arose the great Quietist doctrine of disinterested love. "The Quietists maintain," says a contemporary writer, "that Christian perfection means a love of God so absolutely free from all desire of happiness that it is indifferent to salvation. The soul is moved neither by hope nor fear, nor even by the foretaste of eternal bliss. Its only motive is to do the will and promote the glory of God. Other things are of no account: neither grace, nor merit, nor happiness, nor even perfection, in so far as it attaches to us. Nay, the soul must be ready to renounce its hopes of heaven, and the scrupulous will often feel themselves bound to do so; for in the last and fiercest trials they are invincibly persuaded of their own damnation. In this sentence of condemnation they generously acquiesce; and thenceforward, having nothing more to lose, they stand tranquil and intrepid, without fear and without remorse. This is what the Quietists call the state of holy indifference. Their soul has lost all wish for action, all sense of proprietorship in itself, and has thereby reached the summit of Christian perfection" (André, *Vie du Père Malebranche*, ed. Ingold, Paris, 1886, p. 271).

Quietism is an outgrowth from the mysticism of the great 16th-century Spaniards, St Teresa and St John of the Cross, though it would be unfair to hold them responsible for all the utterances of their disciples. Certainly St Teresa made much of "passivity," but she only regarded it as a refuge for a few specially constituted souls; whereas the Quietists designedly brought it within the reach of everyone. In St Teresa the passivity itself was balanced by a strong attachment to the virtues of the active life, and an equally strong devotion to the Church. Among the Quietists both these checks disappear, and passivity becomes the one and only test of holiness. But if passivity is all in all, there is no room for the virtues of the active life; all Quietists cherished the ancient saying that one moment's contemplation is worth a thousand years' good works. Still less room had they for the Church. It only professed to guide men to God; but those who had already found God stood in no need of a guide. Nay, they did not even stand in need of revelation. "If Christ be the way," wrote the Quietist Malaval, "let us certainly pass by Him to God, but he who is always passing never arrives at his journey's end." Such utterances go far to explain the severity with which the Roman Church tried to stamp out the later developments of Quietism. In its earlier stages, before it had crystallized into a definite doctrine, the ecclesiastical authorities had been tolerant enough. The Spanish monk, Juan Falconi, who is generally reckoned as the father of Quietism, died in the odour of sanctity in 1632; some thirty years later his fellow-countryman, Molinos, transported his doctrines to Rome, where they gained unbounded popularity with bishops and cardinals, and even with pope Innocent XI. In 1675 Molinos published the *Guida Spirituale*, the great text-book of his school. But his success soon aroused the suspicion of the Jesuits, the great champions of militant ecclesiasticism. "Passivity" accorded ill with a zealous

frequentation of the confessional, their chief centre of influence. Failing to turn public opinion against Molinos in Rome, they brought pressure to bear on Louis XIV. through his confessor, Père La Chaise. At the instance of the French ambassador Molinos was arrested (1685); his papers were seized, and his chief disciples examined by the Inquisition. Two years later he was convicted of heresy, and sentenced to imprisonment for life.

The later stages of the Quietist drama were played out in France. Here Quietist ideas had long been spreading under the leadership of enthusiasts like François Malaval (1627-1719), a blind layman of Marseilles. A more romantic figure was Jeanne Marie Guyon (1648-1717), a widow of good family and remarkable personal charm, who devoted her life to missionary journeys on behalf of "passivity." In 1688 fate brought her to the French court, where she made a great impression on Mme. de Maintenon and other persons of quality. But her most illustrious captive was Fénelon, then tutor to the duke of Burgundy, eldest son of the Dauphin. "They met," says Saint-Simon; "they pleased each other, and their sublime amalgamated." In other words, they corresponded with a freedom that Fénelon afterwards had cause to regret. For Mme. Guyon's paradoxical and extravagant language soon scandalized her friends. In 1693 she was examined by Bossuet, and dismissed with a severe caution. Further imprudences led to her arrest, and a long imprisonment in the Bastille. On her release in 1703 she settled down quietly at Blois, where she died in 1717. Meanwhile Fénelon had become involved in her fortunes. When Bossuet first took action, Fénelon defended her with a zeal that drew down suspicion on his own head; and he was only promoted to the archbishopric of Cambrai after signing what was really a disguised retractation (1695). Meanwhile Bossuet was at work on an *Instruction sur les états d'oraison*, which was intended to distinguish once for all what was true in Quietism from what was false. Fénelon, feeling sure that Bossuet would do the Quietists less than justice, determined to be beforehand with him. While Bossuet's book was still in the press, he suddenly brought out an *Explication des maximes des saints* (1697). The little volume raised a violent storm. For two years Fénelon was at bitter feud with Bossuet; he was banished from Versailles; finally, he was censured by the pope (1699), although in very measured terms. For Fénelon by no means shared all the ideas of Mme. Guyon; in the language of the divinity schools he was, at most, a "semi-Quietist." For the more ecstatic side of Quietism, so much in evidence with his friend, he had no taste whatsoever; but he thought that "passivity," when interpreted with large modifications, led the way to a state of peaceful, other-world serenity highly grateful to the denizens of a crowded court, where was much splendid ennui and but little peace. Further, he was the counsellor of many over-scrupulous souls; and Quietist disinterestedness, also much modified, enabled him to tell them that they were not necessarily castaways because they suffered much from "spiritual dryness," and seldom enjoyed the sweets of piety. But in the heat of battle with Bossuet, Fénelon carried his principles beyond all reasonable bounds. The theme of his *Maxims* is that, as men grow in holiness they become utterly indifferent to themselves. Not only do they cease to covet the consolations of religion; they lose all incidental pleasure in its exercise. Their whole soul is taken up in loving God; and they neither know nor care whether God loves them in return. But Bossuet had little trouble in persuading the world that *Wenn ich Dich liebe, was geht es Dich an?* is but a sorry foundation on which to build up a personal religion; and the condemnation of the *Maxims* proved the deathblow to official Quietism. But flickers of "passivity," not always easily distinguishable from the teaching of Molinos, are still here and there produced by violent reaction from the prevailing legalism of the church of Rome.

BIBLIOGRAPHY.—H. Heppe, *Geschichte der quietistischen Mystik* (Berlin, 1875), covers the whole subject. On the place of Quietism in the history of religious thought see W. R. Inge, *Christian Mysticism* (London, 1899); on its psychology see H. Delacroix, *Etudes*

sur le mysticisme (Paris, 1908); J. Denis, *Mémoires de l'Académie de Caen* for 1894; W. James, *The Varieties of Religious Experience* (London, 1902); H. Joly, *Psychologie des saints* (Paris, 1898); J. H. Leuba, "Tendances fondamentales des mystiques chrétiens," in the *Revue philosophique* for 1902; E. Murisier, *Les Maladies du sentiment religieux* (Paris, 1903); Rufus M. Jones, *Studies in Mystical Religion* (1909). See also the articles on BOSSUET; FÉNELON; MME. GUYON; and MOLINOS. (ST C.)

QUILIMANE, or KILMANE (the former being the Portuguese spelling), a town of Portuguese East Africa, in 18° 1' S., 36° 59' E., 14 m. inland from the mouth of the river Quilimane or Qua Qua. The river, an independent stream during the rest of the year, during the rainy season becomes a deltaic branch of the Zambezi, with which it is connected by a channel called Mutu. The town (officially São Martinho de Quilimane) lies on the north bank of the river at a point where it is about a mile broad. There is ample and deep anchorage in the river, but the entrance is obstructed by a bar, over which there is 9 ft. of water at low tide, and from 16 to 22 ft. at high tide. Almost all the European merchants live in one long, acacia-shaded street or boulevard skirting the river, while the Indian merchants or Banyans occupy another street running at right angles to the first street. Behind lies the native town. The total population in 1909 was 2200, including 400 Europeans and 320 Asiatics. The trade of Quilimane, formerly the only port for the produce of the Zambezi valley, steadily declined after the establishment of Chinde (*q.v.*). Efforts made at the beginning of the 20th century to develop local resources met with little success, owing to high duties and freights. A railway 18 m. long runs to Maquival, a large *prazo* for the cultivation of tropical produce. The imports are largely cotton goods from England and India, provisions from Portugal, and hardware from Germany. The exports are chiefly copra, ground-nuts, sugar, sesamum, india-rubber, wax, ivory, and beans. The average annual value of the trade for the ten years 1897-1906 was:—imports £60,509, exports £34,547. The natives are noted for their skill in the manufacture of jewelry, chiefly gold and silver ornaments. The town lies low and is unhealthy, despite efforts to improve its condition.

The Quilimane river was entered by Vasco da Gama in 1498, who there discovered an Arab settlement. The present town was founded by the Portuguese in the 16th century, and became in the 18th and the early part of the 19th centuries one of the great slave marts on the east coast of Africa. It was the starting-point of several notable expeditions—that of Francisco Barreto to the country of the Monomotapa in 1569, and that of David Livingstone up the Zambezi to Lake Nyasa in 1861 being the most famous. Until 1853 the trade of the port was forbidden to any save Portuguese. The European population, until the last quarter of the 19th century, consisted mainly of convicts from Portugal. (See PORTUGUESE EAST AFRICA, *History*.)

QUILL, a term applied to the bare, hard, hollow tube of the feather of a bird, also to the large flight feathers or *remiges*, and especially to the strong feathers of the goose, swan, or crow used in the making of quill pens (see FEATHER and PEN). The word is of obscure origin; a word with similar meaning, *Kiel*, is found in German, and French has *quille*, ninepin, apparently connected with Ger. *Kegel*. Certain ancient stringed instruments were played with a *plectrum* or plucker made of the quill of a bird's feather, and the word has thus been used of a *plectrum* made of other material and differing in shape, and also of an analogous object for striking the strings in the harpsichord, spinet or virginal. The verb "to quill" is to fold lace, muslin or other light material into narrow flutes or pleats; when so pleated the material is called "quilling." The French term "quillon," apparently formed from *quille*, ninepin, is applied to the projecting arms or cross guards of the hilt of a sword.

QUILLER-COUCH, SIR ARTHUR THOMAS (1863-), English writer, known under the pseudonym of "Q" was born in Cornwall on the 21st of November 1863. He was educated at Newton Abbot College, at Clifton College, and Trinity College, Oxford. After taking his degree in 1886 he was for a short time classical lecturer at Trinity. While he was at Oxford he

published (1887) his *Dead Man's Rock* (a romance in the vein of Stevenson's *Treasure Island*), and he followed this up with *Troy Town* (1888) and *The Splendid Spur* (1889). After some journalistic experience in London, mainly as a contributor to the *Speaker*, in 1891 he settled at Fowey in Cornwall. His later novels include *The Blue Pavilions* (1891), *The Ship of Stars* (1899), *Hetty Wesley* (1903), *The Adventures of Harry Revel* (1903), *Fort Amity* (1904), *The Shining Ferry* (1905), *Sir John Constantine* (1906). He published in 1896 a series of critical articles, *Adventures in Criticism*, and in 1898 he completed R. L. Stevenson's unfinished novel, *St Ives*. From his Oxford days he was known as a writer of excellent verse. With the exception of the parodies entitled *Green Boys* (1893), his poetical work is contained in *Poems and Ballads* (1896). In 1895 he published a delightful anthology from the 16th and 17th-century English lyrists, *The Golden Pomp*, followed in 1900 by an equally successful *Oxford Book of English Verse, 1250-1900* (1900). In Cornwall he was an active worker in politics for the Liberal party. He was knighted in 1910.

QUILLOTA, a town of Chile in the province of Valparaiso, on the left bank of the Aconcagua river, 20 m. above its mouth and 26 m. E.N.E. of the city of Valparaiso. Pop. (1902 estimate) 9876. The valley is noted for its beauty, fertility, and healthfulness, and is the centre of thriving fruit and wine industries. Among its fruits is the "chirimoya" (*Annona cherimolia*). There are rich copper mines in the vicinity. Quillota is situated on a railway between Valparaiso and Santiago, which passes through a mountainous, semi-barren country. It is one of the oldest towns of Chile, dating from the first years of the conquest.

QUILON, a seaport of India, on the Malabar coast, in the state of Travancore. Pop. (1901) 15,691. Quilon enjoys great facilities of water communication, and has an active export trade in timber, coco-nuts, ginger, pepper, &c. The palace of the maharaja of Travancore stands on the bank of Quilon lake, a beautiful sheet of water. Besides being on a projecting point, Quilon is rendered still more unsafe to approach by the bank of hard ground called the Tangasseri reef, which extends some distance to the south-west and west of the point and along the coast to the northward. There is good anchorage, however, in a bight about 3 m. from the fort. Quilon is one of the oldest towns on the Malabar coast, and continued to be a place of considerable importance down to the beginning of the 16th century. It is now the headquarters of the Travancore army, with a subsidiary battalion. Cotton weaving and spinning and the manufacture of tiles are the chief industries. It is the terminus of a railway across the hills from Tinnevely. Adjoining Quilon is the British village of Tangasseri, formerly a Portuguese and then a Dutch settlement, which is administered with Anjengo; pop. (1901) 1733.

QUILT, properly a coverlet for a bed, consisting of a mass of feathers, down, wool or other soft substance, surrounded by an outer covering of linen, cloth, or other material. In its earlier uses the "quilt" was made thick, and served as a form of mattress. The term was also given to a stitched wadded lining for body armour, and also, when made stout and closely padded, to a substitute for armour. The word came into English from O. Fr. *cuiltte*, *coille*, or *coule*, mod. *couette*. This is derived from Lat. *culcita* or *culcita*, a stuffed mattress or cushion. From the form *culcita* came O. Fr. *cotre* or *coutre*, whence *contre pointe*, Low Lat. *culcita puncta*, i.e. stitched or quilted cushion; this was corrupted to *contre pointe*, Eng. *counterpoint*, which in turn was changed to "counterpane" (as if from Lat. *pannus*, piece of cloth). Thus "counterpane," a coverlet for a bed, and "quilt," are by origin the same word.

QUIMPER, formerly QUIMPER-CORENTIN, a town of France, capital of the department of Finistère, 158 miles north-west of Nantes and 68 miles south-east of Brest on the railway between those towns. Pop. (1906) 16,550. The delightful valley in which it lies is surrounded by high hills and traversed by the Steir and the Odet, which, meeting above the town, form a navigable channel for vessels of 150 tons to the sea (11 miles).

There is a small general shipping trade. Of the town walls (15th century) a few portions are preserved in the terrace of the episcopal palace and in the neighbourhood of the college. Quimper is the seat of a bishopric in the province of Rennes. The cathedral, dedicated to St Corentin and erected between 1239 and 1515, has a fine façade (c. 1425), the pediment of which is crowned by a modern equestrian statue of King Grallon, and adorned (like several other external parts of the building) with heraldic devices in granite. Two lateral towers with modern spires (1854-56) and turrets reach a height of 247 feet. The axis of the choir is deflected towards the north, a feature not uncommon, but here exaggerated. The nave and the transept are in the style of the 15th century, and the central boss bears the arms of Anne of Brittany (1476-1514). The terminal chapel of the apse dates from the 13th century. In the side chapels are the tombs of several early bishops. The high altar, tabernacle, and ciborium are costly works of contemporary art. The pulpit panels represent episodes in the life of St Corentin. Of the other churches may be mentioned the church of Locmaria, dating from the 11th century, and the chapel of the 15th century connected with the episcopal palace. A number of houses, in wood or stone, date from the 15th, 16th and 17th centuries. The museum, built in 1869-70, contains archaeological collections and about 1300 paintings and drawings. In 1868 a bronze statue of Laennec the inventor of the stethoscope (born at Quimper in 1781) was erected in Place St Corentin.

Quimper, or at least its suburb Locmaria (which lies below the town on the left bank of the Odet), was occupied in the time of the Romans, and traces of the ancient foundations exist. Later Quimper became the capital of Cornouailles and the residence of its kings or hereditary counts. It is said to have been Grallon Meur (i.e. the Great) who brought the name of Cornouailles from Great Britain and founded the bishopric, which was first held by St Corentin about 495. Hoel, count of Cornouailles, marrying the sister and heiress of Duke Conan in 1066, united the countship with the duchy of Brittany. Quimper suffered in the local wars of succession. In 1344 it was sacked by Charles of Blois. Monfort failed in his attempt to take the town by storm on August 11, 1345, but it opened its gates to his son John IV. in 1364 after the victory at Auray. At a later period it sided with the League. Doubtless on account of its distance from the capital, Quimper, like Carpentras and Landerneau, has been a frequent butt of French popular wit.

QUIMPERLÉ, a town of western France, capital of an arrondissement in the department of Finistère, at the confluence of two rivers which unite to form the Laiter, 28 m. E.S.E. of Quimper by rail. Pop. (1906) town 6203, commune 9176. Quimperlé grew up round the abbey of Ste Croix, founded in the 11th century, the romanesque basilica of which, restored in modern times, still remains. The church of St Michel (14th and 15th centuries), with a fine tower, crowns the hill above the town. Quimperlé has a tribunal of first instance, and carries on the manufacture of farm implements, railway material, paper, &c., and trades in grain, timber, cattle and agricultural products. The town has a small port.

QUIN, JAMES (1693-1766), English actor of Irish descent, was born in London on the 24th of February 1693. He was educated at Dublin, and probably spent a short time at Trinity College. Soon after his father's death in 1710, he made his first appearance on the stage at Abel in Sir Robert Howard's *The Committee* at the Smock Alley Theatre. Quin's first London engagement was in small parts at Drury Lane, and he secured his first triumph at Bajazet in Nicolas Rowe's *Tamerlane*, on the 8th of November 1715. The next year he appeared as Hotspur at Lincoln's Inn, where he remained for fourteen years. On the 10th of July 1718 he was convicted of manslaughter for having killed Bowen, another actor, in a duel which the victim had himself provoked. Quin was not severely punished, the affair being regarded as more of an accident than a crime. The public took a similar view of another episode in which Quin, on being attacked by a young actor who had been angered by the sarcastic criticism of his superior,

drew upon him and killed him. But if he was eager in his own defence he was no less so in that of others. In 1721 a drunken nobleman reeled on to the stage of the theatre and assaulted the manager, Rich, whose life was saved by Quin's prompt armed interference. This resulted in a riot, and thereafter a guard was stationed in all theatres. In 1732 Quin appeared at Covent Garden, returning to Drury Lane from 1734 to 1741, and in 1742 was again at Covent Garden, where he remained until the close of his career. On the 14th of November 1746 Quin played Horatio and Garrick Lothario to the Calista of Mrs Cibber in Rose's *Fair Penitent*. The applause of the audience was so great as to disconcert if not actually to alarm the two actors. Public interest was yet more keenly stimulated in comparing Garrick's and Quin's impersonations of Richard III., the popular verdict being loudly in favour of Garrick. But Quin's Falstaff in King Henry IV. was emphatically preferred to the Hotspur of his rival. In consequence of an attempt made by Garrick in 1750-51 to draw him away from Covent Garden, Quin was enabled to extort from his manager a salary of £1000 a year, the highest figure then reached in the profession. Quin's last regular appearance was on the 15th of May 1757, as Horatio in the *Fair Penitent*, though in the following year he twice played Falstaff for the benefit of friends. He had retired to Bath, where he lived a happy life, with late hours and much eating and drinking, until his death on the 21st of January 1766. He was buried in the abbey church at Bath. Some coolness which had arisen between Quin and Garrick before the former's retirement was dissipated on their subsequent meeting at Chatsworth at the duke of Devonshire's, and Quin paid many a visit to Garrick's villa at Hampton in the latter part of his life. The epitaph in verse on his tomb was written by Garrick. Quin's will displayed a generous nature, and among numerous bequests was one of fifty pounds to "Mr Thomas Gainsborough, limner."

In the Garrick Club in London are two portraits of the actor ascribed to Hogarth, and a portrait by Gainsborough is in Buckingham Palace. His personality was not gracious. His jokes were coarse; his temper irascible; his love of food, his important airs, and his capacity for deep drinking do not command respect; on the other hand, a few of his jokes were excellent, and there was no rancour in him. On many occasions he showed his willingness to help persons in distress. His character is summarized by Smollett in *Humphrey Clinker*. As an actor his manner was charged with an excess of gravity and deliberation; his pauses were so portentous as in some situations to appear even ludicrous; but he was well fitted for the delivery of Milton's poetry, and for the portrayal of the graver rôles in his repertory.

See *The Life of Mr. James Quin, Comedian*, published in 1766 and reprinted in 1887.

QUINAULT, PHILIPPE (1635-1688), French dramatist and librettist, was born in Paris on the 3rd of June 1635. He was educated by the liberality of Tristan l'Hermite, the author of *Mariamne*. Quinault's first play was produced at the Hôtel de Bourgogne in 1653, when he was only eighteen. The piece succeeded, and Quinault followed it up, but he also read for the bar; and in 1660, when he married a widow with money, he bought himself a place in the Cour des Comptes. Then he tried tragedies (*Agrippa*, &c.) with more success than desert. He received one of the literary pensions then recently established, and was elected to the Academy in 1670. Up to this time he had written some sixteen or seventeen comedies, tragedies, and tragi-comedies, of which the tragedies were mostly of very small value and the tragi-comedies of little more. But his comedies—especially his first piece *Les Rivaux* (1653), *L'Amant indiscret* (1654), which has some likeness to Molière's *Elouardi*, *Le Fantôme amoureux* (1659), and *La Mère coquette* (1665), perhaps the best—are much better. But in 1671 he contributed to the singular miscellany of *Psyché*, in which Corneille and Molière also had a hand, and which was set to the music of Lulli. Here he showed a remarkable faculty for lyrical drama, and from this time till just before his death he confined himself

to composing libretti for Lulli's work. This was not only very profitable (for he is said to have received four thousand livres for each, which was much more than was usually paid even for tragedy), but it established Quinault's reputation as the master of a new style,—so that even Boileau, who had previously satirized his dramatic work, was converted, less to the opera, which he did not like, than to Quinault's remarkably ingenious and artist-like work in it. His libretti are among the very few which are readable without the music, and which are yet carefully adapted to it. They certainly do not contain very exalted poetry or very perfect drama. But they are quite free from the ludicrous doggerel which has made the name libretto a byword, and they have quite enough dramatic merit to carry the reader, much more the spectator, along with them. It is not an exaggeration to say that Quinault, coming at the exact time when opera became fashionable out of Italy, had very much to do with establishing it as a permanent European *genre*. His first piece after *Psyché* was a kind of classical masque. *Les Fêtes de l'Amour et de Bacchus* (1672). Then came *Cadmus* (1674), *Alceste* (1674), *Thésée* (1675), *Alys* (1676), one of his best pieces, and *Isis* (1677). All these were classical in subject, and so was *Proserpine* (1680), which was superior to any of them. *The Triumph of Love* (1681) is a mere ballet, but in *Perse* (1682) and *Phaeton* (1683) Quinault returned to the classical opera. Then he finally deserted it for romantic subjects, in which he was even more successful. *Amadis de Gaule* (1684), *Roland* (1685), and *Armide* (1686) are his masterpieces, the last being the most famous and the best of all. The very artificiality of the French lyric of the later 17th century, and its resemblance to alexandrines cut into lengths, were aids to Quinault in arranging lyrical dialogue. Lulli died in 1687, and Quinault, his occupation gone, became devout, and began a poem called the "Destruction of Heresy." He died on the 26th of November 1688.

The best edition of his works is that of 1739 (Paris, 5 vols.).

QUINAZOLINES (Pheniazines or benzopyrimidines), in organic chemistry, heterocyclic compounds of the structure shown in the inset formula. They may be regarded as resulting from the fusion of a benzene with a pyrimidine nucleus in the 5.6 position. They are isomeric with the cinnolines, phthalazines and quinoxalines. They may be obtained by the action of alcoholic ammonia on the acyl derivatives of ortho-aminobenzaldehydes and ortho-aminoketones (A. Bischler, *Ber.*,

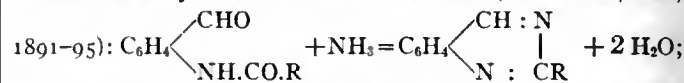
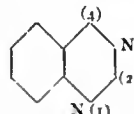

and from the corresponding dihydro compounds on oxidation with potassium permanganate. They are stable, tertiary bases, and may be distilled without decomposition; they form addition products with alkyl iodides and double salts with mercuric and platinum chlorides. On reduction with sodium in presence of alcohol they yield dihydro derivatives. Those in which the :CH group adjacent to the benzene nucleus is unsubstituted are oxidized by chromic acid to ketodihydroquinazolines (quinazolones).

Quinazoline ($\text{C}_8\text{H}_6\text{N}_2$) is obtained by oxidizing its dihydro-derivative with potassium ferricyanide. The dihydro derivatives exist in three different series, since the addition of two atoms of hydrogen in the diazine ring can take place in three different positions, namely, in the 3.4, 1.4 and 1.2 positions, and these different types are distinguished by the symbols Δ_1 , Δ_2 , Δ_3 , denoting that the double linkage is between the first and second, second and third, and third and fourth atoms in the diazine ring. The Δ_1 series, which are obtained by the elimination of the elements of water from the acyl derivatives of ortho-aminobenzylamines, are rather strong bases which form stable salts and yield the corresponding keto derivatives on oxidation (C. Paal, *Ber.*, 1889-1896). 4-Keto-dihydroquinazoline (β -quinazolone) is formed by oxidizing the dihydro base with potassium permanganate; by boiling acyl-ortho-aminobenzamide with water (A. Weddige, *Jour. prak. Chem.*, 1885, (2) 31, p. 124); or by heating anthranilic acid with formamide (S. Nientowski, *Ber.*, 1895, 28, p. 443). It reacts both in the enol and keto forms, yielding both N-ethers and O-ethers, the latter being obtained by the action of sodium alcoholates on 4-chloroquinazolines. The Δ_2 series is obtained by heating acyl-ortho-aminobenzylamines with zinc chloride, whilst the Δ_3 series, which

is only known in the form of its keto derivatives (α -quinazolines), results from the fusion of urea with ortho-aminobenzaldehydes and benzophenones, the elements of water and of ammonia being eliminated (S. Gabriel and Th. Posner, *Ber.*, 1895, 28, p. 1037). They possess feeble basic and phenolic characters. The tetra-hydroquinazolines are obtained by reducing the quinazolines and dihydroquinazolines and by condensing ortho-aminobenzylamine with aldehydes (M. Busch, *Jour. prak. Chem.*, 1896, (2) 53, p. 414). The ring is easily split on hydrolysis, giving rise to ortho-disubstituted benzenes. The keto derivatives of this series result by the action of carbonyl chloride on ortho-aminobenzylamines of the type $H_2N.C_6H_4.CH_2NHR$ (M. Busch, *Ber.*, 1892, 25, p. 2853), or from the urea derivatives of ortho-aminobenzylamine. They are weak bases which are indifferent to both acids and alkalis, and which on oxidation yield the corresponding 2,4-diketo derivatives.

QUINCE (Lat. *Cydonia* or *Cotonca*, Ital. *Cologna*, Fr. *coing*, Mid. Eng. *coin*, *quin*, whence a collective plural "quins," corrupted to singular "quince"), a fruit-tree concerning which botanists differ as to whether or not it is entitled to take rank as a distinct genus or as a section of the genus *Pyrus* (natural order Rosaceae, *q.v.*). It is not a matter of much importance whether we call the quince *Pyrus Cydonia* or *Cydonia vulgaris*. For practical purposes it is perhaps better to consider it as distinct from *Pyrus*, differing from that genus in the twisted manner in which the petals are arranged in the bud, and in the many-celled ovary, in which the numerous ovules are disposed horizontally, not vertically as in the pears. The quinces are much-branched shrubs or small trees with entire leaves, small stipules, large solitary white or pink flowers like those of a pear or apple, but with leafy calyx lobes and a many-celled ovary, in each cell of which are numerous horizontal ovules. The common quince is a native of Persia and Anatolia, and perhaps also of Greece and the Crimea, but in these latter localities it is doubtful whether or not the plant is not a relic of former cultivation. By Franchet and Savatier *P. Cydonia* is given as a native of Japan with the native name of "maroumerou." It is certain that the Greeks knew a common variety upon which they engrafted scions of a better variety which they called *κιδώνιον*, from *Cydon* in Crete, whence it was obtained, and from which the later names have been derived. Pliny (*H.N.* xv. 11) mentions that the fruit of the quince, *Malum cotoneum*, warded off the influence of the evil eye; and other legends connect it with ancient Greek mythology, as exemplified by statues in which the fruit is represented, as well as by representations on the walls of Pompeii. The fragrance and astringency of the fruit of the quince are well known, and the seeds were formerly used medicinally for the sake of the mucilage they yield when soaked in water, a peculiarity which is not met with in pears. This mucilage is analogous to, and has the same properties as, that which is formed from the seeds of linseed.

The quince is but little cultivated in Great Britain, two or three trees planted in the slip or orchard being in general found to be sufficient for a supply of the fruit; in Scotland it seldom approaches maturity, unless favoured by a wall. The fruit has a powerful odour, but in the raw state is austere and astringent; it, however, makes an excellent preserve, and is often used to give flavour and poignancy to stewed or baked apples.

There are three principal varieties of the quince, the Portugal, the apple-shaped and the pear-shaped. The Portugal is a taller and more vigorous grower than the others, and has larger and finer fruit; the apple-shaped, which has roundish fruit, is more productive, and ripens under less favourable conditions than either of the others; while the pear-shaped has roundish-pyriform fruit, which ripens later than that of the apple-shaped variety.

The quince prefers a rich, light and somewhat moist soil. The tree is generally propagated by cuttings or layers, the former making the best plants, but being longer in growing. It is much used as a dwarfing stock for certain kinds of pears, and for this purpose the young plants when bedded out in the quarters should be shortened back to about 18 or 20 inches; the effect is to restrain the growth of the pear, increase and hasten its fruitfulness, and enable it to withstand the effects of cold. Those required to form standard fruit-bearing trees should be trained up to a single stem till a height of 5 or 6 feet is attained.

The common Japan quince, *Pyrus* or *Cydonia japonica*, is grown in gardens for the sake of its flowers, which vary in colour from

creamy white to rich red, and are produced during the winter and early spring months. The fruit is green and fragrant but quite uneatable. *C. Maulei*, a more recently introduced shrub from Japan, bears a profusion of equally beautiful orange-red flowers, which are followed by fruit of a yellow colour and agreeable fragrance, so that, when cooked with sugar, it forms an agreeable conserve, as in the case of the ordinary quince.

QUINCY, JOSIAH (1744-1775), American patriot, son of Josiah Quincy (1700-1784), was born in Boston on the 23rd of February 1744. He was a descendant of Edmund Quincy, who emigrated to Massachusetts in 1633, and received in 1636 a grant of land at Mount Wollaston, or Merry Mount, afterwards a part of Braintree and now Quincy. He graduated at Harvard in 1763, and studied law in the office of Oxenbridge Thacher (d. 1765), to whose large practice he succeeded. In 1767 Quincy contributed to the *Boston Gazette* two bold papers, signed "Hyperion," declaiming against British oppression; they were followed by a third in September 1768; and on the 12th of February 1770 he published in the *Gazette* a call to his countrymen to break off all social intercourse "with those whose commerce contaminates, whose luxuries poison, whose avarice is insatiable, and whose unnatural oppressions are not to be borne." After the "Boston massacre" (5th of March 1770) he and John Adams defended Captain Preston and the accused soldiers and secured their acquittal. He used the signatures "Mentor," "Callisthenes," "Marchmont Needham," "Edward Sexby," &c., in later letters to the *Boston Gazette*. He travelled for his health in the South in 1773, and left in his journal an interesting account of his travels and of society in South Carolina; this journey was important in that it brought Southern patriots into closer relations with the popular leaders in Massachusetts. In May 1774 he published *Observations on the Act of Parliament, commonly called "The Boston Port Bill," with Thoughts on Civil Society and Standing Armies*, in which he urged "patriots and heroes" to "form a compact for opposition—a band for vengeance." In September 1774 he left for England, where he consulted with leading Whigs as to the political situation in America; on the 16th of March 1775 he started back, but he died on the 26th of April in sight of land.

See the *Memoir of the Life of Josiah Quincy, Jun., of Massachusetts* (Boston, 1825; 2nd ed., 1874), by his son, which contains his more important papers.

His son, **JOSIAH QUINCY** (1772-1864), American lawyer and author, was born in Boston on the 4th of February 1772. He studied at Phillips Academy, Andover, graduated at Harvard in 1790, studied law, and was admitted to the bar in 1793, but was never a prominent advocate. He became a leader of the Federalist party in Massachusetts; was an unsuccessful candidate for the national House of Representatives in 1800; served in the Massachusetts Senate in 1804-5; and was a member in 1805-13 of the national House of Representatives, where he was one of the small Federalist minority. He attempted to secure the exemption of fishing vessels from the Embargo Act, urged the strengthening of the American navy, and vigorously opposed the erection of Orleans Territory (Louisiana) into a state in 1811, and stated as his "deliberate opinion, that if this bill passes, the bonds of this Union are virtually dissolved; that the States that compose it are free from their moral obligations to maintain it; and that, as it will be the right of all, so it will be the duty of some to prepare definitely for a separation,—amicably if they can, violently if they must." This is probably "the first assertion of the right of secession on the floor of Congress." Quincy left Congress because he saw that the Federalist opposition was useless, and thereafter was a member of the Massachusetts Senate until 1820; in 1821-22 he was a member and speaker of the state House of Representatives, from which he resigned to become judge of the municipal court of Boston. In 1823-28 he was mayor of Boston, and in his term Faneuil Hall Market House was

¹ His eldest brother, **SAMUEL QUINCY** (1735-1789), was at this time solicitor-general of Massachusetts, and opened this trial. He remained loyal to the Crown, left Boston in 1776, and was attorney for the Crown in Antigua until his death.

built, the fire and police departments were reorganized, and the city's care of the poor was systematized. In 1829-1845 he was president of Harvard College, of which he had been an overseer since 1810, when the board was reorganized; he has been called "the great organizer of the university"; he gave an elective (or "voluntary") system an elaborate trial; introduced a system of marking (on the scale of 8) on which college rank and honours, formerly rather carelessly assigned, were based; first used courts of law to punish students who destroyed or injured college property; and helped to reform the finances of the university. During his term Dane Hall (for law) was dedicated, Gore Hall was built, and the Astronomical Observatory was equipped. His last years were spent principally on his farm in Quincy, where he died on the 1st of July 1864.

He wrote a *Memoir* of his father (1825); a *History of Harvard University* (2 vols., 1840), marred by a tendency to belittle the clerical régime; *The Journals of Major Samuel Shaw* (1847); *The History of the Boston Athenæum* (1851); *The Municipal History of the Town and City of Boston* (1852); a *Memoir of the Life of J. Q. Adams* (1858); and *Essays on the Soiling of Cattle* (1859), only one of his many practical contributions to agriculture. See Edmund Quincy, *Life of Josiah Quincy* (Boston, 1867).

JOSIAH QUINCY (1802-1882), son of the last-named, was mayor of Boston in 1845-1849, and author of *Figures of the Past* (1882); his brother EDMUND (1808-1877) was a prominent Abolitionist, and author of the biography of his father and of a romance, *Wensley* (1854); and his sister ELIZA SUSAN (1798-1884) was her father's secretary and the biographer of her mother. Josiah Quincy (1802-1882) had two sons—JOSIAH PHILLIPS (1820-1910), a lawyer, who wrote, besides some verse, *The Protection of Majorities* (1876) and *Double Taxation in Massachusetts* (1889); and SAMUEL MILLER (1833-1887), who practised law, wrote on legal subjects, served in the Union army during the Civil War, and was breveted brigadier-general of volunteers in 1865. JOSIAH QUINCY (b. 1859), a son of Josiah Phillips Quincy, was prominent in the Democratic party in Massachusetts, and was mayor of Boston in 1895-1899.

QUINCY, a city and the county-seat of Adams county, Illinois, U.S.A., in the western part of the state, on the Mississippi river, about 105 m. W. of Springfield. Pop. (1890) 31,494; (1900) 36,252, of whom 4961 were foreign-born—3988 being of German birth—and 2029 were negroes; (1910, census) 36,587. Land area (1906), 5.8 sq. m. Quincy is served by the Chicago, Burlington & Quincy, the Quincy, Omaha & Kansas City, and the Wabash railways, and by lines of river steamers, which find an excellent harbour in Quincy Bay, an arm of the Mississippi. The city is built on the river bluffs, which command an extensive view. In Indian Mounds park, within the city limits and owned by the city, are prehistoric mounds. The Quincy Library, founded in 1837, has been a free public library since 1889. Among the principal public buildings are the Court House and the Federal Government building. The State Soldiers' and Sailors' Home (1887), with grounds covering 222 acres, is in Quincy; one of its fifty-five buildings (Lippincott Memorial Hall) was erected by the veterans of the institution in memory of Charles E. Lippincott, the first superintendent. There is a monument in Quincy in memory of George Rogers Clark, and the homestead (built in 1835) of John Wood, founder of the city, is now owned by the Quincy Historical Society, organized in 1896. Quincy is the seat of St Francis Solanus College (1860) and St Mary's Institute (Roman Catholic); The Chaddock Boys' School (Methodist Episcopal), until 1900 known as Chaddock College; two schools of music; and the Gem City Business College. Among the charitable institutions are Blessing Hospital (1875), St Mary's Hospital (1867; in charge of the Sisters of the Poor of St Francis), the Woodland Home for Orphans and Friendless (1853), St Ambrose Orphans' Home (1865), and several homes for the aged and infirm. The city is the seat of a Protestant Episcopal bishop. Quincy is the industrial and commercial centre of a large region. The value of factory products in 1905 was \$10,748,224, an increase of 35.7 per cent. since 1900. Among

the manufactures are stoves and furnaces, foundry and machine shop products, carriages and wagons, flour and grist mill products, malt liquors, dairymen's and poulterers' supplies, show-cases, men's clothing, agricultural implements, saddlery and harness, and lumber.

In 1822 John Wood (1798-1880), the first white settler, built a log cabin here, and in 1825, Quincy, then having less than ten inhabitants, was made the county-seat of Adams county, both town and county being named through Wood's influence in honour of John Quincy Adams. Wood was lieutenant-governor of the state in 1857-1860, and acting-governor in 1860-1861. A bronze statue (dedicated in 1883) in his memory stands in Washington Park. There was a general hospital of the United States Army in Quincy during the Civil War. Quincy was incorporated as a town in 1834, and was chartered as a city in 1839.

QUINCY, a city of Norfolk county, Massachusetts, situated on Massachusetts Bay, and separated from Boston by the Neponset river on the N. and from Weymouth by Fore river on the S. Pop. (1890) 16,723; (1900) 23,899, of whom 7662 were foreign-born; (1910 census) 32,642; area, about 16 sq. m. It is served by the New York, New Haven & Hartford railway, and by an interurban electric line. To a large degree Quincy is a residential suburb of Boston. The birthplaces of John Adams, built in 1681, and of John Quincy Adams, built in 1716, are still standing. The Stone Temple, or First (Unitarian) Congregational Church, is the burial-place of the two Adamses. Quincy was also the home of Charles Francis Adams. John Adams gave to the town his valuable private library, and in 1822 founded here the Adams Academy for boys (now closed). In the home of Josiah Quincy (1802-1882) in Wollaston Park is the Quincy Mansion School for Girls. Woodward Institute (1894) is an endowed high school for girls. The public school system, the "Quincy System," was made famous in 1875-1880 by Col. Francis Wayland Parker (1837-1902), who abolished learning lessons by rote, and introduced Froebelian principles. A public library was opened in 1871, and in 1882 it was housed in the Crane Memorial Hall, designed by H. H. Richardson, and given by the family of Thomas Crane (1803-1875), who had spent his early youth in the town, but had lived in New York City from 1827 until his death. The library contained about 26,000 volumes in 1908. The city has a fine system of parks, among them being Merrymount and Faxon, the latter named in honour of the family of Henry H. Faxon, who in 1882 secured a negative vote by the town to the question whether "licenses be granted for the sale of intoxicating liquors"; subsequently there has been a similar vote each year. The manufactures of Quincy were long unimportant, with the exception of "Quincy granite,"¹ which was first quarried in 1825,—this being the first "systematic siliceous crystalline rock quarrying" in New England—and of which the output in the form of tombstones and monuments in 1905 was valued at \$2,018,198, and in the form of "marble and stone work" was valued at \$364,924. But manufacturing rapidly increased in importance between 1900 and 1905; in this period the value of factory products increased 198.2%, to \$8,982,446, and the capital invested increased 389%, to \$9,220,870. Quincy granite, a hornblende, pyroxene, bluish or greyish, without mica, was used for the construction of the Bunker Hill monument at Charlestown (in 1826), and of King's Chapel, Boston; and for interior decorations it has found some use, for example in the Philadelphia city buildings. Engines, and iron and steel ships are built at a shipyard² on the Fore river, and tubular rivets and studs, gearing, foundry products, and translucent fabrics are among the city's other products.

¹ Since 1877 the *Granite Cutters' Journal* has been published here by the Granite Cutters' International Association of America. For a description of the granite quarried in the vicinity of Quincy, see T. N. Dale, *The Chief Commercial Granites of Mass., New Hampshire and Rhode Island* (Washington, 1908), Bulletin 354 of the U.S. Geol. Survey.

² Here were built various vessels of the U.S. Navy, including the battleship "North Dakota."

The site of the present city was settled in 1625 as Merry Mount or Mount Wollaston by Thomas Morton (*q.v.*)—the present Wollaston Heights is a part of the grant of 600 acres made in 1636 by the town of Boston to William Hutchinson, husband of Anne, the Antinomian, and was formerly known as Taylor's Hill. A Puritan settlement was made here in 1634. This first settled part of Braintree (*q.v.*)—a name given in 1640 to the community then organized—after 1708 was officially called the North Precinct of the Town of Braintree; here the Adamses and the Hancocks lived, and Quincy was the birth-place of John Hancock—in a house on Hancock lot lived the first Josiah Quincy; the Mount Wollaston farm was a legacy to John Quincy (1689–1767), in whose honour the township was named on its separation from the township of Braintree in 1792, and whose name was borne by his great grandson, John Quincy Adams. In 1826 a railway about 4 m. long to the Neponset river was built here—the first in New England—for carrying granite from the quarries to tide-water; the cars were drawn by horses. The township had previously been engaged in maritime pursuits, agriculture, and the manufacture of leather. Township government, owing to the abolition of the committee on general business and the consequent confusion of handling so many and minute details, and to the addition to the population of a large Irish element and a large New Hampshire element, both workmen in the quarries, reached the minimum of efficiency in 1840–1870; in 1870, however, the town-meetings were reformed, and in 1874 a committee to consider business details was again appointed. In 1888 Quincy was chartered as a city.

See "A Study of Church and Town Government," by C. F. Adams, in the second volume of his *Three Episodes of Massachusetts History* (Boston, 1892), for an admirable history of the community; his *Centennial Milestone, an Address in Commemoration of the One Hundredth Anniversary of the Incorporation of Quincy, Mass.* (Cambridge, Massachusetts, 1892); D. M. Wilson, *Quincy, Old Braintree and Merry Mount* (Boston, 1907), and *Where American Independence Began* (Boston, 1902); and D. M. Wilson and C. F. Adams, *Col. John Quincy of Mount Wollaston, 1689–1767* (Quincy, 1909), published by the Quincy Historical Society, and containing addresses made at the celebration in February 1908 in honour of Col. Quincy; and W. S. Pattee, *History of Old Braintree and Quincy* (Quincy, 1878).

QUINET, EDGAR (1803–1875), French historian and man of letters, was born at Bourg-en-Bresse, in the department of the Ain, France, on the 17th of February 1803. His father, Jerome Quinet, had been a commissary in the army, but being a strong republican and disgusted with Napoleon's usurpation, he gave up his post and devoted himself to scientific and mathematical study. Edgar, who was an only child, was much alone, but his mother (Eugénie Rozat Lagis, who was a person of education and strong though somewhat unorthodox religious views) exercised great influence over him. He was sent to school first at Bourg and then at Lyons. His father wished him on leaving school to go into the army, and then suggested business. But Quinet was determined upon literature, and after a time got his way. His first publication, the *Tablettes du juif errant*, appeared in 1823. Being struck with Herder's *Philosophie der Geschichte*, he undertook to translate it, learnt German for the purpose, published his work in 1827, and obtained by it considerable credit. At this time he was introduced to Cousin, and made the acquaintance of Michelet. He had visited Germany and England before the appearance of his book. Cousin procured him a post on a government mission to the Morea in 1829, and on his return he published in 1830 a book on *La Grèce moderne*. Some hopes of employment which he had after the revolution of February were frustrated by the reputation of speculative republicanism which he had acquired. But he joined the staff of the *Revue des deux mondes*, and for some years contributed to it numerous essays, the most remarkable of which was that on *Les Épopées françaises du XIIIème siècle*, an early, though not by any means the earliest, appreciation of the long-neglected *chansons de geste*. *Ahasvérus*, his first original work of consequence, appeared in 1833. This is a singular prose poem, in language sometimes rather bombastic

but often beautiful. Shortly afterwards he married Minna Moré, a German girl with whom he had fallen in love some years before. Then he visited Italy, and, besides writing many essays, produced two poems, *Napoléon* (1835) and *Prométhée* (1838), which being written in verse (of which he was not a master) are inferior to *Ahasvérus*. In 1838 he published a vigorous reply to Strauss's *Leben Jesu*, and in that year he received the Legion of Honour. In 1839 he was appointed professor of foreign literature at Lyons, where he began the brilliant course of lectures afterwards embodied in the *Génie des religions*. Two years later he was transferred to the Collège de France, and the *Génie des religions* itself appeared (1842).

Quinet's Parisian professorship was more notorious than fortunate, owing, it must be said, to his own fault. His chair was one of Southern Literature, but, neglecting his proper subject, he chose, in conjunction with Michelet, to engage in a violent polemic with the Jesuits and with Ultramontanism. Two books bearing exactly these titles appeared in 1843 and 1844, and contained, as was usual with Quinet, the substance of his lectures. These excited so much disturbance, and the author so obstinately refused to confine himself to literature proper, that in 1846 the government put an end to them—a course which was not disapproved by the majority of his colleagues. By this time Quinet was a pronounced republican, and something of a revolutionist. He appeared in arms during the disturbances which overthrew Louis Philippe, and was elected by the department of the Ain to the Constituent and then to the Legislative Assembly, where he figured among the extreme radical party. He had published in 1848 *Les Révolutions d'Italie*, one of his principal though not one of his best works. He wrote numerous pamphlets during the short-lived Second Republic, attacked the Roman expedition with all his strength, and was from the first an uncompromising opponent of Prince Louis Napoleon. He was banished from France after the *coup d'état*, and established himself at Brussels. His wife had died some time previously, and he now married Mademoiselle Asaky, the daughter of a Roumanian poet. At Brussels he lived for some seven years, during which he published *Les Esclaves* (1853), a dramatic poem, *Marnix de Sainte-Aldégonde* (1854), a study of that Reformer in which he very greatly exaggerates Sainte-Aldégonde's literary merit, and some other books. He then moved to Veytaux, on the shore of the Lake of Geneva, where he continued to reside till the fall of the empire. Here his pen was busier than ever. In 1860 appeared a singular book, somewhat after the fashion of *Ahasvérus*, entitled *Merlin l'enchanteur*, in 1862 a *Histoire de la campagne de 1815*, in 1865 an elaborate book on the French Revolution, in which the author, republican as he was, blamed the acts of the revolutionists unsparingly, and by that means drew down on himself much wrath from more thoroughgoing partisans. Many pamphlets date from this period, as does *La Création* (1870), a third book of the class of *Ahasvérus* and *Merlin*, but even vaguer, dealing not with history, legend, or philosophy, but with physical science for the most part.

Quinet had refused to return to France to join the liberal opposition against Napoleon III., but immediately after Sedan he returned. He was then restored to his professorship, and during the siege wrote vehemently against the Germans. He was elected deputy by the department of the Seine in 1871, and was one of the most obstinate opponents of the terms of peace between France and Germany. He continued to write till his death, which occurred at Versailles on the 27th of March 1875. *Le Siège de Paris et la défense nationale* appeared in 1871, *La République* in 1872, *Le Livre de l'exilé* in the year of its author's death and after it. This was followed by three volumes of letters and some other work. Quinet had already in 1858 published a semi-biographic book called *Histoire de mes idées*.

Quinet's character was extremely amiable, and his letters to his mother, his accounts of his early life, and so forth, are likely always to make him interesting. He was also a man of great moral conscientiousness, and as far as intention went perfectly disinterested. As a writer, his chief fault is want of concentration;

as a thinker and politician, vagueness and want of practical determination. His historical and philosophical works, though showing much reading, fertile thought, abundant facility of expression, and occasionally, where prejudice does not come in, acute judgment, are rather (as not a few of them were in fact) reported lectures than formal treatises. His rhetorical power was altogether superior to his logical power, and the natural consequence is that his work is full of contradictions. These contradictions were, moreover, due, not merely to an incapacity or an unwillingness to argue strictly, but also to the presence in his mind of a large number of inconsistent tastes and prejudices which he either could not or would not co-ordinate into an intelligible creed. Thus he has the strongest attraction for the picturesque side of medievalism and catholicity, the strongest repulsion for the restrictions which medieval and Catholic institutions imposed on individual liberty. He refused to submit himself to any form of positive orthodoxy, yet when a man like Strauss pushed unorthodoxy to its extreme limits Quinet revolted. As a politician he acted with the extreme radicals, yet universal suffrage disgusted him as unreasonable in its principle and dangerous in its results. His pervading characteristic, therefore, is that of an eloquent vagueness, very stimulating and touching at times, but as deficient in coercive force of matter as it is in lasting precision and elegance of form. He is less inaccurate in fact than Michelet, but he is also much less absorbed by a single idea at a time, and the result is that he seldom attains to the vivid representation of which Michelet was a master.

BIBLIOGRAPHY.—His numerous works appeared in a uniform edition of twenty-eight volumes (1877-79). His second wife, in 1870, published certain *Mémoires d'exil*, and *Lettres d'exil* followed in 1885. In that year Prof. George Saintsbury published a selection of the *Lettres à sa mère* with an introduction. For many years Quinet received little attention in France, but it was revived, though not very strongly, by the publication in 1899 of Madame Quinet's *Cinquante ans d'amitié* (that between her husband and Michelet), and by the centenary of his birth. On this latter (1903) appeared *A l'occasion du centenaire*, by E. Ledrain; see also *Libres Penseurs religieux*, by E. Paris (1905). There is in English an elaborate *Early Life and Writings of Edgar Quinet*, by R. Heath (London, 1881).

QUININE, the most important alkaloid contained in cinchona bark (see CINCHONA). In 1810 Gomez of Lisbon obtained a mixture of alkaloids which he named cinchonino, by treating an alcoholic extract of the bark with water and then adding a solution of caustic potash. In 1820 Pelletier and Caventou proved that the cinchonino of Gomez contained two alkaloids, which they named quinine and cinchonine. Later quinidine and cinchonidine were discovered, and subsequently several other alkaloids, but in smaller quantity.

Chemistry.—The alkaloids exist in the bark chiefly in combination with cinchotannic and quinic acids. The cinchotannic acid apparently becomes altered by atmospheric oxidation into a red-colouring matter, known as cinchono-fulvic or cinchona red, which is very abundant in some species, as in *C. succirubra*. For this reason those barks which, like *C. Calisaya*, *C. officinalis*, and *C. Ledgeriana*, contain but little colouring matter are preferred, the quinine being more easily extracted from them in a colourless form. The exact mode of extraction adopted by manufacturers is secret. That hitherto adopted by the Indian Government for the preparation of the cinchona febrifuge (see below) is simple, but the whole of the alkaloid present in the bark is not obtained by it. This method is to exhaust the powdered bark with water acidulated with hydrochloric acid and then to precipitate the alkaloids by caustic soda. Another method consists in mixing the powdered bark with milk of lime, drying the mass slowly with frequent stirring, exhausting the powder with boiling alcohol, removing the excess of alcohol by distillation, adding sufficient dilute sulphuric acid to dissolve the alkaloid and throw down colouring matter and traces of lime, &c., filtering, and allowing the neutralized liquid to deposit crystals. The sulphates of the alkaloids thus obtained are not equally soluble in water, and the quinine sulphate can be separated by fractional crystallization, being less soluble in water than the other sulphates.

Quinine of commerce is the neutral sulphate, $C_{20}H_{24}N_2O_7 \cdot H_2SO_4 \cdot 8H_2O$, which occurs in commerce in the form of very light slender white acicular crystals. It is soluble in about 780 parts of cold water, but in 30 of boiling water, 60 of rectified spirit (sp. gr. 0.83), and 40 of glycerin. Its solubility in water is lessened by sodium or magnesium sulphate, but is increased by potassium nitrate, ammonium chloride, and most acids. It is not soluble in fixed oils or in ether, although the pure alkaloid is soluble in both. It becomes phosphorescent on trituration. When prescribed it is generally rendered more soluble in water by the addition of dilute sulphuric acid or of citric acid, one drop of the former or $\frac{1}{4}$ ths of a grain of the latter being used for each grain of the quinine sulphate. Quinine is precipitated from its solution by alkalis and their carbonates. It is, however, very soluble in excess of ammonia.

The acid solution of sulphate of quinine is fluorescent, especially when dilute; and it is laevo-rotatory. When a solution of chlorine is first added and then ammonia an emerald green colour, due to the formation of thallicoquin, is developed. This test answers with a solution containing only 1 part of quinine in 5000, or in a solution containing not more than $\frac{1}{10000}$ part if bromine be used instead of chlorine. The fluorescence is visible in an acid solution containing 1 part in 200,000 of water. By adding an alcoholic solution of iodine to a solution of the sulphate in acetic acid a compound known as herapathite, $4Qu \cdot 3H_2SO_4 \cdot 2HI \cdot 4 \cdot 6H_2O$, is obtained, which possesses optical properties similar to those of tourmaline; it is soluble in 1000 parts of boiling water; and its sparing solubility in cold alcohol has been utilized for estimating quinine quantitatively. The other alkaloids are distinguished from quinine thus: quinidine resembles quinine, but is dextro-rotatory, and the iodide is very insoluble in water; the solution of cinchonidine, which is laevo-rotatory, does not give the thallicoquin test, nor fluorescence; cinchonine resembles cinchonidine in these respects, but is dextro-rotatory.

Commercial sulphate of quinine frequently contains from 1 to 10% of cinchonidine sulphate, owing to the use of barks containing it. The sulphate of cinchonidine is more soluble than that of quinine; and, when 1 part of quinine sulphate suspected to contain it is nearly dissolved in 24 parts of boiling water, the sulphate of quinine crystallizes out on cooling, and the cinchonidine is found in the clear mother liquor, from which it can be precipitated by a solution of potassium and sodium tartrate. Samples of quinine in which cinchonidine is present usually contain a smaller percentage of water than the pure sulphate. Traces of quinidine are also sometimes, though rarely, found in commercial quinine, but its presence does not detract in a medicinal point of view from the value of the latter.

Owing to its voluminous character as much as 18% of water may remain present in apparently dry samples of sulphate of quinine. If it loses more than 14.6% of water when dried at 100°C. it contains an excessive amount of moisture. Owing to its variability in this respect, and to its insolubility, certain other salts have largely replaced the sulphate in modern medicine.

Sulphate of quinine manufactured from cuprea bark (*Remijia pedunculata*) may contain from .10 to .90% of sulphate of homoquinine, which almost coincides in solubility with sulphate of quinine. Homoquinine is decomposed on treatment with caustic soda into quinine and a new alkaloid, cupreine, in the proportion of 2 to 3. Cupreine is soluble in a solution of caustic soda (differing in this respect from quinine), and therefore it is easy to prepare sulphate of quinine perfectly free from either homoquinine or cupreine. The medicinal properties of cupreine and homoquinine are of no practical importance.

In consequence of the high price of the alkaloid an attempt was made some years ago by the Government of India to manufacture from cinchona bark a cheap febrifuge which should represent the alkaloids contained in the bark and form a substitute for quinine. This mixture is known as cinchona febrifuge, and is prepared chiefly from *C. succirubra*, which succeeds better in India than the other species in cultivation, and grows at a lower elevation, being consequently procurable in large quantities at a comparatively low price. A mixture of the cinchona alkaloids, consisting principally of cinchonidine sulphate, with smaller quantities of the sulphates of quinine and cinchonine, is sold under the name of "quinetum" at a cheaper rate than quinine.

The chemical constitution of quinine and the allied alkaloids is not definitely settled, although certain relationships are well established. Thus quinine is methoxycinchonine or methylcupreine, cupreine being an oxycinchonine. These relations are shown by the formulae:—cinchonine = $C_{19}H_{21}N_2 \cdot OH$; cupreine = $C_{19}H_{20}N_2(OH)_2$; quinine = $C_{19}H_{20}N_2(OH)(OCH_3)$. Cinchonine yields on oxidation cinchoninic acid (γ -quinoline carboxylic acid), $C_9H_8N \cdot CO_2H$, whilst quinine gives quininic acid, $C_9H_8(OCH_3)(CO_2H)$. This permits the writing of cinchonine, for example, as $C_9H_8N \cdot C_{10}H_{12}(OH)N$, the hydroxy group being in the part $\cdot C_{10}H_{12}(OH)N$, about which the constitution is uncertain. The subject has been especially studied by Skraup, Königs, and von Miller; Königs and von Miller have proposed formulae consisting of a piperidine ring substituted with a vinyl group; in the former that is a bridge of $\cdot CH_2 \cdot C(OH) \cdot$ from the nitrogen atom to the γ -carbon atom, connexion with the quinoline residue being made at the

hydroxylic carbon atom through a $\cdot\text{CH}_2\cdot$ group: whilst in the latter the piperidine ring is substituted by a methyl group in addition to the vinyl group and the bridge is simply $\cdot\text{C}(\text{OH})\cdot$, with which connexion is made as before.

Medicine.—The sulphate is still used in medicine, and the British Pharmacopoeia has admitted two others, which are much more valuable—the hydrochloride and the acid hydrochloride—whilst the hydrobromide is also used. The hydrochloride—formerly known as the hydrochlorate— $\text{C}_{20}\text{H}_{24}\text{N}_2\text{O}_2\cdot\text{HCl}\cdot 2\text{H}_2\text{O}$, resembles the sulphate in appearance, the crystals being, however, somewhat larger. It is soluble in less than 40 parts of cold water, and in 3 parts of alcohol (90%). The doses are similar to those of the sulphate, but somewhat smaller, owing to its greater solubility. The acid hydrochloride is the most valuable of all salts of quinine. It is soluble in its own weight of water, and is the most rapidly and completely absorbed of all the salts of this alkaloid. It occurs in a colourless crystalline powder, having the formula $\text{C}_{20}\text{H}_{24}\text{N}_2\text{O}_2\cdot 2\text{HCl}\cdot 3\text{H}_2\text{O}$.

The sulphate of quinine used in medicine may contain up to 3% of cinchonidine, but should be free from cinchonine, quinidine and cupreine. There are four pharmacopoeial preparations. The *ferri et quininae citras*, one of the "scale preparations" of iron, is given as a haematinic and tonic in doses of about 10 grains. It is very unpleasant to take. The pharmacopoeial *pilule quininae* contains 5 parts of the sulphate in 6. The *syrupus ferri phosphatis cum quinina et strychnina* (Easton's Syrup) contains $\frac{1}{4}$ ths of a grain of quinine in each drachm, that is, in each dose. Here the quinine acts as a bitter tonic. The *tinctura quininae ammoniata* or "ammoniated quinine" is made by mixing 175 grains of quinine sulphate, 2 fluid oz. of liquor ammoniac (the pharmacopoeial solution of ammonia), and 18 fluid oz. of a 60% solution of alcohol. The dose of $\frac{1}{2}$ to 1 drachm contains little more than a grain of quinine, the antipyretic action of which is negligible. Its value in the early stages of a bronchitis or tracheitis is due to the ammonia. The small quantity of quinine it contains is conditioned by the solubility of the alkaloid, which is precipitated when this tincture is diluted with water. No particular value attaches to the pharmacopoeial preparations of the hydrochloride.

Physiological Action.—Our knowledge of this subject is mainly due to Professor Binz of Bonn. Quinine has considerable powers as an antiseptic, this term defined for some time as indicating the power to kill bacteria. Whilst quinine possesses this power, however, it is far more potently lethal to a particular form of animal organism known as the *plasmodium malariae*. Against the bacteria quinine is not at all an exceptionally powerful antiseptic, though more powerful than carbonic acid. Many bacteria are killed by a 2% solution of the alkaloid. Quinine does not affect the unbroken skin, and cannot be absorbed from it, but it is slightly irritant to the pain-conducting nerves of a raw surface.

The first feature of the internal action of quinine is its intensely bitter taste. This induces a reflex secretion from the salivary and gastric glands, which is followed or accompanied by increased vascularity of the gastric mucous membrane, and by some degree of activity on the part of the muscular wall of the stomach. This means that the appetite is strengthened, and digestion rendered more rapid and complete. In this sense alone quinine is a tonic. The hydrochloric acid of the gastric juice is stated to convert any salt of quinine into a chloride, and it seems probable that the absorption of quinine takes place mainly from the stomach, for when the drug reaches the alkaline secretions of the duodenum it is precipitated, and probably none of it is thereafter absorbed. The greater part of a dose of quinine sulphate administered by the mouth may be recovered, as a rule, from the faeces, this being much the most wasteful method of giving quinine. The absorption of the acid hydrochloride is much more complete. Quinine hydrochloride circulates in the alkaline blood without precipitation, probably owing to the presence of carbonic acid in the blood.

The action of quinine on the blood itself—quite apart from its action on malarial blood—is of great complexity and importance. Whilst it is not a haematinic, in that it does not increase the number of the red blood corpuscles, it very markedly influences the stability of the compounds of the haemoglobin with oxygen. Like alcohol and prussic acid, quinine interferes with oxidation, so that oxyhaemoglobin is relatively unable to give up its oxygen to the tissues, the metabolism of which is therefore greatly modified. This property is doubtless partly—though not wholly—explanatory of the antipyretic action of quinine. The leucocytes or white blood corpuscles are very markedly affected by quinine, the characteristic "amoeboid" movements of the cells being arrested. Hence quinine stops the process of *diapedesis* or emigration of the leucocytes from the blood-vessels into the tissues, and if applied to the extravascular spaces it arrests the leucocytic movements there. The explanation that this influence on the leucocytes explained the favourable action of quinine on certain inflammatory processes no

longer holds, since we know that the inflammatory conditions are of microbic origin, and that the movements of the leucocytes are not objectionable, but highly desirable as a means of defence against bacteria and their products. Quinine, therefore, is not beneficial in inflammatory conditions as far as this particular property is concerned.

The action of quinine on the circulatory apparatus is not marked. It is only in very large doses that it weakens the intracardiac nervous ganglia, slows and weakens the pulse, and dangerously lowers the blood pressure. Similarly the depressant action on the respiratory centre in the medulla oblongata occurs only after the administration of enormous doses.

The action of quinine on the temperature is important, for it is the safest of all known antipyretics. Its action on the normal temperature is *nil*. The drug is not an *antithermal*. But when the temperature is raised, quinine will frequently lower it. The action is not due to any influence on the thermic centres, nor to any production of diaphoresis, but to the influence of quinine upon the stability of oxyhaemoglobin. Quinine was the first antipyretic used, and after the introduction of such preparations as antipyrin and acetanilide it may still be said to be the safest, though it is much less powerful. The maximum dose of the sulphate is about 40 grains, and of the acid hydrochloride about 25 grains. The temperature usually begins to fall in about two hours. The influence of quinine upon a malarial temperature is due to an entirely different cause (see below).

In some of the lower vertebrates quinine reduces the activity of the spinal cord, but in the human species it appears to stimulate the nervous mechanism of the uterus under certain conditions, and it is therefore included under the class of *oxytocic* or *ecbolic* drugs.

Quinine is excreted in some degree by nearly all the glands of the body, but mainly by the kidneys. Traces of it may be detected in the urine within an hour of its administration, and most of it is eliminated within eight or ten hours. The study of the urine is highly interesting in correlation with that of the influence of quinine upon the oxidising power of the blood, and upon the movements of the leucocytes. The amount of urea, creatin, creatinin, sulphates and phosphates in the urine is diminished, clearly showing that quinine exerts an inhibitory influence over the metabolic processes of the body. This conclusion is further confirmed by the observation that the amount of carbonic acid excreted by the lungs is also diminished. The uric acid excreted in the urine (mostly in the form of urates) is markedly diminished. This product is largely derived from the nuclei of the leucocytes, which contain large quantities of the nucleo-proteids, of which uric acid is a decomposition product. It is therefore plain that the diminution of leucocytic movement is to be regarded as a sign of diminished metabolism within the cells.

Therapeutics.—The supreme value of quinine is as a specific antidote to malaria, against which it also possesses a powerful prophylactic action. Ten or fifteen grains of the sulphate are often given three times a day for this latter purpose, and smaller doses of the much more efficacious acid hydrochloride will be found to convey even more certain immunity. In treating malaria (including ague, remittent fever, intermittent fever, and all its other forms) with this drug certain important facts are to be observed. Quinine administered by the mouth or by any other means will soon enter the blood, and will then kill the *haematoozon malariae*, whether it be free in the blood-plasma, in the leucocytes or in the red blood corpuscles. There is one exception, however. Quinine is apparently powerless to kill the organism when it is in its reproductive phase. This phase corresponds to the pyretic attack. There is therefore no purpose to be served by administering quinine during a malarial paroxysm. Two successful methods may be adopted. The quinine may be given in a single large dose—30 grains of the sulphate, or 20 of the acid hydrochloride—an hour or two before the attack is due, *i.e.* just before the parent organism in the red blood corpuscles is about to discharge the new generation of young parasites into the blood-plasma. An equally effective method, which may be combined with the above, is to give the quinine in 10-grain doses of the acid hydrochloride every four hours between the attacks. Whichever method be adopted, the paroxysm that was expected will probably not appear. After a single full dose of quinine no parasites can as a rule be observed in the blood for several days. In beginning treatment, it is well to clear the hepatic and alimentary passages by a preliminary dose of calomel combined with a secretory cholagogue, such as *enonymin* or *iridin*. The quinine treatment may be begun with success on the day following an attack. Quinine is much less efficacious in the treatment of post-malarial symptoms, such as neuralgia and haematuria, when no parasites can be detected in the blood. In such cases quinine is often inferior to arsenic.

Quinine is largely used as a bitter tonic in doses of about half a grain. The acid hydrochloride is the best salt to employ.

Quinine has some analgesic power, and is a safe and often efficient drug in the treatment of neuralgia, even when the patient has not had malaria. Somewhat smaller doses than those given in pyrexia should be employed.

Cinchonism is the name applied to the congeries of toxic symptoms which follow the prolonged administration of quinine, but may appear after one small dose in certain persons. The symptoms closely resemble those of salicylism, and also, though in less degree, those of carbolism. The patient is deaf, but complains of ringing in the ears, which may assume various forms, especially in musical people. There is headache, which, with the continuance of the drug, becomes exceedingly severe, the vision and equilibrium are affected, and there is often some gastro-intestinal irritation. In cases where the drug has been deliberately given for its poisonous action the results are still more severe. There may be bleeding from the nose, cutaneous congestion, deafness, blindness, coma or delirium, and even death from cardiac failure. After death there is found one noteworthy lesion, a commencing acute inflammation of the internal ear. In persons who have a marked idiosyncrasy towards cinchonism, the symptoms may often be successfully averted if small doses of hydrobromic acid—10 minims of the dilute solution—are given with the quinine.

A non-official preparation of quinine—Warburg's Tincture—occasionally succeeds where the ordinary preparations fail. The dose is 1 to 4 drachms. It contains 1 part of quinine in 50. Of the thirteen or more other ingredients, there may specially be noticed the salicylic and benzoic acids.

The other alkaloids of cinchona bark—quinidine, cinchonidine, and cinchonine—also possess similar properties, but all are much less effective than quinine. This is also the case with the cinchona febrifuge prepared from *C. succirubra*.

The great disadvantage of the official preparations is the bitter taste and insolubility. It is found, however, that all the soluble salts are bitter, whilst the tasteless ones are insoluble. Substitutes may therefore be divided into those administered orally and those administered hypodermically. Of the insoluble salts we may notice the tannate, the propionic acid ester (euquinine) and carbonic acid ester (aristoquinine), the salicylic acid ester (sal^o quinine); and of the soluble substitutes, quinopyrine (a compound of quinine hydrochloride and antipyrine) and quinine hydrochloro-carbamide (a compound of quinine, urea and hydrochloric acid).

Until 1867 English manufacturers of quinine were entirely dependent upon South America for their supplies of cinchona bark, which were obtained exclusively from uncultivated trees, growing chiefly in Bolivia, Peru, and Ecuador, the principal species which were used for the purpose being *Cinchona Calisaya*; *C. officinalis*; *C. macrocalyx*, var. *Palton*; *C. Pitayensis*, *C. micrantha* and *C. lancifolia*. Since the cultivation of cinchona trees was commenced in Java, India, Ceylon and Jamaica, several other species, as well as varieties and hybrids cultivated in those countries, have been used.¹ Later, *C. lancifolia*, var. *Calisaya*, known as the calisaya of Santa Fé, was strongly recommended for cultivation, because the shoots of felled trees afford bark containing a considerable amount of quinine; *C. Pitayensis* has been introduced into the Indian plantations on account of yielding the valuable alkaloid quinidine, as well as quinine.

The first importation from India took place in 1867, since which time the cultivated bark has arrived in Europe in constantly increasing quantities, London being the chief market for the Indian barks and Amsterdam for those of Java. *Cinchona Calisaya* has also been cultivated extensively in Bolivia and in Tolima, United States of Columbia.

In order to obtain the cultivated bark as economically as possible, experiments were made which resulted in the discovery that, if the bark were removed from the trunks in alternate strips so as not to injure the cambium, or actively growing zone, a new layer of bark was formed in one year which was richer in quinine than the original bark and equal in thickness to that of two or three years' ordinary growth. This is known in commerce as "renewed bark." The process has been found to be most conveniently practised when the trees are eight years old, at which age the bark separates most easily. The yield of quinine has been ascertained to increase annually until the eleventh year, at which it seems to reach its

¹ In Java, *C. Calisaya*, vars. *anglica*, *javanica*, *Hasskarliana* and *Ledgeriana*; *C. officinalis*, var. *angustifolia*; *C. lancifolia*, *C. caloptera*, *C. micrantha* and *C. succirubra*. In India, *C. succirubra*, *C. officinalis*, vars. *angustifolia*, *crispa*, *Uritusinga* and *Bonplandiana*, and to a lesser extent *C. Calisaya*, vars. *Boliviana* and *microcarpa*; *C. micrantha*, *C. Peruviana* and *C. nitida* form only a small proportion of the plantations. Since J. E. Howard pointed out that *C. Pahudiana*, and *C. Calisaya*, vars. *javanica*, *Hasskarliana* and *anglica*, were likely to lead to disappointment as quinine-yielding species, these have been replaced in the plantations as rapidly as possible by the more valuable species, of which *C. Ledgeriana*, yielding from 5 to 10% or even more of quinine, *C. officinalis*, and a hybrid between *C. officinalis* and *C. succirubra*, which has been named *C. robusta*, are the most important.

maximum. The portion of the trunk from which the bark has been removed is sometimes protected by moss, and the new bark which forms is then distinguished by the name of "mossed bark." The species which yield the largest amount of quinine are by no means the easiest to cultivate, and experiments have consequently been made in cross-fertilization and grafting with the view of giving vigour of growth to delicate trees yielding a large amount of alkaloid or of increasing the yield in strong-growing trees affording but little quinine. Grafting, however, has not been found to answer the purpose, since the stock and the graft have been found to retain their respective alkaloids in the natural proportion just as if growing separately. Hybridization also is very uncertain, and is very difficult to carry out effectually; hence the method of propagating the best varieties by cuttings has been adopted, except in the case of those which do not strike readily, as in *C. Ledgeriana*, in which the plants are grown from the shoots of felled trees.

Some years ago it was discovered that a bark imported from Colombia under the name of cuprea bark, or "hard" bark, and derived from *Remijia pedunculata*, *Triana*, and other species, contained quinine to the extent of $\frac{1}{3}$ to $2\frac{1}{2}\%$, and in 1881 this bark was exported in enormous quantities from Santander, exceeding in amount the united importations of all the other cinchona barks; and by reason of its cheapness this has since that date been largely used for the manufacture of quinine.

Cinchona bark as imported is never uniform in quality. The South American kinds contain a variable admixture of inferior barks, and the cultivated Indian barks comprise, under the respective names of yellow, pale, and red barks, a number of varieties of unequal value.

The alkaloids are contained, according to Howard, chiefly in the cellular tissue next to the liber. No definite knowledge has as yet been attained of the exact steps by which quinine is formed in nature in the tissues of the bark. From analyses of the leaves, bark and root, it appears that quinine is present only in small quantities in the leaves, in larger quantity in the stem bark, and increasing in proportion as it approaches the root, where quinine appears to decrease and cinchonine to increase in amount, although the root bark is generally richer in alkaloids than that of the stem. The altitude at which the trees are grown seems to affect the production of quinine, since it has been proved that the yield of quinine in *C. officinalis* is less when the trees are grown below 6000 ft. than above that elevation, and that cinchonidine, quinidine, and resin are at the same time increased in amount. It has also been shown by Broughton that *C. Peruviana*, which yields cinchonine but no quinine at a height of 6000 ft., when grown at 7800 ft. gives nearly as much quinine, and almost as readily, as *C. officinalis*. Karsten also ascertained by experiments made at Bogotá on *C. lancifolia* that the barks of one district were sometimes devoid of quinine, while those of the same species from a neighbouring locality yielded $3\frac{1}{2}$ to $4\frac{1}{2}\%$ of the sulphate; moreover, Dr De Vrij found that the bark of *C. officinalis* cultivated at Utakamand varied in the yield of quinine from 1 to 9%. In these cases the variation may have been due to altitude. Free access of air to the tissues also seems to increase the yield of quinine, for the renewed bark is found to contain more quinine than the original bark.

QUINOLINE (Benzopyridine), C_8H_7N , an organic base first obtained from coal-tar in 1834 by F. Runge (*Pogg. Ann.*, 1834, 31, p. 68), and later by C. Gerhardt by the distillation of cinchonine, quinine and other alkaloids with caustic potash (*Ann.*, 1842, 42, p. 310; 44, p. 279). It also occurs with pyridine and its homologues in bone-oil. It may be prepared by distilling cinchoninic acid with lime; by the reduction of ortho-aminocinnamic aldehyde (A. Baeyer and V. Drewson, *Ber.*, 1883, 16, p. 2207); by passing the vapour of allyl aniline over heated lead oxide; by the condensation of ortho-aminobenzaldehyde with acetaldehyde in the presence of aqueous caustic soda (P. Friedländer and C. F. Gohring, *Ber.*, 1882, 15, p. 2572; 1883, 16, p. 1833); by the action of ortho-toluidine on glyoxal at 150° C. (V. Kulisch, *Monats.*, 1894, 15, p. 276); by the action of phosphorus pentachloride on hydrocarbostyryl (the inner anhydride of ortho-aminohydrocinnamic acid), the chlorinated compound first formed being then reduced by hydriodic acid (A. Baeyer):

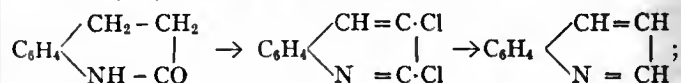

and by the so-called "Skraup" reaction, which consists in oxidizing a mixture of aniline, glycerin and concentrated sulphuric acid, with nitrobenzene (Z. Skraup, *Monats.*, 1880, 1, p. 316; 1881, 2, p. 141). This reaction is a very violent

one, and its mechanism may probably be explained as follows: The glycerin is first converted into acrolein, which combines with the aniline to form acrolein-aniline, and this product is then oxidized by the nitrobenzene: $C_3H_5O_3 \rightarrow C_3H_4O (+C_6H_5NH_2) \rightarrow C_6H_5N:CH:CH:CH_2 \rightarrow C_9H_7N$. The nitrobenzene may be replaced by arsenic acid, when the reaction proceeds much more quietly and a cleaner product is obtained (C. A. Knuessel, *Ber.*, 1896, 29, p. 703). The Skraup reaction is a perfectly general one for primary amino-compounds; the halogen-, nitro- and oxy-anilines (aminophenols) react similarly, as do also the toluidines, naphthylamines, amino-anthracene, meta- and para-phenylene diamines, and ortho- and γ -aminoquinoline.

Quinoline is a colourless liquid with a smell resembling that of pyridine. It boils at 238° C. and is very hygroscopic. It is a tertiary base and forms well-defined salts. It is almost insoluble in water, but dissolves readily in the common organic solvents. It combines readily with the alkyl halides. H. Decker (*Ber.*, 1905, 38, p. 1144) has found that many ortho substituted quinolines will not combine with methyl iodide owing to steric hindrance, but the difficulty can be overcome in most cases by using methyl sulphate and heating the reaction components to 100° C. for half an hour. Nitric acid and chromic acid have little action on quinoline, but alkaline potassium permanganate oxidizes it to carbon dioxide, ammonia, oxalic, and quinolinic acids (S. Hoogewerff and W. A. v. Dorp, *Rec. Pays Bas*, 1882, 1, p. 107). Bleaching powder oxidizes it to chlorcarbostyryl.

It is reduced by the action of zinc and ammonia to di- and tetra-hydroquinolines. A hexahydro- and a decahydroquinoline have been obtained by heating tetrahydroquinoline with hydriodic acid and phosphorus to high temperatures (E. Bamberger, *Ber.*, 1890, 23, p. 1138). Numerous substitution products of quinoline are known, and the positions in the molecule are generally designated in accordance with the scheme shown in the inset formula: the letters *o*, *m*, *p*, *a*, standing for *ortho*-, *meta*-, *para*-, and *ana*-.

The oxyquinolines possess a certain importance owing to their relationship to the alkaloids. Those with the hydroxyl group in the benzene nucleus are prepared from the aminophenols by the Skraup reaction. Only two are known containing the hydroxyl group in the pyridine nucleus, namely, *carbostyryl* (α -oxyquinoline), which is formed by the reduction of ortho-aminocinnamic acid with ammonium sulphide (L. Chiozza, *Ann.*, 1852, 83, p. 118) or with ferrous sulphate and baryta, and *kynurine* (γ -oxyquinoline), which is obtained by the action of nitrous acid on γ -aminoquinoline (A. Claus and H. Howitz, *Jour. prak. Chem.*, 1894, 158, p. 232). It is also formed by the condensation of anthranilic acid with acetaldehyde (S. Niementowski, *Ber.*, 1895, 28, p. 2811). They are both crystalline solids, the former melting when anhydrous at 199-200°, and the latter at 52° C.

Of the homologues of quinoline, the most important are quinaldine, lepidine, γ -phenylquinoline, and flavoline. *Quinaldine* (α -methylquinoline) is present in coal-tar; it may be prepared by condensing aniline with paraldehyde and concentrated hydrochloric acid (O. Doebner and W. v. Miller, *Ber.*, 1881, 14, pp. 2812 et seq.). The reaction is a perfectly general one, for the aniline may be replaced by other aromatic amines and the aldehyde by other aldehydes, and so a large number of quinoline homologues may be prepared in this way. Quinaldine may also be obtained by condensing ortho-aminobenzaldehyde with acetone in presence of caustic soda (P. Friedlander, *loc. cit.*). It is a colourless liquid which boils at 247° C. The $-CH_3$ group is very reactive, condensing readily with aldehydes and with phthalic anhydride. Potassium permanganate oxidizes it to acetylanthranilic acid, $HOOC(1)-C_6H_4(2)NH-COCH_3$, while chromic acid oxidizes it to quinaldic acid (quinoline- α -carboxylic acid). *Lepidine* (γ -methylquinoline) was first obtained by distilling cinchonine with caustic potash. It may be prepared synthetically by condensing ortho-aminooacetophenone with paraldehyde and caustic soda (L. Knorr, *Ann.*, 1886, 236, p. 69) or from aniline, acetone, formaldehyde and hydrochloric acid (C. Beyer, *Jour. prak. Chem.*, 1885, 140, p. 125). It may also be prepared by condensing $\alpha\gamma$ -dimethylquinoline and formaldehyde, the resulting α -ethanollepidine, $C_9H_9-CH_2N(CH_2-CH_2-OH)$, breaks down on heating and forms lepidine (W. Königs and A. Mengel, *Ber.*, 1904, 37, p. 1322). It is a colourless liquid which boils at 255° C. Chromic acid oxidizes it to cinchoninic acid (see below), whilst potassium permanganate oxidizes it to lepidinic acid (γ -methylquinolinic acid) and cinchomeronic acid (see PYRIDINE). γ -Phenylquinoline, which is probably the parent substance

of the cinchona alkaloids, is prepared by heating γ -phenylquinaldic acid, the oxidation product of the γ -phenylquinaldine, which results from the action of alcoholic potash on a mixture of ortho-aminobenzophenone and acetone (W. Königs and R. Geigy, *Ber.*, 1885, 18, p. 2400), or by the action of sulphuric acid on benzoyl-acetone anilide (C. Beyer, *Ber.*, 1887, 20, p. 1767). It crystallizes in needles which melt at 61° C. *Flavoline* (α -phenyl- γ -methylquinoline) is formed on heating flavenol (see below) with excess of zinc dust, or by heating molecular proportions of ortho-aminoacetophenone and acetophenone, in dilute alcoholic solution, with a small quantity of 10% caustic soda solution (O. Fischer, *Ber.*, 1886, 19, p. 1037). Closely related to flavoline is *flavaniline* or (α)-para-aminophenyl- γ -methylquinoline, which is formed when acetanilide and anhydrous zinc chloride are heated together for many hours at 250-270° C. (O. Fischer and C. Rudolph, *Ber.*, 1882, 15, p. 1500), or by heating ortho- and para-aminoacetophenone with zinc chloride to 90° C. (O. Fischer, *Ber.*, 1886, 19, p. 1038). It crystallizes from benzene in prisms, which melt at 97° C. Sodium nitrite in the presence of excess of acid converts it into the corresponding hydroxylic compound *flavenol*.

The oxy derivatives of the quinoline homologues are best obtained from the aniline derivatives of β -ketic acids. At 110° C. aniline and acetoacetic ester condense to form anilido-acetoacetic ester, $CH_3CO-CH_2-CO-NH-C_6H_5$, which is converted by concentrated acids into α -oxy- γ -methylquinoline (L. Knorr, *Ann.*, 1886, 236, p. 73). On the other hand, at about 240° C., the amine and ester react to form β -anilidocrotonic ester, $CH_3C(NHC_6H_5):CH-COOC_2H_5$, which yields γ -oxy- α -methylquinoline (M. Conrad and L. Limpach, *Ber.*, 1887, 20, p. 947).

Numerous carboxylic acids of quinoline are known, the most important of which are quinaldic, cinchoninic and acridinic acids. *Quinaldic acid* (quinoline- α -carboxylic acid) is produced when quinaldine is oxidized by chromic acid. It crystallizes in needles, which contain two molecules of water of crystallization, and melt at 156° C. When heated above the melting-point it loses carbon dioxide and yields quinoline. Alkaline potassium permanganate oxidizes it to pyridine tricarboxylic acid (2-3-6). *Cinchoninic acid* (quinoline- γ -carboxylic acid) is formed when cinchonine is oxidized by nitric acid, or by the oxidation of lepidine. It crystallizes from water in needles or prisms and in the anhydrous state melts at 253-254° C. Potassium permanganate oxidizes it to pyridine tricarboxylic acid (2-3-4). *Acridinic acid* (quinoline- $\alpha\beta$ -dicarboxylic acid) is formed when acridine is oxidized by potassium permanganate (C. Graebe and H. Caro, *Ber.*, 1880, 13, p. 100). It crystallizes in needles, which are easily soluble in alcohol, and when heated above 130° C. lose carbon dioxide and leave a residue of quinoline- β -carboxylic acid.

Isoquinoline, isomeric with quinoline, was first discovered in coal-tar in 1885 by S. Hoogewerff and W. A. v. Dorp (*Rec. Pays Bas*, 1885, 4, 125); its formula is shown in the inset. It may be separated from the quinoline which accompanies it by means of the difference in the solubility of the sulphates of the two compounds, isoquinoline sulphate being much less soluble than quinoline sulphate. It may be prepared by passing the vapour of benzylidene ethylamine through a red-hot tube (A. Pictet and S. Popovici, *Ber.*, 1892, 25, p. 733); by the action of concentrated sulphuric acid on benzyl amino-acetaldehyde, $C_6H_5-CH_2-NH-CH_2-CHO$ (E. Fischer), or on benzylidene amino-acetal, $C_6H_5CH:N \cdot CH_2 \cdot CH(OC_2H_5)_2$ (C. Pomeranz, *Monats.*, 1892, 14, p. 116); by heating cinnamyl aldoxime with phosphorus pentoxide to 70° C. (E. Bamberger, *Ber.*, 1894, 27, p. 1955), $C_6H_5CH:CH-CH:NOH \rightarrow [C_6H_5CH:CH-NH-COH] \rightarrow C_8H_7N$; by the action of hydriodic acid on the oxydichlorisoquinoline formed when phosphorus pentachloride reacts with hippuric acid; by the distillation of homophthalimide over zinc dust (M. Le Blanc, *Ber.*, 1888, 21, p. 2299), or by treatment with phosphorus oxychloride followed by the reduction of the resulting dichlorisoquinoline with hydriodic acid (S. Gabriel, *Ber.*, 1886, 19, pp. 1655, 2355):

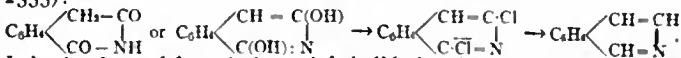

It is also formed from isobenzaldehyde by the action of ammonia, followed by phosphorus oxychloride and reduction of the chlorinated product (S. Gabriel),

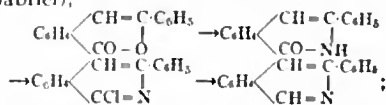

and from isocoumarin carboxylic acid by conversion into isocarbostyryl on heating, and subsequent reduction by distillation with zinc dust (E. Bamberger, *Ber.*, 1892, 25, p. 1138). It melts at 22-23° C. and boils at 240° C., and behaves in most respects similarly to quinoline. By oxidation with alkaline potassium permanganate it yields phthalic acid and cinchomeronic acid. Reduction by means of tin and hydrochloric acid gives a tetrahydro derivative.

Numerous derivatives of isoquinoline are obtained in the decomposition of various vegetable alkaloids. Papaverine on fusion

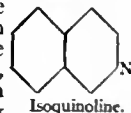
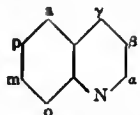

with alkalis yields a dimethoxyisoquinoline, whilst hydrohydrastinine, hydrocotarnine and the salts of cotarnine may be considered as derivatives of reduced isoquinolines (see OPIUM).

QUINONES, in organic chemistry, a group of compounds in which two hydrogen atoms of a benzene nucleus are replaced by two oxygen atoms. This replacement may take place either in the ortho or para positions, giving rise to orthoquinones or to paraquinones; metaquinones do not appear to have been isolated. The para or true quinones are obtained by the oxidation of hydrocarbons with chromic acid or of various para di-derivatives of benzene with chromic acid mixture, such, for example, as para-aminophenol, para-phenylene diamine, para-aminoazobenzene, &c. H. v. Pechmann (*Ber.*, 1888, 21, p. 1417) has shown that α -diketones are converted into paraquinones by the action of warm solutions of the caustic alkalis, diacetyl yielding para-xyloquinone:

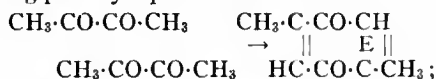

whilst P. H. Bayrac (*Bull. soc. chim.*, 1894 (3) 11, p. 1129) obtained anilino-derivatives of the paraquinones by the action of an aqueous solution of potassium chromate on an acetic acid solution of para-aminodimethylaniline and phenol: $\text{C}_6\text{H}_5\text{OH} + \text{H}_2\text{N}\cdot\text{C}_6\text{H}_4\cdot\text{N}(\text{CH}_3)_2 \rightarrow \text{O}\cdot\text{C}_6\text{H}_4\cdot\text{N}\cdot\text{C}_6\text{H}_4\cdot\text{N}(\text{CH}_3)_2$; these compounds yield the quinone when heated with mineral acids.

The paraquinones are generally crystalline solids of a yellowish colour, having a characteristic sharp odour and being volatile in steam. They are readily reduced to the corresponding hydroquinones or para-dihydroxy-benzenes, and also combine with hydroxylamine hydrochloride to form nitrosophenols, $\text{ON}\cdot\text{C}_6\text{H}_4\cdot\text{OH}$, which can further yield quinone dioximes, $\text{HON}\cdot\text{C}_6\text{H}_4\cdot\text{NOH}$. Paraquinones also combine with ammonia and with amines yielding amino-derivatives and hydroquinones. The orthoquinones more resemble the α -diketones; they are crystalline solids of a red or yellow colour, but differ from the paraquinones in being devoid of smell and not volatile in a current of steam.

Benzoquinone (para) or ordinary quinone, $\text{C}_6\text{H}_4\text{O}_2$, is formed by the oxidation of aniline with sodium bichromate and sulphuric acid. It sublimes in golden yellow needles. Hot concentrated nitric acid oxidizes it to picric acid and oxalic acid, whilst on treatment with hydrochloric acid and potassium chlorate it yields chloranil (tetrachloroquinone). It combines directly with two and four atoms of bromine. Free hydroxylamine reduces it to hydroquinone. It combines directly with aniline to form dianilidoquinone, dianilidoquinone-anil and dianilidoquinone-dianil or azophenine. Two alternative structural formulae have been given to benzoquinone, namely:

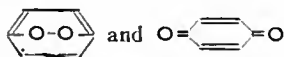

The former, due to C. Graebe (*Zeit. f. Chemie*, 1867, 3, p. 39), ascribes to the molecule a peroxide configuration which accounts for its oxidizing powers but not for the fact that each oxygen atom is capable of replacement by one atom of chlorine. The second formula, due to R. Fittig (*Ann.*, 1876, 180, p. 23) readily explains the formation of the mono- and di-oximes of quinone and also that it readily combines with bromine.

Quinone-chlorimide, $\text{ClN}\cdot\text{C}_6\text{H}_4\cdot\text{O}$, is obtained when para-aminophenol is oxidized with bleaching powder. It is a yellow crystalline solid readily volatile in steam. The dichlorimide, $\text{ClN}\cdot\text{C}_6\text{H}_4\cdot\text{NCl}$, is formed in a similar manner from paraphenylenediamine. It is a strong oxidizing agent. Quinone-dioxime, $\text{HON}\cdot\text{C}_6\text{H}_4\cdot\text{NOH}$, crystallizes in colourless or yellow needles, which decompose when heated to about 240°C . Potassium ferrocyanide in alkaline solution oxidizes it to dinitrosobenzene, whilst cold concentrated nitric acid oxidizes it to para-dinitrobenzene. Quinhydrone, $\text{C}_6\text{H}_4\text{O}_2\cdot\text{C}_6\text{H}_4(\text{OH})_2$, is formed by the direct union of quinone and hydroquinone or by careful oxidation of hydroquinone with ferric chloride solution. On boiling with water it decomposes into quinone and hydroquinone.

Benzoquinone (ortho).—C. L. Jackson (*Amer. Chem. Jour.*, 1901, 26, p. 10) attempted to prepare this compound by the action of iodine on the lead salt of pyrocatechin suspended in chloroform. A deep red solution was obtained, but the free quinone was not isolated since the solution on standing deposits nearly black crystals of dihydroxyphenylhydroxybenzoquinone $(\text{HO})_2\text{C}_6\text{H}_3\cdot\text{C}_6\text{H}_2\text{O}_2\cdot\text{OH}$. R. Willstätter (*Ber.*, 1904, 37, p. 4744), by dissolving pyrocatechin

in absolute ether containing ignited sodium sulphate and then adding dry silver oxide, obtained the quinone in dark red crystalline plates which decompose between 60° and 70°C .

For naphthalene quinones see NAPHTHALENE; for anthracene quinone see ANTHRAQUINONE; and for phenanthrene quinone see PHENANTHRENE.

Quinoles.—The quinoles are a series of compounds of the type $\begin{array}{c} \text{R} \\ \text{HO} \end{array} \times \begin{array}{c} \diagup \\ \diagdown \end{array} = \text{O}$, obtained by the oxidation of para-alkylated phenols with nitric acid, Caro's acid or bromine (Auwers, *Ber.*, 1897–1903; E. Bamberger, *ib.*, 1903, 36, p. 2028; Th. Zincke, *ib.*, 1895, 28, p. 3121); by the action of sulphuric acid on para-substituted phenylhydroxylamines (E. Bamberger), and by the action of the Grignard reagent on quinones (Bamberger). They are crystalline solids which are readily converted into para-alkylated phenols by reducing agents. They possess a weak acid and also an alcoholic character.

QUINOXALINES (Benzopyrazines), in organic chemistry, heterocyclic compounds containing a ring complex made up of a benzene ring and a pyrazine ring (formula I.); they are isomeric with the cinnolenes, phthalazines and quinazolines. They are formed by the condensing ortho-diamines with 1:2 diketones (Hinsberg, *Ann.*, 1887, 237, p. 327), the parent substance of the group (quinoxaline) resulting when glyoxal is so condensed, whilst substitution derivatives arise when α -ketonic acids, α -chloroketones, α -aldehyde alcohols and α -ketone alcohols are used in place of diketones.

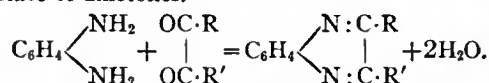

In a similar manner, diamino derivatives are formed when cyanogen is condensed with ortho-diamines, and these amino compounds readily pass into the corresponding dioxy derivatives when acted upon with dilute hydrochloric acid.

The quinoxalines are weak bases, and are stable towards oxidizing agents but are readily reduced to hydro derivatives. The tetrahydroquinoxalines are formed by condensing ortho-diamines with ortho-dihydroxy benzenes, and the keto-dihydro derivatives arise similarly by condensing mono-alkyl diamines with ketonic acids (Kehrmann and Messinger, *Ber.*, 1892, 25, pp. 1628 et seq.).

The azonium bases (formula II.) of this series are produced when the dihydroquinoxalines (obtained by similar condensations from the mono-alkyl-ortho-diamines) are oxidized with ferric chloride.

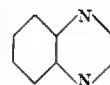

I. Quinoxaline.

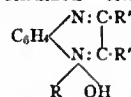

II. Azonium bases.

QUINSY, a common term for acute suppurative tonsillitis (*q.v.*). The English word (formerly "squinzey") is a corruption of Fr. *esquinancie*, from Gr. *κυνάρχη* (*κύνων*, dog, and *ἄρχειν*, to choke), and is derived from the suffocating tendency of the ailment.

QUINTAIN (O. Fr. *quintaine*, from Lat. *quintana*, a street between the fifth and sixth maniples of a camp, where warlike exercises took place), an instrument used in the age of chivalry in practising for the tournament. Originally perhaps the mere trunk of a tree upon which the knight practised his sword-strokes, as may be seen in an ancient illustration reproduced in Strutt's *Sports and Pastimes*, the quintain developed into various forms of posts at which the soldier tilted with his lance, not only on horseback but on foot and even in boats. An early form consisted of the wooden figure of a Saracen armed with shield and sword; the object being to strike the figure on the forehead directly between the eyes. This, according to Strutt, was called by the Italians "running at the armed man" or "at the Saracen." The "pel," or post-quintain, was generally about 6 ft. high.

As late as the 18th century running at the quintain survived in English rural districts. In one variation of the pastime the quintain was a tun filled with water, which, if the blow was a poor one, was emptied over the striker. A later form was a post with a cross-piece, from which was suspended a ring, which the horseman endeavoured to pierce with his lance while at full speed. This sport, called "tilting at the ring," was very popular in England and on the continent of Europe in the 17th century, and is still practised as a feature of military and equestrian sport.

QUINTANA, MANUEL JOSÉ (1772-1857), Spanish poet and man of letters, was born at Madrid on the 11th of April 1772, and after completing his studies at Salamanca was called to the bar. In 1801 he produced a tragedy, *El Duque de Visco*, founded on M. G. Lewis's *Castle Spectre*; his *Pelayo* (1805), written on a patriotic theme, was more successful. The first volume of his *Vidas de Españoles célebres* (1807-33), containing lives of Spanish patriots, stirred the public imagination and secured Quintana the post of secretary to the Cortes during the French invasion. His proclamations and odes fanned the national enthusiasm into flame. But he was ill rewarded for his services, for on the return of Ferdinand VII. he was imprisoned at Pamplona from 1814 to 1820. He was finally given a small post in the civil service, became tutor to Queen Isabella, and was nominated senator. Though publicly "crowned" as the representative poet of Spain (1855), he seems to have lived in poverty. He died on the 11th of March 1857. His poems, thirty-four in number, are inspired by philanthropy and patriotism; the style is occasionally gallicized, and the thought is not profound, but his nobility of sentiment and resounding rhetoric attract every generation of Spaniards.

See an excellent monograph by E. Piñeyro, *Manuel José Quintana, ensayo crítico y biográfico* (Paris, 1892).

QUINTESENCE, in ancient and scholastic philosophy, the name given to the fifth immaterial element, over and above the four material elements, air, water, earth and fire, which Aristotle assumed to be permeating the whole world, and called *quinta essentia*: in medieval philosophy this was called *quinta essentia*, the fifth essence, and by many was considered material and therefore capable of extraction. The ancient Indian philosophers also contain the same idea of a fifth element; thus there were five Sanskrit elements (*bhutas*), earth, wind, fire, water and aether. In the history of chemistry the name was applied, by analogy, to the most concentrated extract of a substance.

QUINTILIAN [MARCUS FABIVS QUINTILIANVS] (c. A.D. 35-95), Roman rhetorician, was born at Calagurris in Spain. Concerning his family and his life but few facts remain. His father taught rhetoric, with no great success, at Rome, and Quintilian must have come there at an early age to reside, and must have there grown up to manhood. The years from 61 to 68 he spent in Spain, probably attached in some capacity to the retinue of the future emperor Galba, with whom he returned to the capital. For at least twenty years after the accession of Galba he was at the head of the foremost school of oratory in Rome, and may fairly be called the Isocrates of his time. He also gained some, but not a great, repute as a pleader in the courts. His greatest speech appears to have been a defence of the queen Berenice, on what charge is not known. He appears to have been wealthy for a professional man. Vespasian created for him a professorial chair of rhetoric, liberally endowed with public money, and from this time he was unquestionably, as Martial calls him, "the supreme controller of the restless youth." About the year 88 Quintilian retired from teaching and from pleading, to compose his great work on the training of the orator (*Institutio Oratoria*). After two years' retirement he was entrusted by Domitian with the education of two grand-nephews, whom he destined as successors to his throne. Quintilian gained the titular rank of consul, and probably died not long before the accession of Nerva (A.D. 96). A wife and two children died early.

Such is the scanty record that remains of Quintilian's uneventful life. But it is possible to determine with some accuracy his relation to the literature and culture of his time, which he powerfully influenced. His career brings home to us the vast change which in a few generations had passed over Roman taste, feeling and society. In the days of Cicero rhetorical teaching had been entirely in the hands of the Greeks. The Greek language, too, was in the main the vehicle of instruction in rhetoric. The first attempt to open a Latin rhetorical school, in 94 B.C., was crushed by authority, and not until the time of Augustus was there any professor of the art who had been born to the full privileges of a Roman citizen. The appointment of Quintilian as professor by the chief of the state marks the last

stage in the emancipation of rhetorical teaching from the old Roman prejudices.

During the hundred years or more which elapsed between the death of Cicero and the birth of Quintilian education all over the Roman Empire had spread enormously, and the education of the time found its end and climax in rhetoric. Mental culture was for the most part acquired, not for its own sake, but as a discipline to develop skill in speaking, the paramount qualification for a public career. Rome, Italy and the provinces alike resounded with rhetorical exertions, which were promoted on all sides by professorships, first of Greek, later also of Latin rhetoric, endowed from municipal funds. The mock contests of the future orators roused a vast amount of popular interest. In Gaul, Spain and Africa these pursuits were carried on with even greater energy than at Rome. The seeds of the existing culture, such as it was, bore richer fruit on the fresh soil of the western provinces than in the exhausted lands of Italy and the East. While Quintilian lived, men born in Spain dominated the Latin schools and the Latin literature, and he died just too soon to see the first provincial, also of Spanish origin, ascend the imperial throne.

As an orator, a teacher and an author, Quintilian set himself to stem the current of popular taste which found its expression in what we are wont to call silver Latin. In his youth the influence of the younger Seneca was dominant. But the chief teacher of Quintilian was a man of another type, one whom he ventures to class with the old orators of Rome. This was Domitius Afer, a rhetorician of Nimes, who rose to the consulship. Quintilian, however, owed more to the dead than to the living. His great model was Cicero, of whom he speaks at all times with unbounded eulogy, and whose faults he could scarce bring himself to mention; nor could he well tolerate to hear them mentioned by others. The reaction against the Ciceronian oratory which had begun in Cicero's own lifetime had acquired overwhelming strength after his death. Quintilian failed to check it, as another teacher of rhetoric, equally an admirer of Cicero, had failed—the historian Livy. Seneca the elder, a clear-sighted man who could see in Cicero much to praise, and was not blind to the faults of his own age, condemned the old style as lacking in power, while Tacitus, in his *Dialogue on Orators*, includes Cicero among the men of rude and "unkempt" antiquity. The great movement for the poetization of Latin prose which was begun by Sallust ran its course till it culminated in the monstrous style of Fronto. In the courts judges, juries and audiences alike demanded what was startling, quaint or epigrammatic, and the speakers practised a thousand tricks to satisfy the demand. Oratory became above all things an art whose last thought was to conceal itself. It is not surprising that Quintilian's forensic efforts won for him no lasting reputation among his countrymen.

The *Institutio Oratoria* is one long protest against the tastes of the age. Starting with the maxim of Cato the Censor that the orator is "the good man who is skilled in speaking," Quintilian takes his future orator at birth and shows how this goodness of character and skill in speaking may be best produced. No detail of training in infancy, boyhood or youth is too petty for his attention. The parts of the work which relate to general education are of great interest and importance. Quintilian postulates the widest culture; there is no form of knowledge from which something may not be extracted for his purpose; and he is fully alive to the importance of method in education. He ridicules the fashion of the day, which hurried over preliminary cultivation, and allowed men to grow grey while declaiming in the schools, where nature and reality were forgotten. Yet he develops all the technicalities of rhetoric with a fulness to which we find no parallel in ancient literature. Even in this portion of the work the illustrations are so apposite and the style so dignified and yet sweet that the modern reader, whose initial interest in rhetoric is of necessity faint, is carried along with much less fatigue than is necessary to master most parts of the rhetorical writings of Aristotle and Cicero. Quintilian's literary sympathies are extraordinarily wide. When

obliged to condemn, as in the case of Seneca, he bestows generous and even extravagant praise on such merit as he can find. He can cordially admire even Sallust, the true fountain-head of the style which he combats, while he will not suffer Lucilius to lie under the aspersions of Horace. The passages in which Quintilian reviews the literature of Greece and Rome are justly celebrated. The judgments which he passes may be in many instances traditional, but, looking to all the circumstances of the time, it seems remarkable that there should then have lived at Rome a single man who could make them his own and give them expression. The form in which these judgments are rendered is admirable. The gentle justness of the sentiments is accompanied by a curious felicity of phrase. Who can forget "the immortal swiftness of Sallust," or "the milky richness of Livy," or how "Horace soars now and then, and is full of sweetness and grace, and in his varied forms and phrases is most fortunately bold"? Ancient literary criticism perhaps touched its highest point in the hands of Quintilian.

To comprehensive sympathy and clear intellectual vision Quintilian added refined tenderness and freedom from self-assertion. Taking him all in all, we may say that his personality must have been the most attractive of his time—more winning and at the same time more lofty than that of the younger Pliny, his pupil, into whom no small portion of the master's spirit, and even some tincture of the master's literary taste, was instilled. It does not surprise us to hear that Quintilian attributed any success he won as a pleader to his command of pathos, a quality in which his great guide Cicero excelled. In spite of some extravagances of phrase, Quintilian's lament (in his sixth book) for his girl-wife and his boy of great promise is the most pathetic of all the lamentations for bereavement in which Latin literature is so rich. In his precepts about early education Quintilian continually shows his shrinking from cruelty and oppression.

Quintilian for the most part avoids passing opinions on the problems of philosophy, religion and politics. The professed philosopher he disliked almost as much as did Isocrates. He deemed that ethics formed the only valuable part of philosophy and that ethical teaching ought to be in the hands of the rhetoricians. In the divine government of the universe he seems to have had a more than ornamental faith, though he doubted the immortality of the soul. As to politics Quintilian, like others of his time, felt free to eulogize the great anti-Caesarean leaders of the dying republic, but only because the assumption was universal that the system they had championed was gone for ever. But Quintilian did not trouble himself, as Statius did, to fling stones at the emperors Caligula and Nero, who had missed their deification. He makes no remark, laudatory or otherwise, on the government of any emperor before Domitian. No character figured more largely in the rhetorical controversies of the schools than the ideal despot, but no word ever betrayed a consciousness that the actual occupant of the Palatine might exemplify the theme. Quintilian has often been reproached with his flattery of Domitian. No doubt it was fulsome. But it is confined to two or three passages, not thrust continually upon the reader, as by Statius and Martial. To refuse the charge of Domitian's expected successors would have been perilous, and equally perilous would it have been to omit from the *Institutio Oratoria* all mention of the emperor. And there was at the time only one dialect in which a man of letters could speak who set any value on his personal safety. There was a choice between extinction and the writing of a few sentences in the loathsome court language, which might serve as an official test of loyalty.

The Latin of Quintilian is not always free from the faults of style which he condemns in others. It also exhibits many of the usages and constructions which are characteristic of the silver Latin. But no writer of the decadence departs less widely from the best models of the late republican period. The language is on the whole clear and simple, and varied without resort to rhetorical devices and poetical conceits. Besides the *Institutio Oratoria*, there have come down to us under Quintilian's name 19 longer

(ed. Lehnert, 1905) and 145 shorter (ed. Ritter, 1884) *Declamationes*, or school exercises on themes like those in the *Controversiae* of Seneca the elder. The longer pieces are certainly not Quintilian's. The shorter were probably published, if not by himself, at least from notes taken at his lessons. It is strange that they could ever have been supposed to belong to a later century; the style proclaims them to be of Quintilian's school and time. The works of Quintilian have often been edited. Of the editions of the whole works the chief is that by Burmann (1720); of the *Institutio Oratoria* that by Spalding, completed by Zumpt and Bonnell (1798-1834, 5th ed., Meister, 1882, the last volume containing a lexicon), and that by Halm (1868), and another by Meister (1886); Eng. trans., J. S. Watson (1856). The tenth book of the *Institutio Oratoria* has often been separately edited, as by Krueger (ed. 3, 1888), Peterson (1891), Bonnell, Mayor and others. (J. S. R.)

QUINTUS SMYRNAEUS, Greek epic poet, probably flourished in the latter part of the 4th century A.D. He is sometimes called Quintus Calaber, because the only MS. of his poem was discovered at Otranto in Calabria by Cardinal Bessarion in 1450. According to his own account (xii. 310), he tried his hand at poetry in his early youth, while tending sheep at Smyrna. His epic in fourteen books, known as *Tà μεθ' Ὀμηρον* or *Posthomericæ*, takes up the tale of Troy at the point where Homer's *Iliad* breaks off (the death of Hector), and carries it down to the capture of the city by the Greeks. The first five books, which cover the same ground as the *Aethiopis* of Arctinus of Miletus, describe the doughty deeds and deaths of Penthesilea the Amazon, of Memnon, son of the Morning, and of Achilles; the funeral games in honour of Achilles, the contest for the arms of Achilles and the death of Ajax. The remaining books relate the exploits of Neoptolemus, Eurypylos and Deiphobus, the deaths of Paris and Oenone, the capture of Troy by means of the wooden horse, the sacrifice of Polyxena at the grave of Achilles, the departure of the Greeks, and their dispersal by the storm. The poet has no originality; in conception and style his work is closely modelled on Homer. His materials are borrowed from the cyclic poems from which Virgil (with whose works he was probably acquainted) also drew, in particular the *Aethiopis* of Arctinus and the *Little Iliad* of Lesches.

Editio princeps by Aldus Manutius (1504); Köchly (ed. major with elaborate prolegomena, 1850; ed. minor, 1853); Z. Zimmermann (author of other valuable articles on the poet), (1891); see also Kehmptzov, *De Quinti Smyrnaei Fontibus ac Mythopoiia* (1889); C. A. Sainte-Beuve, *Étude sur . . . Quinte de Smyrne* (1857); F. A. Paley, *Quintus Smyrnaeus and the "Homer" of the tragic Poets* (1879); G. W. Paschal, *A Study of Quintus Smyrnaeus* (Chicago, 1904).

QUIPUS (*Khipus*, *Qippos*); the ancient Peruvian name for a method of recording which was in use at the time of the arrival of the Spaniards. It consisted of a cord two feet in length to which were attached a series of knotted-strings (Peruv. *quipu*, a knot) hanging like a fringe. These strings were coloured, and the knots, their number and size, their distance apart, the colours, the order in which the coloured threads hung, all had a signification, e.g. white was silver, yellow gold; white meant peace, red war, &c. In this manner a rough register of important events, of births, deaths and marriages, and other statistics was kept, the *quipus* even constituting a rude history of the people. They were also much used for conveying orders to military chiefs in the provinces.

The idea of knotted strings to aid memory is so simple that it is common to many peoples. A Pelew islander, visiting England, knotted strings as a diary of all that struck him during his travels. In the Hawaiian Islands native carriers have knotted-string records of their rounds. The Peruvian quipu is simply the perfecting of a system of mnemonics common to the Red Indians. See also WAMPUM.

QUIRE (in earlier forms *quaer*, *quair* and *quere*, from the O. Fr. *quaier*, modern *cahier*, a copy-book, manuscript book; Lat. *quaterni*, set of four, from *quattuor*), originally the term for four sheets of paper or parchment folded so as to make eight leaves, the ordinary unit in manuscripts and early printed books; the term is now chiefly applied to a twentieth part of a ream of writing paper, twenty-four sheets. In bookbinding and publishing the expression "in quires" is used of the sheets of a book when not folded or bound. "Quire" was formerly

used of a small book contained in a single quire of paper, and so is frequently found in the title of short poems, treatises, &c. A familiar example is the *Kingis Quair* of King James I. of Scotland. "Choir," a body of singers or the part of a church where the singers sit, was formerly spelled "quire," following the pronunciation of the word (See CHOIR).

QUIRINUS, the Sabine name of the god Mars, probably an adjective meaning "wielder of the spear" (Quiris, cf. Janus Quirinus). Other suggested etymologies are: (1) from the Sabine town Cures; (2) from *curia*, i.e. he was the god of the Roman state as represented by the thirty curies. A. B. Cook (*Class. Rev.* xviii., p. 368) explains Quirinus as the oak-god (*quercus*), and Quirites as the men of the oaken spear. From early times he was worshipped at Rome on the Quirinal hill, whither, according to tradition, a body of Sabines under Titus Tatius had migrated from Cures and taken up their abode. In the religious system of Numa, Quirinus and Mars were both recognized as divine beings, distinct but of similar attributes and functions; thus, like Mars, Quirinus was at once a god of war and a nature god, the protector of fields and flocks. Subsequently, at the end of the republic, Quirinus became identified with the deified Romulus, son of Mars. One of the greater flamens was attached to the service of Quirinus, a second college of Salii founded in his honour, and a festival "Quirinalia" celebrated on the 17th of February, the day of the supposed translation of Romulus to heaven. Old Roman formulæ of prayer mention a Hora Quirini, his female cult associate, afterwards identified with Hersilia, the wife of Romulus.

The name was also borne by the following saints: (1) a Roman tribune who suffered martyrdom under Hadrian; (2) a bishop of Siscia in Pannonia; (3) the patron of the Tegersee in Bavaria, beheaded in Rome in 269 and invoked by those suffering from gout. The petroleum (Quirinus-oil) found in the neighbourhood of the lake takes its name from him.

QUIRITES (literally "spearmen"; see QUIRINUS), the earliest name of the burghesses of Rome. Combined in the phrase "populus Romanus Quirites (or Quiritium)" it denoted the individual citizen as contrasted with the community. Hence *ius Quiritium* in Roman law is full Roman citizenship. Subsequently the term lost the military associations due to the original conception of the people as a body of warriors, and was applied (sometimes in a deprecatory sense, cf. Tac. *Ann.* i. 42) to the Romans in domestic affairs, *Romani* being reserved for foreign affairs. (For the distinction between Quiritary and praetorian ownership, see ROMAN LAW.)

QUITO, the capital of the republic of Ecuador, the see of an archbishopric covering the same territory, and the capital of the province of Pichincha, in lat. 0° 14' S., long. 79° 45' W., about 114 m. from the Pacific coast and 165 m. in a direct line N. E. of Guayaquil, with which it is connected by a railway completed in 1908. Pop. (1906) 50,840, of whom 1365 were foreigners, mostly Colombians. It occupies a small basin of the great central plateau formed by the volcano Pichincha on the W., the Puengasi ridge on the E., and ridges N. and S. formed by spurs from the eastern side of Pichincha. The ground upon which the city is built is uneven and is traversed from W. to E. by two deep ravines (*quebradas*), one of which is arched over in great part to preserve the alignment of the streets, the drainage of which escapes through a cleft in the ridge northward to the plain of Tumbaco. The city is in great part laid out in rectangular squares, the streets running nearly with the cardinal points of the compass. The houses of Quito are chiefly of the old Spanish or Moorish style. The building material in general use is sun-dried bricks, which in the better houses is covered with plaster or stucco. The public buildings are of the heavy Spanish type. Facing the principal square (Plaza Mayor), and occupying the whole S. side, is the cathedral; on the W. side is the government palace; on the N. the archbishop's palace; and on the E. the municipal hall. The elevation of this plaza is 9343 ft. above sea-level. The finest building in the city is the Jesuits' church, whose façade is covered with elaborate carving. Among

public institutions are the university, which occupies part of the old Jesuit college, an astronomical observatory, and eleven large monastic institutions, six of which are for nuns. One of the convents, that of San Francisco, covers a whole block, and ranks among the largest institutions of its kind in the world. A part of it is in ruins, and another part has been for some time used as military barracks by the government. The university has faculties of theology, law and medicine, and has 200 to 250 students, but it is antiquated in character and poorly supported. The eminent botanist and chemist, Dr William Jameson (1796-1872), was a member of its faculty for many years. The city has no large commercial houses, and only an insignificant export trade, chiefly hides and forest products from the wooded mountain slopes near by. Religious paintings of a medieval type are produced in large numbers and exported. The native manufactures include tanned leather, saddles, shoes, ponchos, woollen and cotton cloth, fibre sandals and sacking, blankets, coarse matting and coarse woollen carpets. Superior hand-made carpets are also made, and Quito artisans show much skill in wood carvings and in gold and silver works; the women excel in fine needlework and lace-making.

Quito derives its name from the Quitus, who inhabited the locality a long time before the Spanish conquest. In 1533 Sebastian Benalcazar took peaceable possession of the native town (which had been successively a capital of the Seyris and Incas), and in 1541 it was elevated to the rank of a Spanish city. Its full title was San Francisco del Quito, and it was capital of the province or presidency of Quito down to the end of Spanish colonial rule. It has suffered repeatedly from earthquakes, the greatest damage occurring from those of 1797 and 1859.

QUIVER, a case for holding arrows. The word is taken from O. Fr., where it appears in such forms as *quivre*, *cuevre* or *coivre*. This is apparently cognate with the O. E. *cocer*, Ger. *Köcher*, quiver or case. The ultimate origin is obscure, and the medieval Latin and Greek words *cucurum* and *κοιβουρον* are stated to be from the German. The word meaning "to shake" or "tremble" must be distinguished; this is connected with "quaver," "quake"; the *New English Dictionary* takes these words to be onomatopoeic in origin.

QUOINS (an old variant spelling of "coin," from Lat. *cuneus*, a wedge), in architecture, the term for the external angle of a building, generally applied to the ashlar masonry employed to stop the rubble masonry or brickwork of the wall at the angles, as also of buttresses, doorways or projecting features. In Saxon work the quoins were built with large stones laid horizontally and vertically in alternate courses, technically known as "long and short" work. Sometimes, to give greater importance to the angles of towers, the quoin stones are rusticated, and this treatment is found extensively employed in ancient German towns. At Eastbury Manor House in Essex, built in brick, the quoins at the angles of the walls, doorway and windows were plastered in imitation of stonework.

QUOITS (O. Fr. *coiter*, *quoiter*, to incite), a pastime resembling the ancient discus-throwing which formed one of the five games of the Greek pentathlon (see DISCUS), the two main differences between the ancient and modern sports being that the quoit is ring-shaped (one surface being rounded, the other—the back—being flat) and is lighter than the discus, and its throwing is a test rather of accuracy than strength. Few traces of a game resembling quoits can be found on the continent of Europe, and its origin may be sought for on the borderland of Scotland and England. There are references to it in the Midlands dating from the beginning of the 15th century, and it was one of the games prohibited in the reigns of Edward III. and Richard II. in favour of archery. Ascham, in his *Toxophilus* (1545), says that "quoting be too vile for scholars," and in old times it was chiefly played by the working classes, who often used horse-shoes for want of quoits, a custom still prevailing in country districts. According to the modern rules, slightly modified from the code drawn up in 1869, two iron or steel pins 18 yds. apart are driven into the ground, leaving 1 in. exposed. Each is situated in the centre of an "end," a circle of stiff clay 3 ft.

in diameter. The quoits, made of iron, may be of any weight, but are usually about 9 lb each. They must not exceed $8\frac{1}{2}$ in. in diameter, or be less than $3\frac{1}{2}$ in. in the bore, or more than $2\frac{1}{4}$ in. in the web. When delivering his quoit a player must stand within 4 ft. 6 in. of the centre of the end and at its side. Matches are played between teams or individuals, the object of the game being to throw the quoit as near to the pin as possible, a "ringer," i.e. a quoit actually surrounding the pin, counting two, and a quoit nearer to the pin than any of the adversary's, counting one. A match may be for any number of points, the team or player scoring that number first being the winner. In championship matches all quoits farther than 18 in. from the end, are foul and removed. All measurements are made from the middle of the pin to the nearest edge of the quoit. If one or more quoits are lapped, the one most accessible is first measured and withdrawn. All quoits on their backs are a foul. The general principle of curling, to drive the opponents' quoits away from the pin and place one's own near or on it, is followed.

Scotland, Lancashire and the Midlands are the principal centres of quaiting in Great Britain. In Scotland the game is patronized by the Curling Clubs, and this is also the case in the United States and Canada. Billy Hodson was champion of Great Britain in the middle of the 19th century, and his trip to America in the early 'sixties is of historical interest, as it resulted in two contests for the championship of the world with James McLaren of Newark, N. J., a native of Scotland, who was champion of America. One hard-fought match was won by each, the deciding one remaining unplayed. The championship of America is rewarded by the "Bell Medal," presented by the Grand National Curling Club of America.

QUORUM (Lat. for "of whom"), in its general sense, a term denoting the number of members of any body of persons whose presence is requisite in order that business may be validly transacted by the body or its acts be legal. The term is derived from the wording of the commission appointing justices of the peace which appoints them all, jointly and severally to keep the peace in the county named. It also runs—"We have also assigned you, and every two or more of you (of whom [quorum], any one of you the aforesaid A, B, C, D, &c., we will shall be one) our justices to inquire the truth more fully," whence the justices so-named were usually called justices of the *quorum*. The term was afterwards applied to all justices, and subsequently by transference, to the number of members of a body necessary for the transaction of its business. No general rule can be laid down as to the number of members of which a quorum should consist; its size is usually prescribed by definite enactment or provision; it is entirely a matter for self-constituted bodies as to what their quorum shall be, and it usually depends on the size of the body. In bodies which owe their existence to an act of the legislature, the necessary quorum is usually fixed by statute. In England, in the House of Lords, three form a quorum, though on a division there must be thirty members present. In the House of Commons, forty members, including the Speaker, form a quorum. The quorum of a standing committee of the House of Lords is seven, and of the House of Commons, twenty.

QUOTA, a proportional share or part that is due from or to any person or body of persons, in Med. Lat. *quota, sc. pars*, from *quotus*, an adjective formed from *quot*, how many. The word first appears in connexion with the levying of men, money or supplies for military and naval purposes from districts, towns or seaports, and thus is equivalent to "contingent" (Lat. *contingere*, to happen to, fall to one's lot or share, *cum*, with, and *tangere*, to touch), used since the 18th century specifically of a contribution of men or ships according to a scale fixed between the contracting parties.

QUOTATION, a passage repeated from the writings or speech of another. The verb "to quote" comes from Med. Lat.

quotare (from *quot*, how many), to refer to by numbers, i.e. of page, chapter, &c., also to separate into chapters, verses, &c. The term is also specifically applied to the statement of the current prices of goods and commodities, and of stocks and shares (see STOCK EXCHANGE).

Useful lists of familiar quotations may be found in the following:—H. T. Riley, *Dictionary of Latin and Greek Quotations*, ed. Bohn; P. H. Dalbiac, *Dictionary of English Quotations* (1896); in the same series, T. B. Harbottle, *Classical Quotations* (1897), and T. B. Harbottle and P. H. Dalbiac, *French and Italian Quotations* (1901); Robinson Smith, *English Quotations* (n.d.); H. P. Jones, *A New Dictionary of Foreign Phrases and Classical Quotations*; J. K. Hoyt and A. L. Ward, *The Cyclopaedia of Practical Quotations, English and Latin* (1892); Cassell's *Book of Quotations* (1901); J. Bartlett, *Familiar Quotations... in Ancient and Modern Literature* (1902); in *Notes and Queries*, the indices to the various series contain, grouped under the heading "Quotation," a large number of out-of-the-way quotations.

QUO WARRANTO, in English law, the name given to an ancient prerogative writ calling upon any person usurping any office, franchise, liberty or privilege belonging to the Crown, to show "by what warrant" he maintained his claim, the onus being on the defendant. It lay also for non-user or misuser of an office, &c. If the Crown succeeded, judgment of forfeiture or ousterlemain was given against the defendant. The procedure was regulated by statute as early as 1278 (the statute of *Quo Warranto*, 6 Edw. I. c. 1), passed in consequence of the commission of *quo warranto* issued by Edward I. A distinction was drawn in the report between *liberlates*, jurisdiction exercised by the lord as lord, and *regalia*, jurisdiction exercised by Crown grant. After a time the cumbrousness and inconvenience of the ancient practice led to its being superseded by the modern form of an information in the nature of a *quo warranto*, exhibited in the King's Bench Division either by the attorney-general *ex officio* or by the king's coroner and attorney at the instance of a private person called the relator. The information will not be issued except by leave of the court on proper cause being shown. It does not lie where there has been no user or where the office has determined. Nor does it lie for the usurpation of every kind of office. But it lies where the office is of a public nature and created by statute, even though it is not an encroachment upon the prerogative of the Crown. Where the usurpation is of a municipal office the information is regulated by 9 Anne c. 25 (1711), under which the defendant may be fined and judgment of ouster given against him, and costs may be granted for or against the relator. Such an information must, in the case of boroughs within the Municipal Corporations Act 1882, be brought within twelve months after disqualification (s. 225); in the case of other boroughs, within six years after the defendant first took upon himself the office (32 Geo. III. c. 58, s. 2). The information in the nature of a *quo warranto*, though nominally a criminal, has long been really a civil proceeding, and has recently been expressly declared to be so (Supreme Court of Judicature Act 1884, s. 15). In cases not falling within 9 Anne c. 25, judgment of ouster is not usually given. The most famous historical instance of *quo warranto* was the action taken against the corporation of London by Charles II. in 1684. The King's Bench adjudged the charter and franchises of the city of London to be forfeited to the Crown (*State Trials*, vol. viii. 1039). This judgment was reversed by 2 Will. & Mary, sess. 1, c. 8; and it was further enacted, in limitation of the prerogative, that the franchises of the city should never be seized or forejudged on pretence of any forfeiture or misdemeanour. In Scotland the analogous procedure is by action of declarator.

In the United States the right to a public office is tried by *quo warranto* or similar procedure, regulated by the state laws. Proceedings by *quo warranto* lie in a United States court for the removal of persons holding office contrary to art. xiv. s. 3 of the Amendments to the Constitution (act of the 31st of May 1870, c. 14).

R THE twentieth letter in the Phoenician alphabet, the nineteenth in the numerical Greek, the seventeenth in the ordinary Greek and the Latin and (owing to the addition of J) the eighteenth in the English. Its earliest form in the Phoenician alphabet when written from right to left was **A**, thus resembling the symbol for D with one side of the triangle prolonged. In Aramaic and other Semitic scripts which were modified by opening the heads of the letters, the symbol in time became very much changed. Greek, however, maintained the original form with slight variations from place to place. Not infrequently in the Greek alphabets of Asia Minor and occasionally also in the West, R was written as **D**, thus introducing a confusion with D (*q.v.*). Elsewhere a short tail was added, as occasionally in the island of Melos, in Attica and in western Greece, but nowhere does this seem to have been universal. The earliest Latin forms are exactly like the Greek. Thus in the very early inscriptions found in the Forum in 1899 R appears as **Q** (from right to left), **P** and **D** (from left to right). Later the forms **R** and **R** come in; sometimes the back is not quite connected in the middle to the upright, when the form **R** is produced. The name of the Semitic symbol is Rēsh; why it was called by the Greeks Rhō (ῥω) is not clear. The *h* which accompanies *r* in the transliteration of Greek *ρ*, indicates that it was breathed, not voiced, in pronunciation. No consonant varies more in pronunciation than *r*. According to Brockelmann, the original Semitic *r* was probably a trilled *r*, *i.e.* an *r* produced by allowing the tip of the tongue to vibrate behind the teeth while the upper surface of the tongue is pressed against the sockets of the teeth. The ordinary English *r* is also produced against the sockets of the teeth, but without trilling; another *r*, also untrilled, which is found in various parts of the south of England, is produced by turning up the tip of the tongue behind the sockets of the teeth till the tongue acquires something of a spoon shape. This, which is also common in the languages of modern India, is called the cerebral or cacuminal *r*, the former term, which has no meaning in this connexion, being only a bad translation of a Sanscrit term. The common German *r* is produced by vibrations of the uvula at the end of the soft palate, and hence is called the uvular *r*. There are also many other varieties of this sound. In many languages *r* is able to form syllables by itself, in the same way that *l*, *m*, *n* may do, as in the English *brill* (*brill*), *written* (*ritn*). In Europe *r* with this value is most conspicuous in Slavonic languages like Bohemian (Czech) and Croatian; in English *r* in this function is replaced by a genuine vowel in words like *mother* (*moðð*). This syllabic *r* is first recorded for Sanscrit, where it is common, but is replaced in the languages descended from Sanscrit by *r* and a vowel or by a vowel only, according to the position in which it occurs. Most philologists are of opinion that syllabic *r* existed also in the mother-tongue of the Indo-European languages. (P. Gr.)

RAABE, HEDWIG (1844-1905), German actress, was born in Magdeburg on the 3rd of December 1844, and at the age of fourteen was playing in the company of the Thalia theatre, Hamburg. In 1864 she joined the German Court theatre at St Petersburg, touring about Germany in the summer with such success that in 1868 she relinquished her Russian engagement to devote herself to starring. In 1871 she married Albert Niemann (b. 1831), the operatic tenor. She excelled in classical rôles like Marianne in Goethe's *Geschwister* and Franziska in *Minna von Barnhelm*. It was she who first played Ibsen in Berlin. She died on the 21st of April 1905.

RAABE, WILHELM (1831-1910), German novelist, whose early works were published under the pseudonym of Jakob Corvinus, was born at Eschershausen in the duchy of Brunswick on the 8th of September 1831. He served apprenticeship at a bookseller's in Magdeburg for four years (1849-1854); but tiring of the routine of business, studied philosophy at Berlin

(1855-1857). While a student at that university he published his first work, *Die Chronik der Sperlingsgasse* (1857), which at once attained to great popularity. Raabe next returned to Wolfenbüttel, and then lived (1862-1870) at Stuttgart, where he devoted himself entirely to authorship and wrote a number of novels and short stories; notably *Unseres Herrgotts Kanzlei* (1862); *Der Hungerpastor* (1864); *Abu Telfan* (1867) and *Der Schudderump* (1870). In 1870 Raabe removed to Brunswick and published the narratives *Horacker* (1876)—perhaps his masterpiece; *Das Odfeld* (1889); *Kloster Lugau* (1894) and *Hastenbeck* (1899), and numerous other stories. The distinguishing characteristic of Raabe's work is a genial humour which reminds us occasionally of Dickens; but this humour is often combined with a pessimism that is foreign to the English novelist.

Raabe's *Gesammelte Erzählungen* appeared in 4 vols. (1896-1900); there is no uniform edition of his larger novels. See P. Gerber, *Wilhelm Raabe* (1897); A. Otto, *Wilhelm Raabe* (1899); A. Bartels, *Wilhelm Raabe: Vortrag* (1901).

RABA BEN JOSEPH BEN HAMA (*c.* 280-352), Babylonian rabbi or amora. He is closely associated in his studies with Abaye. The latter was head of the Academy at Pumbeditha. Raba founded a new school at Maḥuza, which eventually became so long as Raba lived the only academy in Babylonia (Persia). The development of Talmudic Law (or *Halakha*) was much indebted to this rabbi, whose influence in all branches of Jewish learning was supreme. His friendship with the King Shapur II. enabled Raba to secure a relaxation of the oppressive laws enacted against the Jews of Persia.

See Graetz, *History of the Jews*; (Eng. trans., vol. ii. ch. xxi.); Bacher, *Agada der Babyl. Amoraer*, p. 108, &c. and 114-133. (I. A.)

RABAH ZUBEIR (d. 1900), the conqueror of Bornu (an ancient sultanate on the western shores of Lake Chad, included since 1890 in British Nigeria), was a half-Arab, half-negro chieftain. He was originally a slave or follower of Zobeir Pasha (*q.v.*), and is said to have formed one of the party which served as escort to Miss Tinne (*q.v.*) in her journeys in the Bahr-el-Ghazal in 1862-64. In 1879, Zobeir being in Egypt, his son Suleiman and Rabah were in command of Zobeir's forces in the Bahr-el-Ghazal. They persisted in slave-raiding, and denied the khedive's authority, and Colonel C. G. Gordon sent against them Romolo Gessi Pasha. Gessi captured Suleiman and routed Rabah, who in July 1879 fled westward with some seven hundred Bazingirs (black slave soldiers). He made himself master of Kreich and Dar Banda, countries to the south and south-west of Wadai. In 1884-85 he was invited by Mahommed Ahmed (the mahdi) to join him at Omdurman, but did not do so. According to one account he learnt that the mahdi intended, had he gone to Omdurman, to put him to death. In 1891 Paul Crampel, a French explorer, was killed in Dar Banda by a chieftain tributary to Rabah, and Crampel's stores, including 300 rifles, were sent to Rabah. With this reinforcement of arms he marched towards Wadai, but being stoutly opposed by the people of that country he turned west and established himself in Bagirmi, a state south-east of Lake Chad. In 1893 Rabah overthrew the sultan of Bornu. In his administration of the country he showed considerable ability and a sense of public needs. To the British, represented by the Royal Niger Company, Rabah gave comparatively little trouble. During 1894-95 he continually (but unavailingly) asked the company's representatives at Yola and Ibi to supply him with gunpowder. Rabah then tried threats, and in 1896 all communication between him and the company ceased. Early in 1897 he began an advance in the direction of Kano, the most important city in the Fula empire. The news of the crushing defeat by Sir George Goldie of the Fula at Bida, and of the capture of Illorin, induced

Rabah to return to Bornu. He gave the British no further trouble, but turned his attention to the French. Émile Gentil had in this same year (1897) reached Lake Chad, via the Congo and Bagirmi, and had installed a French resident with the sultan of Bagirmi. As soon as Gentil had withdrawn, Rabah again fell upon Bagirmi, and forced sultan and resident to flee. In 1899 the French sent an expedition to reconquer the country, but at first they were unsuccessful. In the summer of 1899 Rabah attacked and routed the French advanced post, held by Naval-Lieutenant Bretonnet, and the latter was killed. In October following another battle was fought, in which the French, under Captain Robillot, completely defeated Rabah, who retreated north-east towards Wadai. Gathering a fresh army, he returned to Bagirmi and joined issue with the French a third time. In a battle fought on the 22nd of April 1900 Rabah was slain and his host defeated. The chieftain's head was cut off and taken to the French camp. In this engagement Major Lamy, the French commandant, also lost his life.

The French continued the campaign against Rabah's sons, two of whom were killed. Rabah had left instructions that if his army was finally defeated by the French, his successor should return to Bornu and make friends with the British. Rabah's third son, Fader-Allah, accordingly threw himself entirely upon British protection. He made a favourable impression, and it was contemplated to recognize him as sultan of Bornu. However, in the later part of 1901 Fader-Allah, who had 2500 riflemen, again made aggressive movements against the French. In retaliation, Captain Dangeville pursued him into British territory. A battle was fought at Gujba, Fader-Allah being defeated. He fled mortally wounded, and died the same night, being buried in the bed of a small river, the course of which had been diverted for the purpose.

Connected accounts of Rabah's career are contained in É. Gentil's *La Chute de l'empire de Rabah* (Paris, 1902) and in M. von Oppenheim's *Rabeh und das Tschadseegebiet* (Berlin, 1902). (F. R. C.)

RABAT (*Ribât*), a city on the Atlantic coast of Morocco, in 34° 3' N., 6° 46' W., 130 m. S. of Cape Spartel, on the southern side and at the mouth of the Bu Ragrag, which separates it from Salli on the northern bank. It is a commercial town of about 26,000 to 30,000 inhabitants, occupying a rocky plateau and surrounded by massive but dilapidated walls, strengthened by three forts on the seaward side. To the south of the town stands a modern palace, defended by earthworks and Krupp guns. The conspicuous feature in the view from the ocean is the Borj el Hasan, an unfinished square-built tower, 145 ft. high, built on an elevation about 65 ft. above the sea to the west of the walled town. At one time the Bu Ragrag afforded a much better harbour than it does now; the roadstead is quite unprotected, and there is a dangerous bar at the mouth of the river, which hampers the shipping, and makes the growth of trade slow. The depth of water over the bar varies from 7 to 12 ft. Rabat trades with Fez and the interior of Morocco, with the neighbouring coast towns and Gibraltar, and with Marseilles, Manchester and London, and is the greatest industrial centre in Morocco.

Rabat was founded by Yak'ub el Mansur in 1184, but Salli was then already an ancient city, and on the scarp hills to the west of Rabat stand the ruins of Sala, a Roman colony, known as Shella. It contains a mausoleum of the Beni Marin dynasty.

RABAUT, PAUL (1718-1794), French pastor of "the Church of the Desert" (see HUGUENOTS), was born at Bédarieux, near Montpellier, on the 29th of January 1718. In 1738 he was admitted as a preacher by the synod of Languedoc, and in 1740 he went to Lausanne to complete his studies in the seminary recently founded there by Antoine Court (*q.v.*). In 1741 Rabaut was placed at the head of the church of Nîmes, and in 1744 he was vice-president of the general synod. During the persecution of 1745-1752 Rabaut himself was obliged to hide. When the marquis of Paulmy d'Argenson was sent to Languedoc to make a military inspection, Rabaut

succeeded in interviewing him (1750). For a time the persecution ceased, but it broke out again in 1753, a price being put upon Rabaut's head. Louis François de Bourbon, prince de Conti, interested himself in the Protestants in 1755, and in July Rabaut visited him. During the years 1755-1760 periods of persecution and toleration alternated. By the year 1760, however, the efforts of Antoine Court and P. Rabaut had been so successful that French Protestantism was well established and organized. Court de Gébelin, Paul Rabaut, and his son Saint-Étienne now exerted themselves to get it recognized by the law and government. When the people revolted, the minister Turgot in 1775 requested Rabaut to calm them. His success aroused the jealousy of his colleagues, who tried to undo the good work started by Antoine Court. But Rabaut persevered in his efforts to improve legally the position of the Protestants. In 1785, when he was visited by General La Fayette, it was arranged that Rabaut's son, Rabaut Saint-Étienne, should go to Paris on behalf of the Reformed Church. In November 1787 Louis XVI.'s edict of toleration was signed, though it was not registered until the 29th of January 1788. Two years later liberty of conscience was proclaimed by the National Assembly, of which Rabaut Saint-Étienne was chosen vice-president, and it was declared that non-Catholics might be admitted to all positions. After the fall of the Girondists, however, in which Rabaut Saint-Étienne was involved, Paul Rabaut, who had refused to renounce his title of pastor, was arrested, dragged to the citadel of Nîmes, and kept in prison seven weeks (1794). He died at Nîmes on the 25th of September 1794, soon after his release.

See J. Pons de Nîmes, *Notice biographique sur Paul Rabaut* (1808); Charles Dardier, *Paul Rabaut, ses lettres à Antoine Court* (1884) and *Paul Rabaut, ses lettres à divers* (1891).

RABAUT SAINT-ÉTIENNE, JEAN PAUL (1743-1793), French revolutionist, was born at Nîmes, the son of Paul Rabaut (*q.v.*), the additional surname of Saint-Étienne being assumed from a small property near Nîmes. Like his father, he became a pastor, and distinguished himself by his zeal for his co-religionists, working energetically to obtain the recognition of the civil rights which had been granted to them by Louis XVI. in 1788. Having gained a great reputation by his *Histoire primitive de la Grèce*, he was elected deputy to the States General in 1789 by the third estate of the *bailliage* of Nîmes. In the Constituent Assembly he worked on the framing of the constitution, spoke against the establishment of the republic, which he considered ridiculous, and voted for the suspensive veto, as likely to strengthen the position of the crown. In the Convention he sat among the Girondists, opposed the trial of Louis XVI., was a member of the commission of twelve, and was proscribed with his party. He remained in hiding for some time, but was ultimately discovered and guillotined on the 5th of December 1793.

See J. A. Dartigue, *Rabaut St-Étienne à l'Assemblée Constituante* (Paris, 1903); and A. Lods, "Correspondance de Rabaut St-Étienne" in *La Révolution française* (1898), "L'arrestation de Rabaut St-Étienne" in *La Révolution française* for 1903 (cf. the same review for 1901), and "Les débuts de Rabaut St-Étienne aux États Généraux et à la Convention" in the *Bulletin historique de la Société de l'histoire du protestantisme français* (1901), also an *Essai sur la vie de Rabaut Saint-Étienne* (1893) separately published. An edition of the *Œuvres de Rabaut Saint-Étienne* (2 vols., 1826) contains a notice by Collin de Plancy.

RABBA, a town of British West Africa, in the province of Nupe, Northern Nigeria, on the left bank of the Niger, in 9° 6' N., and 200 m. above the confluence of the Niger and the Benue. At the time of Richard Lander's visit in 1830 it was a place of 40,000 inhabitants and one of the most important markets in the country. In 1867 Gerhard Rohlfs found it with only 500 inhabitants. The town has somewhat recovered its position since the establishment of British rule in 1902.

RABBAH BAR NAHMANI (c. 270-c. 330), a Babylonian rabbi or amora (*q.v.*). He was for twenty-two years head of the Academy at Pumbeditha. His great dialectic skill acquired

for him the epithet "uprooter of mountains." The Talmud owes much to this rabbi. He is said to have perished in a jungle into which he had fled from the officers of the Persian king.

See Graetz, *History of the Jews* (Eng. trans.), vol. ii. ch. xxi.; Bacher, *Agada der Babyl. Amoräer*, 97-101. (I. A.)

RABBAN BAR SAUMA (fl. 1280-1288), Nestorian traveller and diplomatist, was born at Peking about the middle of the 13th century, of Uigur stock. While still young he started on a pilgrimage to Jerusalem, and travelling by way of Tangut, Khotan, Kashgar, Talas in the Syr Daria valley, Khorasan, Maragha and Mosul, arrived at Ani in Armenia. Warnings of the danger of the routes to southern Syria turned him from his purpose; and his friend and fellow-pilgrim, Rabban Marcos, becoming Nestorian patriarch (as Mar Yaballaha III.) in 1281, suggested Bar Sauma's name to Arghun Khan, sovereign of the Ilkhanate or Mongol-Persian realm, for a European embassy, then contemplated. The purpose of this was to conclude an anti-Moslem alliance, especially against the Mameluke power, with the chief states of Christendom. On this embassy Bar Sauma started in 1287, with Arghun's letters to the Byzantine emperor, the pope and the kings of France and England. In Constantinople he had audience of Andronicus II.; he gives an enthusiastic description of St Sophia. He next travelled to Rome, where he visited St Peter's, and had prolonged negotiations with the cardinals. The papacy being then vacant, a definite reply to his proposals was postponed, and Bar Sauma passed on to Paris, where he had audience of the king of France (Philip the Fair). In Gascony he apparently met the king of England (Edward I.) at a place which seems to be Bordeaux, but of which he speaks as the capital of *Alanguitar* (i.e. Angleterre). On returning to Rome, he was cordially received by the newly elected pontiff Nicolas IV., who gave him communion on Palm Sunday, 1288, allowed him to celebrate his own Eucharist in the capital of Latin Christendom, commissioned him to visit the Christians of the East, and entrusted to him the tiara which he presented to Mar Yaballaha. His narrative is of unique interest as giving a picture of medieval Europe at the close of the Crusading period, painted by a keenly intelligent, broad-minded and statesmanlike observer.

See J. B. Chabot's translation and edition of the *Histoire du Patriarche Mar Jabalaha III, et du moine Rabban Cauma* (from the Syriac) in *Revue de l'Orient latin*, 1893, pp. 566-610; 1894, pp. 73-143, 235-300; O. Raynaldus, *Annales Ecclesiastici* (continuation of Baronius), A.D. 1288, §§ xxxv.-xxxvi.; 1289, § lxi.; L. Wadding, *Annales Minorum*, v. 169, 196, 170-173; C. R. Beazley, *Dawn of Modern Geography*, ii. 15, 352; iii. 12, 189-190, 539-541.

RABBET, in carpentry and masonry, the name for a rectangular groove or slot cut in the edge of a piece of wood or stone, to which another corresponding piece can be fitted (see JOINERY and MASONRY). The word is an adaptation of the O. Fr. *rabat* or *rabbat*, from *rabattre*, i.e. *abattre*, beat back, abate, to make a recess, and is thus a doublet of "rebate" (q.v.), which is now frequently used instead of "rabbet," the joint being also known as a "rebated joint."

RABBI, a Hebrew word meaning "my master," "my teacher." It is derived from the adjective *rab* (in Aramaic, and frequently also in Hebrew, "great"), which acquired in modern Hebrew the signification of "lord," in relation to servants or slaves, and of "teacher," "master," in relation to the disciple. The master was addressed by his pupils with the word *rabbi* ("my teacher"), or *rabbenu* ("our teacher"). It became customary to speak of Moses as *Moshe rabbenu* ("our teacher Moses"). Jesus makes it a reproach against the scribes that they cause themselves to be entitled by the people *rabbi* (ραββί, Matt. xxiii. 7): and He Himself is saluted by the disciples of John as *rabbi* (John i. 38, where the word is explained as equivalent to διδάσκαλε). As an honorary title of the scribes, with whose name it was constantly linked, "Rabbi" only came into use during the last decades of the second Temple. Hillel and Shammai, the contemporaries of Herod, were mentioned without any title. Gamaliel I., the grandson of Hillel, was the first to whose name the appellation *Rabban* (the same as

rabbon, and also pronounced as *ribbon*, cf. βαββουί, Mark x. 51; John xx. 16) was prefixed. This title, a higher distinction than that of *rabbi*, is in tradition borne only by the descendants of Gamaliel I., the last being Gamaliel III., the son of Jehuda I. (Aboth ii. 2), and by Johanan b. Zaccai, the founder of the school of Jamnia (Jabneh). Otherwise all Tannaites (see TANNA), the scholars of the Mishnah period, were distinguished by the title of "rabbi." The Jehuda I. mentioned above, the redactor of the Mishnah, was honoured as the "Rabbi" *kar' éξοχήν* ("par excellence"), and in the tradition of the houses of learning, if it was necessary to speak of him or to cite his opinions and utterances, he was simply referred to as "Rabbi," without the mention of any name. Scholars who were not definitely ordained—and among these were men of high distinction—were simply mentioned by their names without the Rabbi-title. In the post-Talmudic age the Qaraites, who rejected the tradition of the Talmud, designated the Jews who adhered to that tradition as Rabbanites. Similarly the term Rabbins, or Rabbis, is applied to modern Jewish clergy. The plural *rabbanim* was employed to describe the later Jewish scholars (so, for example, in the historian Abraham Ibn Daud, 12th century). By "rabbinical literature" is understood the post-Talmudic Jewish literature; in particular, so far as its subject is the literature of the tradition and its contents.

RAB became a proper name as the standing nomenclature of the celebrated amora, *Abba Arika* (q.v.). (W. BA.)

RABBIT, the modern name of the well-known rodent, formerly called (as it still is in English legal phraseology) CONY,¹ a member of the family *Leporidae* (see RODENTIA). Till recently the rabbit has generally been known scientifically as *Lepus cuniculus*, but it is now frequently regarded, at least by systematic naturalists, as the representative of a genus by itself, under the

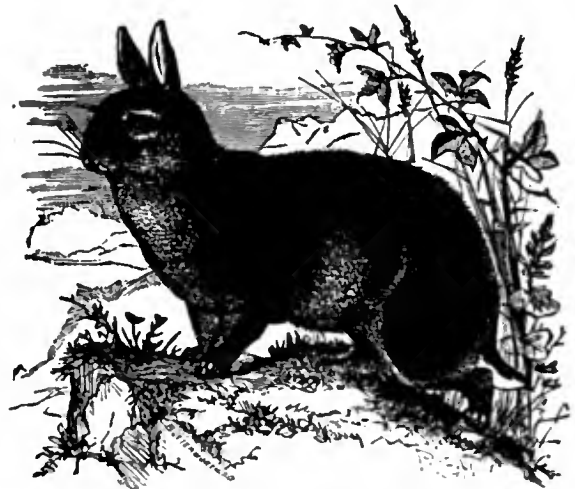

The Rabbit (*Oryctolagus cuniculus*).

name of *Oryctolagus cuniculus*. Some zoologists, indeed, include in the same genus the South African thick-tailed hare, but by others this is separated as *Pronolagus crassicaudatus*. From the hare the wild rabbit is distinguished externally by its smaller size, shorter ears and feet, the absence or reduction of the black patch at the tip of the ears, and its greyer colour. The skull is

¹ There are no native names either in Teutonic or Celtic languages; such words as German *Kaninchen* or English *cony* are from the Latin *cuniculus*, while the Irish, Welsh and Gaelic are adaptations from English. "Rabbit," which is now the common name in English, was for long confined to the young of the cony, and so the *Promptorium Parvulorum*, c. 1440, "Rabet, yonge conye, cunicellus." The ultimate source of "rabbit" is itself unknown. The *New English Dictionary* takes it to be of northern French origin. There is a Walloon *robett*. Skeat suggests a possible connexion with Spanish *rabo*, tail, *rabear*, to wag the hind-quarters. The familiar name for toasted cheese, "Welsh rabbit," is merely a joke, and the alteration to "Welsh rare-bit" is due to a failure to see the joke, such as it is. Parallels may be found in "Prairie oyster," the yolk of an egg with vinegar, pepper, &c. added; or "Scotch woodcock," a savoury of buttered eggs on anchovy toast.

very similar to that of the hare, but is smaller and lighter, with a slenderer muzzle and a longer and narrower palate. Besides these characters, the rabbit is separated from the hare by the fact that it brings forth its young naked, blind, and helpless; to compensate for this, it digs a deep burrow in the earth in which they are born and reared, while the young of the hare are born fully clothed with fur, and able to take care of themselves, in the shallow depression or "form" in which they are produced. The weight of the rabbit is from $2\frac{1}{2}$ to 3 lb, although wild individuals have been recorded up to more than 5 lb. Its general habits are too well known to need detailed description. It breeds from four to eight times a year, bringing forth each time from three to eight young; its period of gestation is about thirty days, and it is able to bear when six months old. It attains to an age of about seven or eight years.

The rabbit is believed to be a native of the western half of the Mediterranean basin, and still abounds in Spain, Sardinia, southern Italy, Sicily, Greece, Tunis and Algeria; and many of the islands adjoining these countries are overrun with these rodents. Thence it has spread, partly by man's agency, northwards throughout temperate western Europe, increasing rapidly wherever it gains a footing; and this extension is still going on, as is shown by the case of Scotland, where early in the 19th century rabbits were little known, while they are now found in all suitable localities up to the extreme north. It has also gained admittance into Ireland, and now abounds there as much as in England. Out of Europe the same extension of range has been going on. In New Zealand and Australia rabbits, introduced either for profit or sport, have increased to such an extent as to form one of the most serious pests that the farmers have to contend against, as the climate and soil suit them perfectly and their natural enemies are too few and too lowly organized to keep them within reasonable bounds. In North America about thirty species and twice as many geographic races (subspecies) are known, and the occurrence of several distinct fossil forms shows that the genus has long been established. The chief variety is the common grey or cottontail (*Lepus floridanus*). For the "jack-rabbit," see HARE.

The rabbit has been domesticated from an early period. Little doubt exists amongst naturalists that all the varieties of the domestic animal are descended from *Oryctolagus cuniculus*. The variations which have been perpetuated and intensified by artificial selection are, with the exception of those of the dog, greater than have been induced in any other mammal. For not only has the weight been more than quadrupled in some of the larger breeds, and the structure of the skull and other parts of the skeleton greatly altered, but the proportionate size of the brain has been reduced and the colour and texture of the fur altered in a remarkable manner. The lop-eared breed is the oldest English variety, and has been cultivated carefully since about 1785, the aim of the breeder being directed to the development of the size of the ears, and with such success that they sometimes measure more than 23 in. from tip to tip and exceed 6 in. in width. This development, which is accompanied by changes in the structure of the skull, depends on breeding the animals in warm damp hutches, without which the best developed parents fail to produce the desired offspring. In colour lop-eared rabbits vary greatly. The Belgian hare is a large breed of a hardy and prolific character, which closely resembles the hare in colour, and is not unlike it in form. Some years ago these rabbits were sold as "leporides" or hybrids, produced by the union of the hare and the rabbit; but the most careful experimenters have failed to obtain any such hybrid, and the naked immature condition in which young rabbits are born as compared with the clothed and highly developed young hare renders it unlikely that hybrids could be produced. Nor does the flesh of the Belgian rabbit resemble that of the hare in colour or flavour. A closely allied variety, though of larger size, is known as the Patagonian rabbit, although it has no relation to the country after which it is called.

The Angora rabbit is characterized by the extreme elongation and fineness of the fur, which in good specimens reaches 6 or 7 in. in length, requiring great care and frequent combing to prevent it from becoming matted. The Angoras most valued are albinos, with pure white fur and pink eyes; in some parts of the Continent they are kept by the peasants and clipped regularly.

Amongst the breeds which are valued for the distribution of colour on the fur are the Himalayan and the Dutch. The former is white, but the whole of the extremities—viz. the nose, the ears, tail and feet—are black or very dark in colour. This very pretty breed has no connexion with the mountains from which it takes

its name, but is a variety produced by careful breeding and selection. Though produced by crossing, it now generally breeds true to colour, at times throwing back, however, to the silver greys from which it was derived. The rabbits known as Dutch are small, and valued for the disposition of the colour and markings. The entire body behind the shoulder-blades is uniformly coloured, with the exception of the feet; the anterior part of the body, including the fore legs, neck, and jaws, is white, the cheeks and ears being coloured. In some strains the coloured portion extends in front of the fore legs, leaving only a ring of white round the neck. The more accurately the coloured portion is defined, the higher is the animal esteemed. The silver grey is a uniform-coloured breed, the fur of which is a rich chinchilla grey, varying in depth in the different strains. From the greater value of the fur, silver greys have been frequently employed to stock warrens, as they breed true to colour in the open if the ordinary wild rabbits are excluded. Other colours known, as silver fawn and silver brown, are closely related. A blue breed has been recently introduced. The largest and heaviest of all is the Flemish giant, with iron-grey fur above and white below. Other breeds include the Japanese, with an orange coat, broadly banded on the hind-quarters with black; the pink-eyed and short and thick-furred albino Polish; the Siberian, probably produced by crossing the Himalayan with the Angora; and the black-and-tan and blue-and-tan.

See also HARE, SHOOTING, and COURSING. (W. H. F.; R. L.*)

RABBLE, a general term for a disorderly crowd, apparently connected with the verb "to rattle," to talk or work in a confused manner, Du. *rabbelen*, Ger. dialect *rabbeln*, cf. Gr. *ῥαβάζω*, to howl. In iron and steel manufacture, a puddling-tool, for stirring the molten metal, is called a "rattle." This is a different word, adapted from Fr. *râble*, for *roable*, Med. Lat. *rotabulum*, Lat. *rutabulum* (*ruere*, to rake), a fire-shovel or oven rake.

RABBŪLĀ, a distinguished bishop of the Syrian church early in the 5th century. He was a native of *Ḳenneshrīn*, a town some few miles south of Aleppo and the seat of a bishopric. His father was a heathen priest, and though his mother was a devoted Christian he continued in pagan belief and practice until some time after his marriage. During a journey to his country estates he was converted to Christianity partly through coming in contact with a case of miraculous healing and partly through the teaching and influence of Eusebius, bishop of *Ḳenneshrīn*, and Acacius, bishop of Aleppo. With all the energy of his fiery nature he threw himself into the practice of Christian asceticism, sold all his possessions, and separated from his wife and kinspeople. He resided for some time in a monastery, and then passed to a life of greater hardship as a solitary hermit. On the death of Diogenes, bishop of Edessa, in the year 411-412, Rabbūlā was chosen his successor, and at once accepted the position offered him, without any of the customary show of reluctance. As a bishop he was marked by extraordinary energy, by the continued asceticism of his personal life, by his magnificent provision for all the poor and suffering in his diocese, by his care for discipline among the clergy and monks who were under his authority, and latterly by the fierce determination with which he combated all heresies and especially the growing school of the followers of Nestorius. On one occasion he visited Constantinople and there preached before Theodosius II. (who was then favourable to Nestorius) and a great congregation a sermon in denunciation of Nestorian doctrine, of which a portion survives in the Syriac version.¹ He became the friend of Cyril of Alexandria, with whom he corresponded, and whose treatise *De recta fide* he translated into Syriac.² After a busy episcopal life of twenty-four years he died in August 435, and was immensely lamented by the people of his diocese. His successor was the Nestorian Ibas.

The literary remains of Rabbūlā are small in bulk, and are mostly to be found in Overbeck. Perhaps his main importance to the historian of Syriac literature lies in the zeal with which he strove to replace the Diatessaron or Gospel Harmony of Tatian by the edition of the separate Gospels, ordering that a copy of the latter should be placed in every church and should

¹ Overbeck, *op. cit.* pp. 239-244.

² The version survives in a British Museum MS.; see Wright's *Catalogue* p. 719.

be read (see Wright's *Syr. Lit.* p. 9). According to his biographer (Overbeck, p. 172) he himself produced a version (or revision) of the New Testament in Syriac. This may have been, as Wright suggests (*Syr. Lit.* p. 11), "a first step in the direction of the Philoxenian version." But there is great probability in F. C. Burkitt's hypothesis that the product of Rabbūlā's work, at least as regards the Gospels, is to be found in the current Peshīṭta text, which "represents the Greek text as read in Antioch about 400 A.D." and "was prepared by Rabbūlā . . . and published by his authority as a substitute for the Diatessaron."¹

Rabbūlā seems to have been a man of great force, devotion and self-denial: on the one hand intellectually gifted, and on the other thoroughly consistent in his practice of religion. But his attractiveness is marred, as in the case of many of his contemporaries, by the bitterness of a narrow orthodoxy.

(N. M.)

RABELAIS, FRANÇOIS (c. 1490–1553), French humorist, was born at Chinon on the Vienne in the province of Touraine. The date of his birth is wholly uncertain: it has been put by tradition, and by authorities long subsequent to his death, as 1483, 1490, and 1495. There is nothing in the positive facts of his life which would not suit tolerably well with any of these dates; most 17th-century authorities give the earliest, and this also accords best with the age of the eldest of the Du Bellay brothers, with whom Rabelais was (perhaps) at school. In favour of the latest it is urged that, if Rabelais was born in 1483, he must have been forty-seven when he entered at Montpellier, and proportionately and unexpectedly old at other known periods of his life. In favour of the middle date, which has, as far as recent authorities are concerned, the weight of consent in its favour, the testimony of Guy Patin (1601–1672), a witness of some merit and not too far removed in point of time, is invoked. The only contribution which need be made here to the controversy is to point out that if Rabelais was born in 1483 he must have been an old man when he died, and that scarcely even tradition speaks of him as such.

With regard to his birth, parentage, youth, and education everything depends upon this tradition, and it is not until he was according to one extreme hypothesis thirty-six, according to the other extreme twenty-four, that we have solid testimony respecting him. In the year 1519, on the 5th of April, the François Rabelais of history emerges. The monks of Fontenay le Comte bought some property (half an inn in the town), and among their signatures to the deed of purchase is that of François Rabelais. Before this all is cloudland. It is said that he had four brothers and no sisters, that his father had a country property called La Devinière, and was either an apothecary or a tavern-keeper. Half a century after his death De Thou mentions that the house in which he was born had become a tavern and then a tennis-court. It still stands at the corner of a street called the Rue de la Lamproie, and the tradition may be correct. An indistinct allusion of his own has been taken to mean that he was tonsured in childhood at seven or nine years old; and tradition says that he was sent to the convent of Seully. From Seully at an unknown date tradition takes him either to the university of Angers or to the convent school of La Baumette or La Basmette, founded by good King René in the neighbourhood of the Angevin capital. Here he is supposed to have been at school with the brothers Du Bellay, with Geoffroy d'Estissac and others. The next stage in this (so far as evidence goes, purely imaginary) career is the monastery of Fontenay le Comte, where, as has been seen, he is certainly found in 1519 holding a position sufficiently senior to sign deeds for the community, where he, probably in 1511, took priest's orders, and where he also pursued, again certainly, the study of letters, and especially of Greek, with ardour. From this date, therefore, he becomes historically visible. The next certain intelligence which we have of Rabelais is somewhat more directly bio-

graphical. The letters of the well-known Greek scholar Budaeus, two of which are addressed to Rabelais himself and several more to his friend and fellow-monk Pierre Amy, together with some notices by André Tiraqueau, a learned jurist, to whom Rabelais rather than his own learning has secured immortality, show beyond doubt what manner of life the future author of *Gargantua* led in his convent. The letters of Budaeus show that an attempt was made by the heads of the convent or the order to check the studious ardour of these Franciscans; but it failed, and there is no positive evidence of anything like actual persecution, the phrases in the letters of Budaeus being merely the usual exaggerated Ciceronianism of the Renaissance. Some books and papers were seized as suspicious, then given back as innocent; but Rabelais was in all probability disgusted with the cloister—indeed his great work shows this beyond doubt. In 1524, the year of the publication of Tiraqueau's book above cited, his friend Geoffroy d'Estissac procured from Clement VII. an indult, licensing a change of order and of abode for Rabelais. From a Franciscan he became a Benedictine, and from Fontenay he moved to Maillezais, of which Geoffroy d'Estissac was bishop. But even this learned and hospitable retreat did not apparently satisfy Rabelais. In or before 1530 he left Maillezais, abandoned his Benedictine garb for that of a secular priest, and, as he himself puts it in his subsequent *Supplicatio pro Apostasia* to Pope Paul III., "*per seculum diu vagatus fuit.*" For a time the Du Bellays provided him with an abode near their own château of Langey. He is met at Montpellier in the year just mentioned. He entered the faculty of medicine there on the 16th of September and became bachelor on the 1st of November, a remarkably short interval, which shows what was thought of his acquirements. Early in 1531 he lectured publicly on Galen and Hippocrates, while his more serious pursuits seem to have been chequered by acting in a *morale comédie*, then a very frequent university amusement. Visits to the Îles d'Îlières, and the composition of a fish sauce in imitation of the ancient *garum*, which he sent to his friend Étienne Dolet, are associated, not very certainly, with his stay at Montpellier, which, lasting rather more than a year at first, was renewed at intervals for several years.

In 1532, however, he had moved from Montpellier to Lyons. Here he plunged into manifold work, literary and professional. He was appointed before the beginning of November physician to the Hôtel Dieu, with a salary of forty livres per annum, and lectured on anatomy with demonstrations from the human subject. He edited for Sebastian Gryphius, in the single year 1532, the medical *Epistles* of Giovanni Manardi, the *Aphorisms* of Hippocrates, with the *Ars Parva* of Galen, and an edition of two supposed Latin documents, which, however, happened unluckily to be forgeries.

At this time Lyons was the centre and to a great extent the headquarters of an unusually enlightened society, and indirectly it is clear that Rabelais became intimate with this society. A manuscript distich, which was found in the Toulouse library, deals with the death of an infant named Théodule, whose country was Lyons and his father Rabelais, but we know nothing more about the matter. What makes the Lyons sojourn of the greatest real importance is that at this time probably appeared the beginnings of the work which was to make Rabelais immortal. It is necessary to say "probably," because the strange uncertainty which rests on so much of his life and writings exists here also. There is no doubt that both *Gargantua* and *Pantagruel* were popular names of giants in the Middle Ages, though, curiously enough, no mention of the former in French literature much before Rabelais's time has been traced. In 1526, however, Charles de Bordigné, in a satiric work of no great merit, entitled *la Légende de Pierre Faifeu*, has the name *Gargantua* with an allusion, and in 1532 (if not earlier) there appeared at Lyons *les Grandes et inestimables chroniques du grand et énorme géant Gargantua*. This is a short book on the plan of the later burlesques and romances of the Round Table. Arthur and Merlin appear with Grantgosier, as he is here spelt, Galemelle (Gargamelle), *Gargantua* himself,

¹ See S. Ephraim's *Quotations from the Gospel* (Cambridge, 1901), p. 57 f.; *Evangelion du-Mepharreshe* (Cambridge, 1904), ii. 5; and *Early Eastern Christianity* (London, 1904), lecture ii.

and the terrible mare. But there is no trace of the action or other characters of *Gargantua* that was to be, nor is the manner of the piece in the least worthy of Rabelais. No one supposes that he wrote it, though it has been supposed that he edited it and that in reality it is older than 1532, and may be the direct subject of Bordigné's allusion six years earlier. What does, however, seem probable is that the first book of *Pantagruel* (the second of the whole work) was composed with a definite view to this chap book and not to the existing first book of *Gargantua*, which was written afterwards, when Rabelais discovered the popularity of his work and felt that it ought to have some worthier starting-point than the *Grandes chroniques*. The earliest known and dated edition of *Pantagruel* is of 1533, of *Gargantua* 1535, though this would not be of itself conclusive, especially as we actually possess editions of both which, though undated, seem to be earlier. But the definite description of *Gargantua* in the title as "Père de Pantagruel," the omission of the words "second livre" in the title of the first book of *Pantagruel* while the second and third are duly entitled "tiers" and "quart," the remarkable fact that one of the most important personages, Friar John, is absent from book ii., the first of *Pantagruel*, though he appears in book i. (*Gargantua*), and many other proofs show the order of publication clearly enough. There is also in existence a letter of Calvin, dated 1533, in which he speaks of *Pantagruel*, but not of *Gargantua*, as having been condemned as an obscene book. Besides this, 1533 saw the publication of an almanac, the first of a long series which exists only in titles and fragments, and of the amusing *Prognostication Pantagrueline* (still, be it observed, *Pantagrueline*, not *Gargantuine*). Both this and *Pantagruel* itself were published under the anagrammatic pseudonym of "Alcofribas Nasier," shortened to the first word only in the case of the *Prognostication*.

This busy and interesting period of Rabelais's life was brought to a close apparently by his introduction or reintroduction to Jean du Bellay, who, in October 1533, passing through Lyons on an embassy to Rome, engaged Rabelais as physician. The visit did not last very long, but it left literary results in an edition of a description of Rome by Marliani, which Rabelais published in September 1534. It is also thought that the first edition of *Gargantua* may have appeared this year.

In the spring of 1535 the authorities of the Lyons hospital, considering that Rabelais had twice absented himself without leave, elected Pierre de Castel in his room; but the documents which exist do not seem to infer that any blame was thought due to him, and the appointment of his successor was once definitely postponed in case he should return. At the end of 1535 Rabelais once more accompanied Jean du Bellay, now a cardinal, to Rome and stayed there till April in the next year. This stay furnishes some biographical documents of importance in the shape of letters to Geoffroy d'Estissac, of the already-mentioned *Supplicatio pro Apostasia*, and of the bull of absolution which was the reply to it. This bull not only freed Rabelais from ecclesiastical censure, but gave him the right to return to the order of St Benedict when he chose, and to practise medicine. He took advantage of this bull and became a canon of St Maur. In 1537 he took his doctor's degree at Montpellier, lectured on the Greek text of Hippocrates, and next year made a public anatomical demonstration. During these two years he seems to have resided either at Montpellier or at Lyons. But in 1539 he entered the service of Guillaume du Bellay-Langey, elder brother of Jean, and would appear to have been with him (he was governor of Piedmont) till his death on 9th January 1543. Rabelais wrote a panegyric memoir of Guillaume, which is lost, and the year before saw the publication of an edition of *Gargantua* and *Pantagruel*, book i., together (both had been repeatedly reprinted separately), in which some dangerous expressions were cut away. Nothing at all is known of his life, whereabouts, or occupations till the publication of the third book, which appeared in 1546, "avec privilège du roi," which had been given in September 1545.

Up to this time Rabelais, despite the condemnation of the Sorbonne referred to above, had experienced nothing like persecution or difficulty. Even the spiteful or treacherous act of Dolet, who in 1542 reprinted the earlier form of the books which Rabelais had just slightly modified, seems to have done him no harm. But the storm of persecution which towards the end of the reign of Francis I. was fatal to Dolet himself and to Des Périers, while it exiled and virtually killed Marot, threatened him. There is no positive evidence of any measures taken or threatened against him; but it is certain that he passed nearly the whole of 1546 and part of 1547 at Metz in Lorraine as physician to the town at the salary of 120 livres, and Sturm speaks of him as having been "cast out of France by the times" (with the exclamation $\phi\epsilon\upsilon\ \tau\omicron\nu\nu\ \chi\rho\theta\omicron\nu\nu$) in a contemporary letter, and says that he himself in another letter gives a doleful account of his pecuniary affairs and asks for assistance. At Francis's death on 31st March 1547 Du Bellay went to Rome, and at some time not certain Rabelais joined him. He was certainly there in February 1549, when he dates from Du Bellay's palace a little account of the festivals given at Rome to celebrate the birth of the second son of Henry II. and Catherine de' Medici. This account, the *Sciomachie* as it is called, is extant. In the same year a monk of Fontevault, Gabriel du Puits-Herbault, made in a book called *Theotimus* the first of the many attacks on Rabelais. It is, however, as vague as it is violent, and it does not seem to have had any effect. Rabelais had indeed again made for himself protectors whom no clerical or Sorbonist jealousy could touch. The *Sciomachie* was written to the cardinal of Guise, whose family were all-powerful at court, and Rabelais dedicated his next book to Odet de Chatillon, afterwards cardinal, a man of great influence. Thus Rabelais was able to return to France, and in 1550 was presented to the livings of Meudon and St Christophe de Jambet. It may, however, surprise those who have been accustomed to hear him spoken of as "curé de Meudon," and who have read lives of him founded on legend, to find that there is very little ground for believing that he ever officiated or resided there. He certainly held the living but two years, resigning it in January 1552 along with his other benefice, and it is noteworthy that at the episcopal visitation of 1551 he was not present. To this supposed residence at Meudon and to the previous stay at Rome, however, are attached two of the most mischievous items of the legend, though fortunately two of the most easily refutable. It is said that Rabelais met and quarrelled with Joachim du Bellay the poet at Rome, and with Ronsard at Meudon and elsewhere, that this caused a breach between him and the Pléiade, that he satirized its classicizing tendencies in the episode of the Limousin scholar, and that Ronsard after his death avenged himself by a libellous epitaph. The facts are these. Nothing is heard of the quarrel with Du Bellay or of any meeting with him, nothing of the meetings and bickerings with Ronsard, till 1697, when Bernier tells the story without any authority. The supposed allusions to the Pléiade date from a time when Ronsard was a small boy, and are mainly borrowed from an earlier writer still, Geoffroy Tory. Lastly, the epitaph, read impartially, is not libellous at all, but simply takes up the vein of the opening scenes of *Gargantua* in reference to *Gargantua's* author. There is indeed no reason to suppose that either Ronsard or Du Bellay was a fervent admirer of Rabelais, for they belonged to a very different literary school; but there is absolutely no evidence of any enmity between them, and Du Bellay actually refers to Rabelais with admiration.

Some chapters of Rabelais's fourth book had been published in 1548, but the whole did not appear till 1552. The Sorbonne censured it and the parliament suspended the sale, taking advantage of the king's absence from Paris. But it was soon relieved of the suspension. He died, it is said, on the 9th of April 1553, but actual history is quite silent save on the point that he was not alive in May of the next year, and the legends about his deathbed utterances—"La farce est jouée," "Je vais chercher un grand peut-être," &c.—are altogether

apocryphal. The same may be said of the numerous silly stories told of his life, such as that of his procuring a free passage to Paris by inscribing packets "Poison for the king," and so forth.

Ten years after the publication of the fourth book and nine after the supposed date of the author's death there appeared at Lyons sixteen chapters entitled *U'le sonnante par maistre François Rabelais*, and two years later the entire fifth book was printed as such. In 1567 it took place with the others, and has ever since appeared with them. But from the beginning of the 17th century there have never been wanting disbelievers in its authenticity. The controversy is one of some intricacy, but as it is also one of capital importance in literary history the heads of it at least must be given here. The opponents of the book rely (1) on the testimony of a certain Louis Guyon, who in 1604 declared that the fifth book was made long after Rabelais's death by an author whom he knew, and who was not a doctor, and on the assertion of the bibliographer Du Verdier, about the same time, that it was written by an "écolier de Valence"; (2) on the fact that the anti-monastic and even anti-Catholic polemic is much more accentuated in it; (3) on the arguments that parts are apparently replicas or rough drafts of passages already appearing in the four earlier books; and (4) that some allusions are manifestly posterior to even the furthest date which can be assigned for the reputed author's decease. On the other hand, it is urged that, though Guyon and Du Verdier were in a sense contemporaries, they wrote long after the events, and that the testimony of the former is vitiated, not merely by its extreme vagueness, but by the fact that it occurs in a *plaidoyer*, tending to exculpate physicians from the charge of unorthodoxy; that Du Verdier in another place assigns the *Pantagrueline Prognostication* to this same unknown student of Valence, and had therefore probably confused and hearsay notions on the subject; that the rasher and fiercer tone, as well as the apparent repetitions, are sufficiently accounted for on the supposition that Rabelais never finally revised the book, which indeed dates show that he could not have done, as the fourth was not finally settled till just before his death; and that it is perfectly probable, and indeed almost certain, that it was prepared from his papers by another hand, which is responsible for the anachronous allusions above referred to. But the strongest argument, and one which has never been attacked by authorities really competent to judge, is that the "griffe de l'aigle" is on the book, and that no known author of the time except Rabelais was capable of writing the passage about the *Chats fourrés*, the better part of the history of Queen Whims (La Quinte) and her court, and the conclusion giving the Oracle of the Bottle. To this argument we believe that the more competent a critic is, both by general faculty of appreciation and by acquaintance with contemporary French literature, the more positive will be the assent that he yields. The reader must, however, be on his guard against confusing the authenticity of the fifth book generally with that of supposed early copies of it. Quite recently it was announced that an edition of 1549 had turned up in Germany; but the investigations of M. R. Stein, *un Rabelais apocryphe* (1901), repeated and confirmed by M. A. Lefranc in the *Revue des études Rabelaisiennes* (1905), disposed of the matter. The substance of the apocryphal document is quite different from our fifth book.

Gargantua and *Pantagruel*, notwithstanding their high literary standing and the frequency with which certain passages from them are cited, are, owing partly to their archaism of language and partly to the extreme licence which their author has allowed himself, so little read that no notice of them or of him could be complete without some sketch of their contents. The first book, *Gargantua*, describes the birth of that hero (a giant and the son of gigantic parents), whose nativity is ushered in by the account of a tremendous feast. In this the burlesque exaggeration of the pleasures of eating and drinking, which is one of the chief exterior notes of the whole work, is pushed to an extreme—an extreme which has attracted natural but perhaps undue attention. Very early, however, the author becomes serious in contrasting the early

education of his hero—a satire on the degraded schools of the middle ages—with its subsequent and reformed stage, in the account of which all the best and noblest ideas of the humanist Renaissance in reference to pedagogy are put with exceptional force. *Gargantua* is recalled from Paris, whither he had been sent to finish his education, owing to a war between his father, Grandgousier, and the neighbouring king, Picrochole. This war is described at great length, the chief hero of it being the monk, Friar John, a very unclerical cleric, in whom Rabelais greatly delights. Picrochole defeated and peace made, *Gargantua* establishes the abbey of Thelema in another of Rabelais's most elaborate literary passages, where all the points most obnoxious to him in monastic life are indicated by the assignment of their exact opposites to this model convent. The second book, which introduces the principal hero of the whole, *Pantagruel*, *Gargantua*'s son, is, on any other hypothesis but that already suggested of its prior composition, very difficult to explain, but in itself it is intelligible enough. *Pantagruel* goes through something like a second edition (really a first) of the educational experiences of his father. Like him, he goes to Paris, and there meets with Panurge, the principal triumph of Rabelaisian character-drawing, and the most original as well as puzzling figure of the book. Panurge has almost all intellectual accomplishments, but is totally devoid of morality: he is a coward, a drunkard, a lecher, a spiteful trickster, a spendthrift, but all the while infinitely amusing. This book, like the other, has a war in its latter part; *Gargantua* scarcely appears in it and Friar John not at all. It is not till the opening of the third book that the most important action begins. This arises from Panurge's determination to marry—a determination, however, which is very half-hearted, and which leads him to consult a vast number of authorities, each giving occasion for satire of a more or less complicated kind. At last it is determined that *Pantagruel* and his followers (Friar John has reappeared in the suite of the prince) shall set sail to consult the Oracle of the *Dive Bouteille*. The book ends with the obscurest passage of the whole, an elaborate eulogy of the "herb pantagrueline," which appears to be, if it is anything, hemp. Only two probable explanations of this have been offered, the one seeing in it an anticipation of Joseph de Maistre's glorification of the executioner, the other a eulogy of work, hemp being on the whole the most serviceable of vegetable products for that purpose. The fourth and fifth books are entirely taken up with a description of the voyage. Many strange places with stranger names are visited, some of them offering obvious satire on human institutions, others, except by the most far-fetched explanations, resolvable into nothing but sheer extravaganza. At last the Land of Lanterns, borrowed from Lucian, is reached, and the Oracle of the Bottle is consulted. This yields the single word "Trinç," which the attendant priestess declares to be the most gracious and intelligible she has ever heard from it. Panurge takes this as a sanction of his marriage, and the book ends abruptly. This singular romance is diversified by, or, to speak more properly, it is the vehicle of the most bewildering abundance of digression, burlesque amplification, covert satire on things political, social and religious, miscellaneous erudition of the literary and scientific kind. Everywhere the author lays stress on the excellence of "Pantagruelism," and the reader who is himself a Pantagruelist (it is perfectly idle for any other to attempt the book) soon discovers what this means. It is, in plain English, humour. The definition of humour is a generally acknowledged *crux*, and till it is defined the definition of Pantagruelism will be in the same position. But that it consists in the extension of a wide sympathy to all human affairs, together with a comprehension of their vanity, may be said as safely as anything else. Moroseness and dogmatism are as far from the Pantagruelism of Rabelais as maudlin sentimentality or dilettantism. Perhaps the chief things lacking in his attitude are, in the first place, reverence, of which, however, from a few passages, it is clear he was by no means totally devoid, and secondly, an appreciation of passion and poetry. Here and there there are touches of the latter, as in the portrait of Quintessence, but passion is everywhere absent—an absence for which the comic structure and plan of the book do not by any means supply a complete explanation.

For a general estimate of Rabelais's literary character and influence the reader may be referred to the article FRENCH LITERATURE. But some detailed remarks must be given here. There are three questions without the discussion of which this notice of one of the foremost writers of the world would not be worthy of its present place. These are—What is the general drift and purpose of *Gargantua* and *Pantagruel*, supposing there to be any? What defence can be offered, if any defence is needed, for the extraordinary licence of language and imagery which the author has permitted himself? What was his attitude towards the great questions of religion, philosophy and politics? These questions succeed each other in the order of reason, and the answer to each assists the resolution of the next.

There have been few more remarkable instances of the *lues commentatoria* than the work of the editors of Rabelais. Almost every one appears to have started with a Rabelais ready made in his head, and to have, so to speak, read that Rabelais into the book. Those who have not done this, like Le Duchat, Moutteux

and Esmangart, have generally committed the error of tormenting themselves and their author to find individual explanations of personages and events. The extravagance of the last-named commentator takes the form of seeing elaborate allegories; that of some others devotes itself chiefly to identifying the characters of the romance with more or less famous historical persons. But the first blunder, that of forming a general hypothetical conception of Rabelais and then adjusting interpretation of the work to it, is the commoner. This conception, however, has singularly varied. According to some expositors, among whom one of the latest and not the least respectable is M. Fleury, Rabelais is a sober reformer, an apostle of earnest work, of sound education, of rational if not dogmatic religion, who wraps up his morals in a farcical envelope partly to make them go down with the vulgar and partly to shield himself from the consequences of his reforming zeal. According to others, of whom we have had in England a distinguished example in Sir Walter Besant, Rabelais is all this but with a difference. He is not religious at all; he is more or less anti-religious; and his book is more or less of a general protest against any attempt to explain supernaturally the riddle of the earth. According to a third class, the most distinguished recent representative of which was M. Paul Lacroix, the Rabelaisian legend does not so much err in principle as it invents in fact. Rabelais is the incarnation of the "esprit Gaulois," a jovial, careless soul, not destitute of common sense or even acute intellectual power, but first of all a good fellow, rather preferring a broad jest to a fine-pointed one, and rollicking through life like a good-natured undergraduate. Of all these views it may be said that those who hold them are obliged to shut their eyes to many things in the book and to see in it many which are not there. The religious part of the matter will be dealt with presently; but it is impossible to think that any unbiased judge reading Rabelais can hold the grave-philosopher view or the reckless-good-fellow view without modifications and allowances which practically deprive either of any value. Those who, as it has been happily put, identify Rabelais with Pantagruel, strive in vain, on any view intellectually consistent or morally respectable, to account for the vast ocean of pure or impure laughter and foolery which surrounds the few solid islets of sense and reason and devotion. Those who in the same way identify Rabelais with Panurge can never explain the education scheme, the solemn apparition of Gargantua among the farcical and fantastic variations on Panurge's wedding, and many other passages; while, on the other hand, those who insist on a definite propaganda of any kind must justify themselves by their own power of seeing things invisible to plain men. But these vagaries are not only unjustifiable; they are entirely unnecessary. No one reading Rabelais without *parti pris*, but with a good knowledge of the history and literature of his own times and the times which preceded him, can have much difficulty in appreciating his book. He had evidently during his long and studious sojourn in the cloister (a sojourn which was certainly not less than five-and-twenty years, while it may have been five-and-thirty, and of which the studiousness rests not on legend but on documentary evidence) acquired a vast stock of learning. He was, it is clear, thoroughly penetrated with the instincts, the hopes, and the ideas of the Renaissance in the form which it took in France, in England and in Germany—a form, that is to say, not merely humanist but full of aspirations for social and political improvement, and above all for a joyous, varied, and non-ascetic life. He had thoroughly convinced himself of the abuses to which monachism lent itself. Lastly, he had the spirit of lively satire and of willingness *desipere in loco* which frequently goes with the love of books. It is in the highest degree improbable that in beginning his great work he had any definite purpose or intention. The habit of burlesquing the *romans d'aventures* was no new one, and the form lent itself easily to the two literary exercises to which he was most disposed—apt and quaint citation from and variation on the classics and satirical criticism of the life he saw around him. The immense popularity of the first two parts induced him to continue them, and by degrees (the genuineness of the fifth book, at any rate in substance, is here assumed) the possibility of giving the whole something like a consistent form and a regular conclusion presented itself to him. The voyage in particular allowed the widest licence of satirical allusion, and he availed himself of that licence in the widest sense. Here and there persons are glanced at, while the whole scenery of his birthplace and its neighbourhood is curiously worked in; but for the most part the satire is typical rather than individual, and it is on the whole a rather negative satire. In only two points can Rabelais be said to be definitely polemic. He certainly hated the monkish system in the debased form in which it existed in his time; he as certainly hated the British ignorance into which the earlier systems of education had suffered too many of their teachers and scholars to drop. At these two things he was never tired of striking, but elsewhere, even in the grim satire of the *Chats fourrés*, he is the satirist proper rather than the reformer. It is in the very absence of any cramping or limiting purpose that the great merit and value of the book consist. It holds up an almost perfectly level and spotless mirror to the temper of the earlier Renaissance. The author has no universal medicine of his own (except Pantagruelism) to offer, nor has he anybody else's universal

medicine to attack. He ranges freely about the world, touching the laughable sides of things with kindly laughter, and every now and then dropping the *risibile* and taking to the *rationale*. It is not indeed possible to deny that in the Oracle of the Bottle, besides its merely jocular and fantastic sense, there is a certain "echo," as it has been called, "of the conclusion of the preacher," a certain acknowledgment of the vanity of things. But in such a book such a note could hardly be wanting unless the writer had been a fanatic, which he was not, or a mere voluptuary, which he was not, or a dullard, which he was least of all. It is, after all, little more than a suggestion, and is certainly not strengthened by anything in the body of the work. Rabelais is, in short, if he be read without prejudice, a humorist pure and simple, feeling often in earnest, thinking almost always in jest. He is distinguished from the two men who alone can be compared with him in character of work and force of genius combined—Lucian and Swift—by very marked characteristics. He is much less of a mere mocker than Lucian, and he is entirely destitute, even when he deals with monks or pedants, of the ferocity of Swift. He neither sneers nor rages; the *rire immense* which distinguishes him is altogether good-natured; but he is nearer to Lucian than to Swift, and Lucian is perhaps the author whom it is most necessary to know in order to understand him rightly.

If this general view is correct it will probably condition to some extent the answer to be given to the two minor questions stated above. The first is connected with the great blemish of *Gargantua* and *Pantagruel*—their extreme coarseness of language and imagery. It is somewhat curious that some of those who claim Rabelais as an enemy of the supernatural in general have been the loudest to condemn this blemish, and that some of them have made the exceedingly lame excuse for him that it was a means of wrapping up his propaganda and keeping it and himself safe from the notice of the powers that were. This is not complimentary to Rabelais, and, except in some very small degree, it is not likely to be true. For as a matter of fact obscenity no less than impiety was charged against him by his ultra-orthodox enemies, and the obscenity no less than the supposed impiety gave them a handle against him before such bodies as the Sorbonne and the parliaments. As for the extreme theory of the anti-Rabelaisians, that Rabelais was a "dirty old blackguard" who liked filth and wallowed in it from choice, that hardly needs comment. His errors in this way are of course, looked at from an absolute standard, unpardonable. But judged relatively there are several, we shall not say excuses, but explanations of them. In the first place, the comparative indecency of Rabelais has been much exaggerated by persons unfamiliar with early French literature. The form of his book was above all things popular, and the popular French literature of the middle ages as distinguished from the courtly and literary literature, which was singularly pure, can hardly be exceeded in point of coarseness. The *fabliaux*, the early burlesque romances of the *Audisier* class, the farces of the 15th century, equal (the grotesque iteration and amplification which is the note of *Gargantua* and *Pantagruel* being allowed for, and sometimes without that allowance) the coarsest passages of Rabelais. His coarseness, moreover, disgusting as it is, has nothing of the corruption of refined voluptuousness about it, and nothing of the sniggering indecency which disgraces men like Pope, like Voltaire, and like Sterne. It shows in its author a want of reverence, a want of decency in the proper sense, a too great readiness to condescend to the easiest kind of ludicrous ideas and the kind most acceptable at that time to the common run of mankind. The general taste having been considerably refined since, Rabelais has in parts become nearly unreadable—the worst and most appropriate punishment for his faults. As for those who have tried to make his indecency an argument for his laxity in religious principle, that argument, like another mentioned previously, hardly needs discussion. It is notoriously false as a matter of experience. Rabelais could not have written as he has written in this respect and in others if he had been an earnestly pious person, taking heed to every act and word, and studious equally not to offend and not to cause offence. But no one in his senses would dream of claiming any such character for him.

This brings us to the last point—what his religious opinions were. He has been claimed as a free-thinker of all shades, from undogmatic theism to atheism, and as a concealed Protestant. The last of these claims has now been very generally given up, and indeed Erasmus might quite as reasonably be claimed for the Reformation as Rabelais. Both disliked and attacked the more crying abuses of their church, and both at the time and since have been disliked and attacked by the more imprudent partisans of that church. But Rabelais, in his own way, held off from the Reformation even more distinctly than Erasmus did. The accusation of free-thinking, if not of directly anti-Christian thinking, has always been more common and has recently found much favour. It is, however, remarkable that those who hold this opinion never give chapter and verse for it, and it may be said confidently that chapter and verse cannot be given. The sayings attributed to Rabelais which colour the idea (such as the famous "Je vais chercher un grand peut-être," said to have been uttered on his death-bed) are, as has been said, purely apocryphal. In the book itself nothing

of the kind is to be found. Perhaps the nearest approach to it is a jest at the Sorbonne couched in the Pauline phrase about "the evidence of things not seen," which the author removed from the later editions. But irreverences of this kind, as well as the frequent burlesque citations of the Bible, whether commendable or not, had been, were, have since been, and are common in writers whose orthodoxy is unquestioned; and it must be remembered that the later Middle Age, which in many respects Rabelais represents almost more than he does the Renaissance, was, with all its unquestioning faith, singularly reckless and, to our fancy, irreverent in its use of the sacred words and images, which were to it the most familiar of all images and words. On the other hand, there are in the book, in the description of Gargantua's and Pantagruel's education, in the sketch of the abbey of Theleme, in several passages relating to Pantagruel, expressions which either signify a sincere and unfeigned piety of a simple kind or else are inventions of the most detestable hypocrisy. For these passages are not, like many to be found from the Renaissance to the end of the 18th century, obvious flags of truce to cover attacks—mere bowings in the house of Rimmon to prevent evil consequences. There is absolutely no sign of the tongue in the cheek. They are always written in the author's highest style, a style perfectly eloquent and unaffected; they can only be interpreted (on the free-thinking hypothesis) as allegorical with the greatest difficulty and obscurity, and it is pretty certain that no one reading the book without a thesis to prove would dream of taking them in a non-natural sense. It is not, indeed, to be contended that Rabelais was a man with whom religion was in detail a constant thought, that he had a very tender conscience or a very scrupulous orthodoxy. His form of religious sentiment was not evangelical or mystical, any more than it was ascetic or ceremonial or dogmatic. As regards one of the accepted doctrines of his own church, the excellence of the celibate life, of poverty, and of elaborate obedience to a rule, he no doubt was a strong dissident; but the evidence that, as a Christian, he was unorthodox, that he was even a heretical or latitudinarian thinker in regard to those doctrines which the various Christian churches have in common, is not merely weak, it is practically non-existent. The counter-testimony is, indeed, not very strong, and still less detailed. But that is not the point. It is sufficient to say that there is absolutely nothing within the covers of Rabelais's works incompatible with an orthodoxy which would be recognized as sufficient by Christendom at large, leaving out of the question those points of doctrine and practice on which Christians differ. Beyond this no wise man will go, and short of it hardly any unprejudiced man will stop.

BIBLIOGRAPHY.—The dates of the original editions of Rabelais's works have been given where possible already. The earlier books were repeatedly reissued during the author's life, and always with some correction. What may be called the first complete edition appeared in 1567 at Lyons, published by Jean Martin. It is computed that no less than sixty editions were printed before the close of the 16th century. A very considerable time, however, elapsed before the works were, properly speaking, edited. Huet devoted much pains to them, but his results were not made public. The first edition which calls for notice, except in a complete bibliography, is that of Le Duchat (Amsterdam, 1711). Le Duchat was a very careful student, and on the whole a very efficient editor, being perhaps, of the group of students of old French at the beginning of the 18th century, which included La Monnoye and others, the most sober, critical and accomplished. But at that time the knowledge of the period was scarcely far enough advanced. The next important date in the bibliography of Rabelais is 1823, in which year appeared the most elaborate edition of his work yet published, that of Esmangart and Johanneau (9 vols.), including for the first time the *Songes Drolatiques*, a spurious but early and not uninteresting collection of grotesque figure drawings illustrating Gargantua and Pantagruel, and the second edition of M. de l'Aulnaye, containing a bad text but a useful glossary. From this time the editions have been very numerous. Among them may be mentioned those illustrated by Gustave Doré, first on a small scale (1854), afterwards more elaborately (1870); that of the Collection Didot by Burgaud des Marets and Rathery (1857 and later); the Bibliothèque Elzévirienne edition by M.M. Lacour and A. de Montaignon; that of the Nouvelle Collection Jannet (seven small volumes, 1867-74), completed by M. Moland and very useful; and lastly, the edition of M. Marty-Laveaux in the Collection Lemerre (1868-1903), the handsomest, the most accurate, and the most complete, in the scholarly sense, yet published. Commentaries on Rabelais, independent of editions, have been numerous from the work of Jean Bernier, *Jugement et nouvelles observations sur les œuvres . . . de M. François Rabelais* (1697), onwards. Of those of the last half-century the best are, besides essays in the works of most of the great critics: E. Noël, *Rabelais* (1850); A. Mayrargues, *Rabelais* (1868); Jean Fleury (1876); Paul Stapfer (the best of all) (1889); and G. Vallat (1899). Separate points have been treated importantly by A. Heulhard, *Dernières années de Rabelais* (1884), and others; while the *Revue des études Rabelaisiennes* (1903 onwards) contains valuable studies, especially those of M. Abel Lefranc.

Rabelais was very early popular in England. There are possible

allusions to him in Shakespeare, and the current clerical notion of him is very unjustly adopted by Marston in the words "wicked Rabelais"; but Bacon described him better as the great jester of France, and a Scot, Sir Thomas Urquhart, translated the earlier books in 1653. This was not worthily completed till the luckless Motteux, or, as his compatriots call him, Le Motteux, finished it with an extensive commentary. It has been frequently reprinted. A new translation by W. F. Smith appeared in 1893. Criticism of a scattered kind on Rabelais in English is abundant, that of Coleridge being the most important, while the constant evidence of his influence in Southey's *Doctor* is also noteworthy. But he was hardly treated as a whole before Sir Walter Besant's book on the subject in the "Foreign Classics for English Readers" (1879), which the author followed up with *Readings from Rabelais* (1883). Somewhat elaborate treatments of him in connexion with contemporary literature will be found in George Saintsbury's *The Earlier Renaissance* (1901) and in A. Tilley's *Literature of the French Renaissance* (1904). (G. SA.)

RABENER, GOTTLIEB WILHELM (1714-1771), German satirist, was born on the 17th of September 1714 at Wachau near Leipzig, and died at Dresden on the 22nd of March 1771. In 1741 he made his *début* as satirist in Schwabe's *Belustigungen des Verstandes und Witzes*, and was subsequently a contributor to the *Bremer Beiträge*. Rabener's satires are in prose and mainly levelled at the follies of the middle classes. The papers which he published in the *Bremer Beiträge* were subsequently collected in a *Sammlung satirischer Schriften* (2 vols., 1751), to which two volumes were added in 1755.

Rabener's *Sämtliche Werke* appeared in 6 vols. in 1777; the edition by E. Ortlepp (1839) also contains his correspondence, first published by C. F. Weiss in 1772. See P. Richter, *Rabener und Liscow* (1884), and D. Jacoby in *Allg. Deutsche Biographie* (1888).

RABIRIUS, a Latin epic poet of the age of Augustus. Among the papyrus fragments discovered at Herculaneum in the early part of the 19th century were sixty-seven (mutilated) hexameters, referring to the final struggle between Antony and Octavian and the death of Cleopatra, generally supposed to be part of a poem by Rabirius, since Seneca (*De Benef.* vi. 3, 1) informs us that he wrote on those subjects. If genuine, they justify the qualified commendation of Quintilian rather than the exaggerated praise of Velleius Paterculus (ii. 36, 3), who couples Rabirius and Virgil as the two most eminent poets of his time.

Fragments in E. Bährens, *Fragmenta Poetarum Romanorum* (1885); W. Scott, *Fragmenta Herculaniensia* (Oxford, 1885); O. Ribbeck, *Geschichte der römischen Dichtung*, ii. (1889); M. Schanz, *Geschichte der römischen Litteratur*, ii. 1 (1899); Teuffel, *Hist. of Roman Literature* (Eng. trans., 1900), 252, 9.

RABIRIUS, GAIUS, a Roman senator, who was defended (63 B.C.) by Cicero in a speech still extant. Nearly forty years after the death of L. Appuleius Saturninus, Titus Labienus (whose uncle had lost his life among the followers of Saturninus on that occasion) was put up by Caesar to accuse Rabirius of having been implicated in the murder. Caesar's real object was to warn the Senate against interference by force with popular movements, to uphold the sovereignty of the people and the inviolability of the person of the tribunes. The obsolete accusation of *perduellio* was revived, and the case was heard before Julius and Lucius Caesar as commissioners specially appointed (*duoviri perduellionis*). Rabirius was condemned, and the people, to whom the accused had exercised the right of appeal, were on the point of ratifying the decision, when Metellus Celer pulled down the military flag from the Janiculum, which was equivalent to the dissolution of the assembly. Caesar's object having been attained, the matter was then allowed to drop.

A nephew, known as C. RABIRIUS POSTUMUS, was also defended by Cicero (54 B.C.) in the extant speech *Pro Rabirio Postumo*, when charged with extortion in Egypt and complicity with Aulus Gabinius (*q.v.*).

See Cicero, *Pro Rabirio*, ed. W. E. Heitland (1882); Dio Cassius, xxxvii. 26-28; H. Putsche, *Über das genus judicii der Rede Ciceros pro C. Rabirio* (Jena, 1881); O. Schulthess, *Der Prozess des C. Rabirius* (Frauenfeld, 1891).

RACAN, HONORÉ DE BUEIL, MARQUIS DE (1589-1670), French poet, was born at the château of La Roche-Racan in 1589. He became page at the court of Henry IV. and then entered the army, seeing some active service. Racan was very poor and was practically uneducated, for, if his own account

may be credited, he had not learnt even Latin. But in middle life he inherited some property, and he was thus able to devote himself to the practice of poetry, in which he was the faithful, and perhaps the most distinguished, disciple of Malherbe. He had known Malherbe when he was a page at the court of Henry IV., and had early contributed to the fashionable albums of the day. In 1625 he published his most important work, *Bergeries*, a dramatic pastoral in five acts, a part of which, entitled *Arthénice*, was played in 1618. Racan was also the author of *Sept psaumes* (1631), *Odes sacrées tirées des psaumes de David* (1651), *Dernières œuvres et poésies chrétiennes* (1660), in all of which he was hampered by his inability to read the sacred writings except in other French paraphrases. He was one of the original members of the French Academy. He died in February 1670.

His *Œuvres complètes* were edited by Tenant de Latour in 1857, and the edition includes a biographical notice. See Sainte-Beuve, *Causeries du lundi*.

RACCONIGI, a town of Piedmont, Italy, in the province of Cuneo, 24 m. S. of Turin, and 31 m. N. of Cuneo by rail, 837 ft. above sea-level. Pop. (1901) 7364 (town); 9077 (commune). It has a royal château built in 1570, with a large park laid out in 1755 by the French gardener Molard from designs by Le Notre, and enlarged in 1835. Since 1901 it has been the summer residence of the king of Italy.

RACCOON (or **RACON**), a name borne by the typical representative of a group of American arboreal placental mammals belonging to the order **CARNIVORA** (*q.v.*) and the family **Procyonidae**. The word is a corruption of the North-American Indian "arrathkune" or "arathcone." The Fr. *raton* or *raton lavour*, Ger. *Waschbär*, and other European names are derived from a curious habit the raccoon has of dipping or washing its food in water before eating it. The typical raccoon (*Procyon lotor*) is a thickly built animal about the size of a badger, with a coat of long coarse greyish-brown hairs, short ears, and a bushy black-and-white-ringed tail. Its range extends over the whole of the United States, and stretches on the west northwards

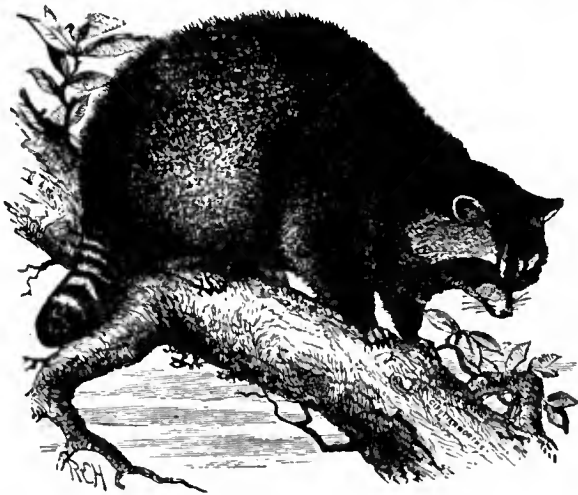

The Raccoon (*Procyon lotor*).

to Alaska and southwards well into Central America, where it attains its maximum size. The following notes on the habits of the raccoon are from Dr C. Hart Merriam's *The Mammals of the Adirondacks*:—

"Raccoons are omnivorous beasts and feed upon mice, small birds' eggs, turtles and their eggs, frogs, fish, crayfish, molluscs, insects, nuts, fruits, maize and sometimes poultry. Excepting alone the bats and flying-squirrels, they are the most strictly nocturnal of all our mammals, and yet I have several times seen them abroad on cloudy days. They haunt the banks of ponds and streams, and find much of their food in these places, such as crayfish, mussels and fish, although they are unable to dive and pursue the latter under water, like the otter and mink. They are good swimmers and do not hesitate to cross rivers that lie in their path. . . . The raccoon hibernates during the severest part of

the winter, retiring to its nest rather early, and appearing again in February or March, according to the earliness or lateness of the season. It makes its home high up in the hollow of some large tree, preferring a dead limb to the trunk itself. It does little in the way of constructing a nest, and from four to six young are commonly born at a time, generally early in April in this region. The young remain with the mother about a year."

The South-American species, *P. cancrivorus*, the crab-eating raccoon, is very similar to *P. lotor*, but differs by its shorter fur, larger size, proportionally more powerful teeth and other minor characters. It extends over the whole of South America, as far south as the Rio Negro, and is common in all suitable localities. Its habits are similar to those of the North-American species.

RACCOON-DOG (*Nyctereutes procyonoides*), a small wild dog, with sharp-pointed muzzle, short rounded ears, bushy tail and long fur, found in China, Japan and Amurland. The total length is about 32 in., of which the tail measures 4 in. The prevailing hues are black and dusky yellow, the distribution of which varies in different individuals. In habit these dogs are chiefly nocturnal; and they are said to hibernate. In winter they feed on fish, and in summer on mice, forming small packs to hunt their prey.

RACE, an homonymous word of which the principal meanings are (1) a trial or contest of speed; (2) a tribe, breed, a group of individuals descended from a common ancestor. In the first case the word is an adaptation of O.Nor. *rás*, a cognate form in O.E. being *rafs*, rush, onset; while the O.E. descendant *reese* was frequently used in medieval poetry. The particular use of the word for a swift current of water running through a narrow channel, *e.g.* the Race of Alderney, and for the water conducted in an artificial channel to a point where its power is to be used, as in "mill-race," may be due to the O.Fr. *raz* or *raze*, probably of Breton origin. The second word, an ethnical or national stock, comes from Fr. *rase*, adapted from Ital. *razzo*, cf. Span. *raza*. It has been referred to an O.H.G. *rciza*, line, mark, cognate with Eng. "write," *i.e.* the line marking descent.

RACHEL (1821-1858), French actress, whose real name was Elizabeth Felix, the daughter of poor Jew pedlars, was born on the 28th of February 1821, at Mumpf, in the canton of Aargau, Switzerland. At Reims she and her elder sister, Sophia, afterwards known as Sarah, joined a troupe of Italian children who made their living by singing in the cafés, Sarah singing and Elizabeth, then only four years of age, collecting the coppers. In 1830 they came to Paris, where they sang in the streets, Rachel giving such patriotic songs as the *Parisienne* and the *Marseillaise* with a rude but precocious energy which evoked special admiration and an abundant shower of coppers. Étienne Choron, a famous teacher of singing, was so impressed with the talents of the two sisters that he undertook to give them gratuitous instruction, and after his death in 1833 they were received into the Conservatoire. Rachel made her first appearance at the Gymnase in Paul Duport's *La Vendéenne* on the 4th of April 1837, with only mediocre success. But on the 12th of June in the following year she succeeded, after great difficulty, in making a *début* at the Théâtre Français, as Camille in Corneille's *Horace*, when her remarkable genius at once received general recognition. In the same year she played Roxane in Racine's *Bajazet*, winning a complete triumph, but it was in Racine's *Phèdre*, which she first played on the 21st of January 1843, that her peculiar gifts were most strikingly manifested. Her range of characters was limited, but within it she was unsurpassable. She excelled particularly in the impersonation of evil or malignant passion, in her presentation of which there was a majesty and dignity which fascinated while it repelled. By careful training her voice, originally hard and harsh, had become flexible and melodious, and its low and muffled notes under the influence of passion possessed a thrilling and penetrating quality that was irresistible. In plays by contemporary authors she created the characters of Judith and Cleopatra in the tragedies of Madame de Girardin, but perhaps her most successful appearance was in 1849 in Scribe and Legouvé's *Adrienne Lecouvreur*, which was written for her. In 1841 and in 1842 she visited London, where her interpretations of Corneille

and Racine were the sensation of the season. In 1855 she made a tour in the United States with comparatively small success, but this was after her powers, through continued ill-health, had begun to deteriorate. She died of consumption at Cannet, near Nice, on the 4th of January 1858, and was buried in the Jewish part of the cemetery of Père Lachaise in Paris. Rachel's third sister was Lia Felix (*q.v.*).

See Jules G. Janin, *Rachel et la tragédie* (1858); Mrs Arthur Kennard, *Rachel* (Boston, 1888); and A. de Faucigny-Lucinge, *Rachel et son temps* (1910).

RACINE, JEAN (1639-1699), French tragic dramatist, was born at La Ferté Milon in the old duchy of Valois on an uncertain date in December 1639. He was certainly christened on the 22nd, and the ceremony was at that time often, though not invariably, performed on the day of birth. Racine belonged to a family of the upper bourgeoisie, which had indeed been technically ennobled some generations earlier, and bore the punning arms of a rat and a swan (*rat, cygne*). The poet himself subsequently dropped the rat. His family were connected with others of the same or a slightly higher station in La Ferté and its neighbourhood—the Desmoulins, the Sconins, the Vitarts, all of whom appear in Racine's life. His mother was Jeanne Sconin. His father, of the same name as himself, was only four-and-twenty at the time of the poet's birth. He seems to have been a solicitor (*procureur*) by profession, and held, as his father, the grandfather of the dramatist, had done, the office of *controleur au grenier à sel*. Racine was the eldest child. Little more than a year afterwards his sister Marie was born and his mother died. Jean Racine the elder married again, but three months later he himself died, and the stepmother is never heard of in connexion with the poet or his sister. They were left without any provision, but their grandparents, Jean Racine the eldest and Marie Desmoulins, were still living, and took charge of them. These grandparents had a daughter, Agnes, who figures in Racine's history. She was a nun and later abbess of Port Royal under the style of Mère de Sainte Thècle, and the whole family had strong Jansenist leanings. Jean Racine the eldest died in 1640, and the poet was sent to the Collège de Beauvais. This (which was the grammar-school of the town of that name, and not the famous Collège de Beauvais at Paris) was intimately connected with Port Royal, and to this place Racine was transferred in November 1655. His special masters there were Nicole and Le Maître. The latter, in an extant letter written to his pupil, speaks of himself as "votre papa." It is evident from documents that he was a very diligent student both at Beauvais and Port Royal. He wrote verse both in Latin and French, and his Port Royal odes, which it has been the fashion with the more fanatical admirers of his later poetry to ridicule, are far from despicable.

Racine stayed at Port Royal for three years, and left it, when nearly nineteen, in October 1658. He was then entered at the Collège d'Harcourt and boarded with his second cousin, Nicolas Vitart, steward of the duke of Luynes. Later, if not at first, he lived in the Hôtel de Luynes itself. It is to be observed that his Jansenist surroundings continued with him here, for the duke of Luynes was a severe Port Royalist. It is, however, clear from Racine's correspondence, which, as we have it, begins in 1660 and is for some years very abundant and interesting, that he was not at all of an austere disposition at this time. Occasionally the liveliness of the letters passes the bounds of strict decency, though there is nothing very shocking in them, and those to Madame (or, as the habit of the time called her, Mademoiselle) Vitart are free from anything of this kind. It does not appear that Racine read much philosophy, as he should have done, but he occasionally did some business in superintending building operations at Chevreuse, the duke's country house. He would seem, however, to have been already given up irrevocably to literature. This by no means suited the views of his devout relations at Port Royal, and he complains in one of his letters that an unlucky sonnet on Mazarin had brought down on him "excommunications sur excommunications." The marriage of Louis XIV. was the occasion of an

ambitious ode, *La nymphe de la Seine*, which was submitted before publication to Jean Chapelain, the too famous author of the *Pucelle*. Chapelain made many suggestions which Racine duly adopted. Nor did the ode bound his ambitions, for in 1660 he finished one piece, *Amasie*, and undertook another, *Les Amours d'Ovide*, for the theatre. The first, however, was rejected by the actors of the Marais, and it is not certain that the other was ever finished or offered to those of the Hôtel de Bourgogne. Racine's letters show that he was intimate with more than one actress at this time; he also made acquaintance with La Fontaine, and the foundations at any rate of the legendary "society of four" (Boileau, La Fontaine, Molière and Racine) were thus laid.

His relations were pretty certainly alarmed by this very pardonable worldliness, though a severe expostulation with him for keeping company with the abominable actors is perhaps later in date. Racine was accordingly disturbed in his easy-going life at Paris. In November 1661 he went to Uzès in Languedoc to live with his uncle the Père Sconin, vicar-general of that diocese, whose attempts to secure a benefice for his nephew were, however, in vain. Racine was back in Paris before the end of 1663. His letters from Uzès to La Fontaine, to Le Vasseur, and others are in much the same strain as before, but there is here and there a marked tone of cynicism in them. He also attempted a little courtiership. An ode on the recovery of Louis XIV. from a slight illness probably secured him the promise of a pension, of which he speaks to his sister in the summer of 1664. It is uncertain whether this pension is identical with "gratifications" which we know that Racine for some years received, and which were sometimes eight and sometimes six hundred livres. It would seem not, as one of these gratifications had been allotted to him the year before he so wrote to his sister. The ode in which he thanked the king for his presents, *La Renommée*, is said to have introduced him to Boileau, to whose censorship there is no doubt that he owed much, if not everything; and from this date, November 1663, the familiarity of "the four" seems to have existed in full force. Unfortunately it is precisely at this date that his correspondence ceases, and it is not renewed till after the close of his brief but brilliant career as a dramatist (*Esther* and *Athalie* excepted). From this time forward the gossip of the period, and the *Life* by his son Louis, are the chief sources of information. Unfortunately Louis Racine, though a man of some ability and of unimpeached character, was only six years old when his father died, and had no direct knowledge. Still his account represents family papers and traditions; and seems to have been carefully, as it is certainly in the main impartially, written. From other sources—notably Boileau, Claude Brossette and Jean Baptiste de Valincourt—a good deal of pretty certainly authentic information is obtainable, and there exists a considerable body of correspondence between Boileau and the poet during the last ten years of Racine's life.

The first but the least characteristic of the dramas by which Racine is known, *La Thébaïde*, was finished by the end of 1663, and on Friday 20th June 1664 it was played by Molière's company at the Palais Royal theatre. Some editors assert that Molière himself acted in it, but the earliest account of the cast we have, and that is sixty years after date, omits his name, though those of Madeleine Béjard and Mademoiselle de Brie occur. There is also a tradition that Molière suggested the subject; but Louis Racine distinctly says that his father wrote most of the play at Uzès before he knew Molière. From Racine's own earlier letters it appears that the play was designed for the rival theatre, and that "La Déhanchée," Racine's familiar name for Mademoiselle de Beauchâteau, with whom he was intimate, was to play Antigone. The play itself is by far the weakest of Racine's works. He has borrowed much from Euripides and not a little from Jean de Rotrou; and in his general style and plan he has as yet struck out no great variation from Corneille. It was acted twelve times during the first month, and was occasionally revived during the year following. This is apparently the date of the pleasant picture

of the four friends which La Fontaine draws in his *Psyche*, Racine figuring as Acante, "qui aimait extrêmement les jardins, les fleurs, les ombrages," in which surroundings he helped to compose the lampoon of *Chapelain décoiffé* on a writer who had helped him with criticism, obtained royal gifts for him, and, in a fashion, started him in the literary career.

We have no definite details as to Racine's doings during the year 1664, but in February 1665 he read at the Hôtel de Nevers before La Rochefoucauld, Madame de la Fayette, Madame de Sévigné, and other scarcely less redoubtable judges the greater part of his second acted play, *Alexandre le Grand*, or, as Pomponne (who tells the fact) calls it, *Porus*. It was anxiously expected by the public, and Molière's company played it on the 4th of December—Monsieur, his wife Henrietta of England, and many other distinguished persons being present. The gazetteer, Adrien Perdou de Subigny vouches for its success, and the receipts were good and steady. But a fortnight afterwards *Alexandre* was played, "de complot avec M. Racine," says La Grange, by the rival actors (who had four days before performed it in private) at the Hôtel de Bourgogne. A vast amount of ink has been spilt on this question, but no one has produced any valid justification for Racine. That the piece failed at the Palais Royal, as is stated in the earliest attempt to excuse Racine, and the only one made in his lifetime, is not true. His son simply says that he was "mécontent des acteurs," which indeed is self-evident. It is certain that Molière and he ceased to be friends in consequence of this proceeding; and that Molière was in fault no one who has studied the character of the two men will easily believe. If, however, *Alexandre* was the occasion of showing the defects of Racine's character as a man, it raised him vastly in public estimation as a poet. He was now for the first time proposed as a serious rival to Corneille. There is a story that he read the piece to the author of the *Cid* and asked his verdict. Corneille praised the piece highly, but not as a drama, "Il l'assurait qu'il n'était pas propre à la poésie dramatique." There is no reason for disbelieving this, for the character of Alexander could not fail to shock Corneille, and he was notorious for not mincing his words. The contrast between the two even at this early period was accurately apprehended and put by Saint Evremond in his masterly *Dissertation sur l'Alexandre*, but this was not published for a year or two. To this day it is the best criticism of the faults of Racine, though not, it may be, of the merits, which had not yet been fully seen. It may be added that in the preface of the printed play the poet showed the extreme sensitiveness to criticism which perhaps excuses, and which certainly often accompanies, a tendency to criticize others. These defects of character showed themselves still more fully in another matter. The Port Royalists, as has been said, detested the theatre, and in January 1666 Nicole, their chief writer, spoke in one of his *Lettres sur les visionnaires*, directed against Desmurets de Saint-Sulin, of dramatic poets as "empoisonneurs publics." Racine immediately published a letter to the author. It is very smartly written, and if Racine had contented himself with protesting against the exaggeration of the decriers of the stage there would have been little harm done. But he filled the piece with personalities, telling an absurd story of Mère Angélique Arnauld's supposed intolerance, drawing a ridiculous picture of Le Maître (a dead man and his own special teacher and friend), and sneering savagely at Nicole himself. The latter made no reply, but two lay adherents of Port Royal took up the quarrel with more zeal than discretion or ability. Racine wrote a second pamphlet as bitter and personal as the first, but less amusing, and was about to publish it when fortunately Boileau, who had been absent from Paris, returned and protested against the publication. It remained accordingly unprinted till after the author's death, as well as a preface to both which he had prepared with a view to publishing them together and so discharging the accumulated resentment arising from a long course of "excommunications."

After this disagreeable episode Racine's life, for ten years and more, becomes simply the history of his plays, if we except

his liaisons with the actresses Mademoiselle du Parc and Mademoiselle de Champmeslé, and his election to the Academy on the 17th of July 1673. Mademoiselle du Parc (marquise de Gorla) was no very great actress, but was very beautiful, and she had previously captivated Molière. Racine induced her to leave the Palais Royal company and join the Hôtel. She died in 1668, and long afterwards the infamous Catherine Voisin accused Racine of having poisoned her. Mademoiselle de Champmeslé was plain, but an admirable actress, and apparently very attractive in some way, for not merely Racine but Charles de Sévigné and many others adored her. For five years before his marriage Racine seems to have been her *amant en titre*, but long afterwards, just before his own death, when he heard of her mortal illness, he spoke of her to his son without a flash of tenderness.

The series of his unquestioned dramatic triumphs began with *Andromaque*, and this play may perhaps dispute with *Phèdre* and *Athalie* the title of his masterpiece. It is much more uniformly good than *Phèdre*, and the character of Hermione is the most personally interesting on the French tragic stage. It is said that the first representation of *Andromaque* was on 10th November 1667, in public and by the actors of the Hôtel de Bourgogne, but the first contemporary mention of it by the gazettes, prose and verse, is on the 17th, as performed in the queen's apartment. Perrault, by no means a friendly critic as far as Racine is concerned, says that it made as much noise as the *Cid*, and so it ought to have done. Whatever may be thought of the *tragédie pathétique* (a less favourable criticism might call it the "sentimental tragedy"), it could hardly be better exemplified than in this admirable play. A ferocious epigram of Racine's own tells us that some critics thought Pyrrhus too fond of his mistress, and Andromache too fond of her husband, but in the contemporary depreciations is to be found the avowal of its real merit. Pyrrhus was taken by Floridor, the best tragic actor by common consent of his time, and Orestes by Montfleury, also an accomplished player. But Mademoiselle du Parc, who played Andromache, had generally been thought below, not above, her parts, and Mademoiselle des Oeillets, who played the difficult rôle of Hermione, was old and had few physical advantages. No one who reads *Andromaque* without prejudice is likely to mistake the secret of its success, which is, in few words, the application of the most delicate art to the conception of really tragic passion. Before leaving the play it may be mentioned that it is said to have been in the part of Hermione, three years later, that Mademoiselle de Champmeslé captivated the author. *Andromaque* was succeeded, at the distance of not more than a year, by the charming comedietta of *Les Plaideurs*. We do not know exactly when it was played, but it was printed on the 5th of December 1668. Many anecdotes are told about its origin and composition. The *Wasps* of Aristophanes, and the known fact that Racine originally destined it, not for a French company, but for the Italian troupe which was then playing the *Commedia dell' arte* in Paris, dispense us from enumerating them. The result is a piece admirably dramatic, but sufficiently literary to shock the *profanum vulgus*, which too frequently gives the tone at theatres. It failed completely, the chief favouring voice being, according to a story sufficiently well attested and worthy of belief even without attestation, that of the man who was best qualified to praise and who might have been most tempted to blame of any man then living. Molière, says Valincourt, the special friend of Racine, said in leaving the house, "Que ceux qui se moquoient de cette pièce meritoient qu'on se moquoient d'eux." But the piece was suddenly played at court a month later; the king laughed, and its fortunes were restored. It need only be added that, if Louis XIV. admired *Les Plaideurs*, Napoleon did not, and excluded it from his travelling library. It was followed by a very different work, *Britannicus*, which appeared on 13th December 1669. This was much less successful than *Andromaque*, and seems to have held its own but a very few nights. Afterwards it became very popular, and even from the first the

exquisite versification was not denied. But there is no doubt that in *Britannicus* the defects of Racine display themselves pretty clearly to any competent critic. The complete nullity of *Britannicus* himself and of Junie, and the insufficient attempt to display the complex and dangerous character of Nero are not redeemed by Agrippina, who is really good, and Burrhus, who is solidly painted as a secondary character. Voltaire calls it "la pièce des connaisseurs," a double-edged compliment. The next play of Racine has, except *Phèdre*, the most curious history of all. "*Bérénice*," says Fontenelle succinctly, "fut un duel," and he acknowledges that his uncle was not the conqueror. Henrietta of Orleans proposed (it is said without letting them know the double commission) the subject to Corneille and Racine at the same time, and rumour gives no very creditable reasons for her choice of the subject. Her death preceded the performance of the two plays, both of which, but especially Racine's, were successful. There is no doubt that it is the better of the two, but Claude Chapelle's not unfriendly criticism in quoting the two lines of an old song—

"Marion pleure, Marion crie,
Marion veut qu'on la marie"—

is said to have annoyed Racine very much, and it has a most malicious appropriateness. *Bajazet*, which was first played on 4th January 1672, is perhaps better. As a play, technically speaking, it has great merit, but the reproach commonly brought against its author was urged specially and with great force against this by Corneille. It is impossible to imagine anything less Oriental than the atmosphere of *Bajazet*; the whole thing is not only French but cphemerally French—French of the day and hour; and its ingenious scenario and admirable style scarcely save it. This charge is equally applicable with the same reservations to *Mithridate*, which appears to have been produced on 13th January 1673, the day after the author's reception at the Academy. It was extremely popular, and Racine could hardly have lodged a more triumphant diploma piece. His next attempt, *Iphigénie*, was a long step backwards and upwards in the direction of *Andromaque*. It is not that the characters are eminently Greek, but that Greek tragedy gave Racine examples which prevented him from flying in the face of the propriety of character as he had done in *Bérénice*, *Bajazet*, and *Mithridate*, and that he here called in, as in *Andromaque*, other passions to the aid of the mere sighing and crying which form the sole appeal of these three tragedies. It succeeded brilliantly and deservedly, but, oddly enough, the date of its appearance is very uncertain. It was acted at court on the 18th of August 1674, but it does not seem to have been given to the public till the early spring of 1675.

The last and finest of the series of tragedies proper was the most unlucky. *Phèdre* was represented for the first time on New Year's Day 1677, at the Hôtel de Bourgogne. Within a week the opposition company or *troupe du roi* launched an opposition *Phèdre* by Nicolas Pradon. This singular competition, which had momentous results for Racine, and in which he to some extent paid the penalty of the *lex talionis* for his own rivalry with Corneille, had long been foreseen. Racine had from the first been bitterly opposed, and his enemies at this time had the powerful support of the duchess of Bouillon, one of Mazarin's nieces, together with her brother the duke of Nevers and divers other personages of high position. These persons of quality, guided, it is said, by Madame Deshoulières, selected Pradon, a dramatist of little talent but of much facility, to compose a *Phèdre* in competition with that which it was known that Racine had been elaborating. The partisans on both sides did not neglect means for correcting fortune. On her side the duchess of Bouillon is accused of having bought up the front places in both theatres for the first six nights; on his, Racine is said to have prevailed on the best actresses of the company that played Pradon's piece to refuse the title part. There is even some ground for believing that he endeavoured to prevent the opposition play from being played at all. It was of no value, but the measures of the cabal had been so well taken that the finest tragedy

of the French classical school was all but driven from the stage, while Pradon's was a positive success. A war of sonnets and epigrams followed, during which it is said that the duke of Nevers menaced Racine and Boileau with the same treatment which Dryden and Voltaire actually received, and was only deterred by the protection which Condé extended to them.

The unjust cabal against his piece no doubt made a deep impression on Racine. But it is impossible to decide exactly how much influence this had on the subsequent change in his life. For thirteen years he had been constantly employed on a series of brilliant dramas. He now broke off his dramatic work entirely and in the remaining twenty years of his life wrote but two more plays, and those under special circumstances and of quite a different kind. He had been during his early manhood a libertine in morals and religion; he now married, became irreproachably domestic, and almost ostentatiously devout. No authentic account of this change exists; for that of Louis Racine, which attributes the whole to a sudden religious impulse, is manifestly little more than the theory of a son, pious in both senses of the word. Probably all the motives which friends and foes have attributed entered more or less into his action. At any rate, what is certain is that he reconciled himself with Arnauld and Port Royal generally, accepted, with whatever sincerity, their doctrine of the incompatibility of the stage and the Christian life, and on the 1st of June married Catherine de Romanet and definitely settled down to a quiet domestic life, alternated with the duties of a courtier. For his repentance was by no means a repentance in sackcloth and ashes. The drama was not then very profitable to dramatists, but Louis Racine tells us that his father had been able to furnish a house, collect a library of some value, and save 6000 livres. His wife had money, and he had possessed for some time (it is not certain how long) the honourable and valuable post of treasurer of France at Moulins. His annual "gratification" had been increased from 800 to 1500 livres, then to 2000, and in the October of the year of his marriage he and Boileau were made historiographers-royal with a salary of 2000 crowns. Besides all this he had, though a layman, one or two benefices. It would have been pleasanter if Louis Racine had not told us that his father regarded His Majesty's choice as "an act of the grace of God to detach him entirely from poetry." For the historiographer of Louis XIV. was simply his chief flatterer. However, little came of this historiography. The joint incumbents of the office made some campaigns with the king, sketched plans of histories and left a certain number of materials and memoirs; but they executed no substantive work. Racine, whether this be set down to his credit or not, was certainly a fortunate and apparently an adroit courtier. His very relapse into Jansenism coincided with his rise at court, where Jansenism was in no favour, and the fact that he had been in the good graces of Madame de Montespan did not deprive him of those of Madame de Maintenon. Neither in *Esther* did he hesitate to reflect upon his former patroness. But a reported sneer of the king, who was sharp-eyed enough, "Cavoie avec Racine se croit bel esprit; Racine avec Cavoie se croit courtisan," makes it appear that his comparatively low birth was not forgotten at Versailles.

Racine's first campaign was at the siege of Ypres in 1678, where some practical jokes are said to have been played on the two civilians who acted this early and peculiar variety of the part of special correspondent. Again in 1683, in 1687 and in each year from 1691 to 1693 Racine accompanied the king on similar expeditions. The literary results of these have been spoken of. His labours brought him, in addition to his other gains, frequent special presents from the king, one of which was as much as 1000 pistoles. In 1690 he further received the office of "gentilhomme ordinaire du roi," which afterwards passed to his son. Thus during the later years of his life he was more prosperous than is usual with poets. His domestic life appears to have been a happy one.

Louis Racine tells us that his mother "did not know what a verse was," but Racine certainly knew enough about verses for both. They had seven children. The eldest, Jean Baptiste, was born in 1678; the youngest, Louis, in 1692. It has been said that he was thus too young to have many personal memories of his father, but he tells one or two stories which show Racine to have been at any rate a man of strong family affection, as, moreover, his letters prove. Between the two sons came five daughters, Marie, Anne, Elizabeth, Françoise and Madeleine. The eldest, after showing "vocation," married in 1699, Anne and Elizabeth took the veil, the youngest two remained single but did not enter the cloister. To complete the notice of family matters—much of Racine's later correspondence is addressed to his sister Marie, Madame Rivière.

The almost complete silence which Racine imposed on himself after the comparative failure of *Phèdre* was broken once or twice even before the appearance of his two last exquisite tragedies. The most honourable of these was the reception of Thomas Corneille on 2nd January 1685 at the Academy in the room of his brother. The discourse which Racine then pronounced turned almost entirely on his great rival, of whom he spoke even more than becomingly. But it was an odd conjunction of the two reigning passions of the latter part of his life—devoutness and obsequiousness to the court—which made him once more a dramatist. Madame de Maintenon had established an institution, first called the Maison Saint Louis, and afterwards (from the place to which it was transferred) the Maison de Saint Cyr, for the education of poor girls of noble family. The tradition of including acting in education was not obsolete. At first the governess, Madame de Grignon, composed pieces for representation, but, says Madame de Caylus, a witness at first hand and a good judge, they were "detestable." Then recourse was had to chosen plays of Corneille and Racine, but here there were obvious objections. The favourite herself wrote to Racine that "nos petites filles" had played *Andromaque* "a great deal too well." She asked the poet for a new play suited to the circumstances, and, though Boileau advised him against it, it is not wonderful that he yielded. The result was the masterpiece of *Esther*, with music by Moreau, the court composer and organist of Saint Cyr. Although played by schoolgirls and in a dormitory, it had an enormous success, with which it may be charitably hoped that the transparent comparison of the patroness to the heroine had not too much to do. Printed shortly afterwards, it had to suffer a certain reaction, or perhaps a certain vengeance, from those who had not been admitted to the private stage. But no competent judge could hesitate. Racine probably had read and to some extent followed the *Aman* of Antoine de Montchrétien, but he made of it only the use which a proved master in literature has a perfect right to make of his fore-runners. The beauty of the chorus, which Racine had restored more probably from a study of the *Pléiade* tragedy than from classical suggestions, the perfection of the characters and the wonderful art of the whole piece need no praise. Almost immediately the poet was at work on another and a still finer piece of the same kind, and he had probably finished *Athalie* before the end of 1690. The fate of the play, however, was very different from that of *Esther*. Some fuss had been made about the worldliness of great court fêtes at Saint Cyr, and the new play, with settings as before by Moreau, was acted both at Versailles and at Saint Cyr with much less pomp and ceremony than *Esther*. It was printed in March 1691, and the public cared very little for it. The truth is that the last five-and-twenty years of the reign of Louis XIV. were marked by one of the lowest tides of literary accomplishment and appreciation in the history of France. The just judgment of posterity has ranked *Athalie*, if not as Racine's best work (and there are good grounds for considering it to be this), at any rate as equal to his best. Thenceforward Racine was practically silent, except for four *cantiques spirituelles*, in the style and with much of the merit of *Esther* and *Athalie*. The general literary sentiment led by Fontenelle (who inherited

the wrongs of Corneille, his uncle, and whom Racine had taken care to estrange further) was against the arrogant critic and the irritable poet, and they made their case worse by espousing the cause of La Bruyère, whose personalities in his *Caractères* had made him one of the best-hated men in France, and by engaging in the Ancient and Modern battle with Charles Perrault. Racine, moreover, was a constant and spiteful epigrammatist, and the unlucky habit of preferring his joke to his friend stuck by him to the last. A savage epigram on the *Sesostris* of Hilaire Bernard de Longepierre, who had done him no harm, was his familiar acquaintance, and had actually put him above Corneille in a *parallèle* between them, dates as late as 1695. Still the king maintained him in favour, and so long as this continued he could afford to laugh at Grub Street and the successors of the Hôtel de Rambouillet alike. At last, however, there seems to have come a change, and it is even probable that royal displeasure had some effect on his health. Disease of the liver appears to have been the immediate cause of his death, which took place on 12th April 1699. The king seems to have, at any rate, forgiven him after his death, and he gave the family a pension of 2000 livres. Racine was buried at Port Royal, but even this transaction was not the last of his relations with that famous home of religion and learning. After the destruction of the abbey in 1711 his body was exhumed and transferred to Saint Étienne du Mont, his gravestone being left behind and only restored to his ashes a hundred years later, in 1818. His eldest son was never married; his eldest daughter and Louis Racine have left descendants to the present day.

Racine may be considered from two very different points of view,—(1) as a playwright and poetical artificer, and (2) as a dramatist and a poet. From the first point of view there is hardly any praise too high for him. He did not invent the form he practised, and those who, from want of attention to the historical facts, assume that he did are unskilful as well as ignorant. When he came upon the scene the form of French plays was settled, partly by the energetic efforts of the *Pléiade* and their successors, partly by the reluctant acquiescence of Corneille. It is barely possible that the latter might, if he had chosen, have altered the course of French tragedy; it is nearly certain that Racine could not. But Corneille, though he was himself more responsible than any one else for the acceptance of the single-situation tragedy, never frankly gave himself up to it, and the inequality of his work is due to this. His heart was, though not to his knowledge, elsewhere, and with Shakespeare. Racine, in whom the craftsman dominated the man of genius, worked with a will and without any misgivings. Every advantage of which the Senecan tragedy adapted to modern times was capable he gave it. He perfected its versification; he subordinated its scheme entirely to the one motive which could have free play in it,—the display of a conventionally intense passion, hampered by this or that obstacle; he set himself to produce in verse a kind of Ciceronian correctness. The grammar-criticisms of Vaugelas and the taste-criticisms of Boileau produced in him no feeling of revolt, but only a determination to play the game according to these new rules with triumphant accuracy. And he did so play it. He had supremely the same faculty which enabled the *rhétoriqueurs* of the 15th century to execute apparently impossible *tours de force* in ballades couronnées, and similar tricks. He had besides a real and saving vein of truth to nature, which preserved him from tricks pure and simple. He would be, and he was, as much a poet as prevalent taste would let him be. The result is that such plays as *Phèdre* and *Andromaque* are supreme in their own way. If the critic will only abstain from thrusting in tierce, when according to the particular rules he ought to thrust in quart, Racine is sure to beat him.

But there is a higher game of criticism than this, and this game Racine does not attempt to play. He does not even attempt the highest poetry at all. His greatest achievements in pure passion—the foiled desires of Hermione and the jealous frenzy of *Phèdre*—are cold, not merely beside the crossed love

of Ophelia and the remorse of Lady Macbeth, but beside the sincerer if less perfectly expressed passion of Corneille's Cléopâtre and Camille. In men's parts he fails still more completely. As the decency of his stage would not allow him to make his heroes frankly heroic, so it would not allow him to make them utterly passionate. He had, moreover, cut away from himself, by the adoption of the Senecan model, all the opportunities which would have been offered to his remarkably varied talent on a freer stage. It is indeed tolerably certain that he never could have achieved the purely poetical comedy of *As You Like It* or the *Vida es Sueño*, but the admirable success of *Les Plaideurs* makes it at least probable that he might have done something in a lower and a more conventional style. From all this, however, he deliberately cut himself off. Of the whole world which is subject to the poet he took only a narrow artificial and conventional fraction. Within these narrow bounds he did work which no admirer of literary craftsmanship can regard without admiration. It would be unnecessary to contrast his performances with his limitations so sharply if those limitations had not been denied. But they have been and are still denied by persons whose sentence carries weight, and therefore it is still necessary to point out the fact of their existence.

BIBLIOGRAPHY.—Nearly all Racine's works are mentioned in the above notice. There is here no room for a bibliographical account of their separate appearances. The first collected edition was in 1675-76, and contained the nine tragedies which had then appeared. The last and most complete which appeared in the poet's lifetime (1697) was perhaps revised by him, and contains the dramas and a few miscellaneous works. Like the *editio princeps*, it is in 2 vols. 12mo. The posthumous editions are innumerable and gradually became more and more complete. The most noteworthy are the Amsterdam edition of 1722; that by Abbé d'Olivet, also at Amsterdam, 1743; the Paris quarto of 1760; the edition of Luneau de Boisjerman, Paris and London, 1768; the magnificent illustrated folios of 1805 (Paris); the edition of Germain Garnier with La Harpe's commentary, 1807; Geoffroy's of the next year; Aimé Martin's of 1820; and lastly, the *Grands écrivains* edition of Paul Mesnard (Paris, 1865-73). This last contains almost all that is necessary for the study of the poet, and has been chiefly used in preparing the above notice. Louis Racine's *Life* was first published in 1747. Translations and imitations of Racine are innumerable. In English the *Distressed Mother* of Ambrose Philips and the *Phædra and Hippolytus* of Edmund Smith (1672-1710), both composed more or less under Addison's influence, are the most noteworthy.

As for criticism on him, a bibliography of it would be nearly a bibliography of French critical literature. The chief recent instance of substantive work is G. Larroumet's monograph in the *Grands écrivains français* (1898), but F. Brunetière, Émile Faguet, and other critics have constantly and in various ways endeavoured to apply the general reaction from Romanticism to a semi-classical attitude to this greatest of French "classics." The conclusions above given remain unaffected by this temporary set of opinion. Racine will never be *enfoncé*—"put to rout"—as the extravagant Romantics thought him to be for a time. But, on the other hand, his limitations will remain, and no ingenious but arbitrary and extemporized theories of drama as to "conflicts of will" and the like can suffice to veil his defect in universality, his comparative shallowness, and his inadequate appreciation, or at least representation, of the richness, the intricacy and the unconventionality of nature.

(G. SA.)

RACINE, LOUIS (1692-1763), French poet, second son of Jean Racine, was born in Paris on the 6th of November 1692. Early conscious of a vocation for poetry, he had been dissuaded from following his inclination by Boileau on the ground that the gift never existed in two successive generations. In 1722 his small means induced him to accept a position in the revenue in Provence, but a marriage with a certain Mademoiselle Presle secured his independence. In 1755 he lost his son in the disasters consequent on the Lisbon earthquake. This misfortune, commemorated by Écouchard Lebrun, broke Racine's spirit. He sold his library, and gave himself up entirely to the practice of religion. In 1719 he had become a member of the Académie des Inscriptions, but had never offered himself as a member of the Académie Française, for fear, it is said, of incurring refusal on account of his Jansenist opinions. *La Grace* (1720) and *Religion* (1742), his most important work, are inspired by a sincere piety, and are written in verse of uniform clearness and excellence. His other works include epistles, odes, among which

the *Ode sur l'harmonie* (1736) should be mentioned, *Mémoires* (1747) of Jean Racine, and a prose translation of *Paradise Lost* (1755). Louis Racine died on the 29th of January 1763. He was characterized by Voltaire as "le bon versificateur Racine, fils du grand poète Racine."

His *Œuvres complètes* were collected (6 vols.) in 1808.

RACINE, a city and the county-seat of Racine county, Wisconsin, U.S.A., on the W. shore of Lake Michigan at the mouth of the Root river, about 25 m. S.S.E. of Milwaukee and about 60 m. N. of Chicago. Pop. (1890) 21,014; (1900) 29,102, of whom 9242 were foreign-born; (1910 census) 38,002. Racine is served by the Chicago & North Western and the Chicago, Milwaukee & St Paul railways, by two inter-urban electric railways, connecting with Milwaukee and Chicago, and by steamboat lines. The river has been deepened and its mouth protected by breakwaters, providing an excellent harbour; in 1909 vessels drawing 19 ft. could pass through the channel. Among the public buildings are the City Hall, the County Court House, the Federal Building, the Carnegie Library, the High School, two hospitals and the Taylor Orphan Asylum (1872). Among educational institutions, besides the public schools, are Racine College (Protestant Episcopal, 1853), St Catherine's Academy (Roman Catholic) and two business colleges. Racine is, next to Milwaukee, the most important manufacturing centre in Wisconsin. The value of its factory products in 1905 was \$16,458,965, an increase of 41% over that of 1900. Of this, \$5,177,079 (or 31.5% of the city's total) represented agricultural implements and machinery. Carriages and wagons (\$2,729,311) and automobiles ranked next in importance.

Racine was the French form of the name of the Root river. The first Europeans positively known to have visited the site of Racine were Vincennes, Tonty and several Jesuit missionaries, who stopped here for a time on their way down the coast in 1699. Early in the 19th century Jambeau, a French trader, established himself on the Root river, and in 1834 Gilbert Knapp (1798-1889), who had been a lake captain since 1818, induced several residents of Chicago to make their homes at its mouth. The place was at first called Port Gilbert. The settlement grew rapidly, a sawmill was built in 1835, and the present name was adopted in 1837. In 1841 Racine was incorporated as a village and in 1848 was chartered as a city.

See S. S. Hurlburt, *Early Days at Racine* (Racine, 1872); *History of Racine and Kenosha Counties* (Chicago, 1879).

RACK, an homonymous word of which the principal branches are the words meaning (1) a mass of cloud driving before the wind in the upper air, (2) to draw off wine or other liquor from the lees, (3) a bar or framework of bars, (4) an instrument of torture. The etymology of (1) shows that it is ultimately to be connected with "wreck" and "wrack," drifted seaweed, and means that which is driven by or drifts with the wind; cf. Norw. *rak*, wreckage, refuse, Icel. *reka*, to drive, toss. In (2) the term seems to have come from the Gascon wine-trade, as Skeat (*Ety. Dict.*, 1910) points out, and was adapted from Prov. *arracar*, to decant wine, *raca*, the stems and husks of grapes, dregs. Both (2) and (3) are in origin to be connected. The O. E. *reccan* and Ger. *recken* mean "to stretch," and so "rack" means something stretched out, a straight bar or rail, especially a toothed bar gearing with a cog-wheel, a framework of bars, as in the cradle of upright bars in which fodder can be placed for cattle, and the instrument of torture, which in Ger. is *Recke* or *Rackbank*. The "rack" for torture was an oblong frame of wood, slightly raised from the ground, having at one end a fixed bar to which the legs were fastened, and at the other a movable bar to which the hands were tied. By means of pulleys and levers this latter could be rolled on its own axis, thus straining the ropes till the sufferer's joints were dislocated. Its first employment in England is said to have been due to John Holland, 4th duke of Exeter, constable of the Tower in 1447, whence it was popularly known as "the Duke of Exeter's daughter."

In 1628 the whole question of its legality was raised by the attempt of the privy council to rack John Felton, the assassin of the duke of Buckingham. This the judges resisted, unanimously declaring its use to be contrary to the laws of England.

RACKETT, or **RACKETT-BASSOON** (Fr. *cervelas* or *cervelat*; Ger. *Rackett*, *Rankett* or *Wurstfagott*), a kind of dwarf bassoon, now obsolete, with a body measuring only from $4\frac{1}{2}$ to 11 in. in length, but nevertheless containing the necessary length of tubing to give the bassoon or contra-bassoon pitch. The rackett consists of a barrel-like body, resembling the barrel drone of the musette (see **BAGPIPE**), made of wood or ivory. Round a centre tube are grouped eight parallel channels of very narrow cylindrical bore communicating with each other and forming a continuous tube nine times the length of the small body.

A reed mouthpiece in combination with a cylindrical tube invests the latter with the acoustic properties of a closed pipe by creating a node at the mouthpiece end; the fundamental note given by such a tube is, therefore, an octave deeper in pitch than would be an open pipe of the same length. The bassoon has a conical bore and the properties of the open pipe, wherefore the aggregate length of the channels in the rackett only requires to be half that of the bassoon, a physical phenomenon to which this curious freak owed its existence. In the rackett the holes are bored obliquely through from the channels to the circumference—three in front for the left and three for the right hand, with an additional hole for the little finger; while at the back are placed the vent and three holes, one for the left thumb and two for the right, the second hole being controlled by the ball of the thumb. The rackett is played by means of a large double reed placed within a *pirouette* or cap, so that the lips do not come into contact with the reed, but only send a stream of compressed air into the *pirouette*, whereby the reed is set in vibration. The consequence of this principle of construction, peculiar to the bagpipe chaunter and drones (with a slight variation) and to cromornes, hautbois de Poitou and a few other obsolete instruments, is that no harmonics can be obtained, since the vibrating length and the tension of the reed cannot be controlled by the player; the compass is therefore obtained by means of the fundamental and of the ten holes of the instrument, aided by cross-fingering.



From Capt. C. R. Day's *Catalogue of Musical Instruments*, by permission of Eyre & Spottiswoode.

a slight variation) and to cromornes, hautbois de Poitou and a few other obsolete instruments, is that no harmonics can be obtained, since the vibrating length and the tension of the reed cannot be controlled by the player; the compass is therefore obtained by means of the fundamental and of the ten holes of the instrument, aided by cross-fingering. (K. S.)

RACQUETS, or **RACKETS**, a game played in an enclosed court with a ball and an implement with which the ball is struck called a racquet, from which the game takes its name. The racquet¹ is about $2\frac{1}{2}$ ft. long, the head, which was formerly pear-shaped, being in the modern racquet nearly circular, from 7 to 8 in. in diameter and tightly cross-strung with cat-gut. The balls, which are about $1\frac{1}{4}$ in. in diameter, are made of strips of cloth tightly wound over each other, with a sewn covering of smooth white leather, the floor and walls of English courts being coloured black; in India, where the floor and walls of the court are painted



FIG. 1.—The Racquet.

white, black balls are used. There are no regulation dimensions for a racquet court, nor for the racquet or ball, though substantial uniformity is observed in practice. The game is usually played either by two or by four players; and in England the court is the same for the four-handed and the two-handed game, the floor measuring usually 60 ft. by 30 ft., or occasionally an inch or two more each way; but in America larger courts measuring on the floor 80 ft. by 40 ft., a size formerly not

¹ The word comes, through Fr. *raquette*, from Sp. and Port. *raqueta*. The origin is doubtful, but Arab. *rāḥa(t)*, palm of the hand, has been suggested; "fives" played with the hand long preceded the game with a bat; cf. also Fr. name for fives, *paume*.

uncommon in England, are sometimes built for the four-handed game. Modern racquet courts have four walls and a roof, though in India they are sometimes left unroofed for the sake of coolness. The floor, which must be perfectly level and smooth, should be made of cement; but is sometimes paved, with less perfect results. The floor cannot be too hard, since the faster the ball travels the better the game; similarly the walls, which should be built of masonry faced with cement and most carefully smoothed, cannot be too hard and fast. The front and side walls are about 30 ft. high, the back wall being about half that height, with a gallery for spectators (containing the marker's and umpires' box) above it. The court is entered by a door in the centre of the back wall, which when shut must be perfectly flush with that wall, and without any projecting handle. The court is lighted

from the roof. The diagram (fig. 2) shows the divisions and markings of the court. On the front wall is fixed a wooden board, the upper edge of which, 26 in. from the floor, constitutes the "play-line," and which usually fills the whole space from that height to the floor; and at a height from the floor of 8 ft. or a few inches more is a second line, called the "cut-line" or "service-line," painted white or in colour. At a distance of 38 ft. (in a court 60 ft. by 30 ft.) from the front wall and parallel to it, a white line is painted on the floor from wall to wall, called the "short-line"; and from the centre of the short-line to the centre of the back wall is the "fault-line," dividing into two equal rectangles the space between the back wall and the short-line. These rectangles are the service-courts and are called the right-hand and left-hand court respectively. Against the side walls outside these courts, but so that one side in each case is formed by the short-line, are squares 8 ft. by 8 ft. called the service-boxes.

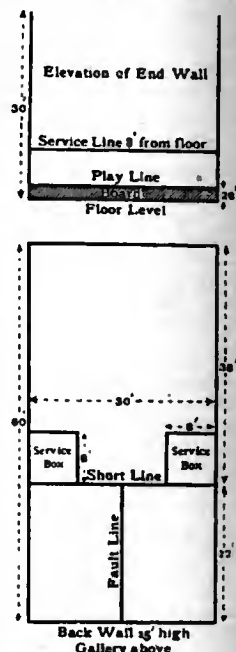

FIG. 2.

The Game.—Racquets is usually played either by two persons ("singles"), or four persons playing two against two ("doubles"); and the general idea of the game is the same as that in tennis, lawn tennis and fives, the object of the player in all these games being to score a point by striking the ball either before it reaches the ground or on its first bound, in accordance with the rules of the game, in such a way that his adversary may fail to make a "good," *i.e.* a valid, stroke in return. In the four-handed game one of each set of partners takes the right-hand court and his partner the left. The game consists of 15 points called "aces." Aces can only be scored by the "hand-in" (the player, or side, having the "innings"), and the "hand-out" must therefore win a stroke or strokes to obtain innings before he or they can score an ace; in "doubles" each of the partners has an innings, and both must therefore be ousted before "hand-out" obtains the innings; but to this rule the first innings of each game affords an exception (see below). The "hand-in" always has "service," *i.e.* he opens the rally (the "rally" being the series of strokes made alternately by the two sides until one or other of them fails to make a good return) by "serving" the ball from the hand. This first stroke, or "serve," must be made in the following manner. The server, standing with one foot at least inside one of the service-boxes, must toss the ball from his hand, and while it is in the air he must hit it with his racquet so that it strikes the front wall above the service-line and falls to the floor within the service-court on the opposite side; after striking the front wall the ball may, but need not, strike the side wall or back wall, or both, and it may do so either before or after touching the floor. The serve is a "fault" if the ball (1) strikes the front wall

above the board but on or below the service-line, in which case it is called a "cut"; or (2) touches the floor on the first bound, outside the proper service-court, when it is called "short" or "fault" according to the position of its pitch (see below). If the "hand-out" player to whom the fault is served "takes" it (*i.e.* if he plays at it), the fault is condoned and the play proceeds as if the serve had been good. If, however, the fault is not taken, the server must serve again from the same box; and if he serves a second fault he loses his "hand" or innings, and his partner or his opponent, as the case may be, takes his place. Two consecutive faults have thus the same result as the loss of a stroke in the rally by the "hand-in." A serve which makes the ball strike the board, or the floor before reaching the front wall, or which sends it "out-of-court" (*i.e.* into the gallery or roof of the court), counts the same as two consecutive faults; it costs the server his innings. Skill in service is a most important part of proficiency in racquets; a player can hardly become first-rate unless he possesses a "strong service." As in tennis a great deal of "cut" may be imparted to the ball by the stroke of the racquet, which makes the ball in its rebound from the wall behave like a billiard ball carrying "side" when striking a cushion; and when this "cut" is combined with great pace in the bound of the ball off the side wall, the back wall, and the floor, at varying angles which the server has to a great degree under his control, it becomes exceedingly difficult for hand-out to "get up" the serve (*i.e.* to hit it on the first bound, sending it above the play-line on the back wall), and still more so to make a good stroke which will render it difficult for his adversary in his turn to get up the ball and thus continue the rally. It often happens, therefore, that a long sequence of aces, sometimes the whole 15 aces of a game, are scored consecutively by service which hand-out is unable to return. A noteworthy instance of successful service occurred in the semi-final tie of the doubles Amateur Championship matches at the Queen's Club in 1897 when W. L. Foster opened service and scored all the aces in the first two games, and added six in the third, thus putting on a sequence of 36 aces before losing his "hand." To obtain first innings is therefore an initial advantage, although in doubles it is limited by the rule that only one partner shall have a "hand" (innings) in the opening service.

The question which side shall have this advantage is decided by spinning a racquet, the "rough" and "smooth" sides of which take the place of "heads" and "tails" when a coin is tossed. The side winning the spin opens the game by serving as described above. The server may begin in either of the service boxes; but when he has started, the service must proceed from the two boxes alternately till the close of the innings of the side, whether singles or doubles. When the other side obtains the innings they may in like manner begin in either box, without regard to where the last service of their opponents was delivered. In singles, hand-out changes sides in the court after each serve, answering to the change over of the server; in doubles the serve is taken alternately by the two hand-out players, who permanently occupy the right- and left-hand courts respectively, being allowed to change the order in which they receive the service only once in any game, or at the end of any game or rubber. Except in the very rare case of left-handed players most of the play in the left half of the court, including the taking of all service on that side, is back-handed; and the stronger of the two partners in back-hand play usually therefore takes the left-hand court. The best position in the court for the hand-out about to take the serve depends entirely on the nature of the service, and he has to use his judgment the instant the ball leaves the server's racquet in order to determine where it will strike the floor and at what precise point in its course it will be best for him to attempt to take it. A strong fast service, heavily cut, that sends the ball darting round the corner of the court, leaving the back wall at an extremely acute angle, or dropping almost dead off it, can only be got up by standing near the back wall a long way across the court and taking the ball by a wrist stroke at the last instant before it falls to the ground a second time. On the other hand when the server avoids the

side wall altogether and strikes the back wall direct and hard, whether he achieves a "nick" serve (*i.e.* the ball striking precisely in the angle between the back wall and the floor) or hits the wall high up, hand-out will have little time to spare in changing position to get within reach of the ball. Some good players make a practice wherever possible, especially in the case of heavily cut service, of taking the serve on the volley (*i.e.* before the ball reaches the ground), sometimes of taking the ball after it leaves the side wall and before it reaches the back wall; practice alone enables the player to decide with the necessary promptitude how each stroke is to be played. In returning the serve, or in playing any stroke during the rally, the ball may strike any of the other walls before the front wall; but though this "boasted" stroke is quite legitimate, and is sometimes the only way of getting up a difficult ball, it is not considered good style deliberately to slash the ball round the corners in order to keep it in the fore end of the court. Good play consists for the most part in hard low hitting, especially as close as possible along the side walls into the corners of the back wall. One of the most effective strokes in racquets is the "drop," which means that the ball is hit so that it only just reaches the front wall and drops close to it, while the player conceals his intention by appearing to strike hard. "The drop-stroke," says Mr Eustace Miles, who regrets that it is less cultivated than formerly, "is one of the most beautiful, and of all drop-strokes, the volley or half-volley is the best." The "half-volley," in which the ball is struck at the moment of its contact with the floor and before it has had time to rise, is also employed with great effect in hard play; it makes the return much quicker than when the ball is allowed to rise to the full length of the bound, and requires corresponding quickness on the part of the adversary. It sometimes happens, too, that the player finding himself too near the pitch of the ball to take it at the end of the bound, yet not near enough to volley it, is compelled to take it on the half-volley as the only chance of getting it up. Accuracy in volleying and half-volleying, especially if the ball be kept low, is a most difficult art to acquire, but a good long rally in which are included a number of hard rapid half-volleys within a couple of inches of the board, is the prettiest feature of the game.

If hand-out succeeds in returning the serve, the rally proceeds until one side or the other fails to make a good return. A good return means (1) that the ball is struck by the racquet before its second bound on the floor, and without its having touched any part of the clothes or person of the striker or his partner; (2) that it is hit against the front wall above the board without first touching the floor or going out of court; and (3) that it returns off the front wall into play (*i.e.* to the floor of the court or to an adversary's racquet) without going out of court. If hand-in be the one to fail in making a good return, he loses his "hand," or innings, and (in singles) hand-out goes in and proceeds to serve; in doubles one of the hand-in partners loses his "hand," and the second partner goes in and serves till he in turn similarly loses his "hand," except that in the case of the opening service in the game there is (as already mentioned) only one "hand" in any event. If hand-out fails to make a good return to the serve or to any stroke in the rally, hand-in scores an ace, and the side that first scores 15 aces wins the game. When, however, the score reaches "13-all" (*i.e.* when each side has scored 13 aces), hand-out may, before the next serve is delivered, declare that he elects to "set" the game either to 5 or 3, whichever he prefers; and similarly when the score stands at "14-all," hand-out may "set" the game to 3. He makes this declaration by calling "set-5!" or "set-3!" and it means that 5 aces, or 3 aces, as the case may be, shall be required to win the game.

In the confined space of a racquet court it is not always easy, especially in doubles, for the players to avoid obstructing each other. It is provided in the rules that "each player must get out of his opponents' way as much as possible," and that it shall be a "let" (an Old English word for impediment or hindrance) and "the service or rally shall count for nothing, and the server shall serve again from the same service-box,

(a) if the ball in play touch the striker's opponent on or above the knee, and if in the marker's opinion it be thereby prevented from reaching the front wall above the board (the play-line); or (b) if either player undesignedly prevent his opponent from returning the ball served in play." If a player considers that he has been thus obstructed by his opponent he may "claim a let," and the marker adjudicates his claim. The marker's decision is final; but "if in doubt which way to decide, the marker may direct that the ace be played over again." It is the duty of the marker, who occupies a box in the gallery, to "call the game." As soon as the server serves the ball the marker calls "Play!" if the ball strikes the front wall above the service-line; and "Cut!" if it strikes below the service-line; if the ball falls in front of the short-line the marker calls "Short!"; if the wrong side of the fault-line he calls "Fault!"; but whether it be "cut," "short," or "fault," the serve counts as a fault in its effect. To every good return, as to every good serve, the marker calls "Play!" If a return is made after the second bound of the ball (called a "double") the marker calls "Double!" or "Not up!"; if the ball is hit into the gallery, or against its posts or cushions, or above the girders or cross-beams of the roof, he calls "Out-of-court!" At the end of every rally he calls the state of the game, always naming first the score of hand-in:—"One-love" (love being the term for zero) meaning that hand-in has scored one ace and hand-out nothing, "Two-love," "Five-all," "Five-ten," "Fourteen-eleven," and so on, till one side has scored 15, when the marker calls "Game!" He then in similar fashion calls the state of the match—"Two games to one," or whatever it may be—before the commencement of the next game. The server in possession at the end of the game continues to serve in the new game, subject as before to the rule limiting the first innings of the game to a single "hand." The usual number of games in matches is five for singles, and seven for doubles. In matches where there are umpires and a referee, there is an appeal to them from the marker's decision except as regards questions relating to the service, on which the marker's decision is final.

Records.—Attempts have been made to trace racquets, like tennis, to an ancient origin; but although it is doubtless true that the striking of a ball with the hand or some primitive form of bat is one of the oldest forms of pastimes, and that racquets has been evolved from such an origin, the game as now known can hardly be said to have existed before the 19th century. Joseph Strutt's work on *The Sports and Pastimes of the People of England*, published at the beginning of the 19th century, makes no mention of racquets; and the century was far advanced before the racquet court was promoted from being an adjunct of the pot-house and the gaol, in which connexion the court within the purlieu of the Fleet prison has been immortalized in the pages of *Pickwick*, to a position scarcely less dignified than that of the tennis-court with its royal and historical associations. It was at the public schools that racquets first obtained repute. The school courts were at first unroofed, and in some cases open also at the back and sides, or on one side. Among the most famous of the early racquets professionals, before the period of the modern closed court, were Robert Mackay (1820), the brothers Thomas and John Pittman, J. Lamb, J. C. Mitchell and Francis Erwood (1860). One of the most famous matches ever played at racquets was that in which Erwood was beaten by Sir William Hart-Dyke, who used the "drop" stroke with telling effect, and who, after representing Oxford in the first four inter-university matches, was the only amateur racquet player who ever defeated the open champion. A notable date in the history of racquets was the year 1853, when the court at the old Prince's Club in Hans Place, London, was built. Here the annual racquet matches between Oxford and Cambridge Universities, singles and doubles, were first played in 1858, and the Public Schools Championship (doubles only) ten years later. Modern racquets may perhaps be said to date from the time of the brothers Gray, who as professionals greatly raised the standard of skill in the game, and as teachers at the

schools and universities improved the play of amateurs. William Gray beat Foulkes, the champion of America, in 1867; Henry Gray and Joseph Gray were also great players. The latter was beaten in 1875 by H. B. Fairs ("Punch") but held the championship from 1878 to 1887. Another member of the same family was Walter Gray, who was as distinguished for the power of his stroke as his brother William was for the accuracy of his "drop" and the ease and grace of his volley and half-volley. Walter Gray was followed in the championship by Peter Latham, the first professional to combine the open Tennis Championship with the Racquets Championship; and in the opinion of Mr Eustace Miles "there has probably lived no player who could have beaten him at either game." Latham was the first to use the heavily cut service at racquets, and he is also remarkable for the power of his wrist stroke. In the last twelve years or so of the 19th century Latham stood alone, and in the opinion of the best judges he was the greatest of all racquet players. When once he had won the championship he never lost it, and when at last he resigned his title he was succeeded by Gilbert Browne, a player of a decidedly inferior calibre, who in 1903 was challenged and beaten by an Indian marker called Jamsetji. For the next six years, during which Jamsetji held the championship, comparatively little was heard of professional racquets; but in 1909 interest was revived by a handicap at Queen's Club for a prize of £100, in which Peter Latham himself took part, and which was won by Jennings of Aldershot. As a result of this contest a challenge was issued by W. Hawes, the marker at Wellington College, to play any other professional for £200 a side and the championship of England. The challenge was accepted by C. Williams, a young player of Prince's Club, who easily won the match, and with it the title of champion.

The institution of annual matches between Oxford and Cambridge Universities in 1858, and of the Public Schools Championship in 1868, gave an immense stimulus to the game among amateurs. Of the 51 inter-university (singles) matches from 1858 to 1908, Oxford won 26 and Cambridge 25; of the 52 contests in doubles Oxford won 25 and Cambridge 27. Among the public schools Harrow has been far the most successful, having won the championship challenge cup 19 times out of 42 contests. Moreover, under the condition permitting any school winning it in three consecutive years to retain the challenge cup permanently, Harrow became possessed of three cups, having won the championship 1871-1874 inclusive, 1879-1881 inclusive, and 1883-1887 inclusive. The next most successful school has been Eton, eight times champion; Charterhouse having won five times, and no other school more than three times. For the first twenty years of the contest, with a single exception when Rugby won in 1870, no school except Eton or Harrow gained the championship; and it is not surprising therefore that the majority of famous amateurs learnt the game at one or other of these schools. Among Etonians were W. Hart-Dyke, C. J. Ottaway, the Hon. Alfred Lyttelton, the Hon. Ivo Bligh (afterwards Lord Darnley), C. T. Studd and H. Philipson; Harrow has produced R. D. Walker, one of the best of the earliest amateur racquet players, C. F. Buller, T. S. Dury, A. J. Webbe, M. C. Kemp, E. M. Butler, the brothers Eustace Crawley and H. E. Crawley, C. D. Buxton, H. M. Leaf, Percy Ashworth and C. Browning. The famous Malvern family of Foster has been as conspicuous in the racquet court as on the cricket field, the eldest, H. K. Foster, being probably the finest amateur player of his generation. F. Dames Longworth, Major A. Cooper-Key, Colonel Spens, E. M. Baerlein and Eustace H. Miles have also been in the front rank of amateur players. The opening of the Queen's Club, West Kensington, was a notable event in the history of the game, especially as it was followed by the establishment of amateur championships in singles and doubles in 1888, of which the results have been as follows:—

AMATEUR CHAMPIONSHIP

I. Singles

1888. C. D. Buxton.	1900. H. K. Foster.
1889. E. M. Butler.	1901. F. Dames Longworth.
1890. P. Ashworth.	1902. E. H. Miles.
1891. H. Philipson.	1903. E. M. Baerlein.
1892. F. Dames Longworth.	1904. H. K. Foster.
1893. F. Dames Longworth.	1905. E. M. Baerlein.
1894. H. K. Foster.	1906. S. H. Sheppard.
1895. H. K. Foster.	1907. E. B. Noel.
1896. H. K. Foster.	1908. E. M. Baerlein.
1897. H. K. Foster.	1909. E. M. Baerlein.
1898. H. K. Foster.	1910. E. M. Baerlein.
1899. H. K. Foster.	

II. Doubles

- 1890. P. Ashworth and W. C. Hedley.
- 1891. P. Ashworth and E. L. Metcalfe.
- 1892. E. M. Butler and M. C. Kemp.
- 1893. F. H. Browning and H. K. Foster.
- 1894. H. K. Foster and F. C. Ridgeway.
- 1895. F. Dames Longworth and F. H. Browning.
- 1896. H. K. Foster and P. Ashworth.
- 1897. H. K. Foster and P. Ashworth.
- 1898. H. K. Foster and W. L. Foster.
- 1899. H. K. Foster and P. Ashworth.
- 1900. H. K. Foster and P. Ashworth.
- 1901. F. Dames Longworth and V. H. Pennell.
- 1902. E. M. Baerlein and E. H. Miles.
- 1903. H. K. Foster and B. S. Foster.
- 1904. E. H. Miles and E. M. Baerlein.
- 1905. E. H. Miles and E. M. Baerlein.
- 1906. E. H. Miles and F. Dames Longworth.
- 1907. W. L. Foster and B. S. Foster.
- 1908. F. Dames Longworth and V. H. Pennell.
- 1909. E. M. Baerlein and P. Ashworth.
- 1910. B. S. Foster and Hon. C. N. Bruce.

A military championship was inaugurated in 1903 and is played annually at Princes' Club. In 1908, mainly through the exertions of Major A. Cooper-Key, a "Tennis, Racquets and Fives Association" was founded for the purpose of encouraging these games, safeguarding their interests and providing a legislative body whose authority would be recognized by all tennis and racquet players.

Racquets in America.—In the United States and in Canada racquets is a popular game, and most of the leading athletic clubs have good courts. The American champions Foulkes, Boakes and George Standing were all beaten by English professionals, but had a great reputation in their own country; and Tom Pettitt, Ellis and Moore are names that stand high in the records of the game. Among American amateurs, Lamontayne did much to encourage racquets in New York in the early period of its history; and in more recent times Quincy Shaw, de Garmendia, R. Fearing, Payne Whitney, Mackay, L. Waterbury and P. D. Haughton have shown themselves racquet players of very high merit, although Mr Eustace Miles is of opinion that "an English player like H. K. Foster, or Dames Longworth, or Ashworth, would give any American amateur upwards of seven aces."

Squash racquets is a form of the game which provides admirable practice for the beginner, and has advantages of its own which offer attractions even to those who are proficient players of real racquets. It is played with a hollow india-rubber ball about the size of a fives ball (*i.e.* nearly twice the size of an ordinary racquet ball) and with a racquet rather shorter in the handle than those used in racquets proper. The court may be of any dimensions, but is always much smaller than a real racquet court; the squash ball, being not nearly so fast as the racquet ball, would not reach the back wall in a 60 ft. court on the first bound unless hit high as well as hard against the front wall. The rules of the game itself are precisely the same as in real racquets. Squash racquets originated at Harrow, where the boys were in the habit of playing in an improvised court in the corner of the school-yard against the old school building; the windows, buttresses and water-pipe on the face of the wall forming irregularities which developed great skill on the part of the players in taking advantage of the difficulties thus caused. The marked success of Harrow in the Public Schools Championship at racquets, especially during the first twenty years of its institution (see above), has been attributed to the early training and practice gained at squash racquets in the school-yard, and in other courts which came into use as the popularity of this form of the game increased. Towards the end of the 19th century squash racquets became adopted at other schools and at the universities; and as the court is much cheaper to build than that required for real or "hard ball" racquets, and the game is cheaper as well as easier to play, many private courts came into existence. On the initiative of Lord Desborough, who had learnt the game at Harrow, several squash courts were provided at the Bath Club, London, where handicap tournaments are annually played. At Lord's cricket ground, when a new pavilion was erected in 1890, squash racquet courts were included in the building. The dimensions of the courts at Lord's, which may be taken as the best model, are as follows: length 42 ft. by 24 ft.; height of back wall 8 ft. 8 in.;

height of service-line from floor 8 ft. 9 in.; height of play-line 2 ft. 4 in. The short-line is 23 ft. from the front wall. The place which squash racquets has come to occupy may be estimated from the fact that Mr. Eustace Miles pronounces it "an almost indispensable preparation" for tennis and racquets as those games are played under modern conditions; and the same authority sufficiently describes its merits when he observes that it "gives, at a small cost of time or money, abundance of hard and brisk and simple yet exciting exercise for all times of life, of the year, and even of the day—if we have good artificial light." The squash courts at Lord's and at the Bath Club are lighted by electricity, so that play is not dependent on the condition of the atmosphere, or on the season of the year.

See *Tennis, Lawn Tennis, Rackets and Fives* in the "Badminton Library"; *Racquets and Squash*, by Eustace Miles (London, 1902); *Sporting and Athletic Register* (London, 1908). (R. J. M.)

RADAUTZ, a town in Bukovina, Austria, 35 m. S. by W. of Czernowitz by rail. Pop. (1900) 14,343, of which about 70% are Germans and 25% are Rumanians. It was formerly the seat of a Greek bishopric, removed to Czernowitz in 1786, and possesses a cathedral (1402) with the tombs of several Moldavian princes. The Austrian government has here a large stud. To the W. of Radautz are situated the old monasteries of Putna and Suczawica, dating from the 15th century. They still contain many old and valuable ecclesiastical objects of art, although a great part has been removed to the various monasteries in Moldavia.

RADBERTUS PASCHASIUS (d. c. 860), French theologian, was born at or near Soissons towards the close of the 8th century. He became a monk of Corbie, near Amiens in Picardy, in 814, and assumed the cloister name of Paschasius. He soon gained recognition as a learned and successful teacher, and the younger Adalhard, St Anskar the apostle of Sweden, Odo bishop of Beauvais and Warinus abbot of Corvei in Saxony may be mentioned among the more distinguished of his pupils. Between 842 and 846 he was chosen abbot, but as a disciplinarian he was more energetic than successful, and about 851 he resigned the office. He never took priestly orders. He died and was buried in Corbie.

Radbertus is one of the most important theologians in the history of the church. "He was perhaps the most learned and able theologian after Alcuin, as well versed in Greek theology as he was familiar with Augustinianism, a comprehensive genius, who felt the liveliest desire to harmonize theory and practice, and at the same time give due weight to tradition" (Harnack). His great work was the *Liber de Corpore et Sanguine Domini* (first ed. 831; new ed., with an epistle to Charles the Bald, 844), which was not only the first systematic and thorough treatise on the sacrament of the eucharist, but is the first clear dogmatic statement of transubstantiation, and as such opened an unending controversy. It was at once attacked by Ratramnus and Hrabanus Maurus, but was so completely in touch with the practice of the church and the spirit of the age, as to win the verdict of Catholic orthodoxy.

On the eucharistic controversy see the article on Radbertus by Steitz in Herzog-Hauek's *Real-Encyclopädie*; Bach, *Dogmengeschichte des Mittelalters*, i. 156 ff.; Ernst, *Die Lehre des h. Paschasius Radbertus v. d. Eucharistie* (1896); Renz, *Die Geschichte des Messopferbegriffs* (1901); K. G. Goetz, *Die Abendmahlsfrage in ihrer geschichtlichen Entwicklung* (1904), a complete survey of the whole problem, beginning with Radbertus. A. Harnack's treatment in his *History of Dogma* (vol. v., p. 308 ff.) is clear and appreciative.

RADCLIFFE, ANN (1764–1823), English novelist, only daughter of William and Ann Ward, was born in London on the 9th of July 1764. She was the author of three famous novels: *The Romance of the Forest* (1791), *The Mysteries of Udolpho* (1794) and *The Italian* (1797). When she was twenty-three years old she married William Radcliffe, an Oxford graduate and student of law. He gave up his profession for literature, and afterwards became proprietor and editor of the *English Chronicle*. After *The Italian* she gave up writing for publication, and was reported to have been driven mad

by the horrors of her own creations, but the nearest approach to eccentricity on Mrs Radcliffe's part was dislike of public notice. Of scenery Mrs Radcliffe was an enthusiastic admirer, and she made driving tours with her husband every other summer through the English counties. She died on the 7th of February 1823. In the history of the English novel, Mrs Radcliffe holds an interesting place. She is too often confounded with her imitators, who vulgarized her favourite "properties" of rambling and ruinous old castles, dark, desperate and cadaverous villains, secret passages, vaults, trapdoors, evidences of deeds of monstrous crime, sights and sounds of mysterious horror. She deserves at least the credit of originating a school of which she was the most distinguished exponent; and none of her numerous imitators approach her in ingenuity of plot, fertility of incident or skill in devising apparently supernatural occurrences capable of explanation by human agency and natural coincidence. She had a genuine gift for scenic effect, and her vivid imagination provided every tragic situation in her stories with its appropriate setting. Sir Walter Scott wrote an appreciative essay for the edition of 1824, and Miss Christina Rossetti was one of her admirers. She exercised a great influence on her contemporaries, and "Schedoni" in *The Italian* is one of the prototypes of the Byronic hero.

RADCLIFFE, SIR GEORGE (1593-1657), English politician, son of Nicholas Radcliffe (d. 1599) of Overthorpe, Yorkshire, was educated at Oldham and at University College, Oxford. He attained some measure of success as a barrister, and about 1626 became the confidential adviser of Sir Thomas Wentworth, afterwards earl of Strafford, who was related to his wife, Anne Trappes (d. 1659). Like his master he was imprisoned in 1627 for declining to contribute to a forced loan, but he shared the good, as well as the ill, fortunes of Wentworth, acting as his adviser when he was president of the council of the north. When Wentworth was made lord deputy of Ireland, Radcliffe, in January 1633, preceded him to that country, and having been made a member of the Irish privy council he was trusted by the deputy in the fullest possible way, his advice being of the greatest service. In 1640, Radcliffe, like Strafford, was arrested and was impeached, but the charges against him were not pressed, and in 1643 he was with Charles I. at Oxford. He died at Flushing in May 1657. Radcliffe wrote *An essay towards the life of my Lord Strafford*, from which the material for the various lives of the statesman has been largely taken.

See Sir T. D. Whitaker, *Life and Correspondence of Sir G. Radcliffe* (1810).

RADCLIFFE, JOHN (1650-1714), English physician, was born at Wakefield in 1650. He matriculated at University College, Oxford, and after taking his degree in 1669 was elected to a fellowship at Lincoln College, which he gave up in 1677 when, under the statutes of the college, he was called on to take orders. Graduating in medicine in 1675, he practised first in Oxford, but in 1684 removed to London, where he soon became one of the leading physicians. He frequently attended William III. until 1699, when he caused offence by remarking, as he looked at the King's swollen ankles, that he would not have his legs for his three kingdoms. On the 1st of November 1714 he died of apoplexy at his house in Carshalton. By his will he left property to University College for founding two medical travelling fellowships and for other purposes. Other property was put at the disposal of his executors to use as they thought best, and was employed, among other things, in building the Radcliffe Observatory, Hospital and Library at Oxford, and in enlarging St Bartholomew's Hospital in London. Radcliffe was elected M.P. for Bramber in 1690 and for Buckingham in 1713.

RADCLIFFE, an urban district in the Radcliffe-cum-Farnworth parliamentary division of Lancashire, England, on the river Irwell, 2 m. S.S.W. of Bury, on the Lancashire & Yorkshire railway. Pop. (1901) 25,368. The church of St Bartholomew dates from the time of Henry IV.; some of the Norman portions of the building remain. Cotton-weaving, calico-printing, and bleaching, dyeing, paper-making, iron-

foundry and machine-making are the principal industries, and there are extensive collieries in the neighbourhood.

RADEBERG, a town of Germany, in the kingdom of Saxony, pleasantly situated in a fertile district on the Röder, 10 m. N.E. of Dresden, by the railway to Görlitz and Breslau. Pop. (1905) 13,301. It has an Evangelical and a Roman Catholic church, and an old castle. Its principal industries are the manufacture of glass, machinery, furniture and paper, and it produces a light Pilsener beer which is largely exported. Near the town are the Augustusbad and the Hermannsbad, two medicinal springs.

RADEGUNDA, ST (d. 587), Frankish queen, was the daughter of Berthaire, king of the Thuringians. Berthaire was killed by his brother Hermannfried, who took Radegunda and educated her, but was himself slain by the Frankish kings Theuderich and Clotaire (529), and Radegunda fell to Clotaire, who later married her. Her piety was already so noteworthy that it was said that Clotaire had married a nun, not a queen. She left him when he unjustly killed her brother, and fled to Medardus, bishop of Poitiers, who, notwithstanding the danger of the act, consecrated her as a nun. Radegunda stayed in Poitiers, founded a monastery there, and lived for a while in peace. Here Venantius Fortunatus, the Italian poet, found a friendly reception, and two of the poems printed under his name are usually attributed to Radegunda. From him we gain a most pleasing picture of life at the monastery. The queen died on the 13th of August 587.

See the references in A. Molinier, *Sources de l'histoire de France*.

RADETZKY, JOSEF, COUNT OF RADETZ (1766-1858), Austrian soldier, was born at Trzebnitz in Bohemia in 1766, to the nobility of which province his family, originally Hungarian, had for several centuries belonged. Orphaned at an early age, he was educated by his grandfather, and after the old count's death, at the Theresa academy at Vienna. The academy was dissolved during his first year's residence, and he joined the army as a cadet in 1785. Next year he became an officer, and in 1787 a first lieutenant in a cuirassier regiment. He served as a galloper on Lacy's staff in the Turkish War, and in the Low Countries during the Revolutionary War. In 1795 he fought on the Rhine. Next year he served with Beaulieu against Napoleon in Italy, and inwardly rebelled at the indecisive "cordon" system of warfare which his first chief, Lacy, had instituted and other Austrian generals only too faithfully imitated. His personal courage was conspicuous; at Fleurus he had led a party of cavalry through the French lines to discover the fate of Charleroi, and at Valeggio on the Mincio, with a few hussars, he rescued Beaulieu from the midst of the enemy. Promoted major, he took part in Wurmser's Mantua campaign, which ended in the fall of the place. As lieutenant-colonel and colonel he displayed both bravery and skill in the battles of the Trebbia and Novi (1799), and at Marengo, as colonel on the staff of Melas, he was hit by five bullets, after endeavouring on the previous evening to bring about modifications in the plan suggested by the "scientific" Zach. In 1801 Radetzky received the knighthood of the Maria Theresa order. In 1805, on the march to Ulm, he received news of his promotion to major-general and his assignment to a command in Italy under the archduke Charles, and thus took part in the successful campaign of Caldiero. Peace again afforded him a short leisure, which he used in studying and teaching the art of war. In 1809, now a lieutenant field marshal, he fought at Wagram, and in 1810 he received the commandership of the Maria Theresa order and the colonelcy of the 5th Radetzky hussars. From 1809 to 1812, as chief of the general staff, he was active in the reorganization of the army and its tactical system, but, unable to carry out the reforms he desired owing to the opposition of the Treasury, he resigned the post. In 1813 he was Schwarzenberg's chief of staff, and as such had considerable influence on the councils of the Allied sovereigns and generals. Langenau, the quartermaster-general of the Grand Army, found him an indispensable assistant, and he had a considerable share in planning the Leipzig campaign and as a tactician won great praises in the

battles of Brienne and Arcis sur Aube. He entered Paris with the allied sovereigns in March 1814, and returned with them to the congress of Vienna, where he appears to have acted as an intermediary between Metternich and the czar Alexander, when these great personages were not on speaking terms.

During the succeeding years of peace he disappeared from the public view. He resumed his functions as chief of the staff, but his ardent ideas for reforming the army came to nothing in the face of the general war-weariness and desire to "let well alone." His zeal added to the number of his enemies, and in 1829, after he had been for twenty years a lieutenant field marshal, it was proposed to place him on the retired list. The emperor, unwilling to go so far as this, promoted him general of cavalry and shelled him by making him governor of a fortress. But very soon afterwards the Restoration settlement of Europe was shaken by fresh upheavals, and Radetzky was brought into the field of war again. He took part under Frimont in the campaign against the Papal States insurgents, and succeeded that general in the chief command of the Austrian army in Italy in 1834. In 1836 he became a field marshal. He was now seventy years of age, but he displayed the activity of youth in training and disciplining the army he commanded. But here too he was in advance of his time, and the government not only disregarded his suggestions and warnings but also refused the money that would have enabled the finest army it possessed to take the field at a moment's notice. Thus the events of 1848 in Italy, which gave the old field marshal his place in history among the great commanders, found him, in the beginning, not indeed unprepared but seriously handicapped in the struggle with Charles Albert's army and the insurgents. How by falling back to the Quadrilateral and there, checking one opponent after another, he was able to spin out time until reinforcements arrived, and how thenceforward up to the final triumph of Novara on the 23rd of March 1849, he and his army carried all before them, is described in the article ITALIAN WARS. The well-disciplined sense of duty to the superior officer, which was remarked even in the brilliant and sanguine young army reformer of 1810, had become more intense in the long years of peace, and after keeping his army loyal in the midst of the confusion of 1848, he made no attempt to play the part of Wallenstein or even to assume Wellington's rôle of family adviser to the nation. While as a patriot he dreamed a little of a united Germany, he remained to the end simply the commander of one of the emperor's armies. He died, still in harness, though infirm, on the 5th of January 1858.

In military history Radetzky's fame rests upon one great achievement, but in the history of the Austrian army he lives as the frank and kindly "Vater Radetzky" whom the soldiers idolized. He was fortunate in the moment of his death. In the year following, another and a greater Italian war broke out, his beloved army, disintegrated by peace economies which the old field marshal had been unable any longer to redress by ceaseless personal training, and in addition suffering from divided command and confused staff work, was defeated in every encounter.

RADEVORMWALD, a town of Germany, in the Prussian Rhine province, 10 m. E. from Remscheid, on the branch line of railway from Krebsöge. Pop. (1905) 10,978. It consists of the town proper and of several suburbs, and has five Evangelical and two Roman Catholic churches. Its chief manufactures are skates, files, locks and similar articles, and it has also cloth and cotton factories.

See J. H. Becker, *Geschichte der Stadt Radevormwald* (Cologne, 1864).

RADHANPUR, a native state of India, in the Palanpur agency, Bombay. It is situated in the north-western corner of Gujarat, close to the Runn of Cutch. The country is an open plain without hills and with few trees. It contains an area of 1150 sq. m. with a population in 1901 of 61,548, showing a decrease of 37% during the decade, due to the results of famine. The estimated revenue is £27,000. The chief products are cotton, wheat and the common varieties of grain; the only manufacture

of any importance is the preparation of a fine description of saltpetre. Radhanpur first came under British protection in 1813. The chief, whose title is Nawab, belongs to the Babi family, who have held power in Gujarat for more than two centuries. The town of Radhanpur had a population in 1901 of 11,879. It is a walled town, with an export trade in rapeseed, grain and cotton.

RADIATA, a term introduced by Cuvier in 1812 to denote the lowest of his four great animal groups or "embranchements." He defined them as possessing radial instead of bilateral symmetry, and as apparently destitute of nervous system and sense organs, as having the circulatory system rudimentary or absent, and the respiratory organs on or co-extensive with the surface of the body; he included under this title and definition five classes,—Echinodermata, Acalepha, Entozoa, Polypi and Infusoria. Lamarck (*Hist. nat. d. Anim. s. Vertèbres*) also used the term, as when he spoke of the Medusae as *radiata medusaria et anomala*; but he preferred the term Radiaria, under which he included Echinodermata and Medusae. Cuvier's term in its wide extension, however, passed into general use; but, as the anatomy of the different forms became more fully known, the difficulty of including them under the common designation made itself increasingly obvious. Milne-Edwards removed the Polyzoa; the group was soon further thinned by the exclusion of the Protozoa on the one hand and the Entozoa on the other; while in 1848 Leuckart and Frey clearly distinguished the Coelenterata from the Echinodermata as a separate sub-kingdom, thus condemning the usage by which the term still continued to be applied to these two groups at least. In 1855, however, Owen included under Lamarck's term Radiaria the Echinodermata, Anthozoa, Acalepha and Hydrozoa, while Agassiz also clung to the term Radiata as including Echinodermata, Acalepha and Polypi, regarding their separation into Coelenterata and Echinodermata as "an exaggeration of their anatomical differences" (*Essay on Classification*, London, 1859). These attempts, however, to perpetuate the usage were finally discredited by Huxley's important *Lectures on Comparative Anatomy* (1864), in which the term was finally abolished, and the "radiate mob" finally distributed among the Echinodermata, Polyzoa, Vermes (Platyhelminthes), Coelenterata and Protozoa.

RADIATION, THEORY OF. The physical activities that flourish on the surface of the earth derive their energy, in a form which is highly available thermodynamically, from the radiation of the sun. This has been ascertained to be dynamic energy, transmitted in waves by the vibrations of a medium occupying space, as the energy of sound is transmitted by the vibrations of the atmosphere. The elasticity that transmits it may be assumed to be mathematically perfect: any slight loss in transit of the light from the most distant stars, which recent statistical comparisons of brightness with distance may possibly indicate, is to be explained far more suitably by the presence of nebulous matter than by any imperfection of the aether. The latter would thus be the one perfect frictionless medium known to us: it could not be such if it were constituted, like matter, of independent molecules. It is thus on a higher plane, and may even be considered to be a dynamical specification of space itself. A molecule of matter is a kinetic system compounded of simpler elements; its energy may be classified into constitutive energy essential to its continued existence, and vibratory energy which it can receive from or radiate away into aether. A piece of matter isolated in free aether would in time lose all energy of the latter type by radiation; but the former will remain so long as the matter persists, along with the energy of the uniform translatory motion to which it is ultimately reduced. Thus all matter is in continual exchange of vibratory energy with the aether: it is with the laws of this exchange of energy that the general theory of Radiation deals, as distinguished from the mechanism of the aethereal vibrations, which is usually treated as the Theory of Light (see **AETHER**).

1. The foundation of this subject is the principle, arrived

at independently by Balfour Stewart and Kirchhoff about the year 1858, that the constitution (§ 6) of the radiation which pervades an enclosure, surrounded by bodies in a steady thermal state, must be a function of the temperature of those bodies, and of nothing else. It was subsequently pointed out by Stewart (*Brit. Assoc. Report*, 1871) that if the enclosure contains a radiating and absorbing body which is put in motion, all being at the same temperature, the constituents of the radiation in front of it and behind it will differ in period on account of the Doppler-Fizeau effect, so that there will be an opportunity of gaining mechanical work in its settling down to an equilibrium; there must thus be some kind of thermodynamic compensation, which might arise either from aetherial friction, or from work required to produce the motion of the body against pressure exerted on it by the surrounding radiation. The hypothesis of friction is now excluded in ultimate molecular physics, while the thermodynamic bearing of a pressure exerted by radiation, such as is demanded by Maxwell's electric theory, has been more recently developed on other lines by Bartoli and Boltzmann (1884), and combined with that of the Doppler effect by W. Wien (1893) in development of the ideas above expressed.

The original reasoning of Stewart and Kirchhoff rests on the dynamical principle, that by no process of ordinary reflexion or transmission can the period, and therefore the wave-length, of any harmonic constituent of the radiation be changed; each constituent remains of the same wave-length from the time it is emitted until the time it is again absorbed. If we imagine a field of radiation to be enclosed within perfectly reflecting walls, then, provided there is no material substance in the field which can radiate and absorb, the constitution of the radiation in it may be any whatever, and it will remain permanent. It is only the presence of material bodies that by their continued emission and absorption can transform the surrounding radiation towards the unique constitution which corresponds to their temperature. We can define the temperature of an isolated field of radiation, of this definite ultimate constitution, to be the same as that of the material bodies with which it would thus be in equilibrium. Further, the mutual independence of the various constituents of any field of radiation enclosed by perfect reflectors allows us to assign a temperature to each constituent, such as the part involving wave-lengths lying between λ and $\lambda + \delta\lambda$; that will be the temperature of a material system with which this constituent by itself is in equilibrium of emission and absorption. But to reason about the temperature of radiation in this way we must be sure that it completely pervades the space, and has no special direction; this is ensured by the continual reflexions from the walls of the enclosure. The question of the temperature of a directed wave-train travelling through space, such as a beam of light, will come up later. The temperature of each constituent in a region of undirected radiation is thus a function of its wave-length and its intensity alone. It is the fundamental principle of thermodynamics, that temperatures tend to become uniform. In the present case of a field of radiation, this equalization cannot take place directly between the various constituents of the radiation that occupy the same space, but only through the intervention of the emission and absorption of material bodies; the constituent radiations are virtually partitioned off adiabatically from direct interchange. Thus in discussing the transformations of temperatures of the constituent elements of radiation, we are really reasoning about the activity of material bodies that are in thermal equilibrium with those constituents; and the theoretical basis of the idea of temperature, as depending on the fortuitous residue of the energy of molecular motions, is preserved.

2. *Mechanical Pressure of Undulatory Motions.*—Consider a wave-train of any kind, in which the displacement is $\xi = a \cos m(x+ct)$ so that it is propagated in the direction in which x decreases; let it be directly incident on a perfect reflector travelling towards it with velocity v , whose position is there-

fore given at time t by $x=vt$. There will be a reflected train given by $\xi' = a' \cos m'(x-ct)$, the velocity of propagation c being of course the same for both. The disturbance does not travel into the reflector, and must therefore be annulled at its surface; thus when $x=vt$ we must have $\xi + \xi' = 0$ identically. This gives $a' = -a$, and $m'(c-v) = m(c+v)$. The amplitude of the reflected disturbance is therefore equal to that of the incident one; while the wave-length is altered on the ratio $\frac{c-v}{c+v}$, which is approximately $1 - \frac{v}{c}$, where v/c is small, and is thus in agreement with the usual statement of the Doppler effect. The energy in the wave-train being half potential and half kinetic, it is given by the integration of $\rho(d\xi/dt)^2$ along the train, where ρ represents density. In the reflected train it is therefore augmented, when equal lengths are compared, in the ratio $\left(\frac{c+v}{c-v}\right)^2$; but the length of the train is diminished by the reflexion in the ratio $\frac{c-v}{c+v}$; hence on the whole the energy transmitted per unit time is increased by the reflexion in the ratio $\frac{c+v}{c-v}$. This increase per unit time can arise only from work done by the advancing reflector against pressure exerted by the radiation. That pressure, per unit surface, must therefore be equal to the fraction $\frac{2}{c-v}$ of the energy in a length $c+v$ of the incident wave-train; thus it is the fraction $\frac{c^2 - v^2}{c^2 + v^2}$ of the total density of energy in front of the reflector, belonging to both the incident and reflected trains. When v is small compared with c , this makes the pressure equal to the density of vibrational energy, in accordance with Maxwell's electrodynamic formula (*Elec. and Mag.*, 1871).

The argument may be illustrated by the transverse vibrations of a tense cord, the reflector being then a lamina through a small aperture in which the cord passes; the lamina can thus slide along the cord and sweep the vibratory motion in front of it. In this case the force acting on the lamina is the resultant of the tensions T of the cord on the two sides of the aperture, giving a lengthwise force $\frac{1}{2}Td(\xi + \xi')^2/dx^2$ when, as usual, powers higher than the second of the ratio of amplitude to wave-length are neglected; this, when v/c is small, is an oscillatory force of amount $2\rho(d\xi/dt)^2$, whose time-average agrees with the value above obtained. If we consider a finite train of waves thus sent back from a moving reflector, the time integral of the pressure must represent force transmitted along the cord, or a gain of longitudinal momentum in the reflected waves, or both together.

When it is a case of transverse waves in an elastic medium, reflected by an advancing obstacle, the origin of the working pressure is not so obvious, because we cannot easily formulate a mechanism for the advancing reflector like that of the lamina above employed. In the case of light-waves we can, however, imagine an ideal material body, constituted of very small molecules, that would sweep them in front of it with the same perfection as a metallic mirror actually reflects the longer Hertzian waves. The pressure will then be identified physically, as in the case of the latter waves, with the mechanical forces acting on the screening oscillatory electric current-sheet which is induced on the surface of the reflector. The displacement represented above by ξ , which is annulled at the reflector, may then be taken to be either the tangential electric force or the normal component of the vector whose velocity is the magnetic force. The latter interpretation is theoretically interesting, because that vector, which is the dynamical displacement in electron-theory, usually occurs only through its velocity. The general case of oblique incidence can be treated on similar lines; each filament of radiation (ray) in fact exerts its own longitudinal push equal to its energy per unit length, and it is only a matter of summation.

The usual formula for the pressure of electric radiation is

derived from a theory, namely, that of the ordinary electro-dynamic equations, which considers the velocity of the matter, or rather of the electrons associated with it, to be so small compared with that of radiation that the square of the ratio of these velocities can be neglected. The formula above obtained is of general application, and shows that for high values of v the pressure must fall off. It has been urged as an objection to the thermodynamic reversibility of a ray (§ 8) that the work of the radiant pressure exerted at its front is lost, as there is no obstacle to sustain it; but on an obstacle moving with the velocity of the wave-front the pressure would vanish, so that this objection does not now hold.

In every such case of an advancing perfect reflector the aggregate amplitude of the superposed incident and reflected wave-trains, of different wave-lengths and periods, will be represented by

$$\xi + \xi' = 2a \sin \frac{mv}{c-v} (x - \frac{c^2}{v} t) \sin \frac{mc}{c-v} (x - vt);$$

thus the appearance presented will be that of a train of waves each of length $(1-v/c)2\pi/m$, and progressing with the velocity v of the reflector, which travels at one of the nodes of the train. This slowly travelling wave-train corresponds to the stationary train which would be produced by a stationary perfect reflector; but the amplitude is now a varying quantity which, once uniform vibration has been fully established along any path, may itself be described as running on after the manner of a superposed wave-train of very great wave-length $(c/v-1)2\pi/m$ and of very great velocity c^2/v . A somewhat similar state of things arises when a wave-train is incident on a stationary reflector very nearly normally, as may sometimes be seen with incoming rollers along a shelving beach; the visible disturbance at a reflecting ridge, arising from each single wave-crest, then rushes along the ridge at a speed which is at first sight surprising, as it is enormously in excess of the speed possible for any simple train of waves travelling into quiescent aether.

3. *Wien's Law.*—Let us consider a spherical enclosure filled with radiation, and having walls of ideal perfectly reflecting quality so that none of the radiation can escape. If there is no material body inside it, any arbitrarily assigned constitution of this radiation will be permanent. Let us suppose that the radius a of the enclosure is shrinking with extremely small velocity v . A ray inside it, incident at angle ι , will always be incident on the walls in its successive reflexions at the same angle, except as regards a negligible change due to the motion of the reflector (§ 2); and the length of its path between successive reflexions is $2a \cos \iota$. Each undulation on this ray will thus undergo reflexion at intervals of time equal to $2a \cos \iota/c$, where c is the velocity of light, and it is easily verified that on each reflexion it is shortened by the fraction $2v \cos \iota/c$ of itself: thus in the very long time T required to complete the shrinkage it is shortened by the fraction vTa , which is $\delta a/a$ where δa is the total shrinkage in radius, and is independent of the value of ι . The wave-length of each undulation in the radiation inside the enclosure is therefore reduced in the same ratio as the radius. Now suppose that the constitution of the enclosed radiation corresponded initially to a definite temperature. During the shrinkage thermal equilibrium must be maintained among its constituents; otherwise there would be a running down of their energies towards uniformity of temperature, if material radiating bodies are present, which would be superposed on the mechanical operations belonging to the shrinkage, and the process could not be reversible. Such a state of affairs is not possible, for it would land us in processes of the following type. Expand the enclosure, gaining the mechanical work of the radiant pressure against its walls, whatever that may be. Then equalize the intensities of the constituent radiations to those corresponding to a common temperature, by taking advantage of the absorptions of material bodies at the actual temperatures of these radiations; when this is done, as it may actually be to some extent by aid of the sifting produced by partitions which transmit some kinds of radiation more rapidly than others, a

further gain of work can be obtained at the expense of the radiant energy. Then contract the remaining radiant energy to its previous volume, which requires an expenditure of less work on the walls of the enclosure than the expansion of the greater amount of radiation originally afforded; and, finally, gain still more work by again equalizing the temperatures of its constituents. The energy now remaining, being of smaller amount and under similar conditions, must have a temperature lower than the initial one. This process might be repeated indefinitely, and would constitute an engine without an extraneous refrigerator, violating Carnot's principle by deriving an unlimited supply of mechanical work from thermal sources at a uniform temperature.

Thus, independently of any knowledge of the intensity of the mechanical pressure of radiation, or indeed of whether such a pressure exists at all, it is established that the shrinkage of the enclosure must directly transform the contained radiation to the constitution which corresponds to some definite new temperature. Now we have seen that the wave-lengths of its constituents are all reduced in the same ratio by this process. If, then, we can prove that the intensities of these constituents are also all changed in a common ratio by the reflexions at the shrinking envelope, it will follow that the distributions of the radiation among the various wave-lengths are, at these two temperatures, and therefore at any two temperatures, homologous, in the sense that the intensity curves, after the wave-lengths in one of them have been reduced in a ratio depending definitely on the two temperatures, differ only in the absolute scale of magnitude of the ordinates.

This procedure modifies Wien's argument by employing a uniformly shrinking spherical enclosure (cf. *Brit. Assoc. Report*, 1900). If the enclosure is not spherical, the angles of incidence at successive reflexions of the same ray will differ by finite amounts; we must then estimate the average effect of the shrinkage. In the form of enclosure here employed all rays are affected alike, and no averaging is required; while by the principle of Stewart and Kirchhoff what is established for any one form is of general validity.

4. *Pressure of Natural Radiation.*—The question reserved above has now to be settled. At first sight it might have appeared that the reflexion is simply total; but, as has been seen in § 2, the advancing perfect reflector does work against the pressure of the radiation, and this work must be changed into radiant energy and thus go to increase the intensity of the reflected ray. Considering electric radiation incident at angle ι , the tangential electric force is annulled at the reflector; hence the amplitude of the electric vibration is conserved on reflexion, though its phase is reversed. As already seen, the wave-length is shortened approximately by the fraction $2v \cos \iota/c$ in each reflexion; thus, just as in § 2, the energy transmitted per unit time per unit area is increased in the same ratio; and allowing for the factor $\cos \iota$ of foreshortening, there is therefore a radiant pressure equal to the total density of radiant energy in front of the reflector multiplied by $\cos^2 \iota$. This argument, being independent of the wave-length, applies to each constituent of the radiation in this direction separately; thus their energies are all increased in the same ratio by the reflexion, as was to be proved. When we are dealing with the natural radiation in an enclosure, which is distributed equally in all directions, this factor $\cos^2 \iota$ must be averaged; and we thus attain Boltzmann's result that the radiant pressure is then one-third of the density of radiant energy in front of the reflector, this statement holding good as regards each constituent of the natural radiation taken separately.

5. *Adiabatic Relations.*—Consider the enclosure filled with radiation of energy-density E at volume V , of any given constitution but devoid of special direction, and let it be shrunk to volume $V - \delta V$ against its own pressure; if the density thereby become $E - \delta E$, the conservation of the energy requires

$$EV + \frac{1}{3}E\delta V = (E - \delta E)(V - \delta V),$$

so that $\frac{1}{3}E\delta V + V\delta E = 0$, or E varies as $V^{-\frac{1}{3}}$.

Again—but now with a restriction to radiation with its energy

distributed as regards wave-length so as to be of uniform temperature—the performance of this mechanical work $\frac{1}{3}E\delta V$ has changed the energy of radiation EV from the state that is in equilibrium of absorption and emission with a thermal source at temperature T to the state in equilibrium with an absorber of some other temperature $T-\delta T$, and that in a reversible manner; thus by Carnot's principle

$$\frac{1}{3}E\delta V/EV = -\delta T/T,$$

so that T varies as $V^{-1/3}$, or inversely as the linear dimensions when the enclosure is shrunk uniformly.

Combining these results, it appears that E varies as T^4 ; this is Stefan's empirical law for the complete radiation corresponding to the temperature, first established on these lines by Boltzmann. Starting from the principle that this radiation must be a function of the temperature alone, this adiabatic process has in fact given us the form of the function. These results cannot, however, be extended without modification to each separate constituent of the complete radiation, because the shrinkage of the enclosure alters its wave-length and so transforms it into a different constituent.

6. *Law of Distribution of Energy.*—The effect of compressing the complete radiation is thus to change it to the constitution belonging to a certain higher temperature, by shortening all its wave-lengths by the proportion of one-third of the compression by volume, the temperature being in fact raised by the same proportion; at the same time increasing in a uniform ratio the amounts corresponding to each interval $\delta\lambda$, so as to get the correct total amount of energy for the new temperature. In the compression each constituent alters so that $T\lambda$ remains constant, and the energy $E\lambda\delta\lambda$ in the range $\delta\lambda$ in other respects changes as a function of T alone. Hence generally $E\lambda\delta\lambda$ must be of form $F(T)f(T\lambda)\delta\lambda$. But for each temperature $\int_0^\infty E\lambda\delta\lambda$ is equal to E and so varies as T^4 , by Stefan's law; that is,

$$T^{-1}F(T)\int_0^\infty f(T\lambda)d(T\lambda) \propto T^4,$$

so that $T^{-1}F(T) \propto T^4$. Thus, finally, $E\lambda\delta\lambda$ is of form $AT^5f(T\lambda)\delta\lambda$ or $\lambda^{-5}\phi(T\lambda)\delta\lambda$, which is Wien's general formula.

7. *Transformation of a Single Constituent.*—It is of interest to follow out this adiabatic process for each separate constituent of the radiation, as a verification, and also in order to ascertain whether anything new is thereby gained. To this end let now $E(\lambda, T)\delta\lambda$ represent the intensity of the radiation between λ and $\lambda+\delta\lambda$ which corresponds to the temperature T . The pressure of this radiation, when it is without special direction, is in intensity one-third of this; thus the application of Carnot's principle shows, as before, that in adiabatic compression $T \propto V^{-1/3}$, so that a small linear shrinkage in the ratio $1-x$ raises T in the ratio $1+x$. We have still to express the equation of energy. The vibratory energy $E(\lambda, T)\delta\lambda \cdot V$ in volume V , together with the mechanical work $\frac{1}{3}E(\lambda, T)\delta\lambda \cdot 3xV$, yields the vibratory energy

$$E\{\lambda(1-x), T(1+x)\}\delta\lambda(1-x) \cdot V(1-3x);$$

thus, writing E and E_λ or $E(\lambda, T)$ we have, neglecting x^2 ,

$$E(1+x) = (E - x\lambda \frac{dE}{d\lambda} + xT \frac{dE}{dT})(1-4x),$$

so that $5E + \lambda \frac{dE}{d\lambda} - T \frac{dE}{dT} = 0$,

a partial differential equation of which the integral is

$$E = \lambda^{-5}\phi(T\lambda),$$

the same formula as was before obtained.

This method, treating each constituent of the radiation separately, has in one respect some advantage, in that it is necessary only to postulate an enclosure which totally reflects that constituent, this being a more restricted hypothesis than an absolutely complete reflector.

To determine theoretically the form of the function ϕ we must have some means of transforming one type of radiation into another, different in essence from the adiabatic compression already utilized. The condition that the entropy of the independent radiations in an enclosure is a minimum when they are all transformed to the same temperature with total

energy unaltered, is already implicitly fulfilled; it would thus appear that any further advance must involve (§ 11) the dynamics of the radiation and absorption of material bodies.

8. *Temperature of an Isolated Ray.*—The temperature of each independent constituent of a radiation has here been taken to be a function of the intensity E_λ , where $E_\lambda\delta\lambda$ is the energy per unit volume in the range between wave-lengths λ and $\lambda+\delta\lambda$; the condition is, however, imposed that this radiation is indifferent as to direction. When a beam of radiation travels without loss in a definite direction across a medium, its form varies as it progresses; but it is reversible inasmuch as it can be turned back at any stage, or concentrated without loss, by perfect reflectors. If the energy of the beam has a temperature, its value must therefore remain constant throughout the progress of the beam, by the principle of Carnot. Now by virtue of a relation in geometrical optics, which on a corpuscular theory would be one aspect of the fundamental dynamical principle of Action, the cross-section δS at any place on the beam, and the conical angle $\delta\omega$ within which the directions of its rays are there included, are such that the value of $V^{-2}\delta S\delta\omega$ is conserved along the beam, V being the velocity of propagation of the undulations. If we represent the amount of radiant energy transmitted per unit time across the section δS of the beam by $I\delta S\delta\omega$, it will follow that in passing along the beam its intensity of illumination I varies as V^{-2} , or as the square of the index of refraction, provided there is no loss of energy in transmission. This condition requires that changes of index shall be gradual, otherwise there would be loss of energy by partial reflexions; in free aether I is itself constant along the beam. The volume-density of the energy in any part of the directed beam is $V^{-1}I\delta\omega$; it is thus inversely as the solid angular concentration of the rays and directly as the cube of the index of refraction. Now we may consider this beam, of aggregate intensity $I\delta S\delta\omega$, to form an elementary filament of the radiation issuing in the direction of the normal from a perfect radiator. As such a body absorbs completely and therefore radiates equally in all directions in front of it, the total intensity of radiation from its element of surface δs is $\delta s \int I \cos \theta d\omega$, or $\delta s \cdot \pi I$, while the volume-density of the total advancing and receding radiation in front of it is $2V^{-1} \int I d\omega$, and therefore $4\pi V^{-1}I$. If we take here $I\delta\lambda$ to represent the intensity between wave-lengths λ and $\lambda+\delta\lambda$, this density is the quantity E_λ of which the temperature of the radiator is a function. Thus the quantity I —which optically is a measure of the brightness of the beam, and is conserved along it to the extent that $\mu^2 I$ is the same from whichever of its cross-sections the beam is supposed to be emitted—also determines its temperature, the latter being that of an enclosure containing undirected radiation of the same range $\delta\lambda$ which is density $E_\lambda\delta\lambda$ given by $E_\lambda = 4\pi V^{-1}I$, where V is the velocity of radiation in the enclosure. When a beam of radiation travels without suffering absorption, its temperature thus continues to be that of its source multiplied by the coefficient of emission of the source for that kind of radiation, this coefficient being less than unity except in the case of a perfect radiator; but when its intensity I falls by δI in any part of its path owing to absorption or other irreversible process, this involves a further fall of temperature of the energy of the beam and a rise of entropy which can be completely determined when the relation connecting $\mu^{-3}E_\lambda$ with T and λ is known. Any directed quality in radiant energy increases its effective temperature. Splitting a beam into two at a reflecting and refracting surface diminishes the temperature of each part; it is true that if the reflecting surface were non-molecular the operation could be reversed, but actually the reversed rays would encounter the reflecting molecules in different collocations, and could not (§ 11) recombine into the same detailed phase-relations as before. The direct solar radiation falling on the Earth is almost completely convertible into mechanical effect on account of its very high temperature; there seems ground for believing that certain constituents of it can actually be almost wholly turned to account by the

green leaves of plants. But the same solar radiation, when broken up into diffused sky light, which has no definite direction, has fallen into equilibrium with a much lower temperature, through loss of its reversibility. It has been remarked that the temperatures of the planets can be roughly compared by means of this principle, if their coefficients of absorption of the solar radiation are assumed; that of Neptune comes out below -200° C., if we suppose that it is not kept higher by a supply of internal heat.

To obtain dynamical precision in this discussion an exact definition of the narrow beam such as is usually called a ray is essential. It can be specified as a narrow filament of radiation, such as may be isolated within an infinitely thin, impermeable, bounding tube without thereby producing any disturbance of the motion. If either the tube or the surrounding radiation were not present to keep the beam in shape, it would spread sideways, as in optical diffraction. But the function of the tube is one of pure constraint; thus the change of energy-content of a given length of the tube is represented by energy flowing into it at the end where the radiation enters, and leaving it at the other end, but with no leakage at the sides. The total radiation may be considered as made up of such filaments.

9. *Temperature of the Sun.*—The mean temperature of the radiating layers of the Sun may be estimated from Stefan's law, by computing the intensity of the radiation at his surface from that terrestrially observed, on the basis of the law of inverse squares; the result is about 6500° C. The application of Wien's law, which makes the wave-length of maximum energy vary inversely as the temperature, for the case of a perfectly radiating source, gives a result 5500° C. These numbers will naturally differ because (i) the Sun is not a perfect radiator, the constitution of his radiation in fact not following the law of that of a black body, (ii) the various radiating layers have different temperatures, (iii) the radiation may be in part due to chemical and electrical causes, and in so far would not be determined by the temperature alone. The fair agreement of these two estimates indicates, however, that the radiation is largely regulated by the temperature, that the layers from which the main part of it comes are at temperatures not very different, and that not very much of the complete radiation established in these layers and emitted from them is absorbed by the overlying layers.

10. *Fluorescence.*—When radiation of certain wave-lengths falls on a fluorescent body, it is largely absorbed, but in such manner as directly to excite other radiation of different type which is emitted in addition to the true temperature-radiation of the body. The distinction involved is that the latter radiation is spontaneously convertible with the heat of the absorbing body at its own temperature, without any external stimulus or compensation; it is, in fact, on the basis of this convertibility that the thermodynamic relations of the temperature-radiation have been established. According to the experimental law of Stokes, the wave-lengths of the fluorescent radiation are longer than those of the radiation which excites it. If the latter were directly transformed, in undiminished amount, into the fluorescent kind, this is what would be expected. For such a spontaneous change must involve loss of availability; and, beyond the wave-length of maximum energy in the spectrum, the temperature of a given density of radiation is greater the shorter its wave-length, as it is a function of that density and the wave-length alone such that greater radiation always corresponds to higher temperature. But it would appear that the opposite should be the case for radiation of long wave-lengths, lying on the other side of the maximum, in which the tendency would thus be for spontaneous change into shorter waves; this may perhaps be related to the fact that the lines of longer wave-lengths in spectra often come out brighter at lower temperatures, for they are then thrown on the other side of the maximum and cannot be thus degraded. The principle does not, however, have free play in the present case, even when the incident radiation is diffused and so has not the abnormally high temperature associated with a directed beam

(§ 8), since part of it might be degraded into low-temperature heat, or there might be other compensation of chemical type for any abnormally high availability that might exist in the fluorescent radiation. It has been found that fluorescent radiation, showing a continuous or banded spectrum, can be excited in many gases and vapours; milky phosphorescence of considerable duration, and thus doubtless associated with chemical change, is produced in vacuum tubes, containing oxygen or other complexly constituted gases, by the electric discharge.

11. *Entropy of a Ray.*—If each definitely constituted beam of radiation has its own temperature and everything is reversible as above, a question arises as to the location of the process of averaging which enters into the idea of temperature. The answer can depend only on the fact, that although the beam is definite as to wave-length and intensity, yet it is far from being a simple wave-train, in that it is constituted of trains of limited lengths and various phases and polarizations, coming from the independent radiating molecules. When such a beam has once emerged, it travels without change, and can be reflected back intact to its source, and is in so far reversible; but when it has arrived there, the molecules of the source will have changed their positions, and it cannot be wholly reabsorbed in the same manner as it was emitted. There must thus be some feature in the ultimate averaged constitution of the beam, emitted from a body in the definite steady state of internal motion determined by its temperature, which adapts it for spontaneous uncompensated reabsorption into a body at its own (or a lower) temperature, but not at a higher one.

The question of the determination of the form of the function ϕ in § 6 would thus appear to be closely connected with the other problems, hitherto imperfectly fathomed, relating to the statistics of kinetic molecular theory. A very interesting attack on the problem from this point of view has recently been made in various forms by Planck. It of course suffices to examine some simple type of radiating system, and the results will be of general validity. He considers an enclosure filled with radiation involving an entirely arbitrary succession of phases and polarizations along each ray, and also containing a system of fixed linear electric oscillators of the Hertzian type, which are taken to represent the transforming action of radiating and absorbing matter. The radiation contained in the enclosure will be passed through these oscillators over and over again, now absorbed, now radiated, and each constituent will thus settle down in a unilateral or irreversible manner towards some definite intensity and composition. But it does not appear that a system of vibrators of this kind, each with its own period, can perform one of the main functions of a material absorber, namely, the transformation of the relative intensities of the various types of radiation in the enclosure to those corresponding to a common temperature. There would be equilibrium established only between the mean internal vibratory energy in the vibrators of each period and the density of radiation of that period; there is needed also some means of interchanging energy between vibrators of different periods, which probably involves doing away with their fixity, or else employing more complex vibrators and assuming a law of distribution of their internal energy. In the absence of any method of introducing this temperature equilibrium directly, Planck originally sought, in the case of each independent constituent, for a function of its intensity of energy and its wave-length, restricted as to form by a certain assumed molecular relation, which has the property of continually increasing after the manner of entropy, during the progress of that constituent of the radiation in such a system towards its steady state. If the actual entropy S per unit volume could be thus determined, the relation of Clausius $\delta S = \delta E/T$ would supply the connexion between the temperature and the density of radiant energy E . This procedure led him, in an indirect and tentative manner, to a relation $d^2S/dE^2 = -\alpha/E$, so that $S = -\alpha E \log \beta E$, where α, β are functions of λ ; an expression which conducts through Clausius's relation to $E = (\alpha\beta)^{-1}e^{-1/\alpha T}$.

The previous argument then gives $E(\lambda, T)\delta\lambda = c_1\lambda^{-5}e^{-c/\lambda T}\delta\lambda$, a type of formula which was originally suggested by Wien on the basis of the analogy that it assigns the same distribution for the radiant energy, among the various frequencies of vibration, as for the energy of the molecules in a gas among their various velocities of translation. But the experimental inadequacy of this formula afterwards suggested a new procedure, as *infra*.

Processes may be theoretically assigned for the direct continuous transformation of radiant into mechanical energy. Thus we can imagine a radiating body at the centre of a wheel, carrying oblique vanes along its circumference, which reflect the radiation on to a ring of parallel fixed vanes, which finally reverse its path and return it to the centre. The pressure of the radiation will drive the wheel, and in case its motion is not resisted, a very great velocity may be theoretically obtained. The thermodynamic compensation in such cases lies in the reduction of the effective temperature of the portion of the radiation not thus used up. We might even do away with the radiating body at the centre of the wheel, and consider a beam of definite radiation reflected backwards and forwards across a diameter. It is easy to see that its path will remain diametral; the work done by it in driving the wheel will be concomitant with increase of the wave-length, and therefore with expansion of the length occupied by the beam. The thermodynamic features are thus analogous to those of the more familiar case of an envelope filled with gas, which can change its thermal energy into mechanical energy by expansion of the envelope against mechanical resistances. In the case of the expanding gas $p\delta v = \frac{2}{3}E_0\delta v$, where E_0 is the total translatory energy of the molecules, while in adiabatic expansion $p = kv - \gamma$. Thus the work gained in unlimited expansion, $\int p\delta v$, is $\frac{2}{3}E_0(\gamma - 1)$. The final temperature being absolute zero, this should by Carnot's principle be equal to the total initial energy of the gas that is in connexion with temperature, constitutive energy of the molecules being excluded; when $\gamma - 1$ is less than $\frac{2}{3}$ there is thus internal thermal energy in the molecules in addition to the translatory energy. In the case of the beam of radiation, of length l , between n and $n + \delta n$ reflexions, where δn is an integer, its total energy E is by § 2 reduced according to the law $\frac{\delta E}{E} = -\frac{4cv\delta n}{(c+v)^2}$. Also $\frac{\delta l}{l} = \frac{2v\delta n}{c+v}$;

thus $\frac{\delta E}{E} = -\frac{2c}{c+v} \frac{\delta l}{l}$. When v is small compared with c , this gives $E = \kappa l^{-2}$; and p is then $2E/l$, so that $\int p\delta l = E$, the temperature of the beam being ultimately reduced to absolute zero by the unlimited expansion. This is in accord with Carnot's principle, in that the whole energy of the beam travelling in a vacuum is mechanically available when reduction to absolute zero of temperature is in our power.

12. *Experimental Knowledge*.—Under the stimulus of Wien's investigation and of improvements in the construction of linear thermopiles and bolometers for the refined measurement of the distribution of energy along a spectrum, the general character of the curve connecting energy and wave-length in the complete radiation at a given temperature has been experimentally ascertained over a wide range. At each temperature there is a wave-length λ_m of maximum radiation, which is displaced towards the ultra-violet as the temperature rises, and Wien's law of homology (§ 6) shows that $\lambda_m T$ should be constant. This deduction, and the law of homology itself, as also the law of Stefan and Boltzmann that the total radiation varies as T^4 , have been closely verified by the experiments of Rubens and Kurlbaum, Lummer and Pringsheim, Paschen and others. They established a steady field of radiation inside a material enclosure by raising the walls to a definite temperature, and measured the radiant intensity emitted from it through an opening or slit in the walls, by means of a bolometer or thermopile, this being the radiation of the so-called perfectly black body. The principle here involved formed one of the foundations of Balfour Stewart's early treatment of the theory, and had already been employed by him and Stokes (1860) in experiments on the polarized emission from tourmaline: cf. Stokes, *Math. and Phys. Papers*, iv. 136. It has been remarked by Planck and by Thiesen that the coefficient of T^4 in Stefan's law, and the value of $\lambda_m T$, are two absolute physical constants independent of any particular kind of matter, which in conjunction with the constant of gravitation would determine an entirely absolute system of physical units. The form of the function $\phi(T\lambda)$ adopted by Wien and in Planck's earlier discussions, namely, $c_1 e^{-c/\lambda T}$, was found to agree fairly with experiment over the range from 100° C. to 1300° C., when $c_1 = 1.24 \times 10^{-5}$, and $c =$

1.4455 in c.g.s. measure, but not so well when the range is farther extended: it appeared that a larger value of c was needed to represent the radiation for high values of $T\lambda$, that is, for high temperature or for very long wave-lengths. Thiesen proposed the somewhat more general form $c_1(T\lambda)^k e^{-c/\lambda T}$, and suggested that the value $k = \frac{1}{2}$ agrees better with the experimental numbers than Wien's value $k = 0$. Lord Rayleigh was led (*Phil. Mag.*, June 1900) towards this form with k equal to unity from entirely different theoretical considerations, on the assumption of the Maxwell-Boltzmann distribution of the energy of a system, consisting of an isolated block of aether, among its free periods of vibration, infinite in number; in some cases this form appeared to give as good results as Wien's own.

Acting on a suggestion advanced by Lord Rayleigh, Rubens and Kurlbaum soon afterwards widely extended the test of the formulæ by means of the so-called *Reststrahlen*. A substance such as an aniline dye, which exhibits selective absorption of any group of rays, also powerfully reflects those rays; and Rubens has been able thus to isolate in considerable purity the rays belonging to absorption bands very far down in the invisible ultra-red, having wave-length of order 10^{-3} cm., which are intensely absorbed by substances such as sylvine, by means of five or six successive reflexions of the beam of radiation. By experiments ranging between temperatures -200° C. and $+1500^\circ$ C. of the source of radiation, it has been found that the intensity of this definite radiation tends to vary simply as T , with close approximation, thus increasing indefinitely with the temperature, whereas Wien's formula would make it tend to a definite limit. The only existing formula (except the one suggested by Lord Rayleigh) that proved to be in accord with this result was a new one advanced shortly before and supported on theoretical grounds by Planck, namely, $E_\lambda \delta\lambda = C\lambda^{-5}\delta\lambda/(e^{c/\lambda T} - 1)$, which for small values of λT agrees with Wien's original form, known to be there satisfactory, while for larger values it tends towards $C/c \cdot \lambda^{-4} T$; the new formula is, in fact, the simplest and most likely form that satisfies these two conditions. The point of Lord Rayleigh's argument was that, at any rate at low frequencies, the law of distribution would suggest an equitable partition of the energy between temperature heat and radiant vibrations, and that therefore the energy of the latter should ultimately vary as T ; and this prediction, which has thus been verified, may be grafted on to any formula that is in other respects appropriate.

Recognizing that his previous hypothesis, restricting the nature of the entropy in addition to its property of continually increasing, had thus to be abandoned, Planck had in fact made a fresh start on the basis of a train of ideas which was introduced by Boltzmann in 1877, in order to obtain a precise physical conception of entropy. According to the latter, for an indefinitely numerous system of molecules, with known properties and in given circumstances, there is a definite probability of the occurrence of each statistical distribution of velocities, or say each "complexion" of the system, that is formally possible when all velocities consistent with given total energy are considered to be equally likely as regards each molecule; the distribution of greatest possible probability is the state of thermal equilibrium of the system, and the probability of any other state is a function of the entropy of that state. This conception can be developed only in very simple cases; the application to an ideal monatomic gas-system led Boltzmann to take the entropy proportional to the logarithm of the probability. This logarithmic law is in fact demanded in advance by the principle that the entropy of a system should be the sum of the entropies of its parts. By means of a priori considerations of this nature, referring to the distribution of internal vibratory energy among a system of linear electric vibrators of given period, and its equilibrium of exchanges with the surrounding radiant energy, Planck has been guided to an expression for the law of dependence of the entropy of that system on the temperature, which corresponds to the form of the law of radiation above stated. The result gains support from the fact that the expressions for the coefficients to which he is led give determinations of the

absolute physical constants of molecular theory, such as the constant of Avogadro, which are in close accord with other recent determinations. But on the other hand these determinations are already involved in the earlier formula of Rayleigh, which expresses the distribution for long waves, based merely on the Maxwell-Boltzmann principle of the equal partition of the energy among the high free periods belonging to the enclosure which contains it. It is maintained by Jeans that the reason why this principle is of avail only for very long wave-lengths is that a steady state is never reached for the shorter ones, a doctrine which as he admits would entirely remove the foundations of the application of thermodynamic principles to this subject. By an argument based on the theory of dimensions, Lorentz has been led to the conclusion that consistency between temperatures, as measured molecularly, and as measured by the laws of radiation, requires that the ultimate indivisible electric charges or electrons must be the same in all kinds of matter.

The abstract statistical theory of entropy, which is here invoked, admits of generalization in a way which is a modification of that of Planck, itself essentially different from the earlier idea of Boltzmann. The molecules of matter, whose interactions control physical phenomena, including radiation, are too numerous to be attended to separately in our knowledge. They, and the phenomena in which they interact, must thus be sorted out into differential groups or classes. Elements of energy of specified types might at first sight constitute such classes; but the identity of a portion of energy cannot be traced during its transformations, while an element of physical disturbance can be definitely followed, though its energy changes by interaction with other elements as it proceeds. The whole disturbance may thus be divided into classes, or groups of similar elements, each with permanent existence; and these may be considered as distributed in series of cells, all equivalent in extent, which constitute and map out the material system or other domain of the phenomena. The test of this equivalence of extent is superposition, in the sense that the same element of disturbance always occupies during its wanderings the same number of cells. This framework being granted, the probability of any assigned statistical distribution of the elements of disturbance now admits of calculation; and it represents, as above, the logarithm of the entropy of that distribution, multiplied however by a coefficient which must depend on the minuteness of scale of the statistics. But in the calculation, all the physical laws which impose restrictions on the migrations of the elements of disturbance must be taken into account; it is only after this is done that the rest of the circumstances can be treated as fortuitous. All these physical laws are, however, required and used up in determining the complex of equivalent cells into which the system which forms the seat of the energy is mapped out. On this basis thermodynamics can be constructed in a priori abstract fashion, and with deeper and more complete implications than the formal Carnot principle of negation of perpetual motions can by itself attain to. But the ratio of the magnitude of the standard element of disturbance to the extent of the standard cell remains inherent in the results, appearing as an absolute physical constant whose value is determined somehow by the other fundamental physical constants of nature. A prescribed ratio of this kind is, however, a different thing from the hypothesis that energy is constituted atomically, which underlies, as Lorentz pointed out, Planck's form of the theory. It has indeed already been remarked that the mere fact of the existence of a wave-length λ_m of maximum radiation, whether obeying Wien's law $\lambda_m T = \text{constant}$ or not, implies by itself some prescribed absolute physical quantity of this kind, whose existence thus cannot be evaded, though we may be at a loss to specify its nature.

13. *Modification by a Magnetic Field.*—The theory of exchanges of radiation, which makes the equilibrium of radiating bodies depend on temperature alone, requires that, when an element of surface of one body is radiating to an element of surface of another body at the same temperature, the amounts of energy interchanged (when reflexion is counted in along with

radiation) should be equal. This proposition is a general dynamical consequence—on the basis of the laws of reciprocity developed in this connexion (after W. Rowan Hamilton) mainly by Helmholtz, Kirchhoff, and Rayleigh—of the form of the equations of propagation of vibrations in the medium. But in a material medium under the influence of a strong magnetic field these equations are altered by the addition of extraneous terms involving differential coefficients of the third order, and the dynamical consistency of the cardinal principle of the theory of exchanges is no longer thus directly verified. A system of this kind has, in fact, been imagined by Wien in which the principle is imperfectly fulfilled. A beam coming from a body A, and polarized by passage through a nicol, may have its plane of vibration rotated through half a right angle by crossing a magnetically active plate, and may then pass through another nicol, properly orientated for transmission, so as finally to fall on another body B. On the other hand, the radiation from B which gets through this adjacent nicol will have its plane of vibration rotated through another half right angle by the magnetically active plate, and so will not get through the first nicol to the body A. Such possibilities of unequal exchange of radiation between A and B are the result of the want of reversibility of the radiation in the extraneous magnetic field, which might have been expected to lead to proportionate inequalities of concentration; in this example, however, though the defect of reversibility is itself slight, its results appear at first sight to prevent any equilibrium at all. But a closer examination removes this discrepancy. In order to make the system self-contained, reflectors must be added to it, so as to send back into the sources the polarized constituents that are turned aside out of the direct line by the nicols. Then, as Brillouin has pointed out, and as in fact Rayleigh had explained some years before, the radiation from B does ultimately get across to A after passage backward and forward to the reflectors and between the nicols: this, it is true, increases the length of its path, and therefore diminishes the concentration of a single narrow beam, but any large change of path would make the beam too wide for the nicols, and thus require other corrections which may be supposed to compensate. The explanation of the slight difference that is to be anticipated on theoretical grounds might conceivably be that in such a case the magnetic influence, being operative on the phases, alters the statistical constitution of the radiation of given wave-length from the special type that is in equilibrium with a definite temperature, so that after passage through the magnetic medium it is not in a condition to be entirely absorbed at that temperature; there would then be some other element, in addition to temperature, involved in equilibrium in a magnetic field. If this is not so, there must be some thermodynamic compensation involving reaction, extremely small, however, on the magnetizing system.

14. *Origin of Spectra.*—In addition to the thermal radiations of material substances, those, namely, which establish temperature-equilibrium of the enclosure in which they are confined, there are the fluorescent and other radiations excited by extraneous causes, radiant or electric or chemical. Such radiations are an indication, by the presence of higher wave-lengths than belong in any sensible degree to the temperature, that the steady state has not arrived; they thus fade away, either immediately on the cessation of the exciting cause, or after an interval. The radiations, consisting of definite narrow bright bands in the spectrum, that are characteristic of the gaseous state in which each molecule can vibrate freely by itself, are usually excited by electric or chemical agency; thus there is no ground for assuming that they always constitute true temperature radiation. The absorption of these radiations by strata of the same gases at low temperatures seems to prove that the unaltered molecules themselves possess these free periods, which do not, therefore, belong specially to dissociated ions. Although very difficult to excite directly, these free vibrations are then excited and absorb the energy of the incident waves, under the influence of resonance, which naturally becomes extremely powerful when the tuning is exact; this

indicates, moreover, that the true absorption bands in a gas of sufficiently low density must be extremely narrow. There is direct evidence that many of the more permanent gases do not sensibly emit light on being subjected to high temperature alone, when chemical action is excluded, while others give in these circumstances feeble continuous spectra; in fact, looking at the matter from the other side, the more permanent gases are very transparent to most kinds of radiation, and therefore must be very bad radiators as regards those kinds. The dark radiation of flames has been identified with that belonging to the specific radiation of their gaseous products of combustion. There is thus ground for the view that the impacts of the colliding molecules in a gas, or rather their mutual actions as they swing sharply round each other in their orbits during an encounter, may not be sufficiently violent to excite sensibly the free vibrations of the definite periods belonging to the molecules. But they may produce radiation in other ways. While the velocity of an electron or other electric charge is being altered, it necessarily sends out a stream of radiation. Now the orbital motions of the electrons in an actual molecule must be so adjusted, as appears to be theoretically possible, that it does not emit radiation when in a steady state and moving with constant velocity. But in the violent changes of velocity that occur during an encounter this equipose will be disturbed, and a stream of radiation, without definite periods, but such as might constitute its share of the equilibrium thermal radiation of the substance, may be expected while the encounter lasts. At very high temperatures the energy of this thermal radiation in an enclosure entirely overpowers the kinetic energy of the molecules present, for the former varies as T^4 , while the latter measures T itself when the number of molecules remains the same. The radiation which can be excited in gases, confined as it is to extremely narrow bands in the spectrum, may indeed be expected to possess such intensity as to be thermally in equilibrium with extremely high temperatures. That the same gases absorb such radiations when comparatively cold and dark does not, of course, affect the case, because emissive and absorptive powers are proportional only for incident radiations of the intensity and type corresponding to the temperature of the body. Thus if our adiabatic enclosure of § 3 is prolonged into a tube of unlimited length which is filled with the gas, then when the temperature has become uniform that gas must send back out of the tube as much radiation as has passed down the tube and been absorbed by it; but if the tube is maintained at a lower temperature, it may return much less. The fact that it is now possible by great optical dispersion to make the line-spectra of prominences in the middle of the Sun's disk stand out bright against the background of the continuous solar spectrum, shows that the intensities of the radiations of these prominences correspond to a much higher temperature than that of the general radiating layer underneath them; their luminosity would thus seem to be due to some cause (electric or chemical) other than mere temperature. On the other hand, the general reversing gaseous layer which originates the dark Fraunhofer lines is at a lower temperature than the radiating layer; it is only when the light from the lower layers is eclipsed that its own direct bright-line spectrum flashes out. It is not necessary to attribute this selective flash-spectrum to temperature radiation; it can very well be ascribed to fluorescence stimulated by the intense illumination from beneath. When the radiation in a spectrum is constituted of wide bands it may on these principles be expected to be in equilibrium with a lower temperature than when it is constituted of narrow lines, if the total intensity is the same in the cases compared; this is in keeping with the easier excitation of band spectra (cf. the banded absorption spectra), and with the fact that various gases and vapours do appear to emit band spectra more or less related to the temperature.

15. *Constitution of Spectra.*—In the problem of the unravelling of the constitutions of the very complex systems of spectral lines belonging to the various kinds of matter, considerable

progress has been made in recent years. The beginning of definite knowledge was the discovery of Balmer in 1885, that the frequencies of vibration (n) of the hydrogen lines could be represented, very closely and within the limits of error of observation, by the formula $n \propto 1 - 4m^{-2}$, when for m is substituted the series of natural numbers 3, 4, 5, . . . 15. Soon afterwards series of related lines were picked out from the spectra of other elements by Liveing and Dewar. Rydberg conducted a systematic investigation on the basis of a modification of Balmer's law for hydrogen, namely, $n = n_0 - N/(m + \mu)^2$. He found that in the group of alkaline metals three series of lines exist, the so-called principal and two subordinate series, whose frequencies fit approximately into this formula, and that similar statements apply to other natural groups of elements; that the constant N is sensibly the same for all series and all substances, while n_0 and μ have different values for each; and that other approximate numerical relations exist. In each series the lines of high frequency crowd together towards a definite limit on the more refrangible side; near this limit they would, if visible, constitute a band. The principal or strongest series of lines shows reversal very readily. The lines of the first subordinate series are usually nebular, while those of the second subordinate or weakest series are sharp; but with a tendency to broaden towards the less refrangible side. In most series there are, however, not more than six lines visible: helium and hydrogen are exceptions, no fewer than thirty lines of the principal series of the latter having been identified, the higher ones in stellar spectra only. But very remarkable progress has recently been made by R. W. Wood, by exciting fluorescent spectra in a metallic vapour, and also by applying a magnetic field to restore the lines sensitive to the Zeeman effect after the spectrum has been cut off by crossed nicols. The large aggregates of lines thus definitely revealed are also resolved by him into systems in other ways; when the stimulating light is confined to one period, say a single bright line of another substance, the spectrum excited consists of a limited number of lines equidistant in frequency, the interval common to all being presumably the frequency of some intrinsic orbital motion of the molecule. In this way the series belonging to some of the alkali metals have been obtained nearly complete.

Simultaneously with Rydberg, the problem of series was attacked by Kayser and Runge, who, in reducing their extensive standard observations, used the formula $n = A + Bm^{-2} + Cm^{-4}$, higher terms in this descending series being presumed to be negligible. This cannot be reconciled with Rydberg's form, which gives on expansion terms involving m^{-8} ; but for the higher values of m the discrepancies rapidly diminish, and do not prevent the picking out of the lines, the frequency-differences between successive lines then varying roughly as the inverse squares of the series of natural numbers. For low values of m neither mode of expression is applicable, as was to be expected; and it remains a problem for the future to ascertain if possible the rational formula to which they are approximations. More complex formulas have been suggested by Ritz and others, partly on theoretical grounds.

Considered dynamically, the question is that of the determination of the formula for the disturbed motions of the system which constitutes the molecule. Although we are still far from any definite line of attack, there are various indications that the quest is a practicable one. The lines of each series, sorted out by aid of the formulae above given, have properties in common: they are usually multiple lines, either all doublets in the case of monad elements, or generally triplets in the case of those of higher chemical valency; in very few cases are the series constituted of single lines. It is found also that the components of all the double or triple lines of a subordinate series are equidistant as regards frequency. In the case of a related group of elements, for example the alkaline metals, it appears that corresponding series are displaced continually towards the less refrangible end as the atomic weight rises; it is found also that the interval in frequency between the double

lines of a series diminishes with the atomic weight, and is proportional to its square. These relations suggest that the atomic weight might here act in part after the manner of a load attached to a fundamental vibrating system, which might conceivably be formed on the same plan for all the metals of the group; such a load would depress all the periods, and at the same time it would split them up in the manner above described, if it introduced dissymmetry into the vibrator. The discovery of Zeeman that a magnetic field triples each spectral line, and produces definite polarizations of the three components, in many cases further subdividing each component into lines placed usually all at equal intervals of frequency, is explained, and was in part predicted, by Lorentz on the basis of the electron theory, which finds the origin of radiation in a system of unitary electric charges describing orbits or executing vibrations in the molecule. Although these facts form substantial sign-posts, it has not yet been found possible to assign any likely structure to a vibrating system which would lead to a frequency formula for its free periods of the types given above. Indeed, the view is open that the group of lines constituting a series form a harmonic analysis of a single fundamental vibration not itself harmonic. If that be so, the intensities and other properties of the lines of a series ought all to vary together; it has in fact been found by Preston, and more fully verified by Runge and others, that the lines are multiplied into the same number of constituents in a magnetic field, with intervals in frequency that are the same for all of them. When the series consists of double or triple lines the separate components of the same compound line are not affected similarly, which shows that they are differently constituted. The view has also found support that the different behaviours of the various groups of lines in a spectrum show that they belong to independent vibrators. The form of the vibration sent out from a molecule into the aether depends on the form of the aggregate hodograph of the electronic orbits, which is in keeping with Rayleigh's remark that the series-laws suggest the kinematic relations of revolving bodies rather than the vibrations of steady dynamical systems.

According to Rydberg, there is ground for the view that a natural group of chemical elements have all the same type of series spectrum, and that the various constants associated with this spectrum change rapidly in the same directions in passing from the elements of one group to the corresponding ones of the following groups, after the manner illustrated in graphical representations of Mendeléeff's law by means of a continuous wavy curve in which each group of elements lies along this same ascending or descending branch; the chemical elements thus being built up in a series of types or groups, so that the individuals in successive groups correspond one to one in a regular progression, which may be put in evidence by connecting them by transverse curves. Illustrations have been worked out mathematically by J. J. Thomson of the effect of adding successive outer rings of electrons to stable vibrating collocations.

The frequencies of the series of very close lines which constitute a single band in a banded spectrum are connected by a law of quite different type, namely, in the simpler cases $n^2 = A - Bm^2$. It may be remarked that this is the kind of relation that would apply to a row of independent similar vibrators in which the neighbours exert slight mutual influence of elastic type. If ξ denote displacement and x distance along the row,

the equation $\frac{d^2\xi}{dt^2} + k^2\xi = -g\frac{d^2\xi}{dx^2}$ would represent the general fea-

tures of their vibration, the right-hand side arising from the mutual elastic influences. If the ends of the line of vibrators, of length l , are fixed, or if the vibrators form a ring, the appropriate type of solution is $\xi \propto \sin \mu x \sin pt$, where $\mu l = m\pi$ and m is integral; further $-p^2 + k^2 = g\mu^2$, hence $p^2 = k^2 - \frac{g\pi^2}{l^2} m^2$, which is of

the type above stated. Dynamical systems of this kind are illustrated by the Lagrangean linear system of connected bodies,

such as, for example, a row of masses fixed along a tense cord, and each subject to a restoring elastic force of its own in addition to the tension of the cord. A single spectral line might thus be transformed into a band of this type, as the effect of disturbance arising from slight elastic connexions established in the molecule between a system of similar vibrators. But the series in line-spectra are of entirely different constitution; thus for the series expressed by the formula $p^2 = p_0^2 - Bm^{-2}$ the corresponding period-equation might be expressed in some such form as $\sin k(p^2 - p_0^2)^{-\frac{1}{2}} = \text{constant}$, which belongs to no type of vibrator hitherto analysed.

AUTHORITIES.—The experimental memoirs on the constitution of radiation are mostly in the *Annalen der Physik*; references are given by P. Drude, *Lehrbuch der Optik*, Leipzig, 1900; cf. also reports in the collection issued by the International Congress of Physics, Paris, 1900. See also Lord Rayleigh's *Scientific Papers*, in various connexions; and Larmor, in *Brit. Assoc. Reports*, 1900–1902, also the Bakerian Lecture, *Roy. Soc. Proc.*, 1909, for a general discussion of molecular statistical theory in this connexion. Planck's *Theorie der Wärmestrahlung*, 1906, gives a discussion from his point of view; there is a summary by Wien in *Ency. Math. Wiss.* v. (3) pp. 282–357; also a lecture of H. A. Lorentz to the Math. Congress at Rome, 1908, and papers by J. H. Jeans, *Phil. Mag.*, 1909, on the partition of energy. In spectrum analysis Kayser's extensive treatise is the standard authority. Winkelmann's *Handbuch der Physik*, vol. ii. (by Kayser, Drude, &c.), may also be consulted. (J. L. *)

RADICAL (Lat. *radix*, a root), in English politics, a term applied to politicians who desire to make *thorough*, or *radical*, changes in the constitution and in the social order generally. Although it had been used in a somewhat similar way during the reign of Charles II., the term Radical, in its political sense, originated about the end of the 18th century, probably owing its existence to Charles James Fox, who, in 1797, declared that "radical reform" was necessary. The ideas of the first Radicals were borrowed largely from the authors of the French Revolution. The word was more generally employed during the disturbed period between the close of the Napoleonic wars and the passing of the great Reform Bill of 1832, and was applied to agitators like Henry Hunt and William Cobbett. After the Reform Bill had become law, the advocates of violent change were drawn into the Chartist movement, and the Radicals became less revolutionary both in speech and object. Thus in 1842 an observer writes:—"The term Radical, once employed as a name of low reproach, has found its way into high places, and is gone forth as the title of a class who glory in their designation." About this time many members of Parliament were known as Radicals, among these men being George Grote and Joseph Hume. The Radicals never formed a distinct party in the House of Commons, and subsequently they formed simply the advanced section of the Liberal party. For a few years in the 19th century the wearing of a white hat was looked upon as the distinguishing mark of a Radical, a hat of this colour having been worn by Hunt when addressing meetings.

See W. Harris, *History of the Radical Party in Parliament* (1885); S. Bamford, *Passages in the Life of a Radical* (new ed., 1893); C. B. Roylance Kent, *The English Radicals: an Historical Sketch* (1899).

RADIOACTIVITY. The subject of radioactivity deals with phenomena exhibited by a special class of bodies of high atomic weight of which uranium, thorium, radium and actinium are the best known examples. These substances possess the property of spontaneously emitting radiations of a special character which are able to penetrate through matter opaque to ordinary light. The beginning of this subject dates from 1896, and was an indirect consequence of the discovery of the X rays made a few months before by Röntgen. It was known that the production of X rays in a vacuum tube was accompanied by a strong phosphorescence of the glass, and it occurred to several investigators that ordinary substances made phosphorescent by visible light might emit a penetrating radiation similar to X rays. Following out this idea, H. Becquerel (1),¹ a distinguished French physicist, exposed amongst other substances a phosphorescent compound of uranium, uranium-

¹ These numbers refer to papers noted under *References* (below).

potassium sulphate, enveloped in paper beneath a photographic plate. A weak photographic effect was obtained. This was shown to be due to a penetrating radiation capable of passing through sheets of matter opaque to ordinary light. Further investigation showed that this photographic action was exhibited by all compounds of uranium and by the metal itself, and had nothing to do with phosphorescence. It was shown equally if the uranium were kept in darkness and did not vary appreciably with time. Becquerel showed that the rays from uranium like X rays were capable of discharging a body whether positively or negatively electrified. A uranium compound brought close to the charged plate of a gold leaf electroscope causes a rapid collapse of the gold leaves. This property of uranium, and also of the radioactive bodies in general, has supplied a delicate and quantitative method of accurate comparison of the intensity of the radiations from substances under varying conditions. A modified form of gold leaf electroscope has come into general use for comparison of the radioactivity of substances. Rutherford (2) made a systematic examination of the discharging effect produced by the rays from uranium and showed that it was due to the production of charged carriers or ions in the volume of the gas through which the radiations pass. In an electric field, the positive ions travel to the negative electrode and vice versa,

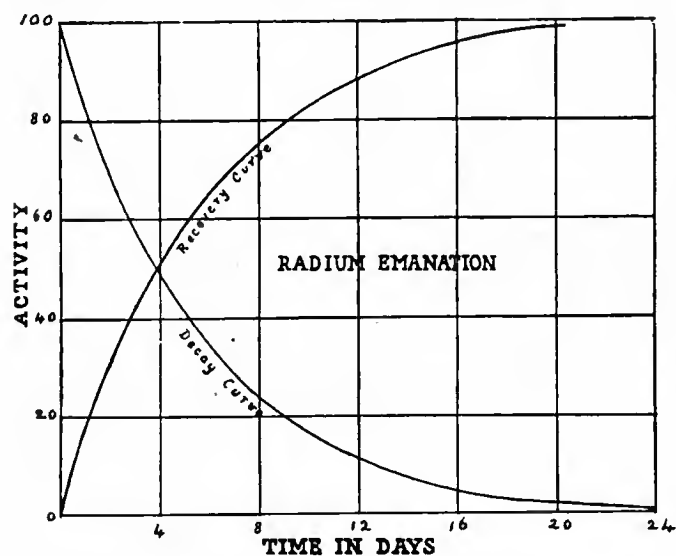

thus causing a discharge of the electrified body. If a sufficiently strong field is used, the ions are all swept to the electrodes before appreciable loss of their number can occur by recombination. The rate of discharge then reaches a steady maximum value which is not altered by a large increase in voltage. This maximum current through the gas is called the saturation current. The ions produced in gases by the rays from uranium and other radioactive substances are in general identical with those produced by X rays, and the mechanism of conductivity of the gas is very similar in both cases (see CONDUCTION, ELECTRIC: § *Through Gases*).

Some time after Becquerel's discovery, Mme Curie (3) made a systematic examination of the electric method of a large number of chemical elements and their compounds to test whether they possessed the "radioactive" property of uranium. Only one other element, thorium, was found to show this effect to a degree comparable with that of uranium—a result independently observed by Schmidt. Mme Curie examined the activity of the various compounds of uranium and found that their radioactivity was an atomic property, *i.e.* the activity was proportional to the amount of the element uranium present, and was independent of its combination with other substances. In testing the activity of the minerals containing uranium, Mme Curie found that the activity was always four to five times as great as that to be expected from their content

of uranium. If the radioactivity were an atomic phenomenon, this could only be explained by the presence in these minerals of another substance more active than uranium itself. Relying on this hypothesis, Mme Curie made a chemical examination of uranium minerals in order to try to separate this new radioactive substance. In these experiments, the Austrian Government generously provided Mme Curie with a ton of the residues from the State manufactory of uranium at Joachimstahl, Bohemia. At that place there are extensive deposits of pitchblende or uranite which are mined for the uranium. After separation of the latter, the residues are three to five times as radioactive weight for weight as the uranium. From this residue Mme Curie separated a substance far more radioactive than uranium, which she called polonium in honour of the country of her birth. This substance is usually separated with bismuth in the mineral, but by special methods can be partly separated from it. A further examination revealed the presence of a second radioactive substance which is normally separated with the barium, to which the name "radium" was given. This name was happily chosen, for in the pure state radium bromide has a very great activity—about two million times as great as an equal weight of uranium. By means of successive fractionations of the chloride, the radium was gradually concentrated, until finally the radium was obtained so that the barium lines showed very faintly. The atomic weight was found by Mme Curie to be 225. In a recent redetermination, using a larger quantity of 0.4 grams of pure radium chloride, Mme Curie (4) found the atomic weight to be 226.2. Thorpe (5) using a smaller quantity obtained a value 227. The spectrum of the purified sample of radium chloride obtained by Mme Curie was first examined by Demarcay. It was found to have a characteristic spark spectrum of bright lines analogous in many respects to the spectra of the alkaline earths. Giesel (6) found that pure radium bromide gives a brilliant carmine colour to the bunsen flame. The flame spectrum shows two broad bright bands in the orange-red. There is also a line in the blue-green and two weak lines in the violet. Giesel (7) has taken an active part in the preparation of pure radium compounds, and was the first to place preparations of pure radium bromide on the market. He found that the separation of radium from the barium mixed with it proceeded much more rapidly if the crystallizations were carried out using the bromide instead of the chloride. He states that six to eight crystallizations are sufficient for an almost complete separation. From the chemical point of view radium possesses all the characteristic properties of a new element. It has a definite atomic weight, a well-marked and characteristic spectrum, and distinct chemical properties. Its comparative ease of separation and great activity, has attracted much attention to this substance, although we shall see that very similar radioactive properties are possessed by a large number of distinct substances.

Radium emits three distinct types of radiation, known as the α , β and γ rays, of which an account will be given later. It produces in addition a radioactive emanation or gas which is about 100,000 times as active weight for weight as radium itself. The emanation released from 10 milligrams of pure radium bromide causes a glass tube into which it is introduced to phosphoresce brightly. A brilliant luminosity is produced in phosphorescent substances like zinc sulphide, willemite and barium platino-cyanide when introduced into a tube containing the emanation. The radium emanation, a more detailed account of which will be given later, has proved of the greatest utility in radioactive experiments. The property of radium of producing the emanation has been utilized as a very delicate and certain method, not only of detection but of estimation of small quantities of radium. This "emanation method" depends upon the introduction of the emanation, liberated from a substance by boiling or heating, into a suitable electroscope. The rate of discharge of the electroscope due to the emanation affords a quantitative measure of the amount of radium present. In this way, it is not difficult to determine with certainty the

presence of radium in a body which contains only 10^{-11} gram of radium. With care, 10^{-12} gram can just be detected. This emanation method has been employed with great success in measuring the quantity of radium in minerals and in rocks. A very simple method has been devised of determining the quantity of radium present when it is not less than 1/100 milligram. The tube containing the radium is placed some distance from an electroscope which is surrounded by a lead screen about 3 mms. thick. This cuts off the α and β rays and the effect in the electroscope is then due to the penetrating γ rays. By comparison of the rate of discharge with that of a standard preparation of radium at the same distance, the quantity of radium can at once be deduced, provided the radium is in equilibrium with its emanation. This is usually the case if the radium preparation is one month old. This method is simple and direct, and has the great advantage that the radium tube under test need not be opened, nor its contents weighed. We shall see later that the amount of radium in an old mineral is always proportional to the amount of uranium present. Rutherford and Boltwood (8) found that 3.4 parts of radium by weight are present in ten million parts of uranium. Consequently an old mineral containing 1000 kilos of uranium should contain 340 milligrams of pure radium.

In addition to radium and polonium, a number of other radioactive substances have been found in uranium minerals. With the exception of the radium emanation, none of these have yet been isolated in a pure state, although preparations of some of them have been obtained comparable in activity with radium itself. Debierne (9) found a radioactive substance which was separated from pitchblende with the rare earths and had chemical properties similar to those of thorium. This he called *actinium*. Giesel (10) independently noted the presence of a new radioactive substance which was usually separated with lanthanum and cerium from the minerals. It possessed the property of giving out a radioactive emanation or gas, the activity of which died away in a few seconds. For this reason he called it the *emanating substance* and afterwards *emanium*. Later work has shown that emanium is identical in chemical and radioactive properties with actinium, so that the former name will be retained.

We have already seen that Mme Curie gave the name polonium to a radioactive substance separated with bismuth. Later Marckwald found that a very radioactive substance was deposited from a solution of a radioactive mineral on a polished bismuth plate. The active matter was found to be deposited in the bismuth with tellurium, and he gave the name *radio-tellurium* to this substance. In later work, he showed that the new substance could be chemically separated from tellurium. By treating the residues from 15 tons of Joachimsthal pitchblende, Marckwald (11) finally obtained 3 milligrams of intensely active material—far more active weight for weight than radium. It has been definitely settled that the active substance of Marckwald is identical with polonium. Both substances give out a type of easily absorbed α rays and both lose their activity at the same rate. The activity of polonium decays in a geometrical progression with the time and falls to half its initial value in 140 days. This law of decay, as we shall see, is characteristic of all radioactive products, although the period of decay is different in each case.

Mme Curie and Debierne (12) have described further experiments with polonium. The latter substance was extracted from several tons of pitchblende and purified until 2 milligrams of material were obtained containing about 1/10 milligram of pure polonium. From a knowledge of the relative periods of transformation of radium and polonium, it can be calculated that the amount of polonium in a radium mineral is 1/5000 of the amount of radium, while the activity of pure polonium measured by the α rays should be 5000 times greater than that of radium. As we have seen, polonium is rapidly transformed, and it is of great interest to determine the nature of the substance into which polonium changes. We shall see later that there is considerable evidence that polonium changes into lead.

Recently Boltwood (13) has separated another substance from uranium minerals which he has called "ionium." This substance is sometimes separated from the mineral with actinium and has chemical properties very similar to those of thorium. Preparations of ionium have been obtained several thousand times as active as uranium. Ionium emits α rays of short range and has a period of transformation probably much longer than that of radium. Ionium has a special interest inasmuch as it is the substance which changes directly into radium. A preparation of ionium initially free from radium grows radium at a rapid rate. Hofmann found that the lead separated from uranium minerals and named it radiollead. The active constituent in the lead is radium D, which changes into radium E and then into radium F (polonium). Both radium D and radium F are products of the transformation of radium. In addition to these radioactive substances mentioned above, a large number of other radioactive substances have been discovered. Most of these lose their activity in the course of a few hours or days. The properties of these substances and their position in the radioactive series will be discussed later.

Radiations from Radioactive Substances.—All the radioactive substances possess in common the property of emitting radiations which darken a photographic plate and cause a discharge of electrified bodies. Very active preparations of radium, actinium and polonium also possess the property of causing strong phosphorescence in some substances. Bodies which phosphoresce under X rays usually do so under the rays from radioactive matter. Barium platinocyanide, the mineral willemite (zinc silicate) and zinc sulphide are the best known examples.

There are in general three types of radiation emitted by the radioactive bodies, called the α , β and γ rays. Rutherford (2) in 1899 showed that the radiation from uranium was complex and consisted of (a) an easily absorbed radiation stopped by a sheet of paper or a few centimetres of air which he called the α rays and (b) a far more penetrating radiation capable of passing through several millimetres of aluminium, called the β rays. Later Villard found that radium emitted a very penetrating kind of radiation called the γ rays capable of passing before absorption through twenty centimetres of iron and several centimetres of lead.

Giesel and, later, Curie and Becquerel showed that the β rays of radium were deflected by a magnetic field. By the work of Becquerel and Kaufmann the β rays have been shown to consist of negatively charged particles projected with a velocity approaching that of light, and having the same small mass as the electrons set free in a vacuum tube. In fact the β rays are electrons spontaneously ejected from the radioactive matter at a speed on an average much greater than that observed in the electrons set free in a vacuum tube.

The very penetrating γ rays are not deflected in a magnetic or electric field and are believed to be a type of radiation similar to X rays. The γ rays are only observed in radioactive substances which emit β rays, and the penetrating power of the γ rays appears to be connected with the initial velocity of expulsion of the β rays. Two general theories have been advanced to account for the properties of these rays. On one view, the γ rays are to be regarded as electromagnetic pulses which have their origin in the expulsion of the β particle from the atom. On the other hand Bragg has collected evidence in support of the view that the γ rays are corpuscular and consist of uncharged particles or "neutral doublets." There is as yet no general consensus of opinion as to the true nature of the γ rays.

Rutherford (14) showed in 1903 that the α rays were deflected in a powerful magnetic or electric field. The amount of deflection is very small compared with the β rays under similar conditions. The direction of deflection in a magnetic field is opposite to that of the β rays, showing that the α rays consist of a stream of positively charged particles. A pencil of rays from a thick layer of radioactive matter is complex and consists of particles moving at varying velocities. If, however,

a thin film of radioactive matter of one kind is taken, the particles which escape without absorption are found to be homogeneous and consist of particles projected at an identical speed. Observations of the velocity and mass of the particle have been made by Rutherford. The general method employed for this purpose is similar to that used for the determination of the velocity and mass of the electron in a vacuum tube. The deflection of a pencil of rays in a vacuum is determined for both a magnetic and electric field. From these observations the velocity and value e/m (the ratio of the charge carried by the particle to its mass) are determined. The value of e/m has been found to be the same for the particles from all the types of radioactive matter that have been examined, indicating that the α particles from all radioactive substances are identical in mass. The value of e/m found for the α particle is 5.07×10^3 . Now the value of e/m for the hydrogen atom set free in the electrolysis of water is 9660. On the assumption that the value of the charge e is the same for the α particle as for the hydrogen atom, the value would indicate that the α particle has about twice the mass of the hydrogen atom, *i.e.* has the same mass as the hydrogen molecule. If the charge on the α particle is twice that on the hydrogen atom, the value of e/m indicates that the α particle is a helium atom, for the latter has an atomic weight of four times that of hydrogen. It was difficult at first to decide between these and other hypotheses, but we shall show later that there is now no doubt that the α particle is in reality a helium atom carrying two elementary charges. We may consequently regard the α rays as a stream of helium atoms which are projected from a radioactive substance with a high velocity. The maximum velocity of the α particle from radium is 2×10^9 cms. per second, or one-fifteenth of the velocity of light. Although the α rays are the least penetrating of the radiations, it will be seen that they play an extremely important part in radioactive phenomena. They are responsible for the greater part of the ionization and heating effects of radioactive matter and are closely connected with the transformations occurring in them.

Under ordinary experimental conditions the greater part of the ionization observed in a gas is due to the α particles. This ionization due to the α rays does not extend in air at atmospheric pressure for more than 7 cms. from radium, and 8.6 cms. from thorium. If a screen of aluminium about 0.1 cms. thick is placed over the active material, the α rays are completely absorbed, and the ionization above the screen is then due to the β and γ rays alone. If a layer of lead about 2 mms. thick is placed over the active material, the β rays are stopped, and the ionization is then due almost entirely to the penetrating γ rays. By the use of screens of suitable thickness we are thus able to sift out the various types of rays. These three types of radiations all set up secondary radiations in passing through matter. A pencil of β rays falling on matter is widely scattered in all directions. This scattered radiation is sometimes called the secondary β rays. The γ rays give rise to secondary rays which consist in part of scattered γ rays and in part electrons moving with a high velocity. These secondary rays in turn produce tertiary rays and so on. The impact of the α rays on matter sets free a number of slow moving electrons which are very easily deflected by a magnetic or electric field. This type of radiation was first observed by J. J. Thomson, and has been called by him the δ rays.

Emanations or Radioactive Gases.—In addition to their power of emitting penetrating radiations, the substances thorium, actinium and radium possess another very striking and important property. Rutherford (15) in 1900 showed that thorium compounds (especially the oxide) continuously emitted a radioactive emanation or gas. This emanation can be carried away by a current of air and its properties tested apart from the substance which produces it. A little later Dorn showed that radium possesses a similar property, while Giesel and Debierne observed a similar effect with actinium. These emanations all possess the property of ionizing a gas and, if sufficiently intense, of producing marked photographic and

phosphorescent action. The activity of the radioactive gases is not permanent but disappears according to a definite law with the time, *viz.* the activity falls off in a geometric progression with the time. The emanations are distinguished by the different rates at which they lose their activity. The emanation of actinium is very shortlived, the time for the activity to fall to half value, *i.e.* the period of the emanation, being 3.7 seconds. The period of the thorium emanation is 54 seconds and of the radium emanation 3.9 days. This property of emitting an emanation is shown in a very striking manner by actinium. A compound of actinium is wrapped in a sheet of thin paper and laid on a screen of phosphorescent zinc sulphide. In a dark room the phosphorescence, marked by the characteristic scintillation, is seen to extend on all sides from the active body. A puff of air is seen to remove the emanation and with it the greater part of the phosphorescence. Fresh emanation immediately diffuses out and the experiment may be repeated indefinitely. The emanations have all the properties of radioactive gases. They can be transferred from point to point by currents of air. The emanations can be separated from the air or other gas with which they are mixed by the action of extreme cold. Rutherford and Soddy (16) showed that under ordinary conditions the temperature of condensation of the radium emanation mixed was -150°C .

The emanations are produced from the parent matter and escape into the air under some conditions. Rutherford and Soddy (17) made a systematic examination of the emanating power of thorium compounds under different conditions. The hydroxide emanates most freely, while in thorium nitrate, practically none of the emanation escapes into the air. Most of the compounds of actinium emanate very freely. Radium compounds, except in very thin films, retain most of the emanation in the compound. The occluded emanation can in all cases be released by solution or by heating. On account of its very slow period of decay, the emanation of radium can be collected like a gas and stored, when it retains its characteristic properties for a month or more.

Induced Activity.—Curie (18) showed that radium possessed another remarkable property. The surface of any body placed near radium, or still better, immersed in the emanation from it, acquires a new property. The surface after removal is found to be strongly active. Like the emanations, this induced activity in a body decays with the time, though at quite a different rate from the emanation itself. Rutherford (19) independently showed that thorium possessed a like property. He showed that the bodies made active behaved as if a thin film of intensely active matter were deposited on their surface. The active matter could be partly removed by rubbing, and could be dissolved off by strong acids. When the acid was evaporated the active matter remained behind. It was shown that induced activity was due to the emanations, and could not be produced if no emanation was present. We shall see that induced activity on bodies is due to a deposit of non-gaseous matter derived from the transformation of the emanations. Each emanation gives a distinctive active deposit which decays at different rates. The active deposits of radium, thorium and actinium are very complex, and consist of several types of matter. Several hours after removal from the emanation the active deposit from radium decays to half-value—26 minutes, for actinium half-value—34 minutes, for thorium half-value—10.5 hours. The active deposits obtained on a platinum wire or plate are volatilized before a white heat, and are again deposited on the cooler bodies in the neighbourhood. Rutherford showed that the induced activity could be concentrated on the negative electrode in a strong electric field, indicating that the radioactive carriers had a positive charge. The distribution of the active deposit in a gas at low pressure has been investigated in detail by Makower and Russ.

Theory of Radioactive Transformations.—We have seen that the radioactive bodies spontaneously and continuously emit a great number of α and β particles. In addition, new types of radioactive matter like the emanations and active deposits

appear, and these are quite distinct in chemical and physical properties from the parent matter. The radiating power is an atomic property, for it is unaffected by combination of the active element with inactive bodies, and is uninfluenced by the most powerful chemical and physical agencies at our command. In order to explain these results, Rutherford and Soddy (20) in 1903 put forward a simple but comprehensive theory. The atoms of radioactive matter are unstable, and each second a definite fraction of the number of atoms present break up with explosive violence, in most cases expelling an α or β particle with great velocity. Taking as a simple illustration that an α particle is expelled during the explosion, the resulting atom has decreased in mass and possesses chemical and physical properties entirely distinct from the parent atom. A new type of matter has thus appeared as a result of the transformation. The atoms of this new matter are again unstable and break up in turn, the process of successive disintegration of the atom continuing through a number of distinct stages. On this view, a substance like the radium emanation is derived from the transformation of radium. The atoms of the emanation are far more unstable than the atoms of radium, and break up at a much quicker rate. We shall now consider the law of radioactive transformation according to this theory. It is experimentally observed that in all simple radioactive substances, the intensity of the radiation decreases in a geometrical progression with the time, *i.e.* $I/I_0 = e^{-\lambda t}$ where I is the intensity of the radiation at any time t , I_0 the initial intensity, and λ a constant. Now according to this theory, the intensity of the radiation is proportional to the number of atoms breaking up per second. From this it follows that the atoms of active matter present decrease in a geometrical progression with the time, *i.e.* $N/N_0 = e^{-\lambda t}$ where N is the number of atoms present at a time t , N_0 the initial number, and λ the same constant as before. Differentiating, we have $dN/dt = -\lambda N$, *i.e.* λ represents the fraction of the total number of atoms present which break up per second. The radioactive constant λ has a definite and characteristic value for each type of matter. Since λ is usually a very small fraction, it is convenient to distinguish the products by stating the time required for half the matter to be transformed. This will be called the period of the product, and is numerically equal to $\log_2 2/\lambda$. As far as our observation has gone, the law of radioactive change is applicable to all radioactive matter without exception. It appears to be an expression of the law of probability, for the average number breaking up per second is proportional to the number present. Viewed from this point of view, the number of atoms breaking up per second should have a certain average value, but the number from second to second should vary within certain limits according to the theory of probability. The theory of this effect was first put forward by Schweidler, and has since been verified by a number of experimenters, including Kohlrausch, Meyer, and Begener and H. Geiger. This variation in the number of atoms breaking up from moment to moment becomes marked with weak radioactive matter, where only a few atoms break up per second. The variations observed are in good agreement with those to be expected from the theory of probability. This effect does not in any way invalidate the law of radioactive change. On an average the number of atoms of any simple kind of matter breaking up per second is proportional to the number present. We shall now consider how the amount of radioactive matter which is supplied at a constant rate from a source varies with the time. For clearness, we shall take the case of the production of emanation, by radium. The rate of transformation of radium is so slow compared with that of the emanation that we may assume without sensible error that the number of atoms of radium breaking up per second, *i.e.* the supply of fresh emanation, is on the average constant over the interval required. Suppose that initially radium is completely freed from emanation. In consequence of the steady supply, the amount of emanation present increases, but not at a constant rate, for the emanation is in turn breaking up. Let q be the number of atoms of emanation

produced by the radium per second and N the number present after an interval t , then $dN/dt = q - \lambda N$ where λ is the radioactive constant of the emanation. It is obvious that a steady state will ultimately be reached when the number of atoms of emanation supplied per second are on the average to the atoms which break up per second. If N_0 be the maximum number, $q = \lambda N_0$. Integrating the above equation, it follows that $N/N_0 = 1 - e^{-\lambda t}$. If a curve be plotted with N as ordinates and time as abscissae, it is seen that the recovery curve is complementary to the decay curve. The two curves for the radium emanation period, 3.8 days, are shown in fig. 1, the maximum ordinate being in each case 100.

This process of production and disappearance of active matter holds for all the radioactive bodies. We shall now consider some special cases of the variation of the amount of active matter with time which have proved of great importance in the analysis of radioactive changes.

(a) Suppose that initially the matter A is present, and this changes into B and B into C, it is required to find the number of atoms P, Q and R of A, B and C present at any subsequent time t .

Let $\lambda_1, \lambda_2, \lambda_3$ be the constants of transformation of A, B and C respectively. Suppose n be the number of atoms of A initially present. From the law of radioactive change it follows:

$$P = ne^{-\lambda_1 t}$$

$$\frac{dQ}{dt} = \lambda_1 P - \lambda_2 Q \dots \dots \dots (1)$$

$$\frac{dR}{dt} = \lambda_2 Q - \lambda_3 R \dots \dots \dots (2)$$

Substituting the value of P in terms of n in (1), $dQ/dt = \lambda_1 n e^{-\lambda_1 t} - \lambda_2 Q$; the solution of which is of the form

$$Q = n(ae^{-\lambda_1 t} + be^{-\lambda_2 t}),$$

where a and b are constants. By substitution it is seen that $a = \lambda_1/(\lambda_2 - \lambda_1)$. Since $Q = 0$ when $t = 0$, $b = -\lambda_1/(\lambda_2 - \lambda_1)$

$$\text{Thus } Q = \frac{n\lambda_1}{\lambda_1 - \lambda_2} (e^{-\lambda_2 t} - e^{-\lambda_1 t}) \dots \dots \dots (3)$$

Similarly it can be shown that

$$R = n(ae^{-\lambda_1 t} + be^{-\lambda_2 t} + ce^{-\lambda_3 t}) \dots \dots \dots (4)$$

$$\text{where } a = \frac{\lambda_1 \lambda_2}{(\lambda_1 - \lambda_2)(\lambda_1 - \lambda_3)}, \quad b = \frac{\lambda_1 \lambda_2}{(\lambda_2 - \lambda_1)(\lambda_2 - \lambda_3)}, \quad c = \frac{\lambda_1 \lambda_2}{(\lambda_3 - \lambda_1)(\lambda_3 - \lambda_2)}$$

It will be seen from (3), that the value of Q , initially zero, increases to a maximum and then decays; finally, according to an exponential law, with the period of the more slowly transformed product, whether A or B.

(b) A primary source supplies the matter A at a constant rate, and the process has continued so long that the amounts of the products A, B, C have reached a steady limiting value. The primary source is then suddenly removed. It is required to find the amounts of A, B and C remaining at any subsequent time t .

In this case of equilibrium, the number n_0 of particles of A supplied per second from the source is equal to the number of particles which change into B per second, and also of B into C. This requires the relation

$$n_0 = \lambda_1 P_0 = \lambda_2 Q_0 = \lambda_3 R_0$$

where P_0, Q_0, R_0 are the initial number of particles of A, B, C present, and $\lambda_1, \lambda_2, \lambda_3$ are their constants of transformation.

Using the same notations as in case (1), but remembering the new initial conditions, it can easily be shown that the number of particles P, Q and R of the matter A, B and C existing at the time t after removal are given by

$$P = \frac{n_0}{\lambda_1} e^{-\lambda_1 t},$$

$$Q = \frac{n_0}{\lambda_1 - \lambda_2} \left(\frac{\lambda_1}{\lambda_2} e^{-\lambda_2 t} - e^{-\lambda_1 t} \right),$$

$$R = n_0 (ae^{-\lambda_1 t} + be^{-\lambda_2 t} + ce^{-\lambda_3 t}),$$

$$\text{where } a = \frac{\lambda_2}{(\lambda_1 - \lambda_2)(\lambda_1 - \lambda_3)}, \quad b = \frac{-\lambda_1}{(\lambda_1 - \lambda_2)(\lambda_2 - \lambda_3)}, \quad c = \frac{\lambda_1 \lambda_2}{\lambda_3(\lambda_1 - \lambda_3)(\lambda_2 - \lambda_3)}$$

The curves expressing the rate of variation of P, Q, R with time are in these cases very different from case (1).

(c) The matter A is supplied at a constant rate from a primary source. Required to find the number of particles of A, B and C present at any time t later, when initially A, B, and C were absent.

This is a converse case from case (2) and the solutions can be obtained from general considerations. Initially suppose A, B and C are in equilibrium with the primary source which supplied A at a constant rate. The source is then removed and the amounts of A, B and C vary according to the equation given in case (2). The source after removal continues to supply A at the same rate as before. Since initially the product A was in equilibrium with the source, and the radioactive processes are in no way changed by the removal of the source, it is clear that the amount of A present in the two parts in which the matter is distributed is unchanged. If P_t be the amount of A produced by the source in the time t , and P

the amount remaining in the part removed, then $P_1 + P = P_0$, where P_0 is the equilibrium value. Thus

$$P_1/P_0 = 1 - P/P_0.$$

The ratio P/P_0 can be written down from the solution given in case (2). Similarly the corresponding values of Q_1/Q_0 , R_1/R_0 may be at once derived. It is obvious in these cases that the curve plotted with P/P_0 as ordinates and time as abscissae is complementary to the corresponding curve with P_1/P_0 as ordinates. This simple relation holds for all recovery and decay curves of radioactive products in general.

We have so far considered the variation in the number of atoms of successive products with time when the periods of the products are known. In practice, the variation of the number of atoms is deduced from measurements of activity, usually made by the electric method. Using the same notation as before, the activity of any product is proportional to its rate of breaking up, i.e. to $\lambda_1 P$ where P is the number of atoms present. If two products are present, the activity is the sum of two corresponding terms $\lambda_1 P$ and $\lambda_2 Q$. In practice, however, no two products emit α or β particles with the same velocity. The difference in ionizing power of a single α particle from the two products has thus to be taken into account. If, under the experimental conditions, the ionization produced by an α particle from the second product is K times that from the first product, the activity observed is proportional to $\lambda_1 P + K\lambda_2 Q$. In this way, it is possible to compare the theoretical activity curves of a mixture of products with those deduced experimentally.

Analysis of Radioactive Changes.—The analysis of the successive changes occurring in uranium, thorium, radium and actinium has proved a very difficult matter. In order to establish the existence of a new product and to fix its position in the scheme of changes, it is necessary to show (a) that the new product has a distinctive period of decay and shows some distinctive physical or chemical properties; (b) that the product under consideration arises directly from the product preceding it in the scheme of changes, and is transformed into the product succeeding it.

In general, it has been found that each product shows some distinctive chemical or physical behaviour which allows of its partial or complete separation from a mixture of other products. It must be remembered that in most cases the amount of radioactive matter under examination is too small to detect by weight, but its presence is inferred from its characteristic radiations and rate of change. In some cases, a separation may be effected by ordinary chemical methods; for example thorium X is separated from thorium by precipitation of thorium with ammonia. The Th X remains in the filtrate and is practically free from thorium. In other cases, a separation is effected by a separation of a metal in the solution of active matter. For example, polonium (radium F) always comes down with bismuth and may be separated by placing a bismuth plate in a solution. Radium C is separated from radium B by adding nickel filings to a solution of the two. Radium C is deposited on the nickel. In other cases, a partial separation may be effected by electrolysis or by differences in volatility when heated. For example, when radium A, B and C are deposited on a platinum plate, on heating the plate, radium B is volatilized and is deposited on any cold surface in the neighbourhood. A very striking method of separating certain products has been recently observed depending upon the recoil of an atom which breaks up with the expulsion of an α particle. The residual atom acquires sufficient velocity in consequence of the ejection of an α particle to escape and be deposited on bodies in the neighbourhood. This is especially marked in a low vacuum. This property was independently investigated by Russ and Makower (21) and by Hahn (22). The latter has shown that by means of the recoil, actinium C may be obtained pure from the active deposit containing actinium A, B and C, for B emits α rays, and actinium C is driven from the plate by the recoil. In a similar way a new product, thorium D, has been isolated. By the recoil method, radium B may be separated from radium A and C. The recoil method is one of the most definite and certain methods of settling whether an α ray product is simple or complex.

While in the majority of cases the products break up either with the emission of α or β particles, some products have been observed which do not emit any characteristic radiation and have been called "rayless products." For example, radium D and

thorium A are changing substances which break up without emitting either penetrating α or β rays. They appear to emit slow δ rays which can only be detected by special methods. The presence and properties of a rayless product can be easily inferred if it is transformed into a product emitting a radiation, for the variation in activity of the latter affords a method of determining the amount of the parent product present. The distinction between a "ray" and a "rayless" product is not clear. It may be that the atom of a rayless product undergoes a re-arrangement of its constituent parts giving rise to an atom of the same mass but of different properties. In the case of an α ray or β ray product, the expulsion of an α or β particle affords an obvious explanation of the appearance of a new product with distinctive physical properties.

In the table a list of the known products of transformation is given. In each case, the half period of transformation is given and the type of radiation emitted. If the product emits α rays, the range of ionization of the α particle in air is given.

TABLE OF RADIOACTIVE PRODUCTS

Product.	Half Period of Transformation.	Rays.	Range of Rays in Air in Cms.
URANIUM—			
Uranium X	5×10^9 years	α	3.5
Ionium	22 days	$\beta + \gamma$..
	?	α	2.8
RADIUM—			
Ra Emanation.	1760 years	α	3.5
Radium A	3.86 days	α	4.33
Radium B	3 mins.	α	4.83
Radium C	26 mins.	slow β	..
Radium D	19 mins.	$\alpha + \beta + \gamma$	7.06
Radium E	17 years	slow β	..
Radium F	5 days	β	..
Radium G	140 days	α	3.86
Radium G = lead?
THORIUM—			
(Th. 1)	about 10^{10} yrs.	..	3.5
Mesothorium (Th. 2)	5.5 years	rayless	..
Radiothorium	6.2 hours	$\beta + \gamma$..
Thorium X	737 days	α	3.9
Th Emanation	3.6 days	α	5.7
Thorium A	54 secs	α	5.5
Thorium B	10.6 hours	slow β	..
Thorium C	55 mins.	α	5.0
Thorium D	very short?	α	8.6
	3 mins.	$\beta + \gamma$..
ACTINIUM—			
Radioactinium	?	rayless	..
Actinium X	19.5 days	$\alpha + \beta$	4.8
Act Emanation	11.8 days	α	6.55
Actinium A	3.7 secs.	α	5.8
Actinium B	36 mins.	slow β	..
Actinium C	2.15 mins.	α	5.50
	5.1 mins.	$\beta + \gamma$..

In each of the groups under the heading uranium, thorium and actinium, each product is derived from the direct transformation of the product above it.

Products of Radium.—Radium is transformed directly into the emanation which in turn goes through a rapid series of transformations called radium A, B and C. The complete analysis of these changes has involved a large amount of work. The emanation changes first into radium A, a substance of period 3 minutes emitting only α rays. Radium A changes into radium B, a product of period 26 minutes emitting β rays of penetrating power small compared with those emitted from the next product radium C. The product radium C has proved of considerable importance, for it not only emits very penetrating α rays and β rays, but is the origin of the γ rays arising from radium in equilibrium. When a wire charged negatively has been exposed for some time in the presence of the radium emanation, it becomes coated with an invisible film of radium A, B and C. After

removal from the emanation for 20 minutes, radium A has practically disappeared and the α rays arise entirely from radium C. Radium C has proved very valuable in radioactive measurements as providing an intense source of homogeneous α rays. Twenty-four hours after removal, the activity due to radium B and C has become exceedingly small. The wire, however, still shows a very small residual activity, first noted by Mme Curie. This residual activity measured by the α rays rapidly increases with the time and reaches a maximum in about three years. The active deposit of slow change has been examined in detail by Rutherford (23) and by Meyer and Schweidler (24). It has been shown to consist of three successive products called radium D, E and F. Radium D is a rayless substance of slow period of transformation. Its period has been calculated by Rutherford to be about 40 years, and by Meyer and Schweidler about 12 years. Antonoff (25) fixes the period of about 17 years. Radium D changes into E, a β ray product of period about 5 days, and E into F, an α ray product of period 140 days. It was at first thought that radium E was complex, but no evidence of this has been observed by Antonoff. The product radium F is of special interest, for it is identical with polonium—the first active body separated by Mme Curie. In a similar way it has been shown that radium D is the primary source of the activity observed in lead or "radiolead" separated by Hofmann. It is interesting to note what valuable results have been obtained from an examination of the minute residual activity observed on bodies exposed in the presence of the radium emanation.

Radium Emanation.—The radium emanation is to be regarded as a typical radioactive product or transition element which exists in a gaseous form. It is produced from radium at a constant rate, and is transformed into radium A and helium. Its half-period of transformation is 3.86 days. The emanation from radium has been purified by condensing it in liquid air, and pumping out the residual gases. The volume (26) of the emanation at normal pressure and temperature to be derived from one gram of radium in equilibrium is about 0.6 cubic millimetres. This small quantity of gas contains initially more than three-quarters of the total activity of the radium before its separation. In a pure state, the emanation is 100,000 times as active weight for weight as pure radium. Pure emanation in a spectrum tube gives a characteristic spectrum of bright lines (27). The discharge in the gas is bluish in colour. With continued sparking, the emanation is driven into the walls of the tube and the electrodes. Notwithstanding the minute volume of emanation available, the boiling-point of the emanation has been determined at various pressures. At atmospheric pressure Rutherford (28) found the boiling-point to be -67° C., and Gray and Ramsay (29) 71° C. Liquid emanation appears colourless when first condensed; when the temperature is lowered, the liquid emanation freezes, and at the temperature of liquid air glows with a bright rose colour. The density of liquid emanation has been estimated at 5 or 6.

Approximate estimates of the molecular weight of the radium emanation were early made by diffusion methods. The molecular weight in most cases came out about 100. In a comparison by Perkins of the rate of diffusion of the emanation with that of a monatomic vapour of high molecular weight, viz. mercury, the value deduced was 234. Since the radium atom in breaking up gives rise to one atom of the emanation and one atom of helium, its atomic weight should be $226 - 4 = 222$. The emanation appears to have no definite chemical properties, and in this respect belongs to the group of inert monatomic gases of which helium and argon are the best known examples. It is partially soluble in water, and readily absorbed by charcoal.

Thorium.—The first product observed in thorium was the emanation. This gives rise to the active deposit which has been analysed by Rutherford, Miss Brooks and by Hahn, and shown to consist of probably four products—thorium A, B, C and D. Thorium A is a rayless product of period 10.5 hours; thorium B an α ray product of period about one hour. The presence of thorium C has been inferred from the two types of α rays

present in the active deposit, but no chemical separation of B and C has yet been found possible. Hahn has shown that thorium D—a β ray product of period 3 minutes—can easily be separated by the recoil method. A special interest attaches to the product thorium X (30), which was first separated by Rutherford and Soddy, since experiments with this substance laid the foundation of the general theory of radioactive transformations. A close analysis of thorium has led to the separation of a number of new products. Hahn (31) found that a very active substance emitting α rays, which gave rise to thorium X, could be separated from thorium minerals. This active substance, called *radiothorium*, has been closely examined by Hahn and Blanc. Its period of decay was found by Hahn to be about 2 years, and by Blanc to be 737 days. From an examination of the activity of commercial thorium nitrate of different ages, Hahn showed that another product must be present, which he called *mesothorium*. This is separated from thorium with Th X by precipitation with ammonia. Thorium is first transformed into the rayless product mesothorium, of period about 5 years. This gives rise to a β ray product of quick transformation, which in turn changes into *radiothorium*. This changes into thorium X, and so on through a long series of changes. When isolated in the pure state, radiothorium would have an activity about a thousand times greater than radium, but would lose its activity with time with a period of about 2 years. Mesothorium, when first separated, would be inactive, but in consequence of the production of radiothorium, its activity would rapidly increase for several years. After reaching a maximum, it would finally decay with a period of five years. Since a large amount of thorium is separated annually from thorium minerals, it would be of great importance at the same time to separate the radiothorium and mesothorium present. For many purposes active preparations of these substances would be as valuable as radium itself, and the amount of active matter from this source would be greater than that at present available from the separation of radium from uranium minerals.

Actinium.—The transformations observed in actinium are very analogous to those in thorium. Actinium itself is a rayless product which changes into radioactinium, an α ray product of period 10.5 days, first separated by Hahn (32). This changes into actinium X, of period 10.2 days, first separated by Godlewski (33). Actinium X is transformed into the emanation which in turn gives rise to three further products, called actinium A, B and C. Although very active preparations of actinium have been prepared, it has so far not been found possible to separate the actinium from the rare earths with which it is mixed. We do not in consequence know its atomic weight or spectrum.

Origin of Radium.—According to the transformation theory, radium, like all other radioactive products, must be regarded as a changing element. Preliminary calculations showed that radium must have a period of transformation of several thousand years. Consequently in order that any radium could exist in old minerals, the supply must be kept up by the transformation of some other substance. Since radium is always found associated with uranium minerals, it seemed probable from the beginning that uranium must be the primary element from which radium is derived. If this were the case, in old minerals which have not been altered by the action of percolating waters, the ratio of the amount of radium to uranium in a mineral must be a constant. This must evidently be the case, for in a state of equilibrium the rate of breaking up of radium must equal the rate of supply of radium from uranium. If P, Q be the number of atoms of uranium and radium respectively in equilibrium, and λ_1, λ_2 their constants of change, then

$$\lambda_2 Q = \lambda_1 P \text{ or } Q/P = \lambda_1/\lambda_2 = T_2/T_1,$$

where T_2 and T_1 are the half-periods of transformation of uranium and radium respectively. The work of Boltwood (34), Strutt (35) and McCoy (36) has conclusively shown that the ratio of radium to uranium in old minerals is a constant. Boltwood and Strutt determined the quantity of radium present in a mineral by the emanation method, and the amount of uranium by analysis.

In order, however, to obtain a direct proof of the genetic relation between uranium and radium, it is necessary to show that radium appears after some time in a uranium compound from which all trace of radium has been initially removed. It can readily be calculated that the growth of radium should be easily observed by the emanation method in the course of one week, using a kilogram of uranium nitrate. Experiments of this kind were first made by Soddy (37), but initially no definite evidence was obtained that radium grew in the solution at all. The rate of production of radium, if it took place at all, was certainly less than $\frac{1}{10,000}$ th part of the amount to be expected if uranium were transformed directly into radium. It thus appeared probable that one or more products of slow period of transformation existed between uranium and radium. Since uranium must be transformed through these intermediate stages before radium appears, it is evident that the initial rate of production of radium under these conditions might be extremely small. This conclusion has been confirmed by Soddy, who has shown that radium does appear in the solution which has been placed aside for several years.

Since the direct parent of radium must be present in radioactive minerals, one of the constituents separated from the mineral must grow radium. This was shown to be the case by Boltwood (38), who found that actinium preparations produced radium at a fairly rapid rate. By the work of Rutherford and Boltwood, it was found that the growth of radium was not due to actinium itself, but to a new substance separated in some cases with the actinium. This new substance, which emits α rays, was separated by Boltwood (38), and called by him "Ionium." It has chemical properties very similar to thorium. Soddy has shown that the period of ionium is probably not less than 20,000 years, indicating that ionium must exist in uranium minerals in not less than ten times the quantity of radium. It has not yet been directly shown that uranium produces ionium, but there can be no doubt that it does so. Since ionium produces radium, Boltwood (38) has determined by direct experiment that radium is half transformed in 2000 years—a number in good agreement with other data on that subject. The constant relation between uranium and radium will only hold for old minerals where there has been no opportunity for chemical alteration or removal of its constituents by the action of percolating water or other agencies. It is quite possible that altered minerals of no great age will not show this constant relation. It seems probable that this is the explanation of some results of Mlle Gleditsch, where the relation between uranium and radium has been found not to be constant for some mineral specimens.

Connexion of the Radioelements.—We have already seen that a number of slowly transforming radioactive substances, viz. polonium (radium F), radiolead (radium D) and ionium are linked up to the uranium-radium series of transformations. Boltwood (39) has made a systematic examination of the relative activity in the form of very thin films due to each of the products present in the uranium-radium family. The results are shown in the following table, where the activity of pure uranium itself is taken as unity:—

Uranium	1.00	Radium B	0.04(?)
Ionium	0.34	Radium C	0.91
Radium	0.45	Radium F	0.46
Emanation	0.62	Actinium and its products	0.28
Radium A	0.54		
Total activity mineral, 4.64 times uranium.			

Taking into account the differences in the ionization due to an α particle from the various products, the results indicate that uranium expels two α particles for one from each of the other α ray products in the series of transformations. This indicates either that two particles are expelled during the transformation of the atom of uranium, or that another α ray product is present which has so far not been separated from the uranium.

Although thorium is nearly always present in old uranium minerals and uranium in thorium minerals, there does not

appear to be any radioactive connexion between these two elements. Uranium and thorium are to be regarded as two distinct radioactive elements. With regard to actinium, there is still no definite information of its place in the scheme of transformations. Boltwood has shown that the amount of actinium in uranium minerals is proportional to the content of uranium. This indicates that actinium, like radium, is in genetic connexion with uranium. On the other hand, the activity of actinium with its series of α ray products is less than that of radium itself or uranium. In order to explain this anomaly, Rutherford has suggested that at a certain stage of disintegration of the uranium-radium series, the disintegration is complex, and two distinct kinds of matter appear, one in much larger quantity than the other. On this view, the smaller fraction is actinium, so that the latter is a branch descendant of the main uranium-radium series.

End Products of Transformation.—It is now definitely established that the α particle expelled from any type of radioactive matter is an atom of helium, so that helium is a necessary accompaniment of radioactive changes involving the expulsion of α particles. After the radioactive transformations have come to an end, each of the elements uranium and thorium and actinium should give rise to an end or final product, which may be either a known element or some unknown element of very slow period of transformation. Supposing, as seems probable, that the expulsion of an α particle lowers the atomic weight of an element by four units—the atomic weight of helium—the atomic weights of each of the products in the uranium and radium series can be simply calculated. Since uranium expels two α particles, the atomic weight of the next ray product, ionium, is $238.5 - 8$ or 230.5 . The atomic weight of radium comes out to be 266.5 , a number in good agreement with the experimental value. Similarly the atomic weight of polonium is 210.5 , and that of the final product after the transformation of polonium should be 206.5 . This value is very close to the atomic weight of lead, and indicates that this substance is the final product of the transformation of radium.

This suggestion was first put forward by Boltwood (40), who has collected a large amount of evidence bearing on this subject. Since in old minerals the transformations have been in progress for periods of time, in some cases measured by hundreds of millions of years, it is obvious that the end product, if a stable element, should be an invariable companion of the radioelement and be present in considerable quantity. Boltwood has shown that lead always occurs in radioactive minerals, and in many cases in amount about that to be expected from their uranium content and age. It is difficult to settle definitely this very important problem until it can be experimentally shown that radium is transformed into lead, or, what should prove simpler in practice, that polonium changes into helium and lead. Unfortunately for a solution of this problem within a reasonable time, a very large quantity of polonium would be necessary. Mme. Curie and Debierne have obtained a very active preparation of polonium containing about $\frac{1}{10}$ th milligram of pure polonium. Rutherford and Boltwood and Curie and Debierne have both independently shown that polonium produces helium—a result to be expected, since it emits α particles.

Production of Helium.—In 1902 Rutherford and Soddy suggested that the helium which is invariably found in radioactive minerals was derived from the disintegration of radioactive matter. In 1903 Ramsay and Soddy definitely showed that helium was produced by radium and also by its emanation. From the observed mass of the α particle, it seemed probable from the first that the α particle was an atom of helium. This conclusion was confirmed by the work of Rutherford and Geiger (41), who showed that the α particle was an atom of helium carrying two unit charges of electricity. In order to prove definitely this relation, it was necessary to show that the α particles, quite independently of the active matter from which they were expelled, gave rise to helium. This was done by Rutherford and Royds (42), who allowed the α particles from a large quantity of emanation to be fired through the

very thin glass walls of the containing tube. The collected particle gave the spectrum of helium, showing, without doubt, that the α particle must be a helium atom.

Since the α particle is an atom of helium, all radioactive matter which expels α particles must give rise to helium. In agreement with this, Debierne and Giesel have shown that actinium as well as radium produces helium. Observations of the production of helium by radium have been made by Ramsay and Soddy, Curie and Dewar, Himstedt and others. The rate of production of helium per gram of radium was first definitely measured by Dewar (43). His preliminary measurements gave a value of 134 cubic mms. of helium per year per gram of radium and its products. Later observations extending over a larger interval give a rate of production about 168 cubic mms. per year. As a result of preliminary measurements, Boltwood and Rutherford (44) have found a growth of 163 cubic mms. per year. It is of interest to note that the rate of production of helium by radium is in excellent agreement with the value calculated theoretically. From their work of counting the particles and measuring their charge, Rutherford and Geiger showed that the rate of production of helium should be 158 cubic mms. per year.

Properties of the α Rays.—We have seen that the rays are positively charged atoms of helium projected at a high velocity, which are capable of penetrating through thin metal sheets and several centimetres of air. Early observations indicated that the ionization due to a layer of radioactive matter decreased approximately according to an exponential law with the thickness of the absorbing matter placed over the active matter. The true nature of the absorption of the α rays was first shown by Bragg and by Bragg and Klecman (45). The active particles projected from a thin film of active matter of one kind have identical velocities, and are able to ionize the air for a definite distance, termed the "range" of the α particle. It was found that the ionization per centimetre of path due to a narrow pencil of α rays increases with the distance from the active matter, at first slowly, then more rapidly, near the end of the range. After passing through a maximum value the ionization falls off rapidly to zero. The range of an α particle in air has a definite value which can be accurately measured. If a uniform screen of matter is placed in the path of the pencil of rays the range is reduced by a definite amount proportional to the thickness of the screen. All the α particles have their velocity reduced by the same amount in their passage through the screen. The ranges in air of the α rays from the various products of the radioelements have been measured. The ranges for the different products vary between 2.8 cms. and 8.6 cms.

Bragg has shown that the range of an α particle in different elements is nearly proportional to the square roots of their atomic weights. Using the photographic method, Rutherford (46) showed that the velocity V of an α particle of range R cms. in air is given by $V^2 = K(R + 1.25)$, where K is a constant. In his experiments he was unable to detect particles which had a velocity lower than 8.8×10^8 cms. per second. Geiger (47), using the scintillation method, has recently found that α particles of still lower velocity can be detected under suitable conditions by the scintillations produced on a zinc sulphide screen. He has found that the connexion between velocity and range can be closely expressed by $V^3 = KR$, where K is a constant.

On account of the great energy of motion of the α particle, it was at first thought that it pursued a rectilinear path in the gas without appreciable deflection due to its encounters with the molecules. Geiger (48) has, however, shown by the scintillation method that the α particles are scattered to a marked extent in passing through matter. The scattering increases with the atomic weight of the substance traversed, and becomes more marked with decreasing velocity of the α particle. A small fraction of the α particles falling on a thick screen are deflected through more than a right angle, and emerge again on the side of incidence.

Rutherford and Geiger (49) have devised an electrical method of counting the α particles expelled from radioactive matter. The α particle enters through a small opening into a metal tube containing a gas at a reduced pressure. The ionization produced by the α particle in its passage through the gas is magnified several thousand times by the movement of the ions in a strong electric field. In this way, the entrance of an α particle into the detecting vessel is shown by a sudden and large deflection of the measuring instrument. By this method, they determined that 3.4×10^{10} α particles are ejected per second from one gram of radium itself and from each of its α ray products in equilibrium with it. By measuring the charge on a counted number of α particles, it was found that the α particle carries a positive charge of 9.3×10^{-10} electrostatic units. From other evidence, it is known that this must be twice the fundamental unit of charge carried by the hydrogen atom. It follows that this unit charge is 4.65×10^{-10} units. This value is in good agreement with numerous recent determinations of this fundamental quantity by other methods. With this data, it is possible to calculate directly the values of some important radioactive data. The calculated and observed values are given below:—

	Calculated.	Observed.
Volume of the emanation in cubic millimetres per gram of radium	585	6
Volume of helium in cubic millimetres produced per year per gram of radium	158	169
Heating effect of radium per gram per hour in gram calories	113	118
Half-period of transformation of radium in year	1760	2000

The calculated values are in all cases in good agreement with the experimental numbers.

It is well known from the experiments of Sir William Crookes (50) that the α rays produce visible scintillations when they fall on a screen of phosphorescent zinc sulphide. This is shown in the instrument called the spintharoscope. By means of a suitable microscope, the number of these scintillations on a given area in a given time can be counted. The number so obtained is practically identical with the number of α particles incident on the screen, determined by the electrical method of counting. This shows that each α particle produces a visible flash of light when it falls on a suitable zinc sulphide screen. The scintillations produced by α rays are observed in certain diamonds, and their number has been counted by Regener (51) and the charge on each particle has been deduced. The latter was the first to employ the scintillation method for actual counting of α particles. Kinoshita has shown that the number of α particles can also be counted by the photographic method, and that each particle must produce a detectable effect.

Absorption of β Rays.—We have seen that the β particles, which are emitted from a number of radioactive products, carry a negative charge and have the same small mass as the particles constituting the cathode rays. The velocity of expulsion and penetrating power of the β rays varies widely for different products. For example, the rays from radium B are very easily absorbed, while some of the rays from radium C are of a very penetrating type. It has been found that for a single β ray product, the particles are absorbed according to an exponential law with the thickness of matter traversed, and Hahn has made use of this fact to isolate a number of new products. It has been generally assumed that the exponential law of absorption is a criterion that the β rays are all expelled at the same speed. In addition, it has been supposed that the β particles do not decrease much in velocity in passing through matter. Wilson has recently made experiments upon homogeneous β rays, and finds that the intensity of the radiation falls off in some cases according to a linear rather than to an exponential law, and that there is undoubted evidence that the β particles decrease in velocity in traversing matter. Experiments upon the absorption of β rays are greatly complicated by the scattering of the β rays in their encounters with the molecules. For example, if a pencil of β rays falls on a metal, a large fraction of the rays are scattered

sufficiently to emerge on the side of incidence. This scattering of the β rays has been investigated by Eve, McLennan, Schmidt, Crowther and others. It has been found that the scattering for different chemical elements is connected with their atomic weight and their position in the periodic table. McClland and Schmidt have given theories to account for the absorption of β rays by matter. The whole problem of absorption and scattering of particles by substances is very complicated, and the question is still under active examination and discussion. The negative charge carried by the β rays has been measured by a number of observers. It has been shown by Rutherford and Makower that the number of β particles expelled per second from one gram of radium in equilibrium is about that to be expected if each atom of the β ray products in breaking up emits one β particle.

Heat Emission of Radioactive Matter.—In 1903 it was shown by Curie and Laborde (52) that a radium compound was always hotter than the surrounding medium, and radiated heat at a constant rate of about 100 gram calories per hour per gram of radium. The rate of evolution of heat by radium has been measured subsequently by a number of observers. The latest and most accurate determination by Schweidler and Hess, using about half a gram of radium, gave 118 gram calories per gram per hour (53). There is now no doubt that the evolution of heat by radium and other radioactive matter is mainly a secondary phenomenon, resulting mainly from the expulsion of α particles. Since the latter have a large kinetic energy and are easily absorbed by matter, all of these particles are stopped in the radium itself or in the envelope surrounding it, and their energy of motion is transformed into heat. On this view, the evolution of heat from any type of radioactive matter is proportional to the kinetic energy of the expelled α particles. The view that the heating effect of radium was a measure of the kinetic energy of the α particles was strongly confirmed by the experiments of Rutherford and Barnes (54). They showed that the emanation and its products when removed from radium were responsible for about three-quarters of the heating effect of radium in equilibrium. The heating effect of the radium emanation decayed at the same rate as its activity. In addition, it was found that the ray products, viz. the emanation radium A and radium C, each gave a heating effect approximately proportional to their activity. Measurements have been made on the heating effect of uranium and thorium and of pitchblende and polonium. In each case, the evolution of heat has been shown to be approximately a measure of the kinetic energy of the α particles.

Experiments on the evolution of heat from radium and its emanation have brought to light the enormous amount of energy accompanying the transformation of radioactive matter where α particles are emitted. For example, the emanation from one gram of radium in equilibrium with its products emits heat initially at the rate of about 90 gram calories per hour. The total heat emitted during its transformation is about 12,000 gram calories. Now the initial volume of the emanation from one gram of radium is .6 cubic millimetres. Consequently one cubic centimetre of emanation during its life emits 2×10^7 gram calories. Taking the atomic weight of the emanation as 222, one gram of the emanation emits during its life 2×10^9 gram calories of heat. This evolution of heat is enormous compared with that emitted in any known chemical reaction. There is every reason to believe that the total emission of energy from any type of radioactive matter during its transformation is of the same order of magnitude as for the emanation. The atoms of matter must consequently be regarded as containing enormous stores of energy which are only released by the disintegration of the atom.

A large amount of work has been done in measuring the amount of the thorium and radium emanation in the atmosphere, and in determining the quantity of radium and thorium distributed on the surface of the earth. The information already obtained has an important bearing on geology and atmospheric electricity.

REFERENCES.—1. H. Becquerel, *Comptes Rendus*, 1896, pp. 420, 501, 559, 689, 762, 1086; 2. Rutherford, *Phil. Mag.*, Jan. 1899; 3. Mme Curie, *Comptes Rendus*, 1898, 126, p. 1101; M and Mme Curie and G. Bémont, *ib.*, 1898, 127, p. 1215; 4. Mme Curie, *ib.*, 1907, 145, p. 422; 5. Thorpe, *Proc. Roy. Soc.*, 1908, 80, p. 298; 6. Giesel, *Phys. Zeit.*, 1902, 3, p. 578; 7. Giesel, *Annal. d. Phys.*, 1899, 69, p. 91; *Ber.*, 1902, p. 3608; 8. Rutherford and Boltwood, *Amer. Journ. Sci.*, July 1906; 9. Debierne, *Comptes Rendus*, 1899, 129, p. 593; 1900, 130, p. 206; 10. Giesel, *Ber.*, 1902, p. 3608; 1903, p. 342; 11. Marckwald, *ib.*, 1903, p. 2662; 12. Mme Curie and Debierne, *Comptes Rendus*, 1910, 150, p. 386; 13. Boltwood, *Amer. Journ. Sci.*, May 1908; 14. Rutherford, *Phil. Mag.*, Feb. 1903, Oct. 1906; 15. Rutherford, *ib.*, Jan. 1900; 16. Rutherford and Soddy, *ib.*, May 1903; 17. Rutherford and Soddy, *ib.*, Nov. 1902; 18. M and Mme Curie, *Comptes Rendus*, 1899, 129, p. 714; 19. Rutherford, *Phil. Mag.*, Jan. and Feb. 1900; 20. Rutherford and Soddy, *ib.*, Sept. and Nov. 1902, April and May 1903; Rutherford, *Phil. Trans.*, 1904, 204A, p. 169; 21. Russ and Makower, *Proc. Roy. Soc.*, 1909, 82A, p. 205; 22. Hahn, *Phys. Zeit.*, 1909, 10, p. 81; 23. Rutherford, *Phil. Mag.*, Nov. 1904, Sept. 1905; 24. Meyer and Schweidler, *Wien. Ber.*, July 1905; 25. Antonoff, *Phil. Mag.*, June 1910; 26. Cameron and Ramsay, *Trans. Chem. Soc.*, 1907, p. 1266; Rutherford, *Phil. Mag.*, Aug. 1908; 27. Cameron and Ramsay, *Proc. Roy. Soc.*, 1908, 81A, p. 210; Rutherford and Royds, *Phil. Mag.*, 1908, 16, p. 313; Royds, *Proc. Roy. Soc.*, 1909, 82A, p. 22; Watson, *ib.*, 1910, 83A, p. 50; 28. Rutherford, *Phil. Mag.*, 1909; 29. Gray and Ramsay, *Trans. Chem. Soc.*, 1909, pp. 354, 1073; 30. Rutherford and Soddy, *Phil. Mag.*, Sept. and Nov. 1902; 31. Hahn, *Proc. Roy. Soc.*, March 1905; *Phil. Mag.*, June 1906; *Ber.*, 40, pp. 1462, 3304; *Phys. Zeit.*, 1908, 9, pp. 245, 246; 32. Hahn, *Phil. Mag.*, Sept. 1906; 33. Godlewski, *ib.*, July 1905; 34. Boltwood, *ib.*, April 1905; 35. Strutt, *Trans. Roy. Soc.*, 1905A; 36. McCoy, *Ber.*, 1904, p. 2641; 37. Soddy, *Phil. Mag.*, June 1905, Aug. 1907, Oct. 1908, Jan. 1909; 38. Boltwood, *Amer. Journ. Sci.*, Dec. 1906, Oct. 1907, May 1908, June 1908; 39. Boltwood, *ib.*, April 1908; 40. Boltwood, *ib.*, Oct. 1905, Feb. 1907; 41. Rutherford and Geiger, *Proc. Roy. Soc.*, 1908, 81A, p. 141; 42. Rutherford and Royds, *Phil. Mag.*, Feb. 1909; 43. Dewar, *Proc. Roy. Soc.*, 1908, 81A, p. 280; 1910, 83, p. 404; 44. Boltwood and Rutherford, *Manch. Lit. and Phil. Soc.*, 1909, 54, No. 6; 45. Bragg and Kleeman, *Phil. Mag.*, Dec. 1904, Sept. 1905; 46. Rutherford, *ib.*, Aug. 1906; 47. Geiger, *Proc. Roy. Soc.*, 1910, 83A, p. 505; 48. Geiger, *ib.*, 1910, 83A, p. 492; 49. Rutherford and Geiger, *ib.*, 1908, 81A, pp. 141, 163; 50. Crookes, *ib.*, 1903; 51. Regener, *Verhandl. d. D. Phys. Ges.*, 1908, 10, p. 28; 52. Curie and Laborde, *Comptes Rendus*, 1904, 136, p. 673; 53. Schweidler and Hess, *Wien. Ber.*, June 1908, 117; 54. Rutherford and Barnes, *Phil. Mag.*, Feb. 1904.

General treatises are: P. Curie, *Œuvres*, 1908; E. Rutherford, *Radioactive Transformations*, 1906; F. Soddy, *Interpretation of Radium*, 1909; R. J. Strutt, *Becquerel Rays and Radium*, 1904; W. Makower, *Radioactive Substances*, 1908; J. Joly, *Radioactivity and Geology*, 1909. See also *Annual Reports of the Chemical Society*. (E. Ru.)

RADIOLARIA, so called by E. Haeckel in 1862 (Polycystina, by C. G. Ehrenberg, 1838), the name given to Marine Sarcodina, in which the cytoplasmic body gives off numerous fine radiating pseudopods (rarely anastomosing) from its surface, and is provided with a chitinous "central capsule," surrounding the inner part which encloses the nucleus, the inner and outer cytoplasm communicating through either one or three apertures or numerous pores in the capsule. The extracapsular cytoplasm is largely transformed into a gelatinous substance ("calymma"), through which a granular network of plasma passes to form a continuous layer bearing the pseudopods at the surface; this gelatinous layer is full of large vacuoles, "alveoli," as in other pelagic Sarcodina (Heliozoa, *q.v.*), Globigerinidae, &c., among Foraminifera (*q.v.*). The protoplasm may contain oil-globules, pigment-grains, reserve-grains and crystals. There is frequently a skeleton present, either of silica (pure or containing a certain amount of organic admixture), or of "acanthin" (possibly a proteid, allied to vitellin, but regarded by W. Schewiakoff as a hydrated silicate of calcium and aluminium); never calcareous or arenaceous. The skeleton may consist of spicules, isolated or more or less compacted, or form a latticed shell, which, in correlation with the greater resistance of its substance, is of lighter and more elegant structure than in the Foraminifera. The alveoli contain a liquid; which, as shown by Brandt, is rich in carbon dioxide, and in proportion to its abundance may become much lighter than sea-water; and possibly the gelatinous substance of the calymma is also lighter than the medium. In Acantharia the protoplasm at the base

of the projecting spines is often differentiated into a bundle of fibres converging on to the spines some way up (distally); these, comparable to the myonemes of Infusoria (*q.v.*), &c., and termed "myophrisks", possibly serve to drag outwards the surface and so extend it, with concurrent dilatation of the alveoli, and lower the specific gravity of the animal. In this group also a thick temporary flagellum "sarcoflagellum" may be formed, apparently by the coalescence of a number of pseudopodia. The pigmented mass or "phaecodium" in the ectoplasm of Phaeodaria appears to be an excretory product, formed within the central capsule and passing immediately outwards; a similar uniform deposit of pigmented granules occurs in the Colloid species, *Thalassicolla nucleata*. The wall of the central capsule is simple in the Spumellaria, but formed of two layers in the Nassellaria and Phaeodaria. In the Nassellaria the oscule is simply a perforated area, and a cone of differentiated fibres in the intracapsular cytoplasm has its base on it: it is termed the "porocone," and the fibres may possibly be muscular (myonemes). In Phaeodaria, the inner membrane at each oscule is prolonged through the outer into a tube ("proboscis"): the outer membrane of the principal oscule forms a large radially

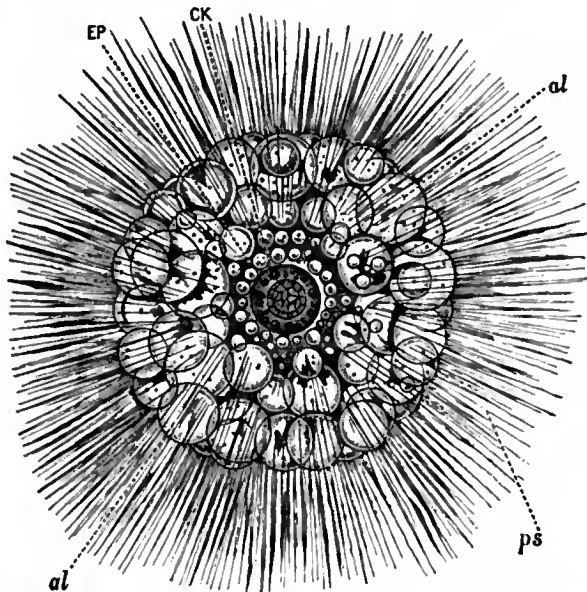

FIG. I.—*Thalassicolla pelagica*, Haeckel; $\times 25$. CK, central capsule; EP, extracapsular protoplasm; al, alveoli, liquid-holding vacuoles in the protoplasm similar to those of Heliozoa, Hastigerina, &c.; ps, pseudopodia. The minute unlettered dots are the "yellow cells."

striated circular plate, the "astropyle," or "operculum." The innermost shell of some with concentric shells may lie within the central capsule, or even within the nucleus; this is due to the growth of these organs after the initial shell is formed, so that they pass out by lobes through the latticed openings of the embryonic shell, which lobes ultimately coalesce outside the embryonic chamber, and so come finally to invest it (fig. III. 17). In some, a symbiosis occurs with *Zooxanthella*, Brandt, a Flagellate of the group Chrysomadinæ, which in the resting state inhabits the extracapsular cytoplasm growing and dividing freely therein, and only (under study) becoming free and flagellate on the death of the host (fig. III. 4, 6-13). The Silicoflagellata or Dietyochidae, also possessing a vegetable colouring matter, but with a skeleton of impure silica (like that of Phaeodaria), may pass some of their lives in symbiosis with Radiolaria.

Living Radiolaria were first observed and partially described by W. J. Tilesius in 1803-6 and 1814, by W. Baird in 1830, and by C. G. Ehrenberg in 1831, as luminous organisms in the sea; F. J. F. Meyen in 1834 recognized their animal character and the siliceous nature of their spicules. Ehrenberg a little later described a large number of Nassellarian skeletons under the

name of Polycystina (1838), but without more than a very slight knowledge of a few living forms. T. H. Huxley in 1851 made the first adequate study of the living animal, and was followed by Joh. Müller in the same decade. E. Haeckel began his publications in 1862, and in two enormous, abundantly illustrated, systematic works, besides minor publications, has dealt exhaustively with the cytology, classification, and distribution of the class. Next in value come the contributions of Richard Hertwig (largely developmental), besides those of L. Cienkowsky, Karl Brandt and A. Borgert, while to F. Dreyer and V. Häcker we owe valuable studies on the physical relations of the skeleton.

Our classification is taken from Haeckel.

A. Spumellaria, Haeck. (*Peripylaea*, Hertwig). Central capsule perforated with numerous evenly distributed pores. Skeleton siliceous, latticed or of detached spicules, or absent. Form homaxonic or with at least three planes of symmetry intersecting at right angles, rarely irregular or spiral, sometimes forming colonies, *i.e.* with several central capsules in a common external cytoplasm.

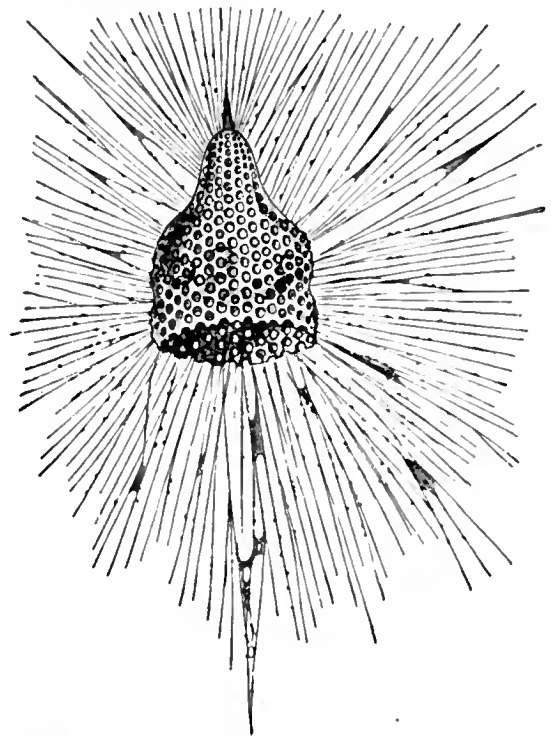

FIG. II.—*Eucyrtidium cranioides*, Haeck.; $\times 150$; one of the Nassellaria. Entire animal as seen in the living condition. The central capsule is hidden by the beehive-shaped siliceous shell within which it is lodged.

I. Skeleton of detached spicules, or absent.

Fam. 1. COLLOIDEA. Skeleton absent. *Thalassicolla*, Huxl. (figs. I. and III. 1); *Thalassophysa*, Haeck.; *Collozoum*, Haeck. (fig. III. 2-5, 15, 16); *Actissa*, Haeck.

Fam. 2. BELOIDEA. Skeleton spicular. *Sphaerouzoum*, Haeck.; *Raphidozoum*, Haeck.

II. Skeleton latticed or spongy-reticulate.

Fam. 3. SPIHAEROIDEA. Skeleton homaxial, sometimes colonial. *Collosphaera*, Mull.; *Haliomma*, Ehrb.; *Actinomma*, Haeck. (fig. III. 17), showing concentric latticed shells, the smallest intranuclear, all connected by radial spines; *Spongospaera*, Haeck. (fig. IV. 8); *Heliosphaera*, Haeck. (fig. III. 14).

Fam. 4. PRUNOIDEA. Skeleton a prolate spheroid or cylinder of circular section, sometimes constricted like a dice-box.

Fam. 5. DISCOIDEA. Shell flattened, of circular plan, rarely becoming spiral.

Fam. 6. LARCOIDEA. Shell with three unequal axes, elliptical in the plane of any two, more rarely becoming irregular or spiral.

B. Acantharia, Haeck. (*Actipylaea*, Hertw.). Skeleton of spicules of acanthin radiating from a centre, and usually twenty,

disposed on five successive zones of four on alternating meridians, the zones corresponding to equator, tropics and circumpolar circles on the globe; pores of central capsule in scattered groups.

Fam. 1. ACTINELIDA. Spines numerous, more than twenty, irregularly grouped. *Litholophus*, Haeck.; *Xiphacantha*, Haeck.

Fam. 2. ACANTHONIDA. Spines twenty, simple, usually equal. *Acanthometra*, J. Müll. (fig. iv. 6, 7); *Astrolonche*, Haeck.; *Amphilonche*, Haeck. (fig. iii. 18).

Fam. 3. SPHAEROPHRACTIDA: Spines equal, branching and often coalescing into a latticed shell, homaxonic.

Fam. 4. PRUNOPHRACTIDA: Branching spines coalescing into a latticed shell which is elongated and elliptical in at least one plane.

C. *Nassellaria*, Haeck. (*Monopylaea*, Hertw.). Silico-skeletal Radiolaria in which the central capsule is typically monaxonic (cone-shaped), with a single perforate area (pore-plate) placed on the basal face of the cone; the membrane of the capsule, the nucleus single; the skeleton is extracapsular, and forms a scaffold-like or beehive-like structure of monaxonic form, a tripod or calthrop, a sagittal ring, or a combination of these.

Fam. 1. NASSOIDEA, Haeck. Skeleton absent. *Cystidium*, Haeck.

Fam. 2. PLECTIDA, Haeck. Skeleton formed of a single branching spicule, a tripod or usually a 4-radiate calthrop, its branches sometimes reticulate. Genera: *Plagiacantha*, Haeck.; *Plegmatium*, Haeck.

Fam. 3. SPYROIDEA. Shell latticed around the sagittal ring ("cephalis"), sometimes with a lower chamber added.

Fam. 4. BOTRIDEA, Haeck. Shell latticed, composed of several chambers agglomerated without definite order; a single central capsule. Genera: *Botryocytis*, Haeck.; *Lithobotrys*, Haeck.

Fam. 5. CYRTOIDEA, Haeck. Skeleton a monaxonic or triradiate shell, or continuous piece (beehive-shaped). Genera: *Halicalyptra*, Haeck.; *Eucyrtidium*, Haeck. (fig. ii.); *Carpocanium*, Haeck. (fig. iv. 3).

Fam. 6. STEPHOIDEA, Haeck. Skeleton a sagittal ring continuous with the branched spicule, and sometimes growing out into other rings or branches. Genera: *Acanthodesmia*, Haeck.; *Zygothephanus*, Haeck.; *Lithocircus*, Haeck. (fig. iv. 1).

D. *Phaeodaria*, Haeck. (*Tripylaea*, Hertw.). Radiolaria of cruciate symmetry, prolonged into tubular processes with three oscula to the central capsule, one inferior, the principal, and two symmetrically placed on either side of the opposite pole; skeleton of spicules, a network of hollow filaments, or a minutely alveolate shell, of a combination of silica with organic substance; extracapsular protoplasm containing in front of the large oscule an agglomeration of dusky purplish or greenish pigment ("phaeodium").

Fam. 1. PHAEOCYSTIDA, Haeck. Siliceous skeleton absent or of separate needles. Genera: *Aulacantha*, Haeck.; *Thalassoplancta*, Haeck.

Fam. 2. PHAEOSPHAERIDA. Spicules united into a latticed shell. Genera: *Aulosphaera*, Haeck. (fig. iv. 9); *Auloplegma*, Haeck.; *Cannacantha*, Haeck.

Fam. 3. PHAEOGROMIDA, Haeck. Shell continuous, traversed by fine canals or finely alveolate, provided with at least one pylome. Genera: *Challengeria*, Wyv., Thomson; *Lithogromia*, Haeck.

Fam. 4. PHAEOCONCHIDA. Shell as in Phaeosphaerida, but of two symmetrical halves (valves), which meet in the plane of the three oscules ("frontal" of Haeckel, who terms the plane of symmetry through the shells "sagittal"). Genera: *Conchidium*, Haeck.; *Coelodendrum*, Haeck. (fig. iv. 4).

The following passages may be repeated here from Sir E. Ray Lankester's article "Protozoa" in the 9th edition of this Encyclopaedia:—

"The important differences in the structure of the central capsule of different Radiolaria were first shown by Hertwig, who also discovered that the spines of the Acanthometridae consist not of silica but of an organic compound (but see above). In view of this latter fact and of the peculiar numerical and architectural features of the Acanthometrid skeleton, it seems proper to separate them altogether from the other Radiolaria. The Periphyllaea may be regarded as the starting-point of the Radiolarian pedigree, and have given rise on the one hand to the Acanthometridae, which

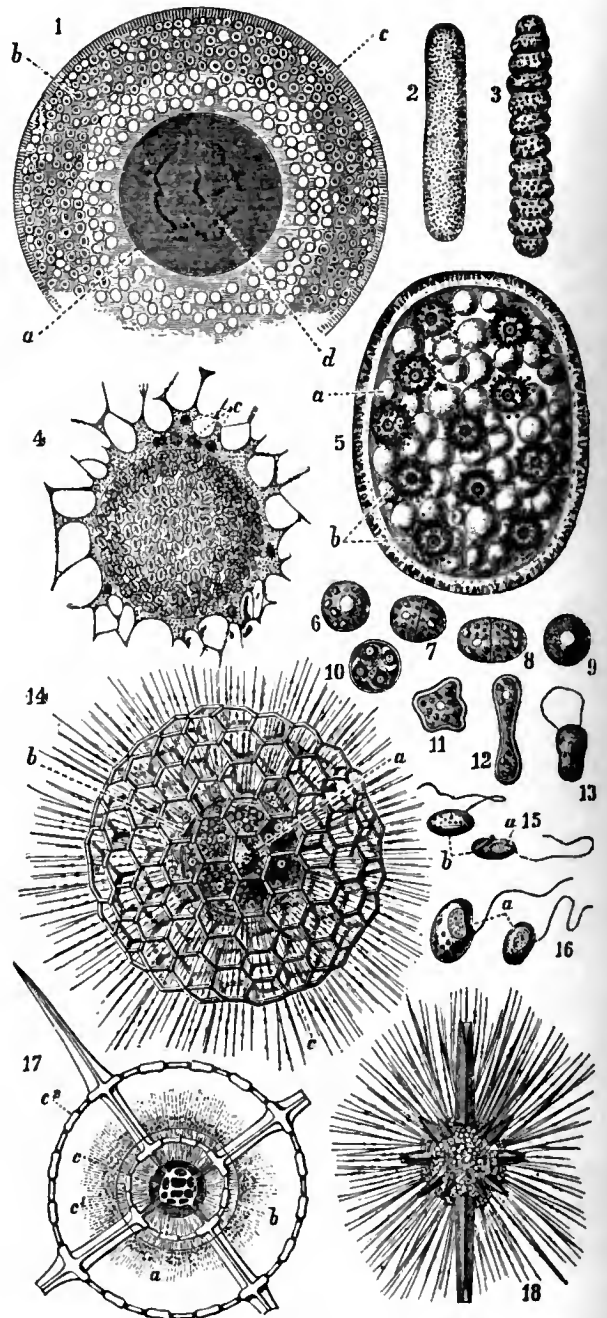
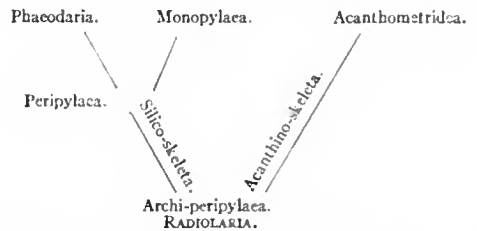

FIG. III.—Radiolaria. 1. Central capsule of *Thalassicolla nucleata*, Huxley, in radial section. *a*, the large nucleus (Binnenbläschen); *b*, corpuscular structures of the intracapsular protoplasm containing concretions; *c*, wall of the capsule (membranous shell), showing the fine radial pore-canals; *d*, nucleolar fibres (chromatin substance) of the nucleus. 2, 3. *Collozoum inerme*, J. Müller, two different forms of colonies, of the natural size. 4. Central capsule from a colony of *Collozoum inerme*, showing the intracapsular protoplasm and nucleus, broken up into a number of spores, the germs of swarm-spores or flagellulae; each encloses a crystalline rod. *c*, yellow cells lying in the extracapsular protoplasm. 5. A small colony of *Collozoum inerme*, magnified 25 diameters. *a*, alveoli (vacuoles) of the extracapsular protoplasm; *b*, central capsules, each containing besides protoplasm a large oil-globule. 6-13. Yellow cells of various Radiolaria: 6, normal yellow cell; 7, 8, division with formation of transverse septum; 9, a modified condition according to Brandt; 10, division of a yellow cell into four; 11, amoeboid condition of a yellow cell from the body of a dead Sphaerozoon; 12, a similar cell in process of division; 13, a yellow cell the protoplasm of which is creeping out of its cellulose envelope. 14. *Heliosphaera inermis*, Haeck., living example; $\times 400$. *a*, nucleus; *b*, central capsule; *c*, siliceous basket-work skeleton. 15. Two swarm-spores (flagellulae) of *Collozoum inerme*, set free

from such a central capsule as that drawn in 4; each contains a crystal *b* and a nucleus *a*. 16. Two swarm-spores of *Collozoum inerme*, of the second kind, viz. devoid of crystals, and of two sizes, a macrospore and a microspore. They have been set free from central capsules with contents of a different appearance from that drawn in 4. *a*, nucleus. 17. *Actinomma asteracanthion*, Haeck.; $\times 260$; one of the Peripylaea. Entire animal in optical section. *a*, nucleus; *b*, wall of the central capsule; *c*, innermost siliceous shell enclosed in the nucleus; *c*¹, middle shell lying within the central capsule; *c*², outer shell lying in the extracapsular protoplasm. Four radial siliceous spines holding the three spherical shells together are seen. The radial fibrillation of the protoplasm and the fine extracapsular pseudopodia are to be noted. 18. *Amphilonche messanensis*, Haeck.; $\times 200$; one of the Acanthometridea. Entire animal as seen living.

of the protoplasmic body, *a*, the tri-lobed nucleus; *b*, the siliceous shell; *c*, oil-globules; *d*, the perforate area (pore-plate) of the central capsule. 4. *Coelodendrum gracillimum*, Haeck.; living animal, complete; one of the Tripylaea. *a*, the characteristic dark pigment (phaeodium) surrounding the central capsule *b*. The peculiar branched siliceous skeleton, consisting of hollow fibres, and the expanded pseudopodia are seen. 5. Central capsule of one of the Tripylaea, isolated, showing *a*, the nucleus; *b*, *c*, the inner and the outer laminae of the capsule wall; *d*, the chief or polar aperture; *e*, *e*, the two secondary apertures. 6, 7. *Acanthometra claparedei*, Haeck. 7 shows the animal in optical section, so as to exhibit the characteristic meeting of the spines at the central point as in all Acanthometridea; 6 shows the transition from the uninuclear to the multinuclear condition by the breaking up of the large nucleus. *a*, small nuclei; *b*, large fragments of the single nucleus; *c*, wall of the central capsule; *d*, extracapsular jelly (not protoplasm); *e*, peculiar intracapsular yellow cells. 8. *Spongosphaera streptacantha*, Haeck.; one of the Peripylaea. Siliceous skeleton not quite completely drawn on the right side. *a*, the spherical extracapsular shell (compare fig. III. 17), supporting very large radial spines which are connected by a spongy network of siliceous fibres. 9. *Aulosphaera elegantissima*, Haeck.; one of the Phaeodaria. Half of the spherical siliceous skeleton.

retain the archaic structure of the central capsule whilst developing a peculiar skeleton, and on the other hand to the Monopylaea and Phaeodaria, which have modified the capsule but retained the siliceous skeleton.



"The occasional total absence of any siliceous or acanthinous skeleton does not appear to be a matter of classificatory importance, since skeletal elements occur in close allies of those very few forms which are totally devoid of skeleton. Similarly it does not appear to be a matter of great significance that some forms (Polycyttaria) form colonies, instead of the central capsules separating from one another after fission has occurred.

"It is important to note that the skeleton of silex or acanthin does not correspond to the shell of other Sarcodina, which appears rather to be represented by the membranous central capsule. The skeleton does, however, appear to correspond to the spicules of Heliozoa, and there is an undeniable affinity between such a form as Clathrulina and the Sphaerid Peripylaea (such as Heliosphaera, fig. III. 14). The Radiolaria are, however, a very strongly marked group, definitely separated from all other Sarcodina by the membranous central capsule sunk in their protoplasm. Their differences *inter se* do not affect their essential structure. The variations in the chemical composition of the skeleton and in the perforation of the capsule do not appear superficially. The most obvious features in which they differ from one another relate to the form and complexity of the skeleton, a part of the organism so little characteristic of the group that it may be wanting altogether. It is not known how far the form-species and form-genera which have been distinguished in such profusion by Haeckel as the result of a study of the skeletons are permanent (*i.e.* relatively permanent) physiological species. There is no doubt that very many are local and conditional varieties, or even merely stages of growth, of a single Protean species. The same remark applies to the species discriminated among the shell-bearing Reticularia. It must not be supposed, however, that less importance is to be attached to the distinguishing and recording of such forms because we are not able to assert that they are permanent species.

"The streaming of the granules of the protoplasm has been observed in the pseudopodia of Radiolaria as in those of Heliozoa and Reticularia; it has also been seen in the deeper protoplasm; and granules have been definitely seen to pass through the pores of the central capsule from the intracapsular to the extracapsular protoplasm. A feeble vibrating movement of the pseudopodia has been occasionally noticed.

"The production of swarm-spores has been observed only in Acanthometra and in the Polycyttaria and Thalassicollidae, and only in the two latter groups have any detailed observations been made. Two distinct processes of swarm-spore production have been observed by Cienkowski, confirmed by Hertwig,—distinguished by the character of the resulting spores, which are called 'crystaligerous' and 'isospores' (fig. III. 15) in the one case, and 'dimorphous' or 'anisospores' in the other (fig. III. 16). In both processes the nucleated protoplasm within the central capsule breaks up by a more or less regular cell-division into small

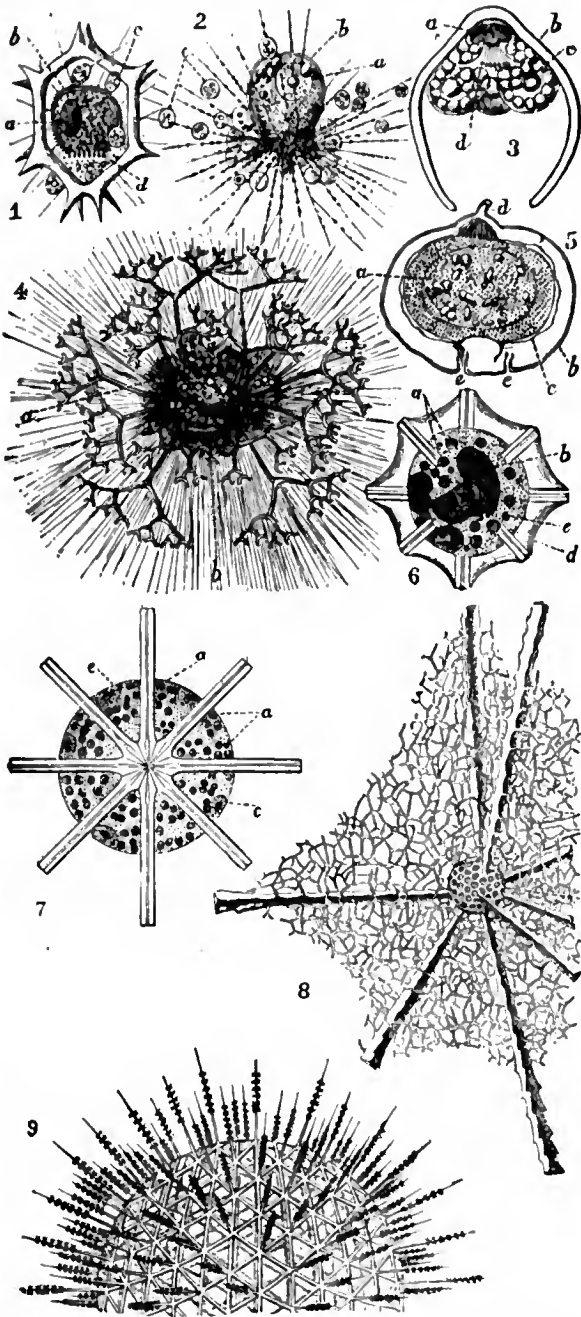

FIG. IV.—Radiolaria. 1. *Lithocircus annularis*, Hertwig; one of the Monopylaea. Whole animal in the living state (optical section); *a*, nucleus; *b*, wall of the central capsule; *c*, yellow cells; *d*, perforated area of the central capsule (Monopylaea). 2. *Cystidium inerme*, Hertwig; one of the Monopylaea. Living animal. An example of a Monopylaea destitute of skeleton. *a*, nucleus; *b*, capsule-wall; *c*, yellow cells in the extracapsular protoplasm. 3. *Carpacantium diadema*, Haeck.; optical section of the beehive-shaped shell to show the form and position

pieces, the details of the process differing a little in the two cases. In those individuals which produce crystalligerous swarm-spores, each spore encloses a small crystal (fig. 111. 15). On the other hand, in those individuals which produce dimorphous swarm-spores, the contents of the capsule (which in both instances are set free by its natural rupture) are seen to consist of individuals of two sizes, 'megaspores' and 'microspores,' neither of which contain crystals (fig. 111. 16). The further development of the spores has not been observed in either case. Both processes have been observed in the same species, and it is suggested that there is an alternation of sexual and asexual generations, the crystalligerous spores developing directly into adults, which in their turn produce in their central capsules dimorphous swarm-spores (megaspores and microspores), which in a manner analogous to that observed in the Volvocinean Flagellata copulate (permanently fuse) with one another (the larger with the smaller) before proceeding to develop. The adults resulting from this process would, it is suggested, produce in their turn crystalligerous swarm-spores. Unfortunately we have no observations to support this hypothetical scheme of a life-history.

"Fusion or conjugation of adult Radiolaria, whether preliminary to swarm-spore-production or independently of it, has not been observed—this affording a distinction between them and Heliozoa.

"Simple fission of the central capsule of adult individuals, preceded of course by nuclear fission, and subsequently of the whole protoplasmic mass, has been observed in several genera of Acantharia and Phaeodaria, and is probably a general method of reproduction in the group. In Spumellaria it gives rise to colonial 'Polycyttarian' forms when the extracapsular protoplasm does not divide.

"The siliceous shells of the Radiolaria are found abundantly in certain rocks from Palaeozoic times onwards. They furnish, together with Diatoms and Sponge spicules, the silica which has been segregated as flint in the Chalk formation. They are present in quantity (as much as 10%) in the Atlantic ooze, and in the celebrated 'Barbados earth' (a Tertiary deposit) are the chief components."

BIBLIOGRAPHY.—The most important systematic works are those of E. Haeckel, *Die Radiolarien* (1862-87), and the "Report" on the Radiolaria of the "Challenger" Expedition (vol. xviii., 1887), which contains full lists of the older literature. Among the most important recent studies we cite K. Brandt, "Die Koloniebildenden Radiolarien" in *Fauna and Flora des Golfes von Neapel*, xii. (1885); A. Borgert in *Zeitschrift f. Wissenschaftliche Zoologie*, li. (1891), and *Zoologische Jahrbücher (Anatomie)*, xiii. (1900); F. Dreyer in *Jenaischer Zeitschr.*, xix. (1892); V. Häcker in *Zeitsch. f. Wiss. Zool.*, lxxxiii. (1905). (M. HA.)

RADIOMETER. It had been remarked at various times, amongst others by Fresnel, that bodies delicately suspended within a partial vacuum are subject to apparent repulsion by radiation. The question was definitely investigated by Sir W. Crookes, who had found that some delicate weighings *in vacuo* were vitiated by this cause. It appeared that a surface blackened so as to absorb the radiant energy directed on it was repelled relatively to a polished surface. He constructed an apparatus in illustration, which he called a *radiometer* or *light-mill*, by pivoting a vertical axle carrying equidistant vertical vanes inside an exhausted glass bulb, one side of each vane being blackened and the other side bright, the blackened sides all pointing the same way round the axle. When the rays of the sun or a candle, or dark radiation from a warm body, are incident on the vanes, the dark side of each vane is repelled more than the bright side, and thus the vanes are set into rotation with accelerated speed, which becomes uniform when the forces produced by the radiation are balanced by the friction of the pivot and of the residual air in the globe. The name radiometer arose from an idea that the final steady speed of rotation might be utilized as a rough measure of the intensity of the exciting radiation.

The problem of the cause of these striking and novel phenomena at first produced considerable perplexity. A preliminary question was whether the mechanical impulsion was a direct effect of the light, or whether the radiation only set up internal stresses, acting in and through the residual air, between the vanes and the walls of the enclosure. The answer to this was found experimentally by Arthur Schuster, who suspended the whole instrument in delicate equilibrium, and observed the effect of introducing the radiation. If the light exerted direct impulsion on the vanes, their motion would gradually drag the case round after them, by reason of the friction of the residual air in the bulb and of the pivot. On the other

hand, if the effects arose from balanced stresses set up inside the globe by the radiation, the effects on the vanes and on the case would be of the nature of action and reaction, so that the establishment of motion of the vanes in one direction would involve impulsion of the case in the opposite direction; but when the motion became steady there would no longer be any torque either on the vanes or on the case, and the latter would therefore come back to its previous position of equilibrium; finally, when the light was turned off, the decay of the motion of the vanes would involve impulsion of the case in the direction of their motion until the moment of the restoring torque arising from the suspension of the case had absorbed the angular momentum in the system. Experiment showed that the latter prediction was what happened. The important part played by the residual air in the globe had also been deduced by Osborne Reynolds from observing that on turning off the light, the vanes came to rest very much sooner than the friction of the pivot alone would account for; in fact, the rapid subsidence is an illustration of Maxwell's great theoretical discovery that viscosity in a gas (as also diffusion both of heat and of the gas itself) is sensibly independent of the density. Some phenomena of retardation in the production of the effect had led Sir G. G. Stokes and Sir W. Crookes to the same general conclusion.

The origin of these phenomena was recognized, among the first by O. Reynolds, and by P. G. Tait and J. Dewar, as a consequence of the kinetic theory of the constitution of gaseous media. The temperature of a gas is measured by the mean energy of translation of its molecules, which are independent of each other except during the brief intervals of collision; and collision of the separate molecules with the blackened surface of a vane, warmed by the radiation, imparts heat to them, so that they rebound from it with greater velocity than they approached. This increase of velocity implies an increase of the reaction on the surface, the black side of a vane being thus pressed with greater force than the bright side. In air of considerable density the mean free path of a molecule, between its collisions with other molecules, is exceedingly small, and any such increase of gaseous pressure in front of the black surface would be immediately neutralized by flow of the gas from places of high to places of low pressure. But at high exhaustions the free path becomes comparable with the dimensions of the glass bulb, and this equalization proceeds slowly. The general nature of the phenomena is thus easily understood; but it is at a maximum at pressures comparable with a millimetre of mercury, at which the free path is still small, the greater number of molecules operating in intensifying the result. The problem of the stresses in rarefied gaseous media arising from inequalities of temperature, which is thereby opened out, involves some of the most delicate considerations in molecular physics. It remains practically as it was left in 1879 by two memoirs communicated to the *Phil. Trans.* by Osborne Reynolds and by Clerk Maxwell. The method of the latter investigator was purely a priori. He assumed that the distribution of molecules and of their velocities, at each point, was slightly modified, from the exponential law belonging to a uniform condition, by the gradient of temperature in the gas (see DIFFUSION). The hypothesis that the state was steady, so that interchanges arising from convection and collisions of the molecules produced no aggregate result, enabled him to interpret the new constants involved in this law of distribution, in terms of the temperature and its spacial differential coefficients, and thence to express the components of the kinetic stress at each point in the medium in terms of these quantities. As far as the order to which he carried the approximations—which, however, were based on a simplifying hypothesis that the molecules influenced each other through mutual repulsions inversely as the fifth power of their distance apart—the result was that the equations of motion of the gas, considered as subject to viscous and thermal stresses, could be satisfied by a state of equilibrium under a modified internal pressure equal in all directions. If, therefore, the walls of the enclosure held

the gas that is directly in contact with them, this equilibrium would be the actual state of affairs; and it would follow from the principle of Archimedes that, when extraneous forces such as gravity are not considered, the gas would exert no resultant force on any body immersed in it. On this ground Maxwell inferred that the forces acting in the radiometer are connected with gliding of the gas along the unequally heated boundaries; and as the laws of this slipping, as well as the constitution of the adjacent layer, are uncertain, the problem becomes very intricate. Such slipping had shown itself at high exhaustions in the experiments of A. A. Kundt and E. G. Warburg in 1875 on the viscosity of gases; its effects would be corrected for, in general, by a slight effective addition to the thickness of the gaseous layer.

Reynolds, in his investigation, introducing no new form of law of distribution of velocities, uses a linear quantity, proportional to the mean free path of the gaseous molecules, which he takes to represent (somewhat roughly) the average distance from which molecules directly affect, by their convection, the state of the medium; the gas not being uniform on account of the gradient of temperature, the change going on at each point is calculated from the elements contributed by the parts at this particular distance in all directions. He lays stress on the dimensional relations of the problem, pointing out that the phenomena which occur with large vanes in highly rarefied gas could also occur with proportionally smaller vanes in gas at higher pressure. The results coincide with Maxwell's so far as above stated, though the numerical coefficients do not agree. According to Maxwell, priority in showing the necessity for slipping over the boundary rests with Reynolds, who also discovered the cognate fact of thermal transpiration, meaning thereby that gas travels up the gradient of temperature in a capillary tube, owing to surface-actions, until it establishes such a gradient of pressure (extremely minute) as will prevent further flow. In later memoirs Reynolds followed up this subject by proceeding to establish definitions of the velocity and the momentum and the energy at an element of volume of the molecular medium, with the precision necessary in order that the dynamical equations of the medium in bulk, based in the usual manner on these quantities alone, without directly considering thermal stresses, shall be strictly valid—a discussion in which the relation of ordinary molar mechanics to the more complete molecular theory is involved.

Of late years the peculiarities of the radiometer at higher gas-pressures have been very completely studied by E. F. Nichols and G. F. Hull, with the result that there is a certain pressure at which the molecular effect of the gas on a pair of nearly vertical vanes is balanced by that of convection currents in it. By thus controlling and partially eliminating the aggregate gas-effect, they succeeded in making a small radiometer, horizontally suspended, into a delicate and reliable measurer of the intensity of the radiation incident on it. With the experience thus gained in manipulating the vacuum, the achievement of thoroughly verifying the pressure of radiation on both opaque and transparent bodies, in accordance with Clerk Maxwell's formula, has been effected (*Physical Review*, 1901, and later papers) by E. F. Nichols and G. F. Hull; some months earlier Lebedew had published in the *Annalen der Physik* a verification for metallic vanes so thin as to avoid the gas-action, by preventing the production of sensible difference of temperature between the two faces by the incident radiation. (See RADIATION.)

More recently J. H. Poynting has separated the two effects experimentally on the principle that the radiometer pressure acts along the normal, while the radiation pressure acts along the ray which may be directed obliquely. (J. L. *)

RADISH, *Raphanus sativus* (nat. order Cruciferae), in botany, a fleshy-rooted annual, unknown in the wild state. Some varieties of the wild radish, *R. Raphanistrum*, however, met with on the Mediterranean coasts, come so near to it as to suggest that it may possibly be a cultivated race of the same species. It is very popular as a raw salad. There are

two principal forms, the spindle-rooted and the turnip-rooted.

The radish succeeds in any well-worked not too heavy garden soil, but requires a warm, sheltered situation. The seed is generally sown broadcast, in beds 4 to 5 ft. wide, with alleys between, the beds requiring to be netted over to protect them from birds. The earliest crop may be sown about the middle of December, the seed-beds being at once covered with litter, which should not be removed till the plants come up, and then only in the daytime, and when there is no frost. If the crop succeeds, which depends on the state of the weather, it will be in use about the beginning of March. Another sowing may be made in January, a third early in February, if the season is a favourable one, and still another towards the end of February, from which time till October a small sowing should be made every fortnight or three weeks in spring, and rather more frequently during summer. About the end of October, and again in November, a late sowing may be made on a south border or bank, the plants being protected in severe weather with litter or mats. The winter radishes, which grow to a large size, should be sown in the beginning of July and in August, in drills from 6 to 9 in. apart, the plants being thinned out to 5 or 6 in. in the row. The roots become fit for use during the autumn. For winter use they should be taken up before severe frost sets in, and stored in dry sand. Radishes, like other fleshy roots, are attacked by insects, the most dangerous being the larvae of several species of fly, especially the radish fly (*Anthomyia radicum*). The most effectual means of destroying these is by watering the plants with a dilute solution of carbolic acid, or much diluted gas-water; or gas-lime may be sprinkled along the rows.

Forcing.—To obtain early radishes a sowing in the British Isles should be made about the beginning of November, and continued fortnightly till the middle or end of February; the crop will generally be fit for use about six weeks after sowing. The seed should be sown in light rich soil, 8 or 9 in. thick, on a moderate hotbed, or in a pit with a temperature of from 55° to 65°. Gentle waterings must be given, and air admitted at every favourable opportunity; but the sashes must be protected at night and in frosty weather with straw mats or other materials. Some of these crops are often grown with forced potatoes. The best forcing sorts are Wood's early frame, and the early rose globe, early dwarf-top scarlet turnip, and early dwarf-top white turnip.

Those best suited for general cultivation are the following:—*Spindle-rooted*.—Long scarlet, including the sub-varieties scarlet short-top, early frame scarlet, and Wood's early frame; long scarlet short-top, best for general crop.

Turnip-rooted.—Early rose globe-shaped, the earliest of all; early dwarf-top scarlet turnip, and early dwarf-top white turnip; earliest Erfurt scarlet, and early white short-leaved, both very early sorts; French breakfast, olive-shaped; red turnip and white turnip, for summer crops.

Winter sorts.—Black Spanish, white Chinese, Californian mammoth.

RADIUM (from Lat. *radius*, ray), a metallic chemical element obtained from pitchblende, a uranium mineral, by P. and Mme. Curie and G. Bémont in 1898; it was so named on account of the intensity of the radioactive emanations which it yielded. Its discovery was a sequel to H. Becquerel's observation in 1896 that certain uranium preparations emitted a radiation resembling the X rays observed by Röntgen in 1895. Like the X rays, the Becquerel rays are invisible; they both traverse thin sheets of glass or metal, and cannot be refracted; moreover, they both ionize gases, *i.e.* they discharge a charged electroscope, the latter, however, much more feebly than the former. Characteristic, also, is their action on a photographic plate, and the phosphorescence which they occasion when they impinge on zinc sulphide and some other salts. Notwithstanding these resemblances, these two sets of rays are not identical. Mme. Curie, regarding radioactivity—*i.e.* the emission of rays like those just mentioned—as a property of some undiscovered substance, submitted pitchblende to a most careful analysis. After removing the uranium, it was found that the bismuth separated with a very active substance—polonium; this element was afterwards isolated by Marckwald, and proved to be identical with his radiotellurium; that the barium could be

separated with another active substance—radium; whilst a third fraction, composed mainly of the rare earths (thorium, &c.), yielded to Debierne another radioactive element—actinium, which proved to be identical with the emanium of Giesel. Another radioactive substance—ionium—was isolated from carnotite, a uranium mineral, by B. B. Boltwood in 1905. Radioactive properties have also been ascribed to other elements, e.g. thorium and lead. There is more radium than any other radioactive element, but its excessive rarity may be gauged by the facts that Mme. Curie obtained only a fraction of a gramme of the chloride and Giesel 0.2 to 0.3 gramme of the bromide from a ton of uranium residues.

There is a mass of evidence to show that radium is to be regarded as an element, and in general its properties resemble those of the metals of the alkaline earths, more particularly barium. To the bunsen flame a radium salt imparts an intense carmine-red colour (barium gives a green). The spectrum, also, is very characteristic. The atomic weight, 226.4, places the element in a vacant position in group II. of the periodic classification, along with the alkaline earth metals.

Generally speaking, the radiation is not simple. Radium itself emits three types of rays: (1) the α rays, which are regarded as positively charged helium atoms; these rays are stopped by a single sheet of paper; (2) the β rays, which are identified with the cathode rays, i.e. as a single electron charged negatively; these rays can penetrate sheets of aluminium, glass, &c., several millimetres thick; and (3) the γ rays—which are non-electrified radiations characterized by a high penetrating power, 1% surviving after traversing 7 cm. of lead or 150 cm. of water. In addition, radium evolves an "emanation" which is an extraordinarily inert gas, recalling the "inactive" gases of the atmosphere. We thus see that radium is continually losing matter and energy as electricity; it is also losing energy as heat, for, as was observed by Curie and Laborde, the temperature of a radium salt is always a degree or two above that of the atmosphere, and they estimated that a gramme of pure radium would emit about 100 gramme-calories per hour.

The Becquerel rays have a marked chemical action on certain substances. The Curies showed that oxygen was convertible into ozone, and Sudborough that yellow phosphorus gave the red modification when submitted to their influence. More interesting are the observations of D. Berthelot, F. Bordas, C. Doelter and others, that the rays induce important changes in the colours of many minerals. (See RADIOACTIVITY.)

The action of radium on human tissues was unknown until 1901, when, Professor Becquerel of Paris having incautiously carried a tube in his waistcoat pocket, there appeared on the skin within fourteen days a severe inflammation which was known as the famous "Becquerel burn." Since that time active investigation into the action of radium on diseased tissues has been carried on, resulting in the establishment in Paris in 1906 of the "Laboratoire biologique du Radium." Similar centres for study have been inaugurated in other countries, notably one in London in 1909. The diseases to which the application has been hitherto confined are papillomata, lupus vulgaris, epithelial tumours, syphilitic ulcers, pigmentary naevi, angiomas, and pruritus and chronic itching of the skin; but the use of radium in therapeutics is still experimental. The different varieties of rays used are controlled by the interposition of screens or filtering substances, such as silver, lead or aluminium. Radium is analgesic and bactericidal in its action.

See *Radiumtherapie*, by Wickham and Degrais (1909); *Die therapeutische Wirkung der Radiumstrahlen*, by O. Lassar, in *Report of Radiology Congress*, Brussels, 1906; E. Dorn, E. Baumann and S. Valentiner in *Physische Zeitung* (1905); Abbé in *Medical Record* (October 1907).

RADIUS, properly a straight rod, bar or staff, the original meaning of the Latin word, to which also many of the various meanings seen in English were attached; it was thus applied to the spokes of a wheel, to the semi-diameter of a circle or sphere and to a ray or beam of light, "ray" itself coming through the Fr. *raie* from *radius*. From this last sense comes

"radiant," "radiation," and allied words. In mathematics, a radius is a straight line drawn from the centre to the circumference of a circle or to the surface of a sphere; in anatomy the name is applied to the outer one of the two bones of the fore-arm in man or to the corresponding bone in the fore-leg of animals. It is also used in various other anatomical senses in botany, ichthyology, entomology, &c. A further application of the term is to an area the extent of which is marked by the length of the radius from the point which is taken as the centre; thus, in London, for the purpose of reckoning the fare of hackney-carriages, the radius is taken as extending four miles in any direction from Charing Cross.

RADNOR, EARLS OF. The 1st earl of Radnor was John Robartes (1606–1685), who succeeded his father, Richard Robartes, as 2nd baron Robartes of Truro in May 1634, the barony having been purchased under compulsion for £10,000 in 1625. The family had amassed great wealth by trading in tin and wool. Educated at Exeter College, Oxford, John Robartes fought on the side of the Parliament during the Civil War, being present at the battle of Edgehill and at the first battle of Newbury, and was a member of the committee of both kingdoms. He is said to have persuaded the earl of Essex to make his ill-fated march into Cornwall in 1644; he escaped with the earl from Lostwithiel and was afterwards governor of Plymouth. Between the execution of Charles I. and the restoration of Charles II. he took practically no part in public life, but after 1660 he became a prominent public man, owing his prominence partly to his influence among the Presbyterians, and ranged himself among Clarendon's enemies. He was lord deputy of Ireland in 1660–1661 and was lord lieutenant in 1669–1670; from 1661 to 1673 he was lord privy seal, and from 1679 to 1684 lord president of the council. In 1679 he was created viscount Bodmin and earl of Radnor, and he died at Chelsea on the 17th of July 1685. His eldest son, Robert, viscount Bodmin, who was British envoy to Denmark, having predeceased his father, the latter was succeeded as 2nd earl by his grandson, Charles Bodvile Robartes (1660–1723), who was a member of parliament under Charles II. and James II., and was lord lieutenant of Cornwall from 1696 to 1705 and again from 1714 to 1723. Henry, the 3rd earl (c. 1690–1741), was also a grandson of the 1st earl, and John, the 4th earl (c. 1686–1757), was another grandson. When John, whose father was Francis Robartes (c. 1650–1718), a member of parliament for over thirty years and a musician of some repute, died unmarried in July 1757, his titles became extinct.

Lanhydrock, near Bodmin, and the other estates of the Robartes family passed to the earl's nephews, Thomas and George Hunt. Thomas Hunt's grandson and heir, Thomas James Agar-Robartes (1808–1882), a grandson of an Irish peer, James Agar, 1st viscount Clifden (1734–1789), was created baron Robartes of Lanhydrock and of Truro in 1869, after having represented East Cornwall in seven parliaments. His son and successor, Thomas Charles Agar-Robartes, the 2nd baron (b. 1844), succeeded his kinsman as 6th viscount Clifden in 1899.

In 1765 William Bouverie, 2nd viscount Folkestone (1725–1776), son of Sir Jacob Bouverie, bart. (d. 1761), of Longford, Wiltshire, who was created viscount Folkestone in 1747, was made earl of Radnor. Descended from a Huguenot family, William Bouverie was a member of parliament from 1747 until he succeeded to the peerage in February 1761. He died on the 28th of January 1776. His son and successor, Jacob, the 2nd earl (1750–1828), who took the name of Pleydell-Bouverie in accordance with the will of his maternal grandfather, Sir Mark Stuart Pleydell, bart. (d. 1768), was the father of William Pleydell-Bouverie, the 3rd earl (1779–1869), a politician of some note. In 1900 his great-grandson, Jacob Pleydell-Bouverie (b. 1868), became 6th earl of Radnor.

RADNORSHIRE (Sir Facyfyed), an inland county of Wales, bounded N. by Montgomery, N.E. by Shropshire, E. by Hereford, S. and S.W. by Brecknock and N.W. by Cardigan. This county, which is lozenge-shaped, contains 471 sq. m., and is

consequently the smallest in area of the six South Welsh counties. Nearly the whole surface of Radnorshire is hilly or undulating, whilst the centre is occupied by the mountainous tract known as Radnor Forest, of which the highest point attains an elevation of 2163 ft. Towards the S. and S.E. the hills are less lofty, and the valleys broaden out into considerable plains abounding in rivulets. The hills for the most part present smooth, rounded outlines, and are covered with heather, bracken and short grass, though tracts of boggy soil in the uplands are not uncommon. There are rich pastures and numerous woods in the valleys of the Wye and Temc. The Wye Valley has long been celebrated for its beauty, while Radnor Forest and the wild district of Cwmdaiddwr present striking views of primeval and unspoiled scenery. Radnorshire is well supplied with water, its principal river being the Wye (Gwy), which, after crossing the N.W. corner of the county, forms its boundary from Rhayader onward to the English border. Salmon, trout and grayling are plentiful, and the Wye is consequently much frequented by anglers; as are also its tributaries—the Elan (which has been utilized for the great Birmingham reservoirs) the Ithon, the Edw or Edwy, the Lug, the Arrow and the Somergil. The Temc, which divides Radnor from Shropshire on the N.E., is a tributary of the Severn. All these streams are clear and rapid, and abound in fish. In the numerous rocky ravines of the mountainous districts are found many waterfalls, of which the most celebrated is "Water-break-its-Neck," to the W. of New Radnor. Omitting the artificially constructed reservoirs in the valleys of the Elan and Claerwen, the lakes of Radnorshire are represented only by a few pools of which Llynbychlyn near Painscastle is the largest.

Geology.—Ordovician rocks occupy most of the western side of the county, they are succeeded eastward by the Silurian formations, the Llandovery, Wenlock and Ludlow beds in the order here given. East of New Radnor an inlier of Wenlock rocks is surrounded by Ludlow beds; while at Old Radnor a ridge of very ancient rocks appears. In the south-east of the county Old Red Sandstone rests upon the Silurian. Between Llandrindod, where there are saline, sulphurous and chalybeate wells, and Builth, is a disturbed area of Ordovician strata with masses of andesitic and diabasic igneous rocks. In the vicinity of Rhayader the strata have been classed as the Rhayader pale shales (Tarannon), the Caban group (Upper Llandovery), the Gwastaden group (Lower Llandovery); these rest upon shales of Bala age.

Climate and Industries.—The climate of Radnorshire is bracing, if somewhat bleak, and the rainfall is not so heavy as in the neighbouring counties of Montgomery and Brecknock, but thick drizzling mists are of constant occurrence. The winters are often very severe, and deep snowfalls are not uncommon. Good hay and tolerable crops of cereals are raised in the valleys, and the margin of cultivation has risen considerably since 1880. The extensive upland tracts, which still cover over one-third of the total area of the county, afford pasturage for mountain ponies and for large flocks of sheep. The quality of the wool of Radnorshire has long been celebrated, and also the delicacy of the Welsh mutton of the small sheep that are bred in this county. The most important sheep fairs are held at Rhayader, which also contains some woollen factories. There are practically no mining industries, nor are the quarries of great value. The valley of the Wye is rich in medicinal springs, and the saline, sulphur and chalybeate waters of Llandrindod have long been famous and profitable, and are growing in popular esteem.

Communications.—The Central Wales branch of the London & North-Western railway enters the county at Knighton, traverses it by way of Llandrindod and passes into Brecknock at Builth Road Junction on the Wye. The Cambrian railway, after passing through the N.W. corner of the county to Rhayader, follows the course of the Wye, by way of Builth and Hay. Two small branch lines connect New Radnor and Presteign with the system of the Great Western.

Population and Administration.—The area of Radnorshire is 301,164 acres, and the population in 1801 was 21,701, while in 1901 it had risen to 23,362; an increase chiefly due to the immigration of outside labourers to the Elan Valley waterworks. There is no existing municipal borough, although New Radnor, now a mere village with 405 inhabitants (1901), was incorporated in 1561 and its municipal privileges were not formally abolished till 1883. The chief towns are Presteign (pop. 1245); Llandrindod (1827); Knighton (2139), and Rhayader (1215);

all, except Rhayader, being urban districts. Radnorshire is included in the South Wales circuit, and assizes are held at Presteign, which ranks as the county town. There is no existing parliamentary borough, and the whole county returns one member to parliament. Ecclesiastically, Radnorshire is divided into 46 parishes, of which 38 lie in the diocese of St Davids, and 8 in that of Hereford.

History.—The wild district of Maesyfed (a name of which the derivation is much disputed), corresponding substantially with the modern Radnorshire, originally formed part of the territory of the Silures, who were vanquished by the Romans. Christianity seems to have been introduced into this barren region during the 5th and 6th centuries by itinerant Celtic missionaries, notably by St David, St Padarn and St Cynllo. Towards the close of the 9th century Maesyfed was absorbed into the middle kingdom of Powys, and in the 10th century it was included in the realm of Elystan Glodrudd, prince of Fferlys, or Feryllwg, who ruled over all land lying between the Wye and Severn. In the reign of William the Conqueror, the Normans began to penetrate into Maesyfed, where, according to Domesday Book, the king already laid claim to Radenoure, or Radnor (a name of doubtful meaning), in the lordship of Melenith (Moelynaidd), which was subsequently bestowed on the Mortimer family, when castles were erected at Old Radnor (Penygraig), New Radnor and Cefnlllys. Later, the Norman invaders forced their way up the Wye Valley, the de Breos family, lords of Elvel (Elfael), building fortresses at Painscastle and at Colwyn or Maud's Castle. In 1188 Archbishop Baldwin, accompanied by Ranulf de Glanville and Giraldus Cambrensis, entered Wales for the purpose of preaching the Third Crusade, and was met in full state at New Radnor by the Lord Rhys, prince of South Wales. The Wye Valley long formed one of the debatable districts between Welsh and Normans, and in 1282 Llewelyn ap Griffith, prince of Wales, was at Aberedw shortly before his death in a skirmish near Builth. After the annexation of Wales by Edward I., the district of Maesyfed remained under the immediate jurisdiction of the Lords-Marchers, represented by the great families of Mortimer and Todeney. During the summer of 1402 Owen Glendower entered the Marches and raided the lands of the young Edward Mortimer, earl of March, whilst the royal troops were severely defeated at the battle of Bryn Gläs near Pilleth. By the Act of Union (1536) Maesyfed was erected out of the suppressed lordships into an English shire on the usual model. For administrative purposes it was now divided into six hundreds, and assizes were ordained to be held in alternate years at Presteign and New Radnor. The newly created county was likewise privileged to return two members to parliament; one for the county, and one for the united boroughs of New Radnor, Rhayader, Knighton, Cefnlllys and Knucklas (Cnwclas). The parliamentary district of the Radnor boroughs was, however, disfranchised and merged in the county representation under the act of 1885. The shire of Radnor with its immense tracts of sheep-walk, its absence of large towns and its sparse rural population has always been reckoned the poorest and least important of the Welsh counties, nor since its creation under Henry VIII. has it ever played a prominent part in the national life of Wales. During the Commonwealth the local clergy were made to suffer severely under the drastic administration of Vavasor Powell (1617-1670), himself a Radnorshire man as a native of Knucklas. Of recent years the rise of Llandrindod as a fashionable watering-place and the construction of the Birmingham reservoirs in the Elan Valley have tended to increase the material prosperity of the county.

Among the leading families of Radnorshire, may be mentioned Lewis of Harpton Court; Baskerville of Clyro; Thomas (formerly Jones) of Pencerrig; Lewis-Lloyd of Nantgwyllt; Gwynne of Llanellwedd, and Prickard of Dderw.

Antiquities.—Radnorshire contains numerous memorials of early British times, of which the entrenchment called Crug-y-buddair in the parish of Beguildy is specially worthy of note. Of Roman remains, the most important are those of the fortified camp at Cwm near Llandrindod, which is believed to be identical

with the military station of Magos or Magna. The course of Offa's Dyke (Clawdd Offa) is perceptible at various points in the hilly regions west of Knighton and Presteign. Very slight traces exist of the many castles erected at various times after the Norman invasion. The parish churches of Radnorshire are for the most part small and of rude construction, and many of them have been modernized or rebuilt. The churches at Old Radnor, Presteign and Llanbister, however, are interesting edifices, and a few possess fine oaken screens, as at Llananno and Llandegley. There was only one monastic house of consequence, the Cistercian abbey of St Mary, founded by Cadwallon ap Madoc in 1143 in "the long valley" of the Clywedog, six miles east of Rhayader, and from its site commonly called Abbey Cwm Hir. Its existing ruins are insignificant, but the proportions of the church, which was 238 ft. long, are still traceable. The modern mansion adjoining, known as Abbey Cwm Hir, was for some generations the residence of the Fowler family, once reputed the wealthiest in the county.

Customs, &c.—Although in most instances the old Celtic place-names survive throughout the western portion of the county, it is only in the wild remote districts of Cwmdauddwr and St Harmon's that the Welsh tongue predominates, and in this region some of the old Welsh superstitions linger amongst the peasants and shepherds of the hills. In the eastern part of the county English is spoken universally, and the manners and customs of the inhabitants differ little from those prevailing in the neighbouring county of Hereford. On the western side of Radnor Forest the modern spirit of progress has destroyed most of the old local customs. Until the beginning of the 19th century the ancient Welsh service of the *pylgain* on Christmas morning was observed in Rhayader church; and the same town was formerly remarkable for an interesting ceremony, evidently of great antiquity, whereat after a funeral each attendant mourner was wont to throw a stone upon a certain spot near the church with the words "Carn ar dy ben" (a stone on thy head). The laying of malicious sprites by means of lighted tapers was formerly practised in the churches of the Wye Valley; and a curious service, commemorative of the dead and known as "the Month's End," is still observed in certain parish churches, a month after the actual funeral has taken place. The practice of farmers and their wives or daughters riding to the local markets on ponies, the older women sometimes knitting as they proceed, still continues, and is specially characteristic of agricultural life in Radnorshire.

See *A General History of the County of Radnor* (compiled from the MS. of the late Rev. Jonathan Williams and other sources) (Brecknock, 1905).

RADOM, a government of Russian Poland, occupying a triangular space between the Vistula and Pilica, and bounded N. by the governments of Warsaw and Siedlce, E. by Lublin, S. by the crownland of Austrian Galicia and the Polish government of Kielce, and W. by that of Piotrków. The area is 4768 sq. m. Its southern part stretches over the well-wooded Sandomir heights, a series of short ranges of hills, 800 to 1000 ft. in altitude, intersected by deep valleys, which, running west and east and drained by tributaries of the Vistula, are excellently adapted for agriculture. In its central parts, the government is level, the soil fertile, and the surface, which is diversified here and there with wood, is broken up by occasional spurs (800 ft.) of the Lysa Góra Mountains. The northern districts consist of low, flat tracts with undefined valleys, exposed to frequent floods and covered over large areas with marshes; the basin of the Pilica, notorious for its unhealthiness, is throughout a low marshy plain. Devonian, Carboniferous, Permian and Triassic deposits appear in the south, Cretaceous and Jurassic in the middle, and Tertiary in the north. Extensive tracts are covered with Glacial deposits,—the Scandinavian erratics reaching as far south as Ilza; these last in their turn are overlain by widespread post-Glacial lacustrine deposits. The climate is cold and moist, the mean temperature for the year being 47°·5 Fabr., for January -5°·8, and for July 77°. The Vistula skirts the government on the south and east, and is

an important means of communication, steamers plying as far up as Sandomir (Sędziejewice). The Sandomir district suffers occasionally from disastrous inundations of the river. The tributaries of the Vistula are short and small, those of the Pilica are sluggish streams meandering amidst marshes. The estimated population in 1906 was 932,800. The government is divided into seven districts, the chief towns of which are Radom, Ilza, Konskie, Koziennice, Opatów, Opoczno and Sandomir. Out of the total area about 50% is under cultivation and 28% under forests. The principal crops are wheat, rye, barley, oats, buck-wheat, hemp, flax and potatoes, these last chiefly cultivated for distilleries. Grain is exported. Live stock is kept in large numbers. Manufactures have considerably developed of late years, the government being rich in iron ore, while coal and zinc occur, as also marble, gypsum, alabaster, potters' clay and red sandstone. The iron industry occupies more than 60,000 workmen, and turns out annually some 100,000 tons of pig iron, 25,000 tons of iron, and 550,000 tons of steel. There are several sugar-works, tanneries, flour-mills, machinery works, distilleries, breweries and brickworks. Trade is not very extensive, the only channel of commerce being the Vistula. (P. A. K., J. T. B.E.)

RADOM, a town of Russia, capital of the government of the same name, 100 m. by rail S. from Warsaw. Pop. 28,749, half of whom were Jews. It is one of the best built provincial towns of Poland. The church of St Wlclaw, contemporary with the foundation of the town, was transformed by the Austrians into a storehouse, and subsequently by the Russian government into a military prison. The old castle is in ruins, and the old Bernardine monastery is used as barracks. Radom has several iron and agricultural machinery works and tanneries. In 1216 it occupied the site of what is now Old Radom. New Radom was founded in 1340 by Casimir the Great, king of Poland. Here Jadwiga was elected queen of Poland in 1382, and here too in 1401 the first act relating to the union of Poland with Lithuania was signed; the *seim* or diet of 1505, where the organic law of Poland was sworn by the king, was also held at Radom. Several great fires, and still more the Swedish war of 1701-7, were the ruin of the old city. After the third partition of Poland in 1795 it fell under Austrian rule; it was in 1815 annexed to Russia, and became chief town of the province of Sandomir.

RADOMYSL, formerly MYCHEK, a town of Russia, in the government of Kiev, 31 m. W. of the city of Kiev, on the Teteriv river. Pop. 18,154. It is a very old town, being mentioned in 1150; from 1746 to 1795 it was the residence of the metropolitan of the United Greek Church. It has tanneries and flour-mills, and exports timber, corn and mushrooms.

RADOWITZ, JOSEPH MARIA VON (1797-1853), Prussian general and statesman, was born at Blankenburg in the Harz Mountains, his family being of Hungarian origin. As a young lieutenant in the Westphalian artillery he was wounded and taken prisoner at the battle of Leipzig (1813), subsequently entered the Hanoverian service, and in 1823 that of Prussia. His promotion was rapid, and in 1830 he became chief of the general staff of the artillery. In 1836 he went as Prussian military plenipotentiary to the federal diet at Frankfort, and in 1842 was appointed envoy to the courts of Carlsruhe, Darmstadt and Nassau. He had early become an intimate friend of the crown prince (afterwards King Frederick William IV.), and the Prussian constitution of February 1847 was an attempt to realize the ideas put forward by him in his *Gespräche aus der Gegenwart über Staat und Kirche*, published under the pseudonym "Waldheim" in 1846. In November 1847 and March 1848 Radowitz was sent by King Frederick William to Vienna to attempt to arrange common action for the reconstruction of the German Confederation. In the Frankfort parliament he was leader of the extreme Right; and after its break-up he was zealous in promoting the Unionist policy of Prussia, which he defended both in the Prussian diet and in the Erfurt parliament. He was practically responsible for the foreign policy of Prussia from May 1848 onwards, and on the 27th of September 1850

he was appointed minister of foreign affairs. He resigned, however, on the 2nd of November, owing to the king's refusal to settle the difficulties with Austria by an appeal to arms. In August 1852 he was appointed director of military education; but the rest of his life was devoted mainly to literary pursuits. He died on the 25th of December 1853.

Radowitz published, in addition to several political treatises, *Ikographie der Heiligen, ein Beitrag zur Kunstgeschichte* (Berlin, 1834) and *Devisen und Mottos des spätern Mittelalters* (ib., 1850). His *Gesammelte Schriften* were published in 5 vols. at Berlin, 1852-53. See Hassel, *Joseph Maria von Radowitz* (Berlin, 1905, &c.).

RAE, JOHN (1813-1893), Scottish Arctic explorer, was born on the 30th of September 1813, in the Orkney Islands, which he left at an early age to study medicine at Edinburgh University, qualifying as a surgeon in 1833. He made a voyage in a professional capacity in one of the ships of the Hudson's Bay Company, and entering the service of the company was resident surgeon for ten years at their station at Moose Factory, at the head of James Bay. In 1846 he made a boat-voyage to Repulse Bay, and having wintered there, in the following spring surveyed 700 miles of new coast-line connecting the earlier surveys of Ross and Parry. An account of this expedition, *A Narrative of an Expedition to the Shores of the Arctic Sea in 1846 and 1847*, was published by him in 1850. During a visit to London in 1848 he joined the expedition which was then preparing to go out under Sir John Richardson in search of Franklin; and in 1851, at the request of the Government and with a very slender outfit, he travelled some 5300 miles, much of it on foot, and explored and mapped 700 miles of new coast on the south side of Wollaston and Victoria Lands. For this achievement he received the Founder's gold medal of the Royal Geographical Society. In 1853 he commanded another boat-expedition which was fitted out by the Hudson's Bay Company, which connected the surveys of Ross with that of Deane and Simpson, and proved King William's Land to be an island. It was on this journey that he obtained the first authentic news regarding the fate of Franklin, thereby winning the reward of £10,000 promised by the admiralty. He subsequently travelled across Iceland, and in Greenland and the northern parts of America, surveying routes for telegraph lines. Dr Rae attributed much to his success in Arctic travel to his adoption of the methods of the Eskimo, a people whom he had studied very closely. He was a keen sportsman, an accurate and scientific observer. He died at his house in London and was buried in the Orkney Islands.

RAE BARELI, a town and district of British India, in the Lucknow division of the United Provinces. The town is on the river Sai, 48 m. S.E. of Lucknow, on the Oudh & Rohilkhand railway. Pop. (1901) 15,880. It possesses many architectural features, chief of which is a strong and spacious fort erected in 1403, and constructed of bricks 2 ft. long by 1 ft. thick and 1½ wide. Among other ancient buildings are the magnificent palace and tomb of nawab Jahan Khan, governor in the time of Shah Jahan, and four fine mosques. The town is an important centre of trade, and muslins and cotton cloth are woven.

The DISTRICT OF RAE BARELI has an area of 1748 sq. m. The general aspect of the district is slightly undulating, and the country is beautifully wooded. The soil is remarkably fertile, and the cultivation of a high class. The principal rivers of the district are the Ganges and the Sai: the former skirts it for 54 miles and is everywhere navigable for boats of 40 tons; the latter traverses it from N.W. to S.E. In 1901 the population was 1,033,761, showing a slight decrease during the decade. The principal crops are rice, pulse, wheat, barley, millet and poppy. Rae Bareli town is connected with Lucknow by a branch of the Oudh & Rohilkhand railway, which in 1898 was extended to Benares.

See *Rae Bareli District Gazetteer*, Allahabad, 1905.

RAEBURN, SIR HENRY (1756-1823), Scottish portrait-painter, was born at Stockbridge, a suburb of Edinburgh, on the 4th of March 1756, the son of a manufacturer of the city.

He was early left an orphan. Being placed in Heriot's Hospital, he received there the elements of a sound education, and at the age of fifteen was apprenticed to a goldsmith in Edinburgh. Here he had some little opportunity for the practice of the humbler kinds of art, and various pieces of jewelry, mourning rings, and the like, adorned with minute drawings on ivory by his hand, are still extant. Soon he took to the production of carefully finished miniatures; and, meeting with success and patronage, he extended his practice to oil-painting, being all the while quite self-taught. The worthy goldsmith his master watched the progress of his pupil with interest, gave him every encouragement, and introduced him to David Martin, who had been the favourite assistant of Allan Ramsay junior, and was now the leading portrait-painter in Edinburgh. Raeburn received considerable assistance from Martin, and was especially aided by the loan of portraits to copy. Soon the young painter had gained sufficient skill to render it advisable that he should devote himself exclusively to painting. When he was in his twenty-second year he was asked to paint the portrait of a young lady whom he had previously observed and admired when he was sketching from nature in the fields. She was the daughter of Peter Edgar of Bridgelands and widow of Count Leslie. The lady was speedily fascinated by the handsome and intellectual young artist, and in a month she became his wife, bringing him an ample fortune. This early insurance against the risks of his chosen profession, did not, however, diminish his anxiety to excel. The acquisition of wealth affected neither his enthusiasm nor his industry, but rather spurred him to greater efforts to acquire a thorough knowledge of his craft. After the approved fashion of artists of the time, it was resolved that Raeburn should visit Italy, and he accordingly started with his wife. In London he was kindly received by Sir Joshua Reynolds, who gave him excellent advice as to his study in Rome, especially recommending to his attention the works of Michelangelo. He also offered him more substantial pecuniary aid, which was declined as unneeded; but Raeburn carried with him to Italy many valuable introductions from the president of the Academy. In Rome he made the acquaintance of Gavin Hamilton, of Batoni, and of Byers. For the advice of the last-named he used to acknowledge himself greatly indebted, particularly for the recommendation that "he should never copy an object from memory, but, from the principal figure to the minutest accessory, have it placed before him." After two years of study in Italy he returned to Edinburgh in 1787, where he began a most successful career as a portrait-painter. In that year he executed an admirable seated portrait of the second Lord President Dundas.

Of his earlier portraiture we have interesting examples in the bust-likeness of Mrs Johnstone of Baldovie and in the three-quarter-length of Dr James Hutton, works which, if they are somewhat timid and tentative in handling and wanting in the trenchant brush-work and assured mastery of subsequent productions, are full of delicacy and character. The portraits of John Clerk, Lord Eldin, and of Principal Hill of St Andrews belong to a somewhat later period. Raeburn was fortunate in the time in which he practised portraiture. Sir Walter Scott, Blair, Mackenzie, Woodhouselee, Robertson, Home, Ferguson, and Dugald Stewart were resident in Edinburgh, and they all, along with a host of others less celebrated, honoured the painter's canvases. Of his fully matured manner we could have no finer examples than his own portrait and that of the Rev. Sir Henry Moncrieff Wellwood, the bust of Dr Wardrop of Torbane Hill, the two full-lengths of Adam Rolland of Gask, the remarkable paintings of Lord Newton and Dr Alexander Adam in the National Gallery of Scotland, and that of William Macdonald of St Martin's. It was commonly believed that Raeburn was less successful in his female than in his male portraits, but the exquisite full-length of his wife, the smaller likeness of Mrs R. Scott Moncrieff in the Scottish National Gallery, and that of Mrs Robert Bell, and others, are sufficient to prove that he could portray all the grace and beauty of the gentler sex.

Raeburn spent his life in Edinburgh, rarely visiting the metropolis, and then only for brief periods, thus preserving his own sturdy individuality, if he missed the opportunity of engrafting on it some of the fuller refinement and delicacy of the London portraitists. But though he, personally, may have lost some of the advantages which might presumably have resulted from closer association with the leaders of English art, and from contact with a wider public, Scottish art certainly gained much from his disinclination to leave his native land. He became the acknowledged chief of the school which was growing up in Scotland during the earlier years of the 19th century, and to his example and influence at a critical period is undoubtedly due much of the striking virility by which the work of his followers and immediate successors is distinguished. Evidences of this influence can be perceived even in the present day. His leisure was employed in athletic sports, in his garden, and in architectural and mechanical pursuits, and so varied were the interests that filled his life that his sitters used to say of him, "You would never take him for a painter till he seizes the brush and palette." Professional honours fell thick upon him. In 1812 he was elected president of the Society of Artists in Edinburgh, in 1814 associate, and in the following year full member of the Royal Academy. In 1822 he was knighted by George IV. and appointed His Majesty's limner for Scotland. He died at Edinburgh on the 8th of July 1823.

In his own day the portraits of Raeburn were excellently and voluminously engraved, especially by the last members of the great school of English mezzotint. In 1876 a collection of over 300 of his works was brought together in the Royal Scottish Academy galleries; in the following year a series of twelve of his finest portraits was included in the winter exhibition of the Royal Academy, London; and a volume of photographs from his paintings was edited by Dr John Brown.

Raeburn possessed all the necessary requirements of a popular and successful portrait-painter. He had the power of producing a telling and forcible likeness; his productions are distinguished by breadth of effect, by admirable force of handling, by execution of the swiftest and most resolute sort. Wilkie has recorded that, while travelling in Spain and studying the works of Velazquez, the brush-work of that master reminded him constantly of the "square touch" of Raeburn. But the portraits of Velazquez are unsurpassable examples of tone as well as of handling, and it is in the former quality that Raeburn is often wanting, possibly because his inclinations led him to study effects of diffused light in preference to those which were strong in contrasts of light and shade. The colour of his portraits is sometimes crude and out of relation, inclining to the use of positive and definite local pigments, and too little perceptive of the changeable subtleties and modifications of atmospheric effect. His draperies frequently consist of little more than two colours—the local hue of the fabric and the black which, more or less graduated, expresses its shadows and modelling. In his flesh, too, he wants—in all but his very best productions—the delicate refinements of colouring which distinguish the works of the great English portrait-painters. His faces, with all their excellent truth of form and splendid vigour of handling, are often hard and bricky in hue. Yet, after all allowances have been made for what deficiencies there may be in his work, his right to a place among the greater British masters cannot be contested. The masculine power, the vitality and the strength of characterization which are so apparent in his paintings entitle him to the serious attention of all lovers of fine achievement; and there is much to be learned from study of his methods. His sincerity and freedom from artificial graces of style can be specially recognized, and his frank directness is always attractive.

See *Life of Sir Henry Raeburn, R.A.*, by his great-grandson William Raeburn Andrew, M.A. Oxon. (2nd ed., 1894), which contains some of the latest information, together with a complete catalogue of the exhibition of 1876. There may also be consulted *Works of Sir Henry Raeburn, R.A.*, with tributes by Dr John Brown and others, published by Andrew Elliot, Edinburgh; *Tribute to the Memory of Raeburn* by Dr Andrew Duncan, the *Catalogues* of the

loan exhibitions in Edinburgh of 1884 and 1901; and the *Essay* by W. E. Henley—*Sir Henry Raeburn* by William Ernest Henley (1890) with a finely produced series of plates, printed by T. & A. Constable for the now defunct Royal Association for Promotion of the Fine Arts in Scotland. But the leading work on the subject, and the most splendidly illustrated, is *Sir Henry Raeburn* by Sir Walter Armstrong, with an introduction by R. A. M. Stevenson and a biographical and descriptive catalogue by J. L. Caw (1901).

RÆDWALD (d. c. 620), king of the East Angles, was the son of King Tytili. He became a Christian during a stay in Kent, but on his return to East Anglia he sanctioned the worship both of the Christian and the heathen religions. Very little is known about his reign, which probably began soon after 600. For a time he recognized the overlordship of Æthelberht, king of Kent, but he seems to have shaken off the Kentish yoke. He gained some superiority over the land south of the Humber with the exception of Kent and is counted among the Bretwaldas. Rædwald protected the fugitive Edwin, afterwards king of Northumbria, and in his interests he fought a sanguinary battle with the reigning Northumbrian king, Æthelfrith, near Retford in Nottinghamshire, where Æthelfrith was defeated and killed in April 617. He was followed as king of the East Angles by his son Eorpwald.

See Bede, *Historiae ecclesiasticae*, edited by C. Plummer (Oxford, 1896); and J. R. Green, *The Making of England* (1897-1899).

RAETIA (so always in inscriptions; in classical MSS. usually **RHAETIA**), in ancient geography, a province of the Roman Empire, bounded on the W. by the country of the Helvetii, on the E. by Noricum, on the N. by Vindelicia and on the S. by Cisalpine Gaul. It thus comprised the districts occupied in modern times by the Grisons, the greater part of Tirol, and part of Lombardy. The land was very mountainous, and the inhabitants, when not engaged in predatory expeditions, chiefly supported themselves by cattle-breeding and cutting timber, little attention being paid to agriculture. Some of the valleys, however, were rich and fertile, and produced corn and wine, the latter considered equal to any in Italy. Augustus preferred Raetian wine to any other. Considerable trade was also carried on in pitch, honey, wax and cheese. Little is known of the origin or history of the Raetians, who are described as one of the most powerful and warlike of the Alpine tribes. It is distinctly stated by Livy (v. 33) that they were of Etruscan origin (a view favoured by Niebuhr and Mommsen). A tradition reported by Justin (xx. 5) and Pliny (*Nat. Hist.* iii. 24, 133) affirmed that they were a portion of that people who had settled in the plains of the Po and were driven into the mountains by the invading Gauls, when they assumed the name of Raetians from their leader Raetus; a more probable derivation, however, is from Celtic *rait*, "mountain land." Even if their Etruscan origin be accepted, at the time when the land became known to the Romans, Celtic tribes were already in possession of it and had amalgamated so completely with the original inhabitants that, generally speaking, the Raetians of later times may be regarded as a Celtic people, although non-Celtic tribes (Lepontii, Euganei) were settled among them. The Raetians are first mentioned (but only incidentally) by Polybius (xxxiv. 10, 18), and little is heard of them till after the end of the Republic. There is little doubt, however, that they retained their independence until their subjugation in 15 B.C. by Tiberius and Drusus (cf. Horace, *Odes*, iv. 4 and 14). At first Raetia formed a distinct province, but towards the end of the 1st century A.D. Vindelicia was added to it; hence Tacitus (*Germania*, 41) could speak of Augusta Vindelicorum (*Augsburg*) as "a colony of the province of Raetia." The whole province (including Vindelicia) was at first under a military prefect, then under a procurator; it had no standing army quartered in it, but relied on its own native troops and militia for protection. In the reign of Marcus Aurelius it was governed by the commander of the *Legio iii. Italica*. Under Diocletian it formed part of the diocese of the *vicarius Italiae*, and was subdivided into Raetia *prima* and *secunda* (each under a *praeses*), the former corresponding to the old Raetia, the latter to Vindelicia. The boundary between them is not clearly defined, but may be

stated generally as a line drawn eastwards from the lacus Brigantinus (Lake of Constance) to the river Oenus (Inn). During the last years of the Western Empire, the land was in a desolate condition, but its occupation by the Ostrogoths in the time of Theodoric, who placed it under a *dux*, to some extent revived its prosperity. The chief towns of Raetia (excluding Vindelicia) were Tridentum (Trent) and Curia (Coire or Chur). It was traversed by two great lines of Roman roads—one leading from Verona and Tridentum across the Brenner (in which the name of the Brenni has survived) to Oenipons (Innsbruck) and thence to Augusta Vindelicorum; the other from Brigantium (Bregenz) on Lake Constance, by Coire and Chiavenna to Como and Milan.

See P. C. Planta, *Das alte Rätien* (Berlin, 1872); T. Mommsen in *Corpus Inscriptionum Latinarum*, iii. p. 706; J. Marquardt, *Römische Staatsverwaltung*, i. (2nd ed., 1881) p. 288; L. Steub, *Über die Urbewohner Rätiens und ihren Zusammenhang mit den Etruskern* (Munich, 1843); J. Jung, *Römer und Romanen in den Donauländern* (Innsbruck, 1877); Smith's *Dict. of Greek and Roman Geography* (1873); T. Mommsen, *The Roman Provinces* (Eng. trans., 1886), i. pp. 16, 161, 196; Mary B. Peaks, *The General Civil and Military Administration of Noricum and Raetia* (Chicago, 1907).

RAFF, JOSEPH JOACHIM (1822–1882), German composer and orchestral conductor, was born near Zürich, Switzerland, on the 27th of May 1822, and educated chiefly at Schwyz. Here, under the care of the Jesuit fathers, he soon became an excellent classical and mathematical scholar, but received scarcely any instruction in his favourite art of music, in which, nevertheless, he made extraordinary progress through sheer force of natural genius, developed by persevering study which no external obstacles could induce him to discontinue. So successful were his unaided efforts that, when in 1843 he sent some MSS. to Mendelssohn, that warm encourager of youthful talent felt justified in at once recommending him to Breitkopf & Härtel, the Leipzig publishers, who brought out a large selection of his early works. Soon after this he became acquainted with Liszt, who gave him much generous encouragement. He first became personally acquainted with Mendelssohn at Cologne in 1846, and gave up all his other engagements for the purpose of following him to Leipzig, but his intention was frustrated by the great composer's death in 1847. After this disappointment he remained for some time at Cologne, where his attention was alternately devoted to composition and to the preparation of critiques for the periodical *Cäcilia*. Thus far he was a self-taught artist; but he felt the need of systematic instruction so deeply that, retiring for a time from public life, he entered at Stuttgart upon a long course of severe and uninterrupted study, and with so much success that in 1850 he appeared before the world in the character of an accomplished and highly cultivated musician. Raff now settled for a time in Weimar in order to be near Liszt. Hans von Bülow had already brought him into notice by playing his *Concertstück* for piano-forte and orchestra in public, and the favour with which this fine work was everywhere received encouraged him to attempt a greater one. During his stay in Stuttgart he had begun the composition of an opera entitled *König Alfred*, and had good hope of securing its performance at Dresden; but the political troubles with which Germany was then overwhelmed rendered its production in the Saxon capital impossible. At Weimar he was more fortunate. In due time *König Alfred* was produced there under Liszt's able direction at the court theatre with complete success; and later, in 1870, he wrote his second opera, *Dame Kobold*, for performance at the same theatre. A third opera, *Samson*, remained unstaged.

Raff lived at Weimar until 1856, when he obtained a large *dientle* at Wiesbaden as a teacher of the pianoforte. In 1859 he married Doris Genast, an actress of high repute, and thenceforward devoted himself with renewed energy to the work of composition, displaying an inexhaustible fertility of invention tempered by great technical skill. He resided chiefly at Wiesbaden till 1877, when he was appointed director of the Hoch-Conservatorium at Frankfurt, an office which he retained until his death on the 25th of June 1882.

More than 200 of Raff's compositions have been published, including ten symphonies—undoubtedly his finest works—quartets, concertos, sonatas, songs, and examples of nearly every known variety of style; yet he never repeats himself. Notwithstanding his strong love for the romantic school, he is never guilty of extravagance, and, if in his minor works he is sometimes a little commonplace, he never descends to vulgarity. His symphonies *Lenore* and *Im Walde* are wonderful examples of musical painting.

RAFFAELINO DEL GARBO (1466, or perhaps 1476–1524), Florentine painter. His real name was Raffaello Capponi; Del Garbo was a nickname, bestowed upon him seemingly from the graceful nicety (*garbo*) of his earlier works. He has also been called Raffaello de Florentia, and Raffaello de Carolis. He was a pupil of Filippino Lippi, with whom he remained till 1490, if not later. He showed great facility in design, and excited hopes which the completed body of his works fell short of. He married and had a large family; embarrassments and a haphazard manner of work ensued; and finally he lapsed into a very dejected and penurious condition. Three of his best tempera pictures are in the Berlin Gallery; one of the Madonna standing with her Infant between two musician-angels, is particularly attractive. We may also name the oil-painting of the "Resurrection" done for the church of Monte Oliveto, Florence, now in the academy of the same city, ordinarily reputed to be Raffaellino's masterpiece; the ceiling of the Caraffa Chapel in the church of the Minerva, Rome; and a "Coronation of the Virgin" in the Louvre, which is a production of much merit, though with somewhat over-studied grace. Angelo Allori was his pupil.

RAFFET, DENIS AUGUSTE MARIE (1804–1860), French illustrator and lithographer, was born in Paris in 1804. At an early age he was apprenticed to a wood turner, but took up the study of art at evening classes. He became acquainted with Cabanel, who made him apply his skill to the decoration of china, and with Rudor, from whom he received instruction in lithography, in the practice of which he was to rise to fame. He then entered the École des Beaux-Arts, but returned definitely to lithography in 1830, when he produced on stone his famous designs of "Lutzen," "Waterloo," "Le bal," "La revue" and "Les adieux de la garnison," by which his reputation became immediately established. Raffet's chief works were his lithographs of the Napoleonic campaigns, from Egypt to Waterloo, vigorous designs that are inspired by ardent patriotic enthusiasm. As an illustrator his activity was prodigious, the list of works illustrated by his crayon amounting to about forty-five, among which are Béranger's poems, the *History of the Revolution* by Thiers, the *History of Napoleon* by de Norvins, the great *Walter Scott* by Defauconpret, the French Plutarch and Frédéric Bérat's *Songs*. He went to Rome in 1840, was present at the siege of Rome, which he made the subject of some lithographs, and followed the Italian campaign of 1859, of which he left a record in his *Episodes de la campagne d'Italie de 1859*. His portraits in pencil and water-colour are full of character. He died at Genoa in 1860. In 1893 a monument by Frémiet was unveiled in the Jardin de l'Infante at the Louvre, Paris.

See *Raffet*, by F. Lhomme (Paris, 1892).

RAFFLE, a special kind of lottery, in which a particular article is put up as the prize, the winner being drawn for by lot out of the number of those who have paid a fixed sum for admission to the drawing; the total amount realized by the sale of the tickets is supposed to approximate to the value of the object raffled for. The word appears in English as early as Chaucer (*The Parson's Tale*) where it is used in its original sense of a game of dice, the winner being that one who threw three dice all alike, or, next, the highest pair. The Fr. *raffle*, Med. Lat. *raffla*, was also used in the sense of a "sweeping-off" of the stakes in a game; it has been connected with Ger. *raffen*, to carry off.

RAFFLES, SIR THOMAS STAMFORD (1781–1826), English administrator, founder of Singapore, was born on the 5th of July 1781, on board a merchantman commanded by his father, Benjamin Raffles, when off Port Morant, Jamaica. He received

his early education at a school at Hammersmith, but when only fourteen he obtained temporary work in the secretary's office of the East India Company. In 1800 he was appointed junior clerk on the establishment. In 1805 the East India Company decided to make Penang a regular presidency, and sent out a governor with a large staff, including Stamford Raffles, who was appointed assistant-secretary. On the eve of his departure he married Mrs Fancourt (Olivia Mariamne Devenish), widow of a surgeon on the Madras Establishment; she proved herself a helpful wife and counsellor to her husband in his rapid rise to fortune during the following nine years, dying prematurely in Java in November 1814. On his way out to Penang, Raffles began the study of the Malay language, and had mastered its grammar before his arrival. He continued his studies, finding a congenial fellow-worker and kindred spirit in John Leyden, who was invalided to Penang. In August 1806 Raffles was appointed acting secretary during the illness of that official, and in 1807 he received the full appointment. In the meantime he had acted as Malay interpreter, which entailed heavy and unappreciated work in addition to his regular duties. In 1808 his health gave way, and he was ordered for a change to Malacca. This proved a turning-point in his career. The East India Company had decided to abandon Malacca, and orders had been issued to dismantle it. Raffles perfected his study of Malay during his stay at this place, and learning from the Malays, with whom he mixed freely, that the abandonment of so important a position would be a grave fault, he drew up a report explaining the great importance of Malacca, and urging in the strongest manner its retention. This report was sent by the Penang authorities not only to London, but to the governor-general, the earl of Minto. The latter was so impressed by the report that he at once gave orders for suspending the evacuation of Malacca, and in 1809 the company decided to reverse its own decision. When the whole question was calmly considered in the light of subsequent events, many years later, the verdict was that Raffles had "prevented the alienation of Malacca from the British Crown." A direct correspondence with Lord Minto was established by the mediation of Leyden, who wrote to Raffles that the governor-general would be gratified in receiving communications direct from him. In June 1810 Raffles, of his own accord, proceeded to Calcutta, where Lord Minto gave him the kindest reception. Raffles remained four months in Calcutta, and gained the complete confidence of the governor-general. He brought Lord Minto round to his opinion that the conquest of the island of Java, then in the hands of the French, was an imperative necessity. To prepare the way for the expedition, Raffles was sent to Malacca as "agent to the Governor-General with the Malay States." He did his work well and thoroughly—even to the extent of discovering that the short and direct route to Batavia by the Caramata passage would be safe for the fleet. In August 1811 the expedition, accompanied by Lord Minto, and with Sir Samuel Auchmuty in command of the troops (11,000 in number, half English and half Indian), occupied Batavia without fighting. On the 25th of the same month a battle was fought at Cornelis, a few miles south of Batavia, and resulted in a complete English victory. On the 18th of September the French commander, General Janssens, formally capitulated at Samarang, and the conquest of the island was completed. Lord Minto's first act was to appoint Raffles lieutenant-governor of Java. From September 1811 until his departure for England in March 1816, Raffles ruled this large island with conspicuous success and the most gratifying results. To give only one fact in support of this statement, he increased the revenue eightfold at the same time that he abolished transit dues, reduced port dues to one-third and removed the fetters imposed on trade and intercourse with the Javanese by Dutch officialdom. In his own words, his administration aimed at being "not only without fear, but without reproach." He had a still greater ambition, which was, in his own words, "to make Java the centre of an Eastern insular Empire," and to establish the closest relations of friendship and alliance with the Japanese, whom he described as "a

highly polished people, considerably advanced in science, highly inquisitive and full of penetration." It is interesting to note that when another great Englishman, Rajah Brooke, began his career in Sarawak in 1838, he announced: "I go to carry Sir Stamford Raffles's views in Java over the whole Archipelago."

The policy of Raffles was based on the assumption that Java would be retained, but for reasons of European policy it was decided that it must be restored to Holland. After his return to England in 1816 he endeavoured to obtain a reconsideration of the question, but the decision taken was embodied in a treaty and beyond all possibility of modification. During his stay in England Raffles was knighted by the prince regent, published his *History of Java* (1817) and discussed with Sir Joseph Banks a project for the foundation in London of a zoological museum and garden on the model of the Jardin des Plantes at Paris. He also married his second wife, Sophia, daughter of T. W. Hull of Co. Down; he had many children by both marriages, but the only one to live beyond childhood was a daughter, who died fifteen years after her father's death, and before she was twenty. He left, therefore, no direct descendants.

In November 1817 Sir Stamford quitted England on his return to the East, where the lieutenant-governorship of Fort Marlborough (Sumatra) had been kept in reserve for him. His administration of Sumatra, which lasted from March 1818 till December 1823, was characterized by the same breadth of view, consistency of purpose and energy in action that had made his government of Java remarkable. He had not, however, done with the Dutch, who, on their recovery of Java, endeavoured to establish a complete control over the Eastern archipelago, and to oust British trade. This design Sir Stamford set himself to baffle, and although he was more frequently censured than praised by his superiors for his efforts, he had already met with no inconsiderable success in minor matters when, by a stroke of genius and unrivalled statecraft, he stopped for all time the Dutch project of a *mare clausum* by the acquisition and founding of Singapore on the 29th of January 1819.

In 1824 Sir Stamford returned to England, but unfortunately the differences between him and the East India Company had resulted in an accumulation of disputes which placed a severe strain on his enfeebled constitution. The memorials and statements that he had to compile for his own vindication would fill a large volume, but at last the court passed (12th of April 1826) a formal decision in his favour. It did not omit, however, to censure him for "his precipitate and unauthorized emancipation of the Company's slaves," or after his death to make his widow pay £10,000 for various items, which included the expense of his mission to found Singapore! Harassed as he was by these personal affairs, he still found time to carry out his original scheme with regard to a zoological society in London. He took the largest part in the creation of the existing society, and his fine Sumatra collection formed its endowment. He was unanimously elected its president at the first meeting, and by a remarkable unanimity of opinion on the part of those who helped in the work, he has been recognized as "the Founder of the Zoological Society." He was contemplating entering parliamentary life when his sudden death on his birthday, 1826, ended his brilliant career at the early age of forty-five. Sir Frederick Weld, lieutenant-governor at Singapore, when unveiling the statue of his predecessor at that place in 1887, crystallized the thoughts of his countrymen and anticipated the verdict of history in a single sentence: "In Raffles, England had one of her greatest sons."

See Lady Raffles, *Memoir of Sir Thomas Stamford Raffles* (1830); D. C. Boulger, *Life of Sir Stamford Raffles* (1897); Hugh Egerton, *Sir Stamford Raffles* (1899); J. Buckley, *Records of Singapore* (1903).
(D. C. B.)

RAFN, KARL CHRISTIAN (1795-1864), Danish archaeologist, was born in Brahesborg, Fünen, on the 16th of January 1795, and died at Copenhagen on the 20th of October 1864. He is chiefly known in connexion with the controversy as to the question of the discovery of America by the Norsemen, his

views being contained in his chief work, *Antiquitates Americanae* (Copenhagen, 1837). See LEIF ERICSSON.

RAFTER, a beam in a sloping roof to which is attached the framework for the slating, tiling or other external covering (see ROOFS). The O.Eng. *raefter* is cognate with Icel. *rafr*, Dan. and Swed. *rafte* or *raft*, a beam, which, in the special sense of a floating collection of timbers, gives the English "raft." The ultimate base of these words is the root *raf-*, to cover, seen in Gr. *δροφος*, roof.

RAGATZ, a famous watering-place in the Swiss canton of St Gall, situated on the left bank of the Rhine, and by rail $13\frac{1}{2}$ m. N. of Coire or $61\frac{1}{2}$ m. S.E. of Zürich. It stands at a height of 1696 ft., at the entrance to the magnificent gorge of the Tamina, about 3 m. up which by carriage road are the extraordinarily placed Baths of Pfäfers (2247 ft.). Since 1840 the hot mineral waters of Pfäfers are conducted in pipes to Ragatz, which is in a more pleasant position. Consequently Ragatz has much increased in importance since that date. In 1900 its native population was 1866, mainly German-speaking, while there were 1472 Romanists to 392 Protestants. The annual number of visitors is reckoned at 30,000. In the churchyard is the grave of the philosopher Schelling (d. here in 1854). About 2 m. by road above Ragatz are the 17th-century buildings (now the cantonal lunatic asylum) of the great Benedictine abbey of Pfäfers (720-1838), to which all this region belonged till 1798; while midway between them and Ragatz are the ruins of the 14th-century castle of Wartenstein, now accessible from Ragatz by means of a funicular railway. (W. A. B. C.)

RAGLAN, FITZROY JAMES HENRY SOMERSET, 1ST BARON (1788-1855), British field marshal, was the eighth and youngest son of Henry, 5th duke of Beaufort, by Elizabeth, daughter of Admiral the Hon. Edward Boscawen, and was born on the 30th of September 1788. His elder brother, General Lord (Robert) Edward (Henry) Somerset (1776-1842), distinguished himself as the leader of the Household Cavalry brigade at Waterloo. Lord Fitzroy Somerset was educated at Westminster school, and entered the army in 1804. In 1807 he was attached to the Hon. Sir Arthur Paget's embassy to Turkey, and the same year he was selected to serve on the staff of Sir Arthur Wellesley in the expedition to Copenhagen. In the following year he accompanied the same general in a like capacity to Portugal, and during the whole of the Peninsular War was at his right hand, first as aide-de-camp and then as military secretary. He was wounded at Busaco, became brevet-major after Fuentes de Oñoro, accompanied the stormers of the 52nd light infantry as a volunteer at Ciudad Rodrigo and specially distinguished himself at the storming of Badajoz, being the first to mount the breach, and afterwards showing great resolution and promptitude in securing one of the gates before the French could organize a fresh defence. During the short period of the Bourbon rule in 1814 and 1815 he was secretary to the English embassy at Paris. On the renewal of the war he again became aide-de-camp and military secretary to the duke of Wellington. About this time he married Emily Harriet, daughter of the 3rd earl of Mornington, and Wellington's niece. At Waterloo he was wounded in the right arm and had to undergo amputation, but he quickly learned to write with his left hand, and on the conclusion of the war resumed his duties as secretary to the embassy at Paris. From 1818 to 1820, and again in 1826-29, he sat in the House of Commons as member for Truro. In 1819 he was appointed secretary to the duke of Wellington as master-general of the ordnance, and from 1827 till the death of the duke in 1852 was military secretary to him as commander-in-chief. He was then appointed master-general of the ordnance, and was created Baron Raglan. In 1854 he was promoted general and appointed to the command of the English troops sent to the Crimea (see CRIMEAN WAR) in co-operation with a strong French army under Marshal St Arnaud and afterwards, up to May 1855, under Marshal Canrobert. Here the advantage of his training under the duke of Wellington was seen in the soundness of his generalship, and his diplomatic experience stood him in good

stead in dealing with the generals and admirals, British, French and Turkish, who were associated with him. But the trying winter campaign in the Crimea also brought into prominence defects perhaps traceable to his long connexion with the formalities and uniform regulations of military offices in peace time. For the hardships and sufferings of the English soldiers in the terrible Crimean winter before Sevastopol, owing to failure in the commissariat, both as regards food and clothing, Lord Raglan and his staff were at the time severely censured by the press and the government; but, while Lord Raglan was possibly to blame in representing matters in a too sanguine light, it afterwards appeared that the chief neglect rested with the home authorities. But this hopefulness was a shining military quality in the midst of the despondency that settled upon the allied generals after their first failures, and at Balaklava and Inkermann he displayed the promptness and resolution of his youth. He was made a field marshal after Inkermann. During the trying winter of 1854-55, the suffering he was compelled to witness, the censures, in great part unjust, which he had to endure and all the manifold anxieties of the siege seriously undermined his health, and although he found a friend and ardent supporter in his new French colleague, General Pélissier (*q.v.*), disappointment at the failure of the assault of the 18th of June 1855 finally broke his spirit, and very shortly afterwards, on the 28th of June 1855, he died of dysentery. His body was brought home and interred at Badminton.

His elder son having been killed at the battle of Ferozeshah (1845), the title descended to his younger son Richard Henry Fitzroy Somerset, 2nd Baron Raglan (1817-1884); and subsequently to the latter's son, George Fitzroy Henry Somerset, 3rd baron (b. 1857), under-secretary for war 1900-2, lieutenant-governor of the Isle of Man (1902) and a prominent militia officer.

RAGMAN ROLLS, the name given to the collection of instruments by which the nobility and gentry of Scotland were compelled to subscribe allegiance to Edward I. of England between the conference of Norham in May 1291 and the final award in favour of Baliol in November 1292, and again in 1296. Of the former of these records two copies were preserved in the chapter-house at Westminster (now in the Record Office, London), and it has been printed by Rymer (*Foedera*, ii. 542). Another copy, preserved originally in the Tower of London, is now also in the Record Office. The latter record, containing the various acts of homage and fealty extorted by Edward from Baliol and others in the course of his progress through Scotland in the summer of 1296 and in August at the parliament of Berwick, was published by Prynne from the copy in the Tower and now in the Record Office. Both records were printed by the Bannatyne Club in 1834. The derivation of the word "ragman" has never been satisfactorily explained, but various guesses as to its meaning and a list of examples of its use for legal instruments both in England and Scotland will be found in the preface to the Bannatyne Club's volume, and in Jamieson's *Scottish Dictionary*, *s.v.* "Ragman." The name "ragman roll" survives in the colloquial "rigmarole," a rambling, incoherent statement.

The name of "Ragman" has been sometimes confined to the record of 1296, of which an account is given in *Calendar of Documents relating to Scotland preserved in the Public Record Office, London* (1884), vol. ii., *Introd.*, p. xxiv; and as to the seals see p. lii and appendix.

RAG-STONE (probably equivalent to "ragged" stone), a name given by some architectural writers to work done with stones which are quarried in thin pieces, such as the Horsham sandstone, Yorkshire stone, the slate stones, &c.; but this is more properly flag or slab work. By rag-stone, near London, is meant an excellent material from the neighbourhood of Maidstone. It is a very hard limestone of bluish-grey colour, and peculiarly suited for medieval work. It is often laid as uncoursed work, or random work (see RANDOM), sometimes as random coursed work and sometimes as regular ashlar. The first method, however, is the more picturesque. (See MASONRY.)

RAGUSA (Serbo-Croatian *Dubrovnik*), an episcopal city, and the centre of an administrative district in Dalmatia, Austria. Pop. (1900) of town and commune, 13,174, including a garrison of 1122. Its situation and its undisturbed atmosphere of antiquity combine to make Ragusa by far the most picturesque city on the Dalmatian coast. It occupies a ridge or promontory, which juts out into the Adriatic Sea, under the bare limestone mass of Monte Sergio. Its seaward fortifications rise directly from the water's edge, one fort, on the north mole, standing boldly on a tall rock almost isolated by a little inlet of the Adriatic. On the landward side a massive round tower dominates the city from a still higher eminence. Beyond the walls and the deep moat, especially on the northward side towards the port of Gravosa, are many pleasant villas, surrounded by gardens in which the aloe, palm and cypress are conspicuous among a number of flowering trees and shrubs. The island of Lacroma lies less than half a mile to the south. Between the seaward ridge and the mountain, the Stradone, or main street, runs along a narrow valley which, until the 13th century, was a marshy channel, dividing the Latin island of Ragusa from the Slavonic settlement of Dubrovnik, on the lower slopes of Monte Sergio. Parallel to the Stradone, on the north, is the Prijeki, a long, very narrow street, flanked by tall houses with overhanging balconies, and greatly resembling a Venetian alley. Despite the havoc wrought by earthquake in 1667, the whole city is rich in antiquarian interest. It possesses one church, of the Byzantine period, which is mentioned in 13th-century documents as even then of great age. Two stately convents of the 14th century stand at the ends of the city; for the Franciscans were set to guard the western gate, or Porta Pile, against the hostile Slavs, while the Dominicans kept the eastern gate, or Porta Ploce. The Franciscan cloister is a fine specimen of late Romanesque; that of the Dominicans is hardly inferior, though of later date. The Dominican church is approached by a sloping flagged lane, having on one side a beautifully ornamented balustrade of the 18th century. Another 14th-century building is the Sponza, or custom-house, from which the state derived its principal revenue. A fountain and a curious clock-tower in the Piazza, which terminates the Stradone towards the east, were erected by Onofrio, the architect and engineer whose aqueduct, built about 1440, supplied Ragusa with water from the neighbouring hills. The Rector's Palace, another noteworthy example of late Romanesque, combined with Venetian Gothic, is one of the masterpieces of Dalmatian architecture. It has a fine façade of six arches, and the capitals of the supporting pillars are very curiously carved. Especially interesting is the figure of Aesculapius, whose traditional birthplace was *Epidaurum* or *Epidaurus*, the parent city of Ragusa. The cathedral dates from the 18th century; and to the same period belongs another church, rebuilt after a fire, but originally erected as a votive offering after the pestilence of 1348, and dedicated to San Biagio (St Blaize), the patron of Ragusa, whose name and effigy continually appear on coins and buildings. Among many fine pieces of jewellers' work preserved in the ecclesiastical treasuries may be mentioned the silver statuette of San Biagio, and the reliquary which contains his skull—a 17th-century casket in filigree and enamels with Byzantine medallions of the 11th or 12th century.

The harbour of Ragusa, once one of the chief ports of southern Europe, is too small for modern needs; but Gravosa (*Gruž*), a village at the mouth of the river Ombla, on the north, is a steamship station and communicates by rail with Herzegovina and the Bocche di Cattaro. Ragusa has thus some transit trade with the interior. Its industries include the manufacture of liqueurs, oil, silk and leather; but Malmsey, its famous wine, could no longer be produced after the vine-disease of 1852.

History.—The name *Ragusa* is of uncertain origin. Constantine Porphyrogenitus, in the 10th century, connects its early form, *Lausa*, with λαῦ, a "precipice." Jireček dissents from this view, and from the common opinion that *Dubrovnik*

is derived from the Slavonic *dubrava*, "woody." The city first became prominent during the 7th century. In 639 and 656 the flourishing Latin communities of Salona and Epidaurum were destroyed by the Avars, and the island rock of Ragusa was colonized by the survivors. Tradition identifies Epidaurum, whence the majority came, with the neighbouring village of Ragusavecchia; but some historians, including Gelcich, place it on the shores of the Bocche di Cattaro. Both sites show signs of Roman occupation. A colony of Slavs soon joined the Latin settlers at Ragusa, and thus, from an early date, the city formed a link between two great civilizations (see VLACHS). In the 9th century it is said to have repulsed the Saracens; in the 10th it defended itself against the Narentine pirates, and Simeon, tsar of the Bulgarians. Some writers consider that it submitted to Venice in 998, with the rest of Dalmatia; but this is generally denied by the native historians. During the 11th century an enforced alliance with the Normans drew the republic into war with Venice and Byzantium; and in the 12th century it was attacked by the Bosnians and Serbs. From 1205 to 1358 it acknowledged Venetian suzerainty; its chief magistrate was the Venetian count; and its archbishops, who wielded much political influence, were often Venetian nominees. The constitution took shape during this period, and the first statute-book was published in 1272. Only patricians could hold office in the senate, grand council and lesser council, three bodies which shared the work of government with the count, or, after 1358, the rector. The ancient popular assembly was almost obsolete before the 14th century. Ragusan policy was usually peaceful, and disputes with other nations were frequently arranged by a system of arbitration called *stanicum*. To refugees of all nations, even to those who had been its own bitter foes, the city afforded asylum; and by means of treaty and tribute it worked its way to a position of mercantile power which Europe could hardly parallel. It was conveniently situated at the seaward end of a great trade route, which bifurcated at Plevlje to Byzantium and the Danube. A compact with the Turks, made in 1370 and renewed in the next century, saved Ragusa from the fate of its more powerful neighbours, Serbia and Byzantium, besides enabling the Ragusan caravans to penetrate into Hungary, Croatia, Bosnia, Serbia, Bulgaria and Rumania. From 1358 to 1526 the republic was a vassal state of Hungary, and no longer controlled by its greatest commercial rival. It acquired, among other territories, the important ship-building and salt-producing centre Stagno Grande (*Ston Veliki*), on the promontory of Sabbioncello; and from 1413 to 1416 it held the islands of Curzola, Brazza and Lesina by lease from Hungary. Meanwhile, Ragusan vessels were known not only in Italy, Sicily, Spain, Greece, the Levant and Egypt, but in the more northern parts of Europe. The English language retains in the word "argosy" a reminiscence of the carracks of Ragusa, long known to Englishmen as *Argouse*, *Argusa* or *Aragosa*. In the 16th century the Ragusan merchants went even to India and America, but they were unable to compete with their rivals from western Europe. Many of their seamen took service with Spain; and twelve of their finest ships were lost with the Invincible Armada in 1588. After 1526 the downfall of Hungary left Ragusa free; and about this time a great development of art and literature, begun in the 15th century and continued into the 17th, earned for the city its title of the "South Slavonic Athens." (See SERBIA, *Literature*.) The earthquake of 1667, which had been preceded by lesser shocks in 1520, 1521, 1536 and 1639, destroyed a considerable portion of the city, and killed about one-fifth of the inhabitants. Only during the Napoleonic wars did the republic regain its prosperity. From 1800 to 1805 it was the sole Mediterranean state remaining neutral, and thus it secured a very large share of the carrying trade. In 1805, however, it was seized by the French; Napoleon deprived it of independence; and in 1814 it was annexed to Austria.

See L. Villari, *The Republic of Ragusa* (London, 1904), for a thorough description and history, with a full bibliography. T. G.

Jackson, *Dalmatia, the Quarnero and Istria* (Oxford, 1887), gives the best account of Ragusan architecture and antiquities. The most accurate native history is G. Gelcich (Gelfič), *Dello Sviluppo civile di Ragusa* (Ragusa, 1884). The course of Ragusan trade may be studied in C. J. Jireček, *Die Handelsstrassen und Bergwerke von Serbien, &c.* (Prague, 1879); and Heyd, *Histoire du commerce du Levant au moyen âge* (Leipzig, 1885).

RAGUSA, a town of Sicily in the province of Syracuse, 70 m. S.W. of Syracuse by rail and 32 m. direct. It consists of an upper (Ragusa Superiore) and a lower town (Ragusa Inferiore), each of which forms a separate commune. Pop. (1906) of the former, 35,529; of the latter, 866. It has some churches with fine Gothic architecture, and is commercially of some importance, a stone impregnated with bitumen being quarried and prepared for use for paving slabs by being exposed to the action of fire. On the hill occupied by the castle of Ragusa Inferiore stood the ancient Hybla Heræa, a Sicel town, under the walls of which Hippocrates of Gela fell in 491 B.C. A Greek settlement seems to have arisen in the neighbourhood close to the present railway station, about the middle of the 6th century B.C., and to have disappeared at the end of the 5th. Orsi points out that the remains (cuttings in the rock and a part of the castle wall), attributed by Freeman (*History of Sicily*, i. 163) to Sicel times, are in reality post-Roman.

See Orsi in *Notizie degli scavi* (1899), 402-418.

RAHWAY, a city of Union county, New Jersey, U.S.A., in the north-eastern part of the state, on the Rahway river and about 20 m. S.W. of New York City. Pop. (1890) 7105; (1900) 7935, of whom 1345 were foreign-born; (1910 U.S. census) 9337. Rahway is served by the main line of the Pennsylvania railroad, and is connected with neighbouring cities by electric lines. It has wide streets and attractive parks, and is, to some extent, a residential suburb of New York and other neighbouring cities. It has a public library (1864), with upwards of 17,000 volumes, and about 1½ m. distant is the New Jersey Reformatory (1903), to which prisoners between the ages of sixteen and thirty may be sentenced instead of to the State Prison. There are various manufactures. Rahway was first settled in 1720, and was named in honour of the Indian chief Rahwack, whose tribe owned the site and the surrounding territory; it was chartered as a city in 1858. For many years Rahway was popularly known as Spanktown, and in January 1777, during the War of Independence, a skirmish, known as the battle of Spanktown, was fought here.

RAICHUR, a town of India, in the state of Hyderabad, at the junction of the Madras and Great Indian Peninsula railways, 351 m. N.E. from Madras. Pop. (1901) 22,165. It gives its name to the *doab*, or tract between the rivers Kistna and Tungabhadra, which was the scene of much fighting between Mahomedans and Hindus as debatable land during the 16th century. It contains a well-preserved fort and two old mosques. It is a thriving centre of trade, with several cotton-presses.

RAID, in the language of international law, an invasion by armed forces, unauthorized and unrecognized by any state, of the territory of a state which is at peace. Piracy is the attack on the high sea of any vessel by an armed vessel, not authorized or recognized by any state, for the purpose of robbery. A raid for the purpose of carrying off movable property and converting it to the use of the captors would still be distinguishable from piracy, because it was committed on territory subject to an exclusive territorial jurisdiction. Where the attack or invasion by an armed ship not authorized or recognized by any state is not for the purpose of capturing property, it is properly speaking a raid and not piracy. An attack though in time of peace, by armed forces authorized or recognized by a regular government, is not a raid but an act of war, there being a government responsible for the act committed. The fact of any act being authorized, not by the supreme government, but by a chartered company, or by its governing officer, makes no difference in international law, the directorate of a chartered company exercising its powers by delegation of the state under which it holds its charter.

The acts of its armed forces cannot in reason be distinguished from the acts of the armed forces of the state government. Thus compensation is just as much due for them as for the deliberate acts of the state itself, and any claim of an injured state can only be preferred against the state to which the company belongs. Invasion by the regular forces of a state, or by the regular forces of its delegated authority, being an act of war, the laws of war apply to it, and, on capture, such forces, or any members or part of such forces, are prisoners of war. On the other hand, the state whose subordinate authorities commit acts of war against a friendly state has the option of following them up as a commencement of hostilities, or of giving satisfactory compensation to the invaded state. Where the invasion is not by forces subject to the orders of a state, the invaded state has the right to apply its own laws for the repression of disturbances in its territory. Thus, in the so-called Jameson Raid, the Transvaal government had no right to treat Dr Jameson, an officer holding his powers under the British government, and his subordinates, as outlaws, and it was probably so advised, and the British government owed proper compensation for an act for the consequences of which, under international law, it was responsible.

British domestic law punishes raiding under the Foreign Enlistment Act 1870 (33 & 34 Vict. c. 90).¹ Section 11 of this act provides as follows.—“If any person within the limits of His Majesty’s dominions, and without the licence of His Majesty, prepares or fits out any naval or military expedition to proceed against the dominions of any friendly state, the following consequences shall ensue: (1) Every person engaged in such preparation or fitting out, or assisting therein, or employed in any capacity in such expedition, shall be guilty of an offence against this act, and shall be punishable by fine and imprisonment or either of such punishments, at the discretion of the Court before which the offender is convicted; and imprisonment, if awarded, may be either with or without hard labour. (2) All ships and their equipments, and all arms and munitions of war, used in or forming part of such expedition, shall be forfeited by His Majesty.” Section 12 provides for the punishment of accessories as principal offenders, and section 13 limits the term of imprisonment for any offence under the act to two years. In the Sandoval case (1886),² in which Colonel Sandoval, who was not a British subject, bought guns and ammunition and shipped them to Antwerp, where they were put on board a vessel, which afterwards made an attack on Venezuela, it was held that the offence of fitting out and preparing an expedition within British territory against a friendly state, under this section, is sufficiently constituted by the purchase of guns and ammunition in the British Empire, and their shipment for the purpose of being put on board a ship in a foreign port, with knowledge of the purchaser and shipper that they are to be used in a hostile demonstration against such state, though the shipper takes no part in any overt act of war, and the ship is not fully equipped for the expedition within any British port. Under the same section, Dr Jameson, administrator of the British South Africa Company, and his confederates were tried before the Central Criminal Court and sentenced to different terms of imprisonment.³ The offence committed under a British act is, of course, that of preparing and fitting out an expedition on British territory. Any acts subsequently committed by any British expedition on foreign soil are beyond the operation of domestic legislation, and fall to be dealt with by the domestic legislation of the state within which they occur, or by diplomacy, as the case may be. (T. BA.)

RAIFFEISEN, FRIEDRICH WILHELM (1818-1888), founder of the German system of agricultural co-operative banks, was

¹ The preamble to the Foreign Enlistment Act 1870 stated that its object was “to make provision for the regulation of the conduct of Her Majesty’s subjects during the existence of hostilities between foreign states with which Her Majesty is at peace.” This preamble was repealed by the Statutes Law Revision (No. 2) Act 1893.

² *R. v. Sandoval*, 1886, 56 *Law Times*, 526.

³ *R. v. Jameson*, 1896, 2 Q.B., 425.

born at Hamm on the Sieg on the 30th of March 1818, being the son of Gottfried Raiffeisen, burgomaster of that place. Educated privately, he entered the artillery in Cologne, but defective eyesight compelled him to leave the army. He then entered the public service at Coblenz, and in 1845 was appointed burgomaster of Weyerbusch. Here he was so successful that in 1848 he was transferred in a like capacity to Flammersfeld, and in 1852 to Heddersdorf. Raiffeisen devoted himself to the improvement of the social condition of the cultivators of the soil, and did good work in the planning of public roads and in other ways. The distress of the years 1846-47, the causes of which he discerned in the slight amount of credit obtainable by the small landed proprietors, led him to seek for a remedy in co-operation, and at Heddersdorf and at Weyerbusch he founded the first agricultural co-operative loan banks (*Darlehnskassenverein*). These banks were called after him, and their foundation resulted in a widespread system of land banks, supported by the government. In 1865 the state of his health compelled him to retire, but he continued to take an interest in the movement he had originated, and in 1878 he founded at Neuwied a periodical, *Das landwirtschaftliche Genossenschaftsblatt*. He died on the 11th of March 1888.

Among Raiffeisen's writings are, *Die Darlehnskassenvereine als Mittel zur Abhilfe* (Neuwied, 1866; new ed., 1887); *Anleitung zur Geschäfts- und Buchführung ländlichen Spar- und Darlehnskassenvereine* (new ed., 1896); and *Kurze Anleitung zur Gründung von Darlehnskassenvereinen* (new ed., 1893). See A. Wattig, *Friedrich Wilhelm Raiffeisen* (1890); H. W. Wolff, *People's Banks. A Record of Social and Economic Success* (1895); and Fassbender, *Friedrich Wilhelm Raiffeisen* (Berlin, 1902).

RAIGARH, a feudatory state of India, in the Chattisgarh division of the Central Provinces. Area, 1486 sq. m. Pop. (1901) 174,929, showing an increase of 4% in the decade. Estimated revenue, £10,000; tribute, £260. The chief belongs to the old Gond royal family. The state is traversed by the Bengal-Nagpur railway, with a station at Raigarh town, 363 m. from Calcutta. Rice is the chief crop; iron ore is worked by indigenous methods, and coal is known to exist. Fine tussore silk is produced at Raigarh town (pop. 6764). Raigarh is also the name of a hill fortress in Kolaba district, Bombay, which Sivaji made his chief place of residence. Here he was crowned in 1674.

RAIKES, ROBERT (1735-1811), English educationist, the founder of Sunday schools, was the son of Robert Raikes, a printer in Gloucester and proprietor of the *Gloucester Journal*, and was born on the 14th of September 1735. On the death of his father in 1757 he succeeded him in the business, which he continued to conduct till 1802. Along with some others he started a Sunday school at Gloucester in 1780, and on his giving publicity to the enterprise in the columns of his journal the notice was copied into the London papers and awakened considerable attention. For nearly thirty years he continued actively engaged in the promotion of his undertaking, and he lived to witness its wide extension throughout England. He died on the 5th of April 1811. His statue stands on the Thames Embankment.

Among various accounts of the life and work of Raikes mention may be made of that by P. M. Eastman, 1880.

RAIL. (1) (From Fr. *Râle*, cf. Ger. *Ralle*, Low Lat. *Rallus*, of unknown origin), originally the English name of two birds, distinguished from one another by a prefix as land-rail and water-rail, but latterly applied in a much wider sense to all the species which are included in the family *Rallidae*.

The land-rail, also very commonly known as the corn-crake, and sometimes as the daker-hen, is the *Rallus crex* of Linnaeus and *Crex pratensis* of recent authors. Its monotonous grating cry has given it its common name in several languages. With comparatively few individual exceptions, the land-rail is essentially migratory. It is the *Ortyometra* of classical authors—supposed by them to lead the quail (*q.v.*) on its voyages—and in the course of its wanderings has now been known to reach the coast of Greenland, and several times that of North America, to say nothing of Bermuda, in every instance

we may believe as a straggler from Europe or Barbary. The land-rail looks about as big as a partridge, but on examination its appearance is found to be very deceptive, and it will hardly ever weigh more than half as much. The plumage above is of a tawny brown, the feathers being longitudinally streaked with blackish brown; beneath it is of a yellowish white; but the flanks are of a light chestnut barred with white. The species is very locally distributed, and in a way for which there is at present no accounting. In some dry upland and corn-growing districts it is plentiful; in others, of apparently the same character, it but rarely occurs; and the same may be said in regard to low-lying marshy meadows, in most of which it is in season always to be heard, while in others having a close resemblance to them it is never met with. The nest is on the ground, generally in long grass, and therein from nine to eleven eggs are commonly laid. These are of a cream-colour, spotted and blotched with light red and grey. The young when hatched are thickly clothed with black down, as is the case in nearly all species of the family.

The water-rail, locally known as the skiddy or billcock, is the *Rallus aquaticus* of ornithology, and seems to be less abundant than the preceding, though that is in some measure due to its frequenting places into which from their swampy nature men do not often intrude. Having a general resemblance to the land-rail,¹ it can be in a moment distinguished by its partly red and much longer bill, and the darker coloration of its plumage—the upper parts being of an olive brown with black streaks, the breast and belly of a sooty grey, and the flanks dull black barred with white. Its geographical distribution is very wide, extending from Iceland (where it is said to preserve its existence during winter by resorting to the hot springs) to China; and though it inhabits Northern India, Lower Egypt and Barbary, it seems not to pass beyond the tropical line. It never affects upland districts as does the land-rail, but always haunts wet marshes or the close vicinity of water. Its love-note is a loud and harsh cry, not continually repeated as is that of the land-rail, but uttered at considerable intervals and so suddenly as to have been termed "explosive." Besides this, which is peculiar to the cock-bird, it has a croaking call that is frog-like. The eggs resemble those of the preceding, but are more brightly and delicately tinted.

The various species of rails, whether allied to the former or latter of those just mentioned, are far too numerous to be here noticed. Hardly any part of the world is without a representative of the genera *Crex* or *Rallus*, and every considerable country has one or perhaps more of each—though it has been the habit of systematists to refer them to many other genera, the characters of which are with difficulty found. Thus in Europe alone three other species allied to *Crex pratensis* occur more or less abundantly; but one of them, the spotted rail or crane, has been made the type of a so-called genus *Porzana*, and the other two, little birds not much bigger than larks, are considered to form a genus *Zapornia*. The first of these, which used not to be uncommon in the eastern part of England, has a very near representative in the Carolina rail or sora, *Crex carolina*, of North America, often there misnamed the ortolan, just as its European analogue, *C. porzana*, is in England often termed the dotterel. But, passing over these as well as some belonging to genera that can be much better defined, and other still more interesting forms of the family, as *Aphanapteryx*, coot (*q.v.*), moor-hen (*q.v.*) and ocydrome (*q.v.*), a few words must be said of the more distant group formed by the South American *Heliornis*, and the African and Indian *Podica*, comprising four or five species, to which the name "Finfoots" has been applied—from the lobes or flaps of skin that fringe their toes. Though for a long while placed among the *Podicipedidae* (see GREBE), their osteology no less than their habits appear to indicate their alliance with the rails, and they are placed as a separate family, *Heliornithidae* of the order *Gruiformes*, to which the rails belong; but they seem to show the extreme modification of that type in adaptation to aquatic life. The curious genus *Mesites* of Madagascar, whose systematic place has been so long in doubt, has been referred by A. Milne-Edwards (*Ann. Sc. Naturelle*, ser. 6, vii. art. 2) to the neighbourhood of the rails, but is now associated as a sub-order *Mesitae* with Galliform birds. On the other hand the jacanas or *Parridae*, which from their long toes were once thought to belong

¹ Formerly it seems to have been a popular belief in England that the land-rail in autumn transformed itself into a water-rail, resuming its own characters in spring.

to the rails, are now generally admitted to be Limicoline, while the genus *Aramus*—the courlan or limpkin of the southern United States—still occupies a very undetermined position. (A. N.)

(2) (Through O.Fr. *reille*, from Lat. *regula*, a rule; the Du. and Swed. *regel*, Ger. *Riegel*, bolt or bar, are probably also from the Latin), a horizontal bar of wood, metal or other material resting on, or fixed in, upright posts to form a fence, or as a support for hanging things on, to form the "hand-rail" of a stair, &c.; on a ship the upper part of the bulwarks, e.g. the "taffrail," round the stern bulwarks; especially, one of the pair of iron or steel bars on which a train or tram runs (see RAILWAYS).

There are two other words "rail": (a) an obsolete word (O.E. *hrægel*), for a garment, often in the compound "night-rail"; and (b) a verb, to abuse, use angry language, from Fr. *railler*, possibly from the same root as Lat. *radere*, to scrape. The word is also seen in "rally," to banter, tease (distinguish, however, "rally," to bring together, especially of defeated troops (from Fr. *rallier*; *re*, again, and *allier*, ally, Lat. *alligare*)).

RAILWAYS. Railways had their origin in the tramways (*q.v.*) or wagon-ways which at least as early as the middle of the 16th century were used in the mineral districts of England round Newcastle for the conveyance of coal from the pits to the river Tyne for shipment. It may be supposed that originally the public roads, when worn by the cartage of the coal, were repaired by laying planks of timber at the bottom of the ruts, and that then the planks were laid on the surface of special roads or ways¹ formed between the collieries and the river. "The manner of the carriage," says Lord Keeper North in 1676, "is by laying rails of timber . . . exactly straight and parallel, and bulky carts are made with four rowlets fitting these rails, whereby the carriage is so easy that one horse will draw down four or five chaldrons of coals" (from 10.6 to 13.2 tons). The planks were of wood, often beech, a few inches wide, and were fastened down, end to end, on logs of wood, or "sleepers," placed crosswise at intervals of two or three feet. In time it became a common practice to cover them with a thin sheathing or plating of iron, in order to add to their life; this expedient caused more wear on the wooden rollers of the wagons, and, apparently towards the middle of the 18th century, led to the introduction of iron wheels, the use of which is recorded on a wooden railway near Bath in 1734. But the iron sheathing was not strong enough to resist buckling under the passage of the loaded wagons, and to remedy this defect the plan was tried of making the rails wholly of iron. In 1767 the Colebrookdale Iron Works cast a batch of iron rails or plates, each 3 ft. long and 4 in. broad, having at the inner side an upright ledge or flange, 3 in. high at the centre and tapering to a height of 2½ in. at the ends, for the purpose of keeping the flat wheels on the track. Subsequently, to increase the strength, a similar flange was added below the rail. Wooden sleepers continued to be used, the rails being secured by spikes passing through the extremities, but about 1793 stone blocks also began to be employed—an innovation associated with the name of Benjamin Outram, who, however, apparently was not actually the first to make it. This type of rail (fig. 1) was known as the plate-rail, tramway-plate or barrow-way-plate—names which are preserved in the modern term "platelayer" applied to the men who lay and maintain the permanent way of a railway.



FIG. 1.—Plate-Rail.

Another form of rail, distinguished as the edge-rail, was first used on a line which was opened between Loughborough and Nanpantan in 1789. This line was originally designed as a "plate-way" on the Outram system, but objections were raised to rails with upstanding ledges or flanges being laid on the turnpike road which was crossed at Loughborough on the level. In other cases this difficulty was overcome by paving or "causewaying" the road up to the level of the top of the flanges, but

¹ "Another thing that is remarkable is their way-leaves; for, when men have pieces of ground between the colliery and the river, they sell leave to lead coals over their ground" (Roger North).

on this occasion William Jessop, of the Butterley Iron Works, near Derby, proposed to get over it by laying down two plates of iron, perfectly flat and level with the road but each having on its outside a groove ¼ in. wide and ¼ in. deep to control extra guiding wheels which were to be of somewhat larger diameter than the bearing wheels and to be affixed to them. The rest of the line was laid with what were substantially plate-rails placed on their edge instead of flat. These were cast in 3 ft. lengths, of a double-flanged section, and for the sake of strength they were "fish-bellied" or deeper in the middle than at the ends. At one end of each rail the flange spread out to form a foot which rested on a cross sleeper, being secured to the latter by a spike passing through a central hole, and above this foot the rail was so shaped as to form a socket into which was fitted the end of the next rail. Each length was thus fastened to a sleeper at one end, while at the other it was socketed into the end of its fellow. This method, however, was not found satisfactory: the projecting feet were liable to be broken off, and in 1799 or 1800 Jessop abandoned them, using instead separate cast-iron sockets or chairs, which were fastened to the sleepers and in which the rails were supported in an upright position. In the first instance he proposed to place the guiding wheels outside the bearing wheels, and the Nanpantan line was laid on this plan with a width of 5 ft. between the guide wheels; but before it was opened he decided not only to cast the guiding wheels and bearing wheels in one piece but also to put the former inside the rails, arguing that with this arrangement the edge-rails themselves would keep the wheels in position on the axles, whereas with that first contemplated fastenings would have been required for them (fig. 2). Jessop thus produced what was virtually the flanged wheel of to-day, having the flanges inside the rails, and further, it is said, established what has become the standard gauge of the world, 4 ft. 8½ in., or 5 ft. minus the width of two of his rails.

These two systems of constructing railways—the plate-rail and the edge-rail—continued to exist side by side until well on in the 19th century. In most parts of England the plate-rail was preferred, and it was used on the Surrey iron railway, from Wandsworth to Croydon, which, sanctioned by parliament in 1801, was finished in 1803, and was the first railway available to the public on payment of tolls, previous lines having all been private and reserved exclusively for the use of their owners. In South Wales again, where in 1811 the railways in connexion with canals, collieries and iron and copper works had a total length of nearly 150 miles, the plate-way was almost universal. But in the north of England and in Scotland the edge-rail was held in greater favour, and by the third decade of the century its superiority was generally established. The manufacture of the rails themselves was gradually improved. By making them in longer lengths a reduction was effected in the number of joints—always the weakest part of the line; and another advance consisted in the substitution of wrought iron for cast iron, though that material did not gain wide adoption until after the patent for an improved method of rolling rails granted in 1820 to John Birkinshaw, of the Bedlington Ironworks, Durham. His rails were wedge-shaped in section, much wider at the top than at the bottom, with the intermediate portion or web thinner still, and he recommended that they should be made 18 ft. long, even suggesting that several of them might be welded together end to end to form considerable lengths. They were supported on sleepers by chairs at intervals of 3 ft., and were fish-bellied between the points of support. As used by George Stephenson on the Stockton & Darlington and Whitstable & Canterbury lines they weighed 28 lb per yard. On the Liverpool & Manchester railway they were usually 12 ft. or 15 ft. long and weighed 35 lb to the yard, and they were fastened by iron wedges to chairs weighing 15 or 17 lb each. The chairs were



FIG. 2.—Edge-Rail.

in turn fixed to the sleepers by two iron spikes, half-round wooden cross sleepers being employed on embankments and stone blocks 20 in. square by 10 in. deep in cuttings. The fish-bellied rails, however, were found to break near the chairs, and from 1834 they began to be replaced with parallel rails weighing 50 lb to the yard.

The next important development in rail design originated in America, which, for the few lines that had been laid up to 1830, remained content with wooden bars faced with iron. In that year Robert Livingston Stevens (1787-1856), devised for the Camden & Amboy railway a rail similar as to its top to those in use in England, but having a flat base or foot by which it was secured to the sleepers by hook-headed spikes, without chairs (fig. 3); he had to get the first lot of these rails, which were 15 ft. long and weighed 36 lb to the yard, manufactured in England, since there were then no mills in America able to roll them. This type, which is often known as the Vignoles rail, after Charles Blacker Vignoles (1793-1875), who re-invented it in England in 1836, is in general use in America and on the continent of Europe. The bridge-rail (fig. 4)—so called because it was



FIG. 3.—Flat-Bottomed Rail.



FIG. 4.—Bridge-Rail.

first laid on bridges—was supported on continuous longitudinal sleepers and held down by bolts passing through the flanges, and was employed by I. K. Brunel on the Great Western railway, where, however, it was abandoned after the line was converted from broad to standard gauge in 1892. In the double-headed rail (fig. 5), originated by Joseph Locke in 1837, and first laid on the Grand Junction railway, the two tables were equal. This rail was more easily rolled than others, and, being reversible, was in fact two rails in one. But as it was laid in cast-iron chairs the lower table was exposed to damage under the hammering of the traffic, and thus was liable to be rendered useless as a running surface. In consequence the bull-headed rail (fig. 6)



FIG. 5.—Double-Headed Rail.



FIG. 6.—Bull-Headed Rail.

was evolved, in which the lower table was made of smaller size and was intended merely as a support, not as a surface to be used by the wheels. There was a waste of metal in these early rails owing to the excessive thickness of the vertical web, and subsequent improvements have consisted in adjusting the dimensions so as to combine strength with economy of metal, as well as in the substitution of steel for wrought iron (after the introduction of the Bessemer process) and in minute attention to the composition of the steel employed.

It was found, naturally, that the rails would not rest in their chairs at the joints, but were loosened and bruised at the ends by the blows of the traffic. The fish-joint was therefore devised in 1847 by W. Bridges Adams, the intention being by "fishing" the joints to convert the rails into continuous beams. In the original design two chairs were placed, one under each rail, a few inches apart, as in fig. 7. The joint was thus suspended between the two chairs, and two keys of iron, called "fishes," fitting the side channels of the rails, were driven in on each side between the chairs and the rails. In subsequent modifications the fishes were, as they continue to be, bolted to and through the rails, the sleepers being placed rather further apart and the joint being generally suspended between them.

The iron tramway or railway had been known for half a

century and had come into considerable use in connexion with collieries and quarries before it was realized that for the carriage

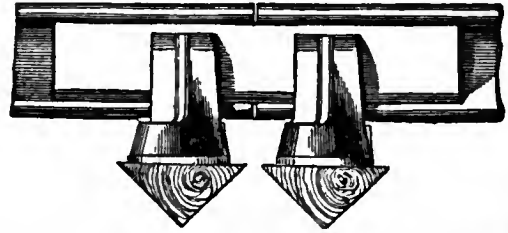

FIG. 7.—The original Fish-Joint of W. Bridges Adams.

of general merchandise it might prove a serious competitor to the canals, of which a large mileage had been constructed in Great Britain during that period. In the article on "Railways" in the Supplement to the *Encyclopaedia Britannica*, published in 1824, it is said: "It will appear that this species of inland carriage [railways] is principally applicable where trade is considerable and the length of conveyance short; and is chiefly useful, therefore, in transporting the mineral produce of the kingdom from the mines to the nearest land or water communication, whether sea, river or canal. Attempts have been made to bring it into more general use, but without success; and it is only in particular circumstances that navigation, with the aid either of locks or inclined planes to surmount the elevations, will not present a more convenient medium for an extended trade." It must be remembered, however, that at this time the railways were nearly all worked by horse-traction, and that the use of steam had made but little progress. Richard Trevithick, indeed, had in 1804 tried a high-pressure steam locomotive, with smooth wheels, on a plate-way near Merthyr Tydvil, but it was found more expensive than horses; John Blenkinsop in 1811 patented an engine with cogged wheel and rack-rail which was used, with commercial success, to convey coal from his Middleton colliery to Leeds; William Hedley in 1813 built two locomotives—Puffing Billy and Wylam Dilly—for hauling coal from Wylam Colliery, near Newcastle; and in the following year George Stephenson's first engine, the Blucher, drew a train of eight loaded wagons, weighing 30 tons, at a speed of 4 m. an hour up a gradient of 1 in 450. But, in the words of the same article, "This application of steam has not yet arrived at such perfection as to have brought it into general use."

The steam locomotive, however, and with it the railways, soon began to make rapid progress. On the Stockton & Darlington railway, which was authorized by parliament in 1821, animal power was at first proposed, but on the advice of Stephenson, its engineer, steam-engines were adopted. This line, with three branches, was over 38 m. in length, and was in the first instance laid with a single track, passing-places being provided at intervals of a quarter of a mile. At its opening, on the 27th of September 1825, a train of thirty-four vehicles, making a gross load of about 90 tons, was drawn by one engine driven by Stephenson, with a signalman on horseback in advance. The train moved off at the rate of from 10 to 12 m. an hour, and attained a speed of 15 m. an hour on favourable parts of the line. A train weighing 92 tons could be drawn by one engine at the rate of 5 m. an hour. The principal business of the new railway was the conveyance of minerals and goods, but from the first passengers insisted upon being carried, and on the 10th of October 1825 the company began to run a daily coach, called the "Experiment," to carry six inside, and from fifteen to twenty outside, making the journey from Darlington to Stockton and back in two hours. The fare was 1s., and each passenger was allowed to take baggage not exceeding 14 lb weight. The rate for carriage of merchandise was reduced from 5d. to one-fifth of a penny per ton per mile, and that of minerals from 7d. to 1½d. per ton per mile. The price of coals at Darlington fell from 18s. to 8s. 6d. a ton.

The example of the Stockton & Darlington line was followed by the Monklands railway in Scotland, opened in 1826, and several other small lines—including the Canterbury &

Whitstable, worked partly by fixed engines and partly by locomotives—quickly adopted steam traction. But the Liverpool & Manchester railway, opened in 1830, first impressed the national mind with the fact that a revolution in the methods of travelling had really taken place; and further, it was for it that the first high-speed locomotive of the modern type was invented and constructed. The directors having offered a prize of £500 for the best engine, trials were held on a finished portion of the line at Rainhill in October 1829, and three engines took part—the Rocket of George and Robert Stephenson, the Novelty of John Braithwaite and John Ericsson, and the Sanspareil of Timothy Hackworth. The last two of these engines broke down under trial, but the Rocket fulfilled the conditions and won the prize. Its two steam cylinders were 8 in. in diameter, with a stroke of $16\frac{1}{2}$ in., and the driving wheels, which were placed in front under the funnel, were 4 ft. $8\frac{1}{2}$ in. in diameter. The engine weighed $4\frac{1}{2}$ tons; the tender following it, 3 tons 4 cwt.; and the two loaded carriages drawn by it on the trial, 9 tons 11 cwt.: thus the weight drawn was $12\frac{1}{2}$ tons, and the gross total of the train 17 tons. The boiler evaporated $18\frac{1}{4}$ cub. ft., or 114 gals., of water an hour, and the steam pressure was 50 lb per square inch. The engine drew a train weighing 13 tons 35 m. in 48 minutes, the rate being thus nearly 44 m. an hour; subsequently it drew an average gross load of 40 tons behind the tender at 13.3 m. an hour. The Rocket possessed the three elements of efficiency of the modern locomotive—the internal water-surrounded fire-box and the multitubular flue in the boiler; the blast-pipe, by which the steam after doing its work in the cylinders was exhausted up the chimney, and thus served to increase the draught and promote the rapid combustion of the fuel; and the direct connexion of the steam cylinders, one on each side of the engine, with the two driving wheels mounted on one axle. Of these features, the blast-pipe had been employed by Trevithick on his engine of 1804, and direct driving, without intermediate gearing, had been adopted in several previous engines; but the use of a number (25) of small tubes in place of one or two large flues was an innovation which in conjunction with the blast-pipe contributed greatly to the efficiency of the engine. After the success of the Rocket, the Stephensons received orders to build seven more engines, which were of very similar design, though rather larger, being four-wheeled engines, with the two driving wheels in front and the cylinders behind; and in October 1830 they constructed a ninth engine, the Planet, also for the Liverpool & Manchester railway, which still more closely resembled the modern type, since the driving wheels were placed at the fire-box end, while the two cylinders were arranged under the smoke-box, inside the frames. The main features of the steam locomotive were thus established, and its subsequent development is chiefly a history of gradual increase in size and power, and of improvements in design, in material and in mechanical construction, tending to increased efficiency and economy of operation.

In America the development of the locomotive dates from almost the same time as in England. The earliest examples used in that country, apart from a small experimental model constructed by Peter Cooper, came from England. In 1828, on behalf of the Delaware & Hudson Canal Company, which had determined to build a line, 16 m. long, from Carbondale to Honesdale, Pennsylvania, Horatio Allen ordered three locomotives from Messrs Foster & Rastick, of Stourbridge, and one from George Stephenson. The latter, named the America, was the first to be delivered, reaching New York in January 1829, but one of the others, the Stourbridge Lion, was actually the first practical steam locomotive to run in America, which it did on the 9th of August 1829. The first American-built locomotive, the Best Friend, of Charleston, was made at the West Point Foundry, New York, in 1830, and was put to work on the South Carolina railroad in that year. It had a vertical boiler, and was carried on four wheels all coupled, the two cylinders being placed in an inclined position and having a bore of about 6 in. with a stroke of 16 in. It

is reported to have hauled 40 or 50 passengers in 4 or 5 cars at a speed of 16–21 m. an hour. After a few months of life it was blown up, its attendant, annoyed by the sound of the escaping steam, having fastened down the safety-valve. A second engine, the West Point, also built at West Point Foundry for the South Carolina railroad, differed from the Best Friend in having a horizontal boiler with 6 or 8 tubes, though in other respects it was similar. In 1831 the Baltimore & Ohio Company offered a prize of \$4000 for an American engine weighing $3\frac{1}{2}$ tons, able to draw 15 tons at 15 m. an hour on the level: it was won by the York of Messrs Davis & Gartner in the following year. Matthias W. Baldwin, the founder of the famous Baldwin Locomotive Works in Philadelphia, built his first engine, Old Ironsides, for the Philadelphia, Germantown & Morristown railroad; first tried in November 1832, it was modelled on Stephenson's Planet, and had a single pair of driving wheels at the fire-box end and a pair of carrying wheels under the smoke-box. His second engine, the E. L. Miller, delivered to the South Carolina railroad in 1834, presented a feature which has remained characteristic of American locomotives—the front part was supported on a four-wheeled swivelling bogie-truck, a device, however, which had been applied to Puffing Billy in England when it was rebuilt in 1815.

The Liverpool & Manchester line achieved a success which surpassed the anticipations even of its promoters, and in consequence numerous projects were started for the construction of railways in various parts of Great Britain. In the decade following its opening nearly 2000 m. of railway were sanctioned by parliament, including the beginnings of most of the existing trunk-lines, and in 1840 the actual mileage reached 1331 m. The next decade saw the "railway mania." The amount of capital which parliament authorized railway companies to raise was about $4\frac{1}{2}$ millions on the average of the two years 1842–1843, $17\frac{1}{2}$ millions in 1844, 60 millions in 1845, and 132 millions in 1846, though this last sum was less than a quarter of the capital proposed in the schemes submitted to the Board of Trade; and the wild speculation which occurred in railway shares in 1845 contributed largely to the financial crisis of 1847. In 1850 the mileage was 6635, in 1860 it was 10,410, and in 1870 it was 15,310. The increase in the decade 1860–1870 was thus nearly 50%, but subsequently the rate of increase slackened, and the mileages in 1880, 1890 and 1900 were 17,935, 20,073 and 21,855. In the United States progress was more rapid, for, beginning at 2816 in 1840, the mileage reached 9015 in 1850, 30,600 in 1860, 87,801 in 1880, and 198,964 in 1900. Canada had no railway till 1853, and in South America construction did not begin till about the same time. France and Austria opened their first lines in 1828; Belgium, Germany, Russia, Italy and Holland in the succeeding decade; Switzerland and Denmark in 1844, Spain in 1848, Sweden in 1851, Norway in 1853, and Portugal in 1854; while Turkey and Greece delayed till 1860 and 1869. In Africa Egypt opened her first line (between Alexandria and Cairo) in 1856, and Cape Colony followed in 1860. In Asia the first line was that between Bombay and Tannah, opened in 1853, and in Australia Victoria began her railway system in 1854 (see also the articles on the various countries for further details about their railways).

Transcontinental Railways.—A railway line across North America was first completed in 1869, when the Union Pacific, building from the Missouri river at Omaha (1400 m. west of New York), met the Central Pacific, which built from San Francisco eastwards, making a line 1848 m. long through a country then for the most part uninhabited. This was followed by the Southern Pacific in 1881, from San Francisco to New Orleans, 2489 miles; the Northern Pacific, from St Paul to Portland, Ore., in 1883; the Atchison, Topcka & Santa Fé, from Kansas City to San Diego; and the Great Northern from St Paul to Seattle and New Westminster in 1893. Meanwhile the Canadian Pacific, a true transcontinental line, was built from Montreal, on Atlantic tide-water, to the Pacific at Vancouver, 2906 m. But these lines have been

dwarfed since 1891 by the Siberian railway, built by the Russian government entirely across the continent of Asia from Cheliabinsk (1769 m. by rail east of St Petersburg) to Vladivostok, a distance of 4073 m., with a branch from Kharbin about 500 m. long to Dalny and Port Arthur. The main line was finished in 1902, except for a length of about 170 m. in very difficult country around the south end of Lake Baikal; this was constructed in 1904, communication being maintained in the interval by ferry-boats, which conveyed all the carriages of a train across the lake, more than 40 m., when the ice permitted. A transcontinental line was long ago undertaken across South America from Buenos Aires to Valparaiso, where the continent is only about 900 m. wide. The last section through the Andes was finished in 1910. (H. M. R.)

GENERAL STATISTICS

Mileage.—At the close of 1907 there were approximately 601,808 miles of railway in the world, excluding tramways. On the whole, the best statistical source for this information is the annual computation published by the *Archiv für Eisenbahnwesen*, the official organ of the Prussian Ministry of Public Works; but the figure quoted above utilizes the Board of Trade returns for the United Kingdom and the report of the Interstate Commerce Commission for the United States. In the United States and in certain other countries, a fiscal year, ending on the 30th of June or at some other irregular period, is substituted for the calendar year.

The partition of this total between the principal geographical divisions of the world is given in Table I.

TABLE I.—MILEAGE OF THE WORLD

	Miles.		Miles.
Europe	199,371	Africa	18,516
America	309,974	Australia	17,766
Asia	56,181		

Table II., classifying the mileage of Europe, shows that Russia has taken the lead, instead of Germany, as in former years. If the Asiatic portions of the Russian Empire were given in the same table, the total Russian mileage would appear nearly as large as that of Germany and Italy together.

TABLE II.—RAILWAYS OF EUROPE IN 1907

	Miles.		Miles.
Germany	36,066	Portugal	1,689
Austria-Hungary, including Bosnia and Herzegovina	25,853	Denmark	2,141
Great Britain and Ireland	23,108	Norway	1,607
France	29,717	Sweden	8,322
European Russia, including Finland	36,280	Servia	379
Italy	10,312	Rumania	1,995
Belgium	4,874	Greece	771
Holland	2,230	European Turkey, Bulgaria, Rumelia	1,968
Switzerland	2,763	Malta, Jersey, Isle of Man	68
Spain	9,228		
		Total	199,371

In the United States railway mileage now tends to increase at the rate of slightly over 5000 miles a year, which is about 2½% on the present main line mileage. In the 'eighties, the country passed through a period of competitive building, which was productive of much financial disaster. Thus, in 1882, 11,569 m. were built—an addition equivalent to more than 11% of mileage then existing—and in 1887, 12,876 m. were built. Unjustifiable railway expansion had much to do with the American commercial panics of 1884 and 1893. After the reconstruction period of the 1893 panic, however, the tendency for a number of years was to spend larger sums in bettering existing railways rather than in new extensions. The decade from 1896 until 1905, inclusive, saw huge sums spent on yards, passing tracks, grade reduction, elimination of curves, substitution of large locomotives and cars for small ones, &c. During those ten years, the route mileage increased 34,991 m., or 17%, while the mileage of second, third, fourth and yard tracks and sidings increased 32,666 m., or nearly 57%. The number of locomotives increased 12,407, or 35%, and the number of freight cars, 545,222, or 42%. Moreover, the average tractive power per locomotive and the average capacity per freight car advanced greatly in this period, although specific figures cannot be given.

Thus it may fairly be said that the railway system of the United States was reconstructed between 1896 and 1905, so far as concerns rails, sleepers, ballast and the general capacity of a given group of lines to perform work. About 1905, however, a new tendency became apparent. At that time the so-called transcontinental

railways, connecting the Pacific coast of the United States with the central portions of the country, and thus with the group of railways reaching the Atlantic seaboard, consisted of five railways within the borders of the United States, and one in Canada. In Canada the Canadian Pacific was the only transcontinental line, extending from St John, on the bay of Fundy, and from Quebec, on the river St Lawrence, to Vancouver, on the strait of Georgia, the distance from St John to Vancouver being approximately 3379 m. Within the boundaries of the United States the northernmost of the transcontinental lines was the Great Northern railway, extending from a point opposite Vancouver, B.C., and from Seattle, Wash., to Duluth, on Lake Superior, and to St Paul and Minneapolis, Minn., where connexion through to Chicago was made over an allied line, the Chicago, Burlington & Quincy, owned jointly by the Great Northern and the Northern Pacific.

Next, south of the Great Northern, lay the Northern Pacific railway, starting on the west from Portland, Ore., and from Seattle and Tacoma, Wash., and extending east to Duluth, St Paul and Minneapolis by way of Helena, Mont. The Central Pacific—Union Pacific route to the coast, with its important affiliated companies, the Oregon Short Line and the Oregon Railroad & Navigation Company, extended from San Francisco, Cal., and Portland, Ore., to Omaha, Neb., by way of Salt Lake City; the Atchison, Topeka & Santa Fé extended from San Francisco and Los Angeles, Cal., to Chicago and to Galveston, Tex.; while the Southern Pacific had its line from San Francisco and Los Angeles to Galveston and New Orleans, running for the greater part of the distance just north of the Mexican border.

Thus it will be observed that the five great cities of the Pacific coast—Seattle and Tacoma, Wash., Portland, Ore., and San Francisco and Los Angeles, Cal.—were already well supplied with railways; but the growth of the fertile region lying west of the transcontinental divide was most attractive to American railway builders; and railways serving this district, almost all of them in trouble ten years before, were showing great increases in earnings. In 1903 the Gould lines determined to enter this Pacific territory. Hitherto the western terminus of this group of lines had been Salt Lake City, Utah; by the exceedingly bold construction of the Western Pacific from Salt Lake City to Oakland, Cal., opposite San Francisco, an additional line to the Pacific coast was provided, having low grades and being in all respects well adapted for cheap operation.

Shortly after the plans were announced for building the Western Pacific, the Chicago, Milwaukee & St Paul also decided to extend west. Before that time the St Paul had been a great local railway, operating primarily in the Dakotas, Minnesota, Iowa, Wisconsin and Illinois; but by the construction of a long arm from the Missouri river to Spokane, Seattle and Tacoma, it became a transcontinental line of the first importance, avoiding the mistakes of earlier railway builders by securing a line with easy gradients through the most favourable regions.

At the same time that these two extensions were being undertaken by old and well-established railways, a new company—the Kansas City, Mexico & Orient—was engaged in constructing a line almost due south-west from Kansas City, Mo., to the lower part of the gulf of California in Mexico; while an additional independent line was under construction from Denver in a north-westerly direction towards the Pacific coast. The guarantee for this activity may be illustrated by a single fact: the combined building operations, in 1908, of San Francisco, Seattle, Portland, Los Angeles, Spokane and Salt Lake City exceeded the combined building operations of Philadelphia, Pittsburg, Kansas City, Boston, Baltimore and Cincinnati during the same year. San Francisco spent more in new permanent structures than Philadelphia, and Seattle spent more than Pittsburg.

Recent American railway development, viewed in its larger aspects, has thus been characterized by what may be described as the rediscovery of the Pacific coast. How far this movement will extend it is impossible to say; it is certain, however, that it will be enormously important in re-aligning trade conditions in the United States, Canada and Mexico.

Table III. illustrates the railway mileage in the continent of America at the close of 1907.

TABLE III.—RAILWAYS OF AMERICA IN 1907

	Miles.		Miles.
United States	236,949	Dutch Guiana	37
Canada	22,452	Ecuador	186
Newfoundland	666	Peru	1,332
Mexico	13,612	Bolivia	702
Central America	1,392	Brazil	10,714
Greater Antilles	2,430	Paraguay	157
Lesser Antilles	336	Uruguay	1,210
Colombia	449	Chile	2,939
Venezuela	634	Argentina	13,673
British Guiana	104		
		Total	309,974

Outside the United States and Canada, the most interesting American developments are in Mexico and Argentina, these countries

having nearly the same amount of railway mileage. In Mexico the national government is carrying out a consistent policy of developing its railway lines. It has succeeded in restoring the credit of these enterprises, and is proceeding with care and skill to form the lines into an efficient transportation system. In Argentina about 15% of the railways are owned and operated by the government, the balance being in the hands of private companies, largely controlled in England. Development of these lines has been primarily an extension from the large cities in the East to the agricultural districts in the West, but a change of great importance was brought about in 1910 by the completion of the last tunnel on the Argentine Transandine Railway, which serves to connect Santiago, Valparaiso and the other great cities of the west coast with Buenos Aires, Montevideo, Bahia, Rio de Janeiro and the other great cities of the east coast. Naturally the company named does not reach all of these points, but its line across the Andes supplies the indispensable link of communication, in the absence of which the east coast towns and the west coast towns have hitherto been as widely separated as if they had been located on different continents—indeed, far more widely separated in point of time and of freight charges than Great Britain and the United States.

Table IV. shows as closely as possible the railway route mileage open in Asia at the close of 1907.

TABLE IV.—RAILWAYS OF ASIA IN 1907

Miles.	Miles.
Central Russia in Asia 2,808	Malay States 636
Siberia and Manchuria 5,565	Dutch East Indies 1,509
China 4,162	Siam 571
Korea 688	Ceylon 561
Japan 5,013	Cochin China } 1,761
British India 29,893	Cambodia }
Persia 33	Annam }
Asia Minor, Syria, Arabia and Cyprus 2,930	Tonkin }
Portuguese East Indies 51	Pondicherry }
	Malacca }
	Philippines }
	Total 56,181

Although more than half of the total mileage of Asia is in British India, it is probable that the greatest proportionate gains in the near future will be in China, Siberia and Manchuria, and Central Russia in Asia. In proportion to its population China has the least railway development of any of the great countries of the world; the probability that its present commercial awakening will extend seems large, and in that case it will need a vast increase in its interior communications.

In Africa, it will be seen by Table V. that the railway mileage in the British possessions amounts to almost five-sixths of the total.

TABLE V.—RAILWAYS OF AFRICA IN 1907

Miles.	Miles.
Egypt 3,445	British Provinces, except South Africa 1,235
Algiers and Tunis 3,049	French Provinces 1,246
Congo States 399	Italian Provinces 71
Abyssinia 192	Portuguese Provinces 703
British South Africa 7,028	
German Provinces 1,148	
	Total 18,516

The so-called Cape-to-Cairo route shows occasional extensions, particularly in the opening up of new country in Central Africa by the Rhodesian railway system. The Rhodesian railway system in 1910 had penetrated north of Broken Hill, which is just above the fifteenth parallel of south latitude, while the Egyptian railway system had reached Gondokoro, located close to the fifth parallel of north latitude. The intervening distance, through country exceedingly unhealthy for white men, and therefore promising no traffic except raw materials, does not seem a likely field for rapid railway extension.

In Australia the increase in railway mileage in the five years ending December 31st, 1907 was about 7%—a small proportion as compared with America, Asia or Africa. The greatest increase, both relative and absolute, was in Queensland; the smallest in South Australia, which added only 24 m. during the five years. Yet the mileage open per 10,000 inhabitants in Australia, as a whole, far surpasses that in any other of the broad geographical divisions.

TABLE VI.—RAILWAYS OF AUSTRALIA IN 1907

Miles.	Miles.
New Zealand 2,571	Queensland 3,405
Victoria 5,517	Tasmania 620
New South Wales 3,471	West Australia 2,259
South Australia 1,924	Hawaiian Group 88
	Total 19,855

Table VII. illustrates the mileage open to the end of 1907 per 100 sq. m. of territory and per 10,000 inhabitants. It will be observed that Belgium leads all the countries of the world in what may be called its railway density, with the United Kingdom a far-distant second in the list, and Persia last. In railway mileage per 10,000 inhabitants, however, Queensland, in the Australian group, reports a figure much greater than any other country; while at the other end of the list Persia holds the record for isolation.

TABLE VII.—MILES OPEN AT THE END OF 1907

Europe	Per 100 sq. miles.	Per 10,000 inhabitants.
Germany	17.2	6.4
Austro-Hungary	10.0	5.5
United Kingdom	19.0	5.6
France	14.2	7.6
Russia in Europe, including Finland	1.8	3.4
Italy	9.3	3.2
Belgium	42.8	7.3
Holland	15.0	3.9
Switzerland	17.2	8.3
Spain	4.8	5.2
Portugal	4.7	3.1
Denmark	14.3	8.7
Norway	1.3	7.2
Sweden	4.8	16.2
Servia	2.1	1.5
Rumania	3.2	3.4
Greece	3.1	3.2
Turkey in Europe, Bulgaria, Rumelia	1.9	2.0
Malta, Jersey, Man	16.1	1.9
Total	5.3	5.1

America, 1907

	Per 100 sq. miles.	Per 10,000 inhabitants.
United States	6.4	26.8
Canada	0.6	42.1
Newfoundland	1.6	31.1
Mexico	1.8	9.4
Colombia	0.08	1.0
Venezuela	0.16	2.6
British Guiana	0.11	3.5
Ecuador	0.16	1.3
Peru	0.32	2.9
Bolivia	0.16	3.1
Brazil	0.32	7.1
Paraguay	0.16	2.5
Uruguay	1.8	13.0
Chile	1.0	8.9
Argentina	1.3	28.0

Asia, 1907

	Per 100 sq. miles.	Per 10,000 inhabitants.
Central Russia in Asia	1.3	3.6
Siberia and Manchuria	0.11	9.8
China	0.1	0.12
Korea	0.8	0.68
Japan	3.1	1.1
British India	1.4	1.0
Ceylon	2.3	1.6
Persia	0.005	0.04
Asia Minor, Syria, Arabia, Cyprus	0.5	1.5
Portuguese Indies	3.5	0.9
Malay Archipelago	1.9	8.8
Dutch Indies	0.6	0.5
Siam	0.16	0.6

Africa, 1907

	Per 100 sq. miles.	Per 10,000 inhabitants.
Egypt	1.0	3.5
Algiers and Tunis	0.8	4.5
Cape Colony	1.3	21.6
Natal	3.5	12.6
Transvaal	1.1	15.7
Orange Colony	1.8	42.6

Complete estimates for the balance of Africa not available.

¹ No accurate returns for Central America, Greater and Lesser Antilles and Dutch Guiana.

² Estimates of area and population incomplete for Cochin China, Cambodia, Annam, Tonkin, Pondicherry, Malacca and Philippines.

Australia, 1907		Per 100	Per 10,000
		sq. miles.	inhabitants.
New Zealand		2.4	30.9
Victoria		3.9	28.5
New South Wales		1.1	25.4
South Australia		0.16	53.0
Queensland		0.5	70.2
Tasmania		2.4	36.0
West Australia		0.16	54.8
Hawaiian Group		1.3	8.1
Total		0.6	35.9

Capital.—The total construction capital invested in the railways of the world in 1907 was estimated by the *Archiv für Eisenbahnwesen* at £8,986,150,000; the figure is necessarily incomplete, though it serves as a rough approximation. This total was divided nearly evenly between the countries of Europe and the rest of the world. The United States of America, with a capital of £3,059,800,000 invested in its railways on the 30th of June 1906, was easily ahead of every other country, and in 1908 the figure was increased to £3,443,027,685, of which £2,636,569,089 was in the hands of the public. On a route-mileage basis, however, the capital cost of the British railway system is far greater than that of any other country in the world, partly because a vast proportion of the lines are double, treble or even quadruple, partly because the safety requirements of the Board of Trade and the high standards of the original builders made actual construction very costly.

The total paid-up railway capital of the United Kingdom amounted, in 1908, to £1,310,533,212, or an average capitalization of £56,476 per route mile, though it should be noted that this total included £196,364,618 of nominal additions through "stock-splitting," &c. Per mile of single track, the capitalization in England and Wales, Scotland, Ireland and the United Kingdom, is shown in Table VIII.

TABLE VIII.—PAID-UP CAPITAL, 1908

	Route Miles.	Single-Track Miles.	Paid-up Capital.	Paid-up Capital per Route Mile.	Paid-up Capital per Single-Track Mile.
England and Wales	15,999	29,748 ¹	£1,080,138,674	£67,513	£36,309 ¹
Scotland	3,843	4,531 ¹	185,345,494	48,229	33,510 ¹
Ireland	3,363	4,037	45,049,044	13,396	11,159
United Kingdom	23,205	39,316	1,310,533,212	56,476	33,333

The table excludes sidings, because they cannot fairly be compared with running tracks, mile for mile. Yet the mileage of sidings in the United Kingdom amounted to 14,353 in 1908, and the cost of constructing them was probably not far from £60,000,000.

On a single-track-mile basis, the following comparison may be made between apparent capital costs in Great Britain and the United States:—

	Single-Track Mileage.	Paid-up Capital per Mile.
United Kingdom, 1908	39,316	£33,333
United States, 1908	254,192	10,372 ²

The figures for the United States are from the report of the Interstate Commerce Commission for the year ended 30th of June 1908, and comprise mileage of first, second, third and fourth tracks, and paid-up capital in the hands of the public only. The British figures are from the Board of Trade returns for the calendar year 1908. In comparing the figures, it should be noted that main line mileage in the Eastern states, as for example that of the Pennsylvania railroad and the New York, New Haven & Hartford, does not differ greatly in standards of safety or in unit cost from the best British construction, although improvement work in America is charged to income far more liberally than it has been in England. But there are long stretches of pine loam in the South where branch lines can be, and are, built and equipped for £2400 or less per mile, while the construction of new main line in the prairie region of the West ought not to cost more than £4000 per single-track-mile, under present conditions.

The problem of the early railway builders in the United States was to conquer the wilderness, to build an empire, and at the same time to bind the East to the West and the North to the South. There can be little doubt but that the United States would long ago have disintegrated into separate, warring republics, had they not been bound together by railways, and standards of safety were

rightly subordinated to the main task to be accomplished. Conquest is not usually bloodless, whether achieved at the van of a marching column or at the head of a hastily-built railway, and the process under which the American railway system took form left the way open for a distressing record of accidents to the traveller and the railway servant. But as traffic becomes more dense, year by year, the rebuilding process is constant, and American railway lines are gradually becoming safer.

In Europe the average route-mile capital is £27,036, and Table IX. shows the differences between various countries.

TABLE IX.—ROUTE-MILE CAPITAL IN EUROPE

Germany (1907)	£22,298
France (1905)	25,285
Belgium (State railways 1906)	35,381
Italy (State railways 1906-7)	26,008
Denmark (State railways 1907-8)	10,433
Norway (1907-8)	8,027
Sweden (1905)	6,647
Russia (excluding Finland; 1905)	16,534
Finland (State railways 1907)	7,300

Statistical Study of Railway Operation.—The study of railway operation through statistics has two distinct aspects. It has been well said that statistics furnish the means by which the railway manager disciplines his property; this is the aspect of control. On the other hand, the banker, the government official and the economist use railway statistics to obtain information which may be characterized as static rather than dynamic. Both uses ultimately rest upon comparison of the observed data from a certain property with the observed data from other properties, or with predetermined standards of performance.

In general, the British working unit supplied as public information has always been the goods-train-mile and the passenger-train-mile, these figures being the products of the number of trains into the number of miles they have travelled. In America, the basic units have been the ton-mile and the passenger-mile, and these figures are now required to be furnished to the Interstate Commerce Commission and to most of the state commissions as well. Both the British manager and the American manager, however, are supplied with a considerable number of daily, weekly and monthly reports, varying on different railways, which are not made public. The daily sheets usually include a summarized statement of the performance of every train on the line, covering the amount of business done, the destination of the loads, &c. For a number of years there has been a movement in Great Britain to require the inclusion of ton-mile statistics in the stated returns to the Board of Trade, but most railway managers have objected to the change on the ground that their own confidential information was already adequate for purposes of control, and that ton-mile statistics would require additional clerical force to a costly extent. The Departmental Committee of the Board of Trade, sitting in 1909 to consider railway accounting forms, while recommending ton-miles to the careful consideration of those responsible for railway working in Great Britain, considered the question of their necessity in British practice to be still open, and held that, at all events, they should not be introduced under compulsion.

REFERENCES.—*Annual Reports of the Interstate Commerce Commission*; *Poor's Manual of Railroads* (annual, New York); *Statistical Abstract of the United States* (annual, Washington, published by the U. S. Bureau of Statistics); A. T. Hadley, *Railroad Transportation, Its History and Laws* (New York, 1885); E. R. Johnson, *American Railway Transportation* (New York, 1908); L. G. McPherson, *Railroad Freight Rates* (New York, 1909); S. Daggett, *Railroad Reorganization* (Boston, 1908); M. L. Byers, *Economics of Railway Operation* (New York, 1908); E. R. Dewsnup (ed.), *Railway Organization and Working* (Chicago, 1906); *Interstate Commerce Commission; Rate Regulation Hearings before the U.S. Senate Committee* (Washington, 5 vols., 1905); and on current matters, *The Official Railway Guide* (monthly, New York), the *Railroad Age Gazette* (weekly, New York) and the *Commercial and Financial Chronicle* (weekly, New York). (R. Mo.)

ECONOMICS AND LEGISLATION

It was at one time an axiom of law and of political economy that prices should be determined by free competition. But in the development of the railway business it soon became evident

¹ These figures are derived from a total. They are not exact, but may be taken as representing an approximation correct within one per cent.

² Dollars to pounds sterling @ 4.87.

that no such dependence on free competition was possible, either in practice or in theory. This difficulty is not peculiar to railways; but it was in the history of railway economy and railway control that certain characteristics which are now manifesting themselves in all directions where large investments of fixed capital are involved were first brought prominently to public notice.

For a large number of those who use a railway, competition in its more obvious forms does not and cannot exist. Independent carriers cannot run trains over the same line and underbid one another in offering transportation services. It would be practically impossible for a line thus used by different carriers to be operated either with safety, or with economy, or with the advantage to the public which a centralized management affords. It is equally impossible for the majority of shippers to enjoy the competition of parallel lines. Such duplication of railways involves a waste of capital. If parallel lines compete at all points, they cause ruin to the investors. If they compete at some points and not at others, they produce a discrimination or preference with regard to rates and facilities, which builds up the competitive points at the expense of the non-competitive ones. Such partial competition, with the discrimination it involves, is liable to be worse for the public than no competition at all. It increases the tendency, already too strong, towards concentration of industrial life in large towns. It produces an uncertainty with regard to rates which prevents stability of prices, and is apt to promote the interests of the unscrupulous speculator at the expense of those whose business methods are more conservative. So marked are these evils that such partial competition is avoided by agreements between the competing lines with regard to rates, and by divisions of traffic, or pools, which shall take away the temptation to violate such rate agreements. The common law has been somewhat unfavourable to the enforcement of such agreements, and statutes in the United States, both local and national, have attempted to prohibit them; but the public advantage from their existence has been so great as to render their legal disabilities inoperative. In those parts of the continent of Europe where railways are owned and administered by state authority, the necessity for such agreements is frankly admitted.

But if rates are to be fixed by agreement, and not by competition, what principle can be recognized as a legitimate basis of railway rate-making? The first efforts at railway legislation were governed by the equal mileage principle; that is, the attempt was made to make rates proportionate to the distance. It was, however, soon seen that this was inadmissible. So much of the expense of the handling, both of freight and of passengers, was independent of the length of the journey that a mileage rate sufficiently large for short distances was unnecessarily burdensome for long ones, and was bound to destroy long-distance traffic, if the theory were consistently applied. The system has been retained in large measure in passenger business, but only because of the conflict which inevitably occurs between the authorities and the passengers with regard to the privilege of breaking and resuming a journey when passenger rates are arranged on any other plan. In freight schedules it has been completely abandoned.

A somewhat better theory of rate regulation was then framed, which divided railway expenditures into movement expense, connected with the line in general, and terminal expense, which connected itself with the stations and station service. Under this system each consignment of freight is compelled to pay its share of the terminal expense, independently of distance, plus a mileage charge proportionate to the length of the journey or haul. There has been also a further attempt in England to divide terminal charges into station and service terminals, according to the nature of the work for which compensation is sought. But none of these classifications of expense reaches the root of the matter. A system of charges which compels each piece of traffic to pay its share of the charges for track and for stations overlooks the fundamental fact that a very large part of the expenses of a railway—more than half—is not

connected either with the cost of moving traffic or of handling traffic at stations, but with the cost of maintaining the property as a whole. Of this character are the expenditures necessary for maintenance of way, for general administration and for interest on capital borrowed, which are almost independent of the total amount of business done, and quite independent of any individual piece of business. To say that all traffic must bear its share of these interest and maintenance charges is to impose upon the railways a rate which would cut off much of the long-distance traffic, and much of the traffic in cheap articles, which is of great value to the public, and which, from its very magnitude, is a thing that railways could not afford to lose. It is also a fact that with each recurring decade these general expenses (also called indirect, undistributed or fixed charges) have an increased importance as compared with the particular (direct, distributed or operating) expense attaching naturally to the particular portions of the traffic. For with increased density of population it becomes profitable to make improvements on the original location, even though this may involve increased charges for interest and for some parts of its maintenance, for the sake of securing that economy of operation, through larger train-loads, which such an improved location makes possible.

Whatever the ostensible form of a railway tariff, the contribution of the different shipments of freight to these general expenses is determined on the principle of charging what the traffic will bear. Under this principle, rates are reduced where the increase of business which follows such reduction makes the change a profitable one. They are kept relatively high in those cases where the expansion of business which follows a reduction is small, and where such a change is therefore unprofitable. This theory of charging what the traffic will bear is an unpopular one, because it has been misapplied by railway managers and made an excuse for charging what the traffic will not bear. Rightly applied, however, it is the only sound economic principle. It means taxation according to ability—that ability being determined by actual experiment.

In the practical carrying out of this principle, railways divide all articles of freight into classes, the highest of which are charged two or three, or even four times the rates of the lowest. This classification is based partly upon special conditions of service, which make some articles more economical to carry than others (with particular reference to the question whether the goods are offered to the companies in car-loads or in small parcels), but chiefly with regard to the commercial value of the article, and its consequent ability to bear a high charge or a low one. For each of these classes a rate-sheet gives the actual rate-charge per unit of weight between the various stations covered by the tariff. This rate increases as the distance increases, but not in equal proportion; while the rates from large trade centres to other trade centres at a great distance are not higher than those to intermediate points somewhat less remote; if the law permits, there is a tendency to make them actually a little lower. Besides the system of charges thus prescribed in the classification and rate-sheet, each tariff provides for a certain number of special rates or charges made for particular lines of trade in certain localities, independently of their relation to the general system. If these special rates are published in the tariff, and are offered to all persons alike, provided they can fulfil the conditions imposed by the company, they are known as commodity rates, and are apparently a necessity in any scheme of railway charges. If, however, they are not published, and are given to certain persons as individual favours, they become a prolific source of abuse, and are quite indefensible from the standpoint of political economy.

While the superficial appearance of the railway tariff is different for different countries, and sometimes for different parts of the same country, the general principles laid down are followed in rate-making by all well-managed lines, whether state or private. It is a mistake to suppose that the question of public or private ownership will make any considerable difference in the system of rate-making adopted by a good railway. A state system will be compelled, by the exigencies

of the public treasury, to arrange its rates to pay interest on its securities; a private company will generally be prevented, by the indirect competition of railways in other parts of the country which it serves, from doing very much more than this. The relative merit of the two systems depends upon the question how we can secure the best efficiency and equity in the application of the principles thus far laid down. There are three different systems of control:—

1. *Private operation, subject only to judicial regulation*, was exemplified most fully in the early railway history of the United States. Until 1870 railway companies were almost free from special acts of control; and, in general, any company that could raise or borrow the capital was allowed to build a railway wherever it saw fit. In the United Kingdom there was almost as much immunity from legislative interference with charges, but the companies were compelled to secure special charters, and to conform to regulations made by the Board of Trade in the interests of public safety. The advantage of this relatively free system of railway building and management is that it secures efficient and progressive methods. Most of the improvements in operation and in traffic management have had their origin in one of these two countries. The disadvantage attendant upon this system is that the courts are reluctant to exercise the right of regulation, except on old and traditional lines, and that in the face of new business methods the public may be inadequately protected. There is also this further disadvantage, that in the gradual progress of consolidation railway companies take upon themselves the aspect of large monopolies, of whose apparently unrestricted power the public is jealous. As a result of these difficulties there has been, both in the United Kingdom and in the United States, a progressive increase of legislative interference with railways. In the former the Railway and Canal Traffic Act of 1854 specially prohibited preferences, either in facilities or in rates. The Regulation of Railways Act of 1873 provided for a Railway Commission, which should be so constituted as to take cognizance of cases on the investigation of which the courts were reluctant to enter. Finally, the legislation of 1888 put into the hands of a reorganized Railway Commission and of the Board of Trade powers none the less important in principle because their action has been less in its practical effect than the advocates of active control demanded. In the United States the years from 1870 to 1875 witnessed sweeping and generally ill-considered legislation ("Granger" Acts) concerning railway charges throughout the Mississippi valley; while the years from 1884 to 1887 were marked by more conservative, and for that reason more enforceable, acts, which culminated in the Interstate Commerce Act, prohibiting personal discrimination and gradually restricting discrimination between places, and providing for a National Commission of very considerable power—not to speak of the pooling clause, which was extraneous to the general purpose of the act, and has tended to defeat rather than strengthen its operation.

2. *Operation by private companies, under specific provisions of the government authorities with regard to the method of its exercise*, has been the policy consistently carried out in France, and less systematically and consistently in other countries under the domination of the Latin race. It was believed by its advocates that this system of prescribing the conditions of construction and operation of lines could promote public safety, prevent waste of capital and secure passengers and shippers against extortionate rates. These expectations have been only partially fulfilled. Well trained as was the civil service of France, the effect of this supervision in deadening activity was sometimes more marked than in its effect in preventing abuse. Moreover, such a system of regulation almost necessarily carries with it a guarantee of monopoly to the various companies concerned, and not infrequently large gifts in the form of subsidies, for without such aid private capital will not submit to the special burdens involved. These rights, whether of monopoly or of subsidy, form a means of abuse in many directions. Where the government is bad, they are a fruitful

source of corruption; even where it is good, they enable the companies to drive hard bargains with the public, and prevent the expected benefits of official control from being realized.

3. *State operation and ownership* is a system which originated in Belgium at the beginning of railway enterprise, and has been consistently carried out by the Scandinavian countries and by Hungary. Since 1860 it has been the policy of Australia. It has generally come to be that of Germany and, so far as the finances of the countries allow, of Austria and Russia; British India also affords not a few examples of the same method. The theory of state ownership is excellent. So large a part of the railway charge is of the nature of a tax, that there seem to be a priori reasons for leaving the taxing powers in the hands of the agents of the government. In practice its operation is far more uncertain. Whether the intelligence and efficiency of the officials charged by the state with the handling of its railway system will be sufficient to make them act in the interest of the public as fully as do the managers of private corporations, is a question whose answer can only be determined by actual experience in each case. If they fail to have these qualities, the complete monopoly which a government enjoys, and the powers of borrowing which are furnished by the use of the public credit, increase instead of diminishing the danger of arbitrary action, unprogressiveness and waste of capital. Even in matters like public safety it is by no means certain that government authorities will do so well as private ones. The question is one which practical railway men have long since ceased to argue on general principles; they recognize that the answer depends upon the respective degree of talent and integrity which characterize the business community on the one hand and the government officials on the other.

AUTHORITIES.—On economics of construction and of operation, see Wellington, *The Economic Theory of Railway Location* (5th ed., New York, 1896). On principles governing railway rates in general, and specifically in England, see Acworth, *The Railways and the Traders* (London, 1891). On comparative railway legislation and the principles governing it, see Hadley, *Railroad Transportation; its History and its Laws* (New York, 1885). On the history of railway legislation in England, see Cohn, *Untersuchungen über die Englische Eisenbahnpolitik* (Leipzig, 1874–83). On practice concerning rates in continental Europe, see Ulrich, *Das Eisenbahntarifwesen* (Berlin, 1886). (Since this was published, continental passenger rates have fallen. The French translation—Paris, 1898—gives Russian tariffs.) On the question of "nationalization" (i.e. state ownership and operation), see an article by Edgar Crammond in the *Quarterly Review* (London) for October 1909, which cites, among other works on the subject, Clement Edwards's *Railway Nationalization* (1898); Edwin A. Pratt's *Railway Nationalization* (1908), and E. A. Davis's *Nationalization of Railways* (1908). (A. T. H.)

BRITISH RAILWAY LEGISLATION

The first thing a railway company in Great Britain has to do is to obtain a special or private act of parliament authorizing the construction of the line. Not that the mere laying or working of a railway requires parliamentary sanction, **Construction.** so long as the work does not interfere with other people's rights and interests. An example of a railway built without any legislative authority is the little mountain railway from Llanberis to the summit of Snowdon, which was made by the owner of the land through which it passes. Such a railway has no statutory rights and no special obligations, and the owner of it is liable to be sued for creating a nuisance if the working of the line interferes with the comfort of those residing in the neighbourhood. When, however, a company desires to construct a line on a commercial scale, to acquire land compulsorily, to divert rivers and streams, to cross roads either on the level or by means of bridges, to pass near houses, to build tunnels or viaducts, and to execute all the other works incidental to a railway, and to work the line when completed without interference, it is essential that the authority of parliament should be obtained. The company therefore promotes a bill, which is considered first by select committees of the two houses of parliament, and afterwards by the two houses themselves, during which period it faces the opposition, if any, of rival concerns, of local authorities and of hostile landowners. If this is successfully overcome, and the proposals meet with the

approval of parliament, the bill is passed and, after securing the Royal Assent, becomes an act of parliament. The company is then free to proceed with the work of construction, and at once becomes subject to various general acts, such as the Companies Clauses Act, which affects all joint-stock companies incorporated by any special act; the Land Clauses Act, which has reference to all companies having powers to acquire land compulsorily; the Railway Clauses Act, which imposes certain conditions on all railways alike (except light railways); the various Regulation of Railways Acts; the Carriers Protection Act; acts for the conveyance of mails, parcels, troops; acts relating to telegraphs, to the conveyance of workmen and to the housing of the labouring classes; and several others which it is unnecessary to specify. From the early days of railways parliament has also been careful to provide for the safety of the public by inserting in the general or special acts definite conditions, and by laying upon the Board of Trade the duty of protecting the public using a railway.

The first act which has reference to the safety of passengers is the Regulation of Railways Act of 1842, which obliges every railway company to give notice to the Board of Trade of its intention to open the railway for passenger traffic, and places upon that public department the duty of inspecting the line before the opening of it takes place. If the officer appointed by the Board of Trade should, after inspection of the railway, report to the department that in his opinion "the opening of the same would be attended with danger to the public using the same, by reason of the incompleteness of the works or permanent way, or the insufficiency of the establishment for working such railway," it is lawful for the department to direct the company to postpone the opening of the line for any period not exceeding one month at a time, the process being repeated from month to month as often as may be necessary. The company is liable to a fine of twenty pounds a day if it should open the line in contravention of such order or direction. The inspections made by the officers of the Board of Trade under this act are very complete: the permanent way, bridges, viaducts, tunnels and other works are carefully examined; all iron or steel girders are tested; stations, including platforms, stairways, waiting-rooms, &c., are inspected; and the signalling and "interlocking" are thoroughly overhauled. A code of requirements in regard to the opening of new railways has been drawn up by the department for the guidance of railway companies, and as the special circumstances of each line are considered on their merits, it rarely happens that the department finds it necessary to prohibit the opening of a new railway. The Regulation of Railways Act of 1871 extends the provisions of the above act to the opening of "any additional line of railway, deviation line, station, junction or crossing on the level" which forms a portion of or is connected with a passenger railway, and which has been constructed subsequently to the inspection of it. This act further defines the duties and powers of the inspectors of the Board of Trade, and also authorizes the Board to dispense with the notice which the previous act requires to be given prior to the opening of a railway.

It may be remarked that neither of these acts confers on the Board of Trade any power to inspect a railway after it has once been opened, unless and until some addition or alteration, such as is defined in the last-named act, has been made. When a line has once been inspected and passed, it lies with the company to maintain it in accordance with the standard of efficiency it originally possessed, but no express statutory obligation to do so is imposed upon the company, and whether it does so or not, the Board of Trade cannot interfere.

The act of 1871 further renders it obligatory upon every railway company to send notice to the Board of Trade in the case of (1) any accident attended with loss of life or personal injury to any person whatsoever; (2) any collision where one of the trains is a passenger train; (3) any passenger train or part of such train leaving the rails; (4) any other accident likely to have caused loss of life or personal injury, and specified on that ground by any order

made from time to time by the Board of Trade. The department is authorized, on receipt of such report, to direct an inquiry to be made into the cause of any accident so reported, and the inspector appointed to make the inquiry is given power to enter any railway premises for the purposes of his inquiry, and to summon any person engaged upon the railway to attend the inquiry as a witness, and to require the production of all books, papers and documents which he considers important for the purpose. The inspector, after making his investigation, is required to make a report to the Board of Trade as to the causes of the accident and the circumstances attending the same, with any observations on the subject which he deems right, and the Board "shall cause every such report to be made public in such manner as they think expedient." The usual mode of publishing such reports is to forward them to railway companies concerned, as well as to the press, and on application to any one else who is interested. The reports are subsequently included in a Blue-book and presented to parliament. It should be noted that although the inspecting officer may in his report make any recommendations that he may think fit with a view to guarding against any similar accident occurring in the future, no power is given to the Board of Trade, or to any other authority, to compel any railway company to adopt such recommendations. This omission is sometimes held to be an error, but as a fact it is an advantage. The moral effect of the report, with the criticisms of the company's methods and recommendations appended thereto, is great, and it rarely happens that a company refuses to adopt, or at any rate to test, the recommendations so made. If, on the other hand, the company is of opinion that the suggestions of the inspecting officer are not likely to prove beneficial, or are for any reason unadvisable, it is at liberty to reject them, the responsibility of doing so resting entirely upon itself. The effect of this latitude is to give the company ample discretion in the matter, and to enable the act to be administered and the object of it to be attained without undue interference.

In 1889 a very important act was passed placing upon the Board of Trade the obligation to call upon railway companies throughout the United Kingdom (1) to adopt upon all passenger lines the "block" system of working; (2) to "interlock" their points and signals; (3) to fit all trains carrying passengers with some form of automatic continuous brake. Prior to this some companies had, to a certain extent, done these things, but few, if any, were completely equipped in these respects. A reasonable period was afforded them, according to circumstances, to comply with these requirements, and at the present time the work is practically complete. In this respect the lines of the United Kingdom are far ahead of those of any other country, and a diminution of accidents, particularly of collisions, has resulted therefrom. America is now following the lead thus set, and all the most important lines in the United States have adopted block working and interlocking, but a great deal still remains to be done. In certain respects, on the other hand, America has gone further than the United Kingdom, especially in the matter of automatic signalling, and in the operating of points and signals by electrical power or air-pressure instead of manual labour. In America, also, freight trains are fitted with an automatic continuous brake, whereas in the United Kingdom this appliance is required by law only in the case of passenger trains, and in fact is not fitted to goods and mineral trains except in a few isolated instances.

The above-named acts enable the Board of Trade to take all the necessary steps to ensure that the safety of passenger trains is sufficiently guarded. More recently legislation has been passed to safeguard the lives and interests of railway servants. In 1893 an act was passed by parliament giving the Board power to interfere if or when representations are made to them by or on behalf of any servant or class of servants of a railway company that the hours of work are unduly long, or do not provide sufficient intervals of uninterrupted rest between the periods of duty, or sufficient relief in respect of Sunday duty. In such cases the company concerned may, after inquiry, be called upon to submit such a

Inspection.

Working.

Hours of Labour.

Inquiries into Accidents.

schedule of the hours during which the man or men are employed as will bring those hours within limits which appear to the department reasonable. In the event of the company failing to comply with the demands of the department, the latter is empowered to refer the case to the Railway and Canal Commissioners, who form a special Court constituted by the Railway and Canal Traffic Act of 1888, for deciding, among other things, questions relating to rates and charges, for protecting traders from undue charges and undue preference, for regulating questions of traffic, and for deciding certain disputes between railway companies and the public. The Commissioners are then empowered to deal with the matter, and if "a railway company fail to comply with any order made by the Railway and Canal Commissioners, or to enforce the provisions of any schedule" approved by them, it is liable to a fine of a hundred pounds for every day during which the default continues. This act has been the means of effecting a considerable reduction in the hours worked by railway men on certain railways, and no case has yet arisen in which a reference to the Commissioners has been necessary. Such modifications of the hours of work have not only been beneficial to the men, but have improved the discipline of the staff and the punctuality and regularity of the train service, particularly in respect of the goods trains.

The Notice of Accidents Act of 1884, which obliges employers of labour to report to the Board of Trade, when "there occurs in any employment" as defined by the schedule of the act, "any accident which causes to any person employed therein, either loss of life or such bodily injury as to prevent him on any one of the three working days next after the occurrence of the accident from being employed for five hours on his ordinary work," affects railways in course of construction, but not, as a rule, otherwise.

Although the administration of the above-mentioned acts of parliament has had a beneficial effect upon the safety of the public, and has enabled an enormous volume of traffic to be handled with celerity, punctuality and absence of risk, it has during recent years come to notice that the number of casualties among railway servants is still unduly great, and in 1899 a Royal Commission was appointed to investigate the causes of the numerous accidents, fatal and non-fatal, to railway men. As a consequence of the report of this Commission the Railway Employment (Prevention of Accidents) Act of 1900 was passed, putting upon the Board of Trade the duty of making "such rules as they think fit with respect to any of the subjects mentioned in the schedule to this act, with the object of reducing or removing the dangers and risks incidental to railway service." Rules may also be made in respect to other matters besides those mentioned in the schedule, and companies may be called upon to adopt or reject, as the case may be, any appliance, the use or disuse of which may be considered desirable in the interest of the men. Before, however, the rules so made become binding upon the companies, the latter have the right of appealing against them to the Railway Commissioners. Failure to comply with any of the rules renders a company "liable for each offence, on conviction under the Summary Jurisdiction Acts, to a fine not exceeding fifty pounds, or in the case of a continuing offence to a fine not exceeding ten pounds for every day during which the offence continues after conviction." Rules drafted by the Board of Trade under this act came into force on the 8th of August 1902, the subjects referred to being (1) labelling of wagons; (2) movements of wagons by propping and tow-roping; (3) power-brakes on engines; (4) lighting of stations and sidings; (5) protection of points, rods, &c.; (6) construction and protection of gauge-glasses; (7) arrangement of tool-boxes, &c., on engines; (8) provision of brake-vans for trains upon running lines beyond the limits of stations; (9) protection to permanent-way men when relaying or repairing permanent way. The final settlement of a rule requiring brake-levers to be fitted on both sides of goods-wagons was, however, deferred, owing to objections raised by certain of the railway companies.

Other acts which are of importance in connexion with

accidents are the Accidents Compensation Act of 1846, the Employers' Liability Act of 1880, and the Workmen's Compensation Act of 1897.

The public acts of parliament referring to British railways are collected in Bigg's *General Railway Acts*. (H. A. Y.)

AMERICAN RAILWAY LEGISLATION

Before 1870.—The earliest legislation is contained in charters granted by special act, for the construction of railways. These special acts gradually gave way to general statutes under which railway corporations could be created without application to the legislature. In the east, where, as a rule, charters had been uniform and consistent, the change to general incorporation law was due to a desire to render incorporations speedier and less expensive. In the west, general laws came rather as a result of the abuses of special legislation. By 1850, general incorporation laws were found in nearly all the eastern states, and by 1870 in those of the west.

Early legislation was confined almost entirely to matters of construction. In cases where statutes did touch the question of regulation, they had to do with the operation of trains and with the provision of facilities for shippers and passengers, rather than with questions of rates. It was natural that this should be so, for the new transportation agency was so much more efficient than anything previously available that the people were eager to take advantage of its superior service. As a rule, the making of rates was left to the corporations. If the maximum rates were prescribed, as they sometimes were, the limit was placed so high as to be of no practical value for control. Such crude attempts as were made to prevent rates from being excessive concerned themselves with profits, and were designed to confiscate for the state treasury any earnings beyond a certain prescribed dividend. Publicity of rates was not generally required, and provisions against discrimination were rare. In the period before 1850 there was but little realization of the public nature of the railway industry and of the possibilities of injury to the public if railway corporations were left uncontrolled.

In regions where capital was lacking eagerness for railway facilities led the people to demand the direct co-operation of the state, and many projects, most of which ended in disaster, were undertaken either by the state itself or through the aid of the state's credit. For example, Michigan, in 1837, in the first session of its state legislature, made plans for the construction of 557 miles of railway under the direct control of the state, and the governor was authorized to issue bonds for the purpose. The unfortunate results of this policy led many of the states, from about 1850, to put constitutional limitations upon the power of their legislatures to lend the state's credit or to involve the state as stockholder in the affairs of any corporation.

As railway building increased in response to traffic needs, and as the consolidation of short lines into continuous systems proceeded, legislation applicable to railways became somewhat broader in scope and more intelligent. About 1850 there began to appear on the statute books laws requiring publicity of rates and the submission of annual reports to the legislature, prescribing limits to corporate indebtedness, and also making provision for safety in operation and for the character and quality of railway service. Consolidation and leasing were commonly permitted in the case of continuous lines, but were regularly prohibited in the case of parallel and competing lines. The practice of pooling seems not to have attracted the attention of the legislature. In general it may be asserted that legislation of this period was ill-considered, haphazard, and on a petty scale. Moreover, it was of little practical importance even within its narrow range, for it does not appear to have been generally enforced.

1870-1900.—Railway legislation first assumed importance in connection with the "Granger Movement" in the middle west. There the policy of subsidies for railway building had been carried to a reckless extreme. Roads had been constructed in advance of settlement, and land-seekers had been

transported to these frontier sections only to become dependent upon the railways for their very existence. To the unusual temptations thus offered for favouritism and discriminations in rates, the railways generally yielded. This preferential and discriminating policy, combined with other causes which cannot here be discussed, resulted in the Granger legislation of the 'seventies. In the first instance laws were enacted prescribing schedules of maximum freight and passenger rates with stringent penalties against rebates and discriminations. These measures proving unsatisfactory, they were soon superseded by statutes creating railway commissions with varied powers of regulation. The commission method of control was not a new one. Such bodies, established to appraise land for railway purposes, to apportion receipts and expenditures of interstate traffic, and in a general way to supervise railway transportation, had been in existence in New England before 1860, one of the earliest being that of Rhode Island in 1839. In 1869 Massachusetts had instituted a commission of more modern type, which was given only powers of investigation and recommendation, the force of public opinion being relied upon to make its orders effective. Western commissions, the offspring of the Granger movement, were of a more vigorous type. Most of them had power to impose schedules of maximum rates; practically all of them had authority to prescribe rates upon complaint of shippers; and they could all seek the aid of the courts to enforce their decrees. Their power to initiate rates, conferred upon them by their legislatures, was sustained by the Supreme Court of the United States, the Court reserving to itself only the power to decide whether the prescribed rates were reasonable.

But the jurisdiction of the state commissions was, by judicial interpretation, limited to commerce beginning and ending within the limits of the single state. The most important part of railway transportation, that which was interstate in character, was left untouched. It was this impotence of the state commission that furnished the strongest incentive to Congressional action. The result was the passage, in 1887, of the Interstate Commerce Act, which was directed towards the extirpation of illegal and unjust practices in commerce among the states. Its primary purpose was to embody in statutory form the common-law principle of equal treatment under like circumstances, and to provide machinery for enforcement. It aimed at the prohibition of discrimination between persons, places and commodities. It made provision for publicity of rates and for due notice of any change in rates; it forbade pooling of freight or earnings, and required annual reports from the carriers. For its enforcement, it created an Interstate Commerce Commission of five members, with powers of investigation, and with authority to issue remedial orders upon complaint and after hearing. Findings of the Commission were to be *prima facie* evidence in any court proceeding for the enforcement of its orders.

In this connexion, reference should be made to the Anti-Trust Act of 1890, which, by its judicial interpretation, has been held to include railways and to forbid rate agreements between competing carriers.

The act of 1887 remained in force without substantial amendment until 1906, although with constantly diminishing prestige, a result largely due to adverse decisions concerning the powers of the Commission. Ten years after the passage of the law, the court decided that the Commission had no power to prescribe a rate, and that its jurisdiction over rates was confined to a determination of the question whether the rate complained of was unreasonable. The Commission had much difficulty at the beginning in securing the testimony of witnesses, who invoked the Constitution of the United States as a bar against self-incrimination, and the immunity clause of the act had to be amended before testimony could be obtained. The so-called "long-and-short-haul clause," which forbade a greater charge for a long than for a short haul over the same line, if circumstances were substantially similar, was also robbed of all its vitality by court decision. The section requiring annual reports, while it led to the creation of a Bureau of Statistics, did not give

the Commission power to compel complete or satisfactory answers to its requests for information. The only element of real strength that the statute acquired during the first twenty years of its history came from the Elkins Act of 1903, which stipulated that the published rate should be the legal rate, and declared any departure from the published rate to be a misdemeanour. It held shipper as well as carrier, and corporation as well as its officer or agent, liable for violations of the act, and conferred upon United States courts power to employ equity processes in putting an end to discrimination. Conviction for granting rebates was by this law made easier and more effective.

Since 1900.—The movement in favour of more vigorous railway regulation became pronounced after 1900. Twenty years of experience and observation had revealed the defects of the earlier legislation, and had concentrated public attention more intelligently than ever before upon the problem of strengthening the weak spots. The state commissions, since their establishment in the 'seventies and the 'eighties, had increased their functions and influence. Many of them, beginning only with powers of recommendation, had obtained a large extension of authority. By 1908, thirty-five of the forty state commissions were of the mandatory type, and thirteen of these had been created since 1904. They had been given power to require complete annual reports from carriers, with a consequent great increase in public knowledge concerning railway operation and practice. The most recent type of state commission is the so-called Public Utility Commission, of which the best examples are those of New York and Wisconsin, established in 1907. In both states, the Commissions have power over electric railways and local public utilities furnishing heat, light and power, as well as over steam railway transportation, and the Wisconsin Commission also has control over telephone companies. In both states the consent of the Commission is necessary for the issue of corporate securities.

Mention should be made of the mass of general legislation passed, principally by western states, since 1905, in response to a popular demand for lower rates. This demand has in many instances led to ill-considered legislation, has frequently ignored the prerogatives and even the existence of the state commissions, and has brought about the passage by state legislatures of maximum freight and passenger rate laws, with rates so low in many cases that they have been set aside by the courts as unconstitutional. The numerous laws limiting the fare for passengers to two cents per mile are an illustration of this tendency.

In the field of federal legislation, no significant change took place until the passage of the Hepburn Act of 1906, which was an amendment of the act of 1887. While failing to correct all the defects in the original statute, the amended law was a decided step in the direction of efficient regulation. It increased the jurisdiction of the Commission by placing under the act express companies, sleeping-car companies and pipe lines for the transportation of oil. It extended the meaning of the term "railroad" to include switches, spurs and terminal facilities, and the term "transportation" to include private cars, and all collateral services, such as refrigeration, elevation and storage. The Elkins Act of 1903 was incorporated in the statute, and an imprisonment penalty was added to the existing fine. It forbade the granting of passes except to certain specified classes,—a provision entirely absent from the original measure. It expressly conferred upon the Commission the power to prescribe maximum rates, upon complaint and after hearing, as well as to make joint rates, and to establish through rates when the carriers had themselves refused to do so. It enacted that published rates should not be changed except on thirty days' notice, whether the change involved an increase or a decrease, and it required annual reports to be made under oath, penalties being prescribed for failure to comply with the Commission's requests for information. Power was also given to prescribe uniform systems of accounts for all classes of carriers, and to employ special examiners to inspect the books and accounts. Carriers were forbidden to keep any accounts, records or memoranda other than those approved by the Commission.

Orders of the Commission became effective within such time, not less than thirty days, as the Commission should prescribe, and penalties began to take effect from the date fixed by the Commission, unless the carrier secured an injunction from the Court suspending the order. Such injunction might not issue except after hearing, of which five days' notice must be given. Decisions of the Commission were not reviewable by the Court unless the Commission had exceeded its authority, or had issued an unconstitutional order.

A new and important act was signed by the President on the 18th of June 1910. It created a Commerce Court (composed of five judges nominated by the president of the United States from the Federal circuit judges), transferred to it jurisdiction in cases instituted to enforce or set aside orders of the Inter-State Commerce Commission, and made the United States instead of the Commission a party in all such actions. The law forbids a railway or any other common carrier to charge more for a short haul than for a long haul over the same line, unless, in special cases, it is authorized to do so by the Commission. It forbids a railway which has reduced its rates while in competition with a water route to raise them again when the competition has ceased, unless the Commission permits it to do so because of other changed conditions. It extends the initiative of the Commission from the investigation of complaints to the investigation of rates on its own motion; authorizes it to suspend rates in advance of their going into effect, pending an investigation which may be continued for ten months, and to establish through routes; and provides for a special commission, appointed by the President, to investigate questions pertaining to the issuance of railway securities.

BIBLIOGRAPHY.—See A. T. Hadley, *Railroad Transportation* (New York, 1885); B. H. Meyer, *Railway Legislation in the United States* (New York, 1903); F. A. Cleveland and F. W. Powell, *Railroad Promotion and Capitalization in the United States* (New York, 1909); L. H. Haney, *A Congressional History of Railways* (2 vols., Madison, Wis., 1908 and 1910); *Elkins Committee Report* (1905); F. H. Dixon, "The Interstate Commerce Act as Amended," *Quarterly Journal of Economics*, xii. 22 (Nov. 1906); F. H. Dixon, "Recent Railroad Commission Legislation," *Political Science Quarterly*, xx. 612 (Dec. 1905). (F. H. D.)*

ACCIDENT STATISTICS

Statistics of railway accidents may be divided into three classes: casualties (a) to passengers, (b) to servants or *employés* and (c) to other persons; and again into (1) train accidents, (2) accidents to persons doing work on or about trains and (3) other accidents.

Such statistics are studied mainly with the object of learning the lessons which they may afford as to preventive measures for the future; and from this point of view the most important element is the single item of passengers killed in train accidents (a 1). The number injured is, indeed, a fact of interest, no less than the number killed, but comparisons under this head are unsatisfactory because it is impracticable or unprofitable to go into sufficient detail to determine the relative seriousness of the injuries. The statistics of the killed usually afford all necessary stimulus to improvement. Accidents to passengers other than those caused by collisions or derailments of trains are very largely due to causes which it is fair to class either as unavoidable or as due mainly to the fault or carelessness of the victim himself. That this is so is indicated by the fact that, although the railways—always made to suffer severely in pecuniary damages for injuries for which their officers or servants are held responsible by the courts—have for years taken almost every conceivable precaution, the number of accidents, in proportion to the number of persons travelling, diminishes but slowly—so slowly that, in view of the variety of conditions to be considered, it would hardly be safe to conclude that the diminution is due to any definite improvement in the safeguards provided. Collisions, on the other hand, are preventable, and derailments nearly so, and the records of deaths and injuries in this class in successive years are therefore justly taken as an index to the efficiency with which the railways are managed.

The number of servants killed in train accidents is the next in importance. The safety of passengers is, indeed, the first care of the railway manager; but the *employés*, exposed to many risks from which the passengers are protected, must be looked after. On the British railways the men who run the trains are safeguarded very efficiently, and the collisions and derailments which are serious enough to do injury to the trainmen or the enginemen are really rare. The roadway, tracks and rolling stock are so well maintained that those causes which lead to the worst derailments have been eliminated almost completely, and the record of serious collisions has been reduced nearly to zero by the universal use of the block system and by systematic precautions at junctions. In America the record is far less satisfactory. The best railways of the United States and Canada have, indeed, been greatly improved, and their main lines approach the high standards of safety which prevail in Great Britain, both as regards maintenance and care of roadway and vehicles (as a preventive of derailments) and the use of the block system (as a preventive of collisions); but when the inquirer looks at America as a whole—the total length of lines in the United States being over 230,000 m., ten times the total of the United Kingdom—he is considering a figure which includes an enormous mileage of railway lying in thinly settled regions where the high standards of safety maintained on the best railways have scarcely been thought of. The duty of a railway with deficient plant or facilities would seem to be to make up for their absence by moderating the speeds of its trains, but public sentiment in America appears so far to have approved, at least tacitly, the combination of imperfect railways and high speeds.

Apart from collisions and derailments, a large proportion of all accidents is found to be due primarily to want of care on the part of the victims. Accidents to workmen in marshalling, shunting, distributing and running trains, engines and cars, may be taken as the most important class, after train accidents, because this work is necessary and important and yet involves considerable hazard. On British railways the duty of the companies to provide all practicable safeguards and to educate and caution the servants may be said to have been faithfully performed, and the accident totals must be taken as being somewhat near the "irreducible minimum"—unless some of the infirmities of the human mind can be cured. In America the number of men killed and injured in handling freight trains has been very large. In the year ending June 30, 1909, exclusive of casualties due to collisions, derailments and other accidents to trains, the number killed was 811 and of injured 28,156 (*Accident Bulletin*, No. 32, p. 14). The number killed (811) is equal to about three in every thousand trainmen employed. From this and all other causes, the number of trainmen killed in the year ending June 30, 1909, was about 8 in 1000.

The use of automatic couplers for freight cars throughout the United States, introduced in 1893-1900, greatly reduced the number of deaths and injuries in coupling, and the use of air brakes on freight cars, now universal, has reduced the risk to the men by making it less necessary for them to ride on the roofs of high box-cars, while at the same time it has made it possible to run long trains with fewer men; but except in these two features the freight service in America continues to be a dangerous occupation. The high and heavy cars, the high speeds, the severe weather in the northern states in winter, the fluctuating nature of the business, resulting often in the employment of poorly qualified men and in other irregularities, are among the causes of this state of things.

Being struck or run over by a train while standing or walking on the track is the largest single cause of "railway accidents." Workmen are killed and injured in this way, both while on duty and when going to and from their work; passengers, with or without right, go in front of trains at stations and at highway crossings at grade level; and trespassers are killed and injured in large numbers on railways everywhere, at and near stations, at crossings, and out on the open road, where they have no shadow of right. Of trespassers the number killed per mile of

line is about as large in England as in America, the density of population and of traffic in Great Britain apparently counterbalancing the laxity of the laws against trespassing in America. In the thickly settled parts of the United States the number of trespassers killed on the railway tracks, including vagrants who suffer in collisions and derailments while stealing rides, is very large. In New York and four adjacent states, having about as many miles of railway as the United Kingdom, the number in the year ending June 30, 1907, was 1552. In the United Kingdom the number for the corresponding year was 447, or less than one-third.

As was suggested at the outset, railway accident statistics are useful only as showing how to make life and limb safer, though in pursuing this object increased economy should also be secured. Railways have always been held by the legislatures and by the courts strictly accountable for their shortcomings, so far as accountability can be enforced by compelling the payment of damages to victims of accidents; but in spite of this, a want of enterprise and even some apparent neglect of passengers' and servants' plain rights, have often been apparent, and the Board of Trade, with its powers of supervision, inspection and investigation, must therefore be classed as one of the most beneficent factors in the promotion of safety on British railways. Its powers have been exercised with the greatest caution, yet with consistent firmness; and the publicity which has been given to the true and detailed causes of scores and scores of railway accidents by the admirable reports of the Board of Trade inspectors has been a powerful lever in improving the railway service. Useful compulsory laws regarding the details of train management are difficult to frame and hard to carry out; but the Board has exercised a persistent persuasiveness and has secured most of its objects. Its investigations justified the law making the block system compulsory, thus removing the worst danger of railway travel. Its constant and impartial expositions of cases of over-work and insufficient training of *employés* have greatly helped to elevate the character of these *employés*.

In the United States the governments have done far less. A majority of the states have railway commissions, but the investigation of railway accidents, with comparatively few exceptions, has not been done in such a way as to make the results useful in promoting improved practice. Many of the commissions have done little or nothing of value in this respect. The Federal government, having authority in railway matters only when interstate traffic is affected, gathers statistics and publishes them; but in the airing of causes—the field in which the British Board of Trade has been so useful—nothing so far has been done except to require written reports monthly from the railways. These are useful so far as they go, but they lack the impartiality that would be secured by an inquiry such as is held in England.

TABLE X.—CASUALTIES ON THE RAILWAYS OF THE UNITED KINGDOM

	1908.		1907.	
	Killed.	In-jured.	Killed.	In-jured.
<i>Passengers:—</i>				
1. In train accidents	0	283	18	534
2. Other accidents in or around trains, &c.	102	2,242	102	2,132
3. Other causes	5	863	5	836
Total of passengers	107	3,388	125	3,502
<i>Servants:—</i>				
4. In train accidents	6	164	13	236
5. Other accidents in or around trains, &c.	376	4,976	441	5,577
6. Other causes	50	19,041	55	15,701
Total of servants	432	24,181	509	21,514
<i>Other Persons:—</i>				
7. In train accidents	0	7	5	11
8. At level crossings	51	44	50	30
9. Trespassing on line	291	99	278	115
10. Suicides (including unsuccessful attempts)	188	19	169	18

11. On business at stations	32	580	36	618
12. Miscellaneous	27	167	39	167
Total of "other persons"	589	916	577	959
Grand total	1,128	28,485	1,211	25,975

The casualties enumerated in items 1, 4 and 7 of Table X. aggregate 6 killed and 454 injured; the six deaths were due to collisions, while of the cases of injury 372 occurred by collisions, 47 by derailments, and 35 by other accidents to trains. This undoubtedly is the greatest record for train safety ever known in the world. Item 1 shows no passengers killed in train accidents during the year. This was the case once before, in 1901; and the total of fatal accidents to passengers and servants, taken together, has in several years been very low (1896, eight; 1901, eight; 1902, ten; 1904, thirteen), but never before was it down to six.

Items 2 and 5 in Table X. are made up of the classes of accidents shown in Table XI.

TABLE XI.—DETAIL CAUSES OF CERTAIN ACCIDENTS

	Year 1908.	
	Killed.	Injured.
<i>Item 2, Passengers:—</i>		
1. From falling between trains and platforms—		
(a) When entering trains	21	53
(b) When alighting from trains	2	110
2. From falling on to the platform, ballast, &c.:—		
(a) When entering trains	5	115
(b) When alighting from trains	10	874
3. From falling off platforms and being struck or run over by trains	8	19
4. While crossing the line at stations—		
(a) Where there is either a subway or footbridge	9	6
(b) Where there is neither a subway nor footbridge	9	6
5. By the closing of carriage doors	..	748
6. From falling out of carriages during the running of trains	19	64
7. By other accidents	19	247
Total of passengers	102	2242
<i>Item 5, Servants:—</i>		
By accidents occurring during shunting operations, viz.—		
1. While coupling or uncoupling vehicles	16	675
2. By coming in contact, while riding on vehicles, with other vehicles, &c., standing on adjacent lines	2	19
3. While passing over, under, or standing on buffers.	2	13
4. When getting on or off, or falling off engines, wagons, &c.	4	278
5. While braking, spragging, or chocking wheels	15	627
6. While attending to ground-points	1	98
7. While moving vehicles by capstans, turntables, props, levers, &c.	16	498
8. By other accidents not included in the preceding	41	587
9. From falling off trains, engines, &c., in motion	5	43
10. When getting on or off engines, vans, &c., during the running of trains	2	226
11. By coming in contact with over-bridges or erections on the sides of the line	5	53
12. While attending to the machinery, &c., of engines in motion	2	674
13. While working on the permanent-way, sidings, &c.	52	100
14. While attending to gates at level-crossings	3	3
15. While walking, crossing or standing on the line on duty:—		
(a) At stations	84	245
(b) At other parts of the line	40	46
16. From being caught between vehicles	23	95
17. From falling, or being caught between trains and platforms, walls, &c.	10	70
18. While walking, &c., along the line to or from work	34	31
19. Miscellaneous	19	595
Total of servants	376	4976

Table XII. analyses the classes of accident comprised in items 3 and 6 of Table X.

TABLE XII.—DETAIL CAUSES OF CERTAIN ACCIDENTS

	1908.		1907.	
	Killed.	In-jured.	Killed.	In-jured.
<i>Passengers:—</i>				
a. While ascending or descending steps at stations	3	370	5	339
b. By being struck by barrows, by falling over packages, &c., on station platforms	..	142	..	122

TABLE XII.—DETAIL CAUSES OF CERTAIN ACCIDENTS—continued.

	1908.		1907.	
	Killed.	In-jured.	Killed.	In-jured.
c. From falling off platforms upon the ballast	1	105	..	110
d. By other accidents	1	246	..	265
Total of passengers	5	863	5	836
Servants:—				
1. While loading, unloading or sheeting wagons, trucks and horse-boxes	8	4,018	5	2,899
2. While moving goods and luggage in stations or sheds	2	1,992	2	975
3. While working at cranes or capstans	3	411	8	304
4. By the falling of wagon-doors, lamps, bales of goods, &c.	1	583	..	390
5. While attending to engines at rest	4	2,479	4	2,363
6. From falling off, or when getting on or off, engines or vehicles at rest	3	1,504	2	1,495
7. From falling off, or when getting on or off, platforms	1	483	2	404
8. From falling off ladders, scaffolds, &c.	11	449	11	400
9. By stumbling while walking on the line	2	1,068	1	1,049
10. By being trampled on or kicked by horses while engaged in railway work	1	94	..	71
11. From being struck by articles thrown from passing trains	..	7	..	6
12. From the falling of rails, sleepers, &c., when at work on the line	..	686	1	611
13. Otherwise injured when at work on the line or in sidings	5	2,182	5	1,981
14. Miscellaneous	9	3,085	14	2,753
Total of servants	50	19,041	55	15,701

TABLE XIII.—NATURE OF ACCIDENTS TO TRAINS, VEHICLES AND PERMANENT-WAY

	1908.	1907.
	United Kingdom.	United Kingdom.
(A) Accidents to trains:—		
1. Collisions between passenger trains or parts of passenger trains	43	48
2. Collisions between passenger trains and goods or mineral trains or light-engines	78	70
3. Collisions between goods trains or parts of goods trains and light-engines	180	216
4. Collisions between trains and vehicles standing foul of the line	7	22
5. Collisions between trains and buffer-stops or vehicles standing against buffer-stops:—		
(a) From trains running into stations or sidings at too high a speed	20	17
(b) From other causes	15	25
6. Trains coming in contact with projections from other trains or vehicles on parallel lines	30	7
7. Passenger trains or parts of passenger trains leaving the rails	94	106
8. Goods trains or parts of goods trains, light-engines, &c., leaving the rails	407	483
9. Trains running through gates at level-crossings or into other obstacles	368	364
10. Fires in trains	195	170
11. Miscellaneous	3	4
(B) Accidents to or failure of rolling stock and permanent-way:—		
12. Bursting of boilers or tubes, &c., of engines	7	13
13. Failure of machinery, springs, &c., of engines	61	86
14. Failure of tires	125	172
15. " wheels	2	8
16. " axles	165	160
17. " couplings	2,346	2,440
18. " ropes used in working inclines
19. " tunnels, bridges, viaducts, culverts, &c.	3	..
20. Broken rails	287	289
21. Flooding of portions of permanent-way	24	40
22. Slips in cuttings or embankments	18	28
23. Fires at stations or involving injury to bridges or viaducts	30	22
24. Miscellaneous	1	..

Percentages.—On British railways the casualties from train accidents, especially fatal injuries, have been reduced to so small a proportion of the number of passengers travelling, or the number of

servants employed, that the figures showing the percentages vary from year to year considerably; but in other classes of accidents, in which a large proportion of the cases may be classed as unpreventable, the percentages do not vary greatly. The following are the more significant ratios in the year 1907, as shown in the Board of Trade returns:—

- (a) Passengers killed in train accidents, approximately (1908, 0 in 1,500,000,000.) 1 in 83,000,000
- (b) Passengers injured in train accidents, approximately (1908, approximately 1 in 6,000,000.) 1 in 3,000,000
- (c) Servants killed in train accidents:—
 - Number of servants killed per 10,000,000 train miles 0.329
 - Engine drivers, ratio killed to number employed 1 in 5,628
 - Firemen, ratio killed to number employed 1 in 12,857
 - Passenger guards, ratio killed to number employed 1 in 4,237
 - Goods guards and brakemen, ratio killed to number employed 1 in 8,438
- (d) Servants killed in work about trains, &c. (excluding train accidents), ratio killed to number employed 1 in 790
 - Goods guards and brakemen, ratio killed to number employed 1 in 409
 - Shunters, ratio killed to number employed 1 in 337
 - Engine drivers, ratio killed to number employed 1 in 1,126
 - Passenger guards, ratio killed to number employed 1 in 1,059

Railway Accidents in America.—The statistics of accidents in America are kept in a form somewhat different from the foregoing. Table XIV. is taken from the Accident Bulletin of the Interstate Commerce Commission (No. 32), the items being numbered to correspond as nearly as practicable with the numbers in the British table (No. X.). The items 7-8 embrace the statistics which most nearly correspond to the items 7-12 in the British table.

TABLE XIV.—CASUALTIES ON THE RAILWAYS OF THE UNITED STATES OF AMERICA

	1909.		1908.		
	Killed.	Injured.	Killed.	Injured.	
Passengers:—					
1. In train accidents	131	5,865	165	7,430	
2, 3. Other causes	204	6,251	241	5,215	
Total of passengers	335	12,116	406	12,645	
Servants:—					
4. In train accidents	520	4,877	642	6,818	
5, 6. Other causes	1,936	46,927	2,716	49,526	
Total of servants	2,456	51,804	3,358	56,344	
Year ending June 30, 1907.					
	Trespassing.		Not Trespassing.		Total.
	Killed.	Injured.	Killed.	Injured.	
Other Persons:—					
7. In train accidents	97	171	52	1202	149 1373
8. Struck by trains at highway crossings	237	274	696	1523	933 1797
Do. at stations	421	423	89	259	510 682
Do. at other places	3732	2063	113	200	3845 2263
Other causes	1125	2581	94	1287	1219 3868
Total of "other persons"	5612	5512	1044	4471	6656 9983

The salient feature of Table XIV. is the diminution from 1908 to 1909. This is mainly due to a great falling off in traffic, because of a general business depression; from 1907 to 1909 the reduction in the accident record is still greater. In items 1 and 4 the increase in safety is due in part, no doubt, to the extension of the use of the block system. The accidents to "other persons" cannot readily be compared with items 7-12 in the British record, except as to the totals and a few of the items.

In any comparison between British and American records the first point to be borne in mind is the difference in mileage and traffic. The American railways aggregate approximately ten times the length of the British lines; but in train miles the difference is far less. In the latest years in which comparisons can be made, the passenger journeys in the United Kingdom amounted to 1500 millions (including season-ticket holders, estimated) and the train miles to 428.3 millions, while the corresponding figures in the United States were 873.9 millions and 1171.9 millions. The average length

of the passenger's journey in the United States is reported to be about 32 m.; in Great Britain it is undoubtedly less, but no record is published. Of the total train mileage in America more than half is freight; in Great Britain much more than half is passenger.

TABLE XV.—TOTAL CASUALTIES ON RAILWAYS OF THE UNITED STATES

	1908.		1907.	
	Killed.	Injured.	Killed.	Injured.
Passengers	383	11,592	610	13,041
Employees	3,470	83,367	4,534	87,644
Other persons	6,460	10,275	6,695	10,331
Total	10,313	105,234	11,839	111,016

Table XV. shows the casualties on American railways in 1907 and 1908 (year ending June 30). These figures differ from those in Table XIV. because of differences in classification. In Table XIV. the item "passengers killed" includes those on some electric railways, which presumably are not covered in the statement here given; also passengers in freight trains, &c. Under "employees" this table includes men in shops, &c., not shown in Table XIV.

In 1907 one passenger in 2,318,051 was killed, and one in 107,004 was injured, in train accidents. The number of employes killed in train accidents was 12.9 in 10 million train miles. Of train men (including engine-drivers and firemen), one out of 125 employed was killed (all causes), and one in eight injured.

The great differences between the records of the United States and the United Kingdom seem to afford justification for the view, which has often been expressed, that in America the spirit of hurry and recklessness manifest in many of the activities of the people prevails even among the men on whom rests the grave responsibility of running trains in safety. Yet the best safety devices are made in America, and means of reducing these death records are well known.

France.—Railway accidents in France are recorded in a shape somewhat different from that found in either Great Britain or America. The principal items for the years 1906 and 1907 are shown in Table XVI. The length of railways in the republic was 39,963 km. (24,832 m.), the number of persons employed on them was rather less than 300,000, the number of passengers carried annually being between 450 and 500 millions. The number of passengers (36) killed in train accidents in 1907 was equal to 0.0759 per million passengers carried and 0.0024 per million kilometres travelled by passengers, or 0.1503 per million kilometres travelled by trains.

TABLE XVI.—RAILWAY CASUALTIES IN FRANCE

	1907.		1906.	
	Killed.	Injured.	Killed.	Injured.
<i>In train accidents—</i>				
Passengers	36	430	14	500
Servants	23	168	21	132
	59	598	35	632
<i>Other accidents, due to railway operations—</i>				
Passengers and others	11	39	14	29
Servants	18	24	8	17
	29	63	22	46
<i>Other accidents, victim's own fault—</i>				
Passengers and others	290	189	305	155
Servants	281	465	265	421
	571	654	570	576
Grand total	659	1315	627	1254

The most significant item in the table, 36 passengers killed in train accidents, is perhaps to be considered as abnormally large, the totals under this head for the preceding six years beginning with 1901 being 7, 35, 3, 18, 4, 14, or an average of 11.57 per year. The French secretary of Public Works, who has furnished these statistics, keeps also similar records of the local or light railways, on which the number of fatal accidents appears to be exceedingly small.

Germany.—The number of persons killed on the railways of the German Empire in the year 1907 was 1249, classified as in Table XVII. This number does not include suicides and attempts at suicide, of which there were 333, all but 24 being successful. In these statistics, the third item, "other persons," includes post office and customs officials and other persons connected with the railway service, as well as railway officers and servants off duty. The totals of passengers killed and

injured in train accidents are not separated from those killed and injured from other causes, but ratios are given showing that for four years no passengers were killed in this class.

TABLE XVII.—RAILWAY CASUALTIES IN THE GERMAN EMPIRE (From *Statistik der im Betriebe befindlichen Eisenbahnen*; E. S. Mittler & Son, Berlin)

	1907.		1906.	
	Killed.	Injured.	Killed.	Injured.
Passengers	135	653	118	597
Servants	714	1673	703	1513
Other persons	400	365	360	373
	1249	2691	1181	2483

See the *Quarterly and Annual Reports*, issued by the Board of Trade, London, and the *Annual Statistical Reports and Quarterly Accident Bulletins*, published by the Interstate Commerce Commission, Washington. (B. B. A.)

FINANCIAL ORGANIZATION

The methods of financing railway enterprises, both new projects and existing lines, have been influenced very largely by the attitude of the state and of municipal authorities. Railways may be built for military reasons or for commercial reasons, or for a combination of the two. The Trans-Siberian railway was a military necessity if Russia was to exercise dominion throughout Siberia and maintain a port on the Yellow Sea or the Sea of Japan. The Union Pacific railroad was a military necessity to the United States if the authority of the national government was to be maintained in the Far West. The cost of such ventures and the detailed methods by which they are financed are of relatively small importance, because they are not required to earn a money return on the investment. To a less degree, the same is true of railways built for a special instead of a general commercial interest. The Baltimore & Ohio railroad was built to protect and further the commercial interests of the city of Baltimore; the Cincinnati Southern railway is still owned by the city of Cincinnati, which built the line in the 'seventies for commercial protection against Louisville, Ky. From a commercial point of view such ventures are differentiated from railway projects built for general commercial reasons because they do not depend on their own credit. The government, national or local, furnishes the borrowing power, and makes the best bargain it can with the men it designates to operate the line.

Where a railway is built for general commercial reasons, however, it must furnish its own credit; that is to say, it must convince investors that it can be worked profitably and give them an assured return on the funds they advance. The state is interested in the commercial railway venture as a matter of public policy, and because it can confer or withhold the right of eminent domain, without which the railway builder would be subjected to endless annoyance and expense. This governmental sanction has been obtainable only with difficulty, and after the exercise of numerous legal forms, in Great Britain and on the continent of Europe. In the United States, on the other hand, it has been obtained with considerable ease. In the earlier years of American railway building, each project was commonly the subject of a special law; then special laws were in turn succeeded by general railway laws in the several states, and these in turn have come to be succeeded in most parts of the country by jurisdiction vested in the state railway commission. Each of these changes has tended to improve the existing status, to legitimize railway enterprise, and to safeguard capital or investment.

The laws regulating original outputs for capital were strictly drawn in Great Britain and on the continent of Europe; in America they were drawn very loosely. As a result it has been far easier for the American than for the European railway builder to take advantage of the speculative instinct in obtaining money. Instead of the borrowing power being restricted to a small percentage of the total capital, as in European countries, most of the railway mileage of America has been built with borrowed money, represented by bonds, while stock has been given freely as an inducement to subscribe to the bonds on the

theory that the bonds represented the cost of the enterprise, and the stock the prospective profits. As a natural result weak railway companies in the United States have frequently been declared insolvent by the courts, owing to their inability in periods of commercial depression to meet their acknowledged obligations, and in the reorganization which has followed the shareholders have usually had to accept a loss, temporary or permanent.

The situation in Great Britain has been wholly different. The debt in that country is relatively small in amount, and is not represented by securities based upon hypothecation of the company's real property, as with the American railway bond, resting on a first, second or third mortgage. But British share capital has been issued so freely for extension and improvement work of all sorts, including the costly requirements of the Board of Trade, that a situation has been reached where the return on the outstanding securities tends to diminish year by year. Although this fact will not in itself make the companies liable to any process of reorganization similar to that following insolvency and foreclosure of the American railway, it is probable that reorganization of some sort must nevertheless take place in Great Britain, and it may well be questioned whether the position of the transportation system of that country would not have been better if it had been built up and projected on the experience gained by actual earlier losses, as in the United States.

Thus the characteristic defect in the British railway organization has been the tendency to put out new capital at a rate faster than has been warranted by the annual increases in earnings. The American railways do not have to face this situation; but, after a long term of years, when they were allowed to do much as they pleased, they have now been brought sharply to book by almost every form of constituted authority to be found in the states, and they are suffering from increased taxation, from direct service requirements, and from a general tendency on the part of regulating authorities to reduce rates and to make it impossible to increase them. Meantime, the purchasing power of the dollar which the railway company receives for a specified service is gradually growing smaller, owing to the general increases year by year in wages and in the cost of material. The railways are prospering because they are managed with great skill and are doing increasing amounts of business, though at lessening unit profits. But there is danger of their reaching the point where there is little or no margin between unit costs of service and unit receipts for the service. It will probably be inevitable for American railway rates to trend somewhat upward in the future, as they have gradually declined in the past; but the process apparently cannot be accomplished without considerable friction with the governing authorities. The attitude of the courts is not that the railways should work without compensation, but that the compensation should not exceed a fair return on funds actually expended by the railway. This is in line with the provisions in the Constitution of the United States regarding the protection of property, but the difficulty in applying the principle to the railway situation lies in the fact that costs have to be met by averaging the returns on the total amount of business done, and it is often impossible, in specific instances, to secure a rate which can be considered to yield a fair return on the specific service rendered. Hence losses in one quarter must be compensated by gains in another—a process which the law, regarding only the gains, renders very difficult.

The growth of railways has been accompanied by a world-wide tendency toward the consolidation of small independent ventures into large groups of lines able to aid one another in the exchange of traffic and to effect economies in administration and in the purchase of supplies. Both in England and in America this process of consolidation has been obstructed by all known legislative devices, because of the widespread belief that competition in the field of transportation was necessary if fair prices were to be charged for the service. But the general tendency to regulate rates by authority of the state has apparently rendered unnecessary the old plan of rate regulation through competition,

even if it had not been demonstrated often and again that this form of regulation is costly for all concerned and is effective only during rare periods of direct conflict between companies. Nevertheless, in spite of difficulties, consolidation has gone on with great rapidity. When Mr E. H. Harriman died he exercised direct authority over more than 50,000 m. of railway, and the tendency of all the great American railway systems, even when not tied to one another in common ownership, is to increase their mileage year by year by acquiring tributary lines. The smaller company exchanges its stock for stock of the larger system on an agreed basis, or sells it outright, and the bondholders of the absorbed line often have a similar opportunity to exchange their securities for obligations of the parent company, which are on a stronger basis or have a broader market. Similarly in Great Britain there is a tendency towards combination by mutual agreement among the companies while they still preserve their independent existence.

Table XVIII. shows the paid-up capital, gross receipts, net receipts and proportion of net receipts to total paid-up capital on the railways of the United Kingdom for a series of years.

TABLE XVIII.—BRITISH RAILWAYS

Year.	Route Miles.	Paid-up Capital.	Gross Receipts.	Net Receipts.	Percent Net to Capital.
1878	17,333	£698,545,154	£62,862,674	£29,673,306	4.25
1888	19,812	864,695,963	72,894,665	35,132,558	4.06
1898	21,659	1,134,468,462	96,252,501	40,291,958	3.55
1899	21,700	1,152,317,501	101,667,065	41,576,378	3.61
1900	21,855	1,176,001,890	104,801,858	40,058,338	3.41
1901	22,078	1,195,564,478	106,558,815	39,069,076	3.27
1902	22,152	1,216,861,421	109,469,720	41,628,502	3.42
1903	22,435	1,235,528,917	110,888,714	42,326,859	3.43
1904	22,634	1,258,294,681	111,833,272	42,660,741	3.39
1905	22,847	1,272,600,935	113,531,019	43,466,356	3.42
1906	23,063	1,286,883,341	117,227,931	44,446,077	3.45
1907	23,108	1,294,065,662	121,548,923	44,939,729	3.47
1908	23,205	1,310,533,212	119,894,327	43,486,526	3.32

A similar comparison (Table XIX.) can be made for the United States of America, statistics prior to the establishment of the Interstate Commerce Commission being taken from *Poor's Manual of Railroads* as transcribed in government reports.

TABLE XIX.—AMERICAN RAILWAYS

Year.	Route Miles.	Issued Capital.	Gross Receipts.	Net Receipts.†	Percent Net to Capital.
1878	81,747	\$4,772,297,349	\$490,103,351	\$187,575,167	3.93
1888	156,114	9,281,914,605	960,256,270	301,631,051	3.25
1898	190,870	10,818,554,031	1,269,263,257	407,018,432	3.76
1899	194,336	11,033,954,898	1,339,655,114	435,753,291	3.95
1900	198,964	11,491,034,960	1,519,570,830	509,289,944	4.43
1901	202,288	11,688,147,091	1,622,014,685	540,140,744	4.62
1902	207,253	12,134,182,964	1,769,447,408	598,206,186	4.93
1903	213,422	12,599,990,258	1,950,743,636	634,924,788	5.04
1904	220,112	13,213,124,679	2,024,555,061	623,509,113	4.72
1905	225,196	13,805,258,121	2,134,208,156	679,518,807	4.92
1906	230,761	14,570,421,478	2,386,285,473	774,051,156	5.31
1907	236,949	*16,082,146,683	2,649,731,911	820,254,887	5.10
1908	237,389†	16,767,544,827	2,393,805,989	651,561,587	3.88

* Includes \$145,321,601 assigned to other than railway property, but earning net receipts.

† After taxes; to compare with British figures.

‡ This figure should be received with caution. The Interstate Commerce Commission made certain accounting changes this year. (R. Mo.)

CONSTRUCTION

Location.—An ideal line of railway connecting two terminal points would be perfectly level and perfectly straight, because in that case the resistance due to gradients and curves would be eliminated (see § *Locomotive Power*) and the cost of mechanical operation reduced to a minimum. But that ideal is rarely if ever attainable. In the first place the route of a railway must be governed by commercial considerations. Unless it be quite short, it can scarcely ever be planned simply to connect its two terminal points, without regard to the intervening country; in order to be of the greatest utility and to secure the greatest revenue it must be laid out with due consideration of the traffic

arising at intermediate places, and as these will not usually lie exactly on the direct line, deviations from straightness will be rendered necessary. In the second place, except in the unlikely event of all the places on the selected route lying at the same elevation, a line that is perfectly level is a physical impossibility; and from engineering considerations, even one with uniform gradients will be impracticable on the score of cost, unless the surface of the country is extraordinarily even. In these circumstances the constructor has two broad alternatives between which to choose. On the one hand he may make the line follow the natural inequalities of the ground as nearly as may be, avoiding the elevations and depressions by curves; or on the other he may aim at making it as nearly straight and level as possible by taking it through the elevations in cuttings or tunnels and across the depressions on embankments or bridges. He will incline to the first of these alternatives when cheapness of first cost is a desideratum, but, except in unusually favourable circumstances, the resulting line, being full of sharp curves and severe gradients, will be unsuited for fast running and will be unable to accommodate heavy traffic economically. If, however, cost within reasonable limits is a secondary consideration and the intention is to build a line adapted for express trains and for the carriage of the largest volume of traffic with speed and economy, he will lean towards the second. In practice every line is a compromise between these two extremes, arrived at by carefully balancing a large number of varying factors. Other things being equal, that route is best which will serve the district most conveniently and secure the highest revenue; and the most favourable combination of curves and gradients is that by which the annual cost of conveying the traffic which the line will be called on to carry, added to the annual interest on the capital expended in construction, will be a minimum.

Cuttings and Embankments.—A cutting, or cut, is simply a trench dug in a hill or piece of rising ground, wide enough at the bottom to accommodate one or more pairs of rails, and deep enough to enable the line to continue its course on the level or on a moderate gradient. The slopes of the sides vary according to the nature of the ground, the amount of moisture present, &c. In solid rock they may be vertical; in gravel, sand or common earth they must, to prevent slipping, rise 1 ft. for 1 to $1\frac{1}{2}$ or 2 ft. of base, or even more in treacherous clay. In soft material the excavation may be performed by mechanical excavators or "steam navvies," while in hard it may be necessary to resort to blasting. Except in hard rock, the top width of a cutting, and therefore the amount of material to be excavated, increases rapidly with the depth; hence if a cutting exceeds a certain depth, which varies with the particular circumstances, it may be more economical, instead of forming the sides at the slope at which the material of which they are composed will stand, to make them nearly vertical and support the soil with a retaining wall, or to bore a tunnel. An embankment-bank, or fill, is the reverse of a cutting, being an artificial mound of earth on which the railway is taken across depressions in the surface of the ground. An endeavour is made so to plan the works of a railway that the quantity of earth excavated in cuttings shall be equal to the quantity required for the embankments; but this is not always practicable, and it is sometimes advantageous to obtain the earth from some source close to the embankment rather than incur the expense of hauling it from a distant cutting. As embankments have to support the weight of heavy trains, they must be uniformly firm and well drained, and before the line is fully opened for traffic they must be allowed time to consolidate, a process which is helped by running construction or mineral trains over them.

An interesting case of embankment and cutting in combination was involved in crossing Chat Moss on the Liverpool & Manchester railway. The moss was $4\frac{1}{2}$ m. across, and it varied in depth from 10 to 30 ft. Its general character was such that cattle could not stand on it, and a piece of iron would sink in it. The subsoil was composed principally of clay and sand, and the railway had to be carried over the moss on the level, requiring cutting, and embanking

for upwards of 4 m. In forming 277,000 cub. yds. of embankment 670,000 yds. of raw peat were consumed, the difference being occasioned by the squeezing out of the water. Large quantities of embanking were sunk in the moss, and, when the engineer, George Stephenson, after a month's vigorous operations, had made up his estimates, the apparent work done was sometimes less than at the beginning of the month. The railway ultimately was made to float on the bog. Where embankment was required drains about 5 yds. apart were cut, and when the moss between them was dry it was used to form the embankment. Where the way was formed on the level, drains were cut on each side of the intended line, and were intersected here and there by cross drains, by which the upper part of the moss was rendered dry and firm. On this surface hurdles were placed, 4 ft. broad and 9 long, covered with heath, upon which the ballast was laid.

Bridges.—For conveying small streams through embankments, channels or culverts are constructed in brickwork or masonry. Larger rivers, canals, roads, other railways and sometimes deep narrow valleys are crossed by bridges (*q.v.*) of timber, brick, stone, wrought iron or steel, and many of these structures rank among the largest engineering works in the world. Sometimes also a viaduct consisting of a series of arches is preferred to an embankment when the line has to be taken over a piece of flat alluvial plain, or when it is desired to economize space and to carry the line at a sufficient height to clear the streets, as in the case of various railways entering London and other large towns. In connexion with a railway many bridges have also to be constructed to carry public roads and other railways over the line, and for the use of owners or tenants whose land it has cut through ("accommodation bridges"). In the early days of railways, roads were often taken across the line on the level, but such "level" or "grade" crossings are now usually avoided in the case of new lines in populous countries, except when the traffic on both the road and the railway is very light. In many instances old level crossings have been replaced by over-bridges with long sloping approaches; in this way considerable expenditure has been involved, justified, however, by the removal of a danger to the public and of interruptions to the traffic on both the roads and the railways. In cases where the route of a line runs across a river or other piece of water so wide that the construction of a bridge is either impossible or would be more costly than is warranted by the volume of traffic, the expedient is sometimes adopted of carrying the wagons and carriages across bodily with their loads on train ferries, so as to avoid the inconvenience and delay of transshipment. Such train ferries are common in America, especially on the Great Lakes, and exist at several places in Europe, as in the Baltic between Denmark and Sweden and Denmark and Germany, and across the Straits of Messina.

Gradients.—The gradient or grade of a line is the rate at which it rises or falls, above or below the horizontal, and is expressed by stating either the horizontal distance in which the change of level amounts to 1 ft., or the amount of change that would occur in some selected distance, such as 100 ft., 1000 ft. or 1 m. In America a gradient of 1 in 100 is often known as a 1% grade, one of 2 in 100 as a 2% grade, and so on; thus a 0.25% grade corresponds to what in England would be known as a gradient of 1 in 400. The ruling gradient of a section of railway is the steepest incline in that section, and is so called because it governs or rules the maximum load that can be placed behind an engine working over that portion of line. Sometimes, however, a sharp incline occurring on an otherwise easy line is not reckoned as the ruling gradient, trains heavier than could be drawn up it by a single engine being helped by an assistant or "bank" engine; sometimes also "momentum" or "velocity" grades, steeper than the ruling gradient, are permitted for short distances in cases where a train can approach at full speed and thus surmount them by the aid of its momentum. An incline of 1 in 400 is reckoned easy, of 1 in 200 moderate and of 1 in 100 heavy. The ruling gradient of the Liverpool & Manchester railway was fixed at 1 in 900, excepting the inclines at Liverpool and at Rainhill summit, for working which special provision was made; and I. K. Brunel laid out the Great Western for a long distance

out of London with a ruling gradient of 1 in 1320. Other engineers, however, such as Joseph Locke, cheapened the cost of construction by admitting long slopes of 1 in 80 or 70. One of the steepest gradients in England on an important line is the Lickey incline at Bromsgrove, on the Midland railway between Birmingham and Gloucester, where the slope is 1 in 37 for two miles. The maximum gradient possible depends on climatic conditions, a dry climate being the most favourable. The theoretical limit is about 1 in 16; between 1 in 20 and 1 in 16 a steam locomotive depending on the adhesion between its wheels and the rails can only haul about its own weight. In practice the gradient should not exceed 1 in 22½, and even that is too steep, since theoretical conditions cannot always be realized; a wet rail will reduce the adhesion, and the gradients must be such that some paying load can be hauled in all weathers. When an engineer has to construct a railway up a hill having a still steeper slope, he must secure practicable gradients by laying out the line in ascending spirals, if necessary tunnelling into the hill, as on the St Gothard railway, or in a series of zigzags, or he must resort to a rack or a cable railway.

Rack Railways.—In rack railways a cog-wheel on the engine engages in a toothed rack which forms part of the permanent way. The earliest arrangement of this kind was patented by John Blenkinsop, of the Middleton Colliery, near Leeds, in 1811, and an engine built on his plan by Mathew Murray, also of Leeds, began in 1812 to haul coals from Middleton to Leeds over a line 3½ m. long. Blenkinsop placed the teeth on the outer side of one of the running rails, and his reason for adopting a rack was the belief that an engine with smooth wheels running on smooth rails would not have sufficient adhesion to draw the load required. It was not till more than half a century later that an American, Sylvester Marsh, employed the rack system for the purpose of enabling trains to surmount steep slopes on the Mount Washington railway, where the maximum gradient was nearly 1 in 2½. In this case the rack had pin teeth carried in a pair of angle bars. The subsequent development of rack railways is especially associated with a Swiss engineer, Nicholas Riggenbach, and his pupil Roman Abt, and the forms of rack introduced by them are those most commonly used. That of the latter is multiple, several rack-plates being placed parallel to each other, and the teeth break joint at ½, ⅓ or ¼ of their pitch, according to the number of rack-plates. In this way smoothness of working is ensured, the cog-wheel being constantly in action with the rack. Abt also developed the plan of combining rack and adhesional working, the engine working by adhesion alone on the gentler slopes but by both adhesion and the rack on the steeper ones. On such lines the beginning of a rack section is provided with a piece of rack mounted on springs, so that the pinions of the engine engage smoothly with the teeth. Racks of this type usually become impracticable for gradients steeper than 1 in 4, partly because of the excessive weight of the engine required and partly because of the tendency of the cog-wheel to mount the rack. The Locher rack, employed on the Mount Pilatus railway, where the steepest gradient is nearly 1 in 2, is double, with vertical teeth on each side, while in the Strub rack, used on the Jungfrau line, the teeth are cut in the head of a rail of the ordinary Vignoles type.

Cable Railways.—For surmounting still steeper slopes, cable railways may be employed. Of these there are two main systems: (1) a continuous cable is carried over two main drums at each end of the line, and the motion is derived either (a) from the weight of the descending load or (b) from a motor acting on one of the main drums; (2) each end of the cable is attached to wagons, one set of which accordingly ascends as the other descends. The weight required to cause the downward motion is obtained either by means of the material which has to be transported to the bottom of the hill or by water ballast, while to aid and regulate the motion generally steam or electric motors are arranged to act on the main drums, round which the cable is passed with a sufficient number of turns to prevent slipping. When water ballast is employed the water is filled into a tank in the bottom of the wagon or car, its quantity, if passengers are carried, being regulated by the number ascending or descending.

Curves.—The curves on railways are either simple, when they consist of a portion of the circumference of a single circle, or compound, when they are made up of portions of the circumference of two or more circles of different radius. Reverse curves are compound curves in which the components are of contrary flexure, like the letter S; strictly the term is only applicable when the two portions follow directly one on the other, but it is sometimes used of cases in which they are separated by a "tangent" or portion of straight line. In Great Britain the curvature is defined by stating the length of

the radius, expressed in chains (1 chain=66 ft.), in America by stating the angle subtended by a chord 100 ft. long; the measurements in both methods are referred to the central line of the track. The radius of a 1-degree curve is 5730 ft., or about 86½ chains, of a 15-degree curve 383 ft. or rather less than 6 chains; the former is reckoned easy, the latter very sharp, at least for main lines on the standard gauge. On some of the earlier English main lines no curves were constructed of a less radius than a mile (80 chains), except at places where the speed was likely to be low, but in later practice the radius is sometimes reduced to 40 or 30 chains, even on high-speed passenger lines.

When a train is running round a curve the centrifugal force which comes into play tends to make its wheel-flanges press against the outer rail, or even to capsize it. If this pressure is not relieved in some way, the train may be derailed either (1) by "climbing" the outer rail, with injury to that rail and, generally, to the corresponding wheel-flanges; (2) by overturning about the outer rail as a hinge, possibly without injury to rails or wheels; or (3) by forcing the outer rail outwards, occasionally to the extent of shearing the spikes that hold it down at the curve, thus spreading or destroying the track. In any case the details depend upon whether the vehicle concerned is an engine, a wagon or a passenger coach, and upon whether it runs on bogie-trucks or not. If it is an engine, particular attention must be directed to the type, weight, arrangement of wheels and height of centre of gravity above rail level. In considering the forces that produce derailment the total mass of the vehicle or locomotive may be supposed to be concentrated at its centre of gravity. Two lines may be drawn from this point, one to each of the two rails, in a plane normal to the rails, and the ends of these lines, where they meet the rails, may be joined to complete a triangle, which may conveniently be regarded as a rigid frame resting on the rails. As the vehicle sweeps round the curve the centre of gravity tends to be thrown outwards, like a stone from a horizontal sling. The vertical pressure of the frame upon the outer rail is thus increased, while its vertical pressure on the inner rail is diminished. Simultaneously the frame as a whole tends to slide horizontally athwart the rails, from the inner towards the outer rail, urged by the same centrifugal forces. This sliding movement is resisted by placing a check rail on the inner side of the inner rail, to take the lateral thrust of the wheels on that side. It is also resisted in part by the conicity of the wheels, which converts the lateral force partly into a vertical force, thus enabling gravity to exert a restoring influence. When the lateral forces are too great to be controlled "climbing" occurs. Accidents due to simple climbing are, however, exceedingly rare, and are usually found associated with a faulty track, with "plunging" movements of the locomotive or vehicle, or with a "tight gauge" at curves or points.

From consideration of the rigid triangular frame described above, it is clear that the "overturning" force acts horizontally from the centre of gravity, and that the length of its lever arm is, at any instant, the vertical distance from the centre of gravity to the level of the outer rail. This is true whatever be the tilt of the vehicle at that instant. The restoring force exerted by gravity acts in a vertical line from the centre of gravity; and the length of its lever arm is the horizontal distance between this vertical line and the outer rail. If therefore the outer rail is laid at a level above that of the inner rail at the curve, overturning will be resisted more than would be the case if both rails were in the same horizontal plane, since the tilting of the vehicle due to this "superelevation" diminishes the overturning moment, and also increases the restoring moment, by shortening in the one case and lengthening in the other the lever arms at which the respective forces act. The amount of superelevation required to prevent derailment at a curve can be calculated¹ under perfect running conditions, given the radius of curvature, the weight of the vehicle, the height of the centre of gravity, the distance between the rails, and the speed; but great experience

¹ See *The Times Engineering Supplement* (August 22, 1906), p. 265.

is required for the successful application of definite formulæ to the problem. For example, what is a safe speed at a given curve for an engine, truck or coach having the load equally distributed over the wheels may lead to either climbing or overturning if the load is shifted to a diagonal position. An ill-balanced load also exaggerates "plunging," and if the period of oscillation of the load happens to agree with the changes of contour or other inequalities of the track vibrations of a dangerous character, giving rise to so-called "sinuous" motion, may occur.

In general it is not curvature, but change of curvature, that presents difficulty in the laying-out of a line. For instance, if the curve is of S-form, the point of danger is when the train enters the contra-flexure, and it is not an easy matter to assign the best superelevation at all points throughout the double bend. Closely allied to the question of safety is the problem of preventing jolting at curves; and to obtain easy running it is necessary not merely to adjust the levels of the rails in respect to one another, but to tail off one curve into the next in such a manner as to avoid any approach to abrupt lateral changes of direction. With increase of speeds this matter has become important as an element of comfort in passenger traffic. As a first approximation, the centre-line of a railway may be plotted out as a number of portions of circles, with intervening straight tangents connecting them, when the abruptness of the changes of direction will depend on the radii of the circular portions. But if the change from straight to circular is made through the medium of a suitable curve it is possible to relieve the abruptness, even on curves of comparatively small radius. The smoothest and safest running is, in fact, attained when a "transition," "easement" or "adjustment" curve is inserted between the tangent and the point of circular curvature.

For further information see the following papers and the discussions on them: "Transition Curves for Railways," by James Glover, *Proc. Inst. C.E.* vol. 140, part ii.; and "High Speed on Railway Curves," by J. W. Spiller, and "A Practical Method for the Improvement of Existing Railway Curves," by W. H. Shortt, *Proc. Inst. C.E.* vol. 176, part ii.

Gauge.—The gauge of a railway is the distance between the inner edges of the two rails upon which the wheels run. The width of 4 ft. 8½ in. may be regarded as standard, since it prevails on probably three-quarters of the railways of the globe. In North America, except for small industrial railways and some short lines for local traffic, chiefly in mountainous country, it has become almost universal; the long lines of 3 ft. gauge have mostly been converted, or a third rail has been laid to permit interchange of vehicles, and the gauges of 5 ft. and more have disappeared. A considerable number of lines still use 4 ft. 9 in., but as their rolling stock runs freely on the 4 ft. 8½ in. gauge and vice versa, this does not constitute a break of gauge for traffic purposes. The commercial importance of such free interchange of traffic is the controlling factor in determining the gauge of any new railway that is not isolated by its geographical position. In Great Britain railways are built to gauges other than 4 ft. 8½ in. only under exceptional conditions; the old "broad gauge" of 7 ft. which I. K. Brunel adopted for the Great Western railway disappeared on the 20th-23rd of May 1892, when the main line from London to Penzance was converted to standard gauge throughout its length. In Ireland the usual gauge is 5 ft. 3 in., but there are also lines laid to a 3 ft. gauge. On the continent of Europe the standard gauge is generally adopted, though in France there are many miles of 4 ft. 9 in. gauge; the normal Spanish and Portuguese gauge is, however, 5 ft. 5½ in., and that of Russia 5 ft. In France and other European countries there is also an important mileage of metre gauge, and even narrower, on lines of local or secondary importance. In India the prevailing gauge is 5 ft. 6 in., but there is a large mileage of other gauges, especially metre. In the British colonies the prevailing gauge is 3 ft. 6 in., as in South Africa, Queensland, Tasmania and New Zealand; but in New South Wales the normal is 4 ft. 8½ in. and in Victoria 5 ft. 3 in., communication between different countries of the

Australian Commonwealth being thus carried on under the disadvantage of break of gauge. Though the standard gauge is in use in Lower Egypt, the line into the Egyptian Sudan was built on a gauge of 3 ft. 6 in., so that if the so-called Cape to Cairo railway is ever completed, there will be one gauge from Upper Egypt to Cape Town. In South America the 5 ft. 6 in. gauge is in use, with various others.

Mono-Rail Systems.—The gauge may be regarded as reduced to its narrowest possible dimensions in mono-rail lines, where the weight of the trains is carried on a single rail. This method of construction, however, has been adopted only to a very limited extent. In the Lartigue system the train is straddled over a single central rail, elevated a suitable distance above the ground. A short line of this kind runs from Ballybunion to Listowel in Ireland, and a more ambitious project on the same principle, on the plans of Mr F. B. Behr, to connect Liverpool and Manchester, was sanctioned by Parliament in 1901. In this case electricity was to be the motive-power, and speeds exceeding 100 m. an hour were to be attained, but the line has not been built. In the Langen mono-rail the cars are hung from a single overhead rail; a line on this system works between Barmen and Elberfeld, about 9 m., the cars for a portion of the distance being suspended over the river Wupper. In the system devised by Mr Louis Brennan the cars run on a single rail laid on the ground, their stability being maintained by a heavy gyostat revolving at great speed in a vacuum.

Permanent Way.—When the earth-works of a line have been completed and the tops of the embankments and the bottoms of the cuttings brought to the level decided upon, the next step is to lay the permanent way, so-called probably in distinction to the temporary way used during construction. The first step is to deposit a layer of ballast on the road-bed or "formation," which often slopes away slightly on each side from the central line to facilitate drainage. The ballast consists of such materials as broken stone, furnace slag, gravel, cinders or earth, the lower layers commonly consisting of coarser materials than the top ones, and its purpose is to provide a firm, well-drained foundation in which the sleepers or cross-ties may be embedded and held in place, and by which the weight of the track and the trains may be distributed over the road-bed. Its depth varies, according to the traffic which the line has to bear, from about 6 in. to 1 ft. or rather more under the sleepers, and the materials of the surface layers are often chosen so as to be more or less dustless. Its width depends on the numbers of tracks and their gauge; for a double line of standard gauge it is about 25 ft., a space of 6 ft. ("six-foot way") being left between the inner rails of each pair in Great Britain (fig. 8), and a rather larger distance in America

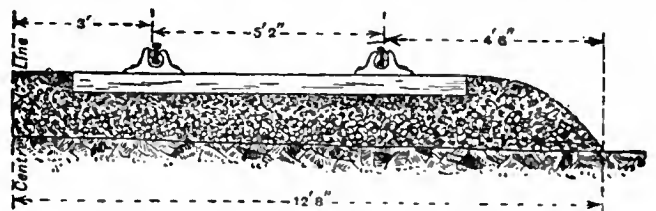

FIG. 8.—Half of English Double Track.

(fig. 9), where the over-hang of the rolling stock is greater. The intervals between the sleepers are filled in level with ballast,

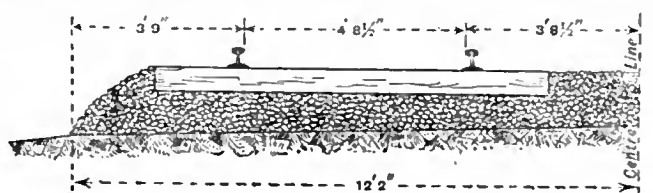

FIG. 9.—Half of American Double Track.

which less commonly is also heaped up over them, especially at the projecting ends.

Sleepers, called ties or cross-ties in America, are the blocks or slabs on which the rails are carried. They are nearly always placed transversely, across the direction of the lines, the longitudinal position such as was adopted in connexion with the broad gauge on the Great Western in England having been abandoned except in special cases. Stone blocks were tried as sleepers in the early days of railways, but they proved too rigid, and besides, it was found difficult to keep the line true with them. Wood is the material most widely used, but steel is employed in some countries where timber is scarce or liable to destruction by white ants, though it is still regarded as too expensive in comparison with wood for general adoption. Steel sleepers were used experimentally on the London & North-Western, but were abandoned owing to the shortness of their life. In Germany, where they have met with greater favour, there were over 26½ millions in use in 1905,¹ and they have been tried by some American railways. Numerous forms of ferro-concrete sleepers have also been devised.

In Great Britain, Germany and France, at least 90% of the wooden sleepers are "treated" before they are laid, to increase their resistance to decay, and the same practice is followed to some extent in other European countries. A great number of preservative processes have been devised. In that most largely used, known as "creosoting," dead oil of tar, to the amount of some 3 gallons per sleeper, is forced into the wood under pressure, or is sucked in by vacuum, both the timber and the oil being heated. In the United States only a small percentage of the ties are treated in any way beyond seasoning in the open air, timber, in the opinion of the railway officials, being still too cheap in nearly all parts of that country to justify the use of preservatives. Some railway companies, however, having a long mileage in timberless regions, do "treat" their sleepers.

Typical dimensions for sleepers on important British railways are:—length 9 ft., breadth 10 in., and depth 5 in. In America 8 ft. is the most common length, the breadth being 8 in., and the depth 6 or 7 in.

There are two main ways of attaching the rails to the sleepers, corresponding to two main types of rails—the bull-headed rail

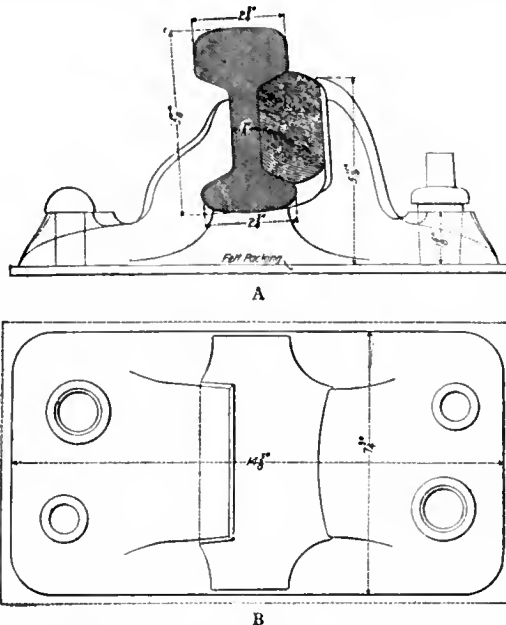

FIG. 10.—A, Section of British Bull-Headed Rail, 90 lb to the yard, showing also chair and fastenings. B, Plan of Chair.

and the Vignoles or flange rail. In the first method, which is practically universal in Great Britain and is also employed to

¹ See a full account of steel sleepers in a paper read by A. Haarmann before the Verein der Deutschen Eisenhüttenleute on Dec. 8, 1907, translated in the *Railway Gazette* (London) on April 3, 10 and 17, 1908.

some extent in France and India, the rails have rounded bases and are supported by being wedged, with wooden keys, in cast-iron chairs which are bolted to the sleepers. In the second method the rails have flat flanged bases which rest directly on the sleepers (fig. 10). The chairs on the British system weigh about 45 or 50 lb each on important lines, though they may be less where the traffic is light, and are fixed to the sleepers each by two, three or four fastenings, either screw spikes, or round drift bolts entered in holes previously bored, or fang bolts or wooden trenails. Sometimes a strip of felt is interposed between the chair and the sleeper, and sometimes a serrated surface is prepared on the sleeper for the chair which is forced into its seat by hydraulic pressure. The keys which hold the rail in the chairs are usually of oak and are placed outside the rails; the inside position has also been employed, but has the disadvantage of detracting from the elasticity of the road since the weight of a passing train presses the rails up against a rigid mass of metal instead of against a slightly yielding block of wood. The rails, which for heavy main line traffic may weigh as much as 100 lb per yard, or even more, are rolled in lengths of from 30 to 60 ft., and sleepers are placed under them at intervals of between 2 and 3 ft. (centre to centre), 11 sleepers to a 30 ft. rail being a common arrangement. On the London & North-Western railway there are 24 sleepers to each 60 ft. rail. A small space is left between the end of one rail and that of the next, in order to allow for expansion in hot weather, and at the joint the two are firmly braced together by a pair of fish-plates (fig. 11). These are flat bars of iron or steel from 18 in. to 2 ft. long, which are lodged in the channels of the rail, one on each side, and secured with four bolts passing through the web; sometimes, to give additional stiffness, they extend down below the lower table of the rail and are bent round so as to clip it. Occasionally the joints thus formed are "supported" on a sleeper, as was the practice in the early days of railway construction, but they are generally "suspended" between two sleepers, which are set rather more closely together than at other points in the rail. Preferably, they are so arranged that those in both lines of rails come opposite each other and are placed between the same pair of sleepers.



FIG. 11.—British Rail and Rail Joint.

Flat-bottomed rails are fastened to the sleepers by hook-headed spikes, the heads of which project over the flanges. In the United States the spikes are simply driven in with a maul, and the rails stand upright, little care being taken to prepare seats for them on the sleepers, on which they soon seat themselves. The whole arrangement is simple and cheap in first cost, and it lends itself admirably to fast track-laying and to repairs and changes of line. On the continent of Europe the practice is common of notching the sleeper so as to give the rail a slight cant inwards—a result obtained in England by canting the rail in the chairs—and metal plates or strips of felt are put under the rail, which is carefully fastened to the sleeper by screwed spikes (fig. 12). This method of construction is more

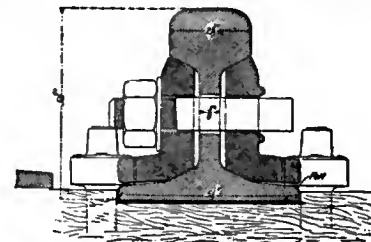

FIG. 12.—French Rail, 90½ lb to the yard, showing rail joint and seat in the sleeper.

expensive than the American in first cost, but it gives a more durable and stable track. Such metal plates, or "tie-plates," have come into considerable use also in the United States, where they are always made of rolled steel, punched with rectangular holes through which the spikes pass. They serve two principal

purposes: they diminish the wear of the sleeper under the rail by providing a larger bearing surface, and they help to support the spikes and so to keep the gauge. On all the accepted forms there are two or more flanges at the bottom, running lengthwise of the plate and crosswise of the rail; these are requisite to give proper stiffness, and further, as they are forced into the tie by the weight of passing traffic, they help to fix the plate securely in place. The joints of flanged rails are similar to those employed with bull-headed rails. Various forms, mostly patented, have been tried in the United States, but the one most generally adopted consists of two symmetrical angle bars (fig. 13),

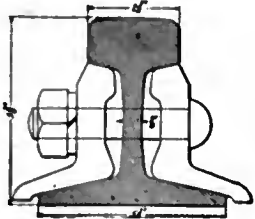

FIG. 13.—American Rail, 90 lb to the yard, showing rail joint.

varying in length (from 20 to 48 in.), in weight and in the number of bolts, which may be four or six. The substitution of steel for iron as the material for rails which made possible the axle loads and the speeds of to-day, and, by reducing the cost of maintenance, contributed enormously to the economic efficiency of railways, was one of the most important events in the history of railways, and a scarcely less important element of progressive economy has been the continued improvement of the steel rail in stiffness of section and in toughness and hardness of material. Carbon is the important element in controlling hardness, and the amount present is in general higher in the United States than in Great Britain. The specifications for bull-headed rails issued by the British Engineering Standards Committee in 1904 provided for a carbon-content ranging from 0.35 to 0.50%, with a phosphorus maximum of 0.075%. In the United States a committee of the American Society of Civil Engineers, appointed to consider the question of rail manufacture in consequence of an increase in the number of rail-failures, issued an interim report in 1907 in which it suggested a range of carbon from 0.55 to 0.65% for the heaviest sections of Bessemer steel flange rails, with a phosphorus maximum of 0.085%; while the specifications of the American Society for Testing Materials, current at the same period, put the carbon limits at 0.45 to 0.55%, and the phosphorus limit at 0.10. For rails of basic open-hearth steel, which is rapidly ousting Bessemer steel, the Civil Engineers' specifications allowed from 0.65 to 0.75% of carbon with 0.05% of phosphorus, while the specifications of the American Railway Engineering and Maintenance of Way Association provided for a range of 0.75 to 0.85% of carbon, with a maximum of 0.03% of phosphorus. The rail-failures mentioned above also drew renewed attention to the importance of the thermal treatment of the steel from the time of melting to the last passage through the rolling mill and to the necessity of the finishing temperature being sufficiently low if the product is to be fine grained, homogeneous and tough; and to permit of this requirement being met there was a tendency to increase the thickness of the metal in the web and flanges of the rails. The standard specification adopted by the Pennsylvania railway in 1908 provided that in rails weighing 100 lb to the yard 41% of the metal should be in the head, 18.6% in the web, and 40.4% in the base, while for 85 lb rails 42.2% was to be in the head, 17.8% in the web and 40.0% in the base. These rails were to be rolled in 33-ft. lengths. According to the specification for 85 lb rails adopted by the Canadian Pacific railway about the same time, 36.77% of the metal was to be in the head, 22.21% in the web and 41.02% in the base.

Points and Crossings.—To enable trains to be transferred from one pair of rails to another pair, as from the main line to a siding, "points" or "switches" are provided. At the place where the four rails come together, the two inner ones (one of the main line and the other of the siding), known as "switch rails" (*b*, fig. 14), are tapered to a fine point or tongue, and rigidly connected together at such a distance apart that when one of the points is pressed against the outer or "stock"

rail (*a*) of either the siding or the main line there is sufficient space between the other tongue and the other stock rail to permit the free passage of the flanges of the wheels on one side of the train, while the flanges on the other side find a continuous path along the other switch rail and thus are deflected in the desired direction. The same arrangement is employed at junctions where different running lines converge. The points over which a train travels when directed from the main to a branch line are called "facing points" (FP), while those which it passes when running from a branch to a main line are "trailing points" (TP). In Great Britain the Board of Trade requires facing points to be avoided as far as possible; but, of course, they are a necessity at junctions where running lines diverge and at the crossing places which must be provided to enable trains to pass each other on single-track lines. At stations the points that give access to sidings are generally arranged as trailing points with respect to the direction of traffic on the main lines; that is, trains cannot pass direct into sidings,

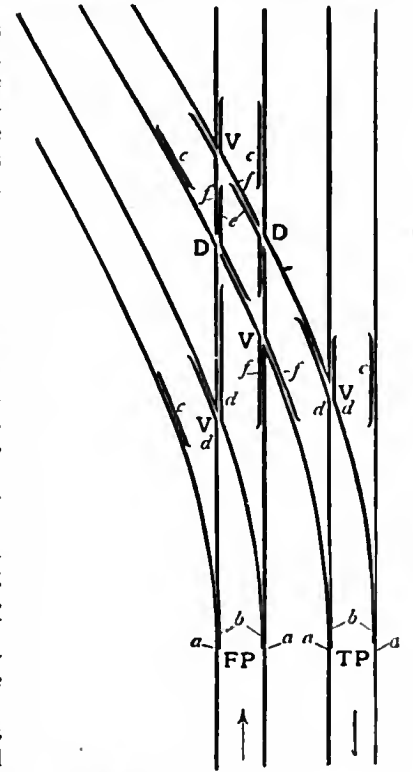

FIG. 14.—Points and Crossings.

- FP = Facing points.
- TP = Trailing points.
- a = Stock rail.
- b = Switch rail.
- V = Single or V-crossing.
- D = Diamond crossing.
- c = Check rails.
- d = Wing rails.
- e = Winged check rails.
- f = Diamond points.

but have to stop and then run backwards into them. In shunting yards the points are commonly set in the required direction by means of hand levers placed close beside the lines, but those at junctions and those which give access from the main lines to sidings at wayside stations are worked by a system of rods from the signal cabin, or by electric or pneumatic power controlled from it and interlocked with the signals (see SIGNAL: § Railway). Crossings are inevitable adjuncts of points. Where a branch diverges from a main line, one rail of the one must cross one rail of the other, and a V-crossing is formed (V). Where, as at a double-line junction, one pair of rails crosses another pair, "diamond" crossings (D) are formed. At both types of crossing, check rails (*c*) must be provided to guide the wheel-flanges, and if these are not accurately placed the safety of the trains will be endangered. At double-line junctions trains passing over the diamond crossings evidently block traffic going in the opposite direction to that in which they are travelling. To avoid the delay thus caused the branch line which would occasion the diamond crossing if it were taken across on the level is sometimes carried over the main line by an over-bridge ("flying junction") or under it by an under-bridge ("burrowing junction").

Railway Stations.—Railway stations are either "terminal" or "intermediate." A terminal station embraces (1) the passenger station; (2) the goods station; (3) the locomotive, carriage and waggon depots, where the engines and the carrying stock are kept, cleaned, examined and repaired. At many intermediate stations the same arrangements, on a smaller scale, are made; in all of them there is at least accommodation for the passenger and the goods traffic. The stations for

passengers and goods are generally in different and sometimes in distant positions, the place selected for each being that which is most convenient for the traffic. The passenger station abuts on the main line, or, at termini, forms the natural terminus, at a place as near as can conveniently be obtained to the centre of the population which constitutes the passenger traffic; and preferably its platforms should be at or near the ground level, for convenience of access. The goods station is approached by a siding or fork set off from the main line at a point short of the passenger station. In order to keep down the expense of shunting the empty trains and engines to and from the platforms the carriage and locomotive depots should be as near the passenger station as possible; but often the price of land renders it impracticable to locate them in the immediate vicinity and they are to be found at a distance of several miles.

In laying out the approaches and station yard of a passenger station ample width and space should be provided, with well-defined means of ingress and egress to facilitate the circulation of vehicles and with a long setting-down pavement to enable them to discharge their passengers and luggage without delay. The position of the main buildings—ticket offices, waiting and refreshment-rooms, parcels offices, &c.—relative to the direction of the lines of rails may be used as a means of classifying terminal stations. They are placed either on the departure side parallel to the platform ("side" stations) or at right angles to the rails and platforms ("end" stations). Many large stations, however, are of a mixed type, and the offices are arranged in a fork between two or more series of platforms, or partly at the end and partly on one side. Where heavy suburban traffic has to be dealt with, the expedient is occasionally adopted of taking some of the lines round the end in a continuous loop, so that incoming trains can deposit their passengers at an underground platform and immediately proceed on their outward journey. Intermediate stations, like terminal ones, should be convenient in situation and easy of approach, and, especially if they are important, should be on the ground level rather than on an embankment or in a cutting. The lines through them should be, if possible, straight and on the level; the British Board of Trade forbids them being placed on a gradient steeper than 1 in 260, unless it is unavoidable. Intermediate stations at the surface level are naturally constructed as side stations, and whether offices are provided on both sides or whether they are mainly concentrated on one will depend on local circumstances, the amount of the traffic, and the direction in which it preponderates. When the railway lies below the surface level the bulk of the offices are often placed on a bridge spanning the lines, access being given to the platforms by staircases or lifts, and similarly when the railway is at a high level the offices may be arranged under the lines. Occasionally on a double-track railway one platform placed between the tracks serves both of them; this "island" arrangement, as it is termed, has the advantage that more tracks can be readily added without disturbance of existing buildings, but when it is adopted the exit from the trains is at the opposite side to that which is usual, and accidents have happened through passengers alighting at the usual side without noticing the absence of a platform. At stations on double-track railways which have a heavy traffic four tracks are sometimes provided, the two outside ones only having platforms, so that fast trains get a clear road and can pass slow ones that are standing in the station. In Great Britain, it may be noted, trains almost invariably keep to the left, whereas in most other countries right-handed running is the rule.

The arrangement and appropriation of the tracks in a station materially affect the economical and efficient working of the traffic. There must be a sufficient provision of sidings, connected with the running tracks by points, for holding spare rolling stock and to enable carriages to be added to or taken off trains and engines to be changed with as little delay as possible. At terminal stations, especially at such as are used

by short-distance trains which arrive at and start from the same platform, a third track is often laid between a pair of platform tracks, so that the engine of a train which has arrived at the platform can pass out and place itself at the other end of the train, which remains undisturbed. At the new Victoria station (London) of the London, Brighton & South Coast railway—which is so long that two trains can stand end to end at the platforms—this system is extended so as to permit a train to start out from the inner end of a platform even though another train is occupying the outer end. One of the advantages of electric trains on the multiple control system is that they economize terminal accommodation, because they can be driven from either end indifferently, and therefore avoid the necessity for tracks by which engines can change from one end of the train to the other.

The platforms on British railways have a standard elevation of 3 ft. above rail level, and they are not now made less than 2½ ft. in height. In other countries they are generally lower; in the United States they are commonly level with, or only a few inches higher than, the top of the rails. They may consist of earth with a retaining wall along the tracks and with the surface gravelled or paved with stone or asphalt, or they may be constructed entirely of timber, or they may be formed of stone slabs supported on longitudinal walls. They should be of ample dimensions to accommodate the traffic—the British Board of Trade requires them to be not less than 6 ft. wide at small stations and not less than 12 ft. wide at large ones—and they should be as free as possible from obstructions, such as pillars supporting the roof. At intermediate stations the roofs are often carried on brackets fixed to the walls of the station buildings, and project only to the edge of the platforms. At larger stations where both the platforms and the tracks are covered in, there are two broad types of construction, with many intermediate variations: the roof may either be comparatively low, of the "ridge and furrow" pattern, borne on a number of rows of pillars, or it may consist of a single lofty span extending clear across the area from the side walls. The advantage claimed for roofs formed with one or two large spans is that they permit the platforms and tracks to be readily rearranged at any time as required, whereas this is difficult with the other type, especially since the British Board of Trade requires the pillars to be not less than 6 ft. away from the edges of the platforms. On the other hand, wide spans are more expensive both in first cost and in maintenance, and there is the possibility of a failure such as caused the collapse in December 1905 of the roof of Charing Cross (S.E.R.) station, London, which then consisted of a single span. Whatever the pattern adopted for the roof, a sufficient portion of it must be glazed to admit light, and it should be so designed that the ironwork can be easily inspected and painted and the glass readily cleaned. For the illumination of large stations by night electric arc lamps are frequently employed, but some authorities favour high-pressure incandescent gas-lighting.

At busy stations separate tracks are sometimes appropriated to the use of light engines and empty trains, on which they may be run between the platforms and the locomotive and carriage depots. A carriage depot includes sheds in which the vehicles are stored, arrangements for washing and cleaning them, and sidings on which they are marshalled into trains. At a locomotive depot the chief building is the "running shed" in which the engines are housed and cleaned. This may be rectangular in shape ("straight" shed), containing a series of parallel tracks on which the engines stand and which are reached by means of points and crossings diverging from a main track outside; or it may take a polygonal or circular form (round house or rotunda), the lines for the engines radiating from a turn-table which occupies the centre and can be rotated so as to serve any of the radiating lines. The second arrangement enables any particular engine to enter or leave without disturbing the other; but on the other hand an accident to the turn-table may temporarily imprison the whole of them. In both types pits are constructed between the rails

**Loco-
motive
depots.**

on which the engines stand to afford easy access for the inspection and cleaning of their mechanism. Machine shops are usually provided to enable minor repairs to be executed; the tendency, both in England and America, is to increase the amount of such repairing plant at engine sheds, thus lengthening the intervals between the visits of the engines to the main repairing shops of the railway. A locomotive depot further includes stores of the various materials required in working the engines, coal stages at which they are loaded with coal, and an ample supply of water. The quality of the last is a matter of great importance; when it is unsuitable, the boilers will suffer, and the installation of a water-softening plant may save more in the expenses of boiler maintenance than it costs to operate. The water cranes or towers which are placed at intervals along the railway to supply the engines with water require similar care in regard to the quality of the water laid on to them, as also to the water troughs, or track tanks as they are called in America, by which engines are able to pick up water without stopping. These consist of shallow troughs about 18 in. wide, placed between the rails on perfectly level stretches of line. When water is required, a scoop is lowered into them from below the engine, and if the speed is sufficient the water is forced up it into the tender-tanks. Such troughs were first employed on the London & North-Western railway in 1857 by John Ramsbottom, and have since been adopted on many other lines.

Goods stations vary in size from those which consist of perhaps a single siding, to those which have accommodation for thousands of wagons. At a small roadside station, where the traffic is of a purely local character, there will be some sidings to which horses and carts have access for handling bulk goods like coal, gravel, manure, &c., and a covered shed for loading and unloading packages and materials which it is undesirable to expose to the weather. The shed may have a single pair of rails for wagons running through it along one side of a raised platform, there being a roadway for carts on the other side; or if more accommodation is required there may be two tracks, one on each side of the platform, which is then approached by carts at the end. In either case the platform is fitted with a crane or cranes for lifting merchandise into and out of the wagons, and doors enable the shed to be used as a lock-up warehouse. In a large station the arrangements become much more complicated, the precise design being governed by the nature of the traffic that has to be served and by the physical configuration of the site. It is generally convenient to keep the inwards and the outwards traffic distinct and to deal with the two classes separately; at junction stations it may also be necessary to provide for the transfer of freight from one wagon to another, though the bulk of goods traffic is conveyed through to its destination in the wagons into which it was originally loaded. The increased loading space required in the sheds is obtained by multiplying the number and the length of lines and platforms; sometimes also there are short sidings, cut into the platforms at right angles to the lines, in which wagons are placed by the aid of wagon turn-tables, and sometimes the wagons are dealt with on two floors, being raised or lowered bodily from the ground level by lifts. The higher floors commonly form warehouses where traders may store goods which have arrived or are awaiting despatch. An elaborate organization is required to keep a complete check and record of all the goods entering and leaving the station, to ensure that they are loaded into the proper wagons according to their destination, that they are unloaded and sorted in such a way that they can be delivered to their consignees with the least possible delay, that they are not stolen or accidentally mislaid, &c.; and accommodation must be provided for a large clerical and supervisory staff to attend to these matters. British railways also undertake the collection and delivery of freight, in addition to transporting it, and thus an extensive range of vans and wagons, whether drawn by horses or mechanically propelled, must be provided in connexion with an important station.

Shunting Yards.—It may happen that from a large station sufficient traffic may be consigned to certain other large stations to enable full train-loads to be made up daily, or several times a day, and despatched direct to their destinations. In general, however, the conditions are less simple. Though a busy colliery may send off its product by the train-load to an important town, the wagons will usually be addressed to a number of different consignees at different depots in different parts of the town, and therefore the train will have to be broken up somewhere short of its destination and its trucks rearranged, together with those of other trains similarly constituted, into fresh trains for conveyance to the various depots. Again, a station of moderate size may collect goods destined for a great variety of places but not in sufficient quantities to compose a full train-load for any of them, and then it becomes impossible, except at the cost of uneconomical working, to avoid despatching trains which contain wagons intended for many diverse destinations. For some distance these wagons will all travel over the same line, but sooner or later they will reach a junction-point where their ways will diverge and where they must be separated. At this point trains of wagons similarly destined for different places will be arriving from other lines, and hence the necessity will arise of collecting together from all the trains all the wagons which are travelling to the same place.

The problem may be illustrated diagrammatically as follows (fig. 15): A may be supposed to be a junction outside a large

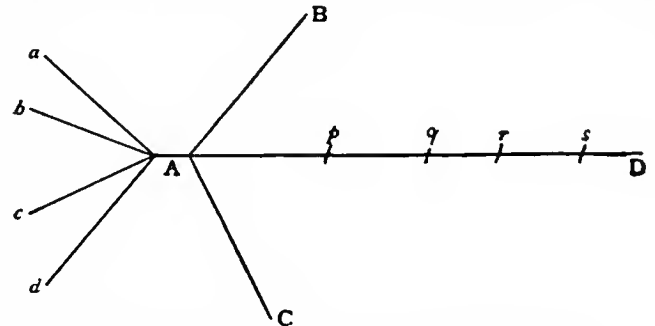

FIG. 15.—Diagram to illustrate use of Shunting Yards.

seaport where branches from docks *a*, *b*, *c*, and *d* converge, and where the main line also divides into three, going to *B*, *C* and *D* respectively. A train from *a* will contain some wagons for *B*, some for *C* and some for *D*, as will also the trains from *a*, *b*, *c* and *d*. At *A* therefore it becomes necessary to disentangle and group together all the wagons that are intended for *B*, all that are intended for *C*, and all that are intended for *D*. Even that is not the whole of the problem. Between *A* and *B*, *A* and *C*, and *A* and *D*, there may be a string of stations, *p*, *q*, *r*, *s*, &c., all receiving goods from *a*, *b*, *c* and *d*, and it would manifestly be inconvenient and wasteful of time and trouble if the trains serving those intermediate stations were made up with, say, six wagons from *a* to *p* next the engine, five from *b* to *p* at the middle, and four from *c* to *p* near the end. Hence at *A* the trucks from *a*, *b*, *c* and *d* must not only be sorted according as they have to travel along *A B*, *A C*, or *A D*, but also must be marshalled into trains in the order of the stations along those lines. Conversely, trains arriving at *A* from *B*, *C* and *D* must be broken up and remade in order to distribute their wagons to the different dock branches.

To enable the wagons to be shunted into the desired order yards containing a large number of sidings are constructed at important junction points like *A*. Such a yard consists essentially of a group or groups of sidings, equal in length at least to the longest train run on the line, branching out from a single main track and often again converging to a single track at the other end; the precise design, however, varies with the amount and character of the work that has to be done, with the configuration of the ground, and also with the mode of shunting adopted. The oldest and commonest method of shunting is that known as "push-and-pull," or in America as "link-and-pin" or "tail" shunting. An engine coupled to a batch of wagons runs one or more of them down one siding, leaves them there, then returns back with the remainder clear of the points where the sidings diverge, runs one or more others down another siding, and so on till they are all disposed of. The same operation is repeated with fresh batches of wagons, until the sidings contain a number of trains, each intended, it may be supposed, for a particular town or district. In some cases nothing more is required than to attach an engine and brake-van ("caboose") and despatch the train; but if, as will happen in others, a further rearrangement of

the wagons is necessary to get them into station order this is effected on the same principle.

Push-and-pull shunting is simple, but it is also slow, and therefore efforts have been made at busy yards where great numbers of trains are dealt with to introduce more expeditious methods. One of these, employed in America, is known as "poling." Alongside the tracks on which stand the trains that are to be broken up and from which the sidings diverge subsidiary tracks are provided for the use of the shunting engines. These engines have a pole projecting horizontally in front of them, or are attached to a "pole-car" having such a pole. The method of working is for the pole to be swung out behind a number of wagons; one engine is then started and with its pole pushes the wagons in front of it until their speed is sufficient to carry them over the points, where they are diverted into any desired siding. It then runs back to the train to repeat the operation, but while it is doing so a second engine similarly equipped has poled away a batch of wagons on the opposite side. In this way a train is distributed with great rapidity, especially if the points giving access to the different sidings are worked by power so that they can be quickly manipulated.

Another method, which was introduced into America from Europe about 1890, is that of the summit or "hump." The wagons are pushed by an engine at their rear up one slope of an artificial mound, and as they run down the other slope by gravity are switched into the desired siding. Sometimes a site can be found for the sorting sidings where the natural slope of the ground is sufficiently steep to make the wagons run down of themselves. One of the earliest and best known of such "gravity" yards is that at Edgehill, near Liverpool, on the London & North-Western railway, which was established in 1873. Here, at the highest level, there are a number of "upper reception lines" converging to a single line which leads to a group of "sorting sidings" at a lower level. These in turn converge to a pair of single lines which lead to two groups of marshalling sidings, called "gridirons" from their shape, and these again converge to single lines leading to "lower reception and departure lines" at the bottom of the slope. The wagons from the upper reception lines are sorted into trains on the sorting sidings, and then, in the gridirons, are arranged in the appropriate order and marshalled ready to be sent off from the departure lines. (H. M. R.)

LOCOMOTIVE POWER

The term "power" is used in technical sense to mean the rate at which work is done against a resistance, and is measured in units of energy expended per unit of time. The unit of power commonly used by engineers is the horse-power, and this unit corresponds to a rate of working of 550 foot-lb of work per second. The problems arising out of the special consideration of the power required to propel a railway train against the resistances opposing its motion, the way the power is applied to trains, the agent by means of which the power is exerted, are conveniently grouped together under the general heading of Locomotive Power. There are certain fundamental relations common to all tractive problems, and these are briefly considered in §§ 1 and 2, after which the article refers particularly to steam locomotives, although §§ 4, 5, 7, 8, 9, and 10 have a general application to all modes of traction.

§ 1. *Fundamental Relations.*—The resistance against which a train is moved along a railway is overcome by means of energy obtained from the combustion of fuel, or in some few cases by energy obtained from a waterfall. If the total resistance against which the train is maintained in motion with an instantaneous velocity of V feet per second is R , the rate at which energy is expended in moving the train is represented by the product RV , and this must be the rate at which energy is supplied to the train after deducting all losses due to transmission from the source of power. Thus if R is equal to 10,000 lb when the velocity is 44 ft. per second, equivalent to 30 m. per hour, the rate of working against the resistance is 440,000 foot-lb per second.

In whatever form energy is produced and distributed to the train it ultimately appears as mechanical energy applied to turn one or more axles against the resistance to their rotation imposed by the weight on the wheels and the motion of the train.

The rate at which work is done on a particular axle is measured by the product $T\omega$, where T is the torque or turning moment exerted on the axle by the motor or mechanism applied to it for this purpose, and ω is the angular velocity of the axle in radians per second. Hence if all the energy supplied to the train is utilized at one axle there is the fundamental relation

$$T\omega = RV \tag{1}$$

Continuing the above arithmetical illustration, if the wheels to the axle of which the torque is applied are 4 ft. diameter, $\omega = 44/2 = 22$ radians per second, and therefore $T = 440,000/22 = 20,000$ lb ft. If the energy supplied is distributed between several axles the relation becomes

$$T_1\omega_1 + T_2\omega_2 + T_3\omega_3 \dots = RV \tag{2}$$

where T_1, T_2, T_3, \dots are the torques on the axles whose respective angular velocities are $\omega_1, \omega_2, \omega_3, \dots$.

The fundamental condition governing the design of all tractive machinery is that the wheels belonging to the axles to which torque is applied shall roll along the rails without slipping, and exert a tractive force on the train.

The fundamental relation between the applied torque and the tractive force F will be understood from fig. 16, which shows in a diagrammatic form a wheel and axle connected to the framework of a vehicle, in the way adopted for railway trains. The journal of the axle A , is carried in a bearing or axle-box B , which is free to move vertically in the wide vertical slot G , formed in the frame and called generally "the horns," under the control of the spring. The weight W_1 carried by the part of the frame supported by the wheel (whose diameter is D) is transmitted first to the pins P_1, P_2 , which are fixed to the frame, and then to the spring links L_1, L_2 , which are jointed at their respective ends to the spring S , the centre of which rests on the axle-box.

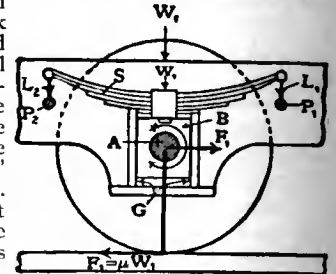

FIG. 16.—Wheel and Connexion to Frame.

Let a couple be applied to the axle tending to turn it in the direction shown by the arrow. This couple, we may assume, will be equally divided between the two wheels, so that the torque acting on each will be $\frac{1}{2}T$. Assuming the wheels to roll along the rail without slipping, this couple will be equivalent to the couple formed by the equal opposite and parallel forces, F_1 acting in the direction shown, from the axle-box on to the frame, and $F_2 = \mu F_1$, acting along the rail. The torque corresponding to this couple is $F_1 \times \frac{1}{2}D = \frac{1}{2}\mu W_1 D$, and hence follows the fundamental relation, $\frac{1}{2}T = \frac{1}{2}\mu F_1 D = \frac{1}{2}\mu W_1 D$, or if T now represents the weight supported by the axle, F will be the tractive force exerted on the frame by the two axle-boxes to propel the vehicle, and the more convenient relation is established,

$$T = \frac{1}{2}FD = \frac{1}{2}\mu WD \tag{3}$$

If T has a greater value than this relation justifies the wheels will slip. F is called the "tractive force" at the rail. The coefficient of friction μ is a variable quantity depending upon the state of the rails, but is usually taken to be $\frac{1}{5}$. This is the fundamental equation between the forces acting, however the torque may be applied. Multiplying through by ω we obtain

$$T\omega = \frac{1}{2}F\omega D = \frac{1}{2}\mu W\omega D = RV \tag{4}$$

This is a fundamental energy equation for any form of locomotive in which there is only one driving-axle.

The couple T is necessarily accompanied by an equal and opposite couple acting on the frame, which couple endeavours to turn the frame in the opposite direction to that in which the axle rotates. The practical effect of this opposite couple is slightly to tilt the frame and thus to redistribute slightly the weights on the wheels carrying the vehicle.

If there are several driving-axes in a train, the product $T\omega$ must be estimated for each separately; then the sum of the products will be equal to RV . In equation (4) there is a fixed relation between ω, V and D given by the expression

$$\omega = 2V/D \tag{5}$$

Here D is in feet, V in feet per second and ω in radians per second.

If the speed is given in miles per hour, S say,

$$V = 1.466 S \tag{6}$$

The revolutions of the axle per second, n , are connected with the radians turned through per second by the relation

$$n = \omega/2\pi = \omega/6.38 \tag{7}$$

§ 2. *Methods of Applying Locomotive Power.*—By locomotive power is to be understood the provision of power to maintain the rates of working on the driving-axes of a train indicated by the relation (4). The most usual way of providing this power is by the combustion of coal in the fire-box of a boiler and the utilization of the steam produced in a steam-engine, both boiler and engine being carried on a frame mounted on wheels in such a way that the crank-shaft of the steam-engine becomes the driving-axle of the train. From equation (3) it is clear that the wheels of the driving-axle must be heavily loaded in order that F may have a value sufficiently great to propel the train. The maximum weight which one pair of wheels are usually allowed to carry on a first-class track is from 18 to 20 tons. If a larger

value of the tractive force is required than this provides for, namely from 4 to 5 tons, the driving-wheels are coupled to one or more pairs of heavily loaded wheels, forming a class of what are called "coupled engines" in contradistinction to the "single engine" with a single pair of loaded driving-wheels. Mechanical energy may be developed in bulk at a central station conveniently situated with regard to a coal-field or a waterfall, and after transformation by means of electric generators into electric energy it may be transmitted to the locomotive and then by means of electric motors be retransformed into mechanical energy at the axles to which the motors are applied. Every axle of an electric locomotive may thus be subjected to a torque, and the large weight which must be put on one pair of wheels in order to secure sufficient adhesion when all the driving is done from one axle may be distributed through as many pairs of wheels as desired. In fact, there need be no specially differentiated locomotive at all. Motors may be applied to every axle in the train, and their individual torques adjusted to values suitable to the weights naturally carried by the several axles. Such an arrangement would be ideally perfect from the point of view of the permanent-way engineer, because it would then be possible to distribute the whole of the load uniformly between the wheels. This perfection of distribution is practically attained in present-day practice by the multiple control system of operating an electric train, where motors are applied to a selected number of axles in the train, all of them being under the perfect control of the driver.

The fundamental difference between the two methods is that while the mechanical energy developed by a steam engine is in the first case applied directly to the driving-axle of the locomotive, in the second case it is transformed into electrical energy, transmitted over relatively long distances, and retransformed into mechanical energy on the driving-axes of the train. In the first case all the driving is done on one or at most two axles, sufficient tractive force being obtained by coupling these axles when necessary to others carrying heavy loads. In the second case every axle in the train may be made a driving-axle if desired, in which case the locomotive as a separate machine disappears. In the second case, however, there are all the losses due to transmission from the central station to the train to be considered, as well as the cost of the transmitting apparatus itself. Ultimately the question resolves itself into one of commercial practicability. For suburban traffic with a service at a few minutes' interval and short distances between the stations electric traction has proved itself to be superior in many respects to the steam locomotive, but for main line traffic and long distance runs it has not yet been demonstrated that it is commercially feasible, though it is known to be practically possible. For the methods of electric traction see TRACTION; the remainder of the present article will be devoted to the steam locomotive.

§ 3. *General Efficiency of Steam Locomotive.*—One pound of good Welsh coal properly burned in the fire-box of a locomotive yields about 15,000 British thermal units of heat at a temperature high enough to enable from 50 to 80% to flow across the boiler-heating surface to the water, the rest escaping up the chimney with the furnace gases. The steam produced in consequence of this heat transfer from the furnace gas to the water carries heat to the cylinder, where 7 to 11% is transformed into mechanical energy, the remainder passing away up the chimney with the exhaust steam. The average value of the product of these percentages, namely $0.65 \times 0.09 = 0.06$ say, may be used to investigate generally the working of a locomotive; the actual value could only be determined by experiment in any particular case. With this assumption, 0.06 is the fraction of the heat energy of the coal which is utilized in the engine cylinders as mechanical work; that is to say, of the 15,000 B.Th.U. produced by the combustion of 1 lb of coal, $15,000 \times 0.06 = 900$ only are available for tractive purposes.

Coals vary much in calorific value, some producing only 12,000 B.Th.U. per lb when burnt, whilst 15,500 is obtained from the best Welsh coals. Let E represent the pounds of coal burnt per hour in the fire-box of a locomotive, and let c be the calorific value in B.Th.U. per lb; then the mechanical energy available in foot-pounds per hour is approximately $0.06 \times 778 \times Ec$, and this expressed in horse-power units gives

$$\text{I.H.P.} = \frac{0.06 \times 778 \times Ec}{1,980,000} = 648.$$

A "perfect engine" receiving and rejecting steam at the same

temperatures as the actual engine of the locomotive, would develop about twice this power, say 1400 I.H.P. This figure represents the ideal but unattainable standard of performance. This question of the standard engine of comparison, and the engine efficiency is considered in § 15 below, and the boiler efficiency in § 11 below.

The indicated horse-power developed by a cylinder may always be ascertained from an indicator diagram and observations of the speed. Let p be the mean pressure in pounds per square inch, calculated from an indicator diagram taken from a particular cylinder when the speed of the crank-shaft is n revolutions per second. Also let l be the length of the stroke in feet and a be the area of one cylinder in square inches, then, assuming two cylinders of equal size,

$$\text{I.H.P.} = 2 \text{ plan}/550 \tag{8}$$

The I.H.P. at any instant is equal to the total rate at which energy is required to overcome the tractive resistance R. The horse-power available at the driving-axle, conveniently called the brake horse-power, is from 20 to 30% less than the indicated horse-power, and the ratio, B.H.P./I.H.P. = ϵ , is called the mechanical efficiency of the steam engine. The relation between the b.h.p. and the torque on the driving-axle is

$$550 \text{ B.H.P.} = T\omega \tag{9}$$

It is usual with steam locomotives to regard the resistance R as including the frictional resistances between the cylinders and the driving-axle, so that the rate at which energy is expended in moving the train is expressed either by the product RV, or by the value of the indicated horse-power, the relation between them being

$$550 \text{ I.H.P.} = RV \tag{10}$$

or in terms of the torque

$$550 \text{ I.H.P.} \times \epsilon = RV\epsilon = T\omega \tag{11}$$

The individual factors of the product RV may have any value consistent with equation (10) and with certain practical conditions, so that for a given value of the I.H.P. R must decrease if V increases. Thus if the maximum horse-power which a locomotive can develop is 1000, the tractive resistance R, at 60 m. per hour (= 88 ft. per second) is $R = (1000 \times 550)/88 = 6250$ lb. If, however, the speed is reduced to 15 m. per hour (= 22 ft. per second) R increases to 25,000 lb. Thus an engine working at maximum power may be used to haul a relatively light load at a high speed or a heavy load at a slow speed.

§ 4. *Analysis of Train Resistance.*—Train resistance may be analysed into the following components:—

- (1) Journal friction and friction of engine machinery.
- (2) Wind resistance.
- (3) Resistance due to gradients, represented by R_g .
- (4) Resistance due to miscellaneous causes.
- (5) Resistance due to acceleration, represented by R_a .
- (6) Resistance due to curves.

The sum of all these components of resistance is at any instant equal to the resistance represented by R. At a uniform speed on a level straight road 3, 5 and 6 are zero. The total resistance is conveniently divided into two parts: (1) the resistance due to the vehicles hauled by the engine, represented by R_v ; (2) the resistance of the engine and tender represented by R_e . In each of these two cases the resistance can of course be analysed into the six components set out in the above list.

§ 5. *Vehicle Resistance and Draw-bar Pull.*—The power of the engine is applied to the vehicles through the draw-bar, so that the draw-bar pull is a measure of the vehicle resistance. The draw-bar pull for a given load is a function of the speed of the train, and numerous experiments have been made to find the relation connecting the pull with the speed under various conditions. The usual way of experimenting is to put a dynamometer car (see DYNAMOMETER) between the engine and the train. This car is equipped with apparatus by means of which a continuous record of the draw-bar pull is obtained on a distance base; time indications are also made on the diagram from which the speed at any instant can be deduced. The pull recorded on the diagram includes the resistances due to acceleration and to the gradient on which the train is moving. It is usual to subtract these resistances from the observed pull, so as to obtain the draw-bar pull reduced to what it would be at a uniform speed on the level. This corrected pull is then divided by the weight of the vehicles hauled, in which must be included the weight of the dynamometer car, and the quotient gives the resistance per ton of load hauled at a certain uniform speed on a straight and level road. A series of experiments were made by J. A. F. Aspinall on the Lancashire & Yorkshire railway to ascertain the resistance of trains of bogie passenger carriages of different lengths at varying speeds, and the results are recorded in a paper, "Train Resistance," *Proc. Inst. C.E.* (1901), vol. 147. Aspinall's results are expressed by the formula

$$r_s = 2.5 + \frac{S^4}{50.8 + 0.0278L} \tag{12}$$

where r_s is the resistance in pounds per ton, S is the speed in miles per hour, and L is the length of the train in feet measured over the

carriage bodies. The two following expressions are given in the *Bulletin of the International Railway Congress* (vol. xii. p. 1275), by Barbier, for some experiments made on the Northern railway of France with a train of 157 tons mean weight; they are valid between 37 and 77 m. per hour:—

$$r_v = 3.58 + \frac{1.65S(1.61S + 50)}{1000} \text{ for 4-wheel coaches, (13)}$$

$$r_v = 3.58 + \frac{1.64S(1.61S + 10)}{1000} \text{ for bogie coaches. (14)}$$

The Baldwin Locomotive Company give the formulae

$$r_v = 3.36 + \frac{0.56S}{3} \text{ (15)}$$

and

$$r_v = 1.68 + 0.224S \text{ for speeds from 47 to 77 m. per hour. (16)}$$

All the above formulae refer to carriage stock. The resistance of goods wagons has not been so systematically investigated. In the paper above quoted Aspinall cites a case where the resistance of a train of empty wagons 1830 ft. long was 18.33 lb per ton at a speed of 26 m. per hour, and a train of full wagons 1045 ft. long gave only 9.12 lb per ton at a speed of 29 m. per hour. The resistance found from the above expressions includes the components 1, 2 and 4 of § 4. The resistance caused by the wind is very variable, and in extreme cases may double the resistance found from the formulae. A side wind causes excessive flange friction on the leeward side of the train, and increases the tractive resistances therefore very considerably, even though its velocity be relatively moderate. The curves corresponding to the above expressions are plotted in fig. 17, four values of L being taken for formula (12) corresponding to trains of 5, 10, 15 and 20 bogie carriages.

The resistance at starting is greater than the running resistance at moderate speeds. From Aspinall's experiments it appears to be about 17 lb per ton, and this value is plotted on the diagram.

The resistance to motion round a curve has not been so systematically studied that any definite rule can be formulated applicable to all classes of rolling stock and all radii of curves. A general result could not be obtained, even from a large number of experiments, because the resistance round curves depends upon so many variable factors. In some cases the gauge is laid a little wider than the standard, and there are varying amounts of super-elevation of the outer rail; but the most formidable factor in the production of resistance is the guard-rail, which is sometimes put in with the object of guiding the wheel which runs on the inner rail of the curve on the inside of the flange.

§ 6. *Engine Resistance.*—From experiments made on the North-Eastern railway (see a paper by W. H. Smith on "Express Locomotive Engines," *Proc. Inst. Mech. Eng.*, October 1898), it appeared that the engine resistance was about 35% of the total resistance, and in the train-resistance experiments on the Lancashire & Yorkshire railway quoted above the engine resistance was also about 35% of the total resistance, thus confirming the North-Eastern railway results. Barbier (*loc. cit.*) gives as the formula for the engine resistance

$$r_e = 8.51 + 3.24S(1.61S + 30)/1000 \text{ (17)}$$

where S is the speed in miles per hour. This formula is valid between speeds of 37 and 77 m. per hour, and was obtained in connexion with the experiments previously quoted on the Northern railway of France with an engine and tender weighing about 83 tons. Barbier's formula is plotted in fig. 17, together with a curve expressing generally the results of some early experiments on the Great Western railway carried out by Sir D. Gooch. The extension of the Barbier curve beyond the above limits in fig. 17 gives values which must be regarded as only very approximate.

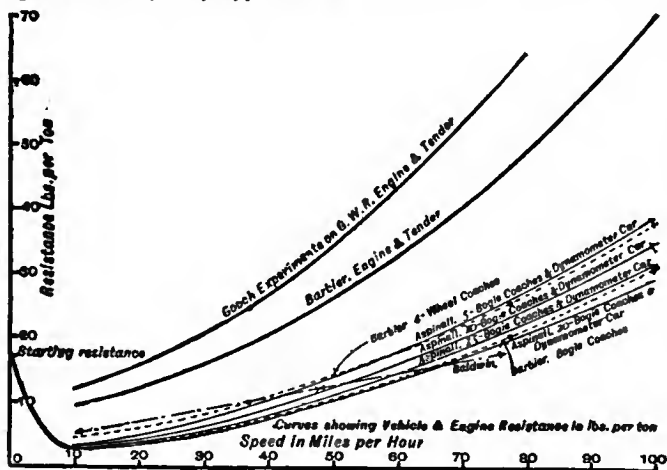

FIG. 17.

§ 7. *Rate at which work is done against the resistances given by the curves in fig. 17.*—When the weight of the engine and tender and

the weight of the vehicles are respectively given, the rate at which work must be done in the engine cylinders in order to maintain the train in motion at a stated speed can be computed by the aid of the curves plotted in fig. 17. Thus let an engine and tender weighing 80 tons haul vehicles weighing 200 tons at a uniform speed on the level of 40 m. per hour. As given by the Barbier curves in fig. 17, the engine resistance at 40 m. per hour is 20 lb per ton, and the vehicle resistance 8.5 lb per ton at the same speed. Hence

$$\begin{aligned} \text{Engine resistance, } R_e &= 80 \times 20 = 1600 \text{ lb} \\ \text{Vehicle resistance, } R_v &= 200 \times 8.5 = 1700 \text{ ,,} \\ \text{Train resistance, } R &= 3300 \text{ ,,} \end{aligned}$$

The speed, 40 m. per hour, is equal to 58.6 ft. per second; therefore the rate of working in foot-pounds per second is 3300×58.6 , from which I.H.P. = $(3300 \times 58.6) / 550 = 354$. This is the horse-power, therefore, which must be developed in the cylinders to maintain the train in motion at a uniform speed of 40 m. per hour on a level straight road with the values of the resistances assumed.

§ 8. *Rate at which work is done against a gradient.*—Gradients are measured either by stating the number of feet horizontally, G say, in which the vertical rise is 1 ft., or by the vertical rise in 100 ft. measured horizontally expressed as a percentage, or by the number of feet rising vertically in a mile. Thus a gradient of 1 in 200 is the same as a half per cent. grade or a rise of 26.4 ft. per mile. The difference between the horizontal distance and the distance measured along the rail is so small that it is negligible in all practical calculations. Hence if a train is travelling up the gradient at a speed of V ft. per second, the vertical rise per second is V/G ft. If W_1 is the weight of the train in pounds, the rate of working against the gradient expressed in horse-power units is

$$\text{H.P.} = W_1 V / 550 G. \text{ (18)}$$

Assuming the data of the previous section, and in addition that the train is required to maintain a speed of 40 m. per hour up a gradient of 1 in 300, the extra horse-power required will be

$$\text{H.P.} = \frac{280 \times 2240 \times 58.6}{300 \times 550} = 223.$$

This must be exerted in addition to the horse-power calculated in the previous section, so that the total indicated horse-power which must be developed in the cylinders is now $354 + 223 = 577$. If the train is running down a gradient this horse-power is the rate at which gravity is working on the train, so that with the data of the previous section, on the assumption that the train is running down a gradient of 1 in 300, the horse-power required to maintain the speed would be $354 - 223 = 131$.

§ 9. *Rate at which work is done against acceleration.*—If W_1 is the weight of the train in pounds and a the acceleration in feet per second, the force required to produce the acceleration is

$$f = W_1 a / g. \text{ (19)}$$

And if V is the average speed during the change of velocity implied by the uniform acceleration a , the rate at which work is done by this force is

$$fV = W_1 Va / g \text{ (20)}$$

or in horse-power units

$$\text{H.P.} = W_1 Va / 550g. \text{ (21)}$$

Assuming the data of § 7, suppose the train to change its speed from 40 to 41 m. per hour in 13 seconds. The average acceleration in feet per second is measured by the fraction

$$\frac{\text{Change of speed in feet per sec.}}{\text{Time occupied in the change}} = \frac{60.07 - 58.6}{13} = 0.113.$$

Therefore the horse-power which must be developed in the cylinders to effect this change of speed is from (21)

$$\text{H.P.} = \frac{280 \times 2240 \times 0.113 \times 59}{550 \times 32} = 237.$$

The rate of working is negative when the train is retarded; for instance, if the train had changed its speed from 41 to 40 m. per hour in 13 seconds, the rate at which work would have to be absorbed by the brake blocks would represent 237 H.P. This is lost in heat produced by the friction between the brake blocks and the wheels, though in some systems of electric driving some of the energy stored in the train may be returned to the central station during retardation. The principal condition operating in the design of locomotives intended for local services with frequent stops is the degree of acceleration required, the aim of the designer being to produce an engine which shall be able to bring the train to its journey speed in the shortest time possible. For example, suppose it is required to start a train weighing 200 tons from rest and bring it to a speed of 30 m. per hour in 30 seconds. The weight of the engine may be assumed in advance to be 80 tons. The acceleration, a , which may be supposed uniform, is 1.465. The average velocity is 15 m. per hour, which is equal to 22 ft. per second; therefore the tractive force required is, from (19),

$$(280 \times 2240 \times 1.465) / 32 = 28,720 \text{ lb,}$$

and the corresponding horse-power which must be developed in the cylinders is, from (20), $fV/550$, and this is with f and V equal to the above values, 1149. To obtain the tractive force the weight on the coupled wheels must be about five times this amount—that is,

64 tons; and to obtain the horse-power the boiler will be one of the largest that can be built to the construction gauge. After acceleration to the journey speed of 30 m. per hour the horse-power required is reduced to about one-third of that required for acceleration alone.

§ 10. *General expression for total rate of working.*—Adding the various rates of working together

$$\frac{RV}{550} = \text{I.H.P.} = \frac{(W_e r_e + W_v r_v) V}{550} \pm \frac{2240 W V}{550 G} \pm \frac{2240 W V a}{550 g} \quad (22)$$

where W_e is weight of engine and tender in tons, W_v the weight of vehicles in tons, W the weight of train in tons = $W_e + W_v$, r_e and r_v the respective engine and vehicle resistances taken from the curves fig. 17 at a speed corresponding to the average speed during the acceleration a , G the gradient, g the acceleration due to gravity, and V the velocity of the train in feet per second. In this expression it is assumed that the acceleration is uniform, and this assumption is sufficiently accurate for any practical purpose to which the above formula would be applied in the ordinary working of a locomotive. If a is variable, then the formula must be applied in a series of steps, each step corresponding to a time interval over which the acceleration may be assumed uniform.

Dividing through by V and multiplying through by 550,

$$R = W_e r_e + W_v r_v \pm \frac{2240 W}{G} \pm \frac{2240 W a}{g} \quad (23)$$

an expression giving the value of R the total tractive resistance. If the draw-bar pull is known to be R_d , then applying the same principles to the vehicle alone which above are applied to the whole train,

$$\text{total draw-bar pull} = W_e r_e \pm \frac{2240 W_e}{G} \pm \frac{2240 W_e a}{g} \quad (24)$$

This expression may be used to find r_v when the total draw-bar pull is observed as well as the speed, the changes of speed and the gradient. The speed held to correspond with the resistance must be the mean speed during the change of speed. The best way of deducing r_v is to select portions of the dynamometer record where the speed is constant. Then a disappears from all the above expressions. These expressions indicate what frequent changes in the power are required as the train pursues its journey up and down gradients, against wind resistance, journal friction and perhaps the resistance of a badly laid track; and show how both the potential energy and kinetic energy of the train are continually changing: the first from a change in vertical position due to the gradients, the second from changes in speed. These considerations also indicate what a difficult matter it is to find the exact rate of working against the resistances, because of the difficulty of securing conditions which eliminate the effect both of the gradient and of acceleration.

§ 11. *The Boiler.—Maximum Power.*—The maximum power which can be developed by a locomotive depends upon the maximum rate of fuel combustion which can be maintained per square foot of grate. This maximum rate depends upon the kind of coal used, whether small, friable, bituminous or hard, upon the thickness of the fire, and upon the correct design and setting of the blast-pipe. A limit is reached to the rate of combustion when the draught becomes strong enough to carry heavy lighted sparks through the tubes and chimney. This, besides reducing the efficiency of the furnace, introduces the danger of fire to crops and buildings near the line. The maximum rate of combustion may be as much as 150 lb of coal per square foot of grate per hour, and in exceptional cases even a greater rate than this has been maintained. It is not economical to force the boiler to work at too high a rate, because it has been practically demonstrated that the boiler efficiency decreases after a certain point, as the rate of combustion increases. A few experimental results are set forth in Table XX., from which it will be seen that with a relatively low rate of combustion, a rate which denotes very light service, namely 28 lb of coal per square foot of grate per hour, the efficiency of the boiler is 82%, which is as good a result as can be obtained with the best class of stationary boiler or marine boiler even when using economizers.

The first group consists of experiments selected from the records of a large number made on the boiler of the locomotive belonging to the Purdue University, Indiana, U.S.A.

The second group consists of experiments made on a boiler belonging to the Great Eastern Railway Company. The first one of the group was made on the boiler fixed in the locomotive yard at Stratford, and the two remaining experiments of the group were made while the engine was working a train between London and March.

The third group consists of experiments selected from the records of a series of trials made on the London & South-Western railway with an express locomotive.

§ 12. *Draught.*—One pound of coal requires about 20 lb of air for its proper combustion in the fire-box of a locomotive, though this quantity of air diminishes as the rate of combustion increases.

For instance, an engine having a grate area of 30 sq. ft. and burning 100 lb of coal per square foot of grate per hour would

TABLE XX

Kind, and calorific value of coal.	Dry coal fired per square foot of grate per hour. lb	Pounds of water evaporated per lb of coal from and at 212° F.	Boiler efficiency.	Reference.
Indiana block coal from the neighbourhood of Brazil. Estimated calorific value, 13,000 B.Th.U. per lb	49 109 181	7·83 6·59 5·71	0·58 0·49 0·42	Prof. Goss (<i>Amer. Soc. of Mech. Eng.</i> , vol. 22, 1900).
Nixon's Navigation. Calorific value, 15,560 B.Th.U. per lb	35·5 28·1 31·7	13 13·3 13·1	0·80 0·82 0·81	"Experiments on Steam Boilers," Donkin and Kennedy, (<i>Engineering</i> , London, 1897).
Calorific value, 13,903	62·5	11·15	0·77	Adams and Pettigrew (<i>Proc. Inst. C.E.</i> , vol. 125).
Calorific value, 12,840	80·9	8·86	0·66	

require that 60,000 lb of air should be drawn through the furnace per hour in order to burn the coal. This large quantity of air is forced through the furnace by means of the difference of pressure established between the external atmospheric pressure in the ash-pan and the pressure in the smoke-box.

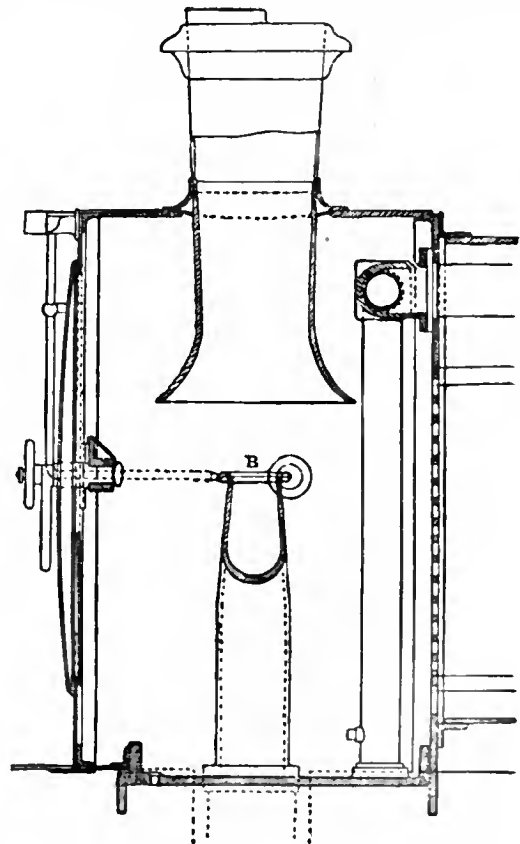

FIG. 18.—Smoke-box, L. & N.W.R. four-coupled 6 ft. 6 in. passenger engine, scale $\frac{1}{4}$.

The exhaust steam passing from the engine through the blast-pipe and the chimney produces a diminution of pressure, or

partial vacuum, in the smoke-box roughly proportional to the weight of steam discharged per unit of time. The difference of pressure between the outside air and the smoke-box gases may be measured by the difference of the water levels in the limbs of a U tube, one limb being in communication with the smoke-box, the other with the atmosphere. The difference of levels varies from 1 to as much as 10 in. in extreme cases. The draught corresponding to the smallest rate of combustion shown in Table XX. in Professor Goss's experiments, was 1.72 in. of water, and for the highest rate, namely 181, 7.48 in. of water. To get the best effect the area of the blast-nozzle must be properly proportioned to the size of the cylinders and be properly set with regard to the base of the chimney. The best proportions are found by trial in all cases.

Figs. 18 and 19 show two smoke-boxes typical of English practice. Fig. 18 is the smoke-box of the 6 ft. 6 in. six-coupled express passenger engines designed by G. Whale for the London & North-Western Railway Company in 1904, and fig. 19 shows the box of the four-coupled express passenger engine designed by J. Holden for the

English practice where a spark-arrester is put in it usually takes the form of a wire-netting dividing the smoke-box horizontally into two parts at a level just above the top row of tubes, or arranged to form a continuous connexion between the blast-pipe and the chimney.

Fig. 19 illustrates an arrangement designed by J. Holden. The heavy sparks are projected from the tubes in straight lines and are caught by the louvres L, L, L, and by them deflected downwards to the bottom of the smoke-box, where they collect in a heap in the space D round a tube which is essentially an ejector. At every blast a small quantity of steam is caught by the orifice O and led to the ejectors, one on each side, with the result that the ashes are blown out into the receptacles on each side of the engine, one of which is shown at E. The louvres l, l, l are placed to shield the central region occupied by the blast-pipe.

As the indicated horse-power of the engine increases, the weight of steam discharged increases, and the smoke-box vacuum is increased, thereby causing more air to flow through the furnace and increasing the rate of combustion. Thus the demand for more steam is automatically responded to by the boiler. It is this close automatic interdependence of engine and boiler which makes the locomotive so extraordinarily well suited for the purpose of locomotive traction.

§ 13. *The Steam Engine.*—The steam engine of a locomotive has the general characteristics of a double-acting non-condensing engine (see STEAM ENGINE). Distribution of steam is effected by a slide valve, sometimes fitted with a balancing device, and sometimes formed into a piston valve. All types of valves are with few exceptions operated by a link motion, generally of the Stephenson type, occasionally of the Allan type or the Gooch type, or with some form of radial gear as the Joy gear or the Walschaert gear, though the latter gear has characteristics which ally it with the link motions. The Stephenson link motion is used almost universally in England and America, but it has gradually been displaced by the Walschaert gear on the continent of Europe, and to some extent in England by the Joy gear. The general characteristics of the distribution effected by these gears are similar. Each of them, besides being a reversing gear, is an expansion gear both in forward and backward running. The lead is variable in the Stephenson link motion, whilst in the Walschaert and the Joy gears it is constant. Illustrations of these gears are given in the article STEAM ENGINE, and the complete distribution of steam for both forward and backward running is worked out for a typical example of each of them in *Valves and Valve Gear Mechanisms* by W. E. Dalby (London, 1906).

§ 14. *Cylinder Dimensions.*—*Adhesion.*—*Tractive Force.*—A locomotive must be designed to fulfil two conditions. First, it must be able to exert a tractive force sufficient to start the train under the worst conditions possible on the railway over which it is to operate—for instance, when the train is stopped by signal on a rising gradient where the track is curved and fitted with a guard-rail. Secondly, it must be able to maintain the train at a given speed against the total resistances of the level or up a gradient of given inclination. These conditions are to a certain extent mutually antagonistic, since an engine designed to satisfy either condition independently of the other would be a different engine from that designed to make the best compromise between them.

Equation (3), § 1 expresses the fundamental condition which must be satisfied when a locomotive is starting a train. The torque exerted on the driving-axle by the steam engine just at starting may be that due to the full boiler pressure acting in the cylinders, but usually the weight on the coupled wheels is hardly sufficient to enable advantage to be taken of the full boiler pressure, and it has to be throttled down by the regulator to prevent slipping. Sand, driven between the wheel and the rail by a steam jet, used just at starting, increases the adhesion beyond the normal value and enables a larger pressure to be exerted on the piston than would otherwise be possible. When the train is started and is moving slowly, the torque acting on the driving-axle may be estimated as that due to about 85% of the full boiler pressure acting in the cylinders. The torque

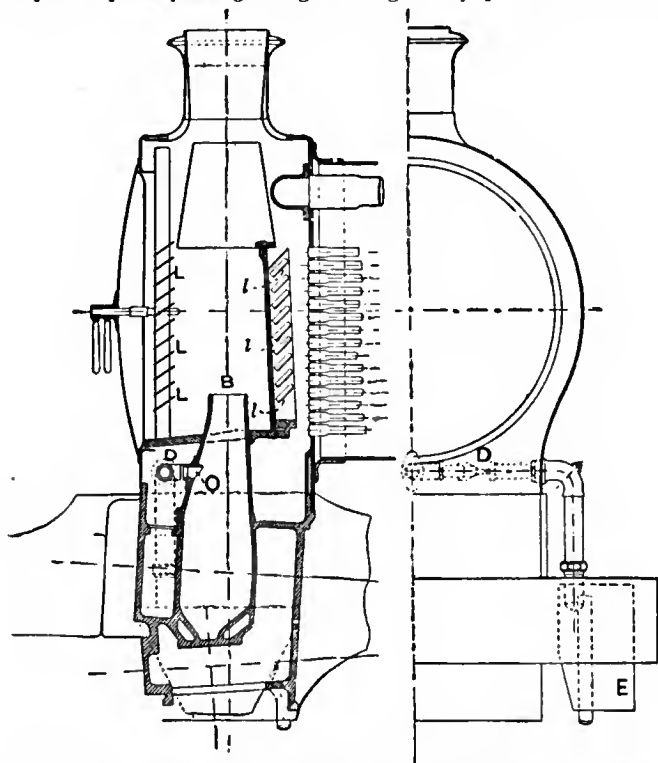

FIG. 19.—Smoke-box and Spark Arrester, G.E.R. four-coupled express engine, scale $\frac{1}{4}$.

Great Eastern Railway Company. In the case of the London & North-Western engine (fig. 18), the blast-pipe orifice B is placed at about the centre of the boiler barrel, and the exhaust steam is discharged straight into the trumpet-shaped end of the chimney, which is continued down inside the smoke-box. In fig. 19 the blast

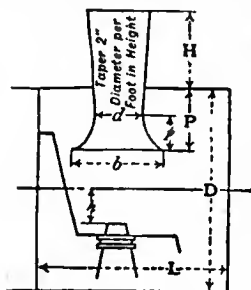

FIG. 20.—Smoke-box, American Railway Master Mechanics' Association.

orifice B is set much lower, and the steam is discharged through a frustum of a cone set in the upper part of the smoke-box into the short chimney. Fig. 20 shows the standard proportions recommended by the committee of the Railway Master Mechanics' Association on Exhaust Pipes and Steam Passages (*Proc. Amer. Railway Master Mechanics' Assoc.*, 1906). According to the Report, for the best results both H and h should be made as great as practicable, and then $d = 0.21D + 0.16h$, $b = 2d$ or $0.5D$, $P = 0.32D$, $p = 0.22D$, $L = 0.6D$ or $0.9D$, but not of intermediate values. This last relation is, however, not well established. For much detailed information regarding American smoke-box practice, reference may be made to *Locomotive Sparks*, by Professor W. F. M. Goss (London, 1902).

The arrangements for arresting sparks in American practice and on the continent of Europe are somewhat elaborate. In

due to the two cylinders is variable to a greater or less extent, depending upon the degree of expansion in the cylinders and the speed. The form of the torque curve, or crank effort curve, as it is sometimes called, is discussed in the article STEAM ENGINE, and the torque curve corresponding to actual indicator diagrams taken from an express passenger engine travelling at a speed of 65 m. per hour is given in *The Balancing of Engines* by W. E. Dalby (London, 1906).

The plotting of the torque curve is laborious, but the average torque acting, which is all that is required for the purposes of this article, can be found quite simply, thus:—Let p be the mean effective pressure acting in one cylinder, a , the area of the cylinder, and l , the stroke. Then the work done during one revolution of the crank is $2pla$ per cylinder. Assuming that the mean pressure in the other cylinder is also p , the total work done per revolution is $4pla$. If T is the mean torque, the work done on the crank-axle per revolution is $2\pi T$. Hence assuming the mechanical efficiency of the engine to be ϵ , and substituting $\frac{\pi d^2}{4}$ for the area a ,

$$2\pi T = 4pl\epsilon = pl\pi d^2\epsilon,$$

so that

$$T = \frac{1}{2}pd^2\epsilon.$$

But from § 1, $T = \frac{1}{2}DF$;

$$F = pd^2\epsilon/D \tag{25}$$

F in this expression is twice the average magnitude of the equal and opposite forces constituting the couple for one driving-wheel illustrated in fig. 16, one force of which acts to propel the train whilst the other is the value of the tangential frictional resistance between the wheel and the rail. This force F must not exceed the value μW or slipping will take place. Hence, if p is the maximum value of the mean effective pressure corresponding to about 85% of the boiler pressure,

$$\mu W = pd^2\epsilon/D \tag{26}$$

is an expression giving a relation between the total weight on the coupled wheels, their diameters and the size of the cylinder. The magnitude of F when p and ϵ are put each equal to unity, is usually called the tractive force of the locomotive per pound of mean effective pressure in the cylinders. If p is the mean pressure at any speed the total tractive force which the engine is exerting is given by equation (25) above. The value of ϵ is variable, but is between .7 and .8, and for approximate calculations may be taken equal to unity. In the following examples the value will be assumed unity.

These relations may be illustrated by an example. Let an engine have two cylinders each 19 in. diameter and 26 in. stroke. Let the boiler pressure be 175 lb per square inch. Taking 85% of this, the maximum mean effective pressure would be 149 lb per square inch. Further, let the diameter of the driving-wheels be 6 ft. 3 in. Then the tractive force is, from (25),

$$(149 \times 19^2 \times 2 \cdot 166) / 6 \cdot 25 = 18,600 \text{ lb} = 8 \cdot 3 \text{ tons.}$$

Assuming that the frictional resistance at the rails is given by $\frac{1}{2}$ the weight on the wheels, the total weight on the driving-wheels necessary to secure sufficient adhesion to prevent slipping must be at least $8 \cdot 3 \times 5 = 41 \cdot 5$ tons. This would be distributed between three coupled axles giving an average of 1.38 tons per axle, though the distribution might not in practice be uniform, a larger proportion of the weight falling on the driving-axle. If the starting resistance of the whole train be estimated at 16 lb per ton, this engine would be able to start 1.163 tons on the level, or about 400 tons on a gradient of 1 in 75, both these figures including the weight of the engine and tender, which would be about 100 tons.

The engine can only exert this large tractive force so long as the mean pressure is maintained at 149 lb per square inch. This high mean pressure cannot be maintained for long, because as the speed increases the demand for steam per unit of time increases, so that cut-off must take place earlier and earlier in the stroke, the limiting steady speed being attained when the rate at which steam is supplied to the cylinders is adjusted by the cut-off to be equal to the maximum rate at which the boiler can produce steam, which depends upon the maximum rate at which coal can be burnt per square foot of grate. If C is the number of pounds of coal burnt per square foot of grate per hour, the calorific value of which is c B.Th.U. per pound, the maximum indicated horse-power is given by the expression

$$\text{I.H.P. maximum} = \frac{cCA \times 778}{1980000} \times \eta,$$

where A is the area of the grate in square feet, and η is the combined efficiency of the engine and boiler. With the data of the previous example, and assuming in addition that the grate area is 24 sq. ft., that the rate of combustion is 150 lb of coal per square foot of grate per hour, that the calorific value is 14,000, and finally that $\eta = 0 \cdot 06$, the maximum indicated horse-power which the engine might be expected to develop would be $0 \cdot 06 \times 150 \times 14000 \times 24 \times 778 / 1980000 = 1190$, corresponding to a mean effective pressure in the cylinders of 59.5 lb per square inch.

Assuming that the train is required to run at a speed of 60 m. per hour, that is 88 ft. per second, the total resistance R , which the engine can overcome at this speed, is by equation (10)

$$R = (1190 \times 550) / 88 = 7,400 \text{ lb.}$$

Thus although at a slow speed the engine can exert a tractive force of 18,600 lb, at 60 m. per hour, the tractive force falls to 7,400 lb, and this cannot be increased except by increasing the rate of combustion (neglecting any small changes due to a change in the efficiency η). Knowing the magnitude of R , the draw-bar pull, and hence the weight of vehicle the engine can haul at this speed, can be estimated if the resistances are known. Using the curves of fig. 17 it will be found that at 60 m. per hour the resistance of the engine and tender is 33 lb per ton, and the resistance of a train of bogie coaches about 14 lb per ton. Hence if W is the weight of the vehicles in tons, and the weight of the engine and tender be taken at 100 tons, the value of W can be found from the equation $14W + 3300 = 7440$, from which $W = 296$ tons. This is the load which the engine would take in ordinary weather. With exceptionally bad weather the load would have to be reduced or two engines would have to be employed, or an exceptionally high rate of combustion would have to be maintained in the fire-box.

It will be seen at once that with a tractive force of 7,400 lb a weight of 37,000 lb (= 16.5 tons) would be enough to secure sufficient adhesion, and this could be easily carried on one axle. Hence for a level road the above load could be hauled at 60 m. per hour with a "single" engine. When the road leads the train up an incline, however, the tractive force must be increased, so that the need for coupled wheels soon arises if the road is at all a heavy one.

§15. *Engine Efficiency. Combined Engine and Boiler Efficiency.*—The combined engine and boiler efficiency has hitherto been taken to be 0.06; actual values of the boiler efficiencies are given in Table XX. Engine efficiency depends upon many variable factors, such as the cut-off, the piston speed, the initial temperature of the steam, the final temperature of the steam, the quality of the steam, the sizes of the steam-pipes, ports and passages, the arrangement of the cylinders and its effect on condensation, the mechanical perfection of the steam-distributing gear, the tightness of the piston, &c. A few values of the thermal efficiency obtained from experiments are given in Table XXI. in the second column, the first column being added to give some idea of the rate at which the engine was working when the data from which the efficiency has been deduced were observed. The corresponding boiler efficiencies are given in the third column of the table, when they are known, and the combined efficiencies in the fourth column. The figures in this column indicate that 0.06 is a good average value to work with.

TABLE XXI

	Indicated horse-power.	Engine Efficiency.	Boiler Efficiency.	Combined Efficiency.	Boiler Pressure lb per sq. in.	
The numbers in this column refer to fig. 22.	128	0.073			Mean about 128 but throttled.	Deduced from data given by Professor Goss (<i>Trans. Am. Soc. Mech. Eng.</i> vol. 14).
	205	0.075				
	222	0.080				
	399	0.088				
1	mean 129	0.057	0.815	0.047	mean about 120	Deduced from Kennedy and Donkin's trials (<i>Engineering</i> , London, 1887).
2	490	0.098	0.775	0.077	167	Deduced from Adams and Pettigrew's trials (<i>Proc. Inst. C.E.</i> vol. 125).
3	582	0.11	0.665	0.073	169	
4	520	0.084	0.52	0.044	140	Deduced from Smith's experiments (<i>Proc. Inst. Mech. Eng.</i> October 1898).
5	692	0.083	0.65	0.054	175	
6	558	0.074	0.69	0.051	175	
7	603	0.086	0.63	0.054	175	
8	570	0.081	0.64	0.052	160	

It is instructive to inquire into the limiting efficiency of an engine consistent with the conditions under which it is working, because in no case can the efficiency of a steam-engine exceed a certain value which depends upon the temperatures at which

it receives and rejects heat. Thus a standard of comparison for every individual engine may be obtained with which to compare its actual performance. The standard of comparison generally adopted for this purpose is obtained by calculating the efficiency of an engine working according to the Rankine cycle. That is to say, expansion is adiabatic and is continued down to the back pressure which in a non-condensing engine is 14.7 lb per square inch, since any back pressure above this amount is an imperfection which belongs to the actual engine. The back pressure is supposed to be uniform, and there is no compression.

Fig. 21 shows the pressure-volume diagram of the Rankine cycle for one pound of steam where the initial pressure is 175 lb per square inch by the gauge, equivalent to 190 lb per square inch absolute. In no case could an engine receiving steam at the temperature corresponding to this pressure and rejecting heat at 212° F. convert more heat into work than is

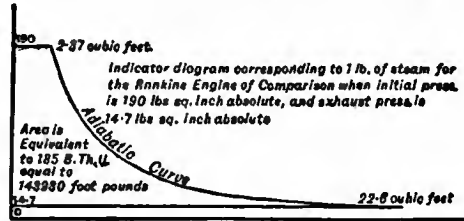

FIG. 21.

represented by the area of this diagram. The area of the diagram may be measured, but it is usually more convenient to calculate the number of B.Th.U. which the area represents from the following formula, which is expressed in terms of the absolute temperature T_1 of the steam at the steam-pipe, and the temperature $T_2 = 461^\circ + 212^\circ = 673^\circ$ absolute corresponding to the back pressure:—

$$\text{Maximum available work per pound of steam} \left. \begin{array}{l} \\ \end{array} \right\} = U = (T_1 - T_2) \left(1 + \frac{L_1}{T_1} \right) - T_2 \log_e \frac{T_1}{T_2}$$

With the initial pressure of 190 lb per square inch absolute it will be found from a steam table that $T_1 = 838^\circ$ absolute. Using this and the temperature 673° in the expression, it will be found that $U = 185$ B.Th.U. per pound of steam. If h_2 is the water heat at the lower temperature, h_1 the water heat at the higher temperature, and L_1 the latent heat at the higher temperature, the heat supply per pound of steam is equal to $h_1 - h_2 + L_1$, which, from the steam tables, with the values of the temperatures given, is equal to 1013 B.Th.U. per pound. The thermal efficiency is therefore

$$185/1013 = 0.183.$$

That is to say, a perfect engine working between the limits of temperature assigned would convert only 18% of the total heat supply into work. This would be an ideal performance for an engine receiving steam at 190 lb initial pressure absolute, and rejecting steam at the back pressure assumed above, and could never be attained in practice. When the initial pressure is 100 lb per square inch by the gauge the thermal efficiency drops to about nearly 15% with the same back pressure. The way the thermal efficiency of the ideal engine increases with the pressure is exhibited in fig. 22 by the curve AB. The curve was drawn by calculating the thermal efficiency from the above expression for various values of the initial temperature, keeping the final temperature constant at 673° , and then plotting these efficiencies against the corresponding values of the gauge pressures.

The actual thermal efficiencies observed in some of the cases cited in Table XXI. are plotted on the diagram, the reference numbers on which refer to the first column in the table. Thus the

the pressure in the steam-pipe being 167 lb per square inch. From the diagram it will be seen that the corresponding efficiency of the ideal engine is about 0.18. The efficiency ratio is therefore $0.11/0.18 = 0.61$. That is to say, the engine actually utilized 61% of the energy which it was possible to utilize by means of a perfect engine working with the same initial pressure against a back pressure equal to the atmosphere. Lines representing efficiency ratios of 0.6, 0.5 and 0.4 are plotted on the diagram, so that the efficiency ratios corresponding to the various experiments plotted may be readily read off. The initial temperature of the standard engine of comparison must be the temperature of the steam taken in the steam-pipe. For further information regarding the standard engine of comparison see the article STEAM ENGINE and also the "Report of the Committee on the Thermal Efficiency of Steam Engines," *Proc. Inst. C.E.* (1898).

§ 16. *Piston Speed.*—The expression for the indicated horse-power may be written

$$I.H.P. = p av / 550 \tag{27}$$

where v is the average piston speed in feet per second. For a stated value of the boiler pressure and the cut-off the mean pressure p is a function of the piston speed v . For the few cases where data are available—data, however, belonging to engines representing standard practice in their construction and in the design of cylinders and steam ports and passages—the law connecting p and v is approximately linear and of the form

$$p = c - bv \tag{28}$$

where b and c are constants. (See W. E. Dalby, "The Economical Working of Locomotives," *Proc. Inst. C.E.*, 1905-6, vol. 164.) Substituting this value of p in (27)

$$I.H.P. = \frac{(c - bv) av}{550} \tag{29}$$

the form of which indicates that there is a certain piston speed for which the I.H.P. is a maximum. In a particular case where the boiler pressure was maintained constant at 130 lb per square inch, and the cut-off was approximately 20% of the stroke, the values $c = 55$ and $b = 0.031$ were deduced, from which it will be found that the value of the piston speed corresponding to the maximum horse-power is 887 ft. per minute. The data from which this result is deduced will be found in Professor Goss's paper quoted above in Table XXI. The point is further illustrated by some curves published in the *American Engineer* (June 1901) by G. R. Henderson recording the tests of a freight locomotive made on the Chicago & North-Western railway. Any modification of the design which will reduce the resistance to the flow of steam through the steam passages at high speeds will increase the piston speed for which the indicated horse-power is a maximum.

§ 17. *Compound Locomotives.*—The thermal efficiency of a steam-engine is in general increased by carrying out the expansion of the steam in two, three or even more stages in separate cylinders, notwithstanding the inevitable drop of pressure which must occur when the steam is transferred from one cylinder to the other during the process of expansion. Compound working permits of a greater range of expansion than is possible with a simple engine, and incidentally there is less range of pressure per cylinder, so that the pressures and temperatures per cylinder have not such a wide range of variation. In compound working the combined volumes of the low-pressure cylinders is a measure of the power of the engine, since this represents the final volume of the steam used per stroke. The volume of the high-pressure cylinder may be varied within wide limits for the same low-pressure volume; the proportions adopted should, however, be such that there is an absence of excessive drop between them as the steam is transferred from one to the other. Compound locomotives have been built by various designers, but opinion is still uncertain whether any commercial economy is obtained by their use. The varying load against which a locomotive works, and the fact that a locomotive is non-condensing, are factors which reduce the margin of possible economy within narrow limits. Coal-saving can be shown to the extent of about 14% in some cases, but the saving depends upon the kind of service on which the engine is employed. The first true compound locomotive was constructed in 1876 from designs by A. M. Mallet, at the Creusot works in Bayonne. The first true compound locomotive in England was constructed at Crewe works in 1878 by F. W. Webb. It was of the same type as Mallet's engine, and was made by simply bushing one cylinder of an ordinary two-cylinder simple engine, the bushed cylinder being the high-pressure and the other cylinder the low-pressure cylinder. Webb evolved the type of three-cylinder compound with which his name is associated in 1882.

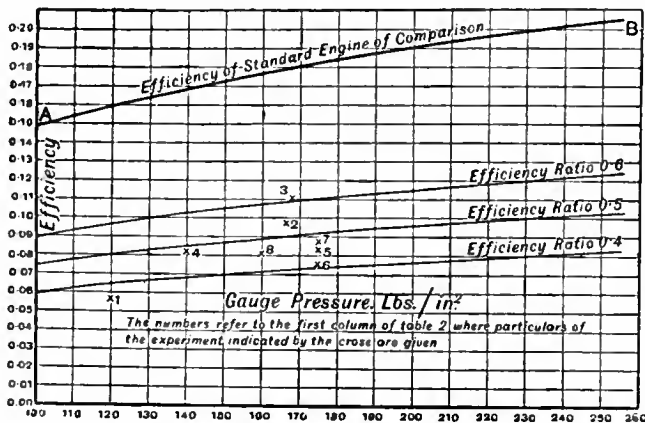

FIG. 22.—Engine Efficiency Curves.

cross marked 3 in fig. 22 represents the thermal efficiency actually obtained in one of Adams and Pettigrew's experiments, namely, 0.11,

There were two high-pressure cylinders placed outside the frames and driving on a trailing wheel, and one low-pressure cylinder placed between the frames and driving on a wheel placed in front of the driving-wheel belonging to the high-pressure cylinders. The steam connexions were such that the two high-pressure cylinders were placed in parallel, both exhausting into the one low-pressure cylinder. The first engines of this class were provided with high-pressure cylinders, 11 in. diameter and 24 in. stroke, a low-pressure cylinder 26 in. diameter, 24 in. stroke, and driving-wheels 6 ft. 6 in. diameter; but subsequently these dimensions were varied. There were no coupling rods. A complete account of Webb's engines will be found in a paper, "The Compound Principle applied to Locomotives," by E. Worthington, *Proc. Inst. C.E.*, 1889, vol. xvi. Locomotives have to start with the full load on the engine, consequently an outstanding feature of every compound locomotive is the apparatus or mechanism added to enable the engine to start readily. Generally steam from the boiler is admitted direct to the low-pressure cylinder through a reducing valve, and valves and devices are used to prevent the steam so admitted acting as a back pressure on the high-pressure cylinder. In the Webb compound the driver opened communication from the high-pressure exhaust pipe to the blast-pipe, and at the same time opened a valve giving a supply of steam from the boiler direct to the low-pressure valve chest. T. W. Worsdell developed the design of the two-cylinder compound in England and built several, first for the Great Eastern railway and subsequently for the North-Eastern railway. The engines were built on the Worsdell and Von Borries plan, and were fitted with an ingenious starting-valve of an automatic character to overcome the difficulties of starting. Several compounds of a type introduced by W. M. Smith on the North-Eastern railway in 1898 have been built by the Midland railway. In these there are two low-pressure cylinders placed outside the frame, and one high-pressure cylinder placed between the frames. All cylinders drive on one crank-axle with three cranks at 120° . The driving-wheels are coupled to a pair of trailing wheels. A controlling valve enables the supply of steam to the low-pressure cylinders to be supplemented by boiler steam at a reduced pressure. For a description and illustrations of the details of the starting devices used in the Webb, Worsdell and Smith compounds, see an article, "The Development of the Compound Locomotive in England," by W. E. Dalby in the *Engineering Magazine* for September and October 1904. A famous type of compound locomotive developed on the continent of Europe is the four-cylinder De Glehn, some of which have been tried on the Great Western railway. There are two high-pressure cylinders placed outside the frame, and two low-pressure cylinders placed inside the frames. The low-pressure cylinders drive on the leading crank-axle with cranks at right angles, the high-pressure cylinders driving on the trailing wheels. The wheels are coupled, but the feature of the engine is that the coupling-rods act merely to keep the high-pressure and low-pressure engines in phase with one another, very little demand being made upon them to transmit force except when one of the wheels begins to slip. In this arrangement the whole of the adhesive weight of the engine is used in the best possible manner, and the driving of the train is practically equally divided between two axles. The engine can be worked as a four-cylinder simple at the will of the driver. S. M. Vauclain introduced a successful type of four-cylinder compound in America in 1889. A high- and low-pressure cylinder are cast together, and the piston-rods belonging to them are both coupled to one cross-head which is connected to the driving-wheels, these again being coupled to other wheels in the usual way. The distribution of steam to both cylinders is effected by one piston-valve operated by a link motion, so that there is considerable mechanical simplicity in the arrangement. Later Vauclain introduced the "balanced compound." In this engine the two piston-rods of one side are not coupled to a common cross-head, but drive on separate

cranks at an angle of 180° , the pair of 180° cranks on each side being placed at right angles.

§18. *The Balancing of Locomotives.*—The unbalanced masses of a locomotive may be divided into two parts, namely, masses which revolve, as the crank-pins, the crank-checks, the coupling-rods, &c.; and masses which reciprocate, made up of the piston, piston-rod, cross-head and a certain proportion of the connecting-rod. The revolving masses are truly balanced by balance weights placed between the spokes of the wheels, or sometimes by prolonging the crank-webs and forming the prolongation into balance weights. It is also the custom to balance a proportion of the reciprocating masses by balance weights placed between the spokes of the wheels, and the actual balance weight seen in a driving-wheel is the resultant of the separate weights required for the balancing of the revolving parts and the reciprocating parts. The component of a balance weight which is necessary to balance the reciprocating masses introduces a vertical unbalanced force which appears as a variation of pressure between the wheel and the rail, technically called the hammer-blow, the magnitude of which increases as the square of the speed of the train. In consequence of this action the compromise is usually followed of balancing only $\frac{2}{3}$ of the reciprocating masses, thus keeping the hammer-blow within proper limits, and allowing $\frac{1}{3}$ of the reciprocating masses to be unbalanced in the horizontal direction. It is not possible to do anything better with two-cylinder locomotives unless bob-weights be added, but with four-cylinder four-crank engines complete balance is possible both in the vertical and in the horizontal directions. When the four cranks are placed with two pairs at 180° , the pairs being at 90° , the forces are balanced without the introduction of a hammer-blow, but there remain large unbalanced couples, which if balanced by means of revolving weights in the wheels again reintroduce the hammer-blow, and if left unbalanced tend to make the engine oscillate in a horizontal plane at high speed. The principles by means of which the magnitude and position of balance weights are worked out are given in the article *MECHANICS (Applied Mechanics)*, and the whole subject of locomotive balancing is exhaustively treated with numerous numerical examples in *The Balancing of Engines* by W. E. Dalby, London, 1906.

§19. *Classification.*—Locomotives may be classified primarily into "tender engines" and "tank engines," the water and fuel in the latter being carried on the engine proper, while in the former they are carried in a separate vehicle. A tender is generally mounted on six wheels, or in some cases on two bogies, and carries a larger supply of water and fuel than can be carried by tanks and the bunker of a tank engine. A tender, however, is so much dead-weight to be hauled, whilst the weight of the water and fuel in a tank engine contributes largely to the production of adhesion. A classification may also be made, according to the work for which engines are designed, into passenger engines, goods engines, and shunting or switching engines. A convenient way of describing any type of engine is by means of numerals indicating the number of wheels—(1) in the group of wheels supporting the leading or chimney end, (2) in the group of coupled wheels, and (3) in the group supporting the trailing end of the engine. In the case where either the leading or trailing group of small wheels is absent the numeral 0 must be used in the series of three numbers used in the description. Thus 4-4-2 represents a bogie engine with four-coupled wheels and one pair of trailing wheels, the well-known Atlantic type; 4-2-2 represents a bogie engine with a single pair of driving-wheels and a pair of trailing wheels; 0-4-4 represents an engine with four-coupled wheels and a trailing bogie, and 4-4-0 an engine with four-coupled wheels and a leading bogie. A general description of the chief peculiarities of various kinds of locomotives is given in the following analysis of types:—

(1) "Single-driver" type, 4-2-2 or 2-2-2. Still used by several railways in Great Britain for express passenger service, but going out of favour; it is also found in France, and less often in Germany, Italy, and elsewhere in Europe. It is generally designed as a 4-2-2 engine, but some old types are still running with only three axles,

the 2-2-2. It is adapted for light, high-speed service, and noted for its simplicity, excellent riding qualities, low cost of maintenance, and high mechanical efficiency; but having limited adhesive weight it is unsuitable for starting and accelerating heavy trains.

(2) "Four-coupled" type, 4-4-0, with leading bogie truck. For many years this was practically the only one used in America for all traffic, and it is often spoken of as the "American" type. In America it is still the standard engine for passenger traffic, but for goods service it is now employed only on branch lines. It has been extensively introduced, both in Great Britain and the continent of Europe, for passenger traffic, and is now the most numerous and popular class. It is a safe, steady-running and trustworthy engine, with excellent distribution of weight, and it is susceptible of a wide range of adaptability in power requirements.

(3) "Four-coupled" three-axle type, 2-4-0. Used to some extent in France and Germany and considerably in England for passenger traffic of moderate weight. Engines of this class, with 78-inch driving wheels and the leading axle fitted with Webb's radial axle-box, for many years did excellent work on the London & North-Western railway. The famous engine "Charles Dickens" was one of this class. Built in 1882, it had by the 12th of September 1891 performed the feat of running a million miles in 9 years 219 days, and it completed two million miles on the 5th of August 1902, having by that date run 5312 trips with express trains between London and Manchester.

(4) "Four-coupled" three-axle type, with trailing axle, 0-4-2. Used on several English lines for fast passenger traffic, and also on many European railways. The advantages claimed for it are: short coupling-rods, large and unlimited fire-box carried by a trailing axle, compactness, and great power for a given weight. Its critics, however, accuse it of lack of stability, and assert that the use of large leading wheels as drivers results in rigidity and produces destructive strains on the machinery and permanent way.

(5) "Four-coupled" type, with a leading bogie truck and a trailing axle, 4-4-2. It is used to a limited extent both in England and on the continent of Europe, and is rapidly increasing in favour in the United States, where it originated and is known as the "Atlantic" type. It has many advantages for heavy high-speed service, namely, large and well-proportioned boiler, practically unlimited grate area, fire-box of favourable proportions for firing, fairly low centre of gravity, short coupling-rods, and, finally, a combination of the safe and smooth riding qualities of the four-coupled bogie type, with great steaming capacity and moderate axle loads. Occasionally a somewhat similar type is designed with the bogie under the fire-box and a single leading axle forward under the smoke-box—an arrangement in favour for suburban tank engines. In still rarer cases both a leading and a trailing bogie have been fitted.

(6) "Six-coupled" with bogie, or "Ten-wheel" type, 4-6-0. A powerful engine for heavy passenger and fast goods service. It is used to a limited extent both in Great Britain and on the continent of Europe, but is much more common in America. The design combines ample boiler capacity with large adhesive weight and moderate axle loads, but except on heavy gradients or for unusually large trains requiring engines of great adhesion, passenger traffic can be more efficiently and economically handled by four-coupled locomotives of the eight-wheel or Atlantic types.

(7) "Six-coupled" total-adhesion type (all the weight carried on the drivers), 0-6-0. This is the standard goods engine of Great Britain and the continent of Europe. In America the type is used only for shunting. It is a simple design of moderate boiler power.

(8) "Six-coupled" type, with a leading axle, 2-6-0. This is of American origin, and is there known as the "Mogul." It is used largely in America for goods traffic. In Europe it is in considerable favour for goods and passenger traffic on heavy gradients. The type is, however, less in favour than either the ten-wheel or the eight-coupled "Consolidation" for freight traffic.

(9) "Eight-coupled" total-adhesion type, 0-8-0; now found on a good many English railways, and common on the continent of Europe for heavy slow goods traffic. In America it is comparatively infrequent, as total-adhesion types are not in favour.

(10) "Eight-coupled" type, with a leading axle, 2-8-0. This originated in America, where it is termed the "Consolidation." In the United States it is the standard heavy slow-speed freight engine, and has been built of enormous size and weight. The type has been introduced in Europe, especially in Germany, where the advantages of a partial-adhesion type in increased stability and a larger boiler are becoming appreciated. Occasionally the American eight-coupled type has a bogie instead of a single leading axle (4-8-0), and is then termed a "Twelve-wheeler," or "Mastodon."

(11) "Ten-coupled" type, with a leading axle, 2-10-0. This originated in America, where it is known as the "Decapod." It is used to a limited extent for mountain-grade goods traffic, and has the advantage over the "Consolidation" or eight-coupled type of lighter axle loads for a given tractive capacity.

In addition to the foregoing list, various special locomotive types have been developed for suburban service, where high rates of acceleration and frequent stops are required. These are generally tank engines, carrying their fuel and water on the engine proper.

Their boilers are of relatively large proportions for the train weight and average speed, and the driving wheels of small diameter, a large proportion of their total weight being "adhesive." Other special types are in limited use for "rack-railways," and operate either by engagement of gearing on the locomotive into a rack between the track rails, or by a combination of this and rail adhesion.

§ 20. *Current Developments.*—The demand of the present day is for engines of larger power both for passenger and goods service, and the problem is to design such engines within the limitations fixed by the 4 ft. 8½ in. gauge and the dimensions of the existing tunnels, arches, and other permanent works. The American engineer is more fortunately situated than his English brother with regard to the possibility of a solution, as will be seen from the comparative diagrams of construction gauges, figs. 23, 24, 25, 26. Fig. 23 shows the construction

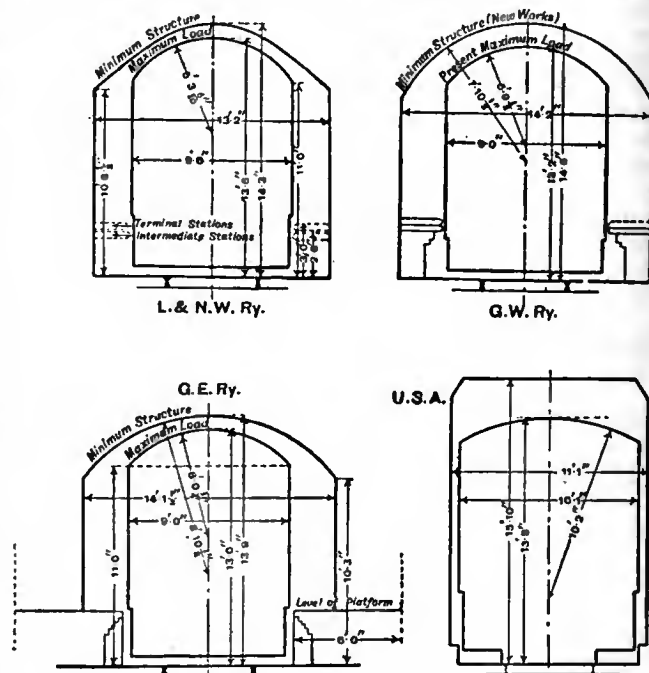

FIGS. 23-26.

gauge for the London & North-Western railway, fig. 24 that for the Great Western¹ railway, fig. 25 that for the Great Eastern railway, whilst fig. 26 gives a general idea of the American gauge in a particular case, generally typical, however, of the American limits. In consequence of this increasing demand for power, higher boiler pressures are being used, in some cases 225 lb per sq. in. for a simple two-cylinder engine, and cylinder volume is slightly increased with the necessary accompaniment of heavier loads on the coupled wheels to give the necessary adhesion. Both load and speed have increased so much in connexion with passenger trains that it is necessary to divide the weight required for adhesion between three-coupled axles, and the type of engine gradually coming into use in England for heavy express traffic is a six-coupled engine with a leading bogie, with wheels which would have been considered small a few years ago for the speed at which the engine runs. The same remarks apply to goods engines. There is a general increase in cylinder power, boiler pressure and weight, and in consequence in the number of coupled axles. Not only are the load and speed increasing, but the distances run without a stop are increasing also, and to avoid increasing the size of the tenders, water-troughs, first instituted by J. Ramsbottom on the London & North-Western railway in 1859, have been laid in the tracks of the leading main lines of Great Britain. For local services where stoppages are frequent the demand is for engines capable of quickly

¹ At the beginning of 1908 the Great Western's loading gauge on its main lines was widened to 9 ft. 8 in. from a height of 5 ft. above rail level.

TABLE XXII.—COMPARATIVE DATA OF LOCOMOTIVES

No.	OWNING RAILWAY.	Type.	Cylinders.			Diam of Driving-Wheels.	Weight(Ton = 2240 lb.).			Grate Area.	Total Heating Surface.	REMARKS.
			Position.	Diam.	Stroke.		Total of Engine.	Total on Coupled Wheels.	Total with Tender.			
1	"Rocket" (Liverpool & Manchester) } Caledonian	0-2-2	Outside	In. 8	In. 16½	In. 56½	Tons. 4'25	..	7 45	Sq. Ft. 6	Sq. Ft. 137.75	In Victoria and Albert Museum, South Kensington.
2	London & South-Western	4-4-0	Inside	19	26	78	51'70	34'65	96'7	23	1600	"Dunalastair III." (900) class. Fitted with cross-watertubes in fire-box giving 165 sq. ft. of heating surface. Belpaire fire-box. Pressure 220 lb per sq. in.
3	Midland	4-4-0	Inside	19	26	78½	58'5	38'75	104'4	28'4	1557	Fitted with superheater contributing 360 sq. ft. of heating surface to the total. Boiler pressure 200 lb per sq. in. Fired with Holden's system of liquid fuel.
4	Great Western	4-6-0	Outside	18½	30	80½	72	54'8	112	27	2000	Experiment class. Boiler pressure 185 lb per sq. in.
5	Great Eastern	4-4-0	Inside	19	26	84	50'3	33'20	85'35	21'3	1630	4-cylinder simple. Fitted with superheater contributing 260 sq. ft. of heating surface to the total. Boiler pressure 225 lb per sq. in.
6	London & North-Western	4-6-0	Inside	19½	26	75	65'75	46'75	102'75	25	1990	4-cylinder simple. Working pressure 175 lb per sq. in. Fitted with cross-tubes in fire-box.
7	Great Western	4-6-0	{ 2 inside 2 outside	14½	26	80½	75'6	55'4	115'6	27	2076	..
8	London & South-Western	4-6-0	{ 2 inside 2 outside	16	24	72	73	51'5	..	31'5	2727	..
9	Lancashire & Yorkshire	4-4-2	Inside	19	26	87	58'75	35'0	89.41	26'05	2052	..
10	Great Northern	4-4-2	Outside	19	24	78	58	31	99	26'75	1432	..
11	North-Eastern	4-4-2	{ 2 inside 2 outside	14½	26	85	73'6	39'15	116'2	29	1969	..
12	Highland	4-6-0	Outside	19½	26	69	58'85	43'85	96'05	26	2050	..
13	Midland	4-4-0	{ 2 L.-P. outside 1 H.-P. inside	21	26	84	59'8	39'1	102'7	28'4	1458	..
14	Midland	0-6-0	Inside	18½	26	63	43'8	43'8	84'05	21'1	1412	..
15	North-Eastern	0-6-0	Inside	18½	26	55	34'4	34'4	82'05	20'0	1658	..
16	Caledonian	4-6-0	Outside	19	26	60	60'4	45'9	98'4	21	2018	..
17	Lancashire & Yorkshire	0-8-0	Inside	20	26	54	53'78	53'78	84'45	26'05	2038	..
18	Great Western	4-4-2	{ 2 H.-P. outside 2 L.-P. inside	14'2 23'6	25'2	80'5	73'8	38'5	108'9	33'3	2755	..
19	Chicago & Alton	4-4-2	Outside	20	28	80	82'8	43'7	155	33'5	2696	..
20	Achison, Topeka & Sante Fé	4-4-2	{ 2 outside 2 inside	25 15	26 26	79	86'5	45'3	160	49'5	3215	..
21	Central of Georgia	4-6-2	Outside	20	28	68	84'0	50'7	150	46'8	3357	..
22	Pennsylvania	2-6-0	Outside	20	28	62	71'45	62'09	125	30'2	2431.3	..
23	Chicago, Rock Island & Pacific	2-8-0	Outside	23	30	63	88'8	79'2	147	49'7	2912	..
24	Achison, Topeka & Sante Fé	2-10-2	{ Outside Outside	19 32	32 32	57	128'4	104'5	201	58'5	4706	..
25	Great Northern, U.S.A.	2-6-6-2	{ Outside Outside	21½ 33	32 32	55	158'5	141	225	78	5658	..
26	Erie Railroad	0-8-8-0	{ Outside Outside	25 39	28 28	51	183	183	..	100	6108	..
27	Argentine Great Western	2-10-0	Outside	19½	28	51	79'5	70'8	124'17	36	2440	..
28	Belgian State	2-6-0	{ 2 outside 2 inside	17½	24	78	82'0	52'0	..	32'4	1672	..
29	Nord	4-4-2	{ 2 outside 2 inside	13.4 13'78	25'2	80'3	66'2	32'5	107'3	29'7	2368	..
30	Est	4-6-0	{ 2 H.-P. outside 2 L.-P. inside	21'65 14'56	25'2	70	62'4	48'7	..	27'6	2155	..
31	Austro-Hungarian State	2-10-0	{ 2 H.-P. inside 2 L.-P. outside	14'56 24'80	28'34	57	77'2	67'4	..	49'5	2777	..
32	Nord	6-2-2-6	{ 2 outside 2 outside	15'75 24'8	26'8	57'2	100	71	..	32'3	2660	..
33	Paris, Orleans	4-6-0	{ 2 outside 2 inside	14'17 23'62	25'19	73	72'6	53	109'5	33'37	2577	..
34	Italian State	6-4-0	{ 2 H.-P. on one side 2 L.-P. on other	14'17 23'22	23'62	75'6	69'5	42'6	106	32'29	2217	..
35	Austrian State	2-6-2	{ 2 H.-P. inside 2 L.-P. outside	14'56 24'80	28'34	71'5	68'9	42'9	107'9	43'0	2775	..
36	Prussian State	4-4-2	{ 2 H.-P. outside 2 L.-P. inside	14'17 22'04	23'62	78	61'0	29'9	107'9	29'0	2520	..

accelerating the train to the journey speed. The nature of this problem is illustrated by the numerical example in § 9. When the service is frequent enough to give a good power factor continuously, the steam locomotive cannot compete with the electric motor for the purpose of quick acceleration, because the motors applied to the axles of a train may for a short time absorb power from the central station to an extent far in excess of anything which a locomotive boiler can supply.

With regard to the working of the locomotive, J. Holden developed the use of liquid fuel on the Great Eastern railway to a point beyond the experimental stage, and used it instead of coal with the engines running the heavy express traffic of the line, its continued use depending merely upon the relative market price of coal and oil. Compound locomotives have been tried, as stated in § 17, but the tendency in England is to revert to the simple engine for all classes of work, though on the continent of Europe and in America the compound

locomotive is largely adopted, and is doing excellent work. A current development is the application of superheaters to locomotives, and the results obtained with them are exceedingly promising.

The leading dimensions of a few locomotives typical of English, American and European practice are given in Table XXII. (W. E. D.)

ROLLING STOCK

The rolling stock of a railway comprises those vehicles by means of which it effects the transportation of persons and things over its lines. It may be divided into two classes, according as it is intended for passenger or for goods traffic.

Passenger Train Stock.—In the United Kingdom, as in Europe generally, the vehicles used on passenger trains include first-class carriages, second-class carriages, third-class carriages, composite carriages containing compartments for two or more classes of passengers, dining or restaurant carriages, sleeping

carriages, mail carriages or travelling post offices, luggage brake vans, horse-boxes and carriage-trucks. Passenger carriages were originally modelled on the stage-coaches which they superseded, and they are often still referred to as "coaching stock." Early examples had bodies about 15 ft. long, 6½ ft. wide and 4½ ft. high; they weighed 3 or 4 tons, and were divided into three compartments holding six persons each, or eighteen in all.

The distinction into classes was made almost as soon as the railways began to carry passengers. Those who paid the highest fares (2½d. or 3d. a mile) were provided with covered vehicles, on the roofs of which their luggage was carried, and from the circumstance that they could book seats in advance came the term "booking office," still commonly applied to the office where tickets are issued. Those who travelled at the cheaper rates had at the beginning to be content with open carriages having little or no protection from the weather. Gradually, however, the accommodation improved, and by the middle of the 19th century second-class passengers had begun to enjoy "good glass windows and cushions on the seat," the fares they paid being about 2d. a mile. But though by an act of 1844 the railways were obliged to run at least one train a day over their lines, by which the fares did not exceed the "Parliamentary" rate of 1d. a mile, third-class passengers paying 1½d. or 1¾d. a mile had little consideration bestowed on their comfort, and were excluded from the fast trains till 1872, when the Midland railway admitted them to all its trains. Three years later that railway did away with second-class compartments and improved the third class to their level. This action had the effect, through the necessities of competition, of causing travellers in the cheaper classes to be better treated on other railways, and the condition of the third-class passenger was still further improved when Parliament, by the Cheap Trains Act of 1883, required the railways to provide "due and sufficient" train accommodation at fares not exceeding 1d. a mile. In the United Kingdom it is now possible to travel by every train, with very few exceptions, and in many cases to have the use of restaurant cars, for 1d. a mile or less, and the money obtained from third-class travellers forms by far the most important item in the revenue from passenger traffic. Since the Midland railway's action in 1875 several other English companies have abandoned second-class carriages either completely or in part, and in Scotland they are entirely unknown.

On the continent of Europe there are occasionally four classes, but though the local fares are often appreciably lower than in Great Britain, only first and second class, sometimes only first class, passengers are admitted to the fastest trains, for which in addition a considerable extra fare is often required. In Hungary and Russia a zone-tariff system is in operation, whereby the charge per mile decreases progressively with the length of the journey, the traveller paying according to the number of zones he has passed through and not simply according to the distance traversed. In the United States there is in most cases nominally only one class, denominated first class, and the average fare obtained by the railways is about 1d. per mile per passenger. But the extra charges levied for the use of parlour, sleeping and other special cars, of which some of the best trains are exclusively composed, in practice constitute a differentiation of class, besides making the real cost of travelling higher than the figures just given.

In America and other countries where distances are great and passengers have to spend several days continuously in a train sleeping and restaurant cars are almost a necessity, and accordingly are to be found on most important through trains. Such cars in the United States are largely owned, not by the railway companies over whose lines they run, but by the Pullman Car Company, which receives the extra fees paid by passengers for their use. Similarly in Europe they are often the property of the International Sleeping Car Company (Compagnie Internationale des Wagons-Lits), and the supplementary fares required from those who travel in them add materially to the cost of a journey. In

the United Kingdom, where the distances are comparatively small, sleeping and dining cars must be regarded rather as luxuries; still even so, they are to be met with very frequently. The first dining car in England was run experimentally by the Great Northern railway between London and Leeds in 1879, and now such vehicles form a common feature on express trains, being available for all classes of passengers without extra charge beyond the amount payable for food. The introduction of corridor carriages, enabling passengers to walk right through the trains, greatly increased their usefulness. The first English sleeping cars made their appearance in 1873, but they were very inferior to the vehicles now employed. In the most approved type at the present time a passage runs along one side of the car, and off it open a number of transverse compartments or berths resembling ships' cabins, mostly for one person only, and each having a lavatory of its own with cold, and sometimes hot, water laid on. A charge of 7s. 6d. or 10s., according to distance, is made for each bed, in addition to the first-class fare. In the United States the standard sleeping car has a central alley, and along the sides are two tiers of berths, arranged lengthwise with the car and screened off from the alley by curtains. To some extent cars divided into separate compartments are also in use in that country. On the continent of Europe the typical sleeping car has transverse compartments with two berths, one placed above the other.

The first railway carriages in England had four wheels with two axles, and this construction is still largely employed, especially for short-distance trains. Later, when increased length became desirable, six wheels with three axles came into use; vehicles of this kind were made about 30 ft. long, and contained four compartments for first-class passengers or five for second or third class, carrying in the latter case fifty persons. Their weight was in the neighbourhood of 10 tons. In both the four-wheeled and the six-wheeled types the axles were free to rise and fall on springs through a limited range, but not to turn with respect to the body of the carriage, though the middle axle of the six-wheeled coach was allowed a certain amount of lateral play. Thus the length of the body was limited, for to increase it involved an increase in the length of the rigid wheel base, which was incompatible with smooth and safe running on curves. (On the continent of Europe, however, six-wheeled vehicles are to be found much longer than those employed in Great Britain.) This difficulty is avoided by providing the vehicles with four axles (or six in the case of the largest and heaviest), mounted in pairs (or threes) at each end in a bogie or swivel truck, which being pivoted can move relatively to the body and adapt itself to the curvature of the line. This construction was introduced into England from America about 1874, and has since been extensively adopted, being now indeed standard for main line stock. It soon led to an increase in the length of the vehicles; thus in 1885 the Midland railway had four-wheeled bogie third-class carriages with bodies 43 ft. long, holding seventy persons in seven compartments and weighing nearly 18 tons, and six-wheeled bogie composite carriages, 54 ft. long and weighing 23 tons, which included 3 first-class and 4 third-class compartments, with a cupboard for luggage, and held 58 passengers. The next advance, introduced on the Great Western railway in 1892, was the adoption of corridor carriages having a passage along one side, off which the compartments open, and connected to each other by vestibules, so that it is possible to pass from one end of the train to the other. This arrangement involves a further increase of length and weight. For instance, four-wheeled bogie third-class corridor carriages employed on the Midland railway at the beginning of the 20th century weighed nearly 25 tons, and had bodies measuring 50 ft.; yet they held only 36 passengers, because not only had the number of compartments been reduced to six, as compared with seven in the somewhat shorter carriage of 1885, by the introduction of a lavatory at each end, but each compartment held only 6 persons, instead of 10, owing to the narrowing of its width by the corridor.

Passenger carriages.

It will be seen from these particulars—which are typical of what has happened not only on other British railways, but also on those of other countries—that much more space has to be provided and more weight hauled for each passenger than was formerly the case. Thus, on the Midland railway in 1885, each third-class passenger, supposing the carriage to have its full complement, was allowed 0.62 ft. of lineal length, and his proportion of the total weight was 5.7 cwt. Less than 20 years later the lineal length allowed each had increased to nearly 1.4 ft., and the weight to nearly 14 cwt. Passengers in sleeping cars appropriate still more space and weight; in Great Britain some of these cars, though 40 tons in weight and over 65 ft. in length, accommodate only 11 sleepers, each of whom thus occupies nearly 6 ft. of the length and requires over $3\frac{1}{2}$ tons of dead weight to be hauled.

In America the long open double-bogie passenger cars, as originally introduced by Ross Winans on the Baltimore & Ohio railway, are universally in use. They are distinguished essentially from the British type of carriage by having in the centre of the body a longitudinal passage, about 2 ft. wide, which runs their whole length, and each car having communication with those on either side of it, the conductor, and also vendors of books, papers and cigars, are enabled to pass right through the train. The cars are entered by steps at each end, and are provided with lavatories and a supply of iced water. The length is ordinarily about 50 ft., but sometimes 80 or 90 ft. The seats, holding two persons, are placed transversely on each side of the central passage, and have reversible backs, so that passengers can always sit facing the direction in which the train is travelling. Cars of this saloon type have been introduced into England for use on railways which have adopted electric traction, but owing to the narrower loading gauge of British railways it is not usually possible to seat four persons across the width of the car for its whole length, and at the ends the seats have to be placed along the sides of the vehicle. A considerable amount of standing room is then available, and those who have to occupy it have been nicknamed "strap-hangers," from the fact that they steady themselves against the motion of the train by the aid of leather straps fixed from the roof for that purpose. Cars built almost entirely of steel, in which the proportion of wood is reduced to a minimum, are used on some electric railways, in order to diminish danger from fire, and the same mode of construction is also being adopted for the rolling stock of steam railways.

End doors opening on end platforms have always been characteristic of American passenger equipment. Their use secures a continuous passage-way through the train, but is attended with some discomfort and risk when the train is in motion. The opening of the doors was apt to cause a disagreeable draught through the car in cold weather, and passengers occasionally fell from the open platform, or were blown from it, when the train was moving. To remedy these defects vestibules were introduced, to enclose the platform with a housing so arranged as to be continuous when the cars are made up into trains, and fitted with side doors for ingress and egress when the trains are standing. A second advantage of the vestibule developed in use, for it was found that the lateral swaying of the cars was diminished by the friction between the vestibule frames. The fundamental American vestibule patent, issued to H. H. Sessions of Chicago in November 1887, covered a housing in combination with a vertical metallic plate frame of the general contour of the central passage-way, which projected slightly beyond the line of the couplings and was held out by horizontal springs top and bottom, being connected with the platform housing by flexible connexions at the top and sides and by sliding plates below. A common form is illustrated in fig. 27. Subsequent improvements on the Sessions patent have resulted in a modified form of vestibule in which the housing is made the full width of the platform, though the contact plate and springs and the flexible connexions remain the same as before. The application of vestibules is practically limited to trains making long

journeys, as it is an obstruction to the free ingress and egress of passengers on local trains that make frequent stops.

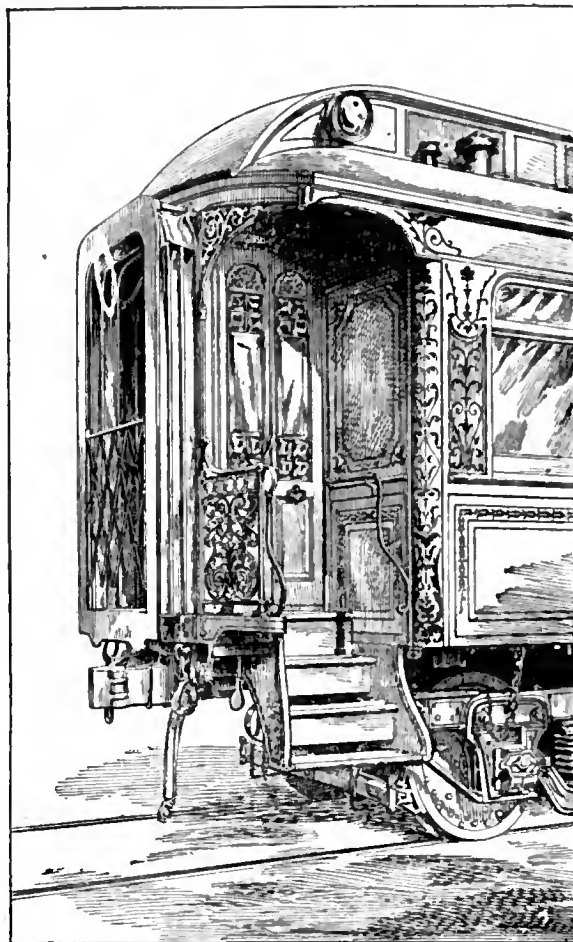

FIG. 27.—A "Vestibule"; the "lazytongs" gate is folded away when two cars are coupled together, giving free passage from end to end of the train.

In the United States the danger of the stoves that used to be employed for heating the interiors of the cars has been realized, and now the most common method is by **Heating and lighting.** steam taken from the locomotive boiler and circulated through the train in a line of piping, rendered continuous between the cars by flexible coupling-hose. The same method is finding increased favour in Great Britain, to the supersession of the old hot-water footwarmers. These in their simplest form are cans filled with water, which is heated by immersing them in a vessel containing boiling water. In some cases, however, they are filled with fused acetate of soda; this salt is solid when cold, but when the can containing it is heated by immersion in hot water it liquefies, and in the process absorbs heat which is given out again on the change of state back to solid. Such cans remain warm longer than those containing only hot water. On electric railways the trains are heated by electric heaters. As to lighting, the oil lamp has been largely displaced by gas and electricity. The former is often a rich oil-gas, stored in steel reservoirs under the coaches at a pressure of six or seven atmospheres, and passed through a reducing valve to the burners; these used to be of the ordinary fish-tail type, but inverted incandescent mantles are coming into increasing use. Gas has the disadvantage that in case of a collision its inflammability may assist any fire that may be started. Electric light is free from this drawback. The current required for it is generated by dynamos driven from the axles of the coaches. With "set" or "block" trains, that is, trains having their vehicles permanently coupled up, one dynamo may serve for the whole train, but usually a dynamo is provided for each coach, which is then an

independent unit complete in itself. It is necessary that the voltage of the current shall be constant whatever be the increase of the speed of the train, and therefore of the dynamo. In most of the systems that have been proposed this result is attained by electrical regulation; in one, however, a mechanical method is adopted, the dynamo being so hung that it allows the driving belt to slip when the speed of the axle exceeds a certain limit, the armature thus being rotated at an approximately constant speed. In all the systems accumulators are required to maintain the light when the train is at rest or is moving too slowly to generate current.

In all countries passenger trains must vary in weight according to the different services they have to perform; suburban **Weight and speed.** trains, for example, meant to hold as many passengers as possible, and travelling at low speeds, do not weigh so much as long-distance expresses, which include dining and sleeping cars, and on which, from considerations of comfort, more space must be allowed each occupant. The speed at which the journey has to be completed is obviously another important factor, though the increased power of modern locomotives permits trains to be heavier and at the same time to run as fast, and often faster, than was formerly possible, and in consequence the general tendency is towards increased weight as well as increased speed. An ordinary slow suburban train may weigh about 100 tons exclusive of the engine, and may be timed at an inclusive speed, from the beginning to the end of its journey, as low as 12 or 15 m. an hour; while usually the fastest express trains maintaining inclusive speeds of say 45 m. an hour, and made up of the heaviest and strongest rolling stock, do not much exceed 300 tons in any country, and are often less. The inclusive speed over a long journey is of course a different thing from the average running speed, on account of the time consumed in intermediate stops; the fewer the stops the more easily is the inclusive speed increased,—hence the advantage of the non-stop runs of 150 and 200 m. or more which are now performed by several railways in Great Britain, and on which average speeds of 54 or 55 m. per hour are attained between stopping-places. Over shorter distances still more rapid running is occasionally arranged, and in Great Britain, France and the United States there are instances of trains scheduled to maintain an average speed of 60 m. an hour or more between stops. Still higher speeds, up to 75 or even 80 m. an hour, are reached, and sustained for shorter or longer distances every day by express trains whose average speed between any two stopping-places is very much less. But isolated examples of high speeds do not give the traveller much information as to the train service at his disposal, for on the whole he is better off with a large number of trains all maintaining a good average of speed than with a service mostly consisting of poor trains, but leavened with one or two exceptionally fast ones. If both the number and the speed of the trains be taken into account, Great Britain is generally admitted still to remain well ahead of any other country.

Goods Trains.—The vehicles used for the transportation of goods are known as goods wagons or trucks in Great Britain, and as freight cars in America. The principal types to be found in the United Kingdom and on the continent of Europe are open wagons (the lading often protected from the weather by tarpaulin sheets), mineral wagons, covered or box wagons for cotton, grain, &c., sheep and cattle trucks, &c. The principal types of American freight cars are box cars, gondola cars, coal cars, stock cars, tank cars and refrigerator cars, with, as in other countries, various special cars for special purposes. Most of these terms explain themselves. The gondola or flat car corresponds to the European open wagons and is used to carry goods not liable to be injured by the weather; but in the United States the practice of covering the load with tarpaulins is unknown, and therefore the proportion of box cars is much greater than in Europe. The long hauls in the United States make it specially important that the cars should carry a load in both directions, and so box cars which have carried grain or merchandise one way are filled with wool,

coal, coke, ore, timber and other coarse articles for the return journey. On this account it is common to put small end doors in American box cars, through which timber and rails may be loaded.

The fundamental difference between American freight cars and the goods wagons of Europe and other lands is in carrying capacity. In Great Britain the mineral trucks can ordinarily hold from 8 to 10 tons (long tons, 2240 lb), and the goods trucks rather less, though there are wagons in use holding 12 or 15 tons, and the specifications agreed to by the railway companies associated in the Railway Clearing House permit private wagon owners (who own about 45% of the wagon stock run on the railways of the United Kingdom) to build also wagons holding 20, 30, 40 and 56 tons. On the continent of Europe the average carrying capacity is rather higher; though wagons of less than 10 tons capacity are in use, many of those originally rated at 10 tons have been rebuilt to hold 15, and the tendency is towards wagons of 15–20 tons as a standard, with others for special purposes holding 40 or 45 tons.

The majority of the wagons referred to above are comparatively short, are carried on four wheels, and are often made of wood. American cars, on the other hand, have long bodies mounted on two swivelling bogie-trucks of four wheels each, and are commonly constructed of steel. About 1875 their average capacity differed little from that of British wagons of the present day, but by 1885 it had grown to 20 or 22 short tons (2000 lb) and now it is probably at least three times that of European wagons. For years the standard freight cars have held 60,000 lb and now many carry 80,000 lb or 100,000 lb; a few coal cars have even been built to contain 200,000 lb. This high carrying capacity has worked in several ways to reduce the cost of transportation. An ordinary British 10-ton wagon often weighs about 6 tons empty, and rarely much less than 5 tons; that is, the ratio of its possible paying load to its tare weight is at the best about 2 to 1. But an American car with a capacity of 100,000 lb may weigh only 40,000 lb, and thus the ratio of its capacity to its tare weight is only about 5 to 2. Hence less dead weight has to be hauled for each ton of paying load. In addition the increased size of the American freight car has diminished the interest on the first cost and the expenses of maintenance relatively to the work done; it has diminished to some extent the amount of track and yard room required to perform a unit of work; it has diminished journal and rolling friction relatively to the tons hauled, since these elements of train resistance grow relatively less as the load per wheel rises; and finally, it has tended to reduce the labour costs as the train loads have become greater, because no more men are required to handle a heavy train than a light one.

It is sometimes argued that if these things are true for one country they must be true for another, and that in Great Britain, for example, the use of more capacious cars would bring down the cost of carriage. It may be pointed out, however, that the social and geographical conditions are different in the United Kingdom and the United States, and in each country the methods of carrying goods and passengers have developed in accordance with the requirements of those conditions. In the one country the population is dense, large towns are numerous and close to one another, the greatest distances to be travelled are short, and relatively a large part of the freight to be carried is merchandise and manufactured material consigned in small quantities. In the other country precisely the opposite conditions exist. Under the first set of conditions quickness and flexibility of service are relatively more important than under the second set. Goods therefore are collected and despatched promptly, and, to secure rapid transit, are packed in numerous wagons, each of which goes right through to its destination, with the consequence that, so far as general merchandise is concerned, the weight carried in each is a quarter or less of its capacity. But if full loads cannot be arranged for small wagons, there is obviously no economy in introducing larger ones. On the other hand, where, as in America, the great

volume of freight is raw material and crude food-stuffs, and the distances are great, a low charge per unit of transportation is more important than any consideration such as quickness of delivery; therefore full car-loads of freight are massed into enormous trains, which run unbroken for distances of perhaps 1000 m. to a seaport or distributing centre.

The weight and speed of goods trains vary enormously according to local conditions, but the following figures, which **Weight and speed.** refer to traffic on the London & North-Western railway between London and Rugby, may be taken as representative of good English practice. Coal trains, excluding the engine, weigh up to 800 or 900 tons, and travel at from 18 to 22 m. an hour; ordinary goods or merchandise trains, weighing 430 tons, travel at from 25 to 30 m. an hour; and quick merchandise trains with limited loads of 300 tons make 35 to 40 m. an hour. In the United States mineral and grain trains, running at perhaps 12 m. an hour, may weigh up to about 4000 tons, and loads of 2000 tons are common. Merchandise trains run faster and carry less. Their speed must obviously depend greatly on topographical conditions. In the great continental basin there are long lines with easy gradients and curves, while in the Allegheny and Rocky Mountains the gradients are stiff, and the curves numerous and of short radius. Such trains, therefore, range in weight from 600 to 1800 tons or even more, and the journey speeds from terminus to terminus, including stops, vary from 15 to 30 m. an hour, the rate of running rising in favourable circumstances to 40 or even 60 m. an hour.

Couplers.—The means by which vehicles are joined together into trains are of two kinds—automatic and non-automatic, the difference between them being that with the former the impact of two vehicles one on the other is sufficient to couple them without any human intervention such as is required with the latter. The common form of non-automatic coupler, used in Great Britain for goods wagons, consists of a chain and hook; the chain hangs loosely from a slot in the draw-bar, which terminates in a hook, and coupling is effected by slipping the chain of one vehicle over the hook of the next. For this operation, or its reverse, a man has to go in between the wagons, unless, as in Great Britain, he is provided with a coupling-stick—that is, a pole having a peculiarly shaped hook at one end by which the chain can be caught and thrown on or off the draw-bar hook. This coupling gear is placed centrally between a pair of buffers; formerly these were often left “dead”—that is, consisted of solid prolongations of the frame of the vehicle, but now they are made to work against springs which take up the shocks that occur when the wagons are thrown violently against one another in shunting. In British practice the chains consist of three links, and are of such a length that when fully extended there is a space of a few inches between opposing buffers; this slack facilitates the starting of a heavy train, since the engine is able to start the wagons one by one and the weight of the train is not thrown on it all at once. For passenger trains and occasionally for fast goods trains screw couplings are substituted for the simple chains. In these the central bar which connects the two end links has screw threads cut upon it, and by means of a lever can be turned so as either to shorten the coupling and bring the vehicles together till their buffers are firmly pressed together, or to lengthen it to permit the end link to be lifted off the hook.

Another form of coupler, which used to be universal in the United States, though it has now been almost entirely superseded by the automatic coupler, was the “link and pin,” which differed fundamentally from the couplers commonly used in Europe, in the fact that it was a buffer as well as a coupler, no side buffers being fitted. In it the draw-bar, connected through a spring to the frame of the car, had at its outboard end a socket into which one end of a solid link was inserted and secured by a pin. The essential change from the link and pin to the automatic coupler is in the outboard end or head of the draw-bar. The socket that received the link is replaced by a hook, shown at *A* in fig. 28, which is usually called the knuckle. This hook

swings on the pivot *B*, and has an arm which extends backwards, practically at right angles with the working face of the hook,

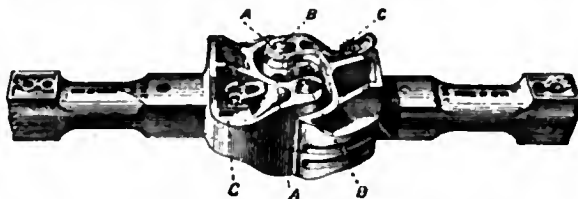

FIG. 28.—Automatic Coupling for Freight Cars (U.S.A.).

in a cavity in the head, and engages with the locking-pin *C*. This locking-pin is lifted by a suitable lever which extends to one or both sides of the car; lifting it releases the knuckle, which is then free to swing open, disconnecting the two cars. The knuckle stands open until the coupling is pushed against another coupling, when the two hooks turn on their pivots to the position shown in fig. 28, and, the locking-pin dropping into place, the couplers are made fast. This arrangement is only partly automatic, since it often happens that when two cars are brought together to couple the knuckles are closed and must be opened by hand. There are various contrivances by which this may be done by a man standing clear of the cars, but often he must go in between their ends to reach the knuckle.

This form of automatic coupler has now gained practically universal acceptance in the United States. To effect this result required many years of discussion and experiment. The Master Car Builders' Association, a great body of mechanical officers organized especially to being about improvement and uniformity in details of construction and operation, expressed its sense of the importance of “self-coupling” so far back as 1874, but no device of the kind that could be considered useful had then been invented. At that time a member of the Association referred to the disappearance of automatic couplers which had been introduced thirty or forty years before. This body pursued the subject with more or less diligence, and in 1884 laid down the principle that the automatic coupler should be one acting in a vertical plane—that is, the engaging faces should be free to move up and down within a considerable range, in order to provide for the differences in the height of cars. By the fixing of this principle the task of the inventor was considerably simplified. In 1887 a committee reported that the coupler question was the “knottiest mechanical problem that had ever been presented to the railroad,” and over 4000 attempted solutions were on record in the United States Patent Office. The committee had not found one that did not possess grave disadvantages, but concluded that the “principle of contact of the surfaces of vertical surfaces embodied in the Janney coupler afforded the best connexion for cars on curves and tangents”; and in 1887 the Association recommended the adoption of a coupler of the Janney type, which, as developed later, is shown in fig. 28. The method of constructing the working faces of this coupler is shown in fig. 29. The principle was patented, but the company owning the patent undertook to permit its free use by railway companies which were members of the Master Car Builders' Association, and thus threw open the underlying principle to competition. From that time the numerous patents have had reference merely to details. Many different couplers of the Janney type are patented and made by different firms, but the tendency is to equip new cars with one of only four or five standard makes. The adoption of automatic couplers was stimulated in some degree by laws enacted by the various states and by the United States; and the Safety Appliance Act passed by Congress in 1893 made it unlawful for railways to permit to be hauled on their lines after the 1st of January 1898 any car used for interstate commerce that was not equipped with couplers which coupled automatically by impact, and which could be uncoupled without the necessity for men going in between the ends of the cars. The limit was extended to the 1st of August 1900 by the Interstate Commerce Commission, which was given discretion in the matter.

Automatic couplers resembling the Janney are adopted in a few special cases in Great Britain and other European countries,

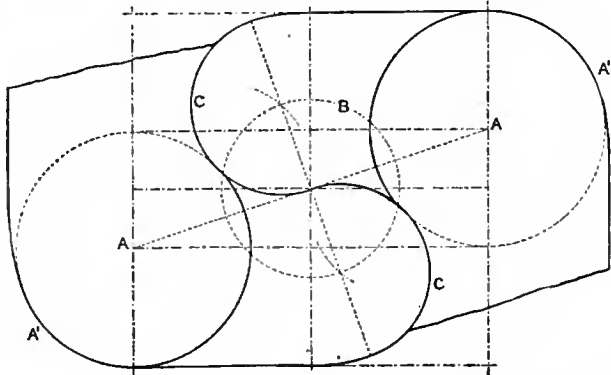

FIG. 29.—Development of the Working Faces of the Janney Coupler. The sides of the square are 6 in., and the centres AA are taken at 2 in. from the top and bottom of the square. The circles A'A', which are struck with 2-inch radius, define the first portion of the knuckle. The inner circle B has a radius of 1½ in. From its intersection with A'A' arcs are struck cutting B in two points. These intersections determine the centres of the semicircles CC which form the ends of the respective knuckles. These semicircles and the circles A'A' are joined by tangents and short arcs struck from the centre of the figure.

but the great majority of couplings remain non-automatic. It may be pointed out that the general employment of side buffers in Europe greatly complicates the problem of designing a satisfactory automatic coupling, while to do away with them and substitute the combined buffer-coupling, such as is used in the United States, would entail enormous difficulties in carrying on the traffic during the transition stage.

Brakes.—In the United States the Safety Appliance Act of 1893 also forbade the railways, after the 1st of January 1898, to run trains which did not contain a "sufficient number" of cars equipped with continuous brakes to enable the speed to be controlled from the engine. This law, however, did not serve in practice to secure so general a use of power brakes on freight trains as was thought desirable, and another act was passed in 1903 to give the Interstate Commerce Commission authority to prescribe what should be the minimum number of power-braked cars in each train. This minimum was at first fixed at 50%, but on and after the 1st of August 1906 it was raised to 75%, with the result that soon after that date practically all the rolling stock of American railways, whether passenger or freight, was provided with compressed air brakes. In the United Kingdom the Regulation of Railways Act 1889 empowered the Board of Trade to require all passenger trains, within a reasonable period, to be fitted with automatic continuous brakes, and now all the passenger stock, with a few trifling exceptions, is provided with either compressed-air or vacuum brakes (see BRAKE), and sometimes with both. But goods and mineral trains so fitted are rare, and the same is the case on the continent of Europe, where, however, such brakes are generally employed on passenger trains. (H. M. R.)

INTRA-URBAN RAILWAYS

The great concentration of population in cities during the 19th century brought into existence a class of railways to which the name of intra-urban may be applied. Such lines are primarily intended to supply quick means of passenger communication within the limits of cities, and are to be distinguished on the one hand from surface tramways, and on the other from those portions of trunk or other lines which lie within city boundaries, although the latter may incidentally do a local or intra-urban business. Intra-urban railways, as compared with ordinary railways, are characterized by shortness of length, great cost per mile, and by a traffic almost exclusively passenger, the burden of which is enormously heavy. For the purpose of connecting the greatest possible number of points of concentrated travel, the first

railways were laid round the boundaries of areas approximately circular, the theory being that the short walk from the circumference of the circle to any point within it would be no serious detention. It has been found, however, in the case of such circular or belt railways, that the time lost in traversing the circle and in walking from the circumference to the centre is so great that the gain in journey speed over a direct surface tramway or omnibus is entirely lost. Later intra-urban railways in nearly every case have been built, so far as possible, on straight lines, radiating from the business centre or point of maximum congestion of travel to the outer limits of the city; and, while not attempting to serve all the population through the agency of the line, make an effort to serve a portion in the best possible manner—that is, with direct transit.

The actual beginning of the construction of intra-urban railways was in 1853, when powers were obtained to build a line, 2½ m. long, from Edgware Road to King's Cross, in London, from which beginning the Metropolitan and Metropolitan District railways developed. These railways, which in part are operated jointly, were given a circular location, but the shortcomings of this plan soon became apparent. It was found that there was not sufficient traffic to support them as purely intra-urban lines, and they have since been extended into the outskirts of London to reach the suburban traffic.

The Metropolitan and Metropolitan District railways followed the art of railway building as it existed at the time they were laid out. Wherever possible the lines were constructed in open cutting, to ensure adequate ventilation; and where this was not possible they were built by a method suggestively named "cut and cover." A trench was first excavated to the proper depth, then the side walls and arched roof of brick were put in place, earth was filled in behind and over the arch, and the surface of the ground restored, either by paving where streets were followed, or by actually being built over with houses where the lines passed under private property. Where the depth to rail-level was too great for cut-and-cover methods, ordinary tunnelling processes were used; and where the trench was too shallow for the arched roof, heavy girders, sometimes of cast iron, bridged it between the side walls, longitudinal arches being turned between them (fig. 30).

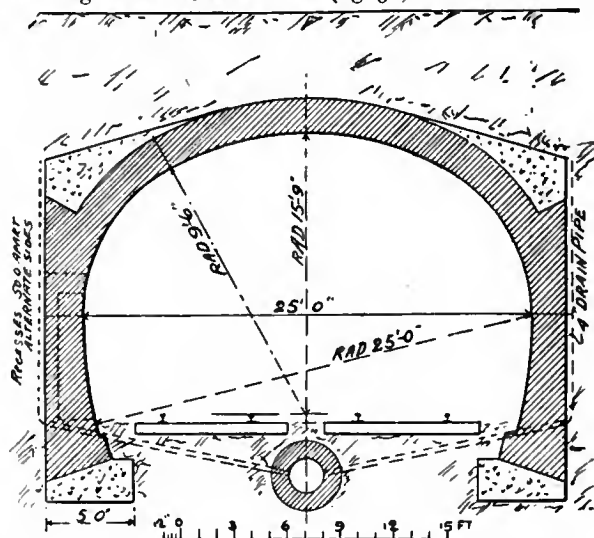

FIG. 30.—Type-Section of Arched Covered Way, Metropolitan District railway, London.

The next development in intra-urban railways was an elevated line in the city of New York. Probably the first suggestion for an elevated railway was made by Colonel Stevens, of Hoboken, New Jersey, as early as 1831, when the whole art of railway construction was in its infancy. He proposed to build an elevated railway on a single line of posts, placed along the curb-line of the street: a suggestion which embodies not only the general plan of an elevated structure, but the most striking feature of it as subsequently built—namely, a railway supported

by a single row of columns. The first actual work, however, was not begun till 1870, when the construction of an iron structure on a single row of columns was undertaken.

The superiority, so far as the convenience of passengers is concerned, of an elevated over an underground railway, when both are worked by steam locomotives, and the great economy and rapidity of construction, led to the quick development and extension of this general design. By the year 1878 there were four parallel lines in the city of New York, and constructions of the same character had already been projected in Brooklyn and Chicago and, with certain modifications of details, in Berlin. In the year 1894 an elevated railway was built in Liverpool, and in 1900 a similar railway was constructed in Boston, U.S.A., and the construction of a new one undertaken in New York. These elevated railways as a rule follow the lines of streets, and are of two general types. One (fig. 31), the earliest form, consisted of a single row of columns supporting two lines of longitudinal girders carrying the rails, the lateral stability of the structure being obtained by anchoring the feet of the columns to their foundations.

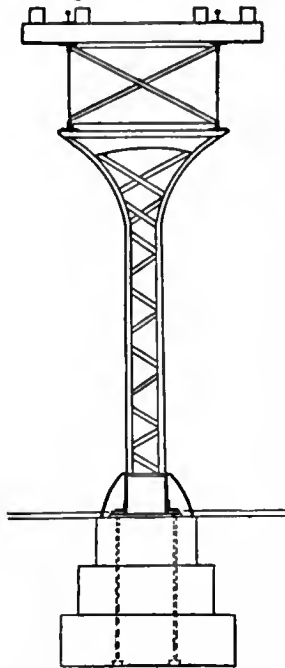

FIG. 31.—Single-Column Elevated Structure.

The other type (fig. 32) has two rows of columns connected at the top by transverse girders, which in turn carry the longitudinal girders that support the railway.

In Berlin, on the Stadtbahn—which for a part of its length traverses private property—masonry arches, or earthen embankments between retaining walls, were substituted for the metallic structure wherever possible.

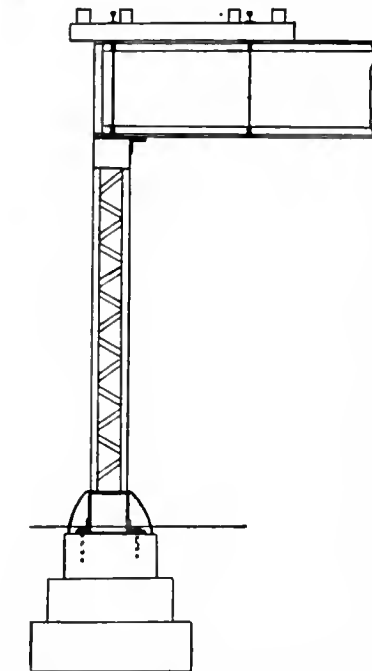

FIG. 32.—Double-Column Elevated Structure (half-section).

The next great development, marking the third step in the progress of intra-urban railway construction, took place in 1886, when J. H. Greathead (*q.v.*) began the City & South London railway, extending under the Thames from the Monument to Stockwell, a distance of 3½ m. Its promoters recognized the unsuitability of ordinary steam locomotives for underground railways, and intended to work it by means of a moving cable; but before it was completed, electric traction had developed so far as to be available for use on such lines. Electricity, therefore, and not the cable, was installed (fig. 33). In the details of construction the shield was the novelty. In principle it had been invented by Sir Marc I. Brunel for the construction of the original Thames tunnel, and it was afterwards improved by Beach, of New York, and finally developed by Greathead. (For the details of the shield and method of its operation, see TUNNEL.) By means of the shield Greathead cut a circular hole at a depth ranging from 40 to 80 ft.

below the surface, with an external diameter of 10 ft. 9 in.; this he lined with cast-iron segments bolted together, giving a

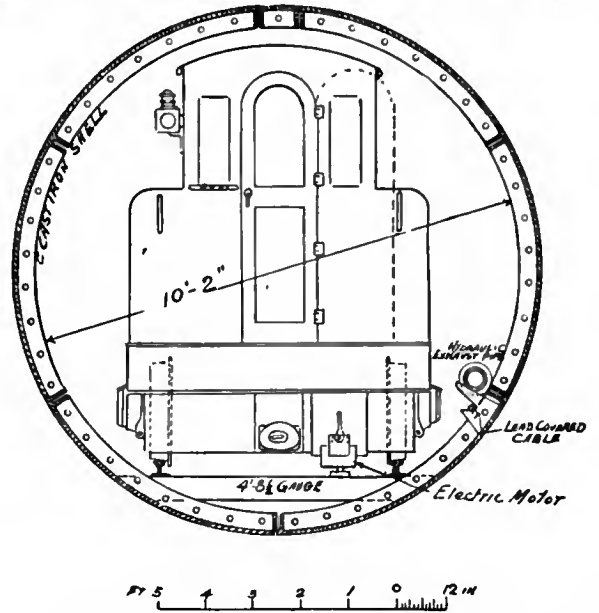

FIG. 33.—Section of Tunnel and Electric Locomotive, City & South London railway.

clear diameter of 10 ft. 2 in. Except at the shafts, which were sunk on proposed station sites, there was no interference with the surface of the streets or with street traffic during construction. Two tunnels were built approximately parallel, each taking a single track. The cross-section of the cars was made to conform approximately to the section of the tunnel, the idea being that each train would act like a piston in a cylinder, expelling in front of it a column of air, to be forced up the station shaft next ahead of the train, and sucking down a similar column through the station shaft just behind. This arrangement was expected to ensure a sufficient change in air to keep such railways properly ventilated, but experience has proved it to be ineffective for the purpose. This method of construction has been used for building other railways in Glasgow and London, and in the latter city alone the "tube railways" of this character have a length of some 40 m. The later examples of these railways have a diameter ranging from 13 to 15 ft.

The fourth step in the development of intra-urban railways was to go to the other extreme from the deep tunnel which Greathead introduced. In 1893 the construction was completed in Budapest of an underground railway with a thin, flat roof, consisting of steel beams set close together, with small longitudinal jack arches between them, the street pavement

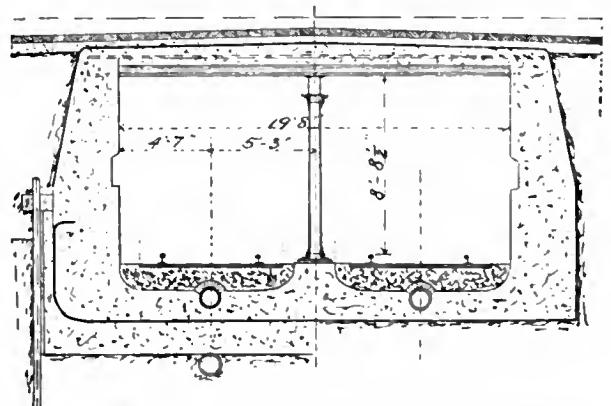

FIG. 34.—Electric Underground Railway, Budapest.

resting directly on the roof thus formed (fig. 34). The object was to bring the level of the station platforms as close to the

surface of the street as the height of the car itself would permit; in the case of Budapest the distance is about 9 ft. This principle of construction has since been followed in the construction of the Boston subway, of the Chemin de Fer Métropolitain in Paris, and of the New York underground railway. The Paris line is built with the standard gauge of 4 ft 8½ in., but its tunnels are designedly made of such a small cross-section that ordinary main line stock cannot pass through them.

The New York underground railway (fig. 35) marks a still further step in advance, in that there are practically two

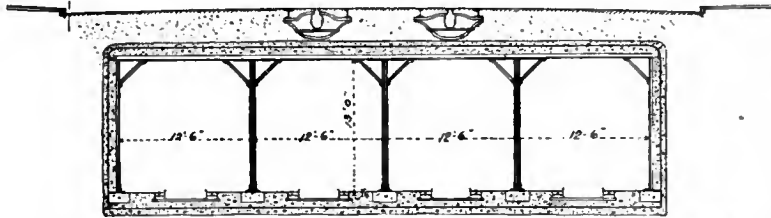

FIG. 35.—New York Rapid Transit railway, showing also the tracks and conduits of the electric surface tramway.

different railways in the same structure. One pair of tracks is used for a local service with stations about one-quarter of a mile apart, following the general plan of operation in vogue on all other intra-urban railways. The other, or central, pair of tracks is for trains making stops at longer distances. Thus there is a differentiation between the long-distance traveller who desires to be carried from one extreme of the city to the other and the short-distance traveller who is going between points at a much less distance.

To sum up, there are of intra-urban railways two distinct classes: the elevated and the underground. The elevated is used where the traffic is so light as not to warrant the expensive underground construction, or where the construction of an elevated line is of no serious detriment to the adjoining property. The underground is used where the congestion of traffic is so great as to demand a railway almost regardless of cost, and where the conditions of surface traffic or of adjoining property are such as to require that the railway shall not obstruct or occupy any ground above the surface.

Underground railways are of three general types: the one of extreme depth, built by tunnelling methods, usually with the shield and without regard to the surface topography, where the stations are put at such depth as to require lifts to carry the passengers from the station platform to the street level. This type has the advantage of economy in first construction, there being the minimum amount of material to be excavated, and no interference during construction with street traffic or subsurface structures; it has, however, the disadvantage of the cost of operation of lifts at the stations. The other extreme type is the shallow construction, where the railway is brought to the minimum distance below the street level. This system has the advantage of the greatest convenience in operation, no lifts being required, since the distance from the street surface to the station platform is about 12 to 15 ft.; it has the disadvantages, however, of necessitating the tearing up of the street surface during construction, and the readjustment of sewer, water, gas and electric mains and other subsurface structures, and of having the gradients partially dependent on the surface topography. The third type is the intermediate one between those two, followed by the Metropolitan and Metropolitan District railways, in London, where the railway has an arched roof, built usually at a sufficient distance below the surface of the street to permit the other subsurface structures to lie in the ground above the crown of the arch, and where the station platforms are from 20 to 30 ft. beneath the surface of the street—a depth not sufficient to warrant the introduction of lifts, but enough to be inconvenient.

In the operation of intra-urban railways, steam locomotives, cables and electricity have severally been tried: the first having been used in the earlier examples of underground lines and in the various elevated systems in the United States. The fouling of the air that results from the steam-engine, owing to the production of carbonic acid gas and of sulphurous fumes and aqueous vapour, is well known, and its use is now practically abandoned for underground working. The cable is slow; and unless development along new lines of compressed air or some sort of chemical engine takes place, electricity will monopolize the field. Electricity is applied

*Opera-
tion.*

through a separate locomotive attached to the head of the train, or through motor carriages attached either at one end or at both ends of the train, or by putting a motor on every axle and so utilizing the whole weight of the train for traction, all the motors being under a single control at the head of the train, or at any point of the train for emergency. The distance between stations on intra-urban railways is governed by the density of local traffic and the speed desired to be maintained. As a general rule the interval varies from one-quarter to one-half mile; on the express lines of the New York underground

railway, the inter-station interval averages about 1½ m. On steam-worked lines the speed of trains is about 11 to 15 m. per hour, according to the distance between stations. Later practice takes advantage of the great increase in power that can be temporarily developed by electric motors during the period of acceleration; this, in proportion to the weight of the train to be hauled, gives results much in advance of those obtained on ordinary steam railways. Since high average speed on a line with frequent stops depends largely on rapidity of acceleration, the tendency in modern equipment is to secure as great an output of power as possible during the accelerating period, with corresponding increase in weight available for adhesion. With a steam locomotive all the power is concentrated in one machine, and therefore the weight on the drivers available for adhesion is limited. With electricity, power can be applied to as many axles in the train as desired, and so the whole weight of the train, with its load, may be utilized if necessary. Sometimes, as on the Central London railway, the acceleration of gravity is also utilized; the different stations stand, as it were, on the top of a hill, so that outgoing trains are aided at the start by having a slope to run down, while incoming ones are checked by the rising gradient they encounter.

The cost of intra-urban railways depends not only on the type of construction, but more especially upon local conditions, such as the nature of the soil, the presence of subsurface structures, like sewers, water and gas mains, electric conduits, &c.; the necessity of permanent underpinning or temporary supporting of house foundations, the cost of acquiring land passed under or over when street lines are not followed, and, in the case of elevated railways, the cost of acquiring easements of light, air and access, which the courts have held are vested in the abutting property. The cost of building an ordinary two-track elevated railway according to American practice varies from \$300,000 to \$400,000 a mile, exclusive of equipment, terminals or land damages. The cost of constructing the deep tubular tunnels in London, whose diameter is about 15 ft. exclusive, in like manner, of equipment, terminals or land damages, is about £170,000 to £200,000 a mile. The cost of the Metropolitan and Metropolitan District railways of London varied greatly on account of the variations in construction. The most difficult section—namely, that under Cannon Street—where the abutting buildings had to be underpinned, and a very dense traffic maintained during construction, while a network of sewers and mains was readjusted, cost at the rate of about £1,000,000 a mile. The contract price of the New York underground railway, exclusive of the incidentals above mentioned, was \$35,000,000 for 21 m., of which 16 m. are underground and 5 are elevated. The most difficult portion of the road, 4½ m. of four-track line, cost \$15,000,000. (W. B. P.)

Cost.

LIGHT RAILWAYS

The term light railways is somewhat vague and indefinite, and therefore to give a precise definition of its significance is not an easy matter. No adequate definition is to be found even in the British statute-book; for although *Great Britain*. parliament has on different occasions passed acts dealing with such railways both in Great Britain and Ireland, it has not inserted in any of them a clear and sufficient statement of what it intends shall be understood by the term, as distinguished from an ordinary railway. Since the passing of the Light Railways Act of 1896, which did not apply to Ireland, it is possible to give a formal definition by saying that a light railway is one constructed under the provisions of that act; but it must be noted that the commissioners appointed under that act have authorized many lines which in their physical characteristics are indistinguishable from street tramways constructed under the Tramways Act, and to these the term light railways would certainly not be applied in ordinary parlance. Still, they do differ from ordinary tramways in the important fact that the procedure by which they have been authorized is simpler and cheaper than the methods by which special private acts of parliament have to be obtained for tramway projects. Economy in capital outlay and cheapness in construction is indeed the characteristic generally associated with light railways by the public, and implicitly attached to them by parliament in the act of 1896, and any simplifications of the engineering or mechanical features they may exhibit compared with the standard railways of the country are mainly, if not entirely, due to the desire to keep down their expenses.

The saving of cost is effected in two ways: (1) Instead of having to incur the expenses of a protracted inquiry before parliament, the promoters of a light railway under the act of 1896 make an application to the light railway commissioners, who then hold a local inquiry, to obtain evidence of the usefulness of the proposed railway, and to hear objections to it, and, if they are satisfied, settle the draft order and hand it over to the Board of Trade for confirmation. The Board may reject the order if it thinks the scheme to be of such magnitude or importance that it ought to come under the direct consideration of parliament, or it may modify it in certain respects, or it may remit it to the commissioners for further inquiry. But once the order is confirmed by the Board, with or without modifications, it has effect as if it had been enacted by parliament, and it cannot afterwards be upset on the ground of any alleged irregularity in the proceedings. (2) The second source of economy is to be sought in the reduced cost of actually making the line and of working it when made. Thus the gauge may be narrow, the line single, the rails lighter than those used in standard practice, while deep cuttings and high embankments may be avoided by permitting the curves to be sharper and the gradients steeper: such points conduce to cheapness of construction. Again, low speeds, light stock, less stringent requirements as to continuous brakes, signals, block-working and interlocking, road-crossings, stations, &c., tend to cheapness in working. On the lines actually authorized by the Board of Trade under the 1896 act the normal minimum radius of the curves has been fixed at about 600 ft.; when a still smaller radius has been necessary, the speed has been reduced to 10 m. an hour and a guard-rail insisted on inside the curve. Again, the speed has been restricted to 20 m. an hour on long inclines with gradients steeper than 1 in 50, and also on a line which had scarcely any straight portions and in which there were many curves of 600 ft. radius and gradients of 1 in 50. In the case of a line of 2½ ft. gauge, with a ruling gradient of 1 in 40, a maximum speed of 15 m. an hour and a minimum radius of curve of 300 ft. have been prescribed. Curves of still smaller radius have entailed a maximum speed of 10 m. an hour. It must be understood that a railway described as "light" is not necessarily built of narrower gauge than the standard. Many lines, indeed, have been designed on the normal 4 ft. 8½ in. gauge, and laid with rails weighing from 50 to 70 lb per yard; a flat-footed 60 lb rail,

with the axle load limited to 14 tons, has the advantage for such lines that it permits the employment of a proportion of the locomotives used on main lines. The orders actually granted have allowed 50 lb, 56 lb, 60 lb and 70 lb rails, with corresponding axle loads of 10, 12, 14 and 16 tons. On a line of 2 ft. gauge, rails of 40 lb have been sanctioned. In regard to fencing and precautions at level-crossings, less rigid requirements may be enforced than with standard railways; and in some cases where trains are likely to be few, it has been provided that the normal position of the gates at crossings shall be across the line. Again, if the speed is low and the trains infrequent, the signalling arrangements may be of a very simple and inexpensive kind, or even dispensed with altogether. It should be mentioned that the act provided that the Treasury might advance a portion of the money required for a line in cases where the council of any county, borough or district had agreed to do the same, and might also make a special advance in aid of a light railway which was certified by the Board of Agriculture to be beneficial to agriculture in any cultivated district, or by the Board of Trade to furnish a means of communication between a fishing-harbour and a market in a district where it would not be constructed without special assistance from the state.

As a general classification the commissioners have divided the schemes that have come before them into three classes: (A) those which like ordinary railways take their own line across country; (B) those in connexion with which it is proposed to use the public roads conjointly with the ordinary road traffic; and (Neutral) which includes inclined railways worked with a rope, and lines which possess the conditions of A and B in about equal proportions.

The Light Railways Act 1896 was to remain in force only until the end of 1901 unless continued by parliament, but it was continued year by year under the Expiring Laws Continuance Act. In 1901 the president of the Board of Trade introduced a bill to continue the act until 1906, and to amend it so as to make it authorize the construction of a light railway on any highway, the object being to abolish the restriction that a light railway should run into the area of at least two local authorities; but it was not proceeded with. Towards the end of 1901 a departmental committee of the Board of Trade was formed to consider the Light Railways Act, and in 1902 the president of the Board of Trade (Mr Gerald Balfour) stated that as a result of the deliberations of this committee, a new bill had been drafted which he thought would go very far to meet all the reasonable objections that had been urged against the present powers of the local authorities. This bill, however, was not brought forward. In July 1903, Lord Wolverton, on behalf of the Board of Trade, introduced a bill to continue and amend the Light Railways Act. It provided that the powers of the light railway commissioners should continue until determined by parliament, and also provided, *inter alia*, that in cases where the Board of Trade thought, under section (9) subsection (3) of the original act, that a proposal should be submitted to parliament, the Board of Trade itself might submit the proposals to parliament by bringing in a bill for the confirmation of the light railway order, with a special report upon it. Opposition on petition could be heard before a select committee or a joint committee as in the case of private bills. The bill was withdrawn on the 11th of August 1903, Lord Morley appealing to the Board of Trade to bring in a more comprehensive measure to amend the unsatisfactory state of legislation in relation to tramways and light railways. In 1904 the president of the Board of Trade brought in a bill on practically the same lines as the amending bill of 1903. It reached second reading but was not proceeded with. Similar amending bills were introduced in the 1905 and 1906 sessions, but were withdrawn. During the first ten years after the act came into force 545 applications for orders were received, 313 orders were made, and 282 orders were confirmed. The orders confirmed were for 1731 m., involving an estimated capital expenditure of £12,770,384. At the end of 1906 only 500 m. had been opened for traffic, and the mileage of lines

opened was much less in proportion to the mileage sanctioned in the cases of lines constructed on their own land than in the case of lines more of the nature of tramways. (In other countries where the mileage of main lines of railways in proportion to area and population is roughly the same as in the United Kingdom, the mileage of light railways already constructed is considerable, while many additional lines are under construction. At the end of 1903 there were 6150 m. working in France, costing on an average £4500 per mile, earning £275 per mile per annum; 3730 miles in Prussia costing £4180 per mile, earning £310 per mile per annum; 1430 m. in Belgium at £3400 per mile, earning £320 per mile per annum.) The average cost per mile in Great Britain on the basis of the prescribed estimates is £5860, but this figure does not include the cost of equipment and does not cover the whole cost of construction. According to the light railway commissioners, experience satisfied them (a) that light railways were much needed in many parts of the country and that many of the lines proposed, but not constructed, were in fact necessary to admit of the progress, and even the maintenance, of existing trade interests; and (b) that improved means of access were requisite to assist in retaining the population on the land, to counteract the remoteness of rural districts, and also, in the neighbourhood of industrial centres, to cope with the difficulties as to housing and the supply of labour. They pointed out that while during the first five years the act was in force there were 315 applications for orders, during the second five years there were only 142 applications, and that proposals for new lines had become less numerous owing to the various difficulties in carrying them to a successful completion and to the difficulty of raising the necessary capital even when part of it was provided with the aid of the state and of the local authorities. They expressed the opinion that an improvement could be effected enabling the construction of many much-needed lines by an amendment of some of the provisions of the Light Railways Act, and by a reconsideration of the conditions under which financial or other assistance should be granted to such lines by the state and by local authorities.

The so-called light railways in the United States and the British colonies have been made under the conditions peculiar to new countries. Their primary object being the development and peopling of the land, they have naturally been made as cheaply as possible; and as in such cases the cost of the land is inconsiderable, economy has been sought by the use of lighter and rougher permanent way, plant, rolling stock, &c. Such railways are not "light" in the technical sense of having been made under enactments intended to secure permanent lowness of cost as compared with standard lines. On the continent of Europe many countries have encouraged railways which are light in that sense. France began to move in this direction in 1865, and has formulated elaborate provisions for their construction and regulation. Italy did the same in its laws in 1873, 1879, 1881, 1887 and 1889; and Germany fostered enterprise of this kind by the imperial edicts of 1875, 1878 and 1892. Holland, Hungary and Switzerland were all early in the field; and Belgium has succeeded, through the instrumentality of the semi-official Société Nationale de Chemins de Fer Vicinaux, started in 1885, in developing one of the most complete systems of rural railway transport in the world.

In France the lines which best correspond to British light railways are called *Chemins de fer d'intérêt local*. These are regulated by a decree No. 11,264 of 6th August 1881, which the Ministry of Public Works is charged to carry out. The model "form of regulation" lays down the scales of the drawings and the information to be shown thereon. For the first installation a single line is prescribed, but the *concessionnaire* must provide space and be prepared to double when required. The gauge may be either 1.44 metres (4 ft. 8.7 in.), or 1 metre (3 ft. 3.37 in.), or .75 metre (2 ft. 5.5 in.). The radius of curves for the 1.44 m. gauge must not be less than 250 metres, 100 metres for the 1 m. gauge and 50 metres for the .75 m. gauge. A straight length of not less than 60 metres for the largest gauge and 40 metres for the smallest must be made between two curves having opposite directions. Except in special cases, gradients must not exceed 3 in 100; and

between gradients in the opposite sense there must be not less than 60 metres of level for 1.44 m. and 40 metres for 1 m. and .75 m. gauges. The position of stations and stopping-places is regulated by the council of the department. The undertaking, once approved, is regarded as a work of public utility, and the undertakers are invested with all the rights that a public department would have in the case of the carrying out of public works. At the end of the period of the concession the *département* comes into possession of the road and all its fixed appurtenances, and in the last five years of the period the *département* has the right to enter into possession of the line, and apply the revenue to putting it into a thorough state of repair. It has also the right to purchase the undertaking at the end of the first fifteen years, the net profits of the preceding seven years to govern the calculation of the purchase price. The maximum 1st, 2nd and 3rd class passenger fares are, per kilometre, .067 f. (.6d.), .050 f. (.455d.) and .037 f. (.34d.) respectively, when the trains are run at *grande vitesse*, the fares including 30 kilogrammes weight of personal baggage.

In Belgium a public company under government control ("*Société Nationale de Chemins de Fer Vicinaux*") does all that in France forms the responsibility of the Ministry of the Interior and of the prefect of the department. Over an average **Belgium.** of years it appears that 27% of the capital cost was found by the state, 28% by the province, 40.9% by the communes and 4.1% by private individuals. At the end of 1908 there were 2085 m. in operation, and the total mileage authorized was 2603, while the construction of a considerable further mileage was under consideration. As far as possible, these railways are laid beside roads, in preference to independent formation; the permanent way costs £977 per mile in the former as against £793 in the latter. If laid in paving, the price varies between £1108 and £2266 per mile. Through villages, and where roads have to be crossed, the line is of the usual tramway type. The line is of 1 metre gauge, with steel rails weighing 21½ kilos (42 lb) per yard. In the towns a deeper rail is used, weighing about 60 lb per yard. In three lines of the Vicinaux system, in the aggregate 45 m. in length, the sharpest curves are 30 metres, 35 metres and 40 metres respectively. There are gradients of 1 in 20 and 1 in 25. The speed is limited to 30 kilometres (about 18 m.) in the country and 6 m. per hour in towns and through villages.

In Italy many railways which otherwise fulfil the conditions of a light railway are constructed with a gauge of 4 ft. 8½ in. The weights are governed by what the railway has to carry **Italy.** and the speed. Light locomotives, light rails and light rolling stock are employed. There are no bridges, except where watercourses occur. Cuttings are reduced to a minimum; and where the roads are sufficiently wide, the rails are laid on the margins. The advantage of uniformity of gauge is in the use of trucks for goods which belong to the rolling stock of the main lines. In Italy these railways are called "economic railways," and are divided into five types. Types I., II. and III. are of 4 ft. 8½ in. gauge, type IV. of 0.95 m. and type V. of 0.70 m.; but as there is no example of type V., the classification is practically one of 1.445 m. (4 ft. 8½ in.) and one of 0.95 (3 ft. 0.5 in.). The chief difference between the first three types lies in the weight of rails and rolling stock and in the radius of the curves. The real light railway of Italy is that of type IV.: gauge, 0.95 m. (3 ft. 0.5 in.); weight of rails, 12 (26.45 lb) to 20 (44 lb) kilos; mean load per axle, 6 tons; minimum curve, 70 m. (229 ft. 2.6 in.) radius; width of formation, 3.50 m. (11 ft. 5.5 in.); top width of ballast, 2.10 m. (6 ft. 10.7 in.); depth of ballast under sleepers, 0.10 m. (3 ft. 9.5 in.); maximum gradient, 1 in 50; length of sleepers, 1.70 m. (5 ft. 6.92 in.); width between parapets and width of tunnels, 1 m. over width of carriage; height of tunnels, 5 m. (16 ft. 4.85 in.); locomotives, maximum weight per axle 6 tons, rigid wheel base 1.80 m. (5 ft. 10.86 in.), diameter of driving-wheels 1 m. (3 ft. 3.37 in.).

In Germany the use of light railways (*Klein-bahnen*) has made great strides. The gauges in use vary considerably between 4 ft. 8½ in., the standard national gauge, and 1 ft. 11¼ in., **Germany.** which appears to be the smallest in use. They are under the control of the Post and Telegraph department, the state issuing loans to encourage the undertakings; the authorities in the provinces and communes also give support in various ways, and under various conditions, to public bodies or private persons who desire to promote or embark on the industry. These conditions, as well as the degree of control over the construction and working of the lines, are left to the regulation of the provincial governments. Similarly, the same authorities decide for themselves the conditions under which the public roads may be used, and the precautions for public safety, all subject to the confirmation of the imperial government.

What are known as "portable railways" should be included in the same category as light railways. With a 24 in. gauge, lines of a portable kind can be made very handily and the cost is very much less than that of a permanently constructed light railway. The simplicity is great; **Portable railways.** they can be quickly mounted and dismounted; the correct gauge can be perfectly maintained; the sections of rails and

sleepers (which are of iron) are very portable, and skilled labour is not required to lay or to take them up; the making of a "turn-out" is easy, by taking out a 15 ft. section of the way and substituting a section with points and crossings. The safe load per wheel varies between 12 cwt. on a 10 in. 16 lb wheel and 40 cwt. on an 18 in. 56 lb wheel. The rolling stock is constructed either for farm produce or heavy minerals, the latter holding 10 to 27 cub. ft. For timber, 4 or 5 ft. bogies can be used. A useful wagon for agricultural transport on a 24 in. gauge line is 16 ft. long by 5 ft. wide; it weighs 72 cwt. and costs £30. A portable line of this kind will have 20 lb steel rails and 2112 steel sleepers—4 ft. 6 in. long—to a mile, laid 2 ft. 6 in. apart centre to centre. The total cost per mile of such a line, including all bolts, nuts, fish-plates and fastenings, ready for laying, delivered in the United Kingdom, is under £500 a mile.

See Evans Austin, *The Light Railways Act 1896*, which contains the rules of the Board of Trade; W. H. Cole, *Light Railways at Home and Abroad*; Lieut.-Col. Addison, *Report to the Board of Trade (1894) on Light Railways in Belgium*. (C. E. W.; E. GA.)

RAIMBACH, ABRAHAM (1776–1843), English line-engraver, a Swiss by descent, was born in London in 1776. Educated at Archbishop Tenison's Library School, he was an apprentice to J. Hall the engraver from 1789 to 1796. For nine years part of his working-time was devoted to the study of drawing in the Royal Academy and to executing occasional engravings for the booksellers, whilst his leisure hours were employed in painting portraits in miniature. Having formed an intimacy with Sir David Wilkie, Raimbach in 1812 began to engrave some of that master's best pictures. At his death, in 1843, he held a gold medal awarded to him for his "Village Politicians" at the Paris Exhibition of 1814. He was elected corresponding member of the Institute of France in 1835.

RAIMUND, FERDINAND (1790–1836), Austrian actor and dramatist, was born on the 1st of June 1790, in Vienna. In 1814 he acted at the Josefstädter Theater, and in 1817 at the Leopoldstädter Theater. In 1823 he produced his first play, *Der Barometermacher auf der Zauberinsel*, which was followed by *Der Diamant des Geisterkönigs* (1824) and the still popular *Bauer als Millionär*. The last-mentioned play, which appeared in 1826, *Der Alpenkönig und der Menschenfeind* (1828) and *Der Verschwendter* (1833) are Raimund's masterpieces. He committed suicide on the 5th of September 1836, owing to the fear that he had been bitten by a mad dog. Raimund was a master of the Viennese *Posse* or farce; his rich humour is seen to best advantage in his realistic portraits of his fellow-citizens.

Raimund's *Sämliche Werke* (with biography by J. N. Vogl) appeared in 4 vols. (1837); they have been also edited by K. Glossy and A. Sauer (4 vols., 1881; 2nd ed., 1891), and a selection by E. Castle (1903). See E. Schmidt in *Charakteristiken*, vol. i. (1886); A. Farinelli, *Grillparzer und Raimund* (1897); L. A. Frankl, *Zur Biographie F. Raimunds* (1884); and especially A. Sauer's article in the *Allgem. Deutsche Biographie*.

RAIN (O.E. *regn*; the word is common to Teutonic languages, cf. Ger. *Regen*, Swed. and Dan. *regnu*; it has been connected with Lat. *rigare*, to wet, Gr. *βρέχειν*), the water vapour of the atmosphere when condensed into drops large enough to be precipitated upon the earth. Hence the term is extended to signify the fall of such drops in a shower, and in the plural, "the rains," it signifies the rainy seasons in India and elsewhere where under normal climatic conditions such seasons are clearly distinguished from the dry. A rain-band is "a dark band in the solar spectrum, caused by the presence of water-vapour in the atmosphere" (*New Engl. Dict.*); a rain-gauge is an instrument used to measure the amount of rainfall (see METEOROLOGY, where the whole subject of precipitation is fully treated).

RAINBOW, formerly known as the *iris*, the coloured rings seen in the heavens when the light from the sun or moon shines on falling rain; on a smaller scale they may be observed when sunshine falls on the spray of a waterfall or fountain. The bows assume the form of concentric circular arcs, having their common centre on the line joining the eye of the observer to the sun. Generally only one bow is clearly seen; this is known as the *primary rainbow*; it has an angular radius of about 41°

and exhibits a fine display of the colours of the spectrum, being red on the outside and violet on the inside. Sometimes an outer bow, the *secondary rainbow*, is observed; this is much fainter than the primary bow, and it exhibits the same play of colours, with the important distinction that the order is reversed, the red being inside and the violet outside. Its angular radius is about 57°. It is also to be noticed that the space between the two bows is considerably darker than the rest of the sky. In addition to these prominent features, there are sometimes to be seen a number of coloured bands, situated at or near the summits of the bows, close to the inner edge of the primary and the outer edge of the secondary bow; these are known as the *spurious*, *supernumerary* or *complementary rainbows*.

The formation of the rainbow in the heavens after or during a shower must have attracted the attention of man in remote antiquity. The earliest references are to be found in the various accounts of the Deluge. In the Biblical narrative (Gen. ix. 12–17) the bow is introduced as a sign of the covenant between God and man, a figure without a parallel in the other accounts. Among the Greeks and Romans various speculations as to the cause of the bow were indulged in; Aristotle, in his *Meteors*, erroneously ascribes it to the reflection of the sun's rays by the rain; Seneca adopted the same view. The introduction of the idea that the phenomenon was caused by refraction is to be assigned to Vitellio. The same conception was utilized by Theodoric of Vriberg, a Dominican, who wrote at some time between 1304 and 1311 a tract entitled *De radialibus impressionibus*, in which he showed how the primary bow is formed by two refractions and one internal reflection; i.e. the light enters the drop and is refracted; the refracted ray is then reflected at the opposite surface of the drop, and leaves the drop at the same side at which it enters, being again refracted. It is difficult to determine the influence which the writings of Theodoric had on his successors; his works were apparently unknown until they were discovered by G. B. Venturi at Basel, partly in the city library and partly in the library of the Dominican monastery. A full account, together with other early contributions to the science of light, is given in Venturi's *Commentari sopra la storia de la Teoria del Ottica* (Bologna, 1814). John Fleischer (sometimes incorrectly named Fletcher), of Breslau, propounded the same view in a pamphlet, *De iridibus doctrina Aristotelis et Vitellonis* (1574); the same explanation was given by Franciscus Maurolycus in his *Photismi de lumine et umbra* (1575).

The most valuable of all the earlier contributions to the scientific explanation of rainbows is undoubtedly a treatise by Marco Antonio de Dominis (1566–1624), archbishop of Spalatro. This work, *De radiis visus et lucis in vitris perspectivis et iride*, published at Venice in 1611 by J. Bartolus, although written some twenty years previously, contains a chapter entitled "Vera iridis tota generatio explicatur," in which it is shown how the primary bow is formed by two refractions and one reflection, and the secondary bow by two refractions and two reflections. Descartes strengthened these views, both by experiments and geometrical investigations, in his *Meteors* (Leiden, 1637). He employed the law of refraction (discovered by W. Snellius) to calculate the radii of the bows, and his theoretical angles were in agreement with those observed. His methods, however, were not free from tentative assumptions, and were considerably improved by Edmund Halley (*Phil. Trans.*, 1700, 714). Descartes, however, could advance no satisfactory explanation of the chromatic displays; this was effected by Sir Isaac Newton, who, having explained how white light is composed of rays possessing all degrees of refrangibility, was enabled to demonstrate that the order of the colours was in perfect accord with the requirements of theory (see Newton's *Opticks*, book i. part 2, prop. 9).

The geometrical theory, which formed the basis of the investigations of Descartes and Newton, afforded no explanation of the supernumerary bows, and about a century elapsed before an explanation was forthcoming. This was given by Thomas Young, who, in the Bakerian lecture delivered before the Royal Society on the 24th of November 1803, applied his principle

of the interference of light to this phenomenon. His not wholly satisfactory explanation was mathematically examined in 1835 by Richard Potter (*Camb. Phil. Trans.*, 1838, 6, 141), who, while improving the theory, left a more complete solution to be made in 1838 by Sir George Biddell Airy (*Camb. Phil. Trans.*, 1838, 6, 379).

The geometrical theory first requires a consideration of the path of a ray of light falling upon a transparent sphere. Of the total amount of light falling on such a sphere, part is reflected or scattered at the incident surface, so rendering the drop visible, while a part will enter the drop. Confining our attention to a ray entering in a principal plane, we will determine its deviation, *i.e.* the angle between its directions of incidence and emergence, after one, two, three or more internal reflections. Let EA be a ray incident at an angle *i* (fig. 1); let AD be the refracted ray, and *r* the angle of refraction. Then the deviation experienced by the ray at A is *i* - *r*. If the ray suffers one internal reflection at D, then it is readily seen that, if DB be the path of the reflected ray, the angle ADB equals 2*r*, *i.e.* the deviation of the ray at D is $\pi - 2r$. At B, where the ray leaves the drop, the deviation is the same as at A, *viz.* *i* - *r*. The total deviation of the ray is consequently given by $D = 2(i - r) + \pi - 2r$.

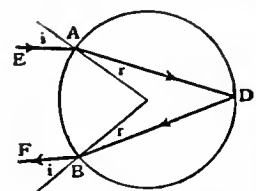

FIG. 1.

Similarly it may be shown that each internal reflection introduces a supplementary deviation of $\pi - 2r$; hence, if the ray be reflected *n* times, the total deviation will be $D = 2(i - r) + n(\pi - 2r)$.

The deviation is thus seen to vary with the angle of incidence; and by considering a set of parallel rays passing through the same principal plane of the sphere and incident at all angles, it can be readily shown that more rays will pass in the neighbourhood of the position of minimum deviation than in any other position (see REFRACTION). The drop will consequently be more intensely illuminated when viewed along these directions of minimum deviation, and since it is these rays with which we are primarily concerned, we shall proceed to the determination of these directions.

Since the angles of incidence and refraction are connected by the relation $\sin i = \mu \sin r$ (Snell's Law), μ being the index of refraction of the medium, then the problem may be stated as follows: to determine the value of the angle *i* which makes $D = 2(i - r) + n(\pi - 2r)$ a maximum or minimum, in which *i* and *r* are connected by the relation $\sin i = \mu \sin r$, μ being a constant. By applying the method of the differential calculus, we obtain $\cos i = \sqrt{\{(\mu^2 - 1)/(n^2 + 2n)\}}$ as the required value; it may be readily shown either geometrically or analytically that this is a minimum. For the angle *i* to be real, $\cos i$ must be a fraction, that is $n^2 + 2n > \mu^2 - 1$, or $(n + 1)^2 > \mu^2$. Since the value of μ for water is about $\frac{4}{3}$, it follows that *n* must be at least unity for a rainbow to be formed; there is obviously no theoretical limit to the value of *n*, and hence rainbows of higher orders are possible.

So far we have only considered rays of homogeneous light, and it remains to investigate how lights of varying refrangibilities will be transmitted. It can be shown, by the methods of the differential calculus or geometrically, that the deviation increases with the refractive index, the angle of incidence remaining constant. Taking the refractive index of water for the red rays as $\frac{10}{81}$, and for the violet rays as $\frac{10}{81}$, we can calculate the following values for the minimum deviations corresponding to certain assigned values of *n*.

<i>n</i>	Red.	Violet.
1	$\pi - 42^\circ.1$	$\pi - 40^\circ.22$
2	$2\pi - 129^\circ.2$	$2\pi - 125^\circ.48$
3	$3\pi - 231^\circ.4$	$3\pi - 227^\circ.08$
4	$4\pi - 317^\circ.07$	$4\pi - 310^\circ.07$

To this point we have only considered rays passing through a principal section of the drop; in nature, however, the rays impinge at every point of the surface facing the sun. It may be readily deduced that the directions of minimum deviation for a pencil of parallel rays lie on the surface of cones, the semi-vertical angles of which are equal to the values given in the above table. Thus, rays suffering one internal reflection will all lie within a cone of about 42° ; in this direction the illumination will be most intense; within the cone the illumination will be fainter, while, without it, no light will be transmitted to the eye.

Fig. 2 represents sections of the drop and the cones containing the minimum deviation rays after 1, 2, 3 and 4 reflections; the order of the colours is shown by the letters R (red) and V (violet). It is apparent, therefore, that all drops transmitting intense light after one internal reflection to the eye will lie on the surfaces of cones having the eye for their common vertex, the line joining the eye to the sun for their axis, and their semi-vertical angles equal to about 41° for the violet rays and 43° for the red rays. The observer will,

therefore, see a coloured band, about 2° in width, and coloured violet inside and red outside. Within the band, the illumination

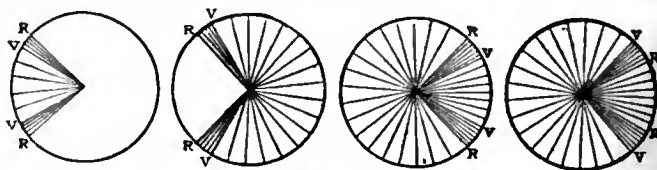

FIG. 2

will be faint; outside the band there will be perceptible darkening until the second bow comes into view. Similarly, drops transmitting rays after two internal reflections will be situated on conical and coaxial cones, of which the semi-vertical angles are 51° for the red rays and 54° for the violet. Outside the cone of 54° there will be faint illumination; within it, no secondary rays will be transmitted to the eye. We thus see that the order of colours in the secondary bow is the reverse of that in the primary; the secondary is half as broad again (3°), and is much fainter, owing to the longer path of the ray in the drop, and the increased dispersion.

Similarly, the third, fourth and higher orders of bows may be investigated. The third and fourth bows are situated between the observer and the sun, and hence, to be viewed, the observer must face the sun. But the illumination of the bow is so weakened by the repeated reflections, and the light of the sun is generally so bright, that these bows are rarely, if ever, observed except in artificial rainbows. The same remarks apply to the fifth bow, which differs from the third and fourth in being situated in the same part of the sky as the primary and secondary bows, being just above the secondary.

The most conspicuous colour band of the principal bows is the red; the other colours shading off into one another, generally with considerable blurring. This is due to the superposition of a great number of spectra, for the sun has an appreciable apparent diameter, and each point on its surface gives rise to an individual spectrum. This overlapping may become so pronounced as to produce a rainbow in which colour is practically absent; this is particularly so when a thin cloud intervenes between the sun and the rain, which has the effect of increasing the apparent diameter of the sun to as much as 2° or 3° . This phenomenon is known as the "white rainbow" or "Ulloa's Ring or Circle," after Antonio de Ulloa.

We have now to consider the so-called spurious bows which are sometimes seen at the inner edge of the primary and at the outer edge of the secondary bow. The geometrical theory can afford no explanation of these coloured bands, and it has been shown that the complete phenomenon of the rainbow is to be sought for in the conceptions of the wave theory of light. This was first suggested by Thomas Young, who showed that the rays producing the bows consisted of two systems, which, although emerging in parallel directions, traversed different paths in the drop. Destructive interference between these superposed rays will therefore occur, and, instead of a continuous maximum illumination in the direction of minimum deviation, we should expect to find alternations of brightness and darkness. The later investigations of Richard Potter and especially of Sir George Biddell Airy have proved the correctness of Young's idea. The mathematical discussion of Airy showed that the primary rainbow is not situated directly on the line of minimum deviation, but at a slightly greater value; this means that the true angular radius of the bow is a little less than that derived from the geometrical theory. In the same way, he showed that the secondary bow has a greater radius than that previously assigned to it. The spurious bows he showed to consist of a series of dark and bright bands, whose distances from the principal bows vary with the diameters of the raindrops. The smaller the drops, the greater the distance; hence it is that the spurious bows are generally only observed near the summits of the bows, where the drops are smaller than at any lower altitude. In Airy's investigation, and in the extensions by Boitel, J. Larmor, E. Mascart and L. Lorentz, the source of light was regarded as a point. In nature, however, this is not realized, for the sun has an appreciable diameter. Calculations taking this into account have been made by J. Pernter (*Neues über den Regenbogen*, Vienna, 1888) and by K. Aichi and T. Tanakadate (*Jour. College of Science*, Tokyo, 1906, vol. xxi. art. 3).

Physical theory.

Experimental confirmation of Airy's theoretical results was afforded in 1842 by William Hallows Miller (*Camb. Phil. Trans.* vii. 277). A horizontal pencil of sunlight was admitted by a vertical slit, and then allowed to fall on a column of water supplied by a jet of about $\frac{1}{16}$ th of an inch in diameter. Primary, secondary and spurious bows were formed, and their radii measured; a comparison of these observations exhibited agreement with Airy's analytical values. Pulfrich (*Wied. Ann.*, 1888, 33, 194) obtained similar results by using cylindrical glass rods in place of the column of water.

In accordance with a general consequence of reflection and refraction, it is readily seen that the light of the rainbow is partially polarized, a fact first observed in 1811 by Jean Baptiste Biot (see POLARIZATION).

Lunar rainbows. The moon can produce rainbows in the same manner as the sun. The colours are much fainter, and according to Aristotle, who claims to be the first observer of this phenomenon, the lunar bows are only seen when the moon is full.

Marine rainbow is the name given to the chromatic displays formed by the sun's rays falling on the spray drawn up by the wind playing on the surface of an agitated sea.

Intersecting rainbows are sometimes observed. They are formed by parallel rays of light emanating from two sources, as, for example, the sun and its image in a sheet of water, which is situated between the observer and the sun. In this case the second bow is much fainter, and has its centre as much above the horizon as that of the direct system is below it.

REFERENCES.—For the history of the theory of the rainbow, see G. B. Venturi, *Commentari sopra la storia de la teoria del Ottica* (Bologna, 1814); F. Rosenberger, *Geschichte der Physik* (1882-90). The geometrical and physical theory is treated in T. Preston's *Theory of Light*; E. Mascart's *Traité d'optique* (1899-1903); and most completely by J. Pernter in various contributions to scientific journals and in his *Meteorologische Optik* (1905-9).

RAINOLDS (or REYNOLDS), **JOHN** (1549-1607), English divine, was born about Michaelmas 1549 at Pinhoe, near Exeter, and was educated at Merton and Corpus Christi Colleges, Oxford, becoming a fellow of the latter in 1568. In 1572-73 he was appointed reader in Greek, and his lectures on Aristotle's *Rhetoric* laid the sure basis of his fame. He resigned the office in 1578 and his fellowship in 1586, through inability to agree with the president William Cole, and became a tutor at Queen's College. By this time he had acquired a considerable reputation as a disputant on the Puritan side, and the story goes that Elizabeth visiting the university in 1592 "schooled him for his obstinate preciseness, willing him to follow her laws, and not run before them." In 1593 he was made dean of Lincoln. The fellows of Corpus were anxious to replace Cole by Rainolds, and exchange was effected, Rainolds being elected president in December 1598. The chief events of his subsequent career were his share in the Hampton Court Conference, where he was the most prominent representative of the Puritan party and received a good deal of favour from the king, and in the Authorized Version of the Bible. Of this project he was initiator, and himself worked with the company who undertook the translation of the Prophets. He died of consumption on the 21st of May 1607, leaving a great reputation for scholarship and high character.

RAINY, ROBERT (1826-1906), Scotch Presbyterian divine, was born on the 1st of January 1826; his father, Dr Harry Rainy, professor of forensic medicine in Glasgow University, was the son of a Sutherlandshire minister. Young Rainy was intended for his father's profession, but he was caught by the evangelical fervour of the Disruption movement, and after studying for the Free Church he became a minister, first in Aberdeenshire and then in Edinburgh, till in 1862 he was elected professor of Church history in the theological seminary, New College, a post he only resigned in 1900. In 1874 he was made principal of the college and was subsequently known as Principal Rainy. He had come to the front as a champion of the liberal party in the Union controversy within the Free Church, and in combating Dean Stanley's Broad Church views in the interests of Scotch evangelicism; and about 1875 he became the undisputed leader of the Free Church. He guided it through the controversies as to Robertson Smith's heresies, as to the use of hymns and instrumental music, and as to the Declaratory Act, brought to a successful issue the union of the Free and United Presbyterian Churches, and threw the weight of the united church on the side of freedom of Biblical criticism. He was the first moderator of the General Assembly of the United Free Church of Scotland, having previously been moderator of the Free General Assembly. Though not a great scholar, he was eminent as an ecclesiastical statesman, and his influence was far-reaching. After the strain of the fight with the so-called "Wee Frees" in 1904-5 his health broke down, and he went to Australia for recovery, but died at Melbourne on the 22nd of December 1906.

See Lives by P. Carnegie Simpson (1909) and R. Mackintosh (1907).

RAIPUR, a town and district of British India, in the Chhattisgarh division of the Central Provinces. The town is 994 ft. above sea-level, 188 m. E. of Nagpur; and has a station on the Bengal-Nagpur railway. Pop. (1901) 32,114. There are ruins of an immense fort, with many tanks and old temples. It has a German mission and a government high school. The Rajkumar college, for the education of the sons of the chiefs of Chhattisgarh, was transferred here from Jubbulpore in 1894.

The DISTRICT OF RAIPUR has an area of 9831 sq. m. It spreads over a vast plateau closed in by ranges of hills branching from the great Vindhyan chain. It is drained by the Seonath and the Mahanadi rivers. Geologically the country consists in the hilly tracts of gneiss and quartzite; the sandstone rocks in the west are intersected with trap dykes. Iron ore is abundant, and red ochre of high repute is found. In the interior the principal strata are a soft sandstone slate (covered generally by a layer of laterite gravel) and blue limestone, which crops out in numerous places on the surface and is invariably found in the beds of the rivers. Throughout the plains the soil is generally fertile. The climate is generally good; the mean temperature is 78° F., and the annual rainfall averages 55 in. The population on the present area in 1901 was 1,096,858, showing a decrease of 2.5% in the decade. The principal crop is rice. There are manufactures of cotton goods and brassware. The north-west corner of the district is crossed by the main line of the Bengal-Nagpur railway, and a narrow-gauge branch runs from Raipur town due south. The district suffered severely from famine in 1896-97, and again in 1899-1900.

Raipur was governed by a branch of the Haihaivansi dynasty of Ratanpur for many centuries until their deposition by the Mahrattas in 1750. The country was then already in a condition of decay, and soon afterwards it relapsed into absolute anarchy. In 1818 it was taken under British superintendence and made rapid progress. It fell with the rest of the Nagpur dominions to the British government in 1854. In 1906 its area was reduced by the formation of the new district of Drug.

RAIS (or RETZ), **GILLES DE** (1404-1440), marshal of France and the central figure of a 15th-century *cause célèbre*, whose name is associated with the story of Bluebeard, was the son of Guy de Montmorency-Laval, the adopted son and heir of Jeanne de Rais and of Marie de Craon. He was born at Macheoul in September or October 1404, and, being early left an orphan, was educated by his maternal grandfather, Jean de Craon. Chief among his great possessions was the barony of Rais (erected in the 16th century into the peerage-duchy of Retz), south of the Loire, on the marches of Brittany. He joined the party of the Montforts, supporting Jean V. of Brittany against the rival house of Penthièvre. He helped to release Duke John from Olivier de Blois, count of Penthièvre, who had taken him prisoner by craft, and was rewarded by extensive grants of land, which were subsequently commuted by the Breton parliament for money payments. In 1420, after other projects of marriage had fallen through, in two cases by the death of the bride, he married Katherine of Thouars, a great heiress in Brittany, La Vendée and Poitou. In 1426 he raised seven companies of men-at-arms, and began active warfare against the English under Artus de Richemont, the newly made constable of France. He had already built up a military reputation when he was chosen to accompany Joan of Arc to Orleans. He continued to be her special protector, fighting by her side at Orleans, and afterwards at Jargeau and Patay. He had advocated further measures against the English on the Loire before carrying out the coronation of Charles VII. at Reims. On the 17th of July he was made marshal of France at Reims, and after the assault on Paris he was granted the right to bear the arms of France as a border to his shield, a privilege that was, however, never ratified. In the winter he was in Normandy, at Louviers, whether with a view to the release of Joan, then a prisoner at Rouen, cannot be stated. Meanwhile his fortune was disappearing, although he had been one of the richest men in France. He had expended great sums in the king's service, and he maintained a court of

knights, squires, heralds and priests, more suited to royal than baronial rank. He kept open house, was a munificent patron of literature and of music, and his library contained many valuable works, he himself being a skilled illuminator and binder. He also indulged a passion for the stage. At the chief festivals he gave performances of mysteries and moralities, and it has been asserted that the *Mystère de la Passion*, acted at Angers in 1420, was staged by him in honour of his own marriage. The original draft of the *Mystery of Orleans* was probably written under his direction, and contains much detail which may be well accounted for by his intimate acquaintance with the Maid. In his financial difficulties he began to alienate his lands, selling his estates for small sums. These proceedings provided his heirs with material for lawsuits for many years. Among those who profited by his prodigality were the duke of Brittany, and his chancellor, Jean de Malestroit, bishop of Nantes, but in 1436 his kinsfolk appealed to Charles VII., who proclaimed further sales to be illegal. Jean V. refused to acknowledge the king's right to promulgate a decree of this kind in Brittany, and replied by making Gilles de Rais lieutenant of Brittany and by acknowledging him as a brother-in-arms. Gilles hoped to redeem his fortunes by alchemy; he also spent large sums on necromancers, who engaged to raise the devil for his assistance. On the other hand he sought to guarantee himself from evil consequences by extravagant charity and a splendid celebration of the rites of the church. The abominable practices of which he was really guilty seem not to have been suspected by his equals or superiors, though he had many accomplices and his criminality was suspected by the peasantry. His wife finally left him in 1434-35, and may possibly have become acquainted with his doings, and when his brother René de la Suze seized Champocé, all traces of his crimes had not been removed, but family considerations no doubt imposed silence. His servants kidnapped children, generally boys, on his behalf, and these he tortured and murdered. The number of his victims was stated in the ecclesiastical trial to have been 140, and larger figures are quoted. The amazing impunity which he enjoyed was brought to an end in 1440, when he was imprudent enough to come into conflict with the church by an act of violence which involved sacrilege and infringement of clerical immunity. He had sold Saint Étienne de Malemort to the duke of Brittany's treasurer, Geoffroi le Ferron. In the course of a quarrel over the delivery of the property to this man's brother, Jean le Ferron, Gilles seized Jean, who was in clerical orders, in church, and imprisoned him. He then proceeded to defy the duke, but was reconciled to him by Richemont. In the autumn, however, he was arrested and cited before the bishop of Nantes on various charges, the chief of which were heresy and murder. With the latter count the ecclesiastical court was incompetent to deal, and on the 8th of October Gilles refused to accept its jurisdiction. Terrified by excommunication, however, he acknowledged the evidence of the witnesses, and by confession he secured absolution. He had been pronounced guilty of apostasy and heresy by the inquisitor, and of vice and sacrilege by the bishop. A detailed confession was extracted by the threat of torture on the 21st of October. A separate and parallel inquiry was made by Pierre de l'Hôpital, president of the Breton parliament, by whose sentence he was hanged (not burned alive as is sometimes stated), on the 26th of October 1440, with two of his accomplices. In view of his own repeated confessions it seems impossible to doubt his guilt, but the numerous irregularities of the proceedings, the fact that his necromancer Prelati and other of his chief accomplices went unpunished, taken together with the financial interest of Jean V. in his ruin, have left a certain mystery over a trial, which, with the exception of the process of Joan of Arc, was the most famous in 15th-century France. His name is connected with the tale of Bluebeard (*q.v.*) in local tradition at Machecoul, Tiffauges, Pornic and Chéméré, though the similarity between the two histories is at best vague. The records of the trial are preserved in the Bibliothèque Nationale in Paris, at Nantes and elsewhere.

See Eugène Bossard, *Gilles de Rais, dit Barbe Bleue* (2nd ed., 1886), which includes the majority of the documents of the trial published originally by De Maulde; E. A. Vizetelly, *Bluebeard* (1902); H. C. Lea, *Hist. of the Inquisition* (iii. 468, seq.); A. Molinier, *Les Sources de l'histoire de France* (No. 4185). Huysmans in *Là-bas* describes his hero as engaged on a life of Gilles de Rais, and takes the opportunity for a striking picture of the trial.

RAISIN (Fr. *raisin*, grape; Lat. *racemus*), the name given to the dried fruits of certain varieties of the grape vine, *Vitis vinifera*, which grow principally in the warm climate of the Mediterranean coasts and are comparatively rich in sugar. The use of dried grapes or raisins as food is of great antiquity (Num. vi. 3; 1 Sam. xxv. 18, xxx. 12). In medieval times raisins imported from Spain were a prized luxury in England, and to the present day Great Britain continues to be the best customer of the raisin-producing regions. "Raisins of the sun" are obtained by letting the fruit continue on the vines after it has come to maturity, where there is sufficient sunshine and heat in the autumn, till the clusters dry on the stocks. Another plan is partially to sever the stalk before the grapes are quite ripe, thus stopping the flow of the sap, and in that condition to leave them on the vines till they are sufficiently dry. The more usual process, however, is to cut off the fully ripe clusters and expose them, spread out, for several days to the rays of the sun, taking care that they are not injured by rain. In unfavourable weather they may be dried in a heated chamber, but are then inferior in quality. In some parts of Spain and France it is common to dip the gathered clusters in boiling water, or in a strong potash lye, a practice which softens the skin, favours drying and gives the raisins a clear glossy appearance. Again, in Asia Minor the fruit is dipped into hot water on the surface of which swims a layer of olive oil, which communicates a bright lustre and softness to the skin. Some superior varieties are treated with very great care, retained on their stalks, and sent into the market as clusters for table use; but the greater part are separated from the stalks in the process of drying and the stalks winnowed out of the fruit. Raisins come from numerous Mediterranean localities, and present at least three distinct varieties—(1) ordinary or large raisins, (2) sultana seedless raisins, and (3) currants or Corinthian raisins (see **CURRENT**). The greater proportion of the common large raisins of English commerce comes from the provinces of Malaga, Valencia and Alicante in Spain; these are known by the common name of Malaga raisins. Those of the finest quality, called Malaga clusters, are prepared from a variety of muscatel grape, and preserved on the stalks for table use. This variety, as well as Malaga layers, so called from the manner of packing, are exclusively used as dessert fruit. Raisins of a somewhat inferior quality, known as "lexias," from the same provinces, are used for cooking and baking purposes. Smyrna raisins also come to some extent into the English market. The best quality, known as Elemé, is a large fruit, having a reddish-yellow skin with a sweet pleasant flavour. Large-seeded dark-coloured raisins are produced in some of the islands of the Greek archipelago and in Crete, but they are little seen in the British markets. In Italy the finest raisins are produced in Calabria, inferior qualities in central Italy and in Sicily. From the Lipari Islands a certain quantity of cluster raisins of good quality is sent to England. In the south of France raisins of high excellence—Provence raisins in clusters—are obtained at Roquevaire, Lunel and Frontignan. Sultana seedless raisins are the produce of a small variety of yellow grape, cultivated exclusively in the neighbourhood of Smyrna. The vines are grown on a soil of decomposed hippurite limestone, on sloping ground rising to a height of 400 ft. above the sea, and all attempts to cultivate sultanas in other raisin-growing localities have failed, the grapes quickly reverting to a seed-bearing character. The dried fruit has a fine golden-yellow colour, with a thin, delicate, translucent skin and a sweet aromatic flavour. A very fine seedless oblong raisin of the sultana type with a brownish skin is cultivated in the neighbourhood of Damascus.

RAJA, the Hindu title for a chief, or prince, derived from the same root as the Latin *rex*. Other forms are rao, rana and rawal, while chiefs of high rank are styled maharaja, maharao and maharana. The Hindustani form is rai, and the title of the Hindu emperor of Vijayanagar in S. India was raya. It is not confined to the rulers of native states, being conferred by the British government on Hindu subjects, sometimes as an hereditary distinction. In the form of rao it appears as a suffix to the names of most Mahrattas, and to the names of Kanarese Brahmans.

RAJAHMUNDRY, or **RAJAMAHENDRI**, a town of British India, in the Godavari district of Madras. Pop. (1901) 36,408. It stands on the left bank of the river Godavari, at the head of the delta, 360 m. N. of Madras, and has a station on the East Coast railway, which is here carried across the river by a bridge of 56 spans. The government college is one of the four provincial schools established in 1853. There are also a training college and high school. Carpets, rugs and wooden wares are manufactured.

Tradition divides the merit of founding Rajahmundry between the Orissa and Chalukya princes. In 1470 it was wrested from Orissa by the Mahommedans, but early in the 16th century it was retaken by Krishna Raja. It continued under Hindu rule till 1572, when it yielded to the Moslems of the Deccan under Rafat Khan. It passed into the possession of the French in 1753, but they were driven out by the British under Colonel Forde in 1758.

RAJASTHANI (properly **RĀJASTHĀNĪ**, the language of Rājasthān of Rajputana), an Indo-Aryan vernacular closely related to Gujarati (*q.v.*). It is spoken in Rajputana and the adjoining parts of central India, and has several dialects the principal of which are Jaipurī, Mārwarī, Mēwātī and Mālvi. Hārautī, an important variety of Jaipurī, is spoken in the states of Kota and Bundi. Carey, the well-known Serampur missionary, paid great attention to Rajasthani in the early part of the 19th century, translating the New Testament into no fewer than six dialects, viz. Hārautī, Ujainī (*i.e.* Mālvi), Udaipurī (a form of Mārwarī), Mārwarī proper, Jaipurī proper and Bīkānērī (another form of Mārwarī). In 1901 the total number of speakers of Rājasthānī was 10,917,712. (G. A. Gr.)

RAJGARH, a native state of central India, in the Bhopal agency. Area, 940 sq. m. Pop. (1901) 88,376, showing a decrease of 26% in the decade, due to the results of famine. Estimated revenue, £33,000; tribute (to Sindhia), £3640. The chief, whose title is rawat, is a Rajput of the Umat clan. Grain and opium are the principal articles of trade. The town of Rajgarh, which is surrounded by a battlemented wall, had a population of 5399 in 1901.

RAJKOT, India, capital of a native state in Bombay, and headquarters of the political agent for Kathiawar. Pop. (1901) 36,151. It is situated in the middle of the peninsula of Kathiawar, and is the centre of the railway system. There is a military cantonment. The Rajkumar college, for the education of the sons of chiefs on the lines of an English public school, has achieved great success. Besides the high school there are training colleges for masters and mistresses. The Rasulkhanji hospital has a department for women, opened in 1897. All these institutions are maintained at the joint expense of the chiefs of Kathiawar. The state of Rajkot, which is a branch of Nawanagar, has an area of 282 sq. m. Pop. (1901) 49,795. Estimated revenue, £20,000.

RAJMAHAL, a former capital of Bengal, India, now a village in the district of the Santal Parganas, situated on the right bank of the Ganges, where that river makes a turn to the south. Pop. (1901) 2047. It was chosen for his residence by Man Singh, Akbar's Rajput general in 1592, but the capital of the province was shortly afterwards transferred to Dacca. It contains many palaces and mosques, now in ruins and overgrown with jungle. It has a station on the loop line of the East Indian railway, but trade has declined since the Ganges abandoned its old bed; and Sahibganj has taken its place. Rajmahal has given its name to a range of hills, almost the only hills in

Bengal proper, which here come down close to the bank of the Ganges. They cover a total area of 1366 sq. m., and their height never exceeds 2000 ft. They are inhabited by an aboriginal race, known as Paharias or "hill-men," of whom two tribes may be distinguished: the Male Sauria Paharias and the Mal Paharias; total pop. (1901) 73,000. The former, if not the latter also, are closely akin to the larger tribe of Oraons. Their language, known as Malto, of the Dravidian family, was spoken by 60,777 persons in 1901. The Paharias have contributed an element to the administrative history of Bengal. Augustus Cleveland, a civilian who died in 1784 and whose name is still honoured, was the first who succeeded in winning their confidence and recruiting among them a corps of hill-rangers. The methods that he adopted are the foundation of the "non-regulation" system, established in 1796; and the hills were exempted from the permanent settlement. The Santals, a different aboriginal race, have since immigrated in large numbers into the Daman-i-koh, or "skirts of the hills"; but the Paharias alone occupy the plateaux on the top, where they are permitted to practise the privilege of shifting cultivation, which renders scientific forestry impossible. The approach from the plains below to each plateau is guarded by a steep ladder of boulders.

See E. W. Dalton, *Descriptive Ethnology of Bengal* (Calcutta, 1872); F. B. Bradley-Birt, *The Story of an Indian Upland* (1905).

RAJPIPLA, a native state of India, in the Rewa Kantha agency, Bombay, occupying a hilly tract between the rivers Nerbudda and Tapti; area, 1517 sq. m. Pop. (1901) 117,175, showing a decrease of 32% in the decade, due to the results of famine; estimated revenue, £60,000; tribute (to the Gaekwar of Baroda), £3000. The chief, whose title is maharana, is a Gohel Rajput, of the same family as the thakor saheb of Bhavnagar. A light railway, constructed at the cost of the state, connects Nandod with Anklesvar in Broach district. The old fort of Rajpipla, in the hills, is now deserted. The modern capital is Nandod, situated on the river Karjan, 32 m. from Surat. Pop. (1901) 11,236.

RAJPUT, a race of India, not confined to Rajputana, but spread over the N. of the country. According to the census of 1901 there were 9,712,156 Rajputs in all India, of whom only 620,229 lived in Rajputana. The great majority adhere to the Hindu religion, but 1,875,387 are entered as Mahommedans. The Rajputs form the fighting, landowning and ruling caste. They claim to be the modern representatives of the Kshatriyas of ancient tradition; but their early history is obscure, and recent research supports the view that they include descendants of more than one wave of immigrant invaders. Linguistic evidence supports tradition in proving that their unity was broken up by the Mahommedan conquest, for the inhabitants of the Himalayan valleys still speak a language akin to those of Rajputana proper, though separated from them by the wide Gangetic valley.

The Rajputs are fine, brave men, and retain the feudal instinct strongly developed. Pride of blood is their chief characteristic, and they are most punctilious on all points of etiquette. The tradition of common ancestry permits a poor Rajput yeoman to consider himself as well born as any powerful landholder of his clan, and superior to any high official of the professional classes. No race in India can boast of finer feats of arms or brighter deeds of chivalry, and they form one of the main recruiting fields for the Indian army of to-day. They consider any occupation other than that of arms or government derogatory to their dignity, and consequently during the long period of peace which has followed the establishment of the British rule in India they have been content to stay idle at home instead of taking up any of the other professions in which they might have come to the front. Those who are not zamindars have, therefore, rather dropped behind in the modern struggle for existence. As cultivators they are lazy and indifferent, and they prefer pastoral to agricultural pursuits. Looking upon all manual labour as humiliating, none but the poorest class of Rajput will himself hold the plough.

Within the limits of Rajputana the Rajputs form a vast body of kindred, and any Rajput can marry any Rajput woman who does not belong to his own clan. The most numerous of the clans is the Rahtor, to which the chiefs of Marwar, Bikanir and Kishangarh belong. Its strength in 1901 was 122,160. Next comes the Kachwaha clan, which is strong in Jaipur and Alwar, both chiefs belonging to its members. It numbers 100,186. The Chauhan follows with an aggregate of 86,460, among whom are the chiefs of Bundi, Kotah and Sirohi. The Jadu or Jadon, which includes in its ranks the chiefs of Karauli and Jaisalmer, numbers 74,666. The Sisodhyias, who include the ancient and illustrious house of Udaipur, number 51,366. The Ponwar clan, to which Vikramaditya, the celebrated king of Ujjain, from whom the Hindu Era is named, is said to have belonged, numbers 43,435. The Solanki and Parihar clans, once powerful, are now only 18,949 and 9448 respectively.

RAJPUTANA, a collection of native states in India, under the political charge of an agent to the governor-general, who resides at Abu in the Aravalli Hills. It lies between 23° and 30° N. and between 69° 30' and 75° 15' E., and includes 18 states and 2 estates or chiefships. For political purposes these are subdivided into eight subordinate groups, consisting of three residencies and five agencies. These are as follow: (1) Mewar residency, with headquarters at Udaipur, comprising the states of Udaipur (Mewar), Dungarpur, Partabgarh and Banswara; (2) Jaipur residency, with headquarters at Jaipur, comprising the states of Jaipur and Kishangarh, with the estate of Lawa; (3) Western Rajputana states residency, with headquarters at Jodhpur, comprising the states of Jodhpur, Jaisalmer and Sirohi; (4) Bikanir agency, with headquarters at Bikanir; (5) Alwar agency, with headquarters at Alwar; (6) Eastern Rajputana states agency, with headquarters at Bharatpur, comprising the states of Bharatpur, Dholpur, and Karauli; (7) Haraoti-Tonk agency, with headquarters at Deoli, comprising the states of Tonk and Bundi, with the estate of Shal-pura; (8) Kotah-Jhalawar agency, with headquarters at Kotah, comprising the states of Kotah and Jhalawar. All of these states are under Rajput rulers, except Tonk, which is Mahomedan, and Bharatpur and Dholpur, which are Jat. The small British province of Ajmere-Merwara is also included within the geographical area of Rajputana.

Physical Features.—The total area of Rajputana is about 127,541 sq. m. It is bounded on the west by Sind, and on the north-west by the Punjab state of Bahawalpur. Thence its northern and north-eastern frontier marches with the Punjab and the United Provinces until it touches the river Chambal, where it turns south-eastward for about 200 m., dividing the states of Dholpur, Karauli, Jaipur and Kotah from Gwalior. The southern boundary runs in a very irregular line across the central region of India, dividing the Rajputana states from a number of native states in Central India and Gujarat. The most striking physical feature is the Aravalli range of mountains, which intersects the country almost from end to end in a line running from south-west to north-east. Mount Abu is at the south-western extremity of the range, and the north-eastern end may be said to terminate near Khetri in the Shaikhawati district of Jaipur, although a series of broken ridges is continued in the direction of Delhi. About three-fifths of Rajputana lies north-west of the range, leaving two-fifths on the east and south. The tract lying to the north-west contains the states of Bikanir, Jaisalmer and Jodhpur. With the exception of the sub-montane districts of Jodhpur, which lie immediately below the Aravallis, this division is sandy, ill-watered and unproductive, improving gradually from a desert in the north-west and west to comparatively fertile land on the east. The country to the east and south-east of the Aravallis affords a striking contrast to the sandy plains on the north-west of the range, and is blessed with fertile lands, hill-ranges and long stretches of forest, where fuel and fodder are abundant.

The chief rivers of Rajputana are the Luni, the Chambal and the Banas. The first of these, the only river of any consequence in the north-western division, flows for 200 m. from the Pushkar valley, close to Ajmere, to the Rann of Cutch. In the south-eastern division the river system is important. The Chambal is by far the largest river in Rajputana, through which it flows for about one-third of its course, while it forms its boundary for another third. The source of the river is in the highlands of the Vindhya, upwards of 2000 ft. above the sea; it soon becomes a considerable stream, collecting in its course the waters of other rivers, and finally discharging itself into the Jumna after a course of 560 m. Next in importance ranks the Banas, which rises in the south-west near

Kankroli in Udaipur. It collects nearly all the drainage of the Udaipur plateau with that of the eastern slopes and hill-tracts of the Aravallis, and joins the Chambal a little beyond the north-eastern extremity of the Bundi state, after a course of about 300 m. Other rivers are the W. Banas and the Sabarmati, which rise among the south-west hills of Udaipur and take a south-westerly course. The river Mahi, which passes through the states of Partabgarh and Banswara, receiving the Som, drains the south-west corner of Rajputana through Gujarat into the Gulf of Cambay. Rajputana possesses no natural freshwater lakes, but there are several important artificial lakes, all of which have been constructed with the object of storing water. The only basin of any extent is the Sambhar salt lake, of about 50 m. in circuit.

Geology.—Geologically considered, the country may be divided into three regions—a central, and the largest, comprising the whole width of the Aravalli system, formed of very old sub-metamorphic and gneissic rocks; an eastern region, with sharply defined boundary, along which the most ancient formations are abruptly replaced by the great basin of the Vindhyan strata, or are overlaid by the still more extensive spread of the Deccan trap, forming the plateau of Malwa; and a western region, of very ill-defined margin, in which, besides some rocks of undetermined age, it is more or less known or suspected that Tertiary and Secondary strata stretch across from Sind, beneath the sands of the desert, towards the flanks of the Aravallis. Rajputana produces a variety of metals. Ore of cobalt is obtained in no other locality in India, and although zinc blende has been found elsewhere it is known to have been extracted only in this province. Copper and lead are found in several parts of the Aravalli range and of the minor ridges in Alwar and Shaikhawati, and iron ores abound in several states. Alum and blue vitriol (sulphate of copper) are manufactured from decomposed schists at Khetri in Shaikhawati. Good building materials are obtained from many of the rocks of the country, among which the Raialo limestone (a fine-grained crystalline marble) and the Jaisalmer limestone stand pre-eminent.

Climate.—The climate throughout Rajputana is very dry and hot during the summer; while in the winter it is much colder in the north than in the lower districts, with hard frost and ice on the Bikanir borders. The rainfall is very unequally distributed: in the western part, which comes near to the limits of the rainless region of Asia, it is very scanty, and scarcely averages more than 5 in.; in the south-west the fall is more copious, sometimes exceeding 100 in. at Abu; but, except in the south-west highlands of the Aravallis, rain is most abundant in the south-east. Notwithstanding all its drawbacks, Rajputana is reckoned one of the healthiest countries in India, at least for the native inhabitants.

Population.—In 1901 the population was 9,723,301, showing a decrease of 20% in the decade owing to the great famines of 1897–1898 and 1900–1901. The greatest mortality was caused by virulent malarial fever, which raged during the autumn months of 1900 and the early months of 1901. Epidemics of cholera, which occurred during the years of scarcity and famine, also swept away large numbers.

It is commonly supposed that, because nearly the whole country is ruled by Rajputs, therefore the population consists mainly of Rajput tribes; but these are merely the dominant race, and the territory is called Rajputana because it is politically possessed by Rajputs. The whole number of this race is 620,229, and nowhere do they form a majority of the whole population in a state; but they are strongest, numerically, in the northern states and in Udaipur. By rigid precedence the Brahmans occupy the first rank; they are numerous and influential, and with them may be classed the peculiar and important caste of Bhats, the keepers of secular tradition and of the genealogies. Next come the mercantile castes, mostly belonging to the Jain sect; these are followed by the powerful cultivating tribes, such as the Jats and Gujars, and then come the so-called aboriginal tribes, chief of whom are the Minas, Bhils and Meos. Rajasthani is the chief language of the country, one or other of its dialects being spoken by 7,035,093 persons or more than 72% of the total population. The gross revenue of all the states is estimated at 2½ millions sterling.

The mass of the people are occupied in agriculture. In the large towns banking and commerce flourish to a degree beyond what might be expected. In the north the staple products for export are salt, grain, wool and cotton, in the south opium and cotton; while the imports consist of sugar, hardware and piece goods. Rajputana is very poor in industrial production. The principal manufactures are cotton and woollen goods, carvings in ivory and working in metals, &c., all of which handicrafts are chiefly carried on in the eastern states. The system of agriculture is

very simple; in the country west of the Aravallis only one crop is raised in the year, while in other parts south and east of the Aravallis two crops are raised annually, and various kinds of cereals, pulses and fibres are grown. In the desert tracts fine breeds of camels, cattle, horses and sheep are to be found wherever there is pasturage. Irrigation, mostly from wells, is almost confined to the N. portion. The country is traversed throughout by the Rajputana railway, with its Malwa branch in the south, and diverging to Agra and Delhi in the north. Jodhpur, Udaipur and Bikanir have constructed branch railways at their own cost, the first of which was extended in 1901 to Hyderabad in Sind. In 1909 another line was opened running N. near the E. boundary from Kotah to Bharatpur.

History.—Only faint outlines can be traced of the condition of Rajputana previous to the invasion of Upper India by the Mahomedans, and these indicate that the country was subject for the most part to two or three powerful tribal dynasties. Chief of these were the Rahtors, who ruled at Kanauj; the Chauhans of Ajmere; the Solankis of Anhilwara, in Gujarat; the Gehlots with the Sisodhyias sept, still in Mewar or Udaipur; and the Kachwaha clan, still in Jaipur. These tribal dynasties of Rajputs were gradually supplanted by the Moslem invaders of the 11th century and weakened by internal feuds. At the beginning of the 16th century the Rajput power began to revive, only to be overthrown by Baber at Fatehpur Sikri in 1527. The clans were finally either conquered, overawed or conciliated by Akbar—all except the distant Sisodhya clan, which, however, submitted to Jehangir in 1616. From Akbar's accession to Aurangzeb's death, a period of 151 years, the Mogul was India's master. Aurangzeb's death and the invasion of Nadir Shah led to a triple alliance among the three leading chiefs, which internal jealousy so weakened that the Mahrattas, having been called in by the Rahtors to aid them, took possession of Ajmere about 1756; thenceforward Rajputana became involved in the general disorganization of India. By the end of the century nearly the whole of Rajputana had been virtually subdued by the Mahrattas. The victories of Generals Wellesley and Lake, however, saved the Rajputs; but on Lord Wellesley's departure from India the floodgates of anarchy were reopened for ten years. On the outbreak of the Pindari War in 1817 the British government offered its protection. The Pindaris were put down, Amir Khan submitting and signing a treaty which constituted him the first ruler of the existing state of Tonk. By the end of 1818 similar treaties had been executed by the other Rajput states with the paramount power. Sindhia gave up the district of Ajmere to the British, and the pressure of the great Mahratta powers upon Rajputana was permanently withdrawn. Since then the political history of Rajputana has been comparatively uneventful. The great storm of the Mutiny of 1857, though dangerous while it lasted, was short. Most of the rajas remained loyal; and the capture of the town of Kotah, which had been held by the mutineers of that state, in March 1858, marked the extinction of armed rebellion.

Rajputana is of great archaeological interest, possessing some fine religious buildings in ruins and others in excellent preservation. Among the latter are the mosques at Ajmere and the temples on Abu. But the most characteristic features of architecture in the country are shown in the forts and palaces of the chiefs and in their cenotaphs.

See J. Tod, *Annals and Antiquities of Rajasthan* (1829, 1832); W. W. Webb, *Currencies of the Hindu States of Rajputana* (1893); *Chiefs and Leading Families of Rajputana* (1903); and *Rajputana Gazetteer* (Calcutta, 1908).

RAJSHAHI, a district and division of British India, in the province of Eastern Bengal and Assam. The administrative headquarters are at Rampur Boalia. The area of the district is 2503 sq. m., comprising an alluvial plain seamed with old river-beds and studded with marshes. The Ganges and the Mahananda are its principal rivers; the former constitutes a great natural boundary-line to the south and south-west, and the latter, which rises in the Himalayas, borders the district on the west for a few miles before joining the Ganges. Other

rivers are the Narad and Baral, important offshoots of the Ganges; the Atrai, a channel of the Tista; and the Jamuna, a tributary of the Atrai. Both the Atrai and the Jamuna belong to the Brahmaputra system and are navigable throughout the year for small cargo boats. The drainage of Rajshahi is not carried off by means of its rivers, but through the chains of marshes and swamps, the most important of which is the Chalan *bhil* or lake, which discharges itself into the Brahmaputra. In 1901 the population was 1,462,407, showing an increase of 1.6% in the decade. Rice is the staple crop, with pulses, oilseeds and jute. Indigo has disappeared. Sericulture has received a stimulus from the efforts of the agricultural department, supported by private enterprise, to improve the breed of silkworms. The hemp grown on a small tract in the north of the district supplies all the *ganja* that is consumed in Bengal. The district is traversed from south to north by the main line of the Eastern Bengal railway to Darjeeling, with a branch to Bogra. Most of the permanent buildings in the district were severely damaged by the earthquake of the 12th of June 1897. When the East India Company took over the administration of Bengal in 1765, the *zamindari* of Rajshahi or Nattor was one of the largest and most important in the province. It appears to have extended from Bhagalpur on the west to Dacca on the east, and to have included an important subdivision called Nij-Chakla Rajshahi on the south of the Ganges. The total area was estimated at 13,000 sq. m., or more than five times the size of the present district. Having been found much too large to be effectually administered by one central authority, Rajshahi was stripped in 1793 of a considerable portion of its outlying territory, and a natural boundary-line was drawn to the west, south and east along the Ganges and Brahmaputra. Its north-western limits were reduced in 1813, when the present district of Malda was constituted. The erection of Bogra into a separate jurisdiction in 1821 still further reduced its area; and in 1832 the limits of Rajshahi were fixed by the constitution of Pabna into an independent jurisdiction.

The DIVISION OF RAJSHAHI is coextensive with northern Bengal, from the Ganges to the mountains. It comprises the seven districts of Rajshahi, Dinajpur, Jalpaiguri, Malda, Rangpur, Bogra and Pabna. Total area, 18,091 sq. m. Pop. (1901) 9,130,072.

RAKE (O.E. *raca*, cognate with Du. *raak*, Ger. *Rechen*, from a root meaning to scrape together, heap up), an agricultural and horticultural implement consisting of a toothed bar fixed transversely to a handle, and used for the collection of cut hay, grass, &c., and, in gardening, for loosening the soil, light weeding and levelling, and generally for purposes performed in agriculture by the harrow. The teeth of the hand-rake are of wood or iron. For the horse-drawn rake, a bar with long curved steel teeth is mounted on wheels (see HAY AND HAYMAKING). The word "rake" has been used since the 17th century in the sense of a man of a dissolute or dissipated character. This is a shortened form of the earlier "rake-hell," apparently in common use in the 16th century. In military and naval use "to rake" means to enfilade, to fire so that the shot may pass lengthwise along a ship, a line of soldiers, entrenchments, &c. In the nautical sense of the projection or slope of a ship's bows or stern or the inclination of a mast, the word is apparently an adaptation of the Scandinavian *raka*, to reach, in the sense of reach forward.

RÁKÓCZY, the name of a noble Hungarian family, which in the 10th century was settled in the county of Zemplén, and members of which played an important part in the history of Hungary during the 17th century.

GEORGE I., prince of Transylvania (1501-1648), who began his career as governor of Onod, was the youngest son of Sigismund Rákóczy (1544-1608), who shared in the insurrection of Stephen Bocskay against the Emperor Rudolph II., and was for a short time prince of Transylvania. In 1616 he married his second wife, the highly gifted zealous Calvinist, Susannah Lorántffy, who exercised a great influence over him. He then took a leading part in the rebellion of Gabriel Bethlen, who

made him commandant of Kassa, and was elected prince of Transylvania on the 26th of November 1630 by the diet of Segesvár. He followed the policy of Gabriel Bethlen, based on the maintenance of the political and religious liberties of the Hungarians. His alliance with Gustavus Adolphus of Sweden for that purpose was no secret at Vienna, where the court estimated at their right value Rákóczy's hypocritical assurances of pacific amity. On the 2nd of February 1644, at the solicitation of the Swedish and French ambassadors, and with the consent of the Porte, he declared war against the Emperor Ferdinand III. Nearly the whole of imperial Hungary was soon in his hands, and Ferdinand, hardly pressed by the Swedes at the same time, was compelled to conclude (Sept. 16, 1645) with Rákóczy the peace of Linz, which accorded full religious liberty to the Magyars, and ceded to Rákóczy the fortress of Regéc and the Tokaj district. On the death of Wladislaus IV. (1648) Rákóczy aimed at the Polish throne also, but died before he could accomplish his design. His capital, Gyula Fehérvár, was a great Protestant resort and asylum.

See *Secret Correspondence of the Age of George Rákóczy I.* (Hung.), ed. Agoston Ötvös (Klausenburg, 1848); *Rákóczy's Correspondence with Pázmány, Esterházy, &c.* (Hung.), ed. Antal Beke (Budapest, 1882); Sándor Szilagyi, *The Rákóczy Family in the 18th Century* (Hung.) (Pest, 1861).

GEORGE II., prince of Transylvania (1621-1660), was the eldest son of George I. and Susannah Lorántffy. He was elected prince of Transylvania during his father's lifetime (Feb. 19, 1642), and married (Feb. 3, 1643), Sophia Báthory, who was previously compelled by his mother to reject the Roman faith and turn Calvinist. On ascending the throne (Oct. 11, 1648), his first thought was to realize his father's Polish ambitions. With this object in view, he allied himself, in the beginning of 1649, with the Cossack hetman, Bohdan Chmielnicki, and the hospodars of Moldavia and Wallachia. It was not, however, till 1657, as the ally of Gustavus Adolphus, that he led a rabble of 40,000 semi-savages against the Polish king, John Casimir. He took Cracow and entered Warsaw with the Swedes, but the moment his allies withdrew the whole scheme collapsed, and it was only on the most humiliating terms that the Poles finally allowed him to return to Transylvania. Here (Nov. 3, 1657) the diet, at the command of the Porte, deposed him for undertaking an unauthorized war, but in January 1658 he was reinstated by the Medgyes Diet. Again he was deposed by the grand vizier, and again reinstated as if nothing had happened, but all in vain. The Turks again invaded Transylvania, and Rákóczy died at Nagyvárad of the wounds received at the battle of Gyula (May 1660).

See Imre Bethlen, *Life and Times of George Rákóczy II.* (Hung.) (Nagy-Enyed, 1829); *Life* (Hung.) in Sándor Szilagyi's *Hungarian Historical Biographies* (Budapest, 1891).

FRANCIS I., prince of Transylvania (1645-1676), was the only son of George Rákóczy II. and Sophia Báthory. He was elected prince of Transylvania during his father's lifetime (Feb. 18, 1652), but lost both crown and father at the same time, and withdrew to the family estates, where, at Patak and Makovica, he kept a splendid court. His mother converted him to Catholicism, and on the 1st of March 1666 he married Helen Zrinyi. In 1670 he was implicated in the Zrinyi-Frangepán conspiracy, and only saved his life by the interposition of the Jesuits on the payment of an enormous ransom.

See Sándor Szilagyi, *The Rákóczy Family in the 17th Century* (Hung.) (Pest, 1861).

FRANCIS II., prince of Transylvania (1676-1735), was born at Borsi, Zemplén county, on the 27th of March 1676. Having lost his father during infancy, he was educated under the guardianship of his heroic mother, Helen Zrinyi, in an ultra-patriotic Magyar environment, though the Emperor Leopold I. claimed a share in his tutelage. In 1682 his mother wedded Imre Thököly, who took no part in the education of Rákóczy, but used him for his political purposes. Unfortunately his stepfather's speculations suffered shipwreck, and Rákóczy lost the greater part of his estates. It is said that the imperialists

robbed him of 1,000,000 florins' worth of plate and supported a whole army corps out of his revenues (1683-85). As a child of twelve he witnessed the heroic defence by his mother of his ancestral castle of Munkács against Count Antonio Caraffa (d. 1693). On its surrender (Jan. 7, 1688) the child was transferred to Vienna that he might be isolated from the Hungarian nation and brought up as an Austrian magnate. Cardinal Kollonics, the sworn enemy of Magyar separatism, now became his governor, and sent him to the Jesuit college at Neuhaus in Bohemia. In 1690 he completed his course at Prague, and in 1694 he married Maria Amelia of Hesse-Rheinfels, and lived for the next few years on his Hungarian estates. At this time Rákóczy's birth, rank, wealth and brilliant qualities made him the natural leader of the Magyar nation, and his name was freely used in all the insurrections of the period, though at first he led a life of the utmost circumspection (1697-1700). Hungary was then regarded at Vienna as a conquered realm, whose naturally rebellious inhabitants could only be kept under by force of arms. Kollonics was the supreme ruler of the kingdom, and his motto was "Make of the Magyar first a slave, then a beggar, and then a Catholic." It was a matter of life or death for the Magyars to resist such a reign of terror and save the national independence by making Hungary independent of Austria as heretofore. Rákóczy and a few other patriotic magnates deeply sympathized with the sufferings of the nation, and on the eve of the war of the Spanish Succession they entered into correspondence with Louis XIV. for assistance through one Longueval, a Belgian general in the Austrian service, who professed to be a friend of the Rákóczyans, who initiated him into all their secrets. Longueval betrayed his trust, and Rákóczy was arrested and imprisoned at Eperjes. His wife saved him from certain death by enabling him to escape to Poland in the uniform of a dragoon officer. On the 18th of June 1703 he openly took up arms against the emperor, most of whose troops were now either on the Rhine or in upper Italy; but, unfortunately, the Magyar gentry stood aloof from the rising, and his ill-supported peasant levies (the Kuruczes) were repeatedly scattered. Yet at first he had some success, and on the 26th of September was able to write to Louis XIV. that the whole kingdom up to the Danube was in his power. He also issued his famous manifesto, *Recrudescunt vulnera inclytæ gentis Hungariæ*, to justify himself in the eyes of Europe. The battle of Blenheim made any direct help from France impossible, and on the 13th of June 1704 his little army of 7000 men was routed by the imperialists at Koronco and subsequently at Nagyszombat. Want of arms, money, native officers and infantry, made, indeed, any permanent success in the open field impossible. Nevertheless, in May 1705, when the Emperor Leopold I. was succeeded by Joseph I., the position of Rákóczy was at least respectable. With the aid of several eminent French officers and engineers he had drilled his army into some degree of efficiency, and had at his disposal 52 horse and 31 foot regiments. Even after the rout of Pudmeric (Aug. 11, 1705), he could put 100,000 men in the field. In September 1705 he was also able to hold a diet at Szécsény, attended by many nobles and some prelates, to settle the government of the country.

Rákóczy, who had already been elected Prince of Transylvania (July 6, 1704), now surrounded himself with a council of state of 24 members. The religious question caused him especial difficulty. An ardent Catholic himself, nine-tenths of his followers were nevertheless stern Calvinists, and in his efforts to secure them toleration he alienated the pope, who dissuaded Louis XIV. from assisting him. Peace negotiations with the emperor during 1705 came to nothing, because the court of Vienna would not acknowledge the independence of Transylvania, while France refused to recognize the rebels officially till they had formally proclaimed the deposition of the Habsburgs, which last desperate measure was actually accomplished by the Ónod diet on the 13th of June 1707. This was a fatal mistake, for it put an end to any hope of a compromise, and alienated both the emperor's foreign allies and the

majority of the Magyar gentry, while from Louis XIV. Rákóczy only got 100,000 thalers, the Golden Fleece, and a promise (never kept) that the Hungarians should be included in the general peace. But into a direct alliance with Rákóczy the French king would not enter, and Laszlo Vetési, Rákóczy's envoy at Versailles, in 1708 advised his master to place no further reliance on the French court. Shortly afterwards, at Trencsen (Aug 3, 1708), Rákóczy's army was scattered to the winds. The rout of Trencsen was followed by a general abandonment. The remnant of the host, too, was now thoroughly demoralized and dared not face the imperialists. A fresh attempt to renew the war in 1710 was speedily ruined by the disaster of Romhány (Jan. 22), and a desperate effort to secure the help of Peter the Great also failing, Rákóczy gave up everything for lost, and on the 21st of February 1711 quitted his country for ever, refusing to accept the general amnesty conceded after the peace of Szatmár (see HUNGARY, *History*). He lived for a time in France on the bounty of Louis XIV., finally entering the Carmelite Order. In 1717, with forty comrades, he volunteered to assist the Turks against the Austrians, but on arriving at Constantinople discovered there was nothing for him to do. He lived for the rest of his life at the little town of Rodostó, where he died on the 8th of April 1735. His remains were solemnly transferred to Hungary in 1907 at the expense of the state.

See *Autobiography of Prince Francis Rákóczy* (Hung.) (Miskolcz, 1903); E. Jurkovich, *The Liberation Wars of Prince Francis Rákóczy* (Hung.) (Besztercebánya, 1903); S. Endródi, *Kurucz Notes, 1700-1720* (Hung.) (Budapest, 1897). (R. N. B.)

RALEIGH, SIR WALTER (c. 1552-1618), British explorer, poet and historian, was born probably in 1552, though the date is not quite certain. His father, Walter Raleigh of Fardell, in the parish of Cornwood, near Plymouth, was a country gentleman of old family, but of reduced estate. Walter Raleigh the elder was three times married. His famous son was the child of his third marriage with Catherine, daughter of Sir Philip Champernown of Modbury, and widow of Otho Gilbert of Compton. By her first marriage she had three sons, John, Humphrey and Adrian Gilbert. Mr. Raleigh had been compelled to give up living in his own house of Fardell. His son was born at the farmhouse of Hayes near the head of Budleigh Salterton Bay, on the coast of Devonshire between Exmouth and Sidmouth. The name is written with a diversity exceptional even in that age. Sir Walter, his father, and a half-brother used different forms. The spelling Raleigh was adopted by Sir Walter's widow, and has been commonly used, though there has been a tendency to prefer "Ralegh" in recent times. It was almost certainly pronounced "Rawley."

In 1568 he was entered as a commoner of Oriol College, Oxford, but he took no degree, and his residence was brief. In 1569 he followed his cousin Henry Champernown, who took over a body of English volunteers to serve with the French Huguenots. From a reference in his *History of the World* it has been supposed that he was present at the battle of Jarnac (13th of March 1569), and it has been asserted that he was in Paris during the Massacre of St Bartholomew in 1572. Nothing, however, is known with certainty of his life till February 1575, when he was resident in the Temple. During his trial in 1603 he declared that he had never studied the law, but that his breeding had been "wholly gentleman, wholly soldier." In June 1578 his half-brother Sir Humphrey Gilbert obtained a patent for six years authorizing him to take possession of "any remote barbarous and heathen lands not possessed by any Christian prince or people." The gentry of Devon had been much engaged in maritime adventure of a privateering or even piratical character since the reign of Henry VIII. In the reign of Elizabeth they were the leaders in colonial enterprises in conflict with the Spaniards in America. During 1578 Humphrey Gilbert led an expedition which was a piratical venture against the Spaniards, and was driven back after an action with them and the loss of a ship in the Atlantic. Raleigh accompanied his half-brother as captain of the "Falcon," and was perhaps with him in an equally unsuccessful voyage of

the following year. Gilbert was impoverished by his ventures, and Raleigh had to seek his fortune about the court. In the course of 1580 he was twice arrested for duels, and he attached himself to the queen's favourite, the earl of Leicester, and to the earl of Oxford, son-in-law of Burghley, for whom he carried a challenge to Sir Philip Sidney. By the end of 1580 he was serving as captain of a company of foot in Munster. He took an active part in suppressing the rebellion of the Desmonds, and in the massacre of the Spanish and Italian adventurers at Smerwick in November. His letters prove that he was the advocate of a ruthless policy against the Irish, and did not hesitate to recommend assassination as a means of getting rid of their leaders.

In December 1581 he was sent home with despatches, as his company had been disbanded on the suppression of the Desmonds. His great fortune dates from his arrival at court where he was already not unknown. Raleigh had been in correspondence with Walsingham for some time. The romantic stories told by Sir Robert Naunton in the *Fragmenta Regalia*, and by Fuller in his *Worthies*, represent at least the mythical truth as to his rise into favour. It is quite possible that Raleigh, at a time when his court clothes represented "a considerable part of his estate," did (as the old story says) throw his mantle on the ground to help the queen to walk dry-shod over a puddle, and that he scribbled verses with a diamond on a pane of glass to attract her attention, though we only have the gossip of a later generation for our authority. It is certain that his tall and handsome person, his caressing manners and his quick wit pleased the queen. The rewards showered on him were out of all proportion to his services in Ireland, which had not been more distinguished than those of many others. In March 1582 he was granted a reward of £100, and the command of a company, nominally that he might be exercised in the wars, but in reality as a form of pension, since he was allowed to discharge his office by deputy and remained at court. In February 1583 he was included in the escort sent to accompany the duke of Anjou from England to Flanders. In 1583 the queen made him a grant of Durham House in the Strand (London), the property of the see of Durham, which had however been used of late as a royal guest-house. In the same year the queen's influence secured him two beneficial leases from All Souls, Oxford, which he sold to his advantage, and a patent to grant licences to "vintners,"—that is, tavern keepers. This he subleased, and when his agent, one Browne, cheated him, he got the grant revoked, and reissued on terms which allowed him to make £2000 a year. In 1584 he had a licence for exporting woollen cloths, a lucrative monopoly which made him very unpopular with the merchants. He was knighted in 1584. In 1585 he succeeded the earl of Bedford as Warden of the Stannaries. Raleigh made a good use of the great powers which the wardenship gave him in the mining districts of the west. He reduced the old customs to order, and showed himself fair to the workers. In 1586 he received a grant of 40,000 acres of the forfeited lands of the Desmonds, on the Blackwater in Ireland. He was to plant English settlers, which he endeavoured to do, and he introduced the cultivation of the potato and of tobacco. In 1587 he received a grant in England of part of the forfeited land of the conspirator Babington.

During these years Raleigh was at the height of his favour. It was the policy of Queen Elizabeth to have several favourites at once, lest any one might be supposed to have exclusive influence with her. Raleigh was predominant during the period between the predominance of Leicester and the rise of the earl of Essex, who came to court in 1587. It is to be noted that Elizabeth treated Raleigh exclusively as a court favourite, to be enriched by monopolies and grants at the expense of her subjects, but that she never gave him any great office, nor did she admit him to the council. Even his post of captain of the Guard, given in 1587, though honourable, and, to a man who would take gifts for the use of his influence, lucrative, was mainly ornamental. His many offices and estates did not monopolize the activity of Raleigh. The patent given to his half-brother Sir Humphrey Gilbert was to run out in 1584. To

avert this loss Raleigh, partly out of his own pocket and partly by securing the help of courtiers and capitalists, provided the means for the expedition to Newfoundland in 1583, in which Gilbert, who had been reduced to sell "the clothes off his wife's back" by his previous misfortunes, finally perished. Sir Humphrey's patent was renewed in favour of Sir Walter in March 1584.

Raleigh now began the short series of ventures in colonization which have connected his name with the settlement of Virginia. It has often been said that Raleigh showed a wise originality in his ideas as to colonization. But in truth the patent granted to him, which gave him and his heirs the proprietary right over all territory they occupied subject to payment of one-fifth of the produce of all mines of precious metals to the crown, is drawn closely on Spanish precedents. Nor was there any originality in his desire to settle English colonists, and encourage other industries than mining. The Spaniards had pursued the same aim from the first. In April 1584 Raleigh sent out two captains, Philip Amadas and Arthur Barlowe, on a voyage of exploration. They sailed by the Canaries to Florida, and from thence followed the coast of North America as far as the inlet between Albemarle and Pamlico sounds in the modern state of North Carolina. The name of Virginia was given to a vast and undefined territory, but none of Raleigh's captains or settlers reached the state of Virginia. In the same year he became member of parliament for Devonshire, and took the precaution to secure a parliamentary confirmation of his grant. His first body of settlers, sent out in 1585 under Sir Richard Grenville, landed on what is now Roanoke Island in North Carolina. Sir R. Grenville showed himself mainly intent on taking prizes, going and coming. The settlers got on bad terms with the natives, despaired, and deserted the colony when Sir Francis Drake visited the coast in 1586. Attempts at colonization at the same place in 1586 and 1587 proved no more successful (see NORTH CAROLINA), and in 1589 Raleigh, who represented himself as having spent £40,000 on the venture, resigned his rights to a company of merchants, preserving to himself a rent, and a fifth of whatever gold might be discovered.

After 1587 Sir Walter Raleigh was called upon to fight for his place of favourite with the earl of Essex (see ESSEX, 2ND EARL OF). During the Armada year 1588 he was more or less in eclipse. He was in Ireland for part of the year with Sir R. Grenville, and was employed as vice-admiral of Devon in looking after the coast-defences and militia levy of the county. During this year he received a challenge from Essex which did not lead to an encounter. In 1589 he was again in Ireland. He had already made the acquaintance of Edmund Spenser and now visited him at his house at Kilcolman. It was by Raleigh's help that Spenser obtained a pension, and royal aid to publish the first three books of the *Faerie Queen*. The exact cause of Raleigh's partial disgrace at court is not known, but it was probably due to the queen's habitual policy of checking one favourite by the promotion of another. In 1589 he accompanied the expedition to the coast of Portugal, which was intended to cause a revolt against King Philip II., but failed completely. In 1591 he was at the last moment forbidden to take part in the voyage to the Azores, and was replaced by his cousin Sir R. Grenville, whose death in action with the Spaniards was the subject of one of Sir Walter's most vigorous pieces of prose writing. In 1592 he was again at sea with an expedition to intercept the Spanish trade, but was recalled by the queen. The cause of his recall was the discovery that he had seduced one of her maids of honour, Elizabeth Throgmorton. Raleigh denied in a letter to Robert Cecil that there was any truth in the stories of a marriage between them. On his return he was put into the Tower, and if he was not already married was married there. To placate the queen he made a fantastic display of despair at the loss of her favour. It must be remembered that the maids of honour could not marry without the consent of the queen, which Elizabeth was always most reluctant to give and would be particularly unwilling to give

when the husband was an old favourite of her own. Raleigh proved a good husband and his wife was devoted to him through life. As the ships of the expedition had taken a valuable prize, the Portuguese carrack "Madre de Dios," and as there was a dispute over the booty, he was released to superintend the distribution. He had been a large contributor to the cost of the expedition, but the queen, who sent only two ships, took the bulk of the spoil, leaving him barely enough to cover his expenses.

Raleigh now retired from court to an estate at Sherborne in Dorsetshire, which just before his disgrace he had extorted from the bishop of Salisbury, to whose see it belonged, by a most unscrupulous use of the royal influence. A son was born to him here in 1594, and he kept up a friendly correspondence with Sir Robert Cecil, afterwards earl of Salisbury, the secretary of state. But a life of constant retirement was uncongenial to Raleigh, and as his profuse habits, together with the multiplicity of his interests, had prevented him from making any advantage out of his estates in Ireland, he was embarrassed for money. In 1595 he therefore sailed on a voyage of exploration with a view to conquest, on the coast of South America. The object was undoubtedly to find gold mines, and Raleigh had heard the wild stories of El Dorado which had been current among the Spaniards for long. His account of his voyage, *The Discoverie of Guiana*, published on his return, is the most brilliant of all the Elizabethan narratives of adventure, but contains much manifest romance. It was received with incredulity. He was now the most unpopular man in England, not only among the courtiers, but in the nation, for his greed, arrogance and alleged scepticism in religion. In 1590 he was named with the poet Marlowe and others as an atheist. At court he was not at first received. The share he took in the capture of Cadiz in 1596, where he was seriously wounded, was followed by a restoration of favour at court, and he was apparently reconciled to Essex, whom he accompanied on a voyage to the Azores in 1597. This co-operation led to a renewal of the quarrel, and Raleigh, as the enemy of Essex who was the favourite of the soldiers and the populace, became more unpopular than ever. In 1600 he obtained the governorship of Jersey, and in the following year took a part in suppressing the rebellion of Essex, at whose execution he presided as captain of the Guard. In 1600 he sat as member for Penzance in the last parliament of Elizabeth's reign. In parliament he was a steady friend of religious toleration, and a bold critic of the fiscal and agrarian legislation of the time.

The death of the queen and the accession of James I. were ruinous to Raleigh. James, who looked upon Essex as his partisan, had been prejudiced, and Raleigh's avowed desire for the prolongation of the war with Spain was utterly against the peace policy of the king. Raleigh was embarrassed for money, and had been compelled to sell his Irish estates to Richard Boyle, afterwards 1st earl of Cork, in 1602. He was expelled from Durham House, which was reclaimed by the bishop, dismissed from the captaincy of the Guard, deprived of his monopolies, which the king abolished, and of the government of Jersey. In his anger and despair he unquestionably took some part in the complication of conspiracies which arose in the first months of James's reign, and was committed to the Tower on the 19th of July 1603. Here he made what appears to have been an insincere attempt to stab himself, but only inflicted a small wound. His trial at Winchester, November 1603, was conducted with such outrageous unfairness as to shock the opinion of the time, and his gallant bearing in face of the brutality of the Attorney-General, Sir Edward Coke, turned public opinion in his favour. It is now impossible to reach the truth, but on the whole it appears probable that Raleigh was cognizant of the conspiracies, though the evidence produced against him was insufficient to prove his guilt. Much was kept back by the council, and the jury was influenced by knowing that the council thought him guilty.

The sentence of death passed on Raleigh, and others tried at about the same time, was in most cases not carried out.

Raleigh was sent to the Tower, where he remained till the 19th of March 1616. His estate of Sherborne, which he had transferred to his son, was taken by the king, who availed himself of a technical irregularity in the transfer. A sum of £8000 offered in compensation was only paid in part. Raleigh's confinement was easy, and he applied himself to chemical experiments and literature. He had been known as one of the most poetical of the minor lyric poets of an age of poetry from his youth. In prison he composed many treatises, and the only volume of his vast *History of the World* published. He also invented an elixir which appears to have been a very formidable quack stimulant. Hope of release and of a renewal of activity never deserted him, and he strove to reach the ear of the king by appealing to successive ministers and favourites. At last he secured his freedom in a way discreditable to all concerned. He promised the king to find a gold mine in Guiana without trenching on a Spanish possession. It must have been notorious to everybody that this was impossible, and the Spanish ambassador, Gondomar, warned the king that the Spaniards had settlements on the coast. The king, who was in need of money, replied that if Raleigh was guilty of piracy he should be executed on his return. Raleigh gave promises he obviously knew he could not keep, and sailed on the 17th of March 1617, relying on the chapter of accidents, and on vague intrigues he had entered into in Savoy and France. The expedition, on which the wreck of his fortune was spent, was ill-appointed and ill-manned. It reached the mouth of the Orinoco on the last day of 1617. Raleigh was ill with fever, and remained at Trinidad. He sent five small vessels up the Orinoco under his most trusted captain, Lawrence Keymis, with whom went his son Walter and a nephew. The expedition found a Spanish settlement on the way to the supposed mine, and a fight ensued in which Sir Walter's son and several Spaniards were killed. After some days of bush fighting with the Spaniards, and of useless search for the mine, Keymis returned to Sir Walter with the news of his son's death and his own utter ruin. Stung by Raleigh's reproach Keymis killed himself, and then after a miserable scene of recriminations, hesitations and mutiny, the expedition returned home. Raleigh was arrested, and in pursuance of the king's promise to Gondomar was executed under his old sentence on the 29th of October 1618. During his confinement he descended to some unworthy supplications and devices, but when he knew his end to be inevitable he died with serenity and dignity. His wife survived him, and he left a son, Carew Raleigh. His enmity to Spain made him a popular hero.

AUTHORITIES.—An edition of his *Works* in eight volumes was published in London in 1829. It contains a *Life* by Oldys and Birch, written with all the knowledge then available. A *Life of Sir Walter Raleigh* (London, 1806, 2nd ed.) was much used by Southey in his biography of Sir Walter Raleigh in vol. iv. of *The British Admirals in the Cabinet Cyclopaedia* (London, 1837). Two biographies appeared simultaneously, *Life of Sir Walter Raleigh* by J. A. Saint John, and *Life of Sir Walter Raleigh* by E. Edwards (London, 1868). Mr Edwards's work is in two volumes, of which the second contains the correspondence, and is still the best authority. Smaller lives, which in some cases contain new matter, are those by E. W. Gosse, "Raleigh" in *English Worthies* (1886); W. Stebbing, *Sir W. Raleigh* (London, 1891, and 1899); Martin Hume, *Sir Walter Raleigh* (London 1897); and H. de Selincourt, *Great Raleigh* (1908). For special episodes see Sir John Pope Hennessy, *Sir Walter Raleigh in Ireland* (London, 1883), and T. N. Brushfield, *Raleighana* (Ashburton, 1896). Two separate editions of Raleigh's poems have been published, *Poems, with biography and critical introduction* by Sir F. Brydges (London, 1813), and *Poems of Raleigh with those of Sir H. Wotton, &c.*, edited by J. Hannah (London, 1892). S. R. Gardiner made a careful examination of the events of Raleigh's life after 1603 in his *History of England from the Accession of James I. to the Outbreak of the Civil War* (1883-84). (D. H.)

RALEIGH, the capital of North Carolina, U.S.A., and the county-seat of Wake county, about 145 m. N. by W. of Wilmington. Pop. (1890) 12,678; (1900) 13,643, of whom 5721 were negroes; (1910, census) 10,218. Area 4 sq. m. It is served by the Southern, the Seaboard Air Line, the Raleigh & Southport, and the Norfolk Southern railways. The city lies about 360 ft. above sea-level on ground sloping gently in all directions from its centre, where there is a beautiful park

of 4 acres known as Union Square, in which is the State Capitol and from which extend four broad streets. On the western border of the city is Pullen Park (about 40 acres), including the campus of the College of Agriculture and Mechanic Arts; it was named in honour of the donor, R. Stanhope Pullen, who was also a benefactor of the college. The State Capitol (1840) is surmounted by a dome and modelled to some extent after the Parthenon and other buildings of ancient Greece; the first Capitol (begun in 1794) was burned in 1831. In the vicinity are the Governor's Mansion, the Supreme Court Building, the State Library, the building of the State Department of Agriculture, housing the State Museum (of geology, mineralogy, agriculture and horticulture, botany, zoology, ethnology, &c.), and the Post Office. Elsewhere are the County Court House, the State Hospital for the Insane (1856), founded through the efforts of Dorothea Lynde Dix, situated on Dix Hill and having in connexion with it a colony for epileptics; a state school for white blind, deaf and dumb (1845), and a state institute for negro deaf mutes and blind (1867); the state penitentiary (with a department for the criminal insane); a National Cemetery and a Confederate Cemetery; a Methodist Orphanage (1900) and a Roman Catholic Orphanage, the St Luke's Home for old ladies (1895; under the King's Daughters), a State (Confederate) Soldiers' Home (1891), and three private hospitals and the Rex public hospital (1909). Raleigh is the seat of the North Carolina College of Agriculture and Mechanic Arts (1889), in connexion with which is an agricultural experiment station; of three schools for girls—Peace Institute (Presbyterian, 1857), St Mary's School (Protestant Episcopal, 1842) and Meredith College (Baptist, 1891); of the medical department of the University of North Carolina; and of two schools for negroes—Shaw University (Baptist, 1865), with 530 students in 1908-1909, and St Augustine's School (Protestant Episcopal, 1868), a training school, with 466 students in 1908-1909. In 1908 the State Library (founded 1841) contained 39,000 volumes, the Supreme Court Library (founded 1870) about 17,000 volumes and the Olivia Rancy public library (founded 1901) 9250 volumes. The city is the see of a Protestant Episcopal bishop. The principal industrial interests are trade in leaf tobacco and cotton raised in the vicinity, and the manufacture of cotton goods, phosphate fertilizers, foundry and machine-shop products, wooden-ware, &c. The Seaboard Air Line and the Raleigh & Southport railways have repair shops here. In 1905 the factory product was valued at \$1,086,671, 14.7% more than in 1900. Electric power is conveyed to the city from Buckhorn Falls, on the Cape Fear river, about 26 m. south of Raleigh, and from Milburnie on the Neuse river, 6 m. distant.

In 1788 the site of the city, then known as Wake Court House, was chosen for the capital of the state; and in 1792 the city was laid out and named in honour of Sir Walter Raleigh. In 1794 the state legislature met here for the first time. Raleigh was incorporated in 1795 and was reincorporated in 1803; its present charter dates from 1899. General William T. Sherman's army, on its march through the Carolinas, passed through the city on the 13th of April 1865. Raleigh was the birthplace of President Andrew Johnson; the house in which he was born has been removed to Pullen Park. By an extension of its boundaries the city nearly doubled its area and increased its population in 1907.

RALPH (d. 1122), archbishop of Canterbury, called Ralph de Turbine, or Ralph d'Escures from his father's estate of Escures, near Séz in Normandy, entered the abbey of St Martin at Séz in 1079, and ten years later became abbot of this house. Soon afterwards he paid a visit to England, where his half-brother, Seffrid Pelochin, was bishop of Chichester, and in 1100 he took refuge in England from the violence of Robert of Belesme, passing some time with his friends St Anselm and Gundulf. In March 1108 he succeeded Gundulf as bishop of Rochester. After Anselm's death in April 1109 Ralph acted as administrator of the see of Canterbury until April 1114, when he himself was chosen archbishop at Windsor. In this capacity he was very assertive of the rights of the archbishop of Canter-

bury and of the liberties of the English church. He claimed authority in Wales and Scotland, and he refused to consecrate Thurstan as archbishop of York because the latter prelate declined to profess obedience to the archbishop of Canterbury. This step involved him in a quarrel with the Papacy, and he visited Rome, but was unable to obtain an interview with pope Paschal II., who had left the city. In spite of peremptory orders from Paschal's successors, Gelasius II. and Calixtus II., the archbishop still refused to consecrate Thurstan, and the dispute was unsettled when he died on the 20th of October 1122.

RALPH DE GUADER, earl of Norfolk (fl. 1070), was the son of a Norman who had held high positions in East Anglia, perhaps that of earl, in the reign of Edward the Confessor (c. 1055). His son Ralph fought on the Norman side at Hastings, and was made earl of Norfolk by William the Conqueror. In 1075 the king's refusal to sanction his marriage with the sister of Roger, earl of Hereford, caused the two earls to revolt. They were easily defeated, though Ralph sent to Denmark for ships and went there himself to fetch them. Ralph forfeited his English lands, and took refuge in Brittany on his wife's estate. In 1076, having plotted against Duke Hoel of Brittany, he was besieged at Dol, and the Conqueror came to Hoel's aid; but Ralph finally made his peace. Both he and his wife took part in the first crusade (1099), and died on the road to Palestine.

RALPH OF COGGESHALL (d. after 1227), English chronicler, was at first a monk and afterwards sixth abbot (1207-1218) of Coggeshall, an Essex foundation of the Cistercian order. Ralph himself tells us these facts; and that his resignation of the abbacy was made against the wishes of the brethren, in consequence of his bad health. He took up and continued a *Chronicon Anglicanum* belonging to his house; the original work begins at 1066, his own share at 1187. He hoped to reach the year 1227, but his autograph copy breaks off three years earlier. Ralph makes no pretensions to be a literary artist. Where he had a written authority before him he was content to reproduce even the phraseology of his original. At other times he strings together in chronological order, without any links of connexion, the anecdotes which he gathered from chance visitors. Unlike "Benedictus" and Roger of Hoveden, he makes little use of documents; only three letters are quoted in his work. On the other hand, the corrections and erasures of the autograph show that he took pains to verify his details; and his informants are sometimes worthy of exceptional confidence. Thus he vouches Richard's chaplain Anselm for the story of the king's capture by Leopold of Austria. The tone of the chronicle is usually dispassionate; but the original text contained some personal strictures upon Prince John, which are reproduced in Roger of Wendover. The admiration with which Ralph regarded Henry II. is attested by his edition of Ralph Niger's chronicle; here, under the year 1161, he replies to the intemperate criticisms of the original author. On Richard I. the abbot passes a judicious verdict, admitting the great qualities of that king, but arguing that his character degenerated. Towards John alone Ralph is uniformly hostile; as a Cistercian and an adherent of the Mandeville family he could hardly be otherwise. Ralph refers in the *Chronicon* (s.a. 1091) to a book of visions and miracles which he had compiled, but this is no longer extant. He also wrote a continuation of Niger's chronicle, extending from 1162 to 1178 (printed in R. Anstruther's edition of Niger, London, 1851), and short annals from 1066 to 1223.

The autograph manuscript of the *Chronicon Anglicanum* is to be found in the British Museum (Cotton, Vespasian D. X.). The same volume contains the continuation of Ralph Niger. The *Chronicon Terrae Sanctae*, formerly attributed to Ralph, is by another hand; it was among the sources on which he drew for the *Chronicon Anglicanum*. The so-called *Libellus de motibus anglicanis sub rege Johanne* (printed by Martene and Durand, *Ampl. Collectio*, v. pp. 871-882) is merely an excerpt from the *Chronicon Anglicanum*. This latter work was edited for the Rolls series in 1875 by J. Stevenson. (H. W. C. D.)

RAM, PIERRE FRANÇOIS XAVIER DE (1804-1865), Belgian churchman and historian, was born at Louvain in

1804. He took orders early, and was appointed professor of poetry at the seminary of Malines, and archivist of the diocese. During the years immediately before the revolution of 1830, Ram, who was much influenced by Lamennais, was active in bringing about a coalition of Liberals and Catholics against the Dutch government established by the Powers on the fall of Napoleon, and in endeavouring to give a democratic character to the policy of his church. He declined to stand as a member of the Belgian assembly, and applied himself wholly to teaching and to editing or composing historical books. As professor of philosophy at Malines he succeeded in bringing about the foundation of the Catholic university, which was transferred to Louvain in 1834. He was rector of the university till his death in 1865.

The best known of his publications is the *Documents relatifs aux troubles du pays de Liège 1455-1505*, published by the *Commission royale de l'Histoire de Belgique* (Brussels, 1844). A *Notice sur la vie et les travaux de Mgr P. F. X. de Ram*, by J. J. Thonissen, will be found in the *Annuaire de l'Académie royale de Belgique* (Brussels, 1866).

RAM, a male sheep, one kept for breeding purposes in domestication and not castrated, as opposed to the castrated "wether" (see SHEEP). For the ram as one of the signs of the zodiac, see ARIES. The word may be connected with O.Nor. *ramme*, strong, or with Sansk. *ram*, to sport. The butting propensities of the ram have given rise to the many transferred senses of the word, chief and earliest of which is that of a battering implement used before the days of cannon for beating in the gates and breaching the walls of fortified places (see BATTERING RAM). Many technical uses of the term have been developed from this, e.g. the weight of a pile-driving machine, the piston of a hydraulic press and other machines or portions of machines worked by water power (see HYDRAULICS). The ancient war-vessels were fitted with a beak (Lat. *rostrum*, Gr. *ἔκβολον*), projecting from the bows, and used to ram or crush in the sides of an opposing vessel; for the development of this in the modern battleship, see SHIP.

RAMADĀN, the month of the Mahommedan year in which absolute fasting from dawn to sunset is required. The law is laid down in Koran ii. 179-184, and is as follows: A fast had always been a part of religion. In Islām it was to fall in this month because in it the Koran was revealed, and it was holier than the others. It was to begin when the new moon was actually seen, and last until sight of the next new moon; to extend each day from the time when a white thread could be distinguished from a black one and until nightfall; to be absolute in that time as to food, drink, women. The daytime should be passed, by preference, in retreat (*i'itikāf*) in the mosque in pious exercises; during the night all otherwise lawful things to be lawful. The sick and those on a journey might be excused, but should fast thereafter an equivalent number of days. Unexcused breaking of the fast might be atoned for by feeding of the poor. The last ten days of the month are regarded as especially sacred; these Mahomet himself used to pass in retreat. In the course of them falls the "Night of Decree," or "of Power" (Koran xc. 1), but its exact date is not known. On it intercourse between heaven and earth is peculiarly open, and many wonders take place. Fasting in Ramadān is reckoned one of the five pillars, or absolute requirements, of Islām. It is followed by the Lesser Festival, the first three days of the month Shawal (see BAIRAM). Naturally, during it all the activities of life are reduced to a minimum, and those who can afford it turn night into day as much as possible.

For details see Hughes, *Dictionary of Islam*, 533 ff.; Sell, *Faith of Islam*, 279 ff.; Sprenger, *Leben Mohammads*, iii. 56 ff.; Snouck Hurgronje, *Mekka*, 51, 77 ff.; Meakin, *The Moors*, 247 ff.; Juynboll, *De Mohammedaansche Wet*, 108 ff. (D. B. MA.)

RAMBAUD, ALFRED NICOLAS (1842-1905), French historian, was born at Besançon on the 2nd of July 1842. After studying at the École normale supérieure, he completed his studies in Germany. He was one of that band of young scholars, among whom were also Ernest Lavisse, Gabriel Monod and Gaston Paris, whose enthusiasm was aroused by

the principles and organization of scientific study as applied beyond the Rhine, and who were ready to devote themselves to their cherished plan of remodelling higher education in France. He was appointed "répétiteur" at the École des Hautes Études on its foundation in 1868. His researches were at that time directed towards the Byzantine period of the middle ages, and to this period were devoted the two theses which he composed for his doctorate in letters, *De byzantino hippodromo et circensibus factionibus* (revised in French for the *Revue des Deux Mondes*, under the title of "Le monde byzantin; le sport et l'hippodrome," 1871), and *L'Empire grec au X^e siècle, Constantin Porphyrogénète* (1870). This latter work is still accepted as a good authority, and caused Rambaud to be hailed as a master on the Byzantine period; but with the exception of one article on Digenis Akritas, in the *Revue des Deux Mondes* (1875), and one other on Michael Psellos, in the *Revue historique* (vol. iii., 1876), Rambaud's researches were diverted towards other parts of the East. The Franco-German War inspired him with the idea for some courses of lectures which developed into books: *La domination française en Allemagne; les Français sur le Rhin, 1792-1804* (1873) and *L'Allemagne sous Napoléon I. 1804-1811* (1874). He watched attentively the rôle played by Russia, and soon observed how much to the interest of France, a good *entente* with this power would be. He accordingly threw himself into the study of Russian history, staying in Russia in order to learn its language, institutions and customs. On his return, he published *La Russie épique*, a study of the heroic songs (1876), a short but excellent *Histoire de la Russie depuis les origines jusqu'à l'année 1877* (1878; 5th ed., 1900), *Français et Russes, Moscou et Sévastopol 1812-1854* (1876; 2nd ed., 1881), and finally the two important volumes on Russian diplomatic history in the *Recueil des Instructions données aux ambassadeurs* (vols. vii. and ix., 1890 and 1891). He was not improbably moved by considerations of foreign policy to publish his *Russes et Prussiens, guerre de Sept Ans* (1895), a popular work, though based on solid research. After teaching history in the Faculties of Arts at Caen (1871) and Nancy (1873), he was called to the Sorbonne (1883), where he was the first to occupy the chair of contemporary history. By this time he had already entered into politics; he had been *chef du cabinet* of Jules Ferry (1879-1881), though this did not distract him from his literary work. It was under these conditions that he composed his *Histoire de la civilisation française* (2 vols., 1885, 1887; 9th ed., 1901) and his *Histoire de la civilisation contemporaine en France* (1888; new ed. entirely revised, 1906), and undertook the general editorship of the *Histoire générale du IV^e siècle jusqu'à nos jours*. The plan of this great work had been drawn up with the aid of Ernest Lavisse, but the entire supervision of its execution was carried out by Rambaud. He contributed to it himself some interesting chapters on the history of the East, of which he had a thorough knowledge. In 1885 Rambaud published, in collaboration with J. B. Baille, a French translation of J. R. Seeley's *Expansion of England*, and in the preface he laid great emphasis on the enormous increase of power brought to England by the possession of her colonies, seeing in this a lesson for France. He was anxious to see the rise of a "Greater France," on the model of "Greater Britain," and it was with this idea that he undertook to present to the public a series of essays, written by famous explorers or political men, under the title of *La France coloniale, histoire, géographie, commerce* (1886; 6th ed., 1893). Having become senator for the department of Doubs (1895-1902), Rambaud held the position of minister of Public Instruction from 1896 to 1898, and in that capacity endeavoured to carry on the educational work of Jules Ferry, to whose memory he always remained faithful. He dedicated to his former chief a book (*Jules Ferry*, 1903), which is a valuable testimony to the efforts made by France to organize public education and found a colonial empire; but this fidelity also won him some enemies, who succeeded for some time in preventing him from becoming a member of the Institute. He

was finally elected a member of the Académie des Sciences morales et politiques on the 11th of December 1897, in place of the duc d'Aumale, of whose life he wrote an account (vol. xxii., 2nd series, of the *Mémoires* of this academy). His many interests ended by wearing out even his robust constitution, and he died at Paris on the 10th of November 1905.

See the notices by Ernest Lavisse in the *Revue de Paris* for January 15th, 1906, and Gabriel Monod in the *Revue historique* (vol. xc., pp. 344-348).

RAMBERT, EUGÈNE (1830-1886), Swiss author, was born at Sâles near Swiss Clarens on the 6th of April 1830, the eldest son of a Vaudois schoolmaster, from whom he received his education. When in 1845 his father lost his post, owing to the religious disputes, Rambert became a teacher in Paris, and later a tutor in England and at Geneva. When the affairs of the family improved, Rambert was able to pursue his studies for the ministry, but he was more attracted by literature, and in 1845 became professor of French literature at the academy of Lausanne, and in 1860 at the Federal polytechnic school at Zürich, where he remained till 1881, when he again became professor at Lausanne. His principal work, *Les Alpes suisses* (5 vols., 1866-1875; republished with large additions, according to his own scheme, in 6 vols., 1887-1889), is a mine of miscellaneous information on the subject. He also published several volumes of poetry, as well as a volume entitled *Écrivains nationaux* (1874, republished 1889), and biographies of the pietist Vinet (1875), of the poet Juste Olivier (1879) and of the artist Alexandre Calame (1883). He died on the 21st of November 1886.

Rambert's *Dernières Poesies* were edited (1903) by Henri Warnery, whose *Eugène Rambert* (Lausanne, 1890) contains a critical estimate. (W. A. B. C.)

RAMBOUILLET, CATHERINE DE VIVONNE, MARQUISE DE (1588-1665), a lady famous in the literary history of France, was born in 1588. She was the daughter and heiress of Jean de Vivonne, marquis of Pisani, and her mother Giulia was of the noble Roman family of Savelli. She was married at twelve years old to Charles d'Angennes, vidame of Le Mans, and afterwards marquis of Rambouillet. The young marquise found the coarseness and intrigue that then reigned in the French court little to her taste, and after the birth of her eldest daughter, Julie d'Angennes, in 1607, she began to gather round her the circle afterwards so famous. She established herself at the Hôtel Pisani, called later the Hôtel de Rambouillet, the site of which is close to the Grands Magasins du Louvre. Mme de Rambouillet took great trouble to arrange her house for purposes of reception, and devised suites of small rooms where visitors could move easily, and could find more privacy than in the large reception rooms of the ordinary house. The hôtel was rebuilt on these lines in 1618. It maintained its importance as a social and literary centre until 1650. Almost all the more remarkable personages in French society and French literature frequented it, especially during the second quarter of the century, when it was at the height of its reputation. There is abundant testimony to Mme de Rambouillet's beauty, though no portrait of her is known to exist. Her success as a hostess was due to many causes. Her natural abilities had been carefully trained, but were not extraordinary. Many people were, however, like herself, disgusted with the intrigues at court, and found the comparative austerity of the Hôtel de Rambouillet a welcome change. The marquise had genuine kindness and a lack of prejudice that enabled her to entertain on the same footing princes and princesses of the blood royal, and men of letters, while among her intimate friends was the beautiful Angélique Paulet. The respect paid to ability in her salon effected a great advancement in the position of French men of letters. Moreover, the almost uniform excellence of the memoirs and letters of 17th-century Frenchmen and Frenchwomen may be traced largely to the development of conversation as a fine art at the Hôtel Rambouillet, and the consequent establishment of a standard of clear and adequate expression. Mme de Rambouillet was known as the "incomparable Arthénice," the name being an anagram for Catherine, devised by Malherbe and Racan.

Among the more noteworthy incidents in the story of the Hôtel are the sonnet war between the Uranistes and the Jobistes—partisans of two famous sonnets by Voiture and Benserage—and the composition by all the famous poets of the day of the *Guirlande de Julie*, a collection of poems on different flowers, addressed in 1641 to Julie d'Angennes, afterwards duchesse de Montausier. Julie herself was responsible for a good deal of the preciousness for which the Hôtel was later ridiculed. Charles de Sainte Maure, who became in 1664 duc de Montausier, had been wooing her for seven years when he conceived the idea of the famous garland, and she kept him waiting for four years more.

The *Précieuses*, who are usually associated with Molière's avowed caricatures and with the extravagances of Mlle. de Scudéry, but whose name, it must be remembered, Madame de Sévigné herself was proud to bear—insisted on a ceremonious gallantry from their suitors and friends, though it seems from the account given by Tallemant des Réaux that practical jokes of a mild kind were by no means excluded from the Hôtel de Rambouillet. They especially favoured an elaborate and quintessenced kind of colloquial and literary expression, imitated from Marini and Gongora, and then fashionable throughout Europe. The immortal *Précieuses ridicules* of Molière was no doubt directly levelled not at the Hôtel de Rambouillet itself, but at the numerous coteries which in the course of years had sprung up in imitation of it. But the satire did in truth touch the originators as well as the imitators,—the former more closely perhaps than they perceived. The Hôtel de Rambouillet continued open till the death of its mistress, on the 2nd of December 1665, but the troubles of the Fronde diminished its influence.

The chief original authorities respecting Madame de Rambouillet and her set are Tallemant des Réaux in his *Historiettes*, and Antoine Baudeau de Somaize in his *Grand Dictionnaire des Précieuses* (1660). Many modern writers have treated the subject, notably Victor Cousin, *La Société française au xvii^e siècle* (2 vols., 1856), and C. L. Livet, *Précieux et Précieuses* . . . (1859). There is an admirable edition (1875) of the *Guirlande de Julie* by O. Uzanne.

RAMBOUILLET, a town of northern France, capital of an arrondissement in the department of Seine-et-Oise, 30 m. S.W. of Paris on the railway to Chartres. Pop. (1906) town, 3965; commune, 6165. Rambouillet derives its whole interest from the associations connected with the ancient château, dating originally from the 14th century, but often rebuilt. A great machicolated tower is all that remains of the medieval building; some apartments with good woodwork are also of interest. The château is surrounded by a beautiful park of 3000 acres and by an extensive forest. The gardens, partly in French, partly in English style, are picturesque, and have an avenue of Louisiana cypress unique in Europe. The park contains the national sheep-farm, where in the 18th century the first flock of merino sheep in France was raised, a school of sheep-farming, and, close to the latter, a small dairy built by Louis XVI. The shooting of the famous coverts of Rambouillet is reserved for the presidents of the Republic. The town is the seat of a sub-prefect and has a tribunal of first instance and a preparatory infantry school. Trade is in grain, wool, flour and wood. Watch-springs are manufactured.

Originally a royal domain, the lands of Rambouillet passed in the 14th century to the D'Angennes family, who held them for three hundred years and built the château. Francis I. died there in 1547; and Charles IX. and Catherine de Medicis found a refuge there in the Wars of Religion, as Henry III. did after them. The title became a marquise in 1612, at which time it was held by Charles d'Angennes, husband of Catherine de Vivonne (*q.v.*), the famous marchioness of Rambouillet. Created a duchy and peerage in favour of the duke of Toulouse, son of Louis XIV., Rambouillet was subsequently bought and embellished by Louis XVI., who erected a model farm and other buildings. The place was a hunting-seat of Napoleon I. and Charles X., and it was here that in 1830 the latter signed his abdication.

RAMEAU, JEAN PHILIPPE (1683–1764), French musical theorist and composer, was born at Dijon on the 23rd of October 1683. His musical education, partly in consequence of his father's desire that he should study law, still more through his own wayward disposition, was of a desultory character. In 1701 his father sent him to Milan to break off a foolish love-match. But he learned little in Italy, and soon returned, in company with a wandering theatrical manager, for whom he played the second violin. He next settled in Paris, where he published his *Premier livre de pièces de clavecin*, in 1706. In 1717 he made an attempt to obtain the appointment of organist at the church of St Paul. Deeply annoyed at his unexpected failure, he retired for a time to Lille, whence, however, he soon removed to Clermont-Ferrand. Here he succeeded his brother Claude as organist at the cathedral.

Burning with desire to remedy the imperfections of his early education, Rameau diligently studied the writings of Zarlino, Descartes, Mersenne, F. Kircher and other theorists. He not only mastered their views but succeeded in demonstrating their weak points and substituting for them a system of his own. His keen insight into the constitution of certain chords, which in early life he had studied only by ear, enabled him to propound a series of hypotheses, many of which are now accepted as established facts. While the older contrapuntists were perfectly satisfied with the laws which regulated the melodious involutions of their vocal and instrumental parts, Rameau demonstrated the possibility of building up a natural harmony upon a fundamental bass, and of using that harmony as an authority for the enactment of whatever laws might be considered necessary for the guidance either of the contrapuntist or the less ambitious general composer. And in this he first explained the distinction between two styles, which have been called the "horizontal and vertical systems," the "horizontal system" being that by which the older contrapuntists regulated the onward motion of their several parts, and the "vertical system" that which constructs an entire passage out of a single harmony. From fundamental harmonies he passed to inverted chords, to which he was the first to call attention; and the value of this discovery fully compensates for his erroneous theory concerning the chords of the eleventh and the great (*Angl.* "added") sixth (see HARMONY).

Rameau first set forth his new theory in his *Traité de l'harmonie* (Paris, 1722), and followed it up in his *Nouveau système* (1726), *Génération harmonique* (1737), *Démonstration* (1750) and *Nouvelles réflexions* (1752). But it was not only as a theorist that he became famous. Returning to Paris in 1722 he first attracted attention by composing some light dramatic pieces, and then showed his real powers in his opera, *Hippolyte et Aricie*, founded on Racine's *Phèdre* and produced at the Académie in 1733. Though this work was violently opposed by the admirers of Lulli, whose party spirit eventually stirred up the famous "guerre des bouffons," Rameau's genius was too brilliant to be trampled under foot by an ephemeral faction and his ultimate triumph was assured. He afterwards produced more than twenty operas, the most successful of which were *Dardanus*, *Castor et Pollux*, *Les Indes galantes* and *La princesse de Navarre*. Honours were showered upon him. He was appointed conductor at the Opéra Comique, and the directors of the opera granted him a pension. King Louis XV. appointed him composer to the court in 1745, and in 1764 honoured him with a patent of nobility and the order of St Michael. But these last privileges were granted only on the eve of his death at Paris on the 12th of September 1764.

See biographies in Charles Poisset (1864), Nisard (1867), Pougin (1876).

RAMESES, or **RAMESESSES** (Gen. xlvii. 11; Exod. xii. 37; Num. xxxiii. 3), or, with a slight change in the vowel points, **RAMSESSES** (Exod. i. 11), the name of a district and town in Lower Egypt, is notable as affording the mainstay of the current theory that King Rameses II. was the pharaoh of the oppression and his successor Minephthas the pharaoh of the exodus. The actual facts, however, hardly justify so large an inference. The

first three passages cited above are all by the priestly (post-exile) author and go together. Jacob is settled by his son Joseph in the land of Rameses and from the same Rameses the exodus naturally takes place. The older narrative speaks not of the land of Rameses but of the land of Goshen; it seems probable, therefore, that the later author interprets an obsolete term by one current in his own day, just as the Septuagint in Gen. xlv. 28 names instead of Goshen Heroopolis and the land of Rameses. Heroopolis lay on the canal connecting the Nile and the Red Sea, and not far from the head of the latter, so that the land of Rameses must be sought in Wādi Tūmilāt near the line of the modern fresh-water canal. In Exod. i. 11, again, the store-cities or arsenals which the Hebrews built for Pharaoh are specified as Pithom and Raameses, to which the Septuagint adds Heliopolis. Pithom also takes us to the Wādi Tūmilāt. But did the Israelites maintain a continuous recollection of the names of the cities on which they were forced to build, or were these names rather added by a writer who knew what fortified places were in his own time to be seen in Wādi Tūmilāt? The latter is far the more likely case, when we consider that the old form of the story of the Hebrews in Egypt is throughout deficient in precise geographical data, as might be expected in a history not committed to writing till the Israelites had resided for centuries in another and distant land. The post-exile or priestly author indeed gives a detailed route for the exodus (which is lacking in the older story), but he, we know, was a student of geography and might supplement tradition by what he could gather from traders as to the caravan routes.¹ And at all events to argue that, because the Hebrews worked at a city named after Rameses, they did so in the reign of the founder, is false reasoning, for the Hebrew expression might equally be used of repairs or new works of any kind.

It appears, however, from remains and inscriptions that Rameses II. did build in Wādi Tūmilāt, especially at Tell Maskhūta, which Lepsius therefore identified with the Raameses of Exodus. This identification is commemorated in the name of the adjacent railway station. But Naville's excavations found that the ruins were those of Pithom and that Pithom was identical with the later Heroopolis. Petrie found sculptures of the age of Rameses II. at Tel Rotāb, in the Wādi Tūmilāt west of Pithom, and concludes that this was Rameses. The Biblical city is probably one of those named Prameses, "House of Rameses," in the Egyptian texts.

See ΠΙΘΟΜ; and W. M. F. Petrie, *Hyksos and Israelite Cities*, p. 28 et seq. (W. R. S., F. L. G.)

RAMESWARAM, a town of British India, in the Madura district of Madras, on the island of Pambam in Palk Straits. It contains one of the most venerable Hindu shrines, founded, according to tradition, by Rama himself, which for centuries has been the resort of thousands of pilgrims from all parts of India. The great temple, with its pillared corridors 700 ft. long, is perhaps the finest example of Dravidian architecture.

RAMIE (RHEA, CHINA-GRASS), the product of one or more species of the genus *Boehmeria*, a member of the order Urticaceae and nearly allied to the stinging nettle genus (*Urtica*), from which, however, it differs in absence of stinging hairs. Some confusion has arisen in the use of the various terms China-grass, Ramie and Rhea. Two plants are concerned. One, *Boehmeria nivea*, China-grass, has been cultivated by the Chinese from very early times under the name *Tschou-ma*. The other, probably a variety of the same species (*Boehmeria nivea*, var. *tenacissima*), though sometimes regarded as a distinct species (*B. tenacissima*), is the Ramie (Malay *sāmi*) of the Malay Islands and the Rhea of Assam.

Boehmeria nivea is a shrubby plant with the growth of the common nettle but without stinging hairs, sending up each season a number of straight shoots from a perennial underground rootstock. The long-stalked leaves recall those of the nettle in their shape and serrated margin, but their backs are

clothed with a downy substance and have a silvery appearance. The minute greenish flowers are closely arranged along a slender axis. This variety has been cultivated by the Chinese for many years, and the fibre, which is obtained from it by a tedious hand-process, has been used more or less as a substitute for silk.

The variety *tenacissima* differs in its more robust habit and larger leaves, which are pale green on the face and a very much paler green on the bark. They are not downy, however, and this affords a ready means of distinction from true China-grass. *Boehmeria nivea* is sometimes found wild in India, Malaya, China and Japan, and is probably a native of further India and Malaya. China-grass and ramie are widely cultivated not only in China, Formosa, Japan, India and Malaya, but also in Queensland, Mauritius, the Cameroons, the West Indies, Brazil, Mexico and the southern states of North America, and also in south Europe.

The plant, which attains a height of from 3 to 8 ft., is grown from seed, cuttings or layers, or by division of the roots. It is easy to cultivate, and thrives in almost any soil, but especially in a naturally rich, moist, light, loamy soil. For the best growth a good and equally distributed rainfall is necessary. Sudden changes of weather result in irregularities in growth, and these have a tendency to produce plants the fibres of which vary in strength. Liberal manuring is necessary, as the plant withdraws a large quantity of valuable constituents from the soil. The plants should be cut when the flower is beginning to fall and the seed to form.

It is stated that two to four crops per season may be obtained on suitable ground, each crop yielding about 4 tons of stems per acre. With only two crops per year, and a 4% yield of fibre, the resulting product would nearly reach one-third of a ton per acre. When proper attention is given to the choice of ground, and to planting, there is not much difficulty in the way of raising a good crop; the trouble arises in the extraction of the fibre.

The stems when ripe are cut down, and after the leaves and small branches have been removed, the outer cover and the layers of fibre are stripped off in the form of ribbons. These ribbons contain the bark, the fibre and a quantity of very adhesive gum. The Chinese remove this bark and as much of the gum as possible before the plant has dried. This hand-process is naturally a slow and tedious one, and many decorticators have been invented to supplant it. The action of all these decorticators is very similar. The ramie stalks are fed into the machine, and during their passage are beaten by 12 to 20 rapidly revolving blades. These break the stalks into small pieces, and leave the bark and fibre in long ribbons. At the same time, part of the gum is squeezed out between the beaters and the anvil. Up to the present, however, these machines have not been very successful. They usually bruise or otherwise injure the fibre, and they do not squeeze out the gum thoroughly. If the gum be allowed to dry on the ribbons it is difficult to remove it, and the chemicals employed in the degumming, if not thoroughly removed by washing, often injure the fibre to such an extent that the ultimate fabric or article is soon decomposed. If, however, the ribbons be degummed immediately, or soon after the plants are cut down, the gum will be much more easily extracted—indeed it might be possible to remove it then by boiling water or steam. The fibre cannot be expected to make much headway until the operations of decorticating and degumming are successfully carried out on or near the growing grounds; and, until a proficient decorticator is made, the fibre should be stripped by hand and the degumming operation begun immediately. By this method the least possible damage would result to the fibre, no waste material would be shipped, and a clean fibre would be placed on the market.

The fibre possesses some very valuable properties; it is not only much stronger than any other known fibre, but almost equals silk in its brilliance. This latter property, however, is now challenged by mercerized cotton. It successfully resists atmospheric changes, is easily dyed and is affected but little by moisture. On the other hand, articles manufactured from it are

¹ From the position of the words it is even not unlikely that "Pithom and Raameses" may be the addition of a redactor, and that the first author of Exod. i. 11 only spoke generally of store-cities.

said to crack and break easily when sharply bent, and on account of their hairy character have not the same smart appearance as those made from flax. Although the fibre is in some cases 12 in. long, it varies considerably in length. This is one of the drawbacks in the preparing and spinning. It is impossible to make perfect yarns from fibres of various lengths; hence it is necessary either to separate the fibres into reasonable groups, or to cut them into satisfactory lengths. The latter method appears, on the whole, to be the better, and it is the method adopted by Messrs Greenwood & Batley Limited, Leeds, who make special machinery for the dressing, preparing and spinning of ramie and China-grass. If no special machinery be employed, the length of the fibre will decide the class of machinery to be used. The fibre has been prepared and spun on flax, wool and silk-waste machinery, but it must be understood that none of these systems are really suitable for the process. A fibre with special characteristics requires special machinery for its manufacture.

When so many different opinions obtain as to which existing machinery is best adapted for the preparing and spinning of ramie, it is not surprising to find that different methods are employed in the process of manufacture. In general, however, we may say that, after decortication, the first process is that of degumming. This is usually done by immersing the fibre in a caustic soda solution, which is then heated in a closed vessel. The fibre is laid on galvanized trays, of which as many as forty-four can be fitted in a cage, which is then placed inside the boiling keir, the lid of which is screwed down and the necessary pressure of steam admitted. After having been boiled a sufficient time to remove the gum, the material is lifted out, the alkali neutralized, and the fibre thoroughly washed to remove all traces of chemicals. The bulk of the water is removed by a hydro-extractor, and the fibre is then hung up or laid on perforated plates to dry.

To facilitate the subsequent processes, the fibre is softened by passing it through a machine fitted with fluted rollers. Then follow the operations of dressing, roving, wet spinning and doubling, and finally the twisted thread is passed rapidly through a gas flame in order to remove all superfluous hairs.

In spite of the many disappointments which have been experienced in connexion with the treatment of this fibre, we are of the opinion that it will ultimately hold a good place amongst commercial fibres. It is at present spun in several European countries, but its use is still very limited. This is due, not to any imperfection of the fibre, but to its price and to the limited supply of raw material. It is at present chiefly used for gas mantles, for which it is particularly well adapted. It has also been used for paper-making, ropes, lines, nets, underwear, and for canvas and several other fabrics. If only a good supply of clean fibre could be obtained, there is not the least doubt that manufacturers and machine-makers would quickly provide means for dealing with it. (T. Wo.)

RAMILLIES, a village of Belgium, in the province of Brabant, 13 miles N. by E. of Namur, between the sources of the Little Gheete and of the Mehaigne. It is famous for the victory of the Allies under the duke of Marlborough over the French commanded by Marshal Villeroy on the 12th/23rd of May 1706. The position of the French on the high ground about Ramillies was marked by the villages of Autréglise (Anderkirch) on the left, Offuz on the left centre, Ramillies on the right centre and Tavers on the right close to the river Mehaigne. In front of the last was a smaller village, Franquenay, which was held as an advanced post. Between these *points d'appui* the ground was mostly open upland, and the position as a whole was defective in so far that the villages were barely within cannon-shot of each other. It was particularly strong on the flanks, which were protected by the marshy beds of the Mehaigne and the Little Gheete. Ramillies stands almost on the watershed of these adjacent valleys, and here Marlborough decided to deliver his main attack. The forces were about equal, and were at first equally distributed along the whole line of either party. Marlborough's local concentration of force at the spot where the attack was to be pressed home was made not before, but after the action had opened (cf. NEERWINDEN). Villeroy's left wing of cavalry and infantry was secure—and at the same time immobilized—behind the upper course of the Little Gheete, and the French commander allowed himself to be imposed upon by a demonstration in this quarter, convinced perhaps by the presence of the British contingent that a serious attack was

intended. The morning was spent in arraying the lines of battle, and it was about 1.30 when the cannonade opened. Soon the first lines of infantry of the Allied centre and left (Dutch) opened the attacks on Franquenay and Tavers and on Ramillies, and, when after a severe struggle Tavers fell into the hands of the Dutch, their commander, Marshal Overkirk, led forward the whole of the left wing cavalry and fiercely engaged the French cavalry opposed to it. The ground was open, both parties had placed the greater part of their horse on this side, and it was only after a severe and prolonged engagement (in which Marlborough himself took part like a trooper and was unhorsed) that the Allies were definitely victorious, thanks to the arrival of a force of cavalry brought over from the Allied right wing. Meanwhile the principal attack on Ramillies had been successfully pressed home, the necessary concentration of force being secured by secretly and skilfully withdrawing some British battalions from the right wing. While Villeroy was trying to bring up supports from the left to take part in the cavalry battle, the French in Ramillies were driven out into the open, where the Allied cavalry, having now gained the upper hand, rode down many battalions. Most of the French cavalry from the other wing, having to force its way through the baggage trains of the army (these had been placed too near the fighting lines), arrived too late, and once Ramillies had fallen the whole line of the Allies gradually took up the offensive. It was not long before the French line was rolled up from right to left, and the retreat of the French was only effected in considerable confusion. Then followed for once a relentless pursuit, carried on by the British cavalry (which had scarcely been engaged) to Louvain, 20 m. from the field of battle. Marlborough's unequalled tactical skill and judgment thus sufficed not merely to win the battle, but to win it with so large a margin of force unexpended that the fruits of his victory could be gathered. The French army lost, in killed, wounded and missing, some 15,000 men, the Allies (amongst whom the Dutch had borne the brunt of the fighting) scarcely one-third as many.

RAMLER, KARL WILHELM (1725-1798), German poet, was born at Kolberg on the 25th of February 1725. After completing his studies in Halle, he went to Berlin, where, in 1748, he was appointed professor of logic and literature at the cadet school. In 1786 he became associated with the author, Johann Jakob Engel, in the management of the royal theatre, of which, after resigning his professorship, he became (1790-96) sole director. He died at Berlin on the 11th of April 1798. Ramlar was a skilful but cold and uninspired versifier; and the reputation he enjoys as poet and critic is mainly due to his skill in imitating and reproducing in German, classical (mostly Horatian) metrical forms; and he had a reputation, not unfounded, of correcting his friends' writings out of recognition. His *Tod Jesu*, a cantata, is well known owing to its musical setting by Karl Heinrich Graun.

Ramlar published *Geistliche Cantaten* (1760) and *Oden* (1767). A collection of his works was published by L. F. G. von Gökkingk (2 vols., 1800-1801). See also Heinsius, *Versuch einer biographischen Skizze Ramlars* (1798); and K. Schüddekopf, *Karl Wilhelm Ramlar, bis zu seiner Verbindung mit Lessing* (1886).

RAMMELSBERG, KARL FRIEDRICH AUGUST (1813-1899), German mineralogist, was born at Berlin on the 1st of April 1813. He was educated for the medical profession and graduated in 1837 at Berlin University. In 1841 he became *privatdozent* in the university, and in 1845 professor extraordinary of chemistry. This post he relinquished in 1851 to take the chair of chemistry and mineralogy at the Royal Industrial Institute. In 1874 he was appointed professor of inorganic chemistry, and director of the second chemical laboratory at Berlin. Distinguished for his researches on mineralogy, crystallography and analytical chemistry, he laboured also at metallurgy, and yet found time for a series of important textbooks, in which his learning and sound judgment were combined with a lucid and accurate statement of facts. He was author of *Handwörterbuch des chemischen Theils der Mineralogie* (2 vols., 1841; supp. 1843-53); *Lehrbuch der chemischen*

Metallurgie (1850); *Handbuch der Krystallographischen Chemie* (1855); *Handbuch der Mineralchemie* (1860); *Handbuch der Krystallographisch-physikalischen Chemie* (2 vols., 1881-82), some of the earlier works being incorporated in later and more comprehensive volumes with different titles. He died at Gross Lichterfelde, near Berlin, on the 28th of December 1899.

RAM MOHAN ROY (1774-1833), Indian religious reformer, and founder of the Brahma Samaj (*q.v.*) or Theistic Church, was born at Radhanagar, in the district of Hugli, Bengal, in May 1774. He was the son of a small landowner, and in his early life acquired a knowledge of Persian, Arabic and Sanskrit, besides his own vernacular, Bengali. At the age of sixteen he first assailed idolatry in his Bengali work, entitled *The Idolatrous Religious System of the Hindus*. This gave offence to his orthodox father, and Ram Mohan left home and spent some years in travel. At the age of twenty-two he began his study of the English language, and he also acquired a knowledge of other modern and ancient European languages. On the death of his father he obtained an appointment under the British government in 1800, from which he retired in 1814, settled down in Calcutta, and devoted himself to religious reform. He had already inaugurated a circle for discussing the absurdities of idol worship, and published a striking book in Persian called *Tuhfat-al-Muwahhiddin* ("A Gift to Monotheists"). On his settlement in Calcutta he established a little friendly society (*Atmiya Sabha*), which met weekly to read the Hindu scriptures and to chant monotheistic hymns. In 1820 he issued a selection from the Christian Gospels entitled *The Precepts of Jesus the Guide to Peace and Happiness*. He also wrote Bengali works on the Vedanta philosophy, translated some of the *Upanishads*, entered into controversies with Christian missionaries, and on the 23rd of January 1830 definitely established the Brahma Samaj "for the worship and adoration of the Eternal, Unsearchable, Immutable Being who is the Author and Preserver of the Universe." He gave his support to the governor-general, Lord William Bentinck, for the abolition of the suttee rite, *i.e.* the custom of permitting Hindu widows to burn themselves on the funeral pyre of their husbands. He also worked hard to spread education among his fellow-countrymen, and to improve the quality and the prestige of the native press. In 1830 the emperor of Delhi bestowed on Ram Mohan the title of raja, and sent him to England as his agent. Raja Ram Mohan Roy gave his evidence before the Select Committee of the House of Commons on the judicial and revenue systems of India. He presented petitions to the House of Commons in support of the abolition of the suttee rite, and had the satisfaction of being present in the House when the appeal against such abolition was rejected on the 11th of July 1832. As the first educated and eminent Indian who had come to England, he received a cordial welcome from learned men; and Bentham addressed him as an "intensely admired and dearly beloved collaborator in the service of mankind." Ram Mohan also visited France and contemplated a voyage to America, but a sudden attack of brain fever led to his death on the 27th of September 1833. He was buried at Bristol, where a tomb was erected by his friend Dwarka Nath Tagore.

RAMNAD, a town of British India, in the Madura district of Madras, at the base of the spit of land that projects towards the island of Pamban in Palk strait. Pop. (1901) 14,546. It is the residence of a raja of old family, head of the Maravar caste, whose title is setupathi, or lord of Adam's Bridge. The estate covers an area of 2104 sq. m., and pays a permanent land revenue of £25,000. It is a desolate and generally unfertile tract, traversed by the South Indian railway.

RÂMNICU SARAT (*Râmnicu Sărat*), the capital of the department of Râmnicu Sarat, Rumania; on the railway from Buzeu to Focshani, and on the left bank of the Râmnicu, a tributary of the Sereth. Pop. (1900) 13,134, about 1500 being Jews. The town rises from a marshy plain, east of the Carpathians, and west of the cornlands of southern Moldavia. Salt and petroleum are worked in the mountains, and there is a considerable trade in agricultural produce and preserved

meat. Râmnicu Sarat was the scene of battles between the Moldavians and the Walachians in 1434 and 1573, and between the Walachians and Turks in 1634. Here also, in 1789, an Austro-Russian army defeated the Turks. In 1854 the town was almost destroyed by fire and was rebuilt.

RÂMNICUVĂLCEA (*Râmnicu Vâlcea*), or Rymnik, an episcopal city and the capital of the department of Vâlcea, Rumania; situated at the foot of the Carpathians, on the right bank of the river Olt, and on the railway from Caracal to Hermannstadt in Transylvania. Pop. (1900) 7317. Three monasteries in the Vâlcea department, those of Bistritza, Cozia and Horezu, are among the finest in Walachia. Besides wine, fruit, grain and timber, the surrounding uplands yield petroleum and salt. Within a few miles are the thermal springs of Olanestzi and the salt mines of Ocele Mari. The city is said to be the ancient *Castra Traiana*, and many traces of old encampments bear evidence of this.

RAMPOLLA, COUNT MARIANO DEL TINDARO (1843-), Italian cardinal, was born on the 17th of August 1843, at Polizzi, in the Sicilian diocese of Cefalù. Having completed his studies in the Capranica College at Rome, and having taken holy orders, he studied diplomacy at the College of Ecclesiastical Nobles, and in 1875 was appointed councillor to the papal nunciature at Madrid. Two years later he was recalled to Rome and appointed secretary of the Propaganda for Eastern Affairs, and for Extraordinary Ecclesiastical Affairs. Consecrated titular archbishop of Heraclea in 1885, he returned to Madrid as nuncio, but was shortly afterwards created cardinal and appointed to the papal secretaryship of state. New to the Sacred College and free from traditional preconceptions, he was admirably fitted to carry out the papal policy under Leo XIII. (see PAPACY). Rightly or wrongly, he was held personally responsible for the *rapprochement* with France and Russia and the opposition to the Powers of the Triple Alliance; and this attitude had its effect on his career when Leo XIII. died. Rampolla was undoubtedly the favourite among the *papabili* cardinals; but the veto of Austria was interposed (see CONCLAVE), and the votes of the Sacred College fell to Cardinal Sarto, who on the 4th of August 1903 became pope as Pius X. Cardinal Rampolla at once resigned his office as secretary of state, being succeeded by Cardinal Merry del Val, and ceased to play any conspicuous part in the Curia.

RAMPUR, a native state of India, in subordination to the United Provinces. It lies in Rohilkhand, between the British districts of Moradabad and Pilibhit. Area, 893 sq. m. The country is level and generally fertile; being watered in the north by the rivers Kosila and Nahul, and in the south by the Ramganga. The chief crops are maize, rice and sugar cane. Pop. (1901) 533,212, showing a decrease of 3.3% in the decade. Estimated revenue, £234,000; military force, 2556 men, including two squadrons of Imperial Service lancers. The chief, whose title is nawab, is a Rohilla Pathan, representing the family which established their power over this part of the country in the 18th century. When the Rohillas were subjugated by the nawab of Oudh, with the assistance of a force lent by Warren Hastings, one of their number, Faiz-ullah Khan, from whom the present nawab traces his descent, was permitted to retain possession of Rampur. During the Mutiny of 1857 the nawab of Rampur rendered important services to the British, for which he received a grant of land assessed at £9000 in perpetuity, besides other honours. The state is crossed by the main line of the Oudh & Rohilkhand railway from Bareilly to Moradabad. The town of Rampur is on the left bank of the river Kosila, 620 ft. above the sea, with a railway station 39 m. N.W. of Bareilly. Pop. (1901) 78,758. There are manufactures of damask, pottery, sword-blades and sugar. It is partially, and was once completely, surrounded by a broad bamboo hedge, which formed a strong defence. In addition to a modern fort and several fine buildings, it contains an Arabic college, which attracts students from all parts of India.

There are two other towns in India called Rampur, one

of which, the capital of the state of Bashahr in the Punjab, has given its name to the fine woollen shawls, widely known as Rampur *chadars*.

RAMPUR BOALIA, or **BEULEAH**, a town of British India, the administrative headquarters of Rajshahi district in Eastern Bengal and Assam; on the left bank of the Ganges. Pop. (1901) 21,589. It was originally chosen as a commercial factory for the silk trade, which is again being officially encouraged by the agricultural department. The town contains a government college, and an industrial school for sericulture. Most of the public buildings were severely damaged by the earthquake of the 12th of June 1897. There is a daily steamer service on the Ganges.

RAMSAY, ALLAN (1686–1758), Scottish poet, was born at Leadhills, Lanarkshire, on the 15th of October 1686. He was educated at the parish school of Crawford, and in 1701 was apprenticed to a wig-maker in Edinburgh. He married Christian Ross in 1712; a few years after he had established himself as a wig-maker (not as a barber, as has been often said) in the High Street, and soon found himself in comfortable circumstances. His first efforts in verse-making were inspired by the meetings of the Easy Club (founded in 1712), of which he was an original member; and in 1715 he became the Club Laureate. In the society of the members he assumed the name of "Isaac Bickerstaff," and later of "Gawin Douglas," the latter partly in memory of his maternal grandfather Douglas of Muthill (Perthshire), and partly to give point to his boast that he was a "poet sprung from a Douglas loin." The choice of the two names has some significance, when we consider his later literary life as the associate of the Queen Anne poets and as a collector of old Scots poetry. By 1718 he had made some reputation as a writer of occasional verse, which he published in broadsheets, and then (or a year earlier) he turned bookseller in the premises where he had hitherto plied his craft of wig-making. In 1716 he had published a rough transcript of *Christ's Kirk on the Green* from the Bannatyne MS., with some additions of his own. In 1718 he republished the piece with more supplementary verses. In the following year he printed a collection of *Scots Songs*. The success of these ventures prompted him to collect his poems in 1722. The volume was issued by subscription, and brought in the sum of four hundred guineas. Four years later he removed to another shop, in the neighbouring Luckenbooths, where he opened a circulating library (the first in Scotland) and extended his business as a bookseller. Between the publication of the collected edition of his poems and his settling down in the Luckenbooths, he had published a few shorter poems and had issued the first instalments of *The Tea-Table Miscellany* and *The Ever Green* (both 1724–1727). *The Tea-Table Miscellany* is "A Collection of Choice Songs Scots and English," containing some of Ramsay's own, some by his friends, several well-known ballads and songs, and some Caroline verse. Its title was suggested by the programme of the *Spectator*: and the compiler claimed the place for his songs "e'en while the tea's fill'd reeking round," which Addison sought for his speculations at the hour set apart "for tea and bread and butter." In *The Ever Green*, being a *Collection of Scots Poems wrote by the Ingenious before 1600*, Ramsay had another purpose, to reawaken an interest in the older national literature. Nearly all the pieces were taken from the Bannatyne MS., though they are by no means verbatim copies. They included his version of *Christ's Kirk* (u.s.) and a remarkable *pastiche* by the editor entitled the *Vision*. While engaged on these two series, he produced, in 1725, his dramatic pastoral *The Gentle Shepherd*. In the volume of poems published in 1722 Ramsay had shown his bent to this genre, especially in "Patie and Roger," which supplies two of the *dramatis personae* to his greater work. The success of the drama was remarkable. It passed through several editions, and was performed at the theatre in Edinburgh; its title is still known in every corner of Scotland, even if it be no longer read. Ramsay wrote little afterwards, though he published a few shorter poems, and new editions of his earlier

work. A complete edition of his *Poems* appeared in London in 1731 and in Dublin in 1733. With a touch of vanity he expressed the fear lest "the coolness of fancy that attends advanced years should make me risk the reputation I had acquired." He was already on terms of intimacy with the leading men of letters in Scotland and England. He corresponded with Hamilton of Bangour (q.v.), Somerville (q.v.), Gay (q.v.) and Pope. Gay visited him in Edinburgh, and Pope praised his pastoral—compliments which were undoubtedly responsible for some of Ramsay's unhappy poetic ventures beyond his Scots vernacular. The poet had for many years been a warm supporter of the stage. Some of his prologues and epilogues were written for the London theatres. In 1736 he set about the erection of a new theatre, "at vast expense," in Carrubber's Close, Edinburgh; but the opposition was too strong, and the new house was closed in 1737. In 1755 he retired from his shop to the house on the slope of the Castle Rock, still known as Ramsay Lodge. In this house, called by his friends "the goose-pie," because of its octagonal shape, the poet died on the 7th of January 1758.

Ramsay's importance in literary history is twofold. As a pastoral writer ("in some respects the best in the world," according to Leigh Hunt) he contributed, at an early stage, to the naturalistic reaction of the 18th century. His *Gentle Shepherd*, by its directness of impression and its appreciation of country life, anticipates the attitude of the school which broke with neo-classical tradition. It has the "mixed" faults which make the greater poem of his Scots successor, Thomson, a "transitional" document, but these give it an historical, if not an individual, interest. His chief place is, however, as an editor. He is the connecting-link between the greater "Makars" of the 15th and 16th centuries, and Fergusson (q.v.) and Burns. He revived the interest in vernacular literature, and directly inspired the genius of his greater successors. The preface to his *Ever Green* is a protest against "imported trimming" and "foreign embroidery in our writings," and a plea for a return to simple Scottish tradition. He had no scholarly interest in the past, and he never hesitated to transform the texts when he could give contemporary "point" to a poem; but his instinct was good, and he did much to stimulate an ignorant public to fresh enjoyment. In this respect, too, he anticipates the reaction in England which followed securely on the publication of Percy's *Reliques*.

The Tea-Table Miscellany was reprinted in 1871 (2 vols., Glasgow; John Crum); *The Ever Green* in 1875 (2 vols., Glasgow; Robert Forrester); *The Poems of Allan Ramsay* in 1877 (2 vols., Paisley; Alex. Gardner). These volumes are uniform in size and binding, though issued by different publishers, u.s. A selection of the *Poems* appeared in 1887 (1 vol. 16mo, London; Walter Scott). There are many popular reprints of *The Gentle Shepherd*. (G. G. S.)

RAMSAY, ALLAN (1713–1784), Scotch portrait-painter, the eldest son of the author of *The Gentle Shepherd*, was born at Edinburgh in 1713. Ramsay manifested an aptitude for art from an early period, and at the age of twenty we find him in London studying under the Swedish painter Hans Huyssing, and at the St Martin's Lane Academy; and in 1736 he left for Rome, where he worked for three years under Solimena and Imperiali (Fernandi). On his return he settled in Edinburgh; and, having attracted attention by his head of Forbes of Culloden and his full-length of the duke of Argyll, he removed to London, where he was patronized by the duke of Bridgewater. His pleasant manners and varied culture, not less than his artistic skill, contributed to render him popular. In 1767 he was appointed to succeed Shakelton as principal painter to the king; and so fully employed was he on the royal portraits which the king was in the habit of presenting to ambassadors and colonial governors, that he was forced to take advantage of the services of a host of assistants—of whom David Martin and Philip Reinagle are the best known. His life in London was varied by frequent visits to Italy, where he occupied himself more in literary and antiquarian research than with art. But this prosperous career came to an end, his health being shattered by an accidental dislocation of the

right arm. With unflinching pertinacity he struggled till he had completed a likeness of the king upon which he was engaged at the time, and then started for his beloved Italy, leaving behind him a series of fifty royal portraits to be completed by his assistant Reinagle. For several years he lingered in the south, his constitution finally broken. He died at Dover on the 10th of August 1784.

Among his most satisfactory productions are some of his earlier ones, such as the full-length of the duke of Argyll, and the numerous bust-portraits of Scottish gentlemen and their ladies which he executed before settling in London. They are full of both grace and individuality; the features show excellent draughtsmanship; and the flesh-painting is firm and sound in method, though frequently tending a little to hardness and opacity. His full-length of Lady Mary Coke is remarkable for the skill and delicacy with which the white satin drapery is managed; while in the portrait of his brown-eyed wife, the eldest daughter of Sir Alexander Lindsay of Evelick, in the Scottish National Gallery, we have a sweetness and tenderness which shows the painter at his highest. This last-named work shows the influence of French art, an influence which helped greatly to form the practice of Ramsay, and which is even more clearly visible in the large collection of his sketches in the possession of the Royal Scottish Academy and the Board of Trustees, Edinburgh.

RAMSAY, SIR ANDREW CROMBIE (1814-1891), British geologist, was born at Glasgow on the 31st of January 1814, being the son of William Ramsay, manufacturing chemist. He was for a time actually engaged in business, but from spending his holidays in Arran he became interested in the study of the rocks of that island, and was thus led to acquire the rudiments of geology. A geological model of Arran, made by him on the scale of two inches to the mile, was exhibited at the meeting of the British Association at Glasgow in 1840, and attracted the notice of Sir R. I. Murchison, with the result that he received from De la Beche an appointment on the Geological Survey, on which he served for forty years, from 1841 to 1881. He was first stationed at Tenby, and to that circumstance may be attributed the fact that so much of his geological work dealt with Wales. His first book, *The Geology of the Isle of Arran*, was published in 1841. In 1845 he became local director for Great Britain, but he continued to carry on a certain amount of field-work until 1854. To the first volume of the *Memoirs of the Geological Survey* (1846) he contributed a now classic essay, "On the Denudation of South Wales and the Adjacent Counties of England," in which he advocated the power of the sea to form great plains of denudation, although at the time he underestimated the influence of subaerial agents in sculpturing the scenery. In 1866 he published *The Geology of North Wales* (vol. iii. of the *Memoirs*), of which a second edition was published in 1881. He was chosen professor of geology at University College, London, in 1848, and afterwards lecturer in the same subject at the School of Mines in 1851. Eleven years later he was elected to the presidential chair of the Geological Society, and in 1872 he succeeded Murchison as director-general of the Geological Survey. In 1880 he acted as president of the British Association at Swansea, and in the following year retired from the public service, receiving at the same time the honour of knighthood. In 1860 he published a little book entitled *The Old Glaciers of Switzerland and North Wales*. The study of this subject led him to discuss the *Glacial Origin of Certain Lakes in Switzerland, the Black Forest, &c.* He dealt also with the origin of *The Red Rocks of England* (1871) and *The River Courses of England and Wales* (1872). He was especially interested in tracing out the causes which have determined the physical configuration of a district, and he devoted much attention to the effects produced by ice, his name being identified with the hypothesis, which, however, has never commanded general assent, that in some cases lake basins have been scooped out by glaciers. A master in the broader questions of stratigraphy and physical geology, he was a clear exponent of facts, but rather impatient of details, while his

original and often bold theories, expressed both in lectures and in writings, stirred others with enthusiasm and undoubtedly exercised great influence on the progress of geology. His lectures to working men, given in 1863 in the Museum of Practical Geology, formed the nucleus of his famous *Physical Geology and Geography of Great Britain* (5th ed., 1878; 6th ed., by H. B. Woodward, 1894). He received a Royal medal in 1880 from the Royal Society, of which he became a fellow in 1862; he was also the recipient of the Neill prize of the Royal Society of Edinburgh in 1866, and of the Wollaston medal of the Geological Society of London in 1871. He died at Beaumaris on the 9th of December 1891.

See *Memoir*, by Sir A. Geikie, 1895.

RAMSAY, ANDREW MICHAEL (1686-1743), French writer, of Scottish birth, commonly called the "Chevalier Ramsay," was born at Ayr on the 9th of January 1686. Ramsay served with the English auxiliaries in the Netherlands, and in 1710 visited Fénelon, who converted him to Roman Catholicism. He remained in France until 1724, when he was sent to Rome as tutor to the Stuart princes, Charles Edward and Henry, the future cardinal of York. He was driven by intrigue from this post, and returned to Paris. He was in England in 1730, and received an honorary degree from the university of Oxford. The claim was nominally his discipleship to Fénelon, but in reality beyond doubt his connexion with the Jacobite party. He died at St Germain-en-Laye (Seine-et-Oise) on the 6th of May 1743. Ramsay's principal work was *Les voyages de Cyrus* (London, 1728; Paris, 1727), a book composed in avowed imitation of *Télémaque*. He also edited *Télémaque* itself (Paris, 2 vols., 1717) with an introduction, and wrote a *Histoire de la vie et des ouvrages de Fénelon* (The Hague, 1723), besides a partial biography (Paris, 1735) of Turenne, some poems (Edinburgh, 1728) in English, and other miscellaneous works.

RAMSAY, DAVID (1749-1815), American physician and historian, the son of an Irish emigrant, was born in Lancaster county, Pennsylvania, on the 2nd of April 1749. He graduated at Princeton in 1765, and M.B. at the University of Pennsylvania in 1773, and then settled as a physician at Charleston, South Carolina, where he had a large practice. During the War of Independence he served as a field-surgeon (1780-1781), and from 1776 to 1783 he was a member of the South Carolina legislature. Having acted as one of the "council of safety" at Charleston, he was, on the capture of that city in 1780, seized by the British as a hostage, and for nearly a year was kept in confinement at St Augustine. From 1782 to 1786 he served in the Continental Congress, and from 1801 to 1815 in the state Senate, of which he was long president. In 1785 he published in two volumes *History of the Revolution of South Carolina*, in 1789 in two volumes *History of the American Revolution*, in 1807 a *Life of Washington*, and in 1809 in two volumes a *History of South Carolina*. He was also the author of several minor works. He died at Charleston on the 8th of May 1815 from a wound inflicted by a lunatic. His *History of the United States* in 3 vols. was published posthumously in 1816-1817, and forms the first three volumes of his *Universal History Americanized*, published in 12 vols. in 1810.

RAMSAY, ROBERT (1842-1882), Australian statesman, was a native of Hawick, Roxburghshire, but his parents emigrated to Victoria when he was a child of four, and he was educated at the Scottish college in Melbourne. He studied law at Melbourne University, and subsequently became a member of a well-known firm of solicitors in the city. He married in 1868 Isabella Catherine Urquhart, and in 1870 entered the assembly for East Bourke in the Conservative and free trade interest. He was a member of the government of James Goodall Francis in 1872-74. He was subsequently postmaster-general (1874-75) in the administration of George Biscoe Kerferd; he held the same office in conjunction with the ministry of education (1875-77) under Sir James M'Culloch; and for a short term in 1880 he was chief secretary and minister of education in the first administration of James Service. He died on the 23rd of May 1882.

RAMSAY, SIR WILLIAM (1852–), British chemist, nephew of Sir A. C. Ramsay, was born at Glasgow on the 2nd of October 1852. From 1866 to 1870 he studied in his native city, and then went to work under R. Fittig at Tübingen. Returning to Glasgow in 1872 he became assistant in the Young laboratory of technical chemistry at Anderson's College, and from 1874 acted as tutorial assistant in chemistry at the university. In 1880 he was appointed to the chair of chemistry at University College, Bristol, becoming principal in the following year, and in 1887 he succeeded A. W. Williamson as professor of chemistry at University College, London. His earlier work was mainly concerned with organic chemistry, and he published researches on picoline and its derivatives in 1876–78 and on quinine and its decomposition products in 1878–79. Later his attention was taken up with questions of physical and inorganic chemistry. With Sydney Young and others he investigated the critical state and properties of liquids and the relationship between their vapour pressures and temperature, and with John Shields he applied measurements of the surface tension of liquids to the determination of their molecular complexity. In 1804 he was associated with Lord Rayleigh in the discovery of argon, announced at that year's meeting of the British Association in Oxford, and in the following year he found in certain rare minerals such as cleveite the gas helium which till that time had only been known on spectroscopic evidence as existing in the sun. In 1898 his work with Morris William Travers (b. 1872), who from 1894 had assisted him at University College, London, and in 1903 was appointed professor of chemistry at University College, Bristol, enabled him to announce the existence in the atmosphere of three new gases, neon, krypton and xenon. Turning to the study of radioactivity, he noticed its association with the minerals which yield helium, and in support of the hypothesis that that gas is a disintegration-product of radium he proved in 1903 that it is continuously formed by the latter substance in quantities sufficiently great to be directly recognizable in the spectroscope. Among the books written by Sir William Ramsay, who was created K.C.B. in 1902, are *A System of Chemistry*, 1891, *The Gases of the Atmosphere*, 1896, and *Modern Chemistry*, vol. i. *Theoretical*, vol. ii. *Systematic*, 1901, and he edited a series of "Textbooks of Physical Chemistry."

RAMSAY, SIR WILLIAM MITCHELL (1851–), British archaeologist, was born on the 15th of March 1851. He was educated at the universities of Aberdeen, Oxford and Göttingen, and was a fellow of Exeter College, Oxford (1882; honorary fellow 1898), and Lincoln College (1885; honorary 1899). In 1885 he was elected professor of classical art at Oxford, and in the next year professor of humanity at Aberdeen. From 1880 onwards he travelled widely in Asia Minor and rapidly became the recognized authority on all matters relating to the districts associated with St Paul's missionary journeys and on Christianity in the early Roman Empire. He received the honorary degrees of D.C.L. Oxford, LL.D. St Andrews and Glasgow, D.D. Edinburgh, and was knighted in 1906. He was elected a member of learned societies in Europe and America, and has been awarded medals by the Royal Geographical Society, the Royal Scottish Geographical Society and the University of Pennsylvania. His numerous publications include: *The Historical Geography of Asia Minor* (1890); *The Church in the Roman Empire* (1893); *The Cities and Bishoprics of Phrygia* (2 vols., 1895, 1897); *St Paul the Traveller and the Roman Citizen* (1895; Germ. trans., 1898); *Impressions of Turkey* (1897); *Was Christ born at Bethlehem?* (1898); *Historical Commentary on Galatians* (1899); *The Education of Christ* (1902); *The Letters to the Seven Churches of Asia* (1905); *Pauline and other Studies in Early Christian History* (1906); *Studies in the History and Art of the Eastern Provinces of the Roman Empire* (1906); *The Cities of St Paul* (1907); *Lucan and Pauline Studies* (1908); *The Thousand and One Churches* (with Miss Gertrude L. Bell, 1909); and articles in learned periodicals and the 9th, 10th and 11th editions of the *Encyclopaedia Britannica*. His wife, Lady Ramsay, granddaughter of Dr Andrew Marshall of Kirkintilloch, accompanied him in many of his journeys and is the

author of *Everyday Life in Turkey* (1897) and *The Romance of Elisavet* (1899).

RAMSBOTTOM, an urban district in the Heywood parliamentary division of Lancashire, England, 4 m. N. of Bury, on the Lancashire & Yorkshire railway. Pop. (1901) 15,920. It has iron and brass foundries, machine factories and textile establishments.

RAMSDEN, JESSE (1735–1800), English astronomical instrument maker, was born at Salterhebble near Halifax, Yorkshire, on the 6th of October 1735. After serving his apprenticeship with a cloth-worker in Halifax, he went in 1755 to London, where in 1758 he was apprenticed to a mathematical instrument maker. About four years afterwards he started business on his own account and secured a great reputation with his products. He died at Brighton on the 5th of November 1800. Ramsden's speciality was divided circles, which began to supersede the quadrants in observatories towards the end of the 18th century. His most celebrated work was a 5-foot vertical circle, which was finished in 1789 and was used by G. Piazzi at Palermo in constructing his well-known catalogue of stars. He was the first to carry out in practice a method of reading off angles (first suggested in 1768 by the duke of Chaulnes) by measuring the distance of the index from the nearest division line by means of a micrometer screw which moves one or two fine threads placed in the focus of a microscope. Ramsden's transit instruments were the first which were illuminated through the hollow axis; the idea was suggested to him by Prof. Henry Ussher in Dublin. He published a *Description of an Engine for dividing Mathematical Instruments* in 1777.

RAMSEY, a market-town in the Northern or Ramsey parliamentary division of Huntingdonshire, England, on the south-western border of the Fen country, on branch lines of the Great Northern and the Great Eastern railways, 13 m. S.S.E. of Peterborough. Pop. of urban district (1901) 4823. The fine church of St Thomas à Becket is transitional between Norman and Early English, and has a beautiful Norman east end. The tower was built in 1672 of stone from Ramsey Abbey. An old oak lectern, dating from the middle of the 15th century, carries a chained copy, in a Tudor binding of brass, of Dean Comber's (1655–99) book on the Common Prayer, and a black-letter copy of Erasmus's Paraphrase of the Gospels. There are many interesting tombs in the churchyard, and the church register contains several entries relating to the Cromwell family, who removed hither from Huntingdon and owned the abbey estates till 1674. Of the ancient Benedictine abbey, the only remains are a part of a gateway, a lodge (a beautiful Perpendicular relic) and some buttresses, while some broken stone arches and walls remain of the conventual buildings. The modern mansion of Ramsey Abbey contains many documentary relics of the abbey, as well as an early monument representing the founder.

According to a 12th-century chronicle of one of the monks, the name Ramsey is derived from the words "ram," referring to the tradition of a solitary ram having taken up its abode here, and "ey" meaning an island. Ramsey, however, was not completely insulated, like some of the monasteries of the Fen district. The abbey was founded by Ailwin, earl of the East Angles, in 969, and a charter of King Edgar granted lands and privileges for the purpose. Ramsey Abbey was noted for the school established within its walls, and for its library of Hebrew works. Its abbot was mitred. The lands were granted after the dissolution to Sir Richard Cromwell.

RAMSEY, a seaport and watering-place on the north-east coast of the Isle of Man, 15 m. N.N.E. of Douglas. Pop. (1901) 4729. It lies on the wide Ramsey Bay, at the mouth of the Sulby river, the estuary of which forms a small harbour. To the north and west the country is flat, but to the south the lower slopes of the North Ballure hill rise sharply. A creek of the Sulby river on the north side of the town is formed into a picturesque lake. The Queen's pier permits of the landing of passengers at all times, and Ramsey is served by

frequent steamers from Liverpool and other ports. The shore of the bay is sandy and gently sloping, and excellent bathing is afforded. A golf links, a geological and antiquarian museum, the Mooragh Park by the side of the lake, and the palace or concert hall, are among the attractions to visitors. Ramsey is connected with Laxey, the summit of Snaefell, and Douglas by electric tramway, and has connexion with the western part of the island by the Manx Northern railway. The Albert tower, on a wooded hill above the town, commemorating a visit of the Prince Consort in 1847, is a favourite view-point. The harbour has some coasting and fishing trade.

RAMSGATE, a municipal borough, watering-place, seaport and member of the Cinque Port of Sandwich, in the Isle of Thanet parliamentary division of Kent, England, 79 m. E. by S. of London by the South Eastern & Chatham railway. Pop. (1901) 27,733. This is one of the most popular resorts on the Kent coast, well situated on the east coast of Thanet, practically contiguous with Broadstairs to the north, with which and Margate to the north-west it is united by an electric tramway. During the season steamers connect it with London and the intermediate watering-places on the north coast, and with Calais and Boulogne. The harbour has an area of 42 acres, and a considerable coasting and fishing trade is carried on. There is a fine sea front, and the beach is of firm sand. The promenade pier was erected in 1881. Near it an obelisk commemorates the departure of George IV. to Hanover from here, and his return, in 1821. The church of St George was built in 1826, its tower forming a conspicuous landmark, and the Roman Catholic church of St Augustine was built from the designs and at the expense of A. W. Pugin, who was long a resident here. The neighbouring Pegwell Bay, famed for its shrimps, is supposed to have been the scene of the landing of Hengist and Horsa, and at Cliff's End (Ebbs Fleet) a monolithic cross marks the landing-place of St Augustine in 596. On the summit of Osengal Hill, about a mile to the west of the town, a graveyard of early Saxon settlers was discovered during the cutting of the railway. The remains proved it to belong to the 5th and 6th centuries. Ramsgate was incorporated in 1884, and is governed by a mayor, 6 aldermen and 18 councillors. Area, 2304 acres.

Ramsgate (Ramesgate) was originally a small but comparatively prosperous place united until 1827 to the parish of St Lawrence. The charter of Charles II. mentions it as having been "time out of mind" a member of Sandwich. In 1884 it was incorporated by royal charter, under the title of mayor, aldermen and councillors. A commission of the peace was granted in 1893. Since then the jurisdiction of the Cinque Ports' justices has ceased within its limits, which include the parishes of Ramsgate and St Lawrence Intra. A daily market was obtained in 1784 by grant from George III. No fair was then held, but from 1792 onwards there has been one yearly on the 10th of August. Under Elizabeth, Ramsgate was still unimportant though possessed of a fair before the reign of Henry VIII. After 1668 the growth of trade increased its prosperity, and at the beginning of the reign of George I. the pier was enlarged and pier-wardens appointed to collect the *droits*. In 1749, having been selected as a Harbour of Refuge for the Downs, it underwent great improvements, and henceforward paid £200 yearly to Sandwich out of the *droits* for clearing the Channel and repairing the banks of the river Stour within the Liberty; but by 1790 the harbour was of small account.

RAMSONS, in botany, the popular name for *Allium ursinum*, a bulbous plant 6 to 18 in. high, with ovate-lanceolate stalked leaves tapering at the apex, surrounding a naked stalk bearing a flat-topped umbel of small white flowers. A rather pretty plant, common in woods and in hedgebanks in spring, but with a pungent garlic-like smell, which is characteristic of the genus (see **ALLIUM**).

RAMUS, PETRUS, or **PIERRE DE LA RAMÉE** (1515-1572), French humanist, was born at the village of Cuth in Picardy in 1515, a member of a noble but impoverished family; his

father was a charcoal-burner. Having gained admission, in a menial capacity, to the college of Navarre, he worked with his hands by day and carried on his studies at night. The reaction against scholasticism was still in full tide; it was the transition time between the old and the new, when the eager and forward-looking spirits had first of all to do battle with scholastic Aristotelianism. Ramus outdid his predecessors in the impetuosity of his revolt. On the occasion of taking his degree (1536) he actually took as his thesis "Everything that Aristotle taught is false." This *tour de force* was followed up by the publication in 1543 of *Aristotelicæ Animadversiones* and *Dialecticæ Partitiones*, the former a criticism on the old logic and the latter a new textbook of the science. What are substantially fresh editions of the *Partitiones* appeared in 1547 as *Institutiones Dialecticæ*, and in 1548 as *Scholæ Dialecticæ*; his *Dialectique* (1555), a French version of his system, is the earliest work on the subject in the French language. Meanwhile Ramus, as graduate of the university, had opened courses of lectures; but his audacities drew upon him the hostility of the conservative party in philosophy and theology. He was accused of undermining the foundations of philosophy and religion, and the matter was brought before the parlement of Paris, and finally before Francis I. By him it was referred to a commission of five, who found Ramus guilty of having "acted rashly, arrogantly and impudently," and interdicted his lectures (1544). He withdrew from Paris, but soon afterwards returned, the decree against him being cancelled through the influence of the cardinal of Lorraine. In 1551 Henry II. appointed him professor of philosophy and eloquence at the Collège de France, where for a considerable time he lectured before audiences numbering as many as 2000. He published fifty works in his lifetime and nine appeared after his death. In 1561, however, the enmity against him was fanned into flame by his adoption of Protestantism. He had to flee from Paris; and, though he found an asylum in the palace of Fontainebleau, his house was pillaged and his library burned in his absence. He resumed his chair after this for a time, but in 1568 the position of affairs was again so threatening that he found it advisable to ask permission to travel. Returning to France he fell a victim to his opponents in the massacre of St Bartholomew (1572).

The logic of Ramus enjoyed a great celebrity for a time, and there existed a school of Ramists boasting numerous adherents in France, Germany and Holland. As late as 1626 F. Burgersdyk divides the logicians of his day into the Aristotelians, the Ramists and the Semi-Ramists, who endeavoured, like Goclenius of Marburg, to mediate between the contending parties. Ramus's works appear among the logical textbooks of the Scottish universities, and he was not without his followers in England in the 17th century. There is even a little treatise from the hand of Milton, published two years before his death, called *Artis Logicæ Plenior Institutio ad Petri Rami Methodum concinnata*. It cannot be said, however, that Ramus's innovations mark any epoch in the history of logic. His rhetorical leaning is seen in the definition of logic as the "ars disserendi"; he maintains that the rules of logic may be better learned from observation of the way in which Cicero persuaded his hearers than from a study of the *Organon*. The distinction between natural and artificial logic, *i.e.* between the implicit logic of daily speech and the same logic made explicit in a system, passed over into the logical handbooks. Logic falls, according to Ramus, into two parts—*invention* (treating of the notion and definition) and *judgment* (comprising the judgment proper, syllogism and method). This division gave rise to the jocular designation of judgment or mother-wit as the "*secunda Petri*." He is, perhaps, most suggestive in his emendations of the syllogism. He admits only the first three figures, as in the original Aristotelian scheme, and in his later works he also attacks the validity of the third figure, following in this the precedent of Laurentius Valla. Ramus also set the modern fashion of deducing the figures from the position of the middle term in the premises, instead of basing them, as Aristotle does, upon the different relation of the middle to the so-called major and minor term. On the whole, however, though Ramus may be allowed to have advanced logical study by the wholesome fermentation of thought which he caused, there is little ground for his pretentious claim to supersede Aristotle by a new and independent system.

See Waddington-Kastus, *De Petri Rami vita, scriptis, philosophia* (Paris, 1848); Charles Desmaze, *Petrus Ramus, professeur au Collège de France, sa vie, ses écrits, sa mort* (Paris, 1864); P. Lobstein,

P. Ramus als Theolog (Strassburg, 1878); E. Saisset, *Les précurseurs de Descartes* (Paris, 1862); J. Owen, *French Skeptics of the Renaissance* (London, 1893); K. Prantl, "Über P. Ramus" in *Münchener Sitzungsberichte* (1878); H. Höfding, *Hist. of Mod. Phil.* (Eng. trans., 1900), vol. i. 185; Voigt, *Über den Ramismus der Universität Leipzig* (Leipzig, 1888).

RAMUSIO. The noble Italian family of Ramusio—the spelling adopted in the publication of the *Navigazioni*, though it is also written Ramnusio, Rhamnusio, Rannusio, &c.—was one of note for literary and official ability during at least four generations. Its original home was in Rimini, and the municipality of that city has within the last few years set up a tablet on the town hall bearing an inscription which may be thus rendered: "The municipality of Rimini here records the claim of their city to the family of the Ramusios, adorned during the 15th and 16th centuries by the illustrious jurist and man of letters Paolo the elder, who rendered the work of Valturius, our fellow-citizen, into the vernacular; by the physician Girolamo, a most successful student of Oriental tongues, and the first to present Europe with a translation of Avicenna; and by Giovanni Battista, cosmographer to the Venetian republic and secretary to the Council of Ten, who bequeathed to the world that famous collection of voyages and travels, regarded in his own day as a marvellous work, and still full of authority among all civilized nations."

PAOLO THE ELDER (c. 1443–1506), the first of those thus commemorated, migrated in 1458 from Rimini to Venice, where he obtained full citizenship, studied law and became a member of the magistracy, filling the offices of *vicario*, of judicial assessor, and of criminal judge under various administrators of the Venetian provinces on the continent. He continued, however, to maintain relations with the Malatesta princes of his native city, and in 1503 negotiated with them the cession of Rimini to the republic. The wife of Paolo, bearing the singular name of Tomyris Macachio, bore him three sons and four daughters. Paolo died at Bergamo on 19th August 1506 at the age of sixty-three, and was buried in S. Agostino at Padua. Paolo was the author of a variety of legal treatises and the like, and also published at Verona in 1483 both a corrected edition and an Italian translation of a once famous book, *Valturius, De re militari*, dedicating both to Pandolfo Malatesta of Rimini.¹

GIROLAMO (1450–1486), younger brother of Paolo, had a notable history. After he had studied medicine at Padua public suspicion was roused against him in connexion with the death of a lady with whom he had had some love passages, and this ran so high that he was fain, by help of his brother Paolo, to whom he transferred his property, to make his escape (about 1481–1483) to Syria and to take up his abode at Damascus. In 1486 he removed to Beyrout, and died the same year, killed, as the family chronicler relates, by a surfeit of "certain fruit that we call *armellini* and *abbiococche*, but which in that country are known as *mazzafranchi*," a title which English sailors in southern regions still give to apricots in the vernacular paraphrase of *killjohns*. During his stay in Syria Girolamo studied Arabic and made a new translation of Avicenna, or rather, we may assume, of some part of that author's medical works (the *Canon*?). It was, however, by no means the first such translation, as is erroneously alleged in the Rimini inscription, for the *Canon* had been translated by Gerard of Cremona (d. 1187), and this version was frequently issued from the early press. Girolamo's translation was never printed, but was used by editors of versions published at Venice in 1579 and 1606. Other works of this questionable member of the house of Ramusio consisted of medical and philosophical tracts and Latin poems, some of which last were included in a collection published at Paris in 1791.²

GIAN BATTISTA (1485–1557), the eldest son of Paolo Ramusio and Tomyris Macachio, was born at Treviso in 1485 (June 20). Having been educated at Venice and at Padua, at an early

age he entered the public service (1505), becoming in 1515 secretary of the senate and in 1533 secretary of the Council of Ten. He also served the republic in various missions to foreign states, e.g. to Rome, to Switzerland and to France, travelling over much of the latter country by special desire of the king, Louis XII. He also on several occasions filled the office of *cancellier grande*. In 1524 he married Franceschina, daughter of Francesco Navagero, a noble—a papal dispensation being required on account of her being cousin to his mother Tomyris. By this lady he had one son, Paolo. In his old age Ramusio resigned the secretaryship and retired to the Villa Ramusia, a property on the river Masanga, in the province of Padua, which had been bestowed on his father in 1504 in recognition of his services in the acquisition of Rimini the year before. The delights of this retreat are celebrated in the poems and letters of several of Gian Battista's friends. He also possessed a house at Padua in the Strada del Patriarcato, a mansion noted for its paintings and for its collection of ancient sculpture and inscriptions. These, too, are commemorated by various writers. A few days before his death Ramusio removed to this house in Padua, and there died, 10th of July 1557, at the age of seventy-two. He was, by his own desire, buried at Venice, in the tomb which he had made for his mother, in Santa Maria dell' Orto. His wife's death had occurred in 1536. In the work called *Museum Mazzuchellianum* (Venice, 1761, vol. i. pl. lxiv. No. 6) there is represented a 16th-century medal of Ramusio, which looks a genuine likeness, and a bronze example of which, without the reverse,³ is preserved in St Mark's Library. There was a portrait of him, represented as in conversation with Andrea Gradenigo, in the Sala del Maggior Consiglio, but in 1577 this perished in a fire, as did also a portrait of his father, Paolo. A professed portrait of Gian Battista by Francesco Grisellini, in the Sala dello Scudo, appears to be, like the companion portrait of Marco Polo, a work of fancy. A public nautical school at Rimini received from the government the title of the Istituto Ramusio.

Ramusio was evidently a general favourite, as he was free from pushing ambition, modest and ingenuous, and, if it be safe to judge from some of the dissertations in his *Navigazioni*, must have been a delightful companion; both his friend Giunti and the historian Giustiniani⁴ speak of him with the strongest affection. He had also a great reputation for learning. Before he was thirty Aldus Manutius the elder dedicated to him his edition of Quintilian (1514); a few years later (1519) Francesco Ardano inscribed to him an edition of Livy, and in 1528 Bernardino Donati did the like with his edition of Macrobius and Censorinus. To Greek and Latin and the modern languages of southern Europe he is said to have added a knowledge of "Oriental tongues," but there is no evidence how far this went, unless we accept as such a statement that he was selected in 1530 on account of this accomplishment to investigate the case of one David, a Hebrew, who, claiming to be of the royal house of Judah, wished to establish himself at Venice outside of the Ghetto.⁵ But Ramusio had witnessed from his boyhood the unrolling of that great series of discoveries by Portugal and Spain in East and West, and the love of geography thus kindled in him

³ The reverse is an amorphous map. The book is in the British Museum.

⁴ *Rerum Venetarum . . . Historia*, bk. xiv.

⁵ Ramusio's report on this Hebrew is preserved in the diaries of Marcus Sanudo, and is printed by Cigogna. It is curious. David represented himself as a prince of the Bedouin Jews who haunt the caravan-road between Damascus and Medina; he claimed to be not only a great warrior covered with wounds but great also in the law and in the cabala, and to have been inspired by God to conduct the dispersed tribes to the Holy Land and to rebuild the temple. In this view he had visited Prester John and the Jews in his kingdom, and then various European countries. David was dark in complexion, "like an Abyssinian," lean, dry and Arab-like, well dressed and well attended, full of pretensions to supernatural cabalistic knowledge, and with enthusiastic ideas about his mission, whilst the Jews regarded him as a veritable Messiah.

¹ Both works are in the British Museum.

² "Ramusii Ariminensis Carmina," in *Quinque Illustrium Poetarum . . . Lus in Venerem*. Girolamo's are grossly erotic.

made that branch of knowledge through life his chief study and delight. He is said, with the assistance of friends touched by the same flame, to have opened a school for geography in his house at Venice. And it appears from a letter addressed to him by his friend Andrea Navagero, that as early as 1523 the preparation of material for his great work had already begun. The task had been suggested and encouraged, as Ramusio himself states in a dedicatory epistle to the famous Girolamo Fracastoro, by that scholar, his lifelong friend; an address to the same personage indeed introduced each of the three volumes, and in the first the writer speaks of his desire to bequeath to posterity, along with his labours, "a testimony to the long and holy friendship that had existed between the two." They were contemporaries in the strictest sense (Ramusio 1485-1557, Fracastorius 1483-1553). His correspondence, which was often devoted to the collection of new material for his work, was immense, and embraced many distinguished men. Among those whose names have still an odour of celebrity were Fracastoro, just mentioned, Cardinal Pietro Bembo, Damiano de Goetz, and Sebastian Cabot; among lesser lights, Vettor Fausto, Daniel Barbaro, Paolo Manuzio, Andrea Navagero, the cardinals Gasparo Contarini and Gregorio Cortese, and the printer Tommaso Giunti, editor after Ramusio's death of the *Navigazioni*.

Two volumes only of the *Navigazioni e Viaggi* were published during the life of Gian Battista, vol. i. in 1550, vol. iii. in 1556; vol. ii. did not appear till 1559, two years after his death, delayed, as his friend and printer T. Giunti explains, not only by that event but by a fire in the printing-office (November 1557), which destroyed a part of the material which had been prepared. It had been Ramusio's intention to publish a fourth volume, containing, as he mentions himself, documents relating to the Andes, and, as appears from one of the prefaces of Giunti, others relating to explorations towards the Antarctic.¹ Ramusio's collection was by no means the first of the kind, though it was, and we may say on the whole continues to be, the best. Even before the invention of the press such collections were known, of which that made by a certain Long John of Yprès, abbot of St Bertin, in the latter half of the 14th century was most meritorious, and afforded in its transcription a splendid field for embellishment by the miniaturists, which was not disregarded. The best of the printed collections before Ramusio's was the *Novus Orbis*, edited at Basel by Simon Grynaeus in 1532, and reissued in 1537 and 1555. This, however, can boast of no disquisitions nor of much editorial judgment. Ramusio's collection is in these respects far superior, as well as in the variety and fulness of its matter. He spared no pains in ransacking Italy and the Spanish peninsula for contributions, and in translating them when needful into the racy Italian of his day. Several of the pieces are very rare in any other shape than that exhibited in Ramusio's collection; several besides of importance—e.g. the invaluable travels of Barbosa and Pigafetta's account of Magellan's voyage—were not publicly known in any complete form till the present century. Of two important articles at least the originals have never been otherwise printed or discovered; one of these is the *Summary of all the Kingdoms, Cities, and Nations from the Red Sea to China*, a work translated from the Portuguese, and dating apparently from about 1535; the other, the remarkable Ramusian redaction of Marco Polo (*q.v.*). The *Prefazione*, *Esposizione* and *Dichiarazione*, which precede this version of Marco Polo's book, are the best and amplest examples of Ramusio's own style as an editor. They are full of good sense and of interesting remarks derived from his large reading and experience, and few pictures in words were ever touched more delightfully than that in which he sketches the return of the Polo family to their native city, as he had received it in the tradition of the Venetian elders.

There were several editions of the *Navigazioni e Viaggi*, and

¹ See in vol. iii. the end of Ramusio's *Discorso* on the conquest of Peru, and Giunti's "Alli Lettori" in the 3rd edition of the first volume.

as additions continued to be made to the several volumes a good deal of bibliographical interest attaches to these various modifications.² The two volumes (i. and iii.) published in Ramusio's lifetime do not bear his name on the title-page, nor does it appear in the addresses to his friend Fracastorius with which these volumes begin (as does also the second and posthumous volume). The editions of vol. i. are as follows: 1550, 1554, 1563, 1588, 1606, 1613.³ The edition of 1554 contains the following articles which are not in that of 1550: (1) copious index; (2) "Narr. di un Compagno di Barbosa"; (3) "Informationi del Giapan"; (4) "Alli Lettori di Giov. de Barros"; (5) "Capitoli estratti da di Barros." The edition of 1563 adds to these a preliminary leaf concerning Ramusio, "Tommaso Giunti alli Lettori." After 1563 there is no change in the contents of this volume, only in the title-page. It should be added that in the edition of 1554 there are three double-page woodcut maps (Africa, India and India extra Gangem), which do not exist in the edition of 1550, and which are replaced by copperplate maps in subsequent editions. These maps are often missing. The editions of vol. ii. are as follows: 1559, 1574, 1583, 1606. There are important additions in the 1574 copy, and still further additions in that of 1583. The additions made in 1574 were: (1) "Herberstein, Della Moscovia e della Russia"; (2) "Viaggio in Persia di Caterino Zeno"; (3) "Scoprimiento dell' Isola Frislanda, &c., per due fratelli Zeni"; (4) "Viaggi in Tartaria per alcuni frati Minori"; (5) "Viaggio del Beato Odorico" (two versions). Further additions made in 1583 were: (1) "Navigatione di Seb. Cabota"; (2) at the end 90 ff. with fresh pagination, containing ten articles on "Sarmatia, Polonia, Lithuania, Prussia, Livonia, Moscovia, and the Tartars by Aless. Guagnino and Matteo di Micheovo." The two latest "editions" of vol. ii. are identical, *i.e.* from the same type, with a change of title-page only, and a reprint of the last leaf of the preface and of the last leaf of the book. But the last circumstance does not apply to all copies. In one, whilst the title bears 1606, the colophon bears "Appresso i Giunti, 1583." Vol. iii. editions are of 1556, 1565 and 1606.⁴ There is no practical difference between the first two, but that of 1606 has forty-five pages of important new matter, which embraces the *Travels of Cesare Fedrici or Federici in India*, one of the most valuable narratives of the 16th century, and *Three Voyages of the Hollanders and Zealanders to Nova Zembla and Groenland*. Vol. iii. also contains (omitting maps and figures inserted in the text, or with type on the reverse) a two-page topographical view of Cuzco, a folding map of Terra Nova and Labrador, a two-page map of Brazil, a two-page map of Guinea, &c., a two-page map of Sumatra, a two-page pictorial plan of the town of Hochelaga in New France, and a general map of the New World in a hemisphere. Brunet's statement mentions issues of vol. ii. in 1564, and of vol. iii. in 1613; but these seem to have no existence. It would thus appear that a set of Ramusio, to be as complete as possible, should embrace—for vol. i., 1563 or any subsequent edition; for vol. ii., 1583 or 1606; for vol. iii., 1606.

PAOLO (GIROLAMO GASPARE)⁵ (1532-1600) was the only child of Gian Battista, and was born on the 4th of July 1532. Like his father, he maintained a large correspondence with many persons of learning and note. In 1541 Francesco Contarini, procurator of St Mark's, brought from Brussels a MS. of Villehardouin's *History of the Conquest of Constantinople*, which he presented to the Council of Ten. In 1556 they publicly ordered its translation into Latin, and gave the commission to Paolo Rannusio. His father also seems to have taken much interest in the work, for a MS. vernacular translation by him exists in the Marciana. Paolo's book was not completed

² Brunet's statements on the subject are borrowed, and not quite accurate. The detail in Cigogna seems to be accurate, but it is vague as to the deficiencies of the earlier editions.

³ All of these are in the British Museum.

⁴ All at the British Museum.

⁵ This person and his son affected the spelling Rannusio.

till 1573, many years after the father's death, and was in fact a paraphrase enlarged from other sources, thus, according to Cigogna's questionable judgment, "converting the dry story of Villehardouin into an elegant (*fiorita*) historical work." It was not published till 1609, nine years after Paolo's death; nor was it ever really reprinted, though it became the subject of a singular and unintelligible forgery. For Jacopo Gaffarelli, who was sent to Venice to buy books for Richelieu, having apparently procured the "remainder" copies, removed the title and preliminary pages and substituted a fresh title with the date 1634, and a dedication to his master the cardinal.¹

GIROLAMO GIUSEPPE (1555-1611), the son of Paolo, was born at Venice in 1555. He entered the public service in 1577, and was employed in connexion with various foreign missions. In 1601 he published at Lyons the French text of Villehardouin; and, besides an Italian translation of this old historian (who seems thus to have furnished occupation for three generations of Ramusios), he left behind him a *Storia o Cronaca di Casa Ramusia*, a folio MS still in St Mark's Library. He died at Padua in 1611, and his posterity did nothing to continue the reputation of the family, official or literary.

Besides the circumstances to be gathered from the *Navigazioni* regarding the Ramusio family, see the *Iscrizioni Venete* of Emanuele Cigogna. There is also in the British Museum *Monografia letta il 14 Marzo 1883* . . . by Guglielmo Carradori (Rimini, 1883); but hardly anything has been found in this except the inscription quoted at the beginning of this article. (H. Y.)

RANADE, MAHADEO GOVIND (1842-1901), Indian lawyer, reformer and author, was born on the 16th of January 1842 at Niphad, in Nasik district, of a Chitpavan Brahman family. When his father was minister at Kolhapur he attended the Anglo-vernacular school in that town, and joined the Elphinstone Institute in Bombay at the age of fourteen. He was one of the first graduates of the Bombay University, taking the B.A. in 1862 and the LL.B. in 1866. Having entered government service he became presidency magistrate and then fourth judge of the small cause court at Bombay in 1871, first-class sub-judge at Poona in 1873, and judge of the Poona small cause court in 1884, after which, as special judge under the Deccan Agriculturists' Relief Act from 1887, he came into close contact with the difficulties of the agrarian classes. In 1886 he was a member of the finance committee appointed to report on the expenditure, both imperial and provincial, with a view to retrenchment. This service won him the decoration of C.I.E. He became a member of the legislative council of Bombay in 1885, and occupied that position until raised to the high court in 1893. Being an energetic social reformer, he directed his efforts against infant marriages, the shaving of widows, the heavy cost of marriages and other social functions, and the caste restrictions on travelling abroad. He strenuously advocated widow remarriage and female education. He was the founder of the social conference movement, which he supported till his death. In the political sphere he founded the Poona Sarvajanic Sabha, through which he frequently helped the government with sound advice. He was also one of the originators of the Indian National Congress. In Bombay University, where he held the offices of syndic and dean in arts, he displayed much organizing power and great intimacy with the needs of the student class. Himself a thorough Mahratti scholar, he encouraged the translation of standard English works, and tried, with some success, to introduce vernacular languages into the university curriculum. Though reared in the strictest tenets of Hinduism, his deep religious feeling and trained intellect craved something higher and broader than he could find in the traditional forms and orthodox teaching of his race. The same spiritual want being felt by many enlightened Hindus, he joined with his friends, Dr Atmaram Pandurang, Bal Mangesh Wagle and Vaman Abaji Modak, in founding a new sect in Bombay known as the "Parthana Samaj." This community resembles, in all essential points, the Brahma Samaj of Bengal. Its principles of enlightened theism are based on the ancient Vedas. He published

¹ In the British Museum.

books on Indian economics and on Mahratta history. He died on the 16th of January 1901. He left no children, but his widow continued his work of social and educational reform at Poona.

See G. A. Mankar, *Justice M. G. Ranade* (Bombay, 1902).

RANAVALO (RANAVALONA) III. (1864-), the last queen of Madagascar, born in 1864, was a great-niece of Radama I. Her name originally was Razafindrahety, but on succeeding to the throne of Madagascar after the death of Queen Ranavalona II., on the 14th of July 1883, she assumed the style of Ranavalona III. Although nominally queen, she took no share in the government, which her prime minister, Rainilaiarivony, had controlled since 1864. After placing her on the throne, he married her before the close of the year. Ranavalona became queen just after the French had revived their claim to a protectorate over the island. The Hova government refusing to admit the claim, war broke out, and several sharp engagements took place. The French bombarded the coast towns, but were unable to reach the interior of the island, where the strength of the Hova lay. In December 1885 a treaty was concluded by which it was agreed that the government of the French Republic should represent Madagascar in all foreign relations, but that in internal matters the Hova government should be independent, as formerly. During the next ten years French influence was quietly extended over the island, in spite of the efforts of Rainilaiarivony, who pursued an anti-French policy, encouraging English and American planters and traders. In 1894 differences on commercial and territorial questions arose between the Hova government and the French, which terminated in war. In 1895 a well-organized expedition was despatched from France to subjugate the island. Many of the inhabitants sympathized with the invaders, and even the Hova themselves were divided. Although Ranavalona endeavoured to arouse a martial spirit in her subjects, the French advanced on the capital without encountering any effective opposition. On the 30th of September they captured Antananarivo. Rainilaiarivony was sent into exile, where he died in the following year; but Ranavalona was suffered to remain as nominal head of the government, under a strict French protectorate. In August 1896, to avoid commercial difficulties with foreign powers, the island was declared a French colony; but no change was made in the internal administration. Later in the year, however, the civil governor was replaced by a military resident, General Gallieni. A formidable insurrection broke out, which Gallieni suppressed, executing or exiling several prominent members of the Hova administration. Finding that the court had been a centre of intrigue, he abolished the sovereignty by proclamation in February 1897, and exiled Ranavalona to Réunion. In March 1899 she was removed to Algiers. Her exile there was relieved by occasional visits to Paris.

RANC, ARTHUR (1831-1908), French politician and writer, was born at Poitiers on the 20th of December 1831, and was educated for the law. Implicated in a plot against Napoleon III. in 1853, he was acquitted, but shortly afterwards was imprisoned for belonging to a secret society; for his share in anti-imperialist conspiracies in 1855 he was arrested and deported to Algeria without a trial. The amnesty of 1859 permitted him to return to Paris, where he soon drew the attention of the police to his presence by his violent articles. During the siege of Paris he left the city in a balloon and joined Gambetta, for whom he organized a system of spies through which General Trochu was kept informed of the strength and disposition of the Prussians around Paris. He was elected to the National Assembly in February 1871, but resigned rather than subscribe to the peace. He had been elected mayor of the ninth arrondissement of Paris in the autumn of 1870, and in March was sent by the same district to the Commune, from which he resigned when he found no reconciliation was possible between the mayors and the Commune. In July he became a member of the municipal council of Paris, and in 1873 was returned to the National Assembly for the department of the Rhône, and took his place on the extreme Left. A month after his election the governor of Paris demanded his prosecution for his share in the Commune. The claim being granted by a large majority, he

escaped to Belgium, where he issued a pamphlet defending his action during the Commune. On his failure to appear before the court he was condemned to death, and remained in Belgium until 1879, when he was included in the amnesty proclaimed by Grévy. During his exile he continued his active collaboration on *La République française*. In 1873 he fought a duel with Paul de Cassagnac, and he acted as second to Clémenceau more than once. He energetically defended the republic against the Boulangist agitation, and took an equally courageous part in the Dreyfus affair. In the Picquart-Henry duel he was second to Colonel Picquart. He succeeded Clémenceau as editor of the *Aurore*, in which Zola's letter "J'accuse" had appeared, and was president of the Association of Republican Journalists. In 1903 he became senator for Corsica, and died on the 10th of August 1908.

In addition to his purely political writings, Arthur Rancé published political novels of the Second Empire, *Sous l'empire* (1872) and *Le roman d'une conspiration* (1868).

RANCÉ, ARMAND JEAN LE BOUTHILLIER DE (1626-1700), founder of the Trappist Cistercians. He was born in Paris of a noble and influential family of Normandy; hence, being destined to the ecclesiastical state, he was when ten years old commendatory abbot of La Trappe and two other abbeys, prior of two priories, and canon of Nôtre Dame, Paris. At twelve he published a translation of Anacreon. He went through his course of theological studies with great distinction, defeating Bossuet at the Baccalaureat in theology. He was ordained in 1651, and embarked on the ambitious and worldly career of a court abbé in the days of Louis XIV. But after a few years he underwent a complete change of life, and in 1662 he retired to his abbey of La Trappe, of which he became regular abbot in 1664 and introduced an austere reform (see TRAPPISTS). The best known episode of his subsequent life was the "Contestation" with Mabillon on the lawfulness of monks devoting themselves to study, which De Rancé denied. He resigned his abbacy in 1695, owing to declining health, and died in 1700.

The best of the early lives is that of P. le Nain, his sub-prior (1715); the most recent is by M. Serrant, *L'Abbé de Rancé et Bossuet* (1903). A sufficient sketch is given by Helyot, *Histoire des ordres religieux* (1718), vi. c. 1. On the "Contestation" on Monastic Studies, see Maitland, *Dark Ages*, § x. (E. C. B.)

RANCH, a term in current usage among the English-speaking peoples for a large farm, particularly one for cattle or horse-breeding. The word came into use in this application in the western states of North America, and was an adaptation of the Spanish-American *rancho*, herdsmen's huts; in Spanish a gathering of people having their meals in common, a mess.

RANCHI, a town and district of British India, in the Chota Nagpur division of Bengal. The town, which is situated on the Chota Nagpur plateau, about 2100 ft. above sea-level, is the headquarters of both the division and the district. Pop. (1901) 25,970. It is an important centre of local trade and the headquarters of the German Lutheran mission. There are a high school and an industrial school, and it is proposed to found here a residential college for all Bengal. The cantonments, formerly called Doranda, accommodate a detachment of native infantry.

The DISTRICT OF RANCHI, formerly called Lohardaga after the town which was its headquarters, has an area of 7128 sq. m. It consists of two tablelands, of which the higher rises to about 2000 ft. The whole area is broken by hills and undulations, which are terraced for rice. The steep slopes are covered with a dense forest, where wild animals still abound, but no profit is derived from the timber. The principal rivers are the Subanarekhâ and the North and South Koel. In 1901 the population was 1,187,925, showing an increase of 5.2% in the decade. Christians form 10% of the total. The district was affected by the famine of 1896-1897, and still more severely by that of 1900. Rice is everywhere the staple crop, with some millets and pulses. Tea cultivation has been introduced, but does not flourish. The only industry on a large scale is the

manufacture of shellac. Myrobalans are also exported. Iron and soapstone are worked in small quantities. Hopes of profitable gold-mining in the quartz veins of the schist formation have proved abortive. There is no railway in the district, though surveys have been made to connect with the Bengal-Nagpur line.

See F. B. Bradley-Birt, *Chota Nagpur* (1903).

RAND, a Dutch word meaning border, edge, used in South Africa to designate a low rounded range of hills; specifically it is an abbreviated form of Witwatersrand, an elevated ridge in the southern Transvaal, forming the water-parting between the basins of the Orange and Limpopo. The Rand is famous for its gold-bearing reefs (see GOLD), and the word is often used as a synonym for the mining industry carried on over a great part of its area, or for Johannesburg (*q.v.*), the city which that industry created.

RANDALL, SAMUEL JACKSON (1828-1890), American politician, was born in Philadelphia, Pennsylvania, on the 10th of October 1828. He was educated in the public schools and in the University Academy, Philadelphia. In 1858-1859 he was a Democratic member of the state Senate. During the Civil War he served as a private in the Union army for ninety days in 1861, and two years later took part in the Gettysburg campaign as a volunteer. From 1863 until his death he was a Democratic representative in Congress. During the session of 1874-1875 he first gained a national reputation by the masterful manner in which he prevented the Republican majority from passing the Force Bill or Federal Election law. Under his leadership discipline and party harmony were established among the Democrats for the first time after the Civil War. He was speaker of the House from December 1876 to March 1881, during a period marked by rancorous debates concerning the disputed Hayes-Tilden presidential election. With the disappearance of the Reconstruction questions and the emergence of the tariff issue, however, his influence began to wane. As the leader of the Protectionist wing of the party he was superseded by the tariff reform advocates, such as John G. Carlisle, William R. Morrison, and Roger Q. Mills, Carlisle defeating him for the speakership in 1883. He died in Washington, D.C., on the 13th of April 1890.

RANDAN, a name for a boat rowed by three persons, stroke and bow using a single oar each and the central person a pair of sculls. The word is of unknown origin, and can hardly be connected with a slang term for a row or spree, which is found as early as the beginning of the 18th century and is generally taken as a variation of "random," haphazard.

RANDAZZO, a town of Sicily, in the province of Catania, at the N. foot of Mount Etna, 43 m. N. by W. of Catania by rail, and 26 m. direct. Pop. (1901) 11,798. It has considerable remains of architecture of the 13th and 14th centuries, including three Norman churches and some interesting palaces. The former contain some fine sculptures and goldsmith's work (Mauceri in *L'Arte*, 1906, 185). It is the nearest town to the summit of Etna (9 m.), and is one of the points from which the ascent may be made.

RANDERS, a town of Denmark, capital of the *amt* (county) of its name in Jutland, on the Gudenaa at the point where it begins to widen into Randers Fjord, an inlet of the Cattegat. Pop. (1901) 20,057. The town is 15 m. from the open Cattegat and the harbour has 15 ft. depth on the bar. The chief exports are butter and eggs; the chief imports sugar, petroleum, coal and iron. Two railways run north to Aalborg, continuing the main East Jutland line from the south, and an eastward branch serves Grenaa and Aebeltoft on the coast. Though a place of considerable antiquity—being mentioned in 1086 as the meeting-place of insurgents against Knud, the saint—Randers has few remains of old buildings and bears the stamp of a compact, modern manufacturing town that owes its importance to its distilleries, manufactories of gloves, railway carriages, &c. St Marten's church dates from the 14th century, but was frequently altered and enlarged down to 1870. It has good woodwork of the 17th century. The high school is housed

in a medieval monastery, which was restored in 1894-97. There is a statue to Steen S. Blicher (1782-1848), the national poet and novelist of Jutland.

Randers is best known in history as the scene of the assassination of Count Gerhard by Niels Ebbesøn in 1340. In the middle ages it had six churches and four monastic establishments, the oldest a Benedictine nunnery (1170). The Grey Friars' building was turned into a castle (Dronningborg) after the Reformation; its church was burned down in 1698.

RANDOLPH, EDMUND [JENNINGS] (1753-1813), American statesman, was born on the 10th of August 1753, at Tazewell Hall, Williamsburg, Virginia, the family seat of his grandfather, Sir John Randolph (1693-1737), and his father, John Randolph (1727-84), who (like his uncle Peyton Randolph) were king's attorneys for Virginia. Edmund graduated at the College of William and Mary, and studied law with his father, who felt bound by his oath to the king and went to England in 1775. In August-October 1775 Edmund was aide-de-camp to General Washington. In 1776 he was a member of the Virginia Convention, and was on its committee to draft a constitution. In the same year he became the first attorney-general of the state (serving until 1786). He served in the Continental Congress in 1779 and again in 1780-82. He had a large private practice, including much legal business for General Washington. In 1786 he was a delegate to the "Annapolis convention," and in 1787-88 was governor of Virginia. He was a delegate to the Constitutional Convention of 1787, and on the 29th of May presented the "Virginia plan" (sometimes called the "Randolph plan").¹ In the Convention Randolph advocated a strongly centralized government, the prohibition of the importation of slaves, and a plural executive, suggesting that there should be three executives from different parts of the country, and refused to sign the constitution because too much power over commerce was granted to a mere majority in Congress, and because no provision was made for a second convention to act after the present instrument had been referred to the states. In October 1787 he published an attack on the Constitution; but in the Virginia convention he urged its ratification, arguing that it was too late to attempt to amend it without endangering the Union, and thinking that Virginia's assent would be that of the necessary ninth state. In 1788 he refused re-election as governor, and entered the House of Delegates to work on the revision and codification of the state laws (published in 1794). In September 1789 he was appointed by President Washington first attorney-general of the United States. He worked for a revision of Ellsworth's judiciary act of 1789, and especially to relieve justices of the supreme court

¹ The plan was not drafted by Randolph, but he presented it because he was governor. It called for a legislature of two branches, one chosen by the people and based on free population (or on wealth) and the other chosen by the first out of candidates nominated by the state legislatures; a majority vote only was required in each house; and Congress was to have a negative on such state legislation as seemed to the Congress to contravene the articles of the Union. There was to be, under this plan, an executive chosen by the national legislature, to be ineligible for a second term, to have general authority to execute the national laws and to have the executive rights vested in Congress by the Confederation; and the executive with a convenient number of the national judiciary was to compose a Council of Revision, with a veto power on acts of the national legislature and on the national legislature's vetoes of acts of state legislatures—but the national legislature might pass bills (or vetoes of state legislation) over the action of the Council of Revision. The plan provided for a Federal judiciary, the judges to be appointed by the national legislature, to hold office during good behaviour, and to have jurisdiction over cases in admiralty and cases in which foreigners or citizens of different states were parties. The Virginia plan was opposed by the smaller states, Connecticut, New Jersey, Delaware and Maryland, which demanded equal representation in the legislature. It was too radically different from the Articles of Confederation. A draft of a constitution in Randolph's handwriting, discovered in 1887, seems to have been the report (6th August) of a Committee of Detail of five members (John Rutledge, Edmund Randolph, Nathaniel Gorham, Oliver Ellsworth and James Wilson). It is reproduced in facsimile in W. M. Meigs's *The Growth of the Constitution* (Philadelphia, 1900). Conway, who discovered it, exaggerated its importance and thought it had been drawn by Randolph alone and before the Convention.

of the duties of circuit judges, and advocated a Federal code; in 1791 he considered Hamilton's scheme for a national bank unconstitutional; and in 1792-93, in the case *Chisolm v. Georgia* before the supreme court, argued that a state might be sued by a citizen of another state. On the 2nd of January 1794 he succeeded Thomas Jefferson as secretary of state. In 1795 he wrote thirteen letters (signed "Germanicus") defending the President in his attack on the American Jacobin or democratic societies. He was the only cabinet member who opposed the ratification of the Jay treaty (his letters to the President on the subject are reprinted in *The American Historical Review*, vol. xii. pp. 587-599), and before it was ratified the delicate task of keeping up friendly diplomatic relations with France fell to him. Home despatches of the French minister, Joseph Fauchet, intercepted by a British man-of-war and sent to the British minister to the United States, accused Randolph of asking for money from France to influence the administration against Great Britain. Although this charge was demonstrably false, Randolph when confronted with it immediately resigned, and subsequently secured a retraction from Fauchet; he published *A Vindication of Mr Randolph's Resignation* (1795) and *Political Truth, or Animadversions on the Past and Present State of Public Affairs* (1796). He was held personally responsible for the loss of a large sum of money during his administration of the state department, and after years of litigation was judged by an arbitrator to be indebted to the government for more than \$49,000, which he paid at great sacrifice to himself. He removed to Richmond in 1803, and during his last years was a leader of the Virginia bar; in 1807 he was one of Aaron Burr's counsel. He died at Carter Hall, Millwood, Clarke county, Virginia, on the 12th of September 1813.

Moncure D. Conway, in his *Omitted Chapters of History disclosed in the Life and Papers of Edmund Randolph* (New York, 1888; 2nd ed., 1889), greatly exaggerates Randolph's work in the Constitutional Convention; the commoner view underrates him and makes him a "hair-splitter," and a man of no decision of character.

RANDOLPH, JOHN (1773-1833), of Roanoke, American statesman. He was a member of an influential and wealthy Virginian family, and was the third and youngest son of John Randolph of Cawsons, Chesterfield county, where he was born on the 2nd of June 1773. He was a descendant of John Rolfe and his wife Pocahontas. His father having died in 1775, his early years were passed under the care of his mother and his stepfather, Mr St George Tucker, from whom, however, he eventually became estranged, as he did from almost every one with whom he was intimately associated. He attended a school at Williamsburg, Virginia, and for a short time studied at Princeton and at Columbia; but, although well read in modern works bearing on politics and philosophy, his own statement, "I am an ignorant man, sir," was in other respects not inaccurate. Both his religious and his political views were radical and extreme. At an early period he imbibed deistical opinions, which he promulgated with eagerness. He was also, though a mere boy when the new Federal government was organized in 1789, strongly opposed to the new Constitution of the United States. In order to assist in asserting the right of resistance to national laws, and to withstand the "encroachments of the administration upon the indisputable rights" of Virginia, he was in 1799 elected as a Republican to the national House of Representatives, of which he was a member, with the exception of two terms (1813-15 and 1817-19), until 1825, and again in 1827-29. After the accession of Jefferson to the presidency in 1801, Randolph was appointed chairman of the Committee of Ways and Means, and as such was naturally the leader of the Republican majority in the House. He took an active part in agitating for the reform of the judiciary, and in 1804 moved the impeachment of Judge Samuel Chase (*q.v.*), acting as the leader of prosecution in the trial before the Senate. Though an avowed Republican, he was far from being subservient to his party, and for several years after 1805 led a small faction, called "Quids," which sharply criticized Jefferson and attempted to prevent the selection of Madison as the

presidential candidate of his party. In March 1807 he lost the chairmanship of the Ways and Means Committee. Possessing considerable wit, great readiness, and a showy if somewhat bombastic eloquence, he would undoubtedly have risen to high influence but for his strong vein of eccentricity and his bitter and ungovernable temper. The championship of state's rights was carried by him to an extreme utterly quixotic, inasmuch as he not only asserted the constitutional right of Virginia to interpose her protest against the usurpation of power at Washington, but claimed that the protest should be supported by force. From December 1825 to March 1827 he served in the United States Senate, and in April 1826 he was forced to fight a duel with Henry Clay, on account of his violent abuse of that statesman in the course of a debate. In 1830 he was sent by President Jackson on a special mission to Russia, but remained in St Petersburg only ten days, then spent almost a year in England, and on his return in October 1831 drew \$21,407 from the United States Treasury for his services. He died of consumption at Philadelphia on the 24th of June 1833. Though his political life was full of inconsistencies—he was even capable of advocating the passage of a bill on one day and of opposing the passage of the same bill on the next—he generally adhered to the principles enunciated by the Republican party in its earliest years, and throughout his later career, in numerous speeches, he laboured to bring about the identification of slavery with the theory of states' rights. In this he was the natural precursor of Calhoun. His last will was disputed in the law courts, and the jury returned a verdict that in the later years of his life he was not of sane mind. He was always in theory opposed to slavery, and by the will which was accepted by the courts, freed his own slaves.

The best biography is that by Henry Adams, *John Randolph* (Boston, 1882), in the "American Statesmen Series." There is also a biography, which, however, contains many inaccuracies, by Hugh A. Garland (2 vols., New York, 1851).

RANDOLPH, PEYTON (1721-1775), American politician, was born at Tazewell Hall, Williamsburg, Virginia, in 1721, a son of Sir John Randolph (1693-1737), the king's attorney for Virginia. He graduated at the College of William and Mary, studied law at the Inner Temple, London, and in 1748 was appointed the king's attorney for Virginia.¹ Randolph wrote the address of remonstrance to the king in behalf of the Burgesses against the suggested stamp duties in 1764. His policy was conservative and moderate, and in May 1765 he opposed Patrick Henry's radical "Stamp Act Resolutions." In 1766 he resigned as king's attorney and was succeeded by his brother John (1727-1784). In 1769 he acted as moderator of the privately convened assembly which entered into the non-importation agreement, and in May 1773 he became chairman of the first Virginia intercolonial committee of correspondence. He presided over the provincial convention of August 1774, and was a member of the First Continental Congress, of which he was president from the 5th of September to the 22nd of October 1774. He was re-elected to Congress in March 1775, and on the 10th of May was again chosen to preside, but on the 24th he left to attend a meeting at Williamsburg of the Virginia Burgesses. He then returned to Congress, of which John Hancock had meanwhile been made president. Randolph died of apoplexy in Philadelphia on the 22nd of October 1775. He was provincial grand-master of the Masons of Virginia, and was an intimate friend of Washington.

RANDOLPH, THOMAS (1523-1590), English diplomatist, son of Avery Randolph, a Kentish gentleman, was educated at Christ Church, Oxford, and in 1549 became principal of Pembroke College, Oxford, then known as Broadgates Hall. During

¹ In 1754 the Burgesses sent him to London to argue against the governor's demand for a fee of one pistole on every land patent; his plea was successful, but the governor superseded him with George Wythe, who resigned in Randolph's favour upon his return from England. The Burgesses voted Randolph £2500 with the grant of £20,000 to Governor Dinwiddie for Indian warfare; the governor would not approve this appropriation, however, until Randolph apologized for leaving his office without the governor's permission.

the reign of Mary, Randolph, who was a zealous Protestant, sought refuge in Paris, where he cultivated the society of scholars. Returning to England after the accession of Elizabeth, he was soon employed as a confidential diplomatic agent of the English queen in Scotland. Here he succeeded in gaining the confidence of the Protestant party, with whom he became a person of great influence. Randolph's despatches from Scotland between 1560 and 1585 supply important materials for the history of the political intrigues of that period. Randolph, who had hitherto remained ostensibly on terms of friendship with Mary Queen of Scots, exerted his influence on instructions from Elizabeth to prevent Mary's marriage with Darnley; but in 1566 he was driven from Scotland on the charge of having fomented Murray's rebellion, and he then obtained government employment of secondary importance in England. In 1568 he undertook a mission to Russia which resulted in the concession by Ivan the Terrible of certain privileges to English merchants; and in 1570 he returned to Scotland, where, after the murder of the regent Murray in January of that year, he "succeeded," says Andrew Lang, "in making civil war inevitable; he himself was in high spirits, as always when mischief was in hand." After carrying through certain diplomatic business in France in 1573 and 1576, Randolph returned in January 1581 to Scotland, where the earl of Morton, the regent, had been arrested a few days previously. Randolph, acting on Elizabeth's instructions, intrigued with Angus and the Douglasses in favour of a plot to seize the person of the young King James, and to save Morton by laying violent hands on the earl of Lennox. Douglas of Whittingham, who was employed in the intrigue, on being arrested made revelations which imperilled Randolph, and the latter prudently withdrew to Berwick before the execution of Morton in June 1581. In 1585, when he next visited Scotland, he was more successful, being instrumental in arranging a treaty between England and Scotland. For the next four years he was chancellor of the exchequer in England, and he died in London in June 1590. Randolph married, in 1571, Anne, daughter of Thomas Walsingham. He was a personal friend of George Buchanan, in whose *History of Scotland* he took a lively interest, and he has been credited, though on doubtful evidence, with the authorship of a *Life of the historian* in Latin.

See J. A. Froude, *History of England* (12 vols., London, 1881); Andrew Lang, *History of Scotland*, vol. ii. (4 vols., London, 1902-7); *Calendar of State Papers relating to Scotland* (1509-1603), edited by M. J. Thorpe (2 vols.); *Calendar of State Papers. Foreign Series of the Reign of Elizabeth*; Anthony à Wood, *Athenae Oxonienses and Fasti*, edited by P. Bliss (4 vols., London, 1813-20).

RANDOLPH, THOMAS (1605-1635), English poet and dramatist, was born near Daventry in Northamptonshire, and was baptized on the 15th of June 1605. He was educated at Westminster and at Trinity College, Cambridge. He took his B.A. degree in 1628, proceeded M.A. in 1632 and became a major fellow of his college in the same year. He soon gave promise as a writer of comedy. Ben Jonson, not an easily satisfied critic, adopted him as one of his "sons." He addressed three poems to Jonson, one on the occasion of his formal "adoption," another on the failure of *The New Inn*, and the third an eclogue, describing his own studies at Cambridge. He lived with his father at Little Houghton in Northamptonshire for some time, and afterwards with William Stafford of Blatherwick, at whose house he died before completing his thirtieth year. He was buried in Blatherwick church on the 17th of March 1634-35, and his epitaph was written by Peter Hausted, the author of *The Rival Friends*.

Randolph's reputation as a wit is attested by the verses addressed to him by his contemporaries and by the stories attached to his name. His earliest printed work is *Aristippus, Or, The Joviall Philosopher. Presented in a private shew, To which is added, The Conceited Pedlar* (1630). It is a gay interlude burlesquing a lecture in philosophy, the whole piece being an argument to support the claims of sack against small beer. *The Conceited Pedlar* is an amusing monologue delivered by the pedlar, who defines himself as an "individuum vagum,

or the *primum mobile* of tradesmen, a walking-burse or movable exchange, a Socratic citizen of the vast universe, or a peripatetical journeyman, that, like another Atlas, carries his heavenly shop on's shoulders." He then proceeds to display his wares with a running satirical comment. *The Jealous Lovers* was presented by the students of Trinity College, Cambridge, before the king and queen in 1632. *The Muse's Looking-Glass* is hardly a drama. Roscius presents the extremes of virtue and vice in pairs, and last of all the "golden mediocrity" who announces herself as the mother of all the virtues. *Amyntas, or The Impossible Dowry*, a pastoral printed in 1638, with a number of miscellaneous Latin and English poems, completes the list of Randolph's authenticated work. *Hey for Honesty, down with Knavery*, a comedy, is doubtfully assigned to him.

His works were edited by W. C. Hazlitt in 1875.

RANDOM (older forms *randon*, *randoun*; from the French, cf. *randir*, to run quickly, impetuously; generally taken to be of Teutonic origin and connected with Ger. *Rand*, edge, brim, the idea being possibly of a brimming river), an adjective originally meaning impetuous, hasty, hence done without purpose or aim, haphazard. The term "random work" is used, in architecture, by the rag-stone masons, for stones fitted together at random without any attempt at laying them in courses. "Random coursed work" is a like term applied to work coursed in horizontal beds, but the stones are of varying height, and fitted to one another (see MASONRY).

RANELAGH, formerly a popular resort by the Thames in Chelsea, London, England. About 1690 the land lying east of Chelsea Hospital, and bordering the river about the point where Chelsea Bridge now stands, was acquired by Richard, Viscount Ranelagh, later earl of Ranelagh (d. 1711). He built a mansion and laid out fine gardens, which, in 1742, were thrown open as a proprietary place of entertainment. A building called the Rotunda was erected for concerts, and the gardens quickly became a favourite resort of fashionable society. Balls and masquerades, exhibitions of fireworks, regattas and many other forms of amusement were provided; but by the close of the 18th century Ranelagh was ceasing to attract the public, and in 1803 the Rotunda was closed. The buildings were removed, and the grounds became the property of Chelsea Hospital. They are still included in the pleasant gardens belonging to that foundation, but no traces of the popular Ranelagh are preserved. There is, however, a fashionable modern club of the same name.

See Warwick Wroth, *London Pleasure Gardens of the Eighteenth Century* (London, 1896).

RANGE-FINDER, TELEMETER OR POSITION-FINDER (Fr. *télémetre*; Ger. *Distanzmesser*; It. *Telemetro*; Russ. *Dalnomier*; Span. *Telómetro*; in the United States the word telemeter is sometimes applied to the stadia used in connexion with the tachometer), an instrument, of which many varieties have been invented, for assisting the gunner and the infantry soldier in determining the distance or "range" to their objective. Nearly all range-finders may be described as instruments which automatically solve a triangle. Usually it is a right-angled triangle, the length of the base of which is known, and one of the sides is the range it is desired to find. They are, in fact, goniometers, but the angle which they measure, whether it may be at the end of the measured base, or that subtended by it, is usually expressed as a function of the angle in terms of the measured base. Thus the range is recorded directly in metres or yards without calculation. It is proposed here

¹ The word "range," from O.Fr. *range*, from *ranger*, to place in a row or rank (*rang* being a variant of *ranc*, whence Eng. "rank"), meant properly a row or line of objects, as still in "mountain-range"; the secondary meanings of an area or space of ground, sphere of action, compass, extent, distance, are derived from the verb "to range," to stretch out in a line, to extend, to move about over a given area.

to describe principally the range-finding instruments in the British services (1) as used in the fleet; (2) by the army in the field; (3) in harbour defence; and (4) to refer briefly to range-finders, not under these heads, of English and foreign design.

1. The necessity for a range-finder afloat caused the British Admiralty in 1891 to issue an advertisement in the press inviting inventors to produce an instrument which would, amongst other conditions, record ranges with an accuracy of within 3% at 3000 yds. The resulting competition was declared in favour of a range-finder which is the joint invention of Professor Barr of the Glasgow University and Professor Stroud of the Yorkshire College.

The naval range-finder consists of a tube² which contains two telescopes. It is carried on a frame by bearings, in which the tube is free to revolve about its longer axis. To the frame is attached a weight capable of movement within a tank. This weight balances the range-finder and frame upon knife-edges. By means of the handle on the left of the instrument and an altitude worm beneath it, the motion of the tube is governed, and the line of sight is directed on the objective. By partially filling the tank with water, the swinging of the weight in a seaway can be checked. The frame is supported on a pedestal and can rotate in azimuth upon it (fig. 1).

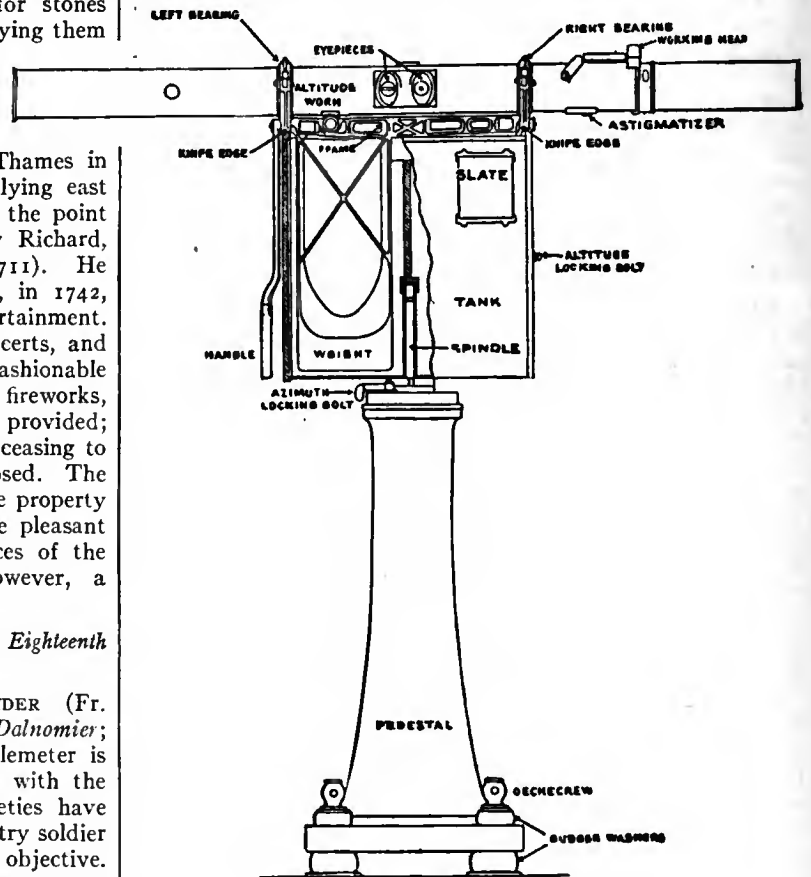

FIG. 1.—Barr and Stroud.

A rubber guard is fitted round the eye-pieces. Its functions are to guide the eyes of the observer into the correct position, and to protect them from side light and the distressing effect of wind. It also guards the forehead against the jar occasioned by firing heavy guns. The upper portion of the field presented to the left eye is used as a finder, the lower portion is occupied by the scale upon which the ranges are engraved. The finder is a low-power telescope of large field, to the centre of which the objective is brought. When the telescope is thus correctly aligned, the objective will be seen with the right eye largely magnified, but as two partial images separated by a thin black horizontal line. When coincidence of the images is effected by means of the working head, the range can be

² The length of tube varies from 3 ft. in the smaller to 9 ft. in the larger instruments

read off against a pointer from the scale seen with the left eye. For night use, means are provided for illuminating the scale. The range to lights may be ascertained by the use of the astigmatizer, an optical device by which a point of light is drawn out into a vertical streak. A beam of light from the objective falls on each reflector (fig. 2),

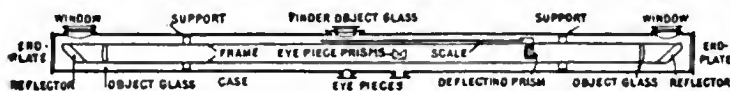

FIG. 2.—Barr and Stroud.

and passing through the object-glasses, each is received by an arrangement of prisms about the centre of the tube, and reflected through the right eye-piece. Two partial images are thus seen. The images could be united by the rotation of one of the reflectors, but owing to the small base used the necessary movement would be so extremely small that it would be practically impossible to measure it. The difficulty has been surmounted by utilizing fixed reflectors and effecting coincidence by means of a prism of small angle. The deflecting prism is situated in the line of the beam of light from the reflector at the right-hand end of the tube. Its multiplying action is of great delicacy. The angle available for subdivision, to measure ranges between infinity and 250 yds., is only one-third of a degree. In a travel of 6 in. the prism renders accurate measurements possible within the required limits. To bring images of distant objectives into coincidence, the prism must be moved towards the eye-piece, and for near objectives in the opposite direction. The range scale is attached to the prism. A consequent advantage is that the accuracy of the instrument is not affected by back lash arising from wear, or irregularity in the actuating mechanism. When once installed, the instrument is always ready for use. Should adjustment be required it is readily and easily applied. It is not within the sphere of this article to enter into the detail of the adjusting mechanism. For further particulars the reader is referred to the *Proceedings of the Institution of Mechanical Engineers*, 30th January 1896. The working of the range-finder is so simple that its use is quickly learnt by any man who can read, and with little instruction and practice he can "take a range" in 8 to 12 seconds. Besides its principal purpose, in connexion with gunnery, there are minor uses in navigation and nautical surveying to which the range-finder can be applied.

With the high speeds of modern war-vessels, guns and their objective approach each other so quickly that unless ranges can be communicated from the instrument to the guns with rapidity and accuracy the range-finder is deprived of much of its value. In connexion with the naval range-finder an apparatus is provided, which though not part of the range-finder is sufficiently important to claim passing notice. The apparatus consists of a transmitting and a receiving instrument of clockwork mechanism electrically controlled. In appearance they resemble the ordinary engine-room telegraph, on the dials of which ranges take the place of orders. The transmitter can communicate with a number of receiving instruments, disposed as required in different parts of the ship.

2. Before the introduction of the Marindin range-finder described below, the British army in the field used the "mekometer." The instruments used by the cavalry and infantry are smaller and lighter than those of the artillery pattern, but the principle involved is identical.

The mekometer is practically a box sextant. Two instruments are used simultaneously at the ends of a base of fixed length. One sextant, called the right-angle instrument, is fitted with index and horizon glasses permanently inclined at 45°. It consequently measures a right angle. In the other sextant, called the reading instrument, a graduated drum takes the place of the usual index arm and scale. The drum is graduated spirally with a scale of ranges. Both reading and right-angle instruments are fitted with a vane of gun metal with a white strip down the centre to facilitate observations. Telescopes of low power can be fitted to the instruments, and two cords of 50 (or 25½) yds. are provided with which to measure the base.

Two observers attach the ends of the cord of fixed length (usually 50 yds.) to their instruments and separate until it is taut. The

observer with the right-angle instrument moves into such a position that coincidence of image will be given between the objective and the vane of the instrument at the other end of the base, *i.e.* he makes ABC a right angle (fig. 3).

When the right angle is established, the observer at C turns the graduated drum of the reading instrument until the image of the vane of the right angle instrument coincides with the direction of the objective. The range AC is then read on the drum. The ranges on the drum are measures of the angle BAC when the base BC is 50 yds.

The mekometer is open to the objection which is common to all range-finders requiring more than one observer. There is always a danger that observers may cause coincidence on different objectives

or on different parts of the same objective, and thus inaccuracy in the recorded range must result. The instruments are expected to give an accuracy of less than 2% at 2000 yds. For ranges over that distance, *i.e.* for usual artillery ranges, it is desirable to use a double base (100 yds. in length), in which case the range registered on the drum must be doubled. This operation, although slight, is a distinct disadvantage, since it adds to the time of taking a range and is a possible source of error. For field artillery, however, a range-finder is only an auxiliary adjunct. The true range can be found by a process of trial and error (see ARTILLERY) in as short a time as the mekometer observers take to report it. It must further be remembered that as shrapnel is the principal projectile of field artillery, not only the correct elevation but also the true length of time fuse has to be found. This the range-finder cannot do. Hence it is that the range-finder for field artillery, although a valuable auxiliary, is not of the same importance as in purely defensive positions, such as batteries for harbour defence, and land forts.

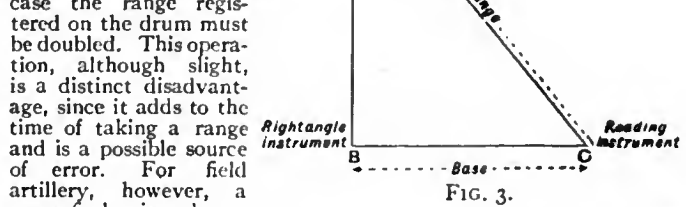

FIG. 3.

The Marindin range-finder was from 1908 gradually introduced in the infantry to replace the mekometer. It was the invention of Captain A. H. Marindin, of the Black Watch (Royal Highlanders).

The principle of the instrument is that of coincidence, as in the Gautier Christie, Le Cyre, Souchier, and Barr and Stroud. But it differs from the last mentioned in that the right prism is made movable, and this movement (necessarily extremely small) is a function of the recorded range.

The steel tube, forming the base of the instrument, which carries the prisms, is supported inside an aluminium outer tube in such a way that no direct shock is communicated to it. The appearance of the outside of the instrument, together with the names of the various parts, is shown in fig. 4.

The instrument can be used in two main positions, *viz.* horizontally, *Marlodin Range-Finder.*

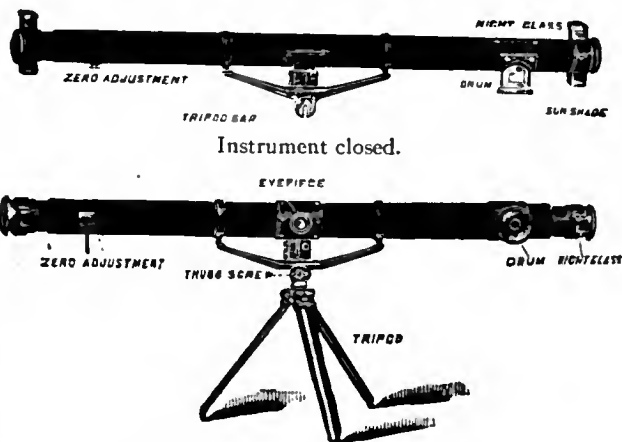

FIG. 4.—Marindin Range-Finder.

for ranging on upright objects, or *vertically*, for ranging on horizontal targets.

For instance, in the diagram (fig. 5) of a road running uphill, the instrument could be held in any of the three positions indicated,

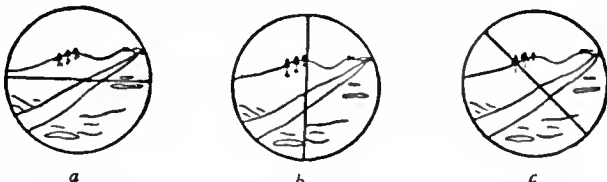

FIG. 5.

and would give good ranges, but probably the best range would be obtained if held as at *c*. If it is required to use the instrument

at night, the two caps of the night-glasses should be opened. On looking through the instrument, any lamp or other light will appear like a fine, bright line, and the range can be taken in the ordinary way.

This range-finder possesses the superlative advantage of the one-man instrument, and it is claimed for it that it can range on horizontal objects, such as the crest of a hill, which has no detail suitable for use with a mekometer, and that it can be adjusted on service with no greater difficulty than the setting of a watch.

3. For harbour defence, owing to the long range of naval guns, and the fast targets which war-vessels present, an accurate range-finder is of first importance. This is largely the case because "ranging" cannot be resorted to in the same manner as in the field, where the targets are comparatively motionless and the effective ranges are less. Successful artillery practice therefore depends, in a great measure, upon the range-finder.

The instrument used in harbour forts is known as the *depression range-finder*. As its name suggests, it solves a triangle in the vertical plane, of which the base is the height of the instrument above sea-level. Its appearance resembles some forms of theodolite (fig. 6). A framework, capable of rotating in azimuth on a vertical

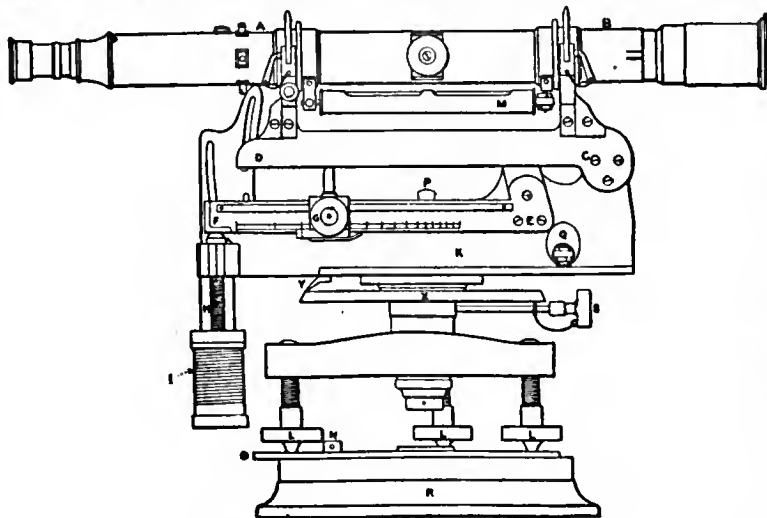

FIG. 6.—Depression Range-Finder.

pivot, is supported on a plate carried by levelling screws, L, L, L. To the framework are pivoted two arms DC and FE, at C and E respectively. The arm EF is supported at F by a vertical screw H ending in a drum, upon which, in a spiral scale, the ranges are graduated. Motion in altitude is thus given to the telescope. The arm CD is supported by a slider G. This slider is set by a rack and pinion to the height above sea-level (represented on a scale of feet on EF) at which the instrument may be used. A telescope AB is suitably fitted in jaws at the top of the frame. There are spirit-levels at M and Q for adjusting purposes. The telescope is provided with cross wires which can be illuminated for night use. An azimuth circle X and pointer Y enable the direction of any vessel to be indicated, the range of which it is desired to know. The instrument rests on a base plate R, to which it is locked by the top-plate O. The observer directs the cross wires of the telescope upon the water-line of the objective, by means of the drum I and the azimuth handle P, the top of which just appears in the diagram. The reader watches the arrow on the drum and calls out the ranges as the figures arrive beneath it. The ranges are communicated to the officers at the guns by various devices, which differ according to local requirements.

Position-Finder.—The range-finding instrument known in the British service as the Position-Finder (invented by Colonel Watkin, C.B., R.A.) is practically a large depression range-finder. It possesses, however, certain additional appliances which render it capable of automatically recording, upon an oriented chart, the position or course of a vessel. And further, by electrical means it automatically records to a distant battery the range and bearing of the desired objective. The position-finder can therefore, from a concealed and safe position, automatically control the fire of a group of guns, whose detachments need not necessarily see the target engaged. As the observer follows the objective with the telescope of the instrument the range and bearing is simultaneously shown in the battery on convenient

dials. The distance and direction thus communicated are the range and bearing from the guns, not as measured from the range-finder. The correction due to the displacement between gun and instrument is automatic. In localities where the height does not admit of using the depression system, an alternative arrangement is provided, known as the Horizontal Position-Finder. It is open to the objections common to two-man range-finders, and is only employed where necessity compels its use. Briefly, there are two observing stations at either end of a measured and electrically connected base. One is known as the transmitting and the other the receiving station; the latter contains the principal instrument, which usually is capable of independent use for medium and short ranges as a depression instrument.

It will be seen that the difference between the two systems is, that the first described solves the range triangle in the vertical, and the latter in the horizontal plane. There have been various methods proposed for using the position-finder. The best results are obtained by placing range and bearing dials on the gun-mounting in a position where they can be easily seen by the men elevating and training the gun. The gun is kept directed upon the objective and fired as quickly as it can be loaded. A position-finder can be used for firing mines in a mine field, and instruments are issued to the Royal Navy for this purpose.

In the United States of America the term "position-finder" is applied to a range-finder which gives direction as well as distance. This is substantially correct, but custom, in the British service, confines the use of the expression as defined above.

4. Various appliances, not strictly range-finders, are sometimes used to assist in estimating distance. The following examples are not without interest:—

Acoustic telemeters, depending upon the velocity of sound, are obviously unsuited to the requirements of modern warfare. The names of Thouvenin, Rédiér and Le Boulengé are connected with such instruments—that of the last-named is perhaps the most convenient. It consists of a graduated glass tube filled with liquid, of suitable density, and containing a small metal traveller. At the flash of discharge of a gun or rifle the instrument is brought to a vertical position, and the traveller starts from zero; at the detonation, it is turned to a horizontal position and the traveller stops at the point on the scale indicating the range.

On this principle is the rough method of ascertaining the distance, in yards, of a thunderstorm, viz. multiply the number of seconds elapsing between the perception of the lightning and that of the thunder by the number of days in the year.

Optical or perspective telemeters determine the distance to any point by observing the size of some object of known dimensions, as seen in a graduated telescope. Porro's telemeter, Elliott's telescope and Nordenfelt's macrometer illustrate the principle. The chief defect of the system is that the objects most conveniently observed—men and horses—vary considerably in size, so that the assumption of a constant dimension may be productive of error.

Other
Tele-
meters.

On the continent of Europe the perspective telemeter for military purposes has attracted more attention than in England. The French in their precise terminology call such an instrument "Stadia militaire," a term which at once distinguishes it from a "télémetre," and describes its nature. In rapid military sketching, in locating positions upon maps, &c., perspective telemeters find a use. The telescopes issued to field batteries and to coast forts in France are provided with a scale in the field of view. By comparing this scale with known heights, such as the average height of a man on foot, or the known height of funnels, masts, turrets, &c., of a war-vessel, distance can be estimated with fair accuracy.

The "jumelle Souchier," which can be used as an ordinary field-glass, is constructed on the stadia principle. By its means ranges can be estimated within an accuracy of 10%. A stand or rest, however, is necessary for good results.

General Percin of the French army has shown, in an interesting pamphlet, that a piece of wood or card cut to a known fraction of the distance between the eye and the end of the thumb, when the arm is fully extended, can be used to estimate distances. Thus it is easy to find a penny in good condition of which the thickness is $\frac{1}{16}$ th part of the arm-length in a man of average height. Provided with such a coin an observer finds its rim to exactly cover a distant man 6 ft. (or 2 yds. high). The range therefore is $400 \times 2 = 800$ yds. Similarly, if the man's height appeared to be but half the thickness of the coin the range would be $4 \times 400 = 1600$ yds. With a little practice the eye estimates the proportion between the object of

known height and the stadia used. General Percin gives many useful applications of this simple device.

Various range-finders have been produced in countries outside the British Isles which, as they are the outcome of similar necessity and required for identical purposes, naturally resemble, more or less, the instruments already described.

Field artillery officers of all countries usually claim their gun to be their best range-finder. This may be another way of saying that a durable, one-man range-finder, capable of instantaneously finding modern artillery ranges with accuracy, has yet to be invented. In France the "télémetre Goutier" for field artillery, a two-man instrument, corresponds with the Watkin mekometer.

The "Gautier," used by the Italian field artillery, is a one-man instrument, but requires a measured base-line. The "Aubry" telemeter, used by some of the Russian batteries in Manchuria, is very portable, but requires a measured base-line, and a slide rule to find the range. In the French and Russian infantry the "prisme-télémetre," the invention of Colonel Souchier, is used. It is small, very light, and can be carried in the same manner as field-glasses. French machine guns are ranged by the "télémetre instantané," an instrument of the Barr and Stroud type, with an aluminium base 1 metre in length.

For work in the field the modern tendency abroad is to follow Barr and Stroud. In Germany, Hahn, Goerz and Zeiss have produced handy and fairly light short base range-finders, in outward appearance more or less similar to Marindin's instrument.

The Zeiss range-finder, however, depends on the stereoscopic principle. It is open to the objection that best results can only be obtained with it by persons who are capable of seeing stereoscopically, and also, in individuals possessing this particular gift (a comparatively small proportion of the human race), stereoscopic vision may vary in power from day to day. Nevertheless the Zeiss range-finder has found favour in many countries, notably as the infantry range-finder in Italy. For naval and harbour defence purposes the Barr and Stroud range-finder is very largely used throughout the world. In Italy a Barr and Stroud instrument, with the large base of 5 metres, was in 1908 under trial for coast artillery.

Of the depression range-finder type in France, "le télémetre Dévé" is used at all heights of about 70 ft. and upwards.

Brazil possesses, in the invention of Captain Marió Netto, an excellent range-finder. It is supplied to the harbour defences of that country. It is accurate, handy, easily transported and re-erected where required, and is not affected by the concussion of heavy gun-fire. The German coast range-finder of Hahn closely resembles the earlier Watkin instruments. In Italy the Amici instrument is being replaced by the Braccialine. The latter inventor has also supplied his country with a horizontal base instrument.

After extended competitive trials in the U.S.A. the Lewis depression range-finder has been found superior to others presented to the Range-Finding Committee, and is recommended for adoption. It is a neat, workmanlike instrument, and gave an average mean error of 24 yds. in the ranges recorded during the trials. The maximum range was 12,000 yds. and the height of base 135½ ft.

The details of position-finders abroad, as in the British service, are confidential, and but little is published of the "télémetre par recouplement" of the French coast batteries, or the "telegoniometro Sollier" of Italy. In the United States, B. A. Fiske has ingeniously adapted the principle of the Wheatstone bridge in the construction of the position-finder which bears his name.

See de Marré, *Instruments pour la mesure de distances* (Paris, 1880); *Abridgments of Specifications*, Class 97, Patent Office, London; *Handbooks and Instructions for Range-Finder*, published by the British War Office; Barr and Stroud, *Proc. Inst. Mech. Eng.*, 30th Jan. 1896; Zeiss pamphlet by Carl Zeiss of Jena, which gives a candid statement of the difficulty attending the stereoscopic principle, &c. (F. M. L.*)

RANGER, HENRY WARD (1858–), American artist, was born at Syracuse, New York, in January 1858. He became a prominent landscape and marine painter, much of his work being done in Holland, and showing the influence of the modern Dutch school. He became a National Academician (1906), and a member of the American Water Color Society. Among his paintings are, "Top of the Hill," Corcoran Gallery of Art, Washington, D.C.; and "East River Idyll," Carnegie Institute, Pittsburgh.

RANGOON, the capital of Burma, situated on the left bank of the Hlaing or Rangoon river, 21 m. from the sea, in 16° 47' N. and 96° 13' E. In 1880 the city was detached from the main district, called Hanthawaddy, and formed into a separate district, with an area of 19 sq. m. Pop. (1901) 234,881, of whom just half were immigrants from India. Rangoon, from being a comparatively insignificant place, has within less than half a century risen to be the third seaport in British India, being surpassed only by Calcutta and Bombay in the

volume of its trade. During the busy season of rice-export, which lasts from the end of December to the middle of May, the pool forming the port of Rangoon presents almost as crowded a scene as the Hugli at Calcutta. Rangoon has the double advantage of being situated near the sea and being served by a great river navigable for 900 m. behind it. The approach to the port is not difficult at any season of the year. With flat and shelving shores, the shoal-banks off the main mouths of the delta form the chief danger to shipping, and this is guarded against by a good service of lighthouses and lightships. For a length of seven or eight miles the river is from a mile to a mile and a quarter in breadth, so that there is plenty of accommodation for shipping. Here is concentrated the whole of the rich trade of the delta of the Irrawaddy. Great part of the river frontage is occupied with rice-mills, teak wharves and similar buildings. The rice exported from Rangoon in 1904-5 amounted to 28 million cwt. with a value of nearly 7 million sterling.

The city is dominated by the great golden pile of the Shwe Dagon pagoda, the centre of Burmese religious life. Rising to a height of 368 ft., this magnificent building is loftier than St Paul's Cathedral in London, and its size is greatly enhanced by the fact that it stands on an eminence that is itself 168 ft. above the level of the city. It is covered with pure gold from base to summit, and once in every generation this gold is renewed by public subscription. Moreover, benefactions to this pagoda are one of the favourite methods of acquiring religious merit among the Burmese. The pagoda itself has no interior. It is a solid stupa of brick, in the form of a cone, raised over a relic chamber; and the place of worship is the surrounding platform with a perimeter of nearly 1400 ft.

Though traditionally a site of great sanctity, Rangoon owes its first importance to its rebuilding in 1753 by Alompra, the founder of the Burmese monarchy, who gave it the present name of *Yan Kon*, "the end of the war." An English factory was opened here about 1790. On the outbreak of the first Burmese War, in 1824, it was taken by the British, but subsequently restored. It was captured a second time in 1852, and passed along with the province of Pegu into the hands of the British. It was destroyed by fire in 1850, and serious conflagrations occurred again in 1853 and 1855. Since the last devastation Rangoon has undergone considerable improvements. Until 1874, when the existing municipality was constituted, the administration was in the hands of the local government, which devoted itself to raising the centre of the town above the river level, providing land fit for building purposes from the original swamp, which was flooded at spring-tides, and making roads, bridges, culverts and surface drains. In 1892 was introduced the sewage system, which now includes 6 m. of mains, 22 m. of gravitating sewers, 4½ m. of air mains and 44 Shone's ejectors. The water supply, drawn from the Victoria Lake, 5 m. distant, has recently been supplemented by an additional reservoir, 10 m. farther off. The city proper of Rangoon with the Kemmendine suburb is laid out on the block system, each block being 800 by 860 ft., intersected with regular streets. In the extensions to the east and west it has been decided to have no streets less than 50 ft. wide. The roads are still lighted by kerosene oil lamps, but electric lighting is in contemplation. Electric tramways run to Pazundaung in one direction and to Alôn and Kemmendine in the other, as well as to the foot of the Shwe Dagon Pagoda hill. Latterly the erection of masonry buildings, instead of plank houses, has been insisted on in the central portion of the city, with the result that fires have decreased in number. There are two large maidans, or commons, which are used as military parade grounds and for racing, as well as for golf links and other purposes of amusement. There is a garden round the Phayre Museum, managed by the Agri-Horticultural Society, and an extremely pretty and well-kept garden in the cantonments under the pagoda. Beyond these lie the Royal Lake and Dalhousie Park, with 160 acres of water and 205 acres of well-laid-out and well-timbered park land. Dalhousie Park has recently been greatly extended, and the new Victoria Park, declared open on the

occasion of the visit of the prince of Wales in 1906, is quite the finest in the East. There are two cathedrals, Church of England and Roman Catholic, and a Presbyterian church, besides the cantonment church buildings for worship. Religious buildings and lands, indeed, occupy an area in Rangoon out of all proportion to its size. Buddhists, Hindus, Mussulmans, Parsees, Armenians and Jews all own lands and pagodas, temples, mosques, churches and synagogues. The Buddhist monasteries, in particular, occupy wide spaces in very central portions of the town and cantonments. Burial-grounds are equally extensive, and exist in every direction in what were once the outskirts, but are now fast becoming central parts of the city. The chief educational institutions are the Government Rangoon college, the Baptist college and St John's college (S.P.G.). Besides the general hospital, a female hospital in connexion with the Dufferin Fund has recently been built, and there are hospitals for contagious diseases and for lepers in the suburbs. The staple industries are mills for husking rice and for sawing timber, and petroleum refineries. Carving in wood and ivory, and embossed silverwork are also carried on. There are three municipal and eight private markets, which are being improved and extended. Everything, from sacking to jewelry, is sold in them. The introduction of pure water and the establishment of compulsory vaccination have greatly improved the health of Rangoon. But the death-rate is still high, due partly to the swampy nature of the outskirts of the city proper, and still more to the mortality among Hindu immigrants from the Madras presidency. The total rainfall in 1905 was 104.96 in. Rangoon is the headquarters of a brigade in the Burma command of the Southern army. (J. G. Sc.)

RANGPUR, or RUNGPORE, a town and district of British India, in the Rajshahi division of Eastern Bengal and Assam. The town is situated on the little river Ghaghat. Pop. (1901) 15,960. There are a high school, a normal school and an industrial school. The earthquake of the 12th of June 1897 destroyed many of the public buildings and diverted the drainage channels.

The DISTRICT OF RANGPUR, with an area of 3493 sq. m., is one vast plain. The greater part of it, particularly towards the east, is inundated during the rains, and the remainder is traversed by a network of streams which frequently break through their sandy banks and plough for themselves new channels over the fields. The river system is constituted by the Brahmaputra and its tributaries, chief of which are the Tista, Dharla, Sankos and Dudhkumar. The climate is generally malarious, owing to the numerous stagnant swamps and marshes filled with decaying vegetable matter. The annual rainfall averages 82 in. About three-fourths of the district is under continuous cultivation. Spare land can hardly be said to exist—even the patches of waste land yield a valuable tribute of reeds and cane. The staple crops are rice, oil-seeds, jute and tobacco. In 1901 the population was 2,154,181, showing an increase of 4.3% in the decade. Nearly two-thirds are Mahommedans. The Eastern Bengal railway has two branches, one of which crosses the district to the Brahmaputra, and the other runs north towards Assam.

The tract comprised within the district of Rangpur was formerly the western outpost of the ancient Hindu kingdom of Kamrup, which appears to have attained its greatest power and prosperity under Raja Nilambar, who was treacherously overthrown by Ala-uddin Hosain of Bengal at the close of the 15th century. Rangpur passed to the East India Company in 1765 under the firm of the emperor Shah Alam. Since then a great number of changes have taken place in the jurisdiction, in consequence of which the district area has been much diminished.

RANJIT SINGH, MAHARAJA (1780-1839), native Indian ruler, was born on the 2nd of November 1780, the son of Sirdar Mahan Singh, whom he succeeded in 1792 as head of the Sukarchakia branch of the Sikh confederacy. By birth he was only one of many Sikh barons and owed his rapid rise entirely to force of character and will. At the age of seventeen he seized the reins of government. He is said to have poisoned his

mother, though it is more probable that he merely imprisoned her to keep her out of his way. At the age of twenty he obtained from Zaman Shah, the king of Afghanistan, a grant of Lahore, which he seized by force of arms in 1799. Subsequently he attacked and annexed Amritsar in 1802, thus becoming master of the two Sikh capitals. When Jaswant Rao Holkar took refuge in the Punjab in 1805, Ranjit Singh made a treaty with the British, excluding Holkar from his territory. Shortly afterwards acute difficulties arose between him and the British as to the Cis-Sutlej portion of the Punjab. It was Ranjit Singh's ambition to weld the whole of the Punjab into a single Sikh empire, while the British claimed the territory south of the Sutlej by right of conquest from the Mahrattas. The difference proceeded almost to the point of war; but at the last moment Ranjit Singh gave way, and for the future faithfully observed his engagements with the British, whose rising power he was wise enough to gauge. In 1808 Charles Metcalfe was sent to settle this question with Ranjit Singh, and a treaty was concluded at Amritsar on the 15th of April 1809. At this period a band of Sikh fanatics called "akalis," attacked Sir Charles Metcalfe's escort, and the steadiness with which the disciplined sepoy repulsed them, so impressed the maharaja that he decided to change the strength of his army from cavalry to infantry. He organized a powerful force, which was trained by French and Italian officers such as Generals Ventura, Allard and Avitabile, and thus forged the formidable fighting instrument of the Khalsa army, which afterwards gave the British their hardest battles in India in the two Sikh wars. In 1810 he captured Multan after many assaults and a long siege, and in 1820 had consolidated the whole of the Punjab between the Sutlej and the Indus under his dominion. In 1823 the city and province of Peshawar became tributary to him. In 1833 when Shah Shuja, flying from Afghanistan, sought refuge at his court, he took from him the Koh-i-nor diamond, which subsequently came into the possession of the British crown. Though he disapproved of Lord Auckland's policy of substituting Shah Shuja for Dost Mahomed, he loyally supported the British in their advance on Afghanistan. Known as "The Lion of the Punjab," Ranjit Singh died of paralysis on the 27th of June 1839.

In his private life Ranjit Singh was selfish, avaricious, drunken and immoral, but he had a genius for command and was the only man the Sikhs ever produced strong enough to bind them together. His military genius showed itself not so much in actual generalship as in the organization of his plans, the selection of his generals and his ministers, the tenacity of his purpose and the soundness of his judgment. The British were the one power in India that was too strong for him, and as soon as he realized that fact he was unwaveringly loyal to his engagements with them. His power was military aristocracy resting on the personal qualities of its founder, and after his death the Sikh confederacy gradually crumbled and fell to pieces through sheer want of leadership; and the rule of the Sikhs in the Punjab passed away completely as soon as it incurred the hostility of the British.

See Sir Lepel Griffin, *Ranjit Singh* (Rulers of India Series), 1892; General Sir John Gordon, *The Sikhs*, 1904; and S. S. Thorburn, *The Punjab in Peace and War*, 1904.

RANK (O.Fr. *ranc* or *renc*, mod. *rang*, generally connected with the O.E. and O.H.G. *hring*, a ring), a row or line, as of cabs or carriages, but especially of soldiers drawn up abreast in a line; in "rank and file" the "rank" is the horizontal line of soldiers, the "file" the vertical. From the sense of orderly arrangement "rank" is applied to grades or classes in a social or other organization, and particularly to a high grade, as in such expressions as a "person of rank." This word must be distinguished from the adjective "rank," over-luxuriant, coarse, strong, generally connected with the Low Ger. *rank*, thin, tall (cf. Du. *rank*, upright). The O.E. *rinc*, warrior, *i.e.* full-grown man, may be also connected with the word; Skeat refers also to "rack," to pull out straight.

RANKE, LEOPOLD VON (1795-1886), German historian, was born on the 20th or the 21st of December 1795, in the small town of Wiehe, in Thuringia, which then formed part of the electorate of Saxony. His father, Gottlob Israel Ranke, was an advocate, but his ancestors, so far back as the family can be traced, had been ministers of religion. Leopold received his education first at Donndorf, a school established in an old monastery near his home, and then at the famous school of Schulpforta, whence he passed to the university of Halle and later to that of Berlin. His studies, both at school and university, were classical and theological. The great political events which occurred during his boyhood and youth seem to have had less effect on him than on many of his contemporaries, and he was not carried away either by enthusiastic admiration for Napoleon or by the patriotic fervour of 1813. Nor was he implicated in the political movements which during the following years attracted so many students; on the contrary, he already displayed that detachment of mind which was to be so characteristic of him. In 1818 he became a master in a school at Frankfort-on-the-Oder, thereby entering the service of the Prussian government. The headmaster of this school was Ernst Friedrich Poppo (1794-1866), a celebrated Grecian, and Ranke was entrusted with the teaching of history.

With the scholar's dislike of textbooks, he rapidly acquired a thorough knowledge of the ancient historians, quickly passed on to medieval times, and here it was that he formed as the ideal of his life the study of universal history, the works of God as displayed in the history of the human race. Here, too, he composed his first work, which deals with the period to which most of his life was to be devoted, *Geschichte der römischen und germanischen Völker 1494-1514* (Berlin, 1824). To this was appended a critical dissertation on the historians who had dealt with the period (*Zur Kritik neuerer Geschichtsschreiber*), which, showing as it did how untrustworthy was much of traditional history, was to be for modern history as epoch-marking as the critical work of Niebuhr had been in ancient history. A copy of the book was sent to the Prussian minister of education, Karl Albert Kamptz (1769-1849), the notorious hunter of democrats. Within a week Ranke received the promise of a post at Berlin, and in less than three months was appointed supernumerary professor in the university of that city, a striking instance of the promptitude with which the Prussian government recognized scientific merit when, as in Ranke's case, it was free from dangerous political opinions. The connexion thus established in 1825 was to last for fifty years. At the Berlin Library Ranke found a collection of MS. records, chiefly Italian, dealing with the period of the Reformation; from a study of them he found how different were the real events as disclosed in contemporary documents from the history as recorded by most writers; and the result of his researches was embodied in his second work, *Fürsten und Völker von Südeuropa im 16 und 17 Jahrhundert* (1827). In later editions the title of this book was altered to *Die Osmanen und die spanische Monarchie*. It was now his ambition to continue his exploration of the new world thus opened to him. The Prussian government provided the means, and in September 1827 he started for Italy. His first sojourn was in Vienna, where the friendship of Gentz and the protection of Metternich opened to him the Venetian archives, of which many were preserved in that city—a virgin field, the value of which he first discovered, and which is still unexhausted. He found time, in addition, to write a short book on *Die Serbische Revolution* (1829), from material supplied to him by Wuk Stephanowich, a Servian who had himself been witness of the scenes he related. This was afterwards expanded into *Serbien und die Türkei im 19 Jahrhundert* (1879). In 1828 he at last crossed the Alps, and the next three years were spent in Italy. The recommendations of Metternich opened to him almost every library except the Vatican; and it was during these three years of study in Venice, Ferrara, Rome, Florence and other cities, that he obtained that acquaintance with European history which was to make him the first historian of his time.

At Rome, as he said, he learned to see events from the inside. He wrote nothing but a critical examination of the story of Don Carlos, but he returned to Germany a master of his craft.

For a time Ranke was now engaged in an occupation of a different nature, for he was appointed editor of a periodical in which Friedrich Perthes designed to defend the Prussian government against the democratic press. Ranke, contemptuous in politics, as in history, of the men who warped facts to support some abstract theory, especially disliked the doctrinaire liberalism so fashionable at the time. He hoped, by presenting facts as they were, to win the adhesion of all parties. We need not be surprised that he failed; men desired not the scientific treatment of politics, but satire and invective. Exposed thus to attack, his weakness, if not his venality, was long an article of faith among the liberals. He did not satisfy the Prussian conservatives, and after four years the *Historische Politische Blätter* came to an end. Two-thirds of the matter had been contributed by the editor, and the two stout volumes in which the numbers were collected contained the best political thought which had for long appeared in Germany. For Ranke the failure was not to be regretted; the rest of his life was to be wholly devoted to that in which he excelled. During 1834-36 appeared the three volumes of his *Die römischen Päpste, ihre Kirche und ihr Staat im 16 und 17 Jahrhundert* (Berlin, 1834-36, and many other editions), in form, as in matter, the greatest of his works, containing the results of his studies in Italy. Henceforth his name was known in all European countries; the English translation by Mrs Austin was the occasion of one of Macaulay's most brilliant essays. Before it was completed he had already begun the researches on which was based the second of his masterpieces, his *Deutsche Geschichte im Zeitalter der Reformation* (Berlin, 1839-47), a necessary pendant to his book on the popes, and the most popular of his works in his own country. In 1837 he became full professor at Berlin; in 1841 Frederick William IV., always ready to recognize intellectual eminence, appointed him Prussian historiographer. Stimulated by this, he brought out his *Neun Bücher preussischer Geschichte* (1847-48), a work which, chiefly owing to the nature of the subject, makes severe demands on the attention of the reader—he is the "Dryasdust" of Carlyle's Frederick; but in it he laid the foundation for the modern appreciation of the founders of the Prussian state. The nine books were subsequently expanded to twelve (Leipzig, 1874). He took no immediate part in the movements of 1848, but in the following years he drew up several memoranda for the king, whom he encouraged in his efforts to defend the character and identity of the Prussian state against the revolutionaries. Though never admitted into the inner circle of the king's associates, he found the king the most appreciative of readers and stimulating of companions, and the queen one of the most faithful of his friends; in biographical works and on other occasions he always defended the memory of the unfortunate monarch. A friend even more sympathetic he found in Maximilian II. of Bavaria, whom he advised in his expansive schemes for the promotion of learning and letters. In the quieter years that followed he wrote the third of his masterpieces, *Französische Geschichte, vornehmlich im 16 und 17 Jahrhundert* (Stuttgart, 1852-61), which was followed by his *Englische Geschichte, vornehmlich im 16 und 17 Jahrhundert* (1859-68). This, the longest of his works, added much to existing knowledge, especially as to the relations between England and the continent, but it lacked something of the freshness of his earlier books; he was over seventy when it was completed, and he was never quite at home in dealing with the parliamentary foundations of English public life. In his later years his small alert figure was one of the most distinguished in the society of Berlin, and every honour open to a man of letters was conferred upon him. He was ennobled in 1865, and in 1885 received the title of Excellenz. When the weakness of his eyes made it necessary for him to depend almost entirely on the service of readers and secretaries,

in his eighty-first year he began to write the *Weltgeschichte* (9 vols., Leipzig, 1883-88). Drawing on the knowledge accumulated during sixty years, he had brought it down to the end of the 15th century before his death in Berlin on the 23rd of May 1886.

Ranke's other writings include *Zur deutschen Geschichte. Vom Religionsfrieden bis zum 30 jährigen Kriege* (Leipzig, 1868); *Geschichte Wallensteins* (Leipzig, 1869; 5th ed., 1896); *Abhandlungen und Versuche* (Leipzig, 1877; a new collection of these writings was edited by A. Dove and T. Wiedemann, Leipzig, 1888); *Aus dem Briefwechsel Friedrich Wilhelms IV. mit Buussn* (Leipzig, 1873); *Die deutschen Mächte und der Fürstentbund. Deutsche Geschichte 1780-90* (1871-72); *Historisch-biographische Studien* (Leipzig, 1878); *Ursprung und Beginn der Revolutionskriege 1791-92* (Leipzig, 1875); and *Zur Geschichte von Oesterreich und Preussen zwischen den Friedensschlüssen zu Aachen und Hubertusberg* (Leipzig, 1875). He also wrote biographies of Frederick the Great and Frederick William IV. for the *Allgemeine Deutsche Biographie*.

Ranke married, at Windermere, in 1843, Miss Clara Graves, daughter of an Irish barrister. She died in 1870, leaving two sons and one daughter.

At the time of his death Ranke was, not in his own country alone, generally regarded as the first of modern historians. It is no disparagement to point out that the recognition he obtained was due not only to his published work, but also to his success as a teacher. His public lectures, indeed, were never largely attended, but in his more private classes, where he dealt with the technical work of a historian, he trained generations of scholars. No one since Heyne has had so great an influence on German academical life, and for a whole generation the Berlin school had no rival. He took paternal pride in the achievements of his pupils, and delighted to see, through them, his influence spreading in every university. While his own work lay chiefly in more modern times, he trained in his classes a school of writers on German medieval history. As must always happen, it is only a part of his characteristics which they learnt from him, for his greatest qualities were incommunicable. The critical method which has since become almost a formal system, aiming at scientific certainty, was with him an unexampled power, based on the insight acquired from wide knowledge, which enabled him to judge the credibility of an author or the genuineness of an authority; but he has made it impossible for any one to attempt to write modern history except on the "narratives of eye-witnesses and the most genuine immediate documents" preserved in the archives. From the beginning he was determined never to allow himself to be misled, in his search for truth, by those theories and prejudices by which nearly every other historian was influenced—Hegelianism, Liberalism, Romanticism, religious and patriotic prejudice; but his superiority to the ordinary passions of the historian could only be attained by those who shared his elevation of character. "My object is simply to find out how the things actually occurred." "I am first a historian, then a Christian," he himself said. In another way no historian is less objective, for in his greatest works the whole narrative is coloured by the quality of his mind expressed in his style. An enemy to all controversy and all violence, whether in act or thought, he had a serenity of character comparable only to that of Sophocles or Goethe. Apt to minimize difficulties, to search for the common ground of unity in opponents, he turned aside, with a disdain which superficial critics often mistook for indifference, from the base, the violent and the common. As in a Greek tragedy, we hear in his works the echo of great events and terrible catastrophes; we do not see them. He also made it a principle not to relate that which was already well known, a maxim which necessarily prevented his works attaining a popularity with the unlearned equal to their reputation among historians. But no writer has surpassed him in the clearness and brevity with which he could sum up the characteristics of an epoch in the history of the world, or present and define the great forces by which the world

has been influenced. His classicism led to his great limitations as an historian. He did not deal with the history of the people, with economic or social problems—the dignity of history was to him a reality. He belonged to the school of Thucydides and Gibbon, not to that of Macaulay and Taine; he deals by preference with the rulers and leaders of the world, and he strictly limits his field to the history of the state, or, as we should say, political history; and in this he is followed by Seeley, one of the greatest of his adherents. The leader of modern historians, he was in truth a man of the *ancien régime*.

Many of Ranke's works have been translated into English. Among these are *Civil Wars and Monarchy in France*, by M. A. Garvey (1852); *History of England, principally in the 17th Century* (Oxford, 1875); *History of the Latin and Teutonic Nations, 1494-1514*, by P. A. Ashworth (1887) and again by S. R. Dennis (1909); *History of the Reformation in Germany*, by S. Austin (1845-47); *History of Servia and the Servian Revolution*, by Mrs A. Kerr (1847); *Ferdinand I. and Maximilian II. of Austria; State of Germany after the Reformation*, by Lady Duff Gordon (1853); *Memoirs of the House of Brandenburg and History of Prussia during the 17th and 18th Centuries*, by Sir Alexander and Lady Duff Gordon (1849); and *History of the Popes during the 16th and 17th Centuries*, by S. Austin (1840; new eds., 1841 and 1847), by W. K. Kelly (1843), and by E. Foster (1847-53). A collected edition of Ranke's works in fifty-four volumes was issued at Leipzig (1868-90), but this does not contain the *Weltgeschichte*.

For details of Ranke's life and work see his own *Zur eigenen Lebensgeschichte*, edited by A. Dove (Leipzig, 1890); and the article by Dove in the *Allgemeine deutsche Biographie*. Also Winckler, *Leopold von Ranke. Lichtstrahlen aus seinen Werken* (Berlin, 1885); W. von Giesebrecht, *Gedächtnisrede auf Leopold von Ranke* (Munich, 1887); Guglia, *Leopold von Ranke's Leben und Werke* (Leipzig, 1893); M. Ritter, *Leopold von Ranke* (Stuttgart, 1895); Nalbandian, *Leopold von Ranke's Bildungsjahre und Geschichtsauffassung* (Leipzig, 1901); and Helmolt, *Leopold Ranke* (Leipzig, 1907).

RANKINE, WILLIAM JOHN MACQUORN (1820-1872), Scottish engineer and physicist, was born at Edinburgh on the 5th of July 1820, and completed his education in its university. He was trained as an engineer under Sir J. B. Macneill, working chiefly on surveys, harbours and railroads, and was appointed in 1855 to the chair of civil engineering in Glasgow, vacant by the resignation of Lewis Gordon, whose work he had undertaken during the previous session. He was a voluminous writer on subjects directly connected with his chair, and, besides contributing almost weekly to the technical journals, such as the *Engineer*, brought out a series of standard textbooks on *Civil Engineering*, *The Steam-Engine and other Prime Movers*, *Machinery and Millwork*, and *Applied Mechanics*, which have passed through many editions, and have contributed greatly to the advancement of the subjects with which they deal. To these must be added his elaborate treatise on *Shipbuilding, Theoretical and Practical*. These writings, however, corresponded to but one phase of Rankine's immense energy and many-sided character. He was an enthusiastic and most useful leader of the volunteer movement from its beginning, and a writer, composer and singer of humorous and patriotic songs, some of which, as "The Three Foot Rule" and "They never shall have Gibraltar," became well known far beyond the circle of his acquaintance. Rankine was the earliest of the three founders of the modern science of Thermodynamics (*q.v.*) on the bases laid by Sadi Carnot and J. P. Joule respectively, and the author of the first formal treatise on the subject. His contributions to the theories of Elasticity and of Waves rank high among modern developments of mathematical physics, although they are mere units among the 150 scientific papers attached to his name in the Royal Society's *Catalogue*. The more important of these were collected and reprinted in a handsome volume (*Rankine's Scientific Papers*, London, 1881), which contains a memoir of the author by Prof. P. G. Tait. Rankine died at Glasgow on the 24th of December 1872.

RANNOCH, a district of north-west Perthshire, Scotland, partly extending into Argyllshire. It measures 32 m. E. and W. and from 10 to 12 m. N. and S. and is surrounded by the districts of Badenoch, Atholl, Breadalbane, Lorne and Lochaber. Much of it is wild, bleak and boggy, and, saving on the E., it is shut in by rugged mountains. The chief rivers are

the Tummel and the Ericht, and the principal lakes Loch Rannoch and Loch Lydoch, or Laidon (about 6 m. long, $\frac{3}{4}$ m. wide and 924 ft. above the sea). Loch Rannoch lies E. and W., measures $9\frac{1}{2}$ m. long by fully 1 m. broad, is 668 ft. above the sea, covers an area of nearly $7\frac{1}{2}$ sq. m., and has a greatest depth of 440 ft. It receives the Ericht and many other streams, and discharges by the Tummel, draining a total area of $243\frac{1}{2}$ sq. m. At the head of the lake is Rannoch Barracks, so named because it was originally built to accommodate a detachment of troops, under ensign (afterwards Sir) Hector Munro, stationed here to maintain order after the Jacobite rising of 1745. Two miles east is Carie, which was the residence of Alexander Robertson, 13th baron of Struan (1670-1749), the Jacobite and poet, who was "out" with Dundee (1689), Mar (1715) and Prince Charles Edward (1745), and yet managed to escape all punishment beyond self-imposed exile to France after the first two rebellions. Kinloch Rannoch, at the foot of the loch, is the principal place in the district, and is in communication by coach with Struan station (13 m. distant) on the Highland, and Rannoch station (6 m.) on the West Highland railway. Dugald Buchanan (1716-1768), the Gaelic poet, was schoolmaster of the village for thirteen years, and a granite obelisk has been erected to his memory.

RANSOM (from Lat. *redemptio*, through Fr. *rançon*), the price for which a captive in war redeemed his life or his freedom, a town secured immunity from sack, and a ship was repurchased from her captors. The practice of taking ransom arose in the middle ages, and had perhaps a connexion with the common Teutonic custom of commuting for crimes by money payments. It may, however, have no such historic descent. The desire to make profit out of the risks of battle, even when they were notably diminished by the use of armour, would account for it sufficiently. The right to ransom was recognized by law. One of the obligations of a feudal tenant was to contribute towards paying the ransom of his lord. England was taxed for the ransom of Richard the Lion Hearted, France for King John taken at Poitiers, and Scotland for King David when he was captured at Durham. The prospect of gaining the ransom of a prisoner must have tended to diminish the ferocity of medieval war, even when it did not reduce the fighting between the knights to a form of athletic sport in which the loser paid a forfeit. Readers of Froissart will find frequent mention of this decidedly commercial aspect of the chivalrous wars of the time. He often records how victors and vanquished arranged their "financing." The mercenary views of the military adventurers were not disguised. Froissart repeats the story that the English "free companions" or mercenaries, who sold their services to the king of Portugal, grumbled at the battle of Aljubarrota in 1385, because he ordered their prisoners to be killed, and would not pursue the defeated French and Spaniards, whereby they lost lucrative captures. The ransom of a king belonged to the king of the enemy by whom he was taken. The actual captor was rewarded at the pleasure of his lord. King Edward III. paid over instalments of the ransom of the king of France to the Black Prince, to pay the expenses of his expedition into Spain in 1367. Occasionally, as in the notable case of Bertrand du Guesclin, the ransom of a valuable knight or leader would be paid by his own sovereign. To trade in ransoms became a form of financial speculation. Sir John Fastolf in the time of King Henry V. is said to have made a large fortune by buying prisoners, and then screwing heavy ransoms out of them by ill-usage. The humane influence of ransom was of course confined to the knights who could pay. The common men, who were too poor, were massacred. Thus Lord Grey, Queen Elizabeth's lord deputy in Ireland, spared the officers of the Spaniards and Italians he took at Smerwick, but slaughtered the common men. Among the professional soldiers of Italy in the 15th century the hope of gaining ransom tended to reduce war to a farce. They would not lose their profits by killing their opponents. The disuse of the practice was no doubt largely due to the discovery that men who were serving for this form of gain could not be trusted to fight seriously.

Instances in which towns paid to avoid being plundered are innumerable. So late as the war in the Peninsula, 1808-14, it was the belief of the English soldiers that a town taken by storm was liable to sack for three days, and they acted on their conviction at Ciudad Rodrigo, Badajoz and San Sebastian. It was a question whether ransoms paid by merchant ships to escape were or were not among the *commercia belli*. In the early 18th century the custom was that the captain of a captured vessel gave a bond or "ransom bill," leaving one of his crew as a hostage or "ransomer" in the hands of the captor. Frequent mention is made of the taking of French privateers which had in them ten or a dozen ransomers. The owner could be sued on his bond. At the beginning of the Seven Years' War ransoming was forbidden by act of parliament. But it was afterwards at least partially recognized by Great Britain, and was generally allowed by other nations. In recent times—for instance in the Russo-Japanese War—no mention was made of ransom, and with the disappearance of privateering, which was conducted wholly for gain, it has ceased to have any place in war at sea, but the contributions levied by invading armies might still be accurately described by the name.

RANTERS, an antinomian and spiritualistic English sect in the time of the Commonwealth, who may be described as the dregs of the Seeker movement. Their central idea was pantheistic, that God is essentially in every creature, but though many of them were sincere and honest in their attempt to express the doctrine of the Divine immanence, they were in the main unable to hold the balance. They denied Church, Scripture, the current ministry and services, calling on men to hearken to Christ within them. Many of them seem to have rejected a belief in immortality and in a personal God, and in many ways they resemble the Brethren of the Free Spirit in the 14th century. Their vague pantheism landed them in moral confusion, and many of them were marked by fierce fanaticism. How far the accusation of lewdness brought against them is just is hard to say, but they seem to have been a really serious peril to the nation. They were largely recruited from the common people, and there is plenty of evidence to show that the movement was widespread. The Ranters came into contact and even rivalry with the early Quakers, who were often unjustly associated with them. The truth is that the positive message of the Friends helped to save England from being overrun with Ranterism. Samuel Fisher, a Friend, writing in 1653, gives a calm and instructive account of the Ranters, which with other relevant information, including Richard Baxter's rather hysterical attack, may be read in Rufus M. Jones's *Studies in Mystical Religion* (1909), xix. In the middle of the 19th century the name was often applied to the Primitive Methodists, with reference to their crude and often noisy preaching.

RANUNCULACEAE, in botany, a natural order of Dicotyledons belonging to the subclass Polypetalae, and containing 27 genera with about 500 species, which are distributed through temperate and cold regions but occur more especially beyond the tropics in the northern hemisphere. It is well represented in Britain, where 11 genera are native. The plants are mostly herbs, rarely shrubby, as in *Clematis*, which climbs by means of the leaf-stalks, with alternate leaves, opposite in *Clematis*, generally without stipules, and flowers which show considerable variation in the number and development of parts but are characterized by free hypogynous sepals and petals, numerous free stamens, usually many free one-celled carpels (fig. 2) and small seeds containing a minute straight embryo embedded in a copious endosperm. The parts of the flower are generally arranged spirally on a convex receptacle. The fruit is one-seeded, an achene (fig. 3), or a many-seeded follicle (fig. 4), rarely, as in *Actaea*, a berry.



From Vines's *Students' Text Book of Botany*, by permission of Swan, Sonnenschein & Co.

FIG. 1.—Gynoecium of *Ranunculus*: x, receptacle with the points of insertion of the stamens, which have been removed.

The order falls into several well-defined tribes which are distinguished by characters of the flower and fruit; all are

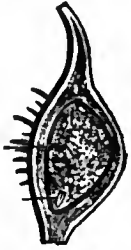

From Strasburger's *Lehrbuch der Botanik*, by permission of Gustav Fischer.
FIG. 2.—*Ranunculus arvensis*. Carpel in longitudinal section. (After Baillon, enlarged.)



FIG. 3.—Single follicle showing dehiscence by the ventral suture.



FIG. 4.—Fruit of Columbine (*Aquilegia*) formed of five follicles.

represented among British native or commonly grown garden plants.

Tribe I. Paeoniae, peony group, are mostly herbs with deeply cut leaves and large solitary showy flowers in which the parts are spirally arranged, the sepals, generally five in number, passing gradually into the large coloured petals. The indefinite stamens are succeeded by 2–5 free carpels which bear a double row of ovules along the ventral suture. Honey is secreted by a ring-like swelling round the base of the carpels, which become fleshy or leathery in the fruit and dehisce along the ventral suture. There are only three genera, the largest of which, *Paeonia*, occurs in Europe, temperate Asia and western North America. *P. officinalis* is the common peony.

Tribe II. Helleboreae are almost exclusively north temperate or subarctic; there are 15 genera, several of which are represented in the British flora. The plants are herbs, either annual, e.g. *Nigella* (love-in-a-mist), or perennial by means of a rhizome, as in *Aconitum* or *Eranthis* (winter aconite). The leaves are simple, as in *Caltha*, but more often palmately divided as in hellebore (fig. 6), aconite (fig. 5) and larkspur. The flowers are solitary (*Eranthis*) or in



FIG. 5.—Five-partite leaf of Aconite.

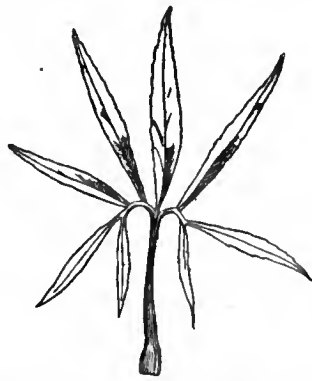

FIG. 6.—Pedate leaf of Stinking Hellebore (*Helleborus foetidus*). It is a palmately-partite leaf, in which the lateral lobes are deeply divided. When the leaf hangs down it resembles the foot of a bird, and hence the name.

cymes or racemes, and are generally regular as in *Caltha* (king-cup, marsh marigold), *Trollius* (globe-flower), *Helleborus*, *Aquilegia* (columbine); sometimes medianly zygomorphic as in *Aconitum* (monkshood, aconite) and *Delphinium* (larkspur). The carpels, generally 3 to 5 in number, form in the fruit a many-seeded follicle, except in *Actaea* (baneberry), where the single carpel develops to form a many-seeded berry, and in *Nigella*, where the five carpels unite to form a five-chambered ovary. There is considerable variety in the form of the floral envelopes and the arrangement of the parts. The outer series, or sepals, generally five in number, is generally white or bright-coloured, serving as an attraction for insects, especially bees, as well as a protection for the rest of the flower. Thus in *Caltha* and *Trollius* the sepals form a brilliant golden-yellow cup or globe, and in *Eranthis* a pale yellow star which contrasts with the green involucre of bracts immediately below it; in *Nigella* they are blue or yellow, and also coloured in *Aquilegia*. In Hellebore the greenish sepals persist till the fruit is ripe. *Aconitum* and *Delphinium* differ in the irregular development of the sepals,

the posterior sepal being distinguished from the remaining four by its helmet-shape (*Aconitum*) or spur (*Delphinium*). In *Caltha* there are no petals, but in the other genera there are honey-secreting and storing structures varying in number and in form in the different genera. In *Trollius* they are long and narrow with a honey-secreting pit at the base, in *Nigella* and *Helleborus* (fig. 7) they form short-



FIG. 7.—*Helleborus niger*. 1, vertical section of flower; 2, nectary, side and front view (nat. size).

stalked pitchers, in *Aquilegia* they are large and coloured with a showy petal-like upper portion and a long basal spur in the tip of which is the nectary. In *Delphinium* they are also spurred, and in *Aconitum* form a spur-like sac on a long stalk (fig. 8). The parts of the flower are generally arranged in a spiral (acyclic), but are sometimes hemicyclic, the perianth forming a whorl as in winter aconite; rarely is the flower cyclic, as in *Aquilegia* (fig. 9) where

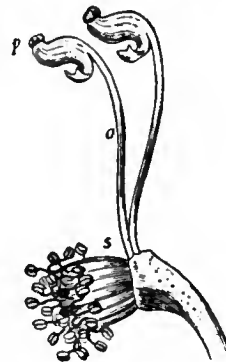

FIG. 8.—Part of the flower of Aconite (*Aconitum Napellus*), showing two irregular horn-like petals *p*, supported on grooved stalks *o*. These serve as nectaries. *s*, the whorl of stamens inserted on the thalamus, and surrounding the pistil.

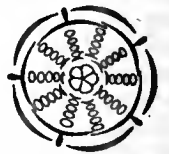

FIG. 9.—Floral diagram of Columbine (*Aquilegia*) showing regular cyclic arrangement.

the parts throughout are arranged in alternating whorls. In *Caltha*, where there are no petals, honey is secreted by two shallow depressions on the side of each carpel.

Tribe III. Anemoneae, with 8 genera, are chiefly north temperate, arctic and alpine plants, but also pass beyond the tropics to the southern hemisphere. They differ from the two preceding tribes in the numerous carpels, each with only one ovule, forming a fruit of numerous achenes. They are annual or perennial herbs, erect as in *Anemone*, *Thalictrum* (meadow-rue) and many buttercups, or creeping as in *Ranunculus repens*; the section *Batrachium* of the genus *Ranunculus* (*q.v.*) contains aquatic plants with submerged or floating stems and leaves. The flowers are solitary, as in *Anemone Pulsatilla* (Pasque flower) and the wood anemone, or cymose as in species of *Ranunculus*, or in racemes or panicles as in *Thalictrum*. The parts are spirally arranged throughout as in *Myosurus* (mouse-tail), where the very numerous carpels are borne on a much elongated receptacle, or *Adonis* (pheasant's eye), or the perianth is whorled as in *Anemone* and *Ranunculus*. In *Anemone* there is a whorl of foliage leaves below the flower, as in *Eranthis*. In *Anemone* and *Thalictrum* there is only one series of perianth leaves, which are petaloid and attractive in *Anemone* where honey is secreted by modified stamens, as in *A. Pulsatilla*, or, as in *A. nemorosa* (wood anemone), there is no honey and the flower is visited by insects for the sake of the pollen; in *Thalictrum* the perianth is greenish or

slightly coloured and the flower is wind-pollinated (*T. minus*) or visited for its pollen. In *Ranunculus* and *Adonis* a calyx of green protective sepals is succeeded by a corolla of showy petals; in *Ranunculus* (fig. 10) there is a basal honey-secreting gland which is absent in *Adonis*. In *Anemone* the achenes bear the persistent naked or bearded style which aids in dissemination; the same purpose is served by the prickles on the achenes of *Ranunculus arvensis*.



FIG. 10.—Petal of Crowfoot (*Ranunculus*), bearing at the base a honey gland protected by a scale, s.

achenes which are generally prolonged into the long feathery style, whence the popular name of the British species, old man's beard (*Clematis vitalba*). The genus, which contains about 170 species, has a wide distribution, but is rarer in the tropics than in temperate regions.

Special articles will be found on the more important genera of *Ranunculaceae*, e.g. *Aconitum*, *Adonis*, *Anemone*, *Baneberry* (*Actaea*), *Clematis*, *Columbine*, *Hellebore*, *Ranunculus*.

RANUNCULUS, familiarly known as "buttercup," or crow-foot, a characteristic type of the botanical order Ranunculaceae. The Lat. name, which means a little frog or tadpole (dim. of *rana*, frog), was also given to a medicinal plant, which has been identified by some with the crowfoot. The Ranunculi are more or less acrid herbs, sometimes with fleshy root-fibres, or with the base of the stem dilated into a kind of tuber (*R. bulbosus*). They have tufted or alternate leaves, dilated into a sheath at the base, and very generally, but not universally, deeply divided above. The flowers are solitary, or in loose cymes, and are remarkable for the number and distinctness (freedom from union) of their parts. Thus there are five sepals, as many petals, and numerous spirally arranged stamens and carpels. The petals have a little pit or honey-gland at the base, which is interesting as foreshadowing the more fully developed tubular petals of the nearly allied genera *Aconitum* and *Helleborus*. The fruit is a head of "achenes"—dry, one-seeded fruits. The genus contains a large number of species (about 250) and occurs in most temperate countries in the northern and southern hemispheres, extending into arctic and antarctic regions, and appearing on the higher mountains in the tropics. About twenty species are natives of Great Britain. *R. acris*, *R. repens*, *R. bulbosus*, are the common buttercups. *R. arvensis*, found in cornfields, has smaller pale yellow flowers and the achenes covered with stout spines. *R. Lingua*, spearwort, and *R. Flammula*, lesser spearwort, grow in marshes, ditches and wet places. *R. Ficaria* is the pilewort or lesser celandine, an early spring flower in pastures and waste places, characterized by having heart-shaped entire leaves and clusters of club-shaped roots. The section *Batrachium* comprises the water-buttercups, denizens of pools and streams, which vary greatly in the character of the foliage according as it is submersed, floating or aerial, and when submersed varying in accordance with the depth and strength of the current. The ranunculus of the florist is a cultivated form of *R. asiaticus*, a native of the Levant, remarkable for the range of colour of the flowers (yellow to purplish black) and for the regularity with which the stamens and pistils are replaced by petals forming double flowers. *R. asiaticus* is one of the older florists' flowers, which has sported into numberless varieties, but was formerly held in much greater esteem than it is at the present time. According to the canons of the florists, the flowers, to be perfect, should be of the form of two-thirds of a ball, the outline forming a perfect circle, with the centre close, the petals smooth-edged, the colour dense, and the marking uniform.

The ranunculus requires a strong and moist soil, with a fourth of rotten dung. The soil should be from 18 in. to 2 ft. deep, and at about 5 in. below the surface there should be placed a stratum 6 or 8 in. thick of two-year-old rotten cow-dung, mixed with earth, the earth above this stratum, where the roots are to be placed, being

perfectly free from fresh dung. The tubers are planted in rows 5 or 6 in. apart, and 3 or 4 in. apart in the rows, the turban sorts in October, the more choice varieties in February. They should be so close that the foliage may cover the surface of the bed. The autumn-planted roots must be sheltered from severe frost. The plants when in flower should be screened from hot sunshine with an awning; when the leaves wither, the roots are to be taken up, dried, and stored. The ranunculus is readily propagated from seed obtained from semi-double sorts, which are often of themselves very beautiful flowers. It is generally sown in boxes in autumn or spring. The young plants thus raised flower often in the second, and always in the third year.

The turban varieties, which are very showy for the borders, are of a few positive colours, as scarlet, yellow, brown, carmine, and white. The florists' varieties have been bred from the Persian type, which is more delicate.

Other species known in gardens are *R. aconitifolius* (white bachelor's buttons), with leaves recalling aconite, and white flowers; the double-flowered form is known in gardens as fair maids of France or fair maids of Kent. A double-flowered form of *R. acris* is grown under the name yellow bachelor's buttons. *R. bulbosus* also has a pretty double-flowered variety. Of dwarfier interesting plants there are *R. alpestris*, 4 in., white; *R. gramineus*, 6 to 10 in., yellow; *R. parnassifolius*, 6 in., white; and *R. rutaeifolius*, 4 to 6 in., white with orange centre. Of the taller kinds mention may be made of *R. cortusaeifolius*, a fine buttercup, 3-5 ft. high, from Teneriffe, and hardy in the mildest parts of Britain; and *R. hyalli*, known as the New Zealand water lily. It is a handsome species, 2 to 4 ft. high, with large petalate leaves often a foot in diameter, and with waxy white flowers about 4 in. across. It is not quite hardy, and even under the best conditions is a difficult plant to grow well.

RAO, SIR DINKAR (1819-1896), Indian statesman, was born in Ratnagiri district, Bombay, on the 20th of December 1819, being a Chitpavan Brahmin. At fifteen he entered the service of the Gwalior state, in which his ancestors had served. Rapidly promoted to the responsible charge of a division, he displayed unusual talents in reorganizing the police and revenue departments, and in reducing chaos to order. In 1851 Dinkar Rao became dewan. The events which led to the British victories of Maharajpur and Panniar in 1844 had filled the state with mutinous soldiery, ruined the finances, and weakened authority. With a strong hand the dewan suppressed disorder, abolished ruinous imposts, executed public works, and by a reduction of salaries, including his own, turned a deficit into a surplus. When the contingent mutinied in 1857, he never wavered in loyalty; and although the state troops also mutinied in June 1858 on the approach of Tantia Topi, he adhered to the British cause, retiring with Maharaja Sindhia to the Agra fort. After the restoration of order he remained minister until December 1859. In 1873 he was appointed guardian to the minor Rana of Dholpur, but soon afterwards he resigned, owing to ill-health. In 1875 the viceroy selected him as a commissioner, with the Maharajas Sindhia and Jaipur, and three British colleagues, to try the Gackwar of Baroda on a charge of attempting to poison the British resident. He also served in the legislative council of India, and was frequently consulted by viceroys on difficult questions. An estate was conferred upon him, with the hereditary title of Raja, for his eminent services, and the decoration of K.C.S.I. He died on the 9th of January 1896. No Indian statesman of the 19th century gained a higher reputation, yet he only commenced the study of English at the age of forty, and was never able to converse fluently in it; his orthodoxy resented social reforms; he kept aloof from the Indian Congress, and he had received no training in British administration.

RAO, SIR T. MADHAVA (1828-1891), Indian statesman, was born at Combaconum in Madras in 1828. Madhava Rao created a new type of minister adapted to the modern requirements of a progressive native state, and he grafted it upon the old stock. He linked the past with the present, using the advantages of heredity, tradition and conservatism to effect reforms in the public administration and in Indian society. Sprung from a Mahratta Brahmin stock long settled at Tanjore, the son of a dewan of Travancore, he was educated in the strictest tenets of his sacred caste. But he readily imbibed the new spirit of the age. To mathematics, science and astronomy he added a study of English philosophy and international law, and a taste for art

and pictures. Although a devout student of the Shastras, he advocated female education and social reform. Refusing to cross the sea and so break caste by appearing before a parliamentary commission, he yet preached religious toleration. A patron of the Indian Congress, he borrowed from the armoury of British administration every reform which he introduced into the native states. He was respected alike by Europeans and natives, and received titles and honours from the British government. As tutor of the maharaja of Travancore, and then as revenue officer in that state, he showed firmness and ability, and became diwan or prime minister in 1857. He found the finances disorganized, and trade cramped by monopolies and oppressive duties. He co-operated with the Madras government in carrying out reforms, and when his measures led to misunderstandings with the maharaja, he preferred honourable resignation to retention of a lucrative office in which he was powerless for good. In 1872 he was engaged at Indore in laying down a plan of reform and of public works which he bequeathed to his successor, when a grave crisis at Baroda demanded his talents there. The Gackwar had been deposed for scandalous misrule, and an entire reorganization was needed. Aided by Sir Philip Melvill, Madhava Rao swept away the corrupt officials, privileged sirdars and grasping contractors who had long ruined Baroda. He wrote able minutes defending the rights and privileges of the Gackwar from fancied encroachment, and justifying the internal reforms which he introduced. He resigned office in 1882, and in his retirement devoted his leisure to reading and writing upon political and social questions. He died on the 4th of April 1891.

RAOUL DE CAMBRAI, the name of a French *chanson de geste*. The existing romance is a 13th-century recension of a poem by a trouvère of Laon called Bertholais, who professed to have witnessed the events he described. It presents, like the other provincial *geste* of *Gorin le Loherain*, a picture of the devastation caused by the private wars of the feudal chiefs. A parallel narrative, obviously inspired by popular poetry, is preserved in the chronicle of Waulsort (ed. Achery, *Spicilegium*, ii. p. 100 seq.), and probably corresponds with the earlier recension. Raoul de Cambrai, the posthumous son of Raoul Taillefer, count of Cambrai, by his wife Alais, sister of King Louis (d'Outre-Mer), whose father's lands had been given to another, demanded the fief of Vermandois, which was the natural inheritance of the four sons of Herbert, lord of Vermandois. On King Louis's refusal, he proceeded to war. The chief hero on the Vermandois side was Bernier, a grandson of Count Herbert, who had been the squire and firm adherent of Raoul, until he was driven into opposition by the fate of his mother, burned with the nuns in the church of Origny. Bernier eventually slew the terrible Raoul in single fight, but in his turn was slain, after an apparent reconciliation, and the blood-feud descended to his sons. The date of these events is exactly ascertainable. Flodoard (*Annales*, Anno 943) states that Count Herbert died in that year, and was buried by his sons at St Quentin, that when they learnt that Raoul, son of Raoul de Gouy, was about to invade their father's territory, they attacked him and put him to death. The identity of other of the personages of the story has also been fixed from historical sources. The second part of the poem, of which Bernier is the hero, is of later date, and bears the character of a *roman d'aventures*.

See *Li Romans de Raoul de Cambrai et de Bernier*, ed. E. le Glay (Paris, 1840); *Raoul de Cambrai*, ed. P. Meyer and A. Longnon (*Soc. des anc. textes fr.*, Paris, 1882); J. M. Ludlow, *Popular Epics of the Middle Ages* (London and Cambridge, 1865); H. Gröber, *Grundriss d. roman. Phil.* (ii. pp. 567 seq.).

RAOUL ROCHETTE, DÉsirÉ (1790-1854), French archaeologist, was born on the 9th of March 1790 at St Amand in the department of Cher, and received his education at Bourges. He was made professor of history in the Collège de Louis-le-Grand at Paris (1813) and in the Sorbonne (1817). His *Histoire critique de l'établissement des colonies grecques* (4 vols., 1815) is now out of date. He was superintendent of antiquities in the Bibliothèque at Paris (1810-48), and professor of

archaeology at the Bibliothèque (from 1826), a result of which may be seen in his *Cours d'archéologie* (1828). In 1829 appeared his *Monuments inédits*, a work of great value at the time. Still valuable are his *Peintures inédites* (1836) and his *Peintures de Pompéi* (1844). He contributed to the *Annali* of the Roman Institute, the *Journal des savants* and the *Académie des inscriptions*. At his death on the 3rd of July 1854 Raoul Rochette was perpetual secretary of the Academy of Fine Arts and a corresponding member of most of the learned societies in Europe.

RAOULT, FRANÇOIS MARIE (1830-1901), French chemist, was born at Fournes, in the Département du Nord, on the 10th of May 1830. He became *aspirant répétiteur* at the lycée of Rheims in 1853, and after holding several intermediate positions was appointed in 1862 to the professorship of chemistry in Sens lycée, where he prepared the thesis on electromotive force which gained him his doctor's degree at Paris in the following year. In 1867 he was put in charge of the chemistry classes at Grenoble, and three years later he succeeded to the chair of chemistry, which he held until his death on the 1st of April 1901. Raoult's earliest researches were physical in character, being largely concerned with the phenomena of the voltaic cell, and later there was a period when more purely chemical questions engaged his attention. But his name is best known in connexion with the work on solutions, to which he devoted the last two decades of his life. His first paper on the depression of the freezing-points of liquids by the presence of substances dissolved in them was published in 1878; and continued investigation and experiment with various solvents, such as benzene and acetic acid, in addition to water, led him to believe in a simple relation between the molecular weights of the substances and the freezing-point of the solvent, which he expressed as the "loi générale de la congélation," that if one molecule of a substance be dissolved in 100 molecules of any given solvent, the temperature of solidification of the latter will be lowered by 0.63° C. (See, however, the article SOLUTION.) Another relation at which he worked was that the diminution in the vapour-pressure of a solvent, caused by dissolving a substance in it, is proportional to the molecular weight of the substance dissolved—at least when the solution is dilute. These two generalizations not only afforded a new method of determining the molecular weights of substances, but have also been utilized by J. H. van't Hoff and W. Ostwald, among other chemists, in support of the hypothesis of electrolytic dissociation in solutions. An account of Raoult's life and work was given by Professor van't Hoff in a memorial lecture delivered before the London Chemical Society on the 26th of March 1902.

RAOUX, JEAN (1677-1734), French painter, was born at Montpellier in 1677. After the usual course of training he became a member of the Academy in 1717 as an historical painter. His reputation had been previously established by the credit of decorations executed during his three years in Italy on the palace of Giustiniani Scini at Venice, and by some easel paintings, the Four Ages of Man (National Gallery), commissioned by the grand prior of Vendôme. To this latter class of subject Raoux devoted himself, nor did he even paint portraits except in character. The list of his works is a long series of sets of the Seasons, of the Hours, of the Elements, or of those scenes of amusement and gallantry in the representation of which he was immeasurably surpassed by his younger rival Watteau. After his stay in England (1720) he lived much in the Temple, where he decorated several rooms. He died in Paris in 1734. His best pupils were Chevalier and Montdidier. His works, of which there is a poor specimen in the Louvre, were much engraved by Poilly, Moyreau, Dupuis, &c.

RAPALLO, a seaport and winter resort of Liguria, Italy, in the province of Genoa. Pop. (1901) 5839 (town); 10,343 (commune). It occupies a beautiful and well-sheltered situation on the east side of the Gulf of Rapallo, 18½ m. E. by S. from Genoa by rail. It has a fine church, a medieval castle (now used as a prison) and a Roman Bridge, known as "Hannibal's Bridge." On the hills above the town is situated the

church and abbey of the Madonna de Montallegro, whose miraculous picture attracts pilgrims from all parts of Italy. Olives and other fruit are grown, and a brisk trade is done in olive oil. A mile to the south is Santa Margherita Ligure (pop. 7051), another winter resort, with a large 16th-century church. Both places are also frequented for sea-bathing in summer. Lace is made, while the men go in May to the coral fisheries off the Sardinian coast. To the south again is the small seaport of Portofino (the Roman *Portus Delphini*) under the south-east extremity of the promontory of Portofino (2010 ft.). On the way from S. Margherita to Portofino is the suppressed monastery of Cervara, in which Francis I. of France was confined after the battle of Pavia on his way to Madrid. At all these places are beautiful villas.

RAPE (Lat. *rapum* or *rapa*, turnip), in botany.—Several forms of plants included in the genus *Brassica* are cultivated for the oil which is present in their ripe seeds. The one most extensively grown for this purpose is known as colza, rape or colesseed, in Germany as *Raps* (*Brassica napus*, var. *oleifera*): its seeds contain from 30 to 45% of oil. The leaves are glaucous and smooth like those of a swede turnip. For a seed-crop rape is sown in July or early August in order that the plants may be strong enough to pass the winter uninjured. The young plants are thinned out to a width of 6 or 8 in. apart, and afterwards kept clean by hoeing. The foliage may be eaten down by sheep early in autumn, without injuring it for the production of a crop of seed. In spring the horse and hand hoe must be used, and the previous application of 1 cwt. or 2 cwt. of guano will add to the productiveness of the crop. On good soil and in favourable seasons the yield sometimes reaches to 40 bushels per acre. The haulm and husks are either used for litter or burned, and the ashes spread upon the land. It makes good fuel for clay-burning. There is a "summer" variety of colza which is sown in April and ripens its seed in the same year. It does not yield so much oil as the "winter" kind, but it will grow on soil in poorer condition. Neither of these is much grown in Great Britain for the production of oil, but the "winter" variety is very extensively grown as green food for sheep. For this purpose it is generally sown at short intervals throughout the summer to provide a succession of fodder. It is peculiarly adapted for peaty soils, and is accordingly a favourite crop in the fen lands of England, and on recently reclaimed mosses and moors elsewhere. Its growth is greatly stimulated by the ashes resulting from the practice of paring and burning. Its highly nutritious leaves and stems are usually consumed by folding the sheep upon it where it grows, there is no green food upon which they fatten faster. Occasionally it is carried to the homestead, and used with other forage in carrying out the system of soiling cattle.

The wild form *Brassica campestris*, the wild colesseed, colza or kohlsaar, of the fields of England and many parts of Europe, is sometimes cultivated on the European continent for its seed, which, however, is inferior in value to rape as an oil-yielding product.

In addition to the previously mentioned rape, a variety of another species (or subspecies) of *Brassica*, namely, *Brassica rapa*, var. *oleifera* (*Rübsen* in Germany), is grown for its oil-yielding seeds. The leaves in a young state are not glaucous, but sap-green in colour and rough, being very similar to those of the turnip, to which the plant is closely related. Both winter and summer varieties are grown; they are rarely cultivated in Britain. The oil is similar to that in the true colza seeds but the plants do not yield so much per acre as the latter: they are, however, hardier and more adapted for cultivation on poor sandy soils.

RAPE (from Lat. *rapere*, to seize), in law, the crime of having carnal knowledge of a woman by a man, not her husband, forcibly and unlawfully against her will. Under the Mosaic law, rape was punished with death, if the damsel was betrothed to another man, and with a fine of fifty shekels if not so betrothed, while in this case, also, she was to be the wife of the ravisher all the days of his life (Deut. xxii. 25). The Roman

civil law punished rape with death and confiscation of goods (Cod. L. IX. tit. 13). In England, under the Saxon law—adopted, probably, from a Teutonic code—death was also the penalty, but under the Normans this was changed to the loss of both eyes and castration; this punishment remained in force until after the time of Bracton (*de Coronâ*, f. 147). The statute of Westminster I. (1275) reduced the offence to a trespass, with a penalty of two years' imprisonment and a fine at the king's will. This lenity, it is said, produced terrible consequences, and, accordingly, the statute of Westminster II. (1285) again declared the offence a felony, with, however, benefit of clergy. This was the state of the law until 1575, when the punishment was made more severe by taking away the benefit of clergy. The offence remained capital until the Offences against the Person Act 1861, by which and subsequent amending acts it is now regulated. The present punishment is penal servitude for life or for not less than three years or imprisonment with or without hard labour for not over two years.

The law of England (differing in this respect from the civil law) regards as immaterial whether the woman is chaste or unchaste, married or single, provided the offence has been committed forcibly and without her consent. The offence is complete if consent is extorted by means of threats of death or immediate bodily harm, by fraud or by false pretences or representation, such as the impersonation of a woman's husband (Criminal Law Amendment Act 1885).

Since the passing of the Criminal Law Amendment Act 1885, it is a felony, entailing the same punishment as rape, to have carnal knowledge of a girl under 13 years, whether she consent or not. Between 13 and 16 years of age it is a criminal offence punishable by two years' imprisonment, whether consent is given or not, and even if there be solicitation; but if the jury is satisfied that the person charged has reasonable cause to believe the girl to be over 16 years, the accused is entitled to be acquitted. Prosecution must be within three months of the offence. The administration of any drug or matter, with intent, by producing stupor, to facilitate the accomplishment of the crime, is an offence punishable by two years' imprisonment. On indictment for rape there may be an acquittal on the actual charge, but a conviction either of the attempt or of an indecent assault.

In charges of rape, from the nature of the offence, the important witness is the woman, and it is essential, apart from medical evidence (see MEDICAL JURISPRUDENCE), that her story be corroborated by evidence implicating the accused. The following points have, of necessity, to be considered. (1) As to the general credibility of the witness and how far her story is to be believed; evidence, therefore, may be given to show that she is of immoral character. (2) As to whether she has made complaint immediately after the alleged outrage and to whom. (3) As to the place where the outrage was alleged to have been committed and the possibility of her being heard if she cried out.

In the United States, rape is universally treated as a felony, and the punishment is either death, imprisonment for life, or imprisonment for a number of years, varying in the different states. In the case of offences against young girls, there is a divergence in the various states as to the age of consent, though the trend of legislation has been to raise it. In North and South Carolina, and Georgia, the age of consent is as low as 10 years, and in Kentucky and Louisiana, 12 years. In nineteen states the age of consent is 14 years. In one (Texas) 15 years. In six, it is 16 years. In Wyoming, New York, Colorado and Kansas it is as high as 18 years.

The essential facts to be proven in order to constitute this crime are the same as in England, but in many of the states the uncorroborated evidence of the woman is sufficient to sustain a conviction. This is so in California, Arizona, Idaho, Missouri, Kentucky, Michigan, Illinois, Oklahoma, &c. [1904; *Brenton v. Territory*, 78 Pac. Rep. 83]. In New York corroboration is required [Penal Code §283]. In Nebraska also evidence corroborating the prosecutrix is necessary [1907; *Burk v. State*, 112 N.W. Rep. 573]. In Texas it is no defence for accused to prove that he believed the prosecutrix to be over 15 years of age, the age of consent [1907; *Robertson v. State*, 102 So. W. Rep. 1130], and the crime is punishable with death [1903; *Keyna v. State*, 75 So. W. Rep. 25], as also apparently it is in the Indian country [U.S. v. *Partello*, 48 Fed. R. 670 U.S. Rev. Stats. § 5345], also in Alabama [Criminal Code, § 5444].

In Hawaii there is no age of consent for rape, which is punishable by \$1000 fine and imprisonment at hard labour for life; the carnal knowledge of females under 10 years is punishable with death or imprisonment for life [Rev. L. 1905, §§ 2927, 2928]. In Porto Rico the age of consent is 14 years and the punishment not less than five years [Pen. Code 1902, §255].

AUTHORITIES.—Stephen, *Digest of Criminal Law*; Russell, *On Crimes*; Archbold, *Criminal Pleading*; and for American law, May, *The Law of Crimes*, and Clark and Marshall, *Treatise on the Law of Crimes*.

RAPE, a territorial division of the county of Sussex, England, formerly used for various administrative purposes. There are now six of these divisions, Hastings, Pevensey, Lewes, Bramber, Arundel and Chichester, but the latter two apparently formed a single rape at the date of the compilation of Domesday Book. The word, which in England is peculiar to Sussex, is usually said to be closely related to the Icelandic *hrœpp*, a small territorial division which in most, but not in all, cases is identical with the parish; but this explanation, which is unsatisfactory on institutional grounds, has also been declared impossible for philological reasons. As an alternative explanation it has been suggested, that "rape" is an early form of the word "rope"; and that the divisions were so called because they were measured and allotted by the rope. Some confirmation of this is to be found in the words of the Norman chronicler, Dudo of St Quentin, who states that Rollo in distributing Neustria "suis fidelibus terram funiculo divisit" (J. P. Migne, *Patrologiæ Cursus completus*, tom. cxli. p. 652). It is possible that the rapes represent the shires of the ancient kingdom of Sussex, especially as in the 12th century they had sheriffs of their own. But there is no evidence of the existence of the rape before the Norman Conquest, except such as may be gathered from Domesday Book, and this is far from convincing. After the Conquest each rape had its own lord, and all the land within it, save that which belonged to the king or to ecclesiastical tenants, was held of the lord. Thus the rape as a lordship only differed from other honours and baronies by the fact that the lands of its knights were not scattered over England, but lay together in a continuous tract. In form the rapes were parallel bands of land running north and south, and each of them contained a different number of hundreds. The place in which the lord's castle was situate ultimately gave its name to the rape; but in Domesday Book the rapes are often described by the names of their lords, and this is always so in that work in the case of Bramber, which belonged to William de Briouze (*rapam Willelmi de Braoza*).

See the *Victoria County History, Sussex*, vol. i.; *New English Dictionary*; and M. A. Lower, *History of Sussex* (Lewes, 1870).

(G. J. T.)

RAPE OIL, an important fatty oil, known also as "sweet oil," either expressed or extracted from the crushed seeds of cultivated varieties of the cruciferous genus *Brassica*, the parent form of the whole apparently being the wild navew, *B. campestris*. Under the general name "rape oil" is included the produce of several plants having distinct and fairly constant characters, and one of these oils—colza (*q.v.*)—is a very well-known commercial variety. In Germany, where the production of rape oil centres, two principal oil-seeds—rape and Rübsen—are well recognized. (See **RAPE**.)

The oil yielded by these seeds is, in physical and chemical properties, practically the same, the range of fluctuations not being greater than would be found in the oil of any specific seed under similar varying conditions of production; the winter varieties of all the seeds are more productive than the summer varieties. Newly pressed rape oil has a dark sherry colour with, at first, scarcely any perceptible smell; but after resting a short time the oil deposits an abundant mucilaginous slime, and by taking up oxygen it acquires a peculiar disagreeable odour and an acrid taste. Refined by the ordinary processes (see **OILS**), the oil assumes a clear golden yellow colour. In specific gravity it ranges between 0.9112 and 0.9117 in the raw state, and from 0.9127 to 0.9136 when refined; the solidifying point is from -4° to -6° C.

The principal uses of rape oil are for lubrication and lighting; but since the introduction of mineral oils for both these purposes the importance of rape has considerably decreased. It is but little employed in soap-making, as it saponifies with difficulty and yields only an indifferent product. In Germany it is very considerably used as a salad oil under the name of Schmalzöl, being for that purpose freed from its biting taste by being mixed with starch, heated till the starch is carbonized, and filtered after the oil has cooled. The offensive taste of rape oil may also be removed by treatment with a small proportion of sweet spirit of nitre (nitrous ether). In the East Indies rape oil and its equivalents, known under various names, are the most important of oils for native use. They are largely consumed as food instead of ghi under the name of "metah" or sweet oil, but for all other purposes the same substance is known as "kurwah" or bitter oil. Most natives prefer it for the preparation of their curries and other hot dishes. Rape oil is the subject of extensive adulteration, principally with the cheaper hemp oil, rosin oil and mineral oils. These sophistications can be most conveniently detected, first by taste and next by saponification, rosin oil and mineral oil remaining unsaponified, hemp oil giving a greenish soap, while rape oil yields a soap with a yellow tinge. With concentrated sulphuric acid, fuming nitric acid, nitrous acid, and other reagents rape oil gives also characteristic colorations; but these are modified according to the degree of purity of the oil itself. The presence of sulphur in rape and other cruciferous oils also affords a ready means for their identification. Lead plaster (*emplastrum lithargyri*) boiled in rape oil dissolves, and, sulphide of lead being formed, the oil becomes brown or black. Other lead compounds give the same black coloration from the formation of sulphide.

RAPHAEL (Hebrew רפאל, "God heals"), an angel who in human disguise and under the name of Azarias ("Yahweh helps") accompanies Tobias in his adventurous journey and conquers the demon Asmodeus (Book of Tobit). He is said (Tob. xii. 15) to be "one of the seven holy angels [archangels] which present the prayers of the saints and go in before the glory of the Holy One." In the Book of Enoch (c. xx.) Raphael is "the angel of the spirits of men," and it is his business to "heal the earth which the angels have defiled." In later Midrash Raphael appears as the angel commissioned to put down the evil spirits that vexed the sons of Noah with plagues and sicknesses after the Flood, and he it was who taught men the use of simples and furnished materials for the "Book of Noah," the earliest treatise on materia medica.

RAPHAEL SANZIO (1483–1520), the great Italian painter, was the son of Giovanni Sanzio or Santi, a painter of some repute in the ducal city of Urbino, situated among the Apennines on the borders of Tuscany and Umbria.¹ For many years both before and after the birth of Raphael (6th of April 1483) the city of Urbino was one of the chief centres in Italy of intellectual and artistic activity, thanks to its highly cultured rulers, Duke Federigo II. of Montefeltro and his son Guidobaldo, who succeeded him in 1482,² the year before Raphael was born. Giovanni Santi was a welcome guest at this miniature but splendid court, and the rich treasures which the palace contained, familiar to Raphael from his earliest years, were a very important item among the various influences which formed and fostered his early love for art. It may not perhaps be purely fanciful to trace Raphael's boyish admiration of the oil-paintings of Jan Van Eyck and Justus of Ghent in the miniature-like care and delicacy with which some of his earliest works, such as the "Apollo and Marsyas," were executed.

Though Raphael lost his father at the age of eleven, yet to him he certainly owed a great part of that early training which enabled him to produce paintings of apparently mature beauty when he was scarcely twenty years of age. The altar-piece painted by Giovanni for the church of Gradara, and a fresco, now preserved in the Santi house³ at Urbino, are clearly prototypes of some of Raphael's most graceful

¹ See Pungileoni, *Elogio Storico di Raffaello* (Urbino, 1829); for a valuable account of Raphael's family and his early life, see also, *Id., Vita di Giov. Santi* (Urbino, 1822), and Campori, *Notizie e Documenti per la Vita di Giov. Santi e di Raffaello* (Modena, 1870).

² See an interesting account of the court of Urbino by Delaborde, *Études sur les B. Arts . . . en Italie* (Paris, 1864), vol. i. p. 145.

³ The house of Giovanni Santi, where Raphael was born, still exists at Urbino in the Contrada del Monte, and, being the property of the municipality, is now safe from destruction.

paintings of the Madonna and Child. On the death of his father in 1494 Raphael was left in the care of his stepmother (his own mother, Magia Ciarla, having died in 1491) and of his uncle, a priest called Bartolomeo.¹

First or Perugian Period.—In what year Raphael was apprenticed to Perugino and how the interval before that was spent are matters of doubt. Vasari's statement that he was sent to Perugia during his father's lifetime is certainly a mistake. On the whole it appears most probable that he did not enter Perugino's studio till the end of 1499, as during the four or five years before that Perugino was mostly absent from his native city.² The so-called *Sketch Book of Raphael* in the academy of Venice contains studies apparently from the cartoons of some of Perugino's Sistine frescoes, possibly done as practice in drawing.

This celebrated collection of thirty drawings, now framed or preserved in portfolios, bears signs of having once formed a bound book, and has been supposed to be a sketch-book filled by Raphael during his Perugian apprenticeship. Many points, however, make this tempting hypothesis very improbable; the fact that the drawings were not all originally on leaves of the same size, and the miscellaneous character of the sketches—varying much both in style and merit of execution—seem to show that it is a collection of studies by different hands, made and bound together by some subsequent owner, and may contain but very few drawings by Raphael himself.³

Before long Raphael appears to have been admitted to share in the execution of paintings by his master; and his touch can with more or less certainty be traced in some of Perugino's panels which were executed about 1502. Many of those who, like Crowe and Cavalcaselle, adopt the earlier date of Raphael's apprenticeship, believe that his hand is visible in the execution of the beautiful series of frescoes by Perugino in the Sala del Cambio, dated 1500; as does also M. Müntz in his excellent *Raphael, sa vie*, Paris, 1881, in spite of his accepting the end of 1499 as the period of Raphael's first entering Perugino's studio,—two statements almost impossible to reconcile. Considering that Raphael was barely seventeen when these frescoes were painted, it is hardly reasonable to attribute the finest heads to his hand; nor did he at an early age master the difficulties of *fresco buono*. The Resurrection of Christ in the Vatican and the Diotalevi Madonna in the Berlin Museum are the principal pictures by Perugino in parts of which the touch of Raphael appears to be visible, though any real certainty on this point is unattainable.⁴

About 1502 Raphael began to execute independent works; four pictures for churches at Città di Castello were probably the earliest of these, and appear to have been painted in the years 1502-4. The first is a gild-banner painted on one side with the Trinity, and below, kneeling figures of S. Sebastian and S. Rocco; on the reverse is a Creation of Eve, very like Perugino in style, but possessing more grace and breadth of treatment. These are still in the church of S. Trinità.⁵ Also

¹ The administration of Giovanni Santi's will occasioned many painful family disputes and even appeals to law; see Pungileoni, *El. Stor. di Raffaello*.

² Crowe and Cavalcaselle (*Life of Raphael*, vol. i., London, 1882) adopt the notion that Raphael went to Perugia in 1495, but the reasons with which they support this view appear insufficient.

³ See an excellent critical examination of the *Sketch Book* by Morelli, *Italian Masters in German Galleries*, translated by Mrs Richter (London, 1882); according to Morelli, only two drawings are by Raphael. Schmarsow, "Raphael's Skizzenbuch in Venedig," in *Preussische Jahrbücher*, xlviii. pp. 122-149 (Berlin, 1881), takes the opposite view. But Kahl, *Das venezianische Skizzenbuch* (Leipzig, 1882), follows Morelli's opinion, which has been generally adopted.

⁴ Parts of Perugino's beautiful triptych of the Madonna, with the archangels Raphael and Michael, painted for the Certosa near Pavia and now in the National Gallery of London, have been attributed to Raphael, but with little reason. Perugino's grand altar-piece at Florence of the Assumption of the Virgin shows that he was quite capable of painting figures equal in beauty and delicacy to the St Michael of the Certosa triptych. See Frizzioni, *L'Arte Italiana nella Gal. Nat. di Londra* (Florence, 1880).

⁵ For an account of processional banners painted by distinguished artists, see Mariotti, *Lettere pittoresche Perugine*, p. 76 seq.

for Città di Castello were the coronation of S. Niccolo Tolentino, now destroyed, though studies for it exist at Oxford and Lille (*Gaz. d. B. Arts*, 1878, i. p. 48), and the Crucifixion, now in the Dudley collection, painted for the church of S. Domenico, and signed **RAPHAEL VRBINAS P.** It is a panel 8 ft. 6 in. high by 5 ft. 5 in. wide, and contains noble figures of the Virgin, St John, St Jerome and St Mary Magdalene. The fourth painting executed for this town, for the church of S. Francesco, is the exquisitely beautiful and highly finished Sposalizio, now in the Brera at Milan, signed and dated **RAPHAEL VRBINAS MDIII.** This is closely copied both in composition and detail from Perugino's painting of the same subject now at Caen, but is far superior to it in sweetness of expression and grace of attitude. The Temple of Jerusalem, a domed octagon with outer ambulatory in Perugino's picture, is reproduced with slight alterations by Raphael, and the attitudes and grouping of the figures are almost exactly the same in both. The Conestabile Madonna is one of Raphael's finest works, painted during his Perugian period; it is a round panel; the motive, the Virgin reading a book of hours, is a favourite one with him, as it was with his father Giovanni. This lovely picture was lost to Perugia in 1871, when Count Conestabile sold it to the emperor of Russia for £13,200.

Second or Florentine Period, 1504-1508.—From 1504 to 1508 Raphael's life was very stirring and active. In the first half of 1504 he visited Urbino, where he painted two small panels for Duke Guidobaldo, the St George and the St Michael of the Louvre. His first and for him momentous visit to Florence was made towards the end of 1504, when he presented himself with a warm letter of recommendation⁶ from his patroness Joanna della Rovere to the gonfaloniere Pier Soderini. In Florence Raphael was kindly received, and, in spite of his youth (being barely of age), was welcomed as an equal by the majority of those great artists who at that time had raised Florence to a pitch of artistic celebrity far above all other cities of the world. At the time of his arrival the whole of artistic Italy was being excited to enthusiasm by the cartoons of the battle of Anghiari and the war with Pisa, on which Leonardo da Vinci and Michelangelo were then devoting their utmost energies. To describe the various influences under which Raphael came, and the many sources, from which he drank in stores of artistic knowledge, would be to give a complete history of Florentine art in the 15th century.⁷ With astonishing rapidity he shook off the mannerisms of Perugino, and put one great artist after another under contribution for some special power of drawing, beauty of colour, or grace of composition in which each happened to excel. Nor was it from painters only that Raphael acquired his enlarged field of knowledge and rapidly growing powers. Sculptors like Ghiberti and Donatello must be numbered among those whose works helped to develop his new-born style.⁸ The Carmine frescoes of Masaccio and Masolino taught this eager student long-remembered lessons of methods of dramatic expression.⁹ Among his contemporaries it was especially Signorelli and Michelangelo who taught him the importance of precision of line and the necessity of a thorough knowledge of the human form.¹⁰ From da Vinci he learnt subtleties of modelling and soft beauty of expression,¹¹ from Fra Bartolommeo nobility of composition and skilful treatment of drapery in dignified folds.¹² The friendship between Raphael and the last of these was very close and lasted for many years. The architect Baccio d'Agnolo was another of his special friends, at whose house the young painter enjoyed social intercourse

⁶ This letter, which still exists, was sold in Paris in 1856, and is now in private hands.

⁷ See Minghetti, "I Maestri di Raffaello," in the *Nuova Antologia*, 1st August 1881.

⁸ See his sketch of St George and the Dragon, in the Uffizi, largely taken from Donatello's pedestal relief outside Or San Michele.

⁹ See his cartoon of St Paul preaching at Athens (Victoria and Albert Museum).

¹⁰ See many of his life-studies, especially the one he sent to Albert Dürer, now at Vienna.

¹¹ See the portrait of Maddalena Doni in the Pitti.

¹² See the Madonna del Baldacchino in the Pitti.

with a large circle of the chief artists of Florence, and probably learned from him much that was afterwards useful in his practice as an architect.

The transition in Raphael's style from his first or Perugian to his second or Florentine manner is well shown in the large picture of the Coronation of the Virgin painted for Maddalena degli Oddi, now in the Vatican, one of the most beautiful that he ever produced, and especially remarkable for its strong religious sentiment—in this respect a great contrast to the paintings of his last or Roman manner which hang near it. The exquisite grace of the angel musicians and the beauty of the faces show signs of his short visit to Florence, while the general formality of the composition and certain details, such as the fluttering ribands of the angels, recall peculiarities of Perugino and of Pinturicchio, with whose fine picture of the same subject hung close by it is interesting to compare it. Raphael's painting, though by far the more beautiful of the two, is yet inferior to that of Pinturicchio in the composition of the whole; an



FIG. 1.—Silver-point study for the main figures in the Coronation of the Virgin (Vatican). In the Lille museum. Illustrating Raphael's use of draped models during his early period.

awkward horizontal line divides the upper group of the Coronation from that below, the apostles standing round the Virgin's tomb, filled with roses and lilies (Dante, *Par.* xxiii. 73), while the older Perugian has skillfully united the two groups by a less formal arrangement of the figures. The predella of this masterpiece of Raphael is also in the Vatican; some of its small paintings, especially that of the Annunciation to the Virgin, are interesting as showing his careful study of the rules of perspective.¹ Several preparatory sketches for this picture exist: fig. 1 shows a study, now at Lille, for the two principal figures, Christ setting the crown on His mother's head (see fig. 2). It is drawn from two youths in the ordinary dress of the time; and it is interesting to compare it with his later studies from the nude, many of which are for figures which in the future picture were to be draped. It was at Florence, as Vasari says, that Raphael began serious life studies, not only from nude models but also by making careful anatomical drawings from dissected corpses and from skeletons.

His first visit to Florence lasted only a few months; in 1505 he was again in Perugia painting his first fresco, the Trinity and Saints for the Camaldoli monks of San Severo, now a mere wreck from injury and restorations. The date MDV and the signature were added later, probably in 1521. Part of this work was left incomplete by the painter, and the fresco was finished in 1521 (after his death) by his old master Perugino.² It was probably earlier than this that Raphael visited Siena and assisted Pinturicchio with sketches for his Piccolomini frescoes.³ The Madonna of S. Antonio was also finished in 1505, but was probably begun before the Florentine visit.⁴ A

¹ While at Florence he is said to have taught the science of perspective to, his friend Fra Bartolommeo, who certainly gave his young instructor valuable lessons on composition in return.

² The fresco of the Last Supper, dated 1505, in the refectory of S. Onofrio at Florence, is not now claimed as a work of Raphael's, in spite of a signature partly introduced by the restorer.

³ Raphael probably had no hand in the actual execution of the paintings; see Schmarsow, *Raphael und Pinturicchio in Siena* (Stuttgart, 1880), and Milanese, in his edition of Vasari, iii. p. 515 seq., appendix to life of Pinturicchio.

⁴ This fine altar-piece, with many large figures, is now the property of the heirs of the duke of Ripalta, and is stored in the basement of the National Gallery, London.

record of his visit to Siena exists in a sketch of the antique marble group of the Three Graces, then in the cathedral library,



FIG. 2.—The group for which fig. 1 is a study.

from which, not long afterwards, he painted the small panel of the same subject now in Lord Dudley's collection.

In 1506 Raphael was again in Urbino, where he painted for the duke another picture of St George, which was sent to England as a present to Henry VII. The bearer of this and other gifts was Guidobaldo's ambassador, the accomplished Baldassare Castiglione (*q.v.*), a friend of Raphael, whose noble portrait of him is in the Louvre. At the court of Duke Guidobaldo the painter's ideas appear to have been led into a more secular direction, and to this stay in Urbino probably belong the Dudley Graces, the miniature "Knight's Dream of Duty and Pleasure" in the National Gallery (London),⁵ and also the "Apollo and Marsyas," sold in 1882 by Morris Moore to the Louvre for £10,000, a most lovely little panel, painted with almost Flemish minuteness, rich in colour, and graceful in arrangement.⁶

Towards the end of 1506 Raphael returned to Florence, and there (before 1508) produced a large number of his finest works, carefully finished, and for the most part wholly the work of his own hand. Several of these are signed and dated, but the date is frequently very doubtful, owing to his custom of using Roman numerals, introduced among the sham Arabic embroidered on the borders of dresses, so that the I's after the V. are not always distinguishable from the straight lines of the ornament. The following is a list of some of his chief paintings of this period: the "Madonna del Gran Duca" (Pitti); "Madonna del Giardino," 1506 (Vienna); "Holy Family with the Lamb," 1506 or 1507 (Madrid); the "Ansidei Madonna," 1506 or 1507 (National Gallery); the Borghese "Entombment," 1507; Lord Cowper's "Madonna" at Panshanger, 1508; "La bella Giardiniera,"

⁵ This missal-like painting is about 7 in. square; it was bought in 1847 for 1000 guineas. The National Gallery also possesses its cartoon, in brown ink, pricked for transference.

⁶ In spite of some adverse opinions, frequently expressed with extreme virulence, the genuineness of this little gem can hardly be doubted by any one who carefully studies it without bias. Sketches for it at Venice and in the Uffizi also appear to bear the impress of Raphael's manner. See Delaborde, *Études sur les B. Arts . . . en Italie*, i. p. 236; Gruyer, *Raphaël et l'antiquité*, ii. p. 421; Eitelberger, *Rafael's Apollo and Marsyas* (Vienna, 1860); Batté, *Le Raphaël de M. Moore* (Paris, 1859); and also various pamphlets on it by its former owner, Mr. Morris Moore.

1508 (Louvre); the "Eszterhazy Madonna," probably the same year; as well as the "Madonna del Cardellino" (Uffizi), the "Tempi Madonna" (Munich), the "Colonna Madonna" (Berlin), the "Bridgewater Madonna" (Bridgewater House), and the "Orleans Madonna" (duc d'Aumale's collection). The "Ansidei Madonna" was bought in 1884 for the National Gallery from the duke of Marlborough for £70,000, more than three times the highest price ever before given for a picture.¹ It was painted for the Ansidei family of Perugia as an altar-piece in the church of S. Fiorenzo, and is a work of the highest beauty in colour, well preserved and very large in scale. The Virgin with veiled head is seated on a throne, supporting the Infant with one hand and holding a book in the other. Below stands S. Niccolo da Tolentino, for whose altar it was painted; he holds a book and a crozier, and is clad in jewelled mitre and green cope, under which appear the alb and cassock. On the other side is the Baptist, in red mantle and camel's-hair tunic, holding a crystal cross. The rich jewellery in this picture is painted with Flemish-like minuteness. On the border of the Virgin's robe is a date, formerly read as MDV by Passavant and others; it really is MDVI or MDVII. If the later date is the true one, the picture was probably begun a year or two before. A favourite method of grouping his Holy Families is that seen in the "Madonna del Cardellino" and the "Bella Giardiniera," in which the main lines form a pyramid. This arrangement is also used in the "Madonna del Giardino" and in the larger group, including St Joseph and St Elizabeth, known as the "Canigiani Holy Family," now at Munich, one of the least graceful of all Raphael's compositions. The "Entombment of Christ," now in the Galleria Borghese in Rome, was painted during a visit to Perugia in 1507 for Lady Atalanta Baglioni, in memory of the death of her brave and handsome but treacherous son Grifonetto, who was killed in 1500 by his enemies the Oddi party.² The many studies and preliminary sketches³ for this important picture which exist in various collections show that it cost Raphael an unusual amount of thought and labour in its composition, and yet it is quite one of his least successful paintings, especially in colour. It is, however, much injured by scraping and repainting, and appears not to be wholly by his hand. The "Madonna del Baldacchino," one of the finest compositions of the Florentine period, owing much to Fra Bartolommeo, is also unsatisfactory in execution; being left unfinished by Raphael, it was completed by Ridolfo Ghirlandajo, by whom the ungraceful angels of the upper part and the canopy were wholly executed, and even designed. It was painted for the Dei family as an altar-piece for their chapel in S. Spirito, Florence. The "St Catherine" of the National Gallery was probably painted in 1507; its cartoon, pricked for transference, is in the Louvre. In colouring it much resembles parts of the Borghese "Entombment," being quiet and grey in tone. To the Florentine period belong some of his finest portraits, and it is especially in these that da Vinci's influence appears. The portraits of Angelo Doni and his wife Maddalena (Pitti) are vivid and carefully executed paintings, and the unknown lady with hard features (now in the Uffizi) is a masterpiece of noble realism and conscientious finish. The Czartoriski portrait, a graceful effeminate-looking youth with long hair and tapering hands, now moved to Cracow, is probably a work of this period; though worthy to rank with Raphael's finest portraits, its authenticity has been doubted. Very similar in style is the Herrenhausen portrait, once attributed to Giovanni Bellini, but an undoubted work of Raphael, in his second manner; it also represents a young man with long hair, close-shaven chin, a wide cloth hat and black dress, painted in half-length. The

so-called Portrait of Raphael by himself at Hampton Court is a very beautiful work, glowing with light and colour, which may possibly be a genuine picture of about 1506. It represents a pleasant-looking youth with turned-up nose, not bearing the remotest resemblance to Raphael, except the long hair and black cap common to nearly all the portraits of this time.⁴ A fine but much-restored portrait of Raphael by himself, painted at Florence, exists in the Uffizi; it represents him at a very early age, and was probably painted during the early part of his stay in Florence.

Third or Roman Period, 1508-1520.—In 1508 Raphael was painting several important pictures in Florence; in September of that year we find him settled in Rome, from a letter addressed in the warmest terms of affectionate admiration to Francia, to whom he sent a sketch for his "Adoration of the Shepherds," and promised to send his own portrait in return for that which Francia had given him.⁵ Raphael was invited to Rome by his fellow-citizen (not relation, as Vasari says) Bramante, who was then occupied in the erection of the new church of St Peter, the foundation-stone of which had been laid by Julius II. on the 18th of April 1506. At this time the love of the popes for art had already attracted to Rome a number of the chief artists of Tuscany, Umbria and North Italy, among whom were Michelangelo, Signorelli, Perugino, Pinturicchio, Lorenzo Lotto, Peruzzi, Sodoma, and many others, and it was among this brilliant assembly that Raphael, almost at once, took a leading position.⁶ Thanks to Bramante's friendly intervention, Julius II. (Della Rovere) soon became Raphael's most zealous patron and friend, as did also the rich bankers Agostino Chigi (the Rothschild of his time) and Bindo Altoviti, whose portrait, at the age of twenty, now at Munich, is one of the most beautiful that Raphael ever produced.

A series of rooms in the Vatican, over the Appartamenti Borgia, were already decorated with frescoes by Bonfigli,

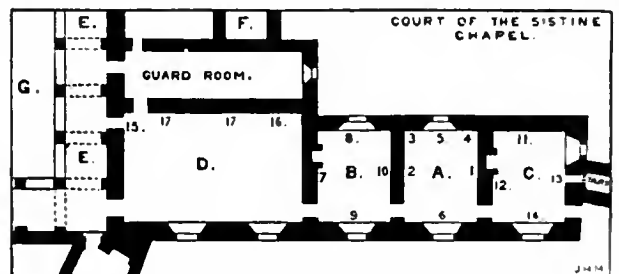

FIG. 3.—Plan showing position of Raphael's frescoes in the stanze.

A. Stanza della Segnatura (1509-11), 1, Disputa; 2, School of Athens; 3, Justinian giving his code to Trebonian; 4, Gregory IX. giving decretals to a jurist; 5 (over the window), Three Virtues; 6 (over the other window), Apollo and a group of poets on Mount Parnassus; vault with medallions of Poetry, Theology, Science, and Justice, and other paintings. B. Stanza d'Eliodoro (1511-14): 7, Expulsion of Heliiodorus from the Temple; 8, Mass of Bolsena; 9, St Peter freed from prison; 10, Attila repulsed by Leo I.; vault with scenes from Old Testament, by pupils. C. Stanza dell' Incendio (1517), nearly all painted by pupils; 11, Burning of the Borgo; 12, Victory of Leo IV. over the Saracens at Ostia; 13, Coronation of Charlemagne by Leo III. in St Peter's; 14, Oath of Leo III. before Charlemagne. D. Sala di Costantino, painted by pupils (1520-24); 15 and 16, oil-paintings of Comitas and Justitia attributed to Raphael; 17, 17, great fresco of the Defeat of Maxentius. E. E. Part of Raphael's loggia, by his pupils. F. Chapel of Nicholas V., painted by Fra Angelico. G. Cortile of Bramante.

Perugino, Piero della Francesca, Andrea del Castagno, Signorelli and Sodoma; but so rapidly had the taste of the time changed that Julius II. decided to sweep them all away and re-cover the

¹ To judge of the authorship of a portrait from internal evidence is especially difficult, as in so many cases the strong individuality of the person represented obscures that of the painter.

² Malvasia, *Felsina pittrice* (Bologna, 1678), was the first to publish this letter; see also Müntz, *Raphael, sa vie, &c.*, p. 315 (Paris, 1881). Minghetti (*Nuova Antologia*, 1883) throws doubt on the date of this letter.

³ Müntz, "Michel-Ange et Raphael à la cour de Rome," *Gaz. des B. Arts*, March and April 1882, and *Les arts à la cour des papes*, vol. iii. (Paris, 1884)

¹ It is engraved at p. 53, vol. ii., of Dohme, *Kunst und Künstler des Mittelalters* (Leipzig, 1878), a work which has many good reproductions of Raphael's paintings and sketches.

² See Symonds, *Sketches in Italy*, the chapter on Perugia, mainly taken from the contemporary chronicle of Matarazzo.

³ These show that Raphael at first intended to paint a Deposition from the Cross, and afterwards altered his scheme into the Entombment; an excess of study and elaboration partly account for the shortcomings of this picture.

walls with paintings in the more developed but less truly decorative style of Raphael. It was not without regret that Raphael saw the destruction of this noble series of frescoes. One vault, that of the Stanza dell' Incendio, painted by his master Perugino, he saved from obliteration; it still exists, well preserved, a most skilful piece of decorative work; and he also set his pupils to copy a number of portrait-heads in the frescoes of Piero della Francesca before they were destroyed.¹ Fig. 3 shows the positions of Raphael's frescoes in the stanze, which, both from their size and method of lighting, are very unsuited for the reception of these large pictures. The two most important rooms (A and B) are small, and have an awkward cross-light from opposite windows.²

Stanza della Segnatura (papal signature room), painted in 1509-11 (A on fig. 3). The first painting executed by Raphael in the stanze was the so-called *Disputa*, finished in 1509. It is very unlike the later ones in style, showing the beginning of transition from his Florentine to his "Roman manner"; as a decorative work it is very superior to the other frescoes; the figures are much smaller in scale, as was suited to the very moderate size of the room, and the whole is arranged mainly on one plane, without those strong effects of perspective which are so unsuited to the decorative treatment of a wall-surface. In its religious sentiment, too, it far excels any of the later stanze paintings, retaining much of the sacred character of earlier Florentine and Umbrian art. As a scheme of decoration it appears to have been suggested by some of the early apsidal mosaics. Fig. 4 shows the disposition of its main masses,

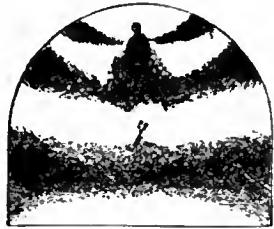

FIG. 4.—Diagram to show main lines of the *Disputa*, suggesting an apse, with mosaic decoration.

which seem to indicate the curved recess of an apse. Gold is largely used, with much richness of effect, while the later purely pictorial frescoes have little or none. The subject of this magnificent painting is the hierarchy of the church on earth and its glory in heaven.³ The angels in the upper tier and the nude cherubs who carry the books of the Gospels are among the most beautiful figures that Raphael ever painted.

The painting on the vault of this room is the next in date, and shows further transition towards the "Roman manner." In his treatment of the whole Raphael has, with much advantage, been

partly guided by the painting of Perugino's vault in the next room (C). Though not without faults, it is a very skilful piece of decoration; the pictures are kept subordinate to the lines of the vault, and their small scale adds greatly to the apparent size of the whole. A great part of the ground is gilt, marked with mosaic-like squares, a common practice with decorative painters—not intended to deceive the eye, but simply to give a softer texture to the gilt surface by breaking up its otherwise monotonous glare. The principal medallions in each cell of this quadripartite vault are very graceful female figures, representing Theology, Science, Justice, and Poetry. Smaller subjects, some almost miniature-like in scale, are arranged in the intermediate spaces, and each has some special meaning in reference to the medallion it adjoins; some of these are painted in warm monochrome to suggest bas-reliefs. The fine painting of the "Flaying of Marsyas" is interesting as showing Raphael's study of antique sculpture: the figure of Marsyas is a copy of a Roman statue, of which several replicas exist. The very beautiful little picture of the "Temptation of Eve" recalls Albert Dürer's treatment of that subject, though only vaguely. Much mutual admiration existed between Raphael and Dürer: in 1515 Raphael sent the German artist a most masterly life study of two nude male figures (now at Vienna); on it is written in Albert Dürer's beautiful hand the date and a record of its being a gift from Raphael. It is executed in red chalk, and was a study for two figures in the "Battle of Ostia" (see below).

On the wall opposite the *Disputa* is the so-called School of Athens.⁴

¹ How fine these portrait-heads probably were may be guessed from Piero's magnificent frescoes at Arezzo, in the retro-choir of S. Francesco.

² See Brunn, *Die Composition der Wandgemälde Raphaels im Vatican* (Berlin), and Gruyer, *Les fresques de Raphaël au Vatican* (Paris, 1859).

³ It need hardly be said that the name *Disputa* is a misnomer; there could be no dispute among the saints and doctors of the church about so well-established a dogma as the real presence: the monstrance with the Host below and the figure of Christ above indicate His double presence both on earth and in heaven. Dr. Braun, Springer, and Hagen have published monographs in German on this painting.

⁴ See Trendelenburg, *Über Raphael's Schule von Athen* (Berlin, 1843), and Richter (same title) (Heidelberg, 1882); the title "School of Athens" is comparatively modern.

In this and the succeeding frescoes all notion of decorative treatment is thrown aside, and Raphael has simply painted a magnificent series of paintings, treated as easel pictures might have been, with but little reference to their architectural surroundings.⁵ The subject of this noble fresco, in contrast to that opposite, is "Earthly Knowledge," represented by an assembly of the great philosophers, poets and men of science of ancient Greece. The central figures are Plato and Aristotle, while below and on each side are groups arranged with the most consummate skill, including the whole "filosofica famiglia" of Dante (*Infer.* iv. 133-144), and a number of other leaders of thought, selected in a way that shows no slight acquaintance with the history of philosophy and science among the ancient Greeks. Many interesting portraits are introduced—Bramante as the aged Archimedes, stooping over a geometrical diagram; a beautiful fair-haired youth on the left is Francesco Maria della Rovere, duke of Urbino; and on the extreme right figures of Raphael himself and Sodoma are introduced (see fig. 5, below). The stately building in which these groups are arranged is taken with modifications from Bramante's first design for St Peter's.

Over the window (No. 6 on fig. 3) is a group of poets and musicians on Mount Parnassus, round a central figure of Apollo; it contains many heads of great beauty and fine portraits of Dante and Petrarch. The former, as a theologian, appears also in the *Disputa*. Over the opposite window (No. 5) are graceful figures of the three chief Virtues, and at one side (No. 4) Gregory IX. (a portrait of Julius II.) presenting his volume of decretals to a jurist; beside him is a splendid portrait of Cardinal de' Medici (afterwards Leo X.) before his face was spoiled by getting too stout. This painting shows the influence of Melozzo da Forlì.⁶ On the other side Justinian presents his code to Trebonianus (No. 3); this is inferior in execution, and appears to have been chiefly painted by pupils.

The next room (B), called La Stanza d'Eliodoro, was painted in 1511-14;⁷ it is so called from the fresco (No. 7 in fig. 3) representing the expulsion of Heliodorus from the Temple (2 Macc. iii.), an allusion to the struggles between Louis XII. of France and Julius II. The whole spirit of the subjects in this room is less broad and tolerant than in the first; no pagan ideas are admitted, and its chief motive is the glorification of the pontificate, with insistence on the temporal power. The main incident of this picture is the least successful part of it: the angel visitant on the horse is wanting in dignity, and the animal is poorly drawn, as is also the case with the horses of Attila's army in the fresco opposite. The group of women and children on the left is, however, very beautiful, and the figures of Julius II. and his attendants are most nobly designed and painted with great vigour. The tall standing figure of Marc Antonio Raimondi, as one of the pope's bearers, is a marvellous piece of portrait-painting, as is also the next figure who bears his name on a scroll—10. **PETRO . DE . FOLIARIIS . CREMONENSIS**. Behind, Giulio Romano is represented as another papal attendant. This picture was completed in 1512. Over the window (No. 8) is the scene of the Miracle at Bolsena of 1264, when the real presence was proved to a doubting priest by the appearance of blood-stains on the Corporal (see ORVIETO). Julius II. is introduced kneeling behind the altar; and the lower spaces on each side of the windows are filled with two groups, that on the left with women, that on the right with officers of the papal guard. The last group is one of the most masterly of all throughout the stanze: each face, a careful portrait, is a marvel of expression and power, and the technical skill with which the whole is painted to the utmost degree of finish, almost without any tempera touches, is most wonderful. The next fresco in date (No. 10) is that of the Repulsion of Attila from the walls of Rome by Leo I., miraculously aided by the apparitions of St Peter and St Paul; it contains another allusion to the papal quarrels with France. It was begun in the lifetime of Julius II., but was only half-finished at the time of his death in 1513; thus it happens that the portrait of his successor, the Medici pope Leo X., appears twice over, first as a cardinal riding behind the pope, painted before the death of Julius II., and again in the character of S. Leo, instead of the portrait of Julius which Raphael was about to paint.⁸ Attila with his savage-looking

⁵ He has shown great skill in the way in which he has fitted his end frescoes into the awkward spaces cut into by the windows, but they are none the less treated in a purely pictorial manner.

⁶ Compare his fresco of Sixtus IV., now in the picture-gallery of the Vatican.

⁷ The vault of this room is painted with scenes from the Old Testament on a harsh blue ground, much restored; they are probably the work of Giulio Romano, and in a decorative way are very unsuccessful—a striking contrast to the beautiful vaults of Perugino and Raphael in rooms C and A. The deep blue grounds so much used by Raphael's school are very liable to injury from damp, and in most cases have been coarsely restored. Those in the Villa Madama are untouched, and in parts the damp has changed the ultramarine into emerald green.

⁸ A pen sketch in the Louvre by Raphael shows Julius II. in the place afterwards occupied by Leo X.; another difference in this sketch is that the pope is borne in a chair, not on horseback as in the fresco.

army is not the most successful part of the fresco: the horses are very wooden in appearance, and the tight-fitting scale armour, put on in some impossible-way without any joints, gives a very unreal and theatrical look to the picture. Part is the work of pupils. In 1514 he painted the "Deliverance of St Peter from Prison," with a further political allusion (No. 9). It is very skilfully arranged to fit in the awkward space round the window, and is remarkable for an attempt, not much suited for fresco-painting, to combine and contrast the three different qualities of light coming from the moon, the glory round the angel, and the torches of the sentinels.

For room C Raphael designed and partly painted the "Incendio del Borgo" (No. 11), a fire in the Borgo or Leonine City, which was miraculously stopped by Leo IV, appearing and making the sign of the cross at a window in the Vatican. On the background is shown the façade of the old basilica of St Peter, not yet destroyed when this fresco was painted. One group on the left, in the foreground, is remarkable for its vigour and powerful drawing; the motive is taken from the burning of Troy; a fine nude figure of Æneas issues from the burning houses bearing on his back the old Anchises and leading the boy Ascanius by the hand. Some of the female figures are designed with much grace and dramatic power. Many studies for this picture exist. This is the last of the stanze frescoes on which Raphael himself worked. Others designed by him and painted by Giulio Romano, Gianfrancesco Penni, and other pupils were the "Battle of Ostia" (No. 12), a very nobly composed picture, and the "Oath of Leo III. before Charlemagne" (No. 14). The other great picture in this room (No. 13), the "Coronation of Charlemagne" (a portrait of Francis I. of France), is so very inferior in composition that it is difficult to believe that Raphael even made a sketch for it. The enormous fresco of the "Defeat of Maxentius by Constantine" (room D, No. 17) was painted by Giulio Romano, soon after Raphael's death, from a sketch by the latter; it is even more harsh and disagreeable in colour than most of Giulio Romano's early frescoes.¹ Among the other very inferior frescoes in this great hall are two female figures (Nos. 15 and 16) representing Comitas and Justitia, painted on the wall in oil colours, very harmonious and rich in tone; they are usually, though wrongly, attributed to Raphael himself.

Technical Methods employed in Raphael's Frescoes.—Having made many studies, both nude and draped, for single figures and groups, the painter made a small drawing of the whole composition, which was enlarged by his pupils with the help of numbered squares, drawn all over it, to the full size required,² on paper or canvas. Holes were then pricked along the outlines of the cartoon, and the design pounced through on to an undercoat of dry stucco on the wall, with pounded charcoal and a stiff brush. Over this, early in the morning, a patch of wet stucco was laid, about enough to serve for the day's painting; this of course obliterated the outline on the wall, and the part covered by the patch was again sketched in by freehand, with a point on the wet stucco, so as to be a guide for the outline traced with the brush and the subsequent painting. A line impressed on the wet stucco was easily smoothed out, but a touch of the brush full of pigment sank deeply into the moist stucco, and could not easily be effaced. It will thus be seen that in fresco painting the only use of pouncing the whole design on to the wall was to keep the general positions of the figures right, and was no guide as to the drawing of each separate part. Fig. 5 shows the portrait-heads of himself and Perugino (?), at the extreme right of the School of Athens; on this are visible many of the impressed sketch-lines, and also part of the "fresco edge" of the patch on which this part is painted. The heads in this figure are less than one day's work. It will be seen that there is no attempt at any accuracy of drawing in the impressed lines. Raphael, especially in his later frescoes, worked with wonderful rapidity: three life-sized busts, or half a full-length figure, more than life-size, was a not unusual day's work. In some of the frescoes the edges of each day's patch of stucco can easily be traced, especially in the Incendio del Borgo, which has a strong side light. In the Disputa much use was made of tempera in the final touches, but less was used in the subsequent frescoes, owing to his increasing mastery of the difficulties of the process.

The paintings in the stanze were only a small part of Raphael's work between 1509 and 1513. To this period belong the Madonna of Foligno (Vatican), painted in 1511 for Sigismondo Conti; it is one of his most beautiful compositions, full of the utmost grace and sweetness of expression, and appears to be wholly the work of his hand. It has suffered much from repainting. Of about the same date are the gem-like Garvagh Madonna (National Gallery, bought for £9000; once in the possession of the Aldobrandini family), the Diademed Virgin

¹ See Montagnani, *Sala di Costantino* (Rome, 1834). Though he was never a good colourist, the great frescoes by Giulio Romano in the Palazzo del Tè, Mantua, show some improvement as compared with his Roman work.

² These three stages were usually distinguished as *study*, *sketch* and *cartoon*.

of the Louvre, and the Madonna del Pesce at Madrid. The last is a very noble picture but the design is more pleasing than the



FIG. 5.—Heads of Raphael and Perugino (?), from the School of Athens, showing incised lines and "fresco edges."

colour, which, like other paintings of Raphael's at Madrid, suggests the inferior touch of a pupil; it was executed in 1513 for S. Domenico in Naples. In addition to other easel pictures a number of his finest portraits belong to this period—that of Julius II. (Uffizi),³ of which a good replica or contemporary copy exists in the National Gallery, the so-called Fornarina in the Palazzo Barberini, the Baldassare Castiglione of the Louvre, and the unfinished portrait of Federigo Gonzaga of Mantua.

When Giovanni de' Medici, at the age of thirty-eight, became pope as Leo X., a period of the most glowing splendour and reckless magnificence succeeded the sterner rule of Julius II. Agostino Chigi, the Siense financier, was the chief of those whose lavish expenditure contributed to enrich Rome with countless works of art. For him Raphael painted, in 1513-14, the very beautiful fresco of the Triumph of Galatea in his new palace by the Tiber bank, the Villa Farnesina, and also made a large series of magnificent designs from Apuleius's romance of Cupid and Psyche, which were carried out by a number of his pupils.⁴ These cover the vault and lunettes of a large loggia (now closed in for protection); in colouring they are mostly harsh and gaudy,⁵ as is usually the case with the works of his pupils, a great contrast to the fresco of the Galatea, the greater part of which is certainly the master's own work.⁶ For the same patron he painted (also in 1513) his celebrated Sibyls

³ A very fine ancient copy of this portrait is in the Pitti Palace; certain peculiarities in its execution show it to be by some Venetian painter, as was pointed out to Professor Middleton by Mr Fairfax Murray.

⁴ Chiefly by Giulio Romano, Gianfrancesco Penni and Giovanni da Udine; much injury has been done to these frescoes by repainting, especially in the coarse blue of the ground.

⁵ These and other frescoes by his pupils are much disfigured by the disagreeable hot tone of the flesh, very unlike the pearly tone of the flesh of Galatea.

⁶ Dorigny, *Psychis et Amoris fabula a Raphaelae, &c.* (Rome, 1693); and Gruner, *Fresco Decorations in Italy* (London, 1854), pls. 16-18. The group of the Triton and Nymph on the left of the composition was probably executed by Giulio Romano.

in S. Maria della Pace,—figures of exquisite grace, arranged with perfect skill in an awkward space. It is not without



FIG. 6.—Mosaic of God creating the stars, from the Chigi chapel, in centre of dome, designed by Raphael.

reason that Vasari gives these the highest position among his fresco-paintings.¹ Agostino Chigi also employed Raphael to build for him a private chapel in S. Maria del Popolo, and to make a series of cartoons to be executed in mosaic on the inner dome.² The central medallion has a figure of God among clouds and angel boys, such as Raphael drew with unrivalled grace (fig. 6), and around are the eight planets, each with its pagan deity and directing angel.³ He has not hampered himself by any of the usual rules which should apply to the designing of mosaic; they are simply treated as pictures, with almost deceptive effects of perspective. The execution of these brilliant mosaics was carried out by the Venetian Luigi della Pace, whose signature is introduced on the torch of Cupid in

the panel representing the star Venus (Ludovico della Pace Veneziano fecit, 1516). These mosaics are still as perfect and brilliant as if they were the work of yesterday. Probably in the early years of Leo X.'s reign were painted the Madonna della Seggiola (Pitti), the S. Cecilia at Bologna (not completed till 1516), the miniature Vision of Ezekiel (Pitti) and three important pictures at Madrid. The latest of these, known as Lo Spasimo, from the church at Palermo, for which it was painted, is one of Raphael's finest compositions, representing Christ bearing His Cross. It bears signs of Giulio Romano's hand in its heavy colouring with unpleasant purple tones. The Madonna called Della Perla has much changed from the darkening of the pigments; in design it recalls Leonardo da Vinci.⁴ The small Madonna della Rosa is the most perfect in colour of all the master's pictures in the Madrid Gallery, and is usually rather undervalued; it is a most graceful little picture. The portrait of Leo X. with Cardinals de' Rossi and de' Medici, in the Pitti, is one of his finest portrait-pictures, especially as regards the figure of the pope.⁵ Little is known about the Madonna di S. Sisto, the glory of the Dresden Gallery; no studies or sketches for it exist. In style it much resembles the Madonna di Foligno; it is less injured by restoration than the latter.

Among the latest works of Raphael are the large "St Michael and the Devil," in the Louvre, signed "Raphael Urbinas pingebat, MDXVIII," and the very beautiful portrait of the Violin-player, in the Sciarra-Colonna Palace in Rome, also dated 1518; this last bears much resemblance to the painter himself. The British Museum possesses one of Raphael's finest portraits,

¹ Thanks to Michelangelo's generous intervention, Raphael was paid the large sum for that time of 900 gold ducats for this fresco.

² Gruner, *Mosaici in S. Maria del Popolo* (Rome, 1839).

³ In accordance with Dante's scheme in the *Paradiso*.

⁴ La Perla, "the pearl" of the Spanish royal collection, was originally painted for Bishop Louis of Canossa; it was sold by Cromwell with the greater part of Charles I.'s collection at Hampton Court. The composition, though not the execution, of this picture, belongs to Raphael's early years in Rome; it is very remarkable for its delicacy of touch and high finish.

⁵ The magnificent portrait-heads of the Venetian scholars Navagero and Beazzano, now in the Doria Gallery in Rome, are worthy of Raphael at his best, and have for long been attributed to him. There are good contemporary copies at Madrid.

though only a chalk drawing, that of his friend the painter Timoteo della Vite, a masterpiece of expression and vigour; it is executed in black and red, and is but little inferior in chromatic effect to an oil-painting; it is life size, and is executed with wonderful skill and evident keen interest in the subject.

The tapestry cartoons, seven of which are in the Victoria and Albert Museum, were painted by pupils from Raphael's designs. They are part of a set of ten, with scenes from the Acts of the Apostles, intended, when copied in tapestry, to adorn the lower part of the walls of the Sistine chapel. The tapestries themselves, worked at Brussels, are now, after many vicissitudes, hung in a gallery in the Vatican; the set is complete, thus preserving the design of the three lost cartoons. The existing seven, after being cut up into strips for use on the looms, were bought by Rubens for Charles I.⁶ The tapestry copies are executed with wonderful skill, in spite of Raphael's having treated the subjects in a purely pictorial way, with little regard to the exigencies of textile work. The designs are reversed, and the colours far more brilliant than those of the cartoons, much gold and silver being introduced. The noble figure of Christ in the Delivery of the Keys to St Peter is in the tapestry much disfigured by the addition of a number of large gold stars all over the drapery, which spoil the simple dignity of the folds. The rich framework round each picture, designed by Raphael's pupils, probably by Penni and Giovanni da Udine, exists in the tapestries and adds greatly to their decorative effect. The cartoons were executed in 1515 and 1516, and the finished tapestries were first exhibited in their place in the Sistine chapel on the 26th of December 1519—a very short time for the weaving of such large and elaborate pictures. The three of which the cartoons are lost represent the Martyrdom of St Stephen, the Conversion of St Paul, and St Paul in Prison at Philippi. Probably no pictures are better known to have been more often engraved and copied than these seven cartoons.⁷

*The Transfiguration.*⁸—In 1519 Cardinal Giuliano de' Medici (afterwards Clement VII.), as bishop of Narbonne, ordered two altar-pieces for his cathedral—the one by Raphael, the other by Raphael's Venetian rival Sebastiano del Piombo. That by the latter painter is the noble Resurrection of Lazarus, now in the National Gallery, in the drawing of which the Venetian received important aid from Michelangelo. Several studies for Raphael's picture exist, showing that he at first intended to paint a Resurrection of Christ as a pendant to Sebastiano's subject, but soon altered his scheme into the Transfiguration. The eight or nine existing studies are scattered through the Oxford, Lille, Windsor and some private collections. A great part of the lower group was unfinished at the time of the painter's sudden death in 1520, and a good deal of the heavy colouring of Giulio Romano is visible in it. On the death of Raphael the picture became too precious to send out of Rome, and Cardinal de' Medici contented himself with sending the Resurrection of Lazarus to Narbonne. The Transfiguration was bequeathed by him to the monks of S. Pietro in Montorio, in whose church it remained till it was stolen by Napoleon I. It now hangs in the Vatican Gallery.

*Architectural Work.*⁹—Though he designed but few buildings, Raphael's great repute even in this branch of art is shown by the

⁶ Fortunately they were not sold with the bulk of Charles's collection, and remained at Hampton Court till a few years ago. See Koch, *Raphael's Tapeten im Vatican* (Vienna, 1878), and Müntz, *Hist. de la tapisserie italienne* (Paris, 1880).

⁷ The name "arazzi" given by Italians to these tapestries is derived from Arras, where they were erroneously thought to have been woven; they were made at Brussels. It is much to be regretted that visitors to the Vatican are no longer allowed to see these priceless examples of textile work.

⁸ See Morgenstern, *Über Raphael's Verklärung* (Leipzig, 1822), and Justi, *Die Verklärung Christi* (Leipzig, 1870).

⁹ See Ojetti, *Discorso su Raffaello Architetto* (Rome, 1883), but more especially Geymüller's work mentioned in the text, and his *Projets primitifs pour la Bas. de S. Pierre* (Paris, 1875-80); also the works of Hofmann and Bloch (Dresden, 1900).

fact that Bramante, before his death in March 1514, specially requested that Raphael should be made his successor as chief architect of St Peter's. To this most important post he was appointed by a brief of Leo X., dated the 1st of August 1514. The progress of St Peter's was, however, too slow for him to leave much mark on its design. Another work of Bramante's completed, by Raphael, was the graceful Cortile di S. Damaso in the Vatican, including the loggie, which were decorated with stucco-reliefs and paintings of sacred subjects by his pupils under his own supervision, but only very partially from his designs.¹ The Palazzo dell' Aquila, built for Giovanni Battista Branconio, and destroyed in the 17th century during the extension of St Peter's, was one of Raphael's chief works as an architect. He also designed the little cross church, domed at the intersection like a miniature St Peter's, called S. Eligio degli Orefici, which still exists near the Tiber, almost opposite the Farnesina gardens, a work of but little merit. According to M. Geymüller, whose valuable work, *Raffaello come Architetto* (Milan, 1883), has done so much to increase our knowledge of this subject, the Villa Farnesina of Agostino Chigi, usually attributed to Peruzzi, was, as well as its palace-like stables, designed by Raphael; but internal evidence makes this very difficult to believe. It has too much of the delicate and refined character of the 15th century for Raphael, whose taste seems to have been strongly inclined to the more developed classic style, of which Palladio afterwards became the chief exponent. The Palazzo Vidoni, near S. Andrea della Valle, also in Rome, is usually attributed to Raphael, but an original sketch for this in Peruzzi's own hand has recently been identified among the collection of drawings at Siena; this, however, is not a certain proof that the design was not Raphael's. M. Geymüller has, however, shown that the Villa Madama, on the slopes of Monte Mario above Rome, was really designed by him, though its actual carrying out, and the unrivalled stucco-reliefs which make its interior one of the most magnificent palaces in the world, are due to Giulio Romano and Giovanni da Udine, as mentioned in Vasari's life of the latter.² The original design for this villa made by Raphael himself has been discovered by M. Geymüller. Another architectural work was the little Chigi chapel in S. Maria del Popolo, built in 1516, for the dome of which the above-mentioned mosaics were designed (see fig. 6). At the time of his death he was preparing to build himself a handsome palace near the church of S. Eligio; the deed for the purchase of its site was signed by him only a few days before his last short illness. Though not completed till 1530, the Palazzo Pandolfini at Florence was also designed by him; it is a dull scholastic building without any special beauty either in proportion or treatment of the mass; it is illustrated by Montigny and Famin, *Architecture Toscane* (Paris, 1815), pls. 33-36.

A sober criticism of Raphael's architectural works must force one to refuse him a high position in this branch of art. In the church of S. Eligio and the Chigi chapel he is merely a copyist of Bramante, and his more original works show but little power of invention or even mastery of the first principles of architectural design. His details are, however, often delicate and refined (especially in the Palazzo Pandolfini), and he was supremely successful in the decorative treatment of richly ornamented interiors when he did not, as in some of the Vatican stanze, sacrifice the room to the frescoes on its walls.

Sculpture.—That Vasari is right in attributing to him the model for the beautiful statue of Jonah in the Chigi chapel (fig. 7) is borne witness to by two important documents, which show that his almost universal talents led him to attempt with success the preliminary part of the sculptor's art, though there is no evidence to show that he ever worked on marble.³ One of these is a letter written to Michelangelo to warn him that Raphael had been invading his province as a sculptor by modelling a boy, which had been executed in marble by a pupil, and was a work of much beauty. Again, after his death his friend Baldassare Castiglione, in a letter

dated the 8th of May 1523, asks his steward in Rome "if Giulio Romano still possesses a certain boy in marble by Raphael and what his lowest price for it would be,"—"s'egli [Giulio Romano] ha più quel puttino di marino di mano di Raffaello e per quanto si daria all'ultimo." A group in marble of a Dead Boy on his Dolphin Playfellow, now in the St Petersburg Hermitage, has been erroneously supposed to be Raphael's "puttino," which has also been identified with a statuette of a child formerly at Florence in the possession of Signor Molini.⁴ The statue of Jonah was executed in marble by Lorenzetto, a Florentine sculptor; and it remained in his studio for many years after Raphael's death. The Victoria and Albert Museum possesses a small clay sketch for this beautiful group, slightly different from the marble; it is probably the original design by the master's own hand. The whole feeling of the group—a beautiful youth seated on a sea-monster—is purely classical, and the motive is probably taken from some antique statue representing Arion or Taras on a dolphin.⁵ Being intended for a church it was necessary to give the figure a sacred name, and hence the very incongruous title that it received. There is no trace of Raphael's hand in the design of the other statue, an Elijah by Lorenzetto, though it also is ascribed to him by Vasari.

Lesser Arts practised by Raphael.—Like other great artists, Raphael did not disdain to practise the lesser branches of art: a design for a silver perfume-burner with female caryatids is preserved in an engraving by Marco da Ravenna; and he also designed two handsome repoussé salvers for Agostino Chigi, drawings for which are now at Dresden. In designs for tarsia-work and wood-carving he was especially skilful; witness the magnificent doors and shutters of the stanze executed by his pupil Giovanni Barile of Siena.⁶ The majolica designs attributed to him were by a namesake and relation called Raffaello di Ciarla;⁷ and, though many fine dishes and ewers of Urbino and other majolica are decorated with Raphael's designs, they are all taken from pictures or engravings, not specially done by him for ceramic purposes. With the frivolity of his age Leo X. occasionally wasted Raphael's skill on unworthy subjects, such as the scenery of a temporary theatre; and in 1516 the pope set him to paint in fresco the portrait life-size of a large elephant, the gift of the king of Portugal, after the animal was dead.⁸ This elephant is also introduced among the stucco reliefs of the Vatican loggie, with the poetaster Barrabal sitting in mock triumph on its back.

Though Raphael himself does not appear to have practised the art of engraving, yet this formed one of the many branches of art which were carried on under his supervision. A large number of his designs were engraved by his pupils Marcantonio Raimondi and Agostino Veneziano. These valuable engravings are from Raphael's sketches, not from his finished pictures, and in some cases they show



FIG. 7.—Statue of Jonah in the Chigi chapel, designed by Raphael, sculptured by Lorenzetto; heroic size.

¹ See Mariani, *La Bibbia nelle Loggie del Vaticano* (Rome); Anon., *Dipinti nelle Loggie del Vaticano* (Rome, 1841); and Gruner, *Fresco Decorations* (London, 1854), pls. 1-5. Too great a share in the decoration of the loggie is usually given to Raphael; not only the harsh colour but also the feebleness of much of the drawing shows that he can have had but little to do with it.

² See Gruner, *Fresco Decorations, &c.* (London, 1854), pls. 6-12, and Raffaele Santi, *Ornati della Villa Madama, &c.* (Rome, 1875). Two other little known but very beautiful architectural works, executed under Raphael's influence by his pupils, are the bathroom of Cardinal Bibbiena in the Vatican and the bathroom of Clement VII. in the castle of S. Angelo, both richly decorated with delicate stucco-reliefs and paintings, treated after a classical model.

³ See note on p. 369, vol. iv., of Milanese's edition of Vasari (Florence, 1879). To one branch of the sculptor's art, practised under Raphael's supervision, belong the elaborate and delicately executed stucco-reliefs of the loggie and elsewhere. Among these occur many panels with figure-subjects, large in scale and important in composition; those executed during his lifetime are free from the too pictorial character which is an obvious fault in the very magnificent reliefs of the Villa Madama.

⁴ See Appendix, p. 406, vol. iv., of Milanese's edition of Vasari; Rembadi, *Del putto . . . di Raffaello* (Florence, 1872); Gennarelli, *Sopra una Scultura di Raffaello* (Florence, 1873). The evidence which would attribute this piece of sculpture to Raphael is almost worthless. See on the St Petersburg group, Guédonoff, *Über die dem Raphael zugesch. Marmorgruppe* (St Petersburg, 1872).

⁵ Compare this latter subject on reverses of the beautiful didrachms of Tarentum, c. 300 B.C.

⁶ The very beautiful and elaborate choir-stalls of the church of S. Pietro de' Casinensi at Perugia, with panels carved in relief, executed in 1535 by Stefano da Bergamo, are mainly adapted from Raphael's designs.

⁷ Campori, *Natizie Star. d. Maiolica di Ferrara* (3rd ed., Pesaro, 1879), pp. 132-133.

⁸ Under it was inscribed—"Raphael Urbinas quod natura abstulerat arte restituit."

important alterations made in the execution of the picture. Raimondi's engraving of the S. Cecilia of Bologna in design is very inferior to that of the actual painting. Several of Raphael's most important compositions are known to us only by these early engravings, e.g. the Massacre of the Innocents (engraved by Raimondi), which is one of his finest works, both for skilful composition and for masterly drawing of the nude. Another magnificent design is the Judgment of Paris, containing a large number of figures; the nude figure of Minerva is a work of especial force and beauty. A standing figure of Lucretia¹ about to stab herself is also one of his most lovely figures. Many of Raphael's studies for Marcantonio's engravings still exist.

Archæology.—As an antiquary Raphael deserves to take the highest rank. His report² to Leo X. in 1518 is an eloquent plea for the preservation of ancient buildings. In 1515 he had been appointed by Leo X. inspector of all excavations in Rome and within 10 miles round. His careful study of the antique, both statues and modes of decoration, is clearly shown in many of his frescoes, and especially in the graceful stucco reliefs and painted grotteschi, of which he and his pupils made such skilful use in the decorations of the Vatican loggie, the Villa Madama and elsewhere.³

Raphael's Fame.—Among all the painters of the world none has been so universally popular as Raphael, or has so steadily maintained his pre-eminent reputation throughout the many changes in taste which have taken place in the last three and a half centuries. Apart from his combined merits as a draughtsman, colourist and master of graceful composition, he owes the constancy of admiration which has been felt for him partly to the wide range of his subjects, but still more to the wonderful varieties of his style. If the authorship of his paintings were unknown, who would guess that the Spozalizio of the Brera, the Madonna del Baldacchino of the Pitti, and the Transfiguration could possibly be the work of one painter? In the seventeen or eighteen years which composed his short working life he passed through stages of development for which a century would not have seemed too long, while other painters lived through the same changeful time with but little alteration in their manner of work. Perugino, who outlived his wonderful pupil, completed in 1521 Raphael's San Severo fresco in a style differing but little from his paintings executed in the previous century.

In versatility of power Raphael (as a painter) remains almost without a rival; whether painting an altar-piece for a church, a large historical fresco, a portrait or decorative scenes from classical mythology, he seems to excel equally in each; and the widely different methods of painting in tempera, oil or fresco are employed by him with apparently equal facility. His range of scale is no less remarkable, varying from a miniature, finished like an illuminated MS., to colossal figures in fresco dashed in with inimitable breadth and vigour.

His personal beauty, charm of manner and deep kindness of heart endeared him to all who knew him.⁴ His sincere modesty was not diminished by his admission as an equal by the princes of the church, the distinguished scholars and the world-famed men of every class who formed the courts of Julius II. and Leo X. In accordance with the spirit of the age he lived with considerable display and luxury, and was approached with the utmost deference by the ambassadors of foreign princes, whether their master desired a picture, or, as the duke of Ferrara did, sent to consult him on the best cure for smoky chimneys. To his pupils he was as a father, and they were all, as Vasari says, "vinti dalla sua cortesia"; they formed round him a sort of royal retinue, numbering about fifty youths, each talented in some branch of the arts.⁵ Giulio Romano and Gianfrancesco Penni, his two favourite pupils, lived with him in the Palazzo di Bramante, a house near St Peter's, where he resided during the greater part of his life in Rome. This fine

¹ On a pedestal is inscribed in Greek—"Better to die than live basely."

² Published by Visconti, *Lettera di Raffaello a Leone X.* (Rome, 1840); see also Müntz, "Raphaël Archéologue," &c., *Gaz. des B. Arts*, October and November 1880.

³ See Gruyer, *Raphaël et l'antiquité* (Paris, 1864).

⁴ See the eloquent eulogy of his character at the end of Vasari's *Life*.

⁵ See Minghetti, "Gli Scolari di Raffaello," *Nuova Antologia* (June 1880).

palace, designed by Bramante, was destroyed in the 17th century at the same time as Raphael's Palazzo dell' Aquila.

It is difficult to realize the grief and enthusiasm excited by the master's death on Good Friday (April 6th) 1520, at the age of thirty-seven exactly, after an attack of fever which lasted only ten days. His body was laid out in state in his studio, by the side of the unfinished Transfiguration, and all Rome flocked to the place for a last sight of the "divino pittore." His property amounted to about £30,000; his drawings and MSS. he left to Giulio Romano and Gianfrancesco Penni; his newly bought land to Cardinal Bibbiena, the uncle of the lady to whom he had been betrothed; there were liberal bequests to his servants; and the rest was mostly divided among his relatives at Urbino. He desired to be buried in the Pantheon, under the noble dome which he and Bramante had dreamed of rivaling. His body is laid beside an altar, which he endowed with an annual chantry, and on the wall over it is a plain slab, with an inscription written by his friend Cardinal Bembo. Happily his grave has as yet escaped the disfigurement of a pretentious monument such as those erected to Michelangelo, Dante and other great Italians; it has not, however, remained undisturbed: in 1833 it was opened and the bones examined.⁶ In March 1883 a festival was held at Urbino, on the occasion of the 4th centenary of his birth, and on this occasion many interesting articles on Raphael were published, especially one by Geymüller, "Le IV^{me} centenaire de la naissance de Raphaël," 1483-1883, in the *Gaz. de Lausanne*, March 1883.

LITERATURE.—Comolli, *Vita inedita di Raffaello* (1790); Duppa, *Life of Raphael* (London, 1816); Braun, *Raphael... Leben und Werke* (Wiesbaden, 1819); Fea, *Raffaello... ed alcune di lui Opere* (Rome, 1822); Rehberg, *Rafael Sanzio aus Urbino* (Munich, 1824); Quatremère de Quincy, *Vita ed Opere di Raffaello*, trans. by Longhena (Milan, 1829) (a work marred by many inaccuracies); Rumohr, *Über Raphael und sein Verhältniss* (Berlin, 1831); Rio, *Michelange et Raphaël* (Paris, 1863); Gruyer, *Raphaël et l'antiquité* (Paris, 1864); *Les vierges de Raphaël* (Paris, 1878) and *Raphaël, peintre de portraits* (Paris, 1880); Grimm, *Das Leben Raphaels von Urbino* (Berlin, 1872) (intended specially to point out the errors of Vasari and Passavant, and not written in a very fair spirit); Gherardi, *Della Vita di Raffaello* (Urbino, 1874); Anton Springer, *Raffaël und Michelangelo* (Leipzig, 1878); C. C. Perkins, *Raphael and Michelangelo* (Boston, 1878); Dohme, *Kunst und Künstler des Mittelalters* (Leipzig, 1878) (vol. ii. of this valuable work, with many illustrations, is devoted entirely to Raphael and Michelangelo); Alippi, *Il Raffaello* (Urbino, 1880); Clément, *Michelange et Raphaël* (5th ed., improved) (Paris, 1881); Eug. Müntz, *Raphaël, sa vie, son œuvre, &c.* (Paris, 1881) (with numerous well-chosen illustrations); Passavant, *Rafael und sein Vater* (Leipzig, 1839-58) (a valuable book, especially for its list of Raphael's works; a new edition translated by Guasti into Italian was published at Florence in 1882, but this edition is in no way superior to the French one of Lacroix (Paris, 1860), which is a great advance on the original German text); Crowe and Cavalcaselle, *Life and Works of Raphael* (London, 1882-85); Eug. Müntz, *Les historiens et les critiques de Raphaël* (Paris, 1883) (contains a good bibliography of the subject); Morelli, *Italian Masters* (in German, 1880; in English, 1882, and subsequently republished),—practically the starting-point of modern technical criticism; B. Berenson, *Central Italian Painters* (1897) (expert characterization and list of works).

Reproductions of Raphael's Works.—From the time of Raimondi downwards no painter's works have been so frequently engraved. The Calcografia Camerale (now called Regia) of Rome possesses an enormous number of copper-plates of his pictures by a great many good (and bad) engravers of the 18th and 19th centuries. Electrotypes of the old coppers are still worked, and are published by the Stamperia at very moderate prices; in the catalogue Nos. 736 to 894 are the works of Raphael, including several books of engravings containing whole sets, such as the Vatican loggie, &c. A very complete collection of photographs from these and other engravings was published by Gutbier and Lübke, *Rafael's Werke, sämtliche Tafelbilder und Fresken* (Dresden, 1881-82), in three large volumes, divided into classes,—pictures of the Madonna, frescoes, stanze of the Vatican, tapestry cartoons, &c. The descriptive text and life of Raphael are by Lübke. The Malcolm, Oxford, British Museum, Lille, Louvre, Dresden and other collections of Raphael's drawings have mostly been published in photographic facsimile, and an enormous number of illustrated monographs on single pictures exist. Braun's autotypes of the stanze and Farnesina frescoes are especially good. (J. H. M.)

⁶ See "Ritrovamento delle ossa di Raffaello," *Soc. Virtuosi al Panteone* (Rome, 1833); other pamphlets on this were published in the same year by Fea, Falconieri and Odescalchi.

RAPIER, the name given to two distinct types of sword. Originally the "rapier" (Fr. *rapière*) was a long two-edged and pointed weapon with a wide cup hilt, used together with the dagger in fencing and duelling chiefly as a thrusting weapon, the cut taking a secondary position. This was the typical duelling sword of the 16th and 17th centuries. In the 18th century the "small-sword" took its place; this was a pointed weapon only, the "cut" having entirely dropped out, and the dagger being discarded. The word rapier is of doubtful origin. Du Cange (*Glossarium*, s.v. "Rapparia") quotes an example of the word used as an adjective to qualify *espée* as early as 1474, and gives as a conjectural derivation Gr. *ραπίειν*=Lat. *caedere*, to cut. Skeat (*Elym. Dict.*, 1910) follows the suggestion of Diez that *rapière* is from *raspière*, a rasper or poker, and was a name given in contempt by the old cut-and-thrust fencers to the new weapon. Spanish has *raspadera*, a raker, and there are several 16th and 17th century quotations alluding to the contempt with which the rapier was greeted, and to its Spanish origin (see FENCING and SWORD).

RAPIN, PAUL DE (1661-1725), sieur of Thoyras, French historian, was the son of Jacques de Rapin, *avocat* at Castres (Tarn), where he was born on the 25th of March 1661. He was educated at the Protestant academy of Saumur, and in 1679 became an advocate, but soon afterwards entered the army. The revocation of the Edict of Nantes in 1685, and the death of his father led him to come to England; but, unable to find employment there, he crossed to Holland and enlisted in the company of French volunteers at Utrecht commanded by Daniel de Rapin, his cousin-german. He accompanied the prince of Orange to England in 1688, and during the Irish campaign he took part in the siege of Carrickfergus and the battle of the Boyne, and was wounded at the battle of Limerick. Soon afterwards he was promoted captain; but in 1693 he resigned in order to become tutor to the earl of Portland's son. After travelling with his charge, he settled with his family in Holland, first at the Hague, then, for economy's sake, at Wesel, in 1707, where he began his great work, *L'Histoire d'Angleterre*. Though he was of a strong constitution, the seventeen years' application ruined his health. He died in 1725.

Rapin was also the author of a *Dissertation sur les Whigs et les Tories* (1717). *L'Histoire d'Angleterre*, embracing the period from the invasion of the Romans to the death of Charles I., was printed at the Hague in 1724 in 8 vols. It was translated into English and improved with notes by Tindal, in 2 vols. folio, 1725-31. Rapin's history of England was almost the only one available in France in the first half of the 18th century.

RAPOPORT, SAMUEL JUDAH LÖB (1790-1867), Jewish scholar, was born at Lemberg in 1790. After various experiences in business, Rapoport became successively rabbi of Tarnopol (1837) and of Prague (1840). He was one of the founders of the new learning in Judaism. His chief work was the first part of an (unfinished) encyclopaedia (*Erekk Millin*, 1852). Equally notable were his biographies of the Gaon Saadiah, Nathan author of the *Arnkh*, the Gaon Hai, Eleazar Kalir and others. He died at Prague in 1867. (I. A.)

RAPPAREE, properly a short pike (Irish *rapaire*); the term being hence applied in the war in Ireland from 1688-92 to the Irish irregular soldiers armed with this weapon. It thus became synonymous with robber or freebooter, and in 1707 appears in the title of an act (6 Anne, cap. 11) "for the more effectual suppression of . . . robbers and rapparees."

RAPPOLTSWEILER (French *Ribcauville*), a town of Germany, in the imperial province of Alsace-Lorraine. Pop. (1905) 5986. It lies at the entrance of the valley of the Strengbach, under the eastern slope of the Vosges mountains, 33 m. S.W. of Strassburg on the railway to Basel, being connected with its station on that line, 2½ m. distant, by a tramway. It is in part surrounded by ancient walls, and has many picturesque medieval houses, and two old churches, of St Gregory and St Augustine, both fine Gothic buildings. The town hall contains a valuable collection of antiquities. The Carolabad, a saline spring with a temperature of 64° F., which had a great repute in the middle ages, was rediscovered in 1888, and made Rappoltsweiler a

watering-place. The industries include the spinning and weaving of cotton and wool, printing, dyeing and tanning, while there is a brisk trade in wine.

Rappoltsweiler, known in the 8th century as Rathaldovilare, passed from the bishops of Basel to the lords of Rappoltstein, who were among the most famous nobles in Alsace. The lord of Rappoltstein was the king or protector of the wandering minstrels of the land, who purchased his protection by paying him a tax. When the family became extinct in 1673 this office of king of the pipers (*Pfeiferkönig*) passed to the counts palatine of Zweibrücken-Birkenfeld. The minstrels had a pilgrimage chapel near Rappoltsweiler, dedicated to their patron saint, Maria von Dusenbach, and here they held an annual feast on the 8th of September. Near the town are the ruins of three famous castles, Ulrichsburg, Girsberg and Hoh-rappoltstein, which formerly belonged to the lords of Rappoltsstein.

See Bernhard, *Recherches sur l'histoire de la ville de Rappoltsweiler* (Colmar, 1888); and Kube, *Rappoltsweiler, das Carolabad und Umgebung* (Strassburg, 1905). For the lords of Rappoltstein, see Brieger, *Die Herrschaft Rappoltstein* (Strassburg, 1907).

RARE EARTHS, in chemistry, the name given to a group of oxides of certain metals which occur in close association in some very rare minerals. Although these metals resemble each other in their chemical relationships, it is convenient to subdivide them into three groups: the cerium, terbium and ytterbium groups. The first includes scandium (Sc, 44.1), yttrium (Y, 89.0), lanthanum (La, 139.0), cerium (Ce, 140.25), praseodymium (Pr, 140.6), neodymium (Nd, 144.3), and samarium (Sa, 150.4); the second includes europium (Eu, 152.0), gadolinium (Gd, 157.3), and terbium (Tb, 159.2); and the third includes dysprosium (Dy, 162.5), holmium (Ho, ?) erbium (Er, 167.4), thulium (Tm, 168.5), ytterbium or neoytterbium (Yb, 172.0), and lutecium (Lu, 174.0); the letters and numbers in the brackets are the symbols and atomic weights (international). Although very rare, a large number of minerals contain these metals; they are chiefly found in Scandinavia, parts of the Urals, America and Australia, generally associated with Archean and eruptive rocks, and more rarely with sedimentary deposits. They are usually silicates, but many complex tantalates, niobates, phosphates, uranates and fluorides occur. The chief mineral species are monazite, a phosphate of the cerium metals, containing thorium (this mineral supplies the ceria and thoria employed in making incandescent gas mantles); cerite, a hydrated silicate of calcium and the cerium metals; gadolinite, a silicate of beryllium, iron, and the yttrium metals; samarskite, a niobate and tantalate of both the cerium and yttrium metals, with uranium, iron, calcium, etc.; and keilhauite, a titanosilicate of yttrium, iron, calcium and aluminium; other species are fergusonite, orthite, aeschynite, euxenite and thorianite.

The chemistry of this group may be regarded as beginning with Cronstedt's description of the mineral cerite from Bastnaës in 1751, and the incorrect analyses published by T. O. Bergman and Don Fausto d'Elhuyar in 1784. Ten years later Gadolin investigated the mineral subsequently named gadolinite, which had been found at Ytterby in 1788 by Arrhenius. This discovery of a new earth was confirmed by A. G. Ekeberg in 1790, who named the base yttria. Cerite was examined simultaneously by Klaproth in Germany and by Berzelius and Hisinger in Sweden; and a new base was discovered in 1803 which the Swedish chemists named ceria. Both these oxides have proved to be mixtures. In 1839 Mosander separated "ceria" into true ceria and an earth which he termed lanthana (Gr. *λανθάνειν*, to lie hidden), and in 1841 he showed that his lanthana contained another base, which he called didymia (Gr. *διδύμοι*, twins). This didymia was separated in 1870 by Lecoq de Boisbaudran into a new base, samaria, and a residual didymia which was shown by Auer von Welsbach in 1885 to consist of a mixture of two bases, praseodidymia and neodidymia; moreover, samaria was split by Demarçay in 1900 into true samaria and a new base named europia. In 1843 Mosander also split

yttria into two new bases which he called "erbia" and "terbia," and a true yttria, but in 1860 N. J. Berlin denied the existence of Mosander's "erbia," and gave this name to his "terbia." The new erbia has itself proved to be a mixture. Marignac in 1878 separated an ytterbia which was split by Nilson in 1879 into scandia (the metal of which proved to be identical with Mendelëff's predicted eka-boron) and a new ytterbia, which, in turn, was separated by Urbain in 1907 into neoytterbia and lutecia (C. A. von Welsbach proposed for these elements the names aldebarianum and cassiopeium). Berlin's erbia was also examined by Soret in 1878 and by Cleve in 1879; the new base then isolated, Soret's X or Cleve's holmia, was split by Lecoq de Boisbaudran in 1886 into a true holmia and a new oxide dysprosia. The same erbia also yielded another base, thulia, to Cleve, in 1879, in addition to true erbia. The original erbia of Mosander was confirmed by M. A. Delafontaine in 1878 and renamed terbia; this base was split by Marignac in 1886 into gadolinia and true terbia. These relations are schematically shown below; the true earths are in italics, mixtures in Roman.

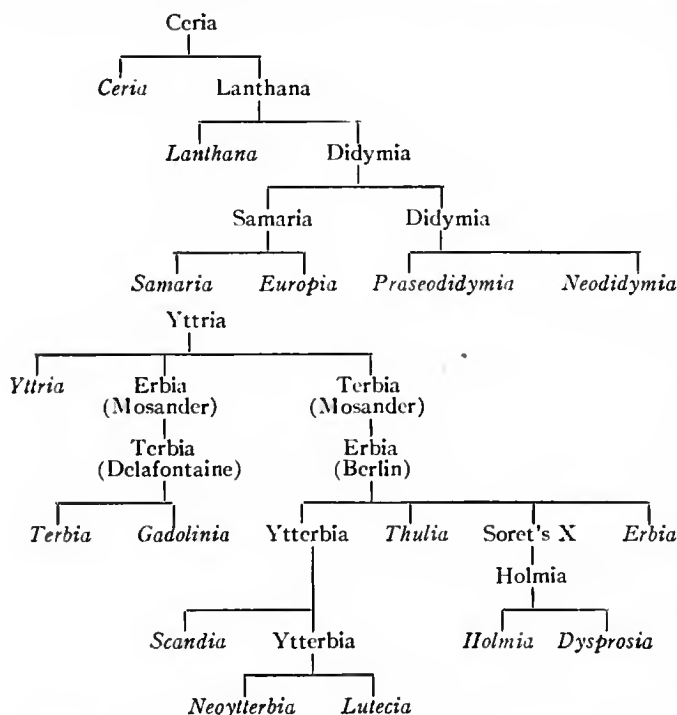

Methods of Separation.—The small proportions in which the rare earths occur in the mineral kingdom and the general intermixture of several of them renders their efficient separation a matter of much difficulty, which is increased by their striking chemical resemblances. While it is impossible to treat the separations in detail, a general indication of the procedure may be given. The first step is to separate the rare earths from the other components of the mineral. For this purpose the mineral is evaporated with sulphuric or hydrochloric acid, or fused with potassium bisulphate, and the residue extracted with water. The solution of chlorides or sulphates thus obtained is treated with sulphuretted hydrogen, to remove copper, bismuth and molybdenum, and the filtrate, after the ferrous iron has been oxidized with chlorine, is precipitated with oxalic acid. The oxalates (and also thorium oxalate) may be converted into oxides by direct heating, into nitrates by dissolving in nitric acid, or into hydroxides by boiling with potash solution. The thorium may be removed by treating the nitrate solution with hydrogen peroxide, and warming, whereupon it separates as thorium peroxide. The next step consists in neutralizing the nitric acid solution and then saturating with potassium sulphate. Double salts of the general formula $R_2(SO_4)_3 \cdot 3K_2SO_4$ are formed, of which those of the cerium group are practically insoluble, of the terbium group soluble, and of the yttrium group very

soluble. The sulphates thus obtained may be reconverted into oxalates or oxides and the saturation with potassium sulphate repeated.

To separate the individual metals many different methods have been proposed; these, however, depend on two principles, one, on the different basicities of the metals, the other, on the different solubilities of their salts. Bahr and Bunsen worked out a process of the first type, which utilized the fractional decomposition of the nitrates into oxides on heating. The mixed oxalates are converted into nitrates, which are then mixed with an alkali nitrate to lower the melting-point, and the mixture fused. The nitrates decompose in order of the basicities of the metals, and after a short fusion the residue is extracted with boiling water, and the basic salt which separates when the solution is cooled is filtered off. This contains the most negative metal; and the filtrate, after evaporation and a repetition of the fusion and extraction, may be caused to yield the other oxides. A second method, based on the same principle, consists in the fractional precipitation by some base, such as ammonia, soda, potash, aniline, &c. The neutral nitrates are dissolved in water, and the base added in such a quantity to precipitate the oxides only partially and very slowly. Obviously the first deposit contains the least basic oxide, which by re-solution as nitrate and re-precipitation yields a purer product. To the filtrate from the first precipitate more of the base is added, and the second less basic oxide is thrown down. By repeating the process all the bases can be obtained more or less pure.

Many processes depending upon the different solubilities of certain salts have been devised. They consist in forming the desired salt and fractionally crystallizing. The mother liquor is concentrated and crystallized, the crystals being added to the filtrate from a re-crystallization of the first deposit. These operations are repeated after the manner shown in the following scheme; the letter C denotes crystals, the M.L. mother liquor, whilst a bracket means mixing before re-crystallization.

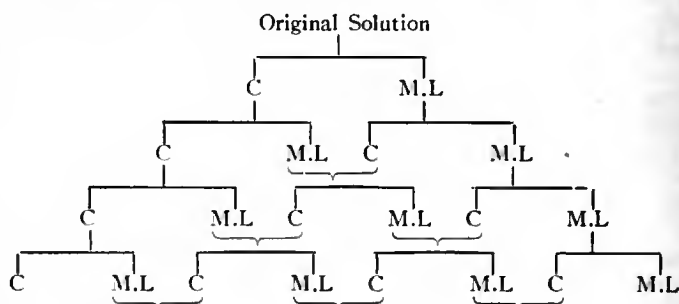

Obviously the fractions contain salts which increase in solubility as one passes from the left to right, and with sufficient care and patience this method permits a complete separation. The salts which have been used include the sulphates, nitrates, chromates, formates, oxalates and malonates. R. J. Meyer (*Zeit. anorg. Chem.*, 1904, 41, p. 97) separates the cerium earths by forming the double potassium carbonates, e.g. $K_2Ce_2(CO_3)_4 \cdot 12H_2O$, which are soluble in potassium carbonate solution, being precipitated in the order lanthanum, praseodymium, cerium and neodymium on diluting the solution; C. A. von Welsbach (*Chem. News*, 1907, 95, p. 196; 1908, 98, pp. 223, 297) separates the metals of the yttrium group by converting the basic nitrates into double ammonium oxalates and fractionating; C. James (*ibid.*, 1907, 95, p. 181; 1908, 97, pp. 61, 205) formed the oxalates of the yttrium earths and dissolved them in dilute ammonia saturated with ammonium carbonate; by boiling this solution the earths are precipitated in the order yttrium, holmium and dysprosium, and erbium; he also fractionally crystallized the bromates (see, e.g. *Jour. Amer. Chem. Soc.*, 1910, 32, p. 517, for thulium). Complex organic reagents are also employed. Neish (*Jour. Amer. Chem. Soc.*, 1904, 26, p. 780) used meta-nitrobenzoic acid; O. Holmberg separates neodymium, praseodymium and lanthanum (and also thorium) with meta-nitrobenzene sulphonic acid, and has investigated many other organic salts (see *Abs. J. C. S.*, 1907, ii. p. 90), whilst H. Erdmann and F. Wirth (*Ann.*, 1908, 361, p. 180) employ the 1-8 naphthol sulphonates.

In order to determine whether any chosen method for separating these earths is really effective, it is necessary to analyse the fractions. For this purpose two processes are available. We may convert the salt into the oxalate from which the oxide is obtained by heating. A weighed quantity of the oxide is now taken and converted into sulphate by evaporating with dilute sulphuric acid. The sulphate is gently dried until the weight is constant, and from this weight the equivalent of the earth can be calculated. When repeated fractionation is attended by no change in the equivalent we may conclude that only one element is present. This process, however, is only rough, for the elements with which we are dealing have very close equivalents. A more exact method employs the

spectra—spark, arc, phosphorescence and absorption; the evidence, however, cannot in all cases be accepted as conclusive, but when taken in conjunction with chemical tests it is the most valuable method.

Chemical Relations.—The rare earth metals were at first regarded as divalent, but determinations of the specific heats of cerium by Mendeléeff and Hillebrand and of lanthanum and didymium by Hillebrand pointed to their trivalency; and this view now has general acceptance. They are comparatively reactive: they burn in air to form oxides of the type Me_2O_3 ; combine directly with hydrogen at 200° – 300° to form hydrides of the formula MH_2 or MH_3 ; nitrides of the formula MN are formed by passing nitrogen over the oxides mixed with magnesium; whilst carbides of the type MC_2 are obtained in the electrolytic reduction of the oxides with carbon. In addition to the oxides M_2O_3 , several, e.g. cerium, terbium and neodymium, form oxides of the formula MO_2 . The sesquioxides are bases which form salts and increase in basicity in the order Sc, Yb, Tm, Er, Ho, Tb, Gd, Sm, Y, Ce, Nd, Pr, La; the latter hissing with water like quicklime.

The placing of these elements in the periodic table has attracted much attention on account of the many difficulties which it presented. The simplest plan of regarding them all as trivalent and placing them in the third group is met by the fact that there is not room for them. Another scheme scatters them in the order of their atomic weights in the last four groups of the system, but grave objections have been urged against this plan. A third device places them in one group as a bridge between barium and tantalum. This was suggested by Benedick in 1904 (*Zeit. anorg. Chem.*, 1904, 39, p. 41), and adopted in Werner's table of 1905 (*Ber.* 38, p. 914), whilst in 1902 Brauner (*ibid.* 32, p. 18) placed the group as a bridge on a plane perpendicular to the planes containing the other elements, thus expanding the table into a three-dimensional figure. The question has also been considered by Sir William Crookes (*Jour. Chem. Soc.*, 1888, 53, p. 487; 1889, 55, pp. 257 et seq.), whose inquiries led him to a new conception of the chemical elements.

REFERENCES.—For the general chemistry see R. Böhm, *Seltene Erden* (1905); Abegg, *Handbuch der anorganischen Chemie* (1906), vol. iii. (article by R. T. Meyer); H. Moissan, *Traité de chimie minérale* (1904), vol. iii. (article by G. Urbain); Roscoe and Schorlemmer, *Treatise on Chemistry* (1908), vol. ii.; P. E. Browning, *Introduction to the Rarer Elements* (1909); see also A. W. Stewart, *Recent Advances in Physical and Inorganic Chemistry* (1909). For the rare earth minerals see J. Schilling, *Das Vorkommen der seltenen Erden im Mineralreiche* (1904).

RAS, the Arabic for a "head," hence a cape, promontory or headland; a common word in place names.

RASCAL, a term originally used in the sense of a rabble, especially descriptive of camp-followers or the dregs of an army, or of the lowest of the people; now only of a single person, in the sense of a rogue or knave. The origin of O.Fr. *rascaille*, modern *racaille*, from which the word came into English, is uncertain. The word was early used, in hunting, for the weaker or poorer male deer of a herd; the word has been connected with O.Fr. *rascler*, mod. *racler*, to scrape, rake, in the sense of the off-scourings of the herd.

RASHBAM (1085–1174), Jewish scholar, so called from the initials of his full name, **RABBI SAMUEL BEN MEIR**, was a leading member of the French school of Biblical exegesis. He was a grandson of Rashi (*q.v.*), but differed in his method of interpretation. He wrote commentaries on the Pentateuch and some other parts of the Scriptures. Rashbam adopts a natural (as distinct from a homiletical and traditional) method; thus (in agreement with the modern school) Rashbam (on Gen. i. 5) maintained that the day began at dawn and not from the previous sunset (as later Jewish custom assumed). Another famous interpretation was Rashbam's view that the much disputed phrase in Gen. xlix. 10 must be rendered "Until he cometh to Shiloh," and refers to the division of the kingdom of Judah after Solomon's death. Rashbam's notes on the Bible are remarkable for brevity, but when he comments on the Talmud—he wrote explanations on several tracts—he is equally noted for prolixity.

(I. A.)

RASHI (1040–1105), Jewish scholar. **RABBI SOLOMON IZHAQI** (son of Isaac), usually cited as Rashi from the initials of those words, was born at Troyes in 1040 and died in the same town in 1105. Legends concerning him are many. Isaac's wife, shortly before the birth of their famous son, was walking one day down a narrow street in Worms, when two vehicles moving in opposite directions seemed about to crush her. As she leant hopelessly against a wall, it miraculously fell inwards to make a niche for her. So with his education. Legend sends the student to southern France, and even on a tour of the world. At an inn in the Orient he cured a sick monk, who later on, as bishop of Olmütz, returned the kindness by saving the Jews from massacre. In fact, Rashi never went farther than from the Seine to the Rhine; the utmost limit of his travels were the academies of Lorraine. Situated between France and Germany, Lorraine was more French than German, and French was the common language of Jew and Christian. This is shown by the glosses in Rashi's works, almost invariably in French. He seems to have passed the decade beginning with 1055 in Worms, where the niche referred to above is still shown. Within this, it is said, Rashi was wont to teach. A small edifice on the east of the synagogue is called the "Rashi Chapel," and the "Rashi Chair," raised on three steps in the niche, is one of the objects of the pious admiration of pilgrims. At Worms Rashi worked under Jacob ben Yaqar, and at Mainz under Isaac ben Judah, perhaps combining at the same time the functions of teacher and student. Besides the oral tuition that he received, the medieval schools habitually kept the notes of former teachers. From these Rashi learned much, and probably he incorporated some of these notes in his own works. In the middle ages there was a communism in learning, but if Rashi used some of the stones quarried and drafted by others, it was to his genius that the finished edifice was due.

Rashi was twenty-five years of age when he returned to Troyes, which town thenceforward eclipsed the cities of Lorraine and became the recognized centre of Jewish learning. Rashi acted as rabbi and judge, but received no salary. Not till the 14th century were Jewish rabbis paid officials. Rashi and his family worked in the vines of Troyes (in the Champagne); in his letters he describes the structure of the wine-presses. His learning and character raised him to a position of high respect among the Jewries of Europe, though Spain and the East were long outside the range of his influence. As was said of him soon after his death: "His lips were the seat of wisdom, and thanks to him the Law, which he examined and interpreted, has come to life again." His posterity included several famous names, those of his grandchildren. Rashi had no sons, but his three daughters were women of culture, and two of the sons of Jochebed (see **RASHBAM** and **TAM**), as well as others of his descendants, carried on the family tradition for learning, adding lustre to Rashi's fame. The latter part of Rashi's life was saddened by the incidents connected with the first Crusade. Massacres occurred in the Rhinelands. According to legend, Rashi and Godfrey of Bouillon—the foremost leaders of the Crusade—were intimate friends. Rashi died peacefully in Troyes in 1105.

Rashi was the most conspicuous medieval representative of the Jewish spirit. A century later Maimonides was to give a new turn to Jewish thought, by the assimilation of Aristotelianism with Mosaism, but Rashi was a traditionalist pure and simple. He was in no sense a philosopher, but he exemplified in his person and in his works the stored up wisdom of the Synagogue. Yet through all that he wrote there runs a vein of originality. Besides minor works, such as a recension of the Prayer-Book (*Siddur*), the *Pardes* and *ha-Orah*, Rashi wrote two great commentaries on which his fame securely rests. These were the commentaries on the whole of the Hebrew Bible and on about thirty treatises of the Talmud. His commentary on the Pentateuch, in particular, has been printed in hundreds of editions; it is still to Jews the most beloved of all commentaries on the Mosaic books. More than a

hundred supercommentaries have been written on it. Rashi unites homily with grammatical exegesis in a manner which explains the charm of the commentary. His influence in Christian circles was great, especially because of the use made of the commentary by Nicolaus de Lyra (*q.v.*), who in his turn was one of the main sources of Luther's version. Even more important was Rashi's commentary on the Talmud, which became so acknowledged as the definitive interpretation that Rashi is cited simply under the epithet of "the Commentator." It is no exaggeration to assert that the modern world owes its power to understand the Talmud to Rashi. In this field the "Commentator" is supreme. He practically edited the text of the Talmud besides explaining it, and the Talmud is never printed without Rashi's commentary on the margin. An important feature of Rashi's commentaries is the frequency of French translations of words. These glosses (*lo'azim*) have now been in part edited from the manuscripts of the late Arsène Darmesteter.

BIBLIOGRAPHY.—M. Liber, *Rashi* (1906), published as a memorial of Rashi on the 800th anniversary of his death. Rashi's commentary on the Bible has been translated into Latin by Breithaupt (1710-1714); and into German (Pentateuch) by Dukes (1833-38) and others. The foundation of recent investigation into Rashi's life is Zunz's *Salomon b. Isaac* (1823), to which I. H. Weiss added much in his (Hebrew) biography (in *Bet Talmud* ii., Nos. 2-10. See also Graetz, *History of the Jews* (Engl. trans., vol. iii. ch. ix.). A critical edition of Rashi's Pentateuch commentary was published by A. Berliner (2nd ed., 1905). (I. A.)

RASHTRAKUTA, an Indian dynasty which ruled in the Deccan (*q.v.*) from about A.D. 750 to 973. The Rashtrakuta or Ratta clan are supposed to have held power during the historical blank before the 6th century; but they came to the front in A.D. 750, when Dantidurga overthrew the Chalukya dynasty and made himself ruler of the Deccan. He was succeeded by his uncle Krishna I. (*c.* 760), who completed his conquests, and whose reign is memorable for the execution of the Kailasa, the rock-cut temple at Ellora. His grandson Govinda III. (780-815) extended the power of the family from the Vindhya Mountains and Malwa on the north to Kanchi on the south. The next king, Amogavarsha, reigned for sixty-two years. The reign of Krishna III. was remarkable for a war with the Cholas, in which the Chola king was killed on the field of battle in 949. The last of the Rashtrakuta kings was Karka II., who was overthrown by the Chalukyas in 973.

See R. G. Bhandarkar, *Early History of the Deccan* (Bombay, 1884).

RASK, RASMUS CHRISTIAN (1787-1832), Danish scholar and philologist, was born at Brändekilde in the island of Fünen or Fyen in Denmark in 1787. He studied at the university of Copenhagen, and at once showed remarkable talent for the acquisition of languages. In 1808 he was appointed assistant keeper of the university library, and some years afterwards professor of literary history. In 1811 he published, in Danish, his *Introduction to the Grammar of the Icelandic and other Ancient Northern Languages*, from printed and MS. materials accumulated by his predecessors in the same field of research. The reputation which Rask thus acquired recommended him to the Arna-Magnaean Institution, by which he was employed as editor of the *Icelandic Lexicon* (1814) of Björn Haldorson, which had long remained in manuscript. Rask visited Iceland, where he remained from 1813 to 1815, mastering the language and familiarizing himself with the literature, manners and customs of the natives. To the interest with which they inspired him may probably be attributed the establishment at Copenhagen, early in 1816, of the Icelandic Literary Society, of which he was the first president.

In October 1816 Rask left Denmark on a literary expedition, at the cost of the king, to prosecute inquiries into the languages of the East, and collect manuscripts for the university library at Copenhagen. He proceeded first to Sweden, where he remained two years, in the course of which he made an excursion into Finland to study the language. Here he published, in Swedish, his *Anglo-Saxon Grammar* in 1817. In 1818 there

appeared at Copenhagen, in Danish, an *Essay on the Origin of the Ancient Scandinavian or Icelandic Tongue*, in which he traced the affinity of that idiom to the other European languages, particularly Latin and Greek. In the same year he brought out the first complete editions of Snorro's *Edda* and Saemund's *Edda*, in the original text, along with Swedish translations of both *Eddas*. From Stockholm he went in 1819 to St Petersburg, where he wrote, in German, a paper on "The Languages and Literature of Norway, Iceland, Sweden and Finland," in the sixth number of the Vienna *Jahrbücher*. From Russia he proceeded through Tartary into Persia, and resided for some time at Tabriz, Teheran, Persepolis and Shiraz. In about six weeks he made himself sufficiently master of Persian to be able to converse freely. In 1820 he embarked at Bushire for Bombay; and during his residence there he wrote, in English, "A Dissertation on the Authenticity of the Zend Language" (*Trans. Lit. Soc. of Bombay*, vol. iii., reprinted with corrections and additions in *Trans. R. As. Soc.*). From Bombay he proceeded through India to Ceylon, where he arrived in 1822, and soon afterwards wrote, in English, "A Dissertation respecting the best Method of expressing the Sounds of the Indian Languages in European Characters," in the *Transactions of the Literary and Agricultural Society of Colombo*. Rask returned to Copenhagen in May 1823, bringing a considerable number of Oriental manuscripts, Persian, Zend, Pali, Sinhalese and others, with which he enriched the collections of the Danish capital. He died at Copenhagen on the 14th of November 1832.

During the period between his return from the East and his death Rask published in his native language a *Spanish Grammar* (1824), a *Frisic Grammar* (1825), an *Essay on Danish Orthography* (1826), a *Treatise respecting the Ancient Egyptian Chronology* and an *Italian Grammar*, (1827), and the *Ancient Jewish Chronology pervious to Moses* (1828). He also edited an edition of Schneider's *Danish Grammar for the use of Englishmen* (1830), and superintended the English translation of his *Anglo-Saxon Grammar* by Thorpe (1830). He was the first to point out the connexion between the ancient Northern and Gothic on the one hand, and the Lithuanian, Slavonic, Greek and Latin on the other, and he also deserves credit for having had the original idea of "Grimm's Law" for the transmutation of consonants in the transition from the old Indo-European languages to Teutonic, although he only compared Teutonic and Greek, Sanskrit being at the time unknown to him. In 1822 he was master of no less than twenty-five languages and dialects, and is stated to have studied twice as many. His numerous philological manuscripts were transferred to the king's library at Copenhagen. Rask's *Anglo-Saxon, Danish and Icelandic Grammars* were brought out in English editions by Thorpe, Repp and Dasent respectively.

RASPBERRY, known botanically as *Rubus Idaeus* (nat. ord. Rosaceae, *q.v.*), a fruit-bush found wild in Great Britain and in woods throughout Europe, North Africa and in north and west Asia. The raspberry was known to classic writers, and is mentioned by Pliny as one of the wild brambles known to the Greeks as *Idea*, from Mt. Ida in Asia Minor on which it grew. Parkinson (*Paradisus*, 1629) speaks of red, white and thornless varieties as suitable for the English climate, and Gerarde (*Herbal*, 1597) figures and describes the Raspis or Framboise bush as one of the four kinds of bramble. It is propagated from suckers, which may be taken off the parent stools in October, and planted in rows 5 or 6 ft. apart, and at 3 ft. asunder in the rows. It is the habit of the plant to throw up from the root every year a number of shoots or canes, which bear fruit in the subsequent year, and then decay. In dressing the plants, which is done immediately after the crop is gathered, all these exhausted stems are cut away, and of the young canes only three or four of the strongest are left, which are shortened about a third. The stems, being too weak to stand by themselves, are sometimes connected together by the points in the form of arches, or a stake is driven in midway between the plants, and half the canes are bent one way and half the other, both being tied to the stake. Sometimes they are tied upright to stakes fixed to each stool. The best support, however, is obtained by fastening the points of the shoots to a slight horizontal rail or bar, placed a foot and a half on the south side of the rows,

by which means the bearing shoots are deflected from the perpendicular to the sunny side of the row, and are not shaded by the annual wood. When this mode of training is adopted, the plan of planting 1 foot apart in the row and leaving one or two canes only to each shoot is preferable. The ground between the rows should never be disturbed by deep digging; but an abundant supply of good manure should be given annually in autumn as a dressing, which should be forked in regularly to a depth of 4 or 5 inches. All surplus suckers should be got away early in the summer before they have robbed the roots—five or six, to be reduced to the four best, being reserved to each root. Fresh plantations of raspberries should be made every six or seven years. The double-bearing varieties, which continue to fruit during autumn, require light soils and warm situations. These should be cut close down in February, as it is the strong young shoots of the current year which bear the late autumnal crops. The other varieties may be made to bear in autumn by cutting the stems half-way down at an early period in spring; but, as with all other fruits, the flavour of the raspberry is best when it is allowed to ripen at its natural season.

The following are some of the finer sorts now in cultivation:—

- Baumforth's Seedling*—a large summer-bearing red.
- Carler's Prolific*—a large summer-bearing red.
- Fastolf or Filby*—a large summer-bearing red.
- M'Laren's Prolific*—a large double-bearing red.
- Northumberland Fillbasket*—a large summer red.
- October Red*—a fine autumn-bearing red.
- October Yellow*—a fine autumn-bearing yellow.
- Prince of Wales*—a large summer-bearing red.
- Red Antwerp*—a large summer-bearing red.
- Rogers's Victoria*—a large autumn-bearing red.
- Round Antwerp*—a large summer-bearing red.
- Semper Fidelis*—an excellent bright red variety; heavy cropper.
- Superlative*—fruits rich red; perhaps the best raspberry in cultivation.
- Sweet Yellow Antwerp*—a large summer-bearing yellow.

The European raspberry, though admittedly of better quality, has been largely displaced in the United States of America by a closely allied native species, *R. strigosus*, the numerous varieties of which are harder than the varieties of the European species and ripen their crop much more rapidly. The stems are more slender and flexible than in *R. Idaeus*, usually brown or reddish-brown in colour and beset with stiff straight prickles. The most important raspberry of cultivation in America is *R. occidentalis*, the black raspberry or thimbleberry, which is at once distinguished by its firm black, rarely yellow, fruit. The purple-cane raspberry, *R. neglectus*, with fruit varying in colour from dull purple to dark red or sometimes yellowish, is perhaps a hybrid between *R. strigosus* and *R. occidentalis*.

For a detailed account of the American species of *Rubus* see F. W. Card, *Bush-fruits* (1898).

The Loganberry is a hybrid between the raspberry (*Rubus Idaeus*) and the blackberry or bramble (*R. fruticosus*), and derives its name from its raiser, Judge Logan of the American Bar. It is a strong-growing plant, partaking more of the habit of the blackberry than the raspberry, and making shoots often 10 to 15 ft. long in the course of the year. These bear leaves with 5 leaflets, and fruit the following year. The fruiting shoots have leaves with only 3 leaflets; but young and old stems are densely covered with sharp crimson prickles. The fruits are borne profusely in loose trusses, and are ripe in southern localities in July, and about early August in northern parts. They are at first reddish like raspberries in a half-ripened state, but when fully ripe are deep purplish red, and much more palatable, each fruit being about 1½ in. long, and shaped like a raspberry.

The Loganberry flourishes in heavy loamy soil, and is a useful plant for old fences or trellises, or even in waste places, where it is fully exposed to the sunshine. The old fruiting shoots should be cut away each winter, and in the spring the young shoots should have a foot or two taken off the ends, to induce the better and riper buds lower down to throw masses of white flowers, to be succeeded in due course by the fruits. Propagation is by means of suckers from the base.

RASPE, RUDOLF ERICH (1737-1794), the original author of the *Adventures of Baron Munchausen* (see MUNCHAUSEN), was born in Hanover in 1737, and studied at Göttingen and Leipzig. In 1762 he became a clerk in the university library at Hanover, and in 1764 secretary to the university library at Göttingen. He had become known as a versatile scholar and a student of natural history and antiquities, and he published some original poems and also translations, among the latter of Leibnitz's philosophical works and of Ossian's poems; he also wrote a treatise on Percy's *Reliques*. In 1767 he was appointed professor in Cassel, and subsequently librarian. He contributed in 1769 a zoological paper to the 50th volume of the *Philosophical Transactions*, which led to his being selected an honorary member of the Royal Society in London, and he wrote voluminously on all sorts of subjects. In 1774 he started a periodical called the *Cassel Spectator*. But having gone to Italy in 1775 to buy curios for the landgrave of Hesse, to whom he was keeper of the gems, he was found to have sold the landgrave's valuables for his own profit; and, on orders being issued for his arrest, he decamped to England. In London he employed his knowledge of English and his learning to secure a living by publishing books on various subjects, and English translations of German works, and there are allusions to him as "a Dutch savant" in 1780 in the writings of Horace Walpole, who gave him money and helped him to publish an *Essay on the Origin of Oil-painting* (1781). But he remained poor, and the Royal Society expunged his name off its list. He went to Cornwall in 1782, and till about 1788 was assay-master and storekeeper at the Dolcoath mine, where memories of his ingenuity remained to the middle of the 19th century. While there, he seems to have written the original version of *Munchausen*, which was subsequently elaborated by others. Between 1785 and 1790 he compiled a descriptive catalogue of James Tassie's collection of pastes and casts of gems, in two quarto volumes (1791) of laborious industry and bibliographical rarity. Raspe then went to Scotland, and in Caithness found a patron in Sir John Sinclair of Ulbster, whose mineralogical proclivities he proceeded to impose upon by pretending to discover valuable and workable veins on his estates; but Raspe had "salted" the ground himself, and on the verge of exposure he absconded. He next betook himself to Ireland, but died at Muckross in 1794, when he was only beginning some mining operations in Donegal. His career is interesting because of his connexion with the famous book of stories of Baron Munchausen (*q.v.*). His authorship was not known in his lifetime, except to his friend Gottfried August Bürger and possibly a few of his other intimates (such as Kästner and Lichtenburg) in his student days at Göttingen; and it was not till 1824 that the biographer of Bürger (who had been credited with writing *Munchausen* instead of only translating it, as he did in 1786) revealed the truth about the book.

RASSAM, HORMUZD (1826-1910), Assyriologist and traveller, was born at Mosul of native Christian parents. His first work was done as assistant to Sir A. H. Layard in his first expedition (1845-47). He subsequently came to England, studied at Oxford, and was again sent by the British Museum trustees to accompany Layard in his second expedition (1849-51). Layard having entered upon a political career, Rassam continued the work (1852-54) in Assyria under the direction of the British Museum and Sir Henry Rawlinson at Nimrud and Kuyunjik. In 1866 he was sent by the British government to Abyssinia, where, however, he was imprisoned for two years until freed by the victory of Sir Robert Napier. From 1876 to 1882 he was again in Assyria conducting important investigations, especially at Nineveh, and during the Russo-Turkish War he was sent on a mission of inquiry to report on the condition of the Christian communities of Asia Minor and Armenia. His archaeological work resulted in many important discoveries and the collection of valuable epigraphical evidence.

See *The Times*, Sept. 17, 1910.

RASTATT, a town of Germany, in the grand duchy of Baden, on the Murg, 4 m. above its junction with the Rhine and 15 m.

by rail S.W. of Karlsruhe. Pop. (1905) 14,404. The old palace of the margraves of Baden, a large Renaissance edifice in red sandstone, is now partly used for military purposes and contains a collection of pictures, antiquities and trophies from the Turkish wars. The chief manufactures are stoves, beer and tobacco. Until the end of the 17th century Rastatt was unimportant, but after its destruction by the French in 1689 it was rebuilt on a larger scale by Louis William, margrave of Baden, the imperial general in the Turkish wars. It was then the residence of the margraves until 1771. The Baden revolution of 1849 began with a mutiny of soldiers at Rastatt in May 1849, and ended here a few weeks later with the capture of the town by the Prussians. For some years Rastatt was one of the strongest fortresses of the German empire, but its fortifications were dismantled in 1890.

See Schuster, *Rastatt, die ehemalige badische Residenz und Bundesfestung* (Lahr, 1902); and Lederle, *Rastatt und seine Umgebung* (Rastatt, 1905).

Rastatt has been the scene of two congresses. At the first congress, which was opened in November 1713, negotiations were carried on between France and Austria for the purpose of ending the war of the Spanish succession. These culminated in the treaty of Rastatt signed on the 7th of March 1714. The second congress, which was opened in December 1797, was intended to rearrange the map of Germany by providing compensation for those princes whose lands on the left bank of the Rhine had been seized by France. It had no result, however, as it was ended by the outbreak of the European war, but it had a sequel of some interest. As the three French representatives were leaving the town in April 1799 they were waylaid, and two of them were assassinated by some Hungarian soldiers. The origin of this outrage remains shrouded in mystery, but the balance of evidence seems to show that the Austrian authorities had commanded their men to seize the papers of the French plenipotentiaries in order to avoid damaging disclosures about Austria's designs on Bavaria, and that the soldiers had exceeded their instructions. On the other hand, some authorities think that the deed was the work of French emigrants, or of the party in France in favour of war.

For fuller particulars of the two sides of this controversy see K. Mendelssohn-Bartholdy, *Der Rastatter Gesandtenmord* (Heidelberg, 1869); J. A. Freiherr von Helfert, *Der Rastatter Gesandtenmord* (Vienna, 1874); Böhlingk, *Napoleon und der Rastatter Gesandtenmord* (Leipzig, 1883); and *Zum Rastatter Gesandtenmord* (Heidelberg, 1895); H. Hüffer, *Der Rastatter Gesandtenmord* (Bonn, 1896); and H. von Sybel, in Band 39 of the *Historische Zeitschrift*.

RASTELL (or RASTALL), **JOHN** (d. 1536), English printer and author, was born in London towards the end of the 15th century. He is vaguely reported by Anthony à Wood to have been "educated for a time in grammaticals and philosophicals" at Oxford. He became a member of Lincoln's Inn, and practised successfully as a barrister. He was also M.P. for Dunheved, Cornwall, from 1529 to the time of his death. He began his printing business some time before 1516, for in his preface to the undated *Liber Assisarum* he announced the forthcoming publication of Sir A. Fitzherbert's *Abbreuiamentum librorum legum Anglorum*, dated 1516. Among the works issued from the "sygne of the meremayd at Powlysgate," where he lived and worked from 1520 onwards, are *The Mery Gestys of the Wydow Edyth* (1525), and *A Dyaloge of Syr Thomas More* (1529). The last of his dated publications was *Fabyll's Ghoste* (1533), a poem. In 1530 he wrote, in defence of the Roman doctrine of Purgatory, *A New Boke of Purgatory* (1530), dialogues on the subject between "Comyngs and Almayn a Christen man, and one Gyngemyn a Turke." This was answered by John Frith in *A Disputacion of Purgatorie*. Rastell replied with an *Apology against John Fryth*, also answered by the latter. Rastell had married Elizabeth, sister of Sir Thomas More, with whose Catholic theology and political views he was in sympathy. More had begun the controversy with John Frith, and Rastell joined him in attacking the Protestant writer, who, says Foxe (*Actes and Monuments*, ed. G. Townsend, vol. v. p. 9), did so "overthrow and confound" his adversaries

that he converted Rastell to his side. Separated from his Catholic friends, Rastell does not seem to have been fully trusted by the opposite party, for in a letter to Cromwell, written probably in 1536, he says that he had spent his time in upholding the king's cause and opposing the pope, with the result that he had lost both his printing business and his legal practice, and was reduced to poverty. He was imprisoned in 1536, perhaps because he had written against the payment of tithes. He probably died in prison, and his will, of which Henry VIII. had originally been appointed an executor, was proved on the 18th of July 1536. He left two sons: William, noticed below, and John. The Jesuit, John Rastell (1532-1577), who has been frequently confounded with him, was no relation.

Rastell's best-known work is *The Pastyme of People, the Chronycles of dyvers Realmys and most specially of the Realme of England* (1529), a chronicle dealing with English history from the earliest times to the reign of Richard III., edited by T. F. Dibdin in 1811. His *Expositiones terminorum legum Angliae* (in French, translated into English, 1527; reprinted 1629, 1636, 1641, &c., as *Les Termes de la Ley*), and *The Abbreuiacion of Statutis* (1519), of which fifteen editions appeared before 1625, are the best known of his legal works.

Rastell was also the author of a morality play, *A new Interlude and a Mery of the 1111 Elements*, written about 1519, which is no doubt the "large and ingenious comedy" attributed to him by Wood. The unique copy in the British Museum is incomplete, and contains neither the date nor the name of the author, identified with John Rastell on the authority of Bale, who catalogues *Natura Naturata* among his works, adding a Latin version of the first line of the piece. This interlude was printed in W. C. Hazlitt's edition of Dodsley's *Old English Plays*, by J. O. Halliwell-Phillips for the Percy Soc. (*Early English Poetry*, vol. 22, 1848), and by Julius Fischer (*Marburger Studien zur englischen Philologie*, vol. v., 1903). See also an article on "John Rastell and his Contemporaries" in *Bibliographica*, vol. 11, 437 seq., by Mr. H. R. Plomer, who unearthed in the Record Office an account of a law-suit (1534-35) in connexion with Rastell's premises at the "Mermaid." For the books issued from his press see a catalogue by R. Proctor, in *Hand-Lists of English Printers* (Bibliographical Soc., 1896).

RASTELL, WILLIAM (c. 1508-1565), English printer and judge, son of the preceding, was born in London about 1508. At the age of seventeen he went to the university of Oxford, but did not take a degree, being probably called home to superintend his father's business. The first work which bears his own imprint was *A Dyaloge of Sir Thomas More* (1531), a reprint of the edition published by his father in 1529. He also brought out a few law-books, some poetry, an edition of *Fabyan's Cronycle* (1533), and *The Apologye* (1533) and *The Supplycacyon of Soulys* of his uncle Sir Thomas More. His office was "in Fletestrete in saynt Brydys chyrche yarde." He became a student at Lincoln's Inn on 12th September 1532, and gave up the printing business two years later. In 1547 he was appointed reader. On account of his Catholic convictions he left England for Louvain; but upon the accession of Mary he returned, and was made serjeant-at-law and treasurer of Lincoln's Inn in 1555. His patent as judge of the Queen's Bench was granted on the 27th of October 1558. Rastell continued on the bench until 1562, when he retired to Louvain without the queen's licence. By virtue of a special commission issued by the barons of the Exchequer on the occasion an inventory of his goods and chattels was taken. It furnishes an excellent idea of the modest nature of the law library (consisting of twenty-four works) and of the chambers of an Elizabethan judge (see *Law Magazine*, February 1844). He died at Louvain on the 27th of August 1565.

It is difficult to distinguish between the books written by him and those by his father. The following are believed to be his: *A Collecion of all the Statutes* (1559), *A Table collected of the Yeares of the Kynges of Englande* (1561), both frequently reprinted with continuations, and *A Collecion of Entrees, of Declarations, &c.* (1566), also frequently reprinted. The entries are not of Rastell's own drawing, but have been selected from printed and MS. collections; their "pointed brevity and precision" are commended by Story. He supplied tables or indexes to several law-books, and edited *La novel natura breuium de Monsieur Anton. Fitzherbert* (1534) and *The Workes of Sir T. More in the English Tongue* (1557). He is also stated to have written a life of Sir T. More, but it has not come down to us.

RASTENBURG, a town of Germany, in the province of East Prussia, lying in a flat sandy plain on the Guber, 64 m. S.E. of Königsberg by the railway to Prostken. Pop. (1905) 11,889. Its principal manufactures are flour, sugar, oil, beer and machinery. In the vicinity is Karlshof, a celebrated establishment for the cure of epileptic diseases.

See Beckherrn, *Mitteilungen aus Rastenburgs Vergangenheit* (Rastenburg, 1891); and Schaffer, *Chronik von Rastenburg* (Rastenburg, 1889).

RAT (a word common to Teut. and Rom. languages; probably first adopted in Teut.; the ultimate origin is not known; Skeat suggests the root *rad-*, to scratch; cf. Ger. *Ratte*, Dan. *rotte*, Fr. *rat*, &c.), probably in its original sense the designation of the British rodent mammal commonly known as the black rat (*Mus rattus*), but also applied indifferently to the brown or Norway rat (*M. norvegicus*), and in a still wider sense to all the larger representatives of the genus *Mus*, as to many other members of the family Muridae. In fact, as mentioned in the article **MOUSE**, there is no possibility of defining the term "rat" when used in a sense other than as relating to the two species above mentioned; while there is also no hard-and-fast limit between the terms "rats" and "mice" when these are likewise employed in their now extended sense, "rats" being merely larger "mice," and vice versa. Rats have, however, generally more rows of scales

on the tail (reaching to 210 or more) than mice, in which the number does not exceed 180. For the distinctive characteristics of the family Muridae and the genus *Mus*, to which true rats and true mice alike belong, see **RODENTIA**. Of the two British species the brown, or Norway rat (*M. norvegicus*) is distinguished by its large size, brownish grey colour, short tail and ears, stout skull, and the



Black Rat (*Mus rattus*).



Brown Rat (*M. norvegicus*).

possession of from 10 to 12 teats. It is fierce and cunning, and easily overcomes all allied species with which it is brought in contact. Its original home would seem to have been some part of Central Asia, an indigenous species from China, *M. humilatus*, being so like it that in all probability the latter is the original race from which it has sprung. Thence it has spread to all parts of the world, driving out the house-haunting species everywhere, as it has in England all but exterminated the black rat. The brown rat migrated westwards from Central Asia early in the 18th century, and is believed to have first reached Great Britain about 1730. Its already evil reputation has been increased of late years by the fact that it is one of the chief disseminators of bubonic plague. Black phases are not uncommon. The black rat (*M. rattus*) is distinguishable from the brown rat by its smaller size, longer ears and tail, and glossy black colour. It shares the roving habits of the latter, frequenting ships and by these means reaching various parts of the world. On this account either the typical form or the tropical *M. rattus alexandrinus* is common in many places to which the brown species has not yet penetrated, for instance in South America. This long-tailed rat, originally a native of India, would seem to have first penetrated to all parts of the world and to have nearly or quite exterminated the indigenous rats. After this followed the advance of the more powerful brown rat. The black rat first reached Europe in the 13th century; but of late years another and still darker phase of the species, the Black Sea black rat (*M. rattus ater*) made its appearance in

England. The Isle of Dogs and Yarmouth, in Norfolk, are reported to be the chief of the English strongholds of the black rat. Both species agree in their predaceous habits, omnivorous diet and great fecundity. They bear, four or five times in the year, from four to ten blind and naked young, which are in their turn able to breed at an age of about six months; the time of gestation being about twenty days.

See J. G. Millais, "The True Position of *Mus rattus* and its Allies," *Zoologist*, June 1905. (R. L.)*

RATAFIA, a liqueur or cordial flavoured with peach or cherry kernels, bitter almonds, or other fruits; many different varieties are made. The same name is given to a flavouring essence resembling bitter almonds, and also to a light biscuit. The word is adapted from the French of the 17th century. Skeat (*Elym. Dict.*, 1910) quotes as a possible origin a combination of Malay *araq*, arrack, and *tafia*, rum.

RATE, a general term for proportion, standard, allowance, tax (Med. Lat. *rata*, from *pro rata parte*, *ratus* being the participle of *veri*, to think, judge). In England the term is specially applied to the levying of public money contributions for local purposes, as distinguished from the "taxes" raised for what are treated as general state purposes. The money required for local administration in England is raised (when the ordinary revenues are insufficient) by assessments on lands and buildings based on their annual rental value. The financial authority estimates what additional amount beyond revenue is required for the expenses of administration, and levies a rate to meet it. The earliest rate levied in England was that for poor relief, and of the great variety of rates now existing, the majority are based on the poor rate and levied with it, under the term of precept rates. Next to the poor rate came that for highways, and other special rates have been authorized from time to time, as for police, education, public lighting, cemeteries, libraries, sanitary purposes, &c. To distinguish the rate the name of the precepting authority is frequently added or the purpose for which it is levied specified, as county rate, watch rate, &c. The valuation list of a parish is the basis on which the poor rate is levied. This valuation list contains the gross estimated rental and rateable value of all rateable property in the parish. The gross estimated rental is the rent at which a property might reasonably be expected to let from year to year, the tenant paying tithes, rates and taxes. From this is deducted the average annual cost of repairs, insurance and renewals, the balance constituting the rateable value. The rateable value of the parish being known, so much on each pound of the rateable value as will equal the amount required to be raised is levied, and is known as the "rate." See further **ENGLAND**, *Local Government*; **TAXATION**.

Rating, in maritime vocabulary, is the classification of men according to rank, and was formerly employed to class ships of a navy according to strength. A sailor is said to be "rated A.B.," or in the navy "rated petty officer," "seaman," "gunner," and so on. The rating of ships began in the 17th century, and was at first done roughly by size and number of crew. Later the rating was by guns. Thus in 1741 in the British navy there were six rates: 1st. 100 guns; 2nd, 90; 3rd, 70 to 80; 4th, 50 to 60; 5th, 40; and 6th, 20. Sloops, fire-ships, bomb-vessels and royal yachts were said to be not rated. The classification of ships into six rates, and into rated and non-rated ships, continued during the existence of the old sailing fleets, with modifications in detail. The practice of other navies was similar to the British.

RATEL, or HONEY-BADGER, the name of certain Indian and African small clumsy-looking creatures of about the size and appearance of badgers, representing the genus *Mellivora* in the family Mustelidae (see **CARNIVORA**). Two species of ratel are commonly recognized, the Indian (*M. indica*), and the African (*M. ratel*), which ranges over Africa, but a black ratel from the Ituri forest has been separated as *M. cottoni*. Both the two former are iron-grey on the upper parts, and black below, a style of coloration rare among mammals, as the upper side of the body is in the great majority darker than the lower.

The body is stout and thickly built; the legs are short and strong, and armed, especially the anterior pair, with long curved claws; the tail is short; and the ears are reduced to rudiments. The skull is conical, stout and heavy, and the teeth, although sharper and less rounded than those of badgers, are less suited to a carnivorous diet than those of stoats, weasels and martens. The two ratels may be distinguished by the fact that the African species has a distinct white line round the body at the junction of the grey of the upper side with the black of the lower, while in the Indian this line is absent; the teeth also of the former are larger, rounder and heavier than those of the latter. The two are, however, so nearly allied that they might almost be considered geographical races of a single species. Dr T. C. Jerdon states that the Indian ratel is found throughout the



The African Ratel (*Mellivora ratel*).

whole of India, from the extreme south to the foot of the Himalaya, chiefly in hilly districts, where it has greater facilities for constructing the holes and dens in which it lives; but also in the north of India in alluvial plains, where the banks of large rivers afford equally suitable localities wherein to make its lair. It is stated to live usually in pairs, and to eat rats, birds, frogs, white ants and various insects, and in the north of India it is accused of digging out dead bodies, and several of the native names mean "grave-digger." Dr W. T. Blanford, in the *Fauna of British India*, is of opinion that the reproach is without foundation. Like its Cape congener it occasionally partakes of honey, and is often destructive to poultry. In confinement the Indian ratel becomes tame and even playful, displaying a habit of tumbling head over heels. (R. L.*)

RATH, GERHARD VOM (1830–1888), German mineralogist, was born at Dinsburg in Prussia, on the 20th of August 1830. He was educated at Cologne, at Bonn University, and finally at Berlin, where he graduated Ph.D. in 1853. In 1856 he became assistant to Nöggerath in the mineralogical museum at Bonn, and succeeded to the directorship in 1872. Meanwhile in 1863 he was appointed extraordinary professor of geology, and in 1872 he became professor of geology and mineralogy in the university at Bonn. He was distinguished for his accurate researches on mineralogy and crystallography; he described a great many new minerals, some of which were discovered by him, and he contributed largely to our knowledge of other minerals, notably in an essay on tridymite. He travelled much in southern Europe, Palestine and the United States, and wrote several essays on petrology, geology and physical geography, on earthquakes and on meteorites. He died at Coblenz on the 23rd of April 1888.

His separate publications included *Ein Ausflug nach Kalabrien* (1871); *Der Monzoni im südöstlichen Tirol* (1875); and *Durch*

Italien und Griechenland nach dem Heiligen Land (2 vols., 1882). See Obituary with bibliography by Professor H. Laspeyres, in *Sitzungsbericht des nat. Vereins der preussischen Rheinlande* (1888).

RATHENOW, a town of Germany, in the Prussian province of Brandenburg, on the Havel, 45 m. N.W. of Berlin on the main railway to Hanover. Pop. (1905) 23,095, including the garrison. The Protestant church of St Mary and St Andrew, originally a basilica, and transformed to the Gothic style in 1517–1589, and the Roman Catholic church of St George, are noteworthy. Rathenow is known for its "Rathenow stones," bricks made of the clay of the Havel, and for its spectacles and optical instruments, which are exported.

Rathenow received its incorporation as a town in 1295. In 1394 it was taken and partly destroyed by the archbishop of Magdeburg. It suffered much from the ravages of the Thirty Years' War, being occupied in turn by the Saxons and the Swedes, from whom in 1675 it was taken by the Brandenburgers, when most of the garrison were put to the sword.

See Wagener, *Denkwürdigkeiten der Stadt Rathenow* (Berlin, 1903).

RATIBOR (Polish *Raciborz*), a town of Germany, in the Prussian province of Silesia, pleasantly situated on the left bank of the Oder at the point where the river becomes navigable, 13 m. from the Austrian frontier and 97 m. by rail S.E. of Breslau, on the main line to Oderberg. Pop. (1905) 32,690. The most prominent buildings are the handsome law-courts by Schinkel and the imposing château of the dukes of Ratibor, which occupies a commanding position on the right bank of the Oder. The town is the seat of various industries, the chief products of which are machinery, railway gear, iron wares, tobacco, cigars, paper, sugar, furniture and glass. Trade is carried on in these and in coal, wood and agricultural produce, while hemp and vegetables are largely grown in the environs.

Ratibor, which received municipal privileges in 1217, was formerly the capital of an independent duchy, 380 sq. m. in extent, which existed from 1288 to 1532, and afterwards passed successively into the hands of Austria and Prussia. In 1821 a small mediate principality was formed out of the old lordship of Ratibor and certain ecclesiastical domains, and was conferred upon Victor Amadeus, landgrave of Hesse-Rotenburg, as compensation for some Hessian territory absorbed by Prussia. The title of duke of Ratibor was revived in 1840 for his heir, Prince Victor of Hohenlohe-Schillingsfürst (1818–1893).

See A. Weltzel, *Geschichte der Stadt und Herrschaft Ratibor* (2nd ed., Ratibor, 1881).

RATIONALISM (from Lat. *rationalis*, pertaining to reason, *ratio*), a term employed both in philosophy and in theology for any system which sets up human reason as the final criterion and chief source of knowledge. Such systems are opposed to all doctrines which rest solely or ultimately upon external authority; the individual must investigate everything for himself and abandon any position the validity of which cannot be rationally demonstrated. The rationalist spirit is, of course, coeval with human evolution; religion itself began with a rational attempt to maintain amicable relations with unknown powers, and each one of the dead religions succumbed before the development of rationalist inquiry into its premises. But the term has acquired more special connotations in modern thought. In its commonest use it is applied to all who decline to accept the authority of the Bible as the infallible record of a divine revelation, and is practically synonymous with free-thinking. This type of rationalism is based largely upon the results of modern historical and archaeological investigation. The story of the Creation in the book of Genesis is shown, from the point of view of chronology, to be a poetic or symbolic account by the discovery of civilizations of much greater antiquity. Again, the study of comparative religion (*e. g.* the study of the Deluge (*q.v.*), showing as it does that similar stories are to be found in primitive literature, both oriental and other) has placed the Bible in close relation with other ancient literature. The Bible, especially the Old Testament, is thus regarded even by orthodox Christians from a rationalist standpoint,

very different from that of the early and medieval Church. Rationalism within the Christian Church differs, however, from that which is commonly understood by the term, inasmuch as it accepts as revealed the fundamental facts of its creed. Thoroughgoing rationalism, on the other hand, either categorically denies that the supernatural or the infinite—whether it exist or not—can be the object of human knowledge (see AGNOSTICISM), or else, in the mouth of a single person, states that he at least has no such knowledge. In addition to the difficulties presented by the Bible as an historical record, and the literary problems which textual and other critics have investigated, the modern freethinker denies that the Christianity of the New Testament or its interpretation by modern theologians affords a coherent theory of human life and duty. Apart from the general use of the term for a particular attitude towards religion, two more technical uses require notice: (i) the purely philosophical, (ii) the theological.

(i) Philosophical rationalism is that theory of knowledge which maintains that reason is in and by itself a source of knowledge, and that knowledge so derived has superior authority over knowledge acquired through sensation. This view is opposed to the various systems which regard the mind as a *tabula rasa* (blank tablet) in which the outside world as it were imprints itself through the senses. The opposition between rationalism and sensationalism is, however, rarely so simple and direct, inasmuch as many thinkers (e.g. Locke) have admitted both sensation and reflection. Such philosophies are called rationalist or sensationalist according as they lay emphasis specially on the function of reason or that of the senses. More generally, philosophic rationalism is opposed to empirical theories of knowledge, inasmuch as it regards all true knowledge as deriving deductively from fundamental elementary concepts. This attitude may be studied in Descartes, Leibnitz and Wolff. It is based on Descartes' fundamental principle that knowledge must be clear, and seeks to give to philosophy the certainty and demonstrative character of mathematics, from the a priori principle of which all its claims are derived. The attack made by David Hume on the causal relation led directly to the new rationalism of Kant, who argued that it was wrong to regard thought as mere analysis. A priori concepts there are, but if they are to lead to the amplification of knowledge, they must be brought into relation with empirical data.

(ii) The term "rationalism" in the narrow theological sense is specially used of the doctrines held by a school of German theologians and Biblical scholars which was prominent roughly between 1740 and 1836. This rationalism within the Church was a theological manifestation of the intellectual movement known as the Enlightenment (*Aufklärung*), and must be studied in close connexion with the purely philosophical rationalism already discussed. It owed much to the English deists, to the Pietistic movement, and to the French *esprits forts* who had already made a vigorous attack on the supernatural origin of the Scriptures. The crux of the difficulty was the doctrine of the supernatural, the relation between revealed and natural religion. The first great rationalist leader was J. S. Semler (q.v.), who held that true religion springs from the individual soul, and attacked the authority of the Bible in a comprehensive spirit of criticism. He ultimately reached a point at which the Bible became for him simply one of many ancient documents. At the same time he did not impugn the authority of the Church, which he regarded as useful in maintaining external unity. Among those who followed in Semler's path were Gruner, Ernesti, J. D. Michaelis, Griesbach, J. G. Eichhorn. This spirit was exhibited on the philosophical side by Kant who in his *Die Religion innerhalb der Grenzen der blossen Vernunft* (1793) set forth his doctrine of rational morality (*Vernunftglauben*) as the only true religion. These two great rationalist movements, the critical and the philosophical, ultimately led to, or were accompanied by, the gradual reduction of religion to a system of morals based at the most on two or three fundamental religious principles. This is the

rationalism known as *rationalismus vulgaris*, the period of which is practically from 1800 to 1833. Among its exponents were Wegscheider, Bretschneider and H. E. G. Paulus (q.v.). The general attitude of German theology, however, became gradually more and more hostile, and the works of Schleiermacher, though in a sense themselves rationalist, renewed the general desire for a positive Christianity. Hase's *Hutterus Redivivus*, an exposition of orthodoxy in the light of modern development, called forth a final exposition of the rationalist position by Röhr. From that time the school as such ceased to have a real existence, though the results of its work are traceable more or less in all modern Biblical criticism, and its influence upon the attitude of modern theologians and Biblical critics can scarcely be overestimated.

See Ständlin, *Geschichte des Rationalismus* (Göttingen, 1826); Hase, *Theologische Streitschriften in Gesammelte Werke*, viii. (1892); Rückert, *Der Rationalismus* (1859); Tholuck, *Vorgeschichte des Rat.* (1853-1861) and *Geschichte des Rat.* (1865); Ritschl, *Christ. Lehre von der Rechtfertigung*, &c. (1870), vol. i.; Bann, *History of Rationalism* (1906). See also histories of philosophy and theology in the 19th century, and the valuable article *s.v.* by O. Kirn in Herzog-Hauck, *Realencyk.* xvi. (1905).

RATISBONNE, LOUIS GUSTAVE FORTUNÉ (1827-1900), French man of letters, was born at Strassburg on the 29th of July 1827. He studied at the school of his native town and at the Collège Henry IV. in Paris. He was connected with the *Journal des Débats* from 1853 to 1876; became librarian of the palace of Fontainebleau in 1871, and three years later to the Senate. Louis Ratisbonne's most important work was a verse translation of the *Divina Commedia*, in which the original is rendered tercet by tercet into French. *L'Enfer* (1852) was crowned by the Academy; *Le Purgatoire* (1857) and *Le Paradis* (1859) received the *prix Bordin*. He is also the author of some charming fables and verses for children: *La Comédie enfantine* (1860), *Les Figures jeunes* (1865) and others. He was literary executor of Alfred de Vigny, whose *Destinées* (1864) and *Journal d'un poète* (1867) he published. Ratisbonne died in Paris on the 24th of September 1900.

RATITAE (from Lat. *ratis*, a raft), the name given by B. Merrem (*Abh. Ak. Wiss.*, Berlin, 1812-1813; *Phys. Kl.*, p. 259) to the "flat-breasted birds," in opposition to the Carinatae, or those which normally possess a keeled sternum. In thus dividing the birds into two great equivalent groups, he was followed only by C. L. Nitzsch (1829), T. H. Huxley (1867), P. L. Selater (1880), A. Newton (1884), R. B. Sharpe (1891), whilst in most of the other numerous classifications the Ratitae (vicariously named Struthiones, Cursorae, Brevipennes, Proceres) were treated as of much lower rank.

A diagnosis covering all the Ratitae (*struthio, rhea, casuarius, dromaeus, apteryx* and the allied fossils *dinornis* and *acpyornis*) would be as follows—(i) terrestrial birds without keel to the sternum, absolutely flightless; (ii) quadrate bone with a single proximal articulating knob; (iii) coracoid and scapula fused together and forming an open angle; (iv) normally without a pygostyle; (v) with an incised ischiadica; (vi) rhamphotheca compound; (vii) without apteria or bare spaces in the plumage; (viii) with a complete copulatory organ, moved by skeletal muscles.

The separation of the Ratitae from the other birds, and their seemingly fundamental differences, notably the absence of the keel and of the power of flight, induced certain authors to go so far as to derive the Ratitae from the Dinosaurian reptiles, whilst *Archaeopteryx* (q.v.) and the Carinatae were supposed to have sprung from some Pterosaurian or similar reptilian stock. Such vagaries require no refutation. But it is quite another question, whether the "Ratitae" form a natural group. Sir R. Owen was the first (*Comp. Anat. and Physiol. of Vertebrates*, ii. 1866) to indicate that the various Ratitae might be referable to various natural groups of the Carinatae. A. W. Forbes likewise had doubts about them. B. Lindsay (*P. Z. S.*, 1885, pp. 684-716, pls. lii.-lv.) found vestiges of a keel in a young rhea, and apteria in the embryonic ostrich, and she concluded that they were descendants of birds which originally possessed

the power of flight. This has been settled by M. Fürbringer (*Untersuchungen* . . . 1888), and there is now no doubt that the absence of the power of flight is a secondary, not primitive, feature in the Ratitae as well as in the flightless *bona fide* Carinatae, e.g. *Didus*, and penguins. It had already been understood that the various genera of the Ratitae were the representatives of so many different groups, each of which was at least equivalent to ordinal rank, and that therefore, if the Ratitae were still to be considered a natural group, this common ancestry must be referred to a remote geological epoch. Fürbringer, however, separated *Apteryx* with *Dinornis* from the rest, combining his "Apteryges" with Crypturi and Galli as Alectorornithes, the latter being practically A. H. Garrod's Galliformes, of which his "Struthionnes" form part together with the Tinamidae or Crypturi. Relationship of this otherwise typically carinate, neotropical family with the Ratitae had already been insisted upon by T. H. Huxley; hence his term Dromaeognathae for the Crypturi. L. Stejneger (*Standard Nat. Hist.*, iv., Boston, 1885) applied this term in a new wider sense to all the Ratitae, and recently W. P. Pycraft has revived this notion by his division of the Neornithes into Dromaeo- and Neognathae. At any rate we begin to see that some of the Ratitae, namely the Rheidae, may possibly be an early and then much modified offshoot of such of the Carinatae as are now represented by the Crypturi, whilst in another part of the world, and at a much later time, kiwis and moas have sprung from a somewhat more Galliform stock, which points to a descent from a still undivided Galliform-Tinamiform mass. Further, it is the opinion of competent ornithologists that there is affinity of the Australian emeus and cassowaries with the New Zealand moas and with the Malagasy *Aepyornis*. *Struthio* alone still stands aloof, possibly because it is the oldest and most specialized form. This genus was already typically developed in late Miocene times, and with a very wide geographical distribution (see BIRD, *Fossil*), but of the affinities of the other mid- and early tertiary flightless birds we know nothing, and it must be emphasized that we should probably not be able to classify a truly ancestral Ratite, namely, a bird which is still to a certain extent carinate and not yet ratite. It is impossible to give a satisfactory diagnosis of such intermediate forms.

All the recent Ratitae still possess a considerable number of rather primitive characters, e.g. they are typically nidifugous; the simple structure of their neossoptiles; quintocubital; compound rhamphotheca; holorhinal nares imperviae; basipterygoid processes; simple articular facet of the quadrate; configuration of the palatal bones, including the large vomer; incisura ischiadica; simple hypotarsus; the thigh muscles; the copulatory organ.

We restrict the origin of the Ratitae to that great branch of still primitive Carinatae which, after separation of the Ratitae, has further developed into the legion of the Alectoromorphae, notably Tinami- and Galliformes, together with still low Gruiformes (see BIRD, *Classification*). From such a *rudis indigestaque moles*, after it had attained an almost world-wide distribution, have arisen the various Ratitae, independently at various epochs and in various countries. Most of them are now restricted to widely separated countries of the southern hemisphere. Although loss of flight (correlated with more or less reduction of the wings and the sternal keel, and often compensated by stronger hind limbs) has occurred, and is still taking place in various groups of birds, it is quite impossible that a new Ratite can still come into existence, because the necessary primitive substratum, whence arose the true Ratitae, is no longer available. Consequently we are justified in retaining "Ratitae" in our classification, although they are a heterogeneous, not strictly monophyletic, assembly. (H. F. G.)

RATKE (RATCHIUS), WOLFGANG (1571-1635), German educationist, was born at Wilster, Holstein, on the 18th of October 1571, and educated at the university of Rostock. His system of education was based upon Bacon's philosophy, the principle being that of "proceeding from things to names,"

from the particular to the general, and from the mother tongue to foreign languages. In 1618 he opened schools at Augsburg and elsewhere, but at Köthen difficulties with the clergy led to his imprisonment for eight months, and after starting another school at Magdeburg in 1620 which failed, he became a wanderer and died at Erfurt on the 27th of April 1635. His ideas were far in advance of his time, but he lacked executive ability.

RATLAM (or RUTLAM), a native state of central India, in the Malwa agency. Area, 902 sq. m. Its territory is closely interlaced with that of Sailana. It is held as tributary to Sindhia; but in 1819 an arrangement was made by which Sindhia engaged never to send any troops into the country or to interfere with the internal administration, and in 1861 the tribute was assigned to the British government in part payment of the Gwalior contingent. The population in 1901 was 83,773, showing a decrease of 6% in the decade; estimated revenue, £34,000; tribute, £2850. The chief, whose title is raja, is a Rahtor Rajput of the Jodhpur family. The chief Sujjan Singh succeeded in 1893, and attained full powers in 1898. The town of Ratlam is 1577 ft. above sea-level. Pop. (1901) 36,321. It is a junction on the Rajputana-Malwa railway, and an important centre of trade, especially in opium.

RATNAGIRI, a town and district of British India, in the southern division of Bombay. The town is on the seacoast, 136 m. S. of Bombay. Pop. (1901) 16,094. A leading industry is the sardine fishery, which usually takes place in January and February, and engages fleets of canoes.

The DISTRICT OF RATNAGIRI has an area of 3998 sq. m. It forms a strip between the western Ghats and the sea, and its general character is rugged; nearly all the fertile land lies on the banks of the streams which intersect the country. The coast, about 150 m. in length, is almost uniformly rocky and dangerous. At intervals of about 10 m. a river or bay opens, sufficiently large to form a secure harbour for native craft, and the promontories at the river mouths are almost invariably crowned with the ruins of an old fort. The rivers and creeks are generally navigable for about 20 m., and afford facilities for a coasting trade. At the beginning of British rule there were no roads, and traffic was confined to places where there was water carriage; but a network of roads has been made, opening communication by hill passes with the Deccan. Ratnagiri formed part of the dominions of the peshwa, and was annexed by the British government in 1818 on the overthrow of Baji Rao. In 1901 the population was 1,167,927, showing an increase of 6% in the decade. Ratnagiri is the home of the influential class of Chitpavan Brahmans. It also supplies factory hands to Bombay and sepoy to the native army.

RATNAPURA (i.e. "The City of Gems"), the chief town in the province of Sabaragamuwa, Ceylon. It is the centre of a long established industry in digging for precious stones—rubies, sapphires, cat's-eyes, &c. There is also much rice and fruit cultivation and planting of tea in the district. Pop. of town (1901) 4084; of district 132,964.

RATON, a city and the county seat of Colfax county, New Mexico, U.S.A., in the N.E. part of the state, and about 193 m. by rail N.E. of Santa Fé. Pop. (1890) 1255; (1900) 3540 (337 foreign-born); (1910 census) 4539. Raton is served by the Atchison, Topeka & Santa Fé, the Saint Louis, Rocky Mountain & Pacific, and the Santa Fé, Raton & Eastern railways. The city lies immediately W. of the Raton Mountains, from which it derives its name, and has an elevation of 6400-6650 ft. above the sea. Among its institutions are a miners' hospital, maintained by the state, and a picturesque public park. The city lies within the Raton coal field, a southern continuation of the field of the same name in Colorado, and the richest coal-producing area in New Mexico. In 1907 70% of the total coal product of New Mexico came from Colfax county, in which this field is situated. Ores of gold, silver and lead have been mined in Colfax county. South and east of the city there is good farming land. Raton is a place of railway origin, and owes its development to its extensive railway shops, as well as to the proximity of mines. It was incorporated in 1891.

RATRAMNUS (d. c. 868), a theological controversialist of the second half of the 9th century, was a monk of the Benedictine abbey of Corbie near Amiens, but beyond this fact very little of his history has been preserved. He is best known by his treatise on the Eucharist (*De corpore et sanguine Domini liber*), in which he controverted the doctrine of transubstantiation as taught in a similar work by his contemporary Radbertus Paschasius. Ratramnus sought in a way to reconcile science and religion, whereas Radbertus emphasized the miraculous. Ratramnus's views failed to find acceptance; their author was soon forgotten, and, when the book was condemned at the synod of Vercelli in 1050, it was described as having been written by Johannes Scotus Erigena at the command of Charlemagne. In the Reformation it again saw the light; it was published in 1532 and immediately translated. In the controversy about election, when appealed to by Charles the Bald, Ratramnus wrote two books *De predestinatione Dei*, in which he maintained the doctrine of a twofold predestination; nor did the fate of Gottschalk deter him from supporting his view against Hincmar as to the orthodoxy of the expression "trina Deitas." Ratramnus perhaps won most glory in his own day by his *Contra Graecorum opposita*, in four books (868), a valued contribution to the controversy between the Eastern and Western Churches which had been raised by the publication of the encyclical letter of Photius in 867. An edition of *De corpore et sanguine Domini* was published at Oxford in 1859.

See the article by G. Steitz and Hauck in Hauck's *Realencyklopädie für protest. Theologie*, Band xvi. (Leipzig, 1905); Naegle, *Ratramnus und die heilige Eucharistie* (Vienna, 1903); Schnitzer, *Berengar von Tours*; and A. Harnack, *History of Dogma*, v., pp. 309-322 (1894-9).

RATTAZZI, URBANO (1808-1873), Italian statesman, was born on the 29th of June 1808 at Alessandria, and from 1838 practised at the bar. In 1848 he was sent to the chamber of deputies in Turin as representative of his native town. By his debating powers he contributed to the defeat of the Balbo ministry, and for a short time held the portfolio of public instruction; afterwards, in the Gioberti cabinet, he became minister of the interior, and on the retirement of the last-named in 1849 he became practically the head of the government. The defeat at Novara compelled the resignation of Rattazzi in March 1849. His election as president of the chamber in 1852 was one of the earliest results of the so-called "connubio" with Cavour, i. e. the union of the moderate men of the Right and of the Left; and having become minister of justice in 1853 he carried a number of measures of reform, including that for the suppression of certain of the monastic orders. During a momentary reaction of public opinion he resigned office in 1858, but again entered the cabinet under La Marmora in 1859 as minister of the interior. In consequence of the negotiations for the cession of Nice and Savoy he again retired in January 1860. He was entrusted with the formation of a new ministry in March 1862, but in consequence of his policy of repression towards Garibaldi at Aspromonte he was driven from office in the following December. He was again prime minister in 1867, from April to October. He died at Frosinone on the 5th of June 1873. His wife, whom he married in 1863, was a remarkable woman. She was the daughter of Sir Thomas Wyse, British plenipotentiary at Athens, and Laetitia Bonaparte, niece of Napoleon I. Born in Ireland in 1833, she was educated in Paris, and in 1848 married a rich Alsatian named Solms; but the prince-president refused to recognize her, and in 1852 she was expelled from Paris. Her husband died soon after; and calling herself the Princesse Marie de Solms, she spent her time in various fashionable places and dabbled in literature, Eugène Sue and François Ponsard being prominent in her court of admirers. She published *Les Chants de l'exilée* (1859) and some novels. After Rattazzi's death, she married (1877) a Spaniard named Rute; she died in February 1902.

See Madame Rattazzi, *Rattazzi et son temps* (Paris, 1881); Bolton King, *History of Italian Unity* (London, 1899).

RATTLESNAKE. Rattlesnakes are a small group of the sub-family of pit-vipers (*Crotalinae*, see SNAKES; *Viperidae*), characterised by a tail which terminates in a chain of horny, loosely connected rings, the so-called "rattle." The "pit" by which the family is distinguished from the ordinary vipers is a deep depression in the integument of the sides of the snout, between the nostrils and the eye; its physiological function is unknown. The rattle is a complicated and highly specialized organ, developed from the simple conical scale or epidermal spine, which in the majority of snakes forms the termination of the general integument of the tail. The bone by which the root of the rattle is supported consists of the last caudal vertebrae, from three to eight in number, which are enlarged, dilated, compressed and coalesced (fig. 1, a). This bone is covered

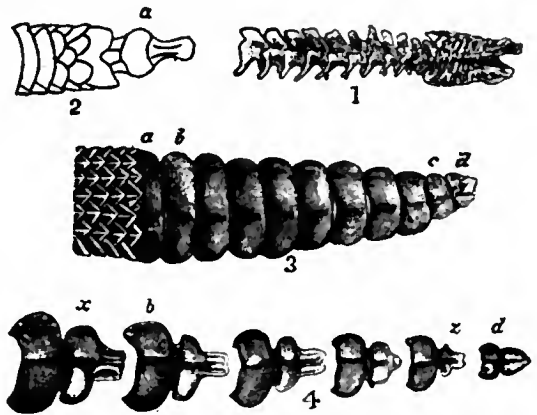

FIG. 1.—Rattle of Rattlesnake (after Czermak).

1. Caudal vertebrae, the last coalesced in a single bone *a*. 2. End of tail (rattle removed); *a*, cuticular matrix covering terminal bone. 3. Side view of a rattle; *c* and *d* the oldest, *a* and *b* the youngest joints. 4. A rattle with joints disconnected; *x* fits into *b* and is covered by it; *z* into *d* in like manner.

with thick and vascular cutis, transversely divided by two constrictions into three portions, of which the proximal is larger than the median, and the median much larger than the distal. This cuticular portion constitutes the matrix of a horny epidermoid covering which closely fits the shape of the underlying soft part and is the beginning of the rattle, as it appears in young rattlesnakes before they have shed their skin for the first time. When the period of a renewal of the skin approaches a new covering of the extremity of the tail is formed below the old one, but the latter, instead of being cast off with the remainder of the epidermis, is retained by the posterior swelling of the end of the tail, forming now the first loose joint of the rattle. This process is repeated on succeeding moultings—the new joints being always larger than the old ones as long as the snake grows. Perfect rattles therefore taper towards the point, but generally the oldest (terminal) joints wear away in time and are lost. As rattlesnakes shed their skins more than once every year, the number of joints of the rattle does not indicate the age of the animal but the number of exuviations which it has undergone. The largest rattle in the British Museum has twenty-one joints. The rattle consists thus of a variable number of dry, hard, horny cup-shaped joints, each of which loosely grasps a portion of the preceding, and all of which are capable of being shaken against each other. If the interspaces between the joints are filled with water, as often happens in wet weather, no noise can be produced. The motor power lies in the lateral muscles of the tail, by which a vibratory motion is communicated to the rattle, the noise produced being similar to that of a child's rattle and perceptible at a distance of from 10 to 20 yds.

The habit of agitating the tail is not peculiar to the rattlesnake, but has been observed in other venomous and innocuous snakes with the ordinary tail, under the influence of fear or anger. It is significant that the tip of such snakes is sometimes rather conspicuously coloured and covered with peculiarly modified

scales, notably in *Acanthophis*. The use of such a tail probably consists in attracting or fixing the attention of small animals, by slightly raising and vibrating the tip. The rattle no doubt acts as a warning, every snake preferring being left alone to being forced to bite. Many a man has been warned in time by the shrill sound, and this principle applies undoubtedly to other

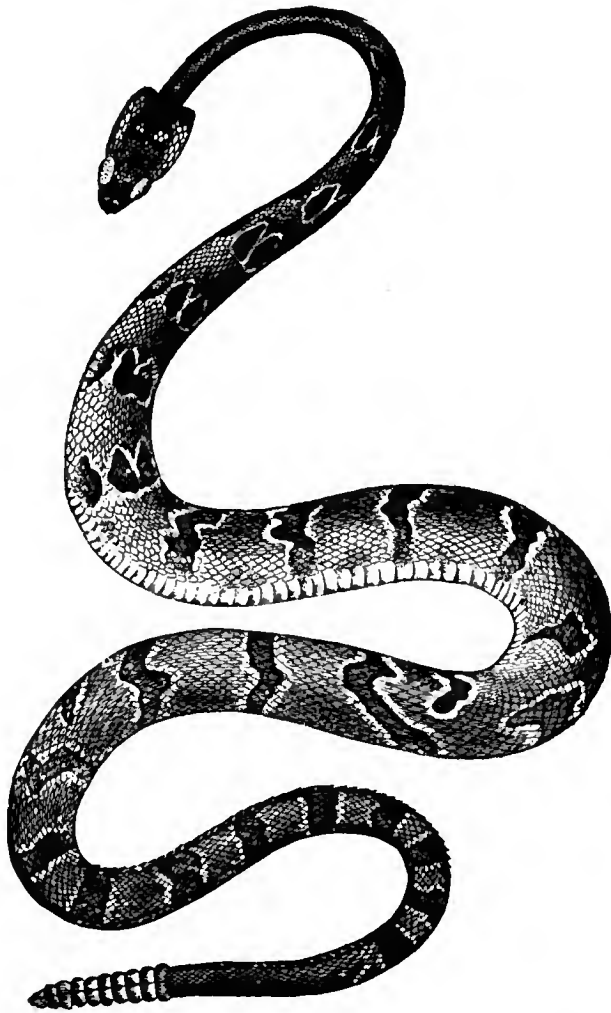

FIG. 2.—Rattlesnake (*Crotalus adamanteus* s. *durissus*).

mammals. Moreover, rattlesnakes are rather sluggish, and comparatively not vicious. First they try to slink away; when overtaken or cornered they use every means of frightening the foe by swelling up, puffing, rattling and threatening attitudes; it is as a rule not until they are touched, or provoked by a rapid movement, that they retaliate, but then they strike with fury. They are viviparous, and as destroyers of rats, mice and other small rodents they are useful. The surest way of clearing a ground of them and any other snakes is to drive in pigs, which are sure to find and to eat them, without harm to themselves. They inhabit localities to which the sun has free access, prairies, rough stony ground, &c. Specimens of 5 ft. in length are not rare. Formerly common in the eastern parts of the United States, and still so in thinly inhabited districts, rattlesnakes, like the vipers of Europe, have gradually succumbed to the persecution of man.

Rattlesnakes are confined to the New World. North-American authors distinguish a great number of different kinds, S. W. Garman ("Reptiles and Batrachians of North America," *Harvard Mus. Zool. Mem.*, 1883, 4to) enumerating twelve species and thirteen additional varieties. E. D. Cope has split them into twenty; but all these species or varieties fall into two groups. One, *Sistrurus*, has the upper side of the head covered with the ordinary nine shields; only three species, of comparatively small size, in North America

(*Sistrurus miliarius* from Florida to Sonora; *S. catenatus* in many of the middle states of the Union, and elsewhere, as far north as Michigan; *S. ravus* in Mexico).

The second group forms the genus *Crotalus*, in which the shields between and behind the eyes are broken up and replaced by small scales. This genus ranges throughout the United States through Central and South America into Patagonia, but is not represented on any of the West Indian islands. *C. horridus*, with the tail uniformly black, from Maine to Kansas and Louisiana to Florida. *C. adamanteus*, tail light, with black crossbands, body with a handsome pattern of rhombs with lighter centres and yellowish edges; chiefly south-eastern states, to Arizona and Mexico; the largest of rattlers, giants of 8 ft. in length having been recorded. *C. confluentus*, tail with brown or indistinct bands; with a continuous series of large brown or reddish rhomboidal spots on the back; Texas to California. *C. cerastes*, with a pair of horns above the eyes; the "sidewinder" of Arizona and California to Nevada. *C. terrificus*, easily distinguished by the possession of three pairs of symmetrical shields on the top of the muzzle, ranging from Arizona into Argentina. It is the only kind of rattlesnake in Central and South America. *C. triseriatus*, a small species, with a feebly developed rattle, on Mexican mountains, on the pic of Orizaba up to 12,500 ft. (St G. M.; H. F. G.)

RAU, KARL HEINRICH (1792-1870), German political economist, was born at Erlangen on the 29th of November 1792. He studied from 1808 to 1812 at the university there, where he afterwards remained as a *Privatdozent*. In 1814 he obtained the prize offered by the academy of Göttingen for the best treatment of the question how the disadvantages arising from the abolition of trade guilds might be removed. His memoir, greatly enlarged, was published in 1816 under the title *Über das Zunftwesen und die Folgen seiner Aufhebung*. In the same year appeared his *Principia lincae historiae politicae*. In 1818 he became professor at Erlangen. In 1822 he was called to the chair of political economy at Heidelberg where the rest of his life was spent, in the main, in teaching and research. He took some part, however, in public affairs: in 1837 he was nominated a member of the first chamber of the duchy of Baden, and in 1851 he was one of the commissioners sent to England on the part of the Zollverein to study the Industrial Exhibition. A result of this mission was his account of the agricultural implements exhibited at London (*Die landwirthschaftlichen Geräthe der Londoner Ausstellung*, 1853). He was elected a corresponding member of the French Institute in 1856. He died at Heidelberg on the 18th of March 1870.

His principal work is the *Lehrbuch der politischen Ökonomie* (1826-37), an encyclopaedia of the economic knowledge of his time, written with a special view to the guidance of practical men. The three volumes are respectively occupied with (1) political economy, properly so called, or the theory of wealth, (2) administrative science (*Volkswirtschaftspolitik*) and (3) finance. The two last he recognizes as admitting of variations in accordance with the special circumstances of different countries, whilst the first is more akin to the exact sciences, and is in many respects capable of being treated, or at least illustrated, mathematically. This threefold division marks his close relation to the older German cameralistic writers, with whose works he was familiarly acquainted. It is a consequence in part of his conformity to their method and his attention to administrative applications that his treatise was found peculiarly adapted for the use of the official class, and long maintained its position as their special text-book. He was the economic teacher, says Roscher, of the well-governed middle states of Germany from 1815 to 1848. The book has passed through many editions; in that of 1870 by Adolf Wagner it was transformed into a new book.

In the earlier part of his scientific life Rau tended strongly towards the relative point of view and an historical method in economics, but he never actually joined the historical school. To the end he occupied a somewhat indeterminate position with respect to that school; on the whole, however, he more and more subordinated historical investigation to immediate practical interests, and in his economic politics moved in the direction of limiting rather than extending the sphere of state action. His general merits are thoroughness of treatment, accuracy of statement, and balance of judgment; he shows much industry in the

collection and skill in the utilization of statistical facts; and his exposition is orderly and clear.

Besides the publications already mentioned, he was author of the following:—*Ansichten der Volkswirtschaft*, 1821; *Malthus und Say über die Ursachen der jetzigen Handelsstockung*, 1821; *Grundriss der Kameralwissenschaft oder Wirtschaftslehre*, 1823; *Über die Kameralwissenschaft, Entwickelung ihres Wesens und ihrer Theile*, 1825; *Über die Landwirtschaft der Rheinpfalz*, 1830; and *Geschichte des Pfluges*, 1845.

Rau founded in 1834 the *Archiv der politischen Ökonomie und Polizeiwissenschaft*, in which he wrote a number of articles, afterwards issued in separate form: amongst them may be named those on the debt of Baden, on the accession of Baden to the Zollverein, on the crisis of the Zollverein in the summer of 1852, on the American banks, on the English poor law, on List's national system of political economy and on the minimum size of a peasant property.

RAUCH, CHRISTIAN DANIEL (1777–1857), German sculptor, was born at Arolsen in the principality of Waldeck on the 2nd of January 1777. His parents were poor and unable to place him under efficient masters. His first instructor taught him little else than the art of sculpturing gravestones, and Professor Ruhl of Cassel could not give him much more. A wider field of improvement opened up before him when he removed to Berlin in 1797; but he was obliged to earn a livelihood by becoming a royal lackey, and to practise his art in spare hours. Queen Louisa, surprising him one day in the act of modelling her features in wax, sent him to study at the Academy of Art. Not long afterwards, in 1804, Count Sandrecky gave him the means to complete his education at Rome, where William von Humboldt, Canova and Thorwaldsen befriended him. Among other works, he executed bas-reliefs of "Hippolytus and Phædra," "Mars and Venus wounded by Diomedæ," and a "Child praying." In 1811 Rauch was commissioned to execute a monument for Queen Louisa of Prussia. The statue, representing the queen in a sleeping posture, was placed in a mausoleum in the grounds of Charlottenburg, and procured great fame for the artist. The erection of nearly all public statues came to be entrusted to him. There were, among others, Bülow and Scharnhorst at Berlin, Blücher at Breslau, Maximilian at Munich, Francke at Halle, Dürer at Nuremberg, Luther at Wittenberg, and the grand-duke Paul Frederick at Schwerin. At length, in 1830, he began, along with Schinkel the architect, the models for a colossal equestrian monument at Berlin to Frederick the Great. This work was inaugurated with great pomp in May 1851, and is regarded as one of the masterpieces of modern sculpture. Princes decorated Rauch with honours and the academies of Europe enrolled him among their members. A statue of Kant for Königsberg and a statue of Thier for Berlin occupied his attention during some of his last years; and he had just finished a model of "Moses praying between Aaron and Hur" when he was attacked by his last illness. He died on the 3rd of December 1857.

RAUCOURT, MLE (1756–1815), French actress, whose real name was Françoise Marie Antoinette Saucerotte, was born in Nancy on the 3rd of March 1756, the daughter of an actor, who took her to Spain, where she played in tragedy at the age of twelve. By 1770 she was back in France at Rouen, and her success as Euphémie in Belloy's *Gaslon et Bayard* caused her to be called to the Comédie Française, where in 1772 she made her *début* as Dido. She played all the classical tragedy parts to crowded houses, until the scandals of her private life and her extravagance ended her popularity. In 1776 she suddenly disappeared. Part of the ensuing three years she was in prison for debt, but some of the time she spent in the capitals of northern Europe, followed everywhere by scandal. Under protection of the queen she reappeared at the Théâtre Français in 1779, and renewed her success in *Phèdre*, as Cleopatra, and all her former rôles. At the outbreak of the Revolution she was imprisoned for six months with other royalist members of the Comédie Française, and she did not reappear upon that stage until the close of 1793, and then only for a short time. She deserted, with a dozen of the best actors in the company, to found a rival colony, but a summons from the Directory brought her back in 1797. Napoleon gave her a pension, and

in 1806 she was commissioned to organize and direct a company that was to tour Italy, where, especially in Milan, she was enthusiastically received. She returned to Paris a few months before her death on the 15th of January 1815. Her funeral was the occasion of a riot. The clergy of her parish having refused to receive the body, the crowd broke in the church doors, and were only restrained from further violence by the arrival of an almoner sent post-haste by Louis XVIII. She is buried at Père Lachaise.

RAUDNITZ (Czech *Roudnice nad Labem*), a town of Bohemia, Austria, 44 m. N. of Prague by rail. Pop. (1900) 7986, mostly Czech. It is situated on the Elbe, and its chief attraction lies in the interesting and valuable collections in its château, which has belonged to the princely family of Lobkowitz since the beginning of the 17th century. These include a library with a large number of the earliest specimens of printing and valuable MSS., together with a series of pictures from the time of Charles V. to the Thirty Years' War. In 1350 Cola di Rienzi, "the last of the tribunes," was confined by the emperor Charles IV. in the castle, which occupied the site of the present château, previous to his despatch under arrest to the pope at Avignon. In 1184 Raudnitz is mentioned as belonging to the see of Prague. The title of duke of Raudnitz was conferred on the head of the family of Lobkowitz by the emperor Joseph II. in 1786.

RAUMER, FRIEDRICH LUDWIG GEORG VON (1781–1873), German historian, was born at Wörlitz in Anhalt on the 14th of May 1781. His father (d. 1822), as *Kammerdirektor* in Anhalt, did excellent service to agriculture. After studying at the Joachimsthal Gymnasium, Berlin, and at the universities of Halle and Göttingen, Raumer began to practise law, and rose in the civil service under Hardenberg, the chancellor. He was made a professor at the university of Breslau in 1811, and in 1819 he became professor of political science and history at Berlin, holding the chair until 1847, and giving occasional lectures until 1853. In 1815 he had carried on historical investigations in Venice, and in the two following years he had travelled in Germany, Switzerland and Italy. In 1848 he was elected a member of the German parliament at Frankfort, where he associated himself with the right centre, supporting the proposal for a German empire under the supremacy of Prussia; and he was one of the deputation which offered the imperial crown to Frederick William IV. After the breakdown of the German parliament, Raumer returned to Berlin, where he was made a member of the first chamber of the Prussian parliament. He died at Berlin on the 14th of June 1873. Raumer's style is direct, lucid and vigorous, and in his day he was a popular historian, but judged by strictly scientific standards he does not rank among the first men of his time.

His first work, published anonymously in 1806, was entitled *Sechs Dialoge über Krieg und Handel*. This was followed by *Das britische Besteuerungssystem* (1810), *Handbuch merkwürdiger Stellen aus den lateinischen Geschichtschreibern des Mittelalters* (1813), *Herbstreise nach Venedig* (1816) and other books. His most famous works are *Geschichte der Hohenstaufen und ihrer Zeit* (1823–25; 5th ed., 1876) and *Geschichte Europas seit dem Ende des 15ten Jahrhunderts* (1832–50). In 1831 appeared *Briefe aus Paris und Frankreich im Jahre 1830 und Briefe aus Paris zur Erläuterung der Geschichte des 16ten und 17ten Jahrhunderts*. He went to England in 1835, to Italy in 1839 and to America in 1843, and these visits led to the publication of various works—*England in 1835* (1836), *Beiträge zur neuern Geschichte aus dem Britischen Museum und Reichsarchive* (1836–39), *Italien, Beiträge zur Kenntniss dieses Landes* (1840), *Die Vereinigten Staaten von Nordamerika* (1845). Among his later books may be mentioned *Antiquarische Briefe* (1851), *Historisch-politische Briefe über die geselligen Verhältnisse der Menschen* (1860), *Lebenserinnerungen und Briefwechsel* (1861) and *Handbuch zur Geschichte der Literatur* (1864–66). In 1830 Raumer began the *Historisches Taschenbuch* published by Brockhaus, which from 1871 was continued by Riehl.

RAUPACH, ERNST BENJAMIN SALOMO (1784–1852), German dramatist, was born on the 21st of May 1784 at Straupitz, near Liegnitz in Silesia, a son of the village pastor. He attended the gymnasium at Liegnitz, and studied theology at the university of Halle. In 1804 he obtained a tutorship

in St Petersburg. He preached at times in the German Lutheran church, wrote his first tragedies, and in 1817 was appointed professor of German literature and history at a training college in connexion with the university. Owing to an outburst of jealousy against Germans in Russia, culminating in police supervision, Raupach left St Petersburg in 1822 and undertook a journey to Italy. The literary fruits of his travels were *Hirsemenzels Briefe aus und über Italien* (1823). He next visited Weimar, but, being coldly received by Goethe, abandoned his idea of living there and settled in 1824 in Berlin. Here he spent the remainder of his life, writing for the stage, which for twenty years he greatly influenced, if not wholly controlled, in the Prussian capital. He died at Berlin on the 18th of March 1852.

Raupach was a prolific writer of both tragedies and comedies; of the former, *Die Fürsten Chawansky* (1818), *Der Liebe Zauberkreis* (1824), *Die Leibeigenen, oder Isidor und Olga* (1826), *Rafaele* (1828), *Der Nibelungenhort* (1834) and *Die Schule des Lebens* (1841), and of the latter *Die Schleichhändler* (1828) and *Der Zeitgeist* (1830) are pieces which have enjoyed great popularity owing to their skilful dramatic handling. On the other hand, the historical dramas with which his name is chiefly associated, *Die Hohenstaufen* (1837-38), a cyclus of 15 dramatic pieces founded on Friedrich von Raumer's *Geschichte der Hohenstaufen*, as also the trilogy *Cromwell* (1841-44), are superficial in treatment. Raupach had a great knowledge of theatrical effect and situations, but he contorts historical facts in order to suit his political hobby, which was the separation of church and state.

Raupach's collected dramas appeared under the title *Dramatische Werke erster Gattung* (16 vols., 1830-43) and *Dramatische Werke komischer Gattung* (4 vols., 1829-35). For his life see Pauline Raupach, *Raupach, eine biographische Skizze* (1853); also K. Goedeke, *Grundriss zur Geschichte der deutschen Dichtung*, 2nd ed. (1905), vol. viii., pp. 646-668.

RAVAILLAC, FRANÇOIS (1578-1610), the assassin of Henry IV. of France, was born near Angoulême. He was of humble origin and began life as a *valet de chambre*, but afterwards became a lawyer and also teacher of a school. After having been imprisoned by his creditors, he sought admission to the recently founded order of Feuillants, but after a short probation was dismissed as a visionary. An application for admission to the Society of Jesus was equally unsuccessful in 1606. His disappointments fostered a fanatical temperament, and rumours that the king was intending to make war upon the pope suggested to him the idea of assassination, which he carried out on the 14th of May 1610. In the course of his trial he was frequently put to the torture, but persistently (and it is now believed truly) denied that he had been prompted by any one or had any accomplices. Sentence of death was carried out on the 27th of May following.

See Jules Loiseleur, *Ravaillac et ses complices* (1873), and E. Lavis, *Histoire de France*, tome vi. (Paris, 1905).

RAVAISSON-MOLLIEN, JEAN GASPARD FÉLIX (1813-1900), French philosopher and archaeologist, was born at Namur on the 23rd of October 1813. After a successful course of study at the Collège Rollin, he proceeded to Munich, where he attended the lectures of Schelling, and took his degree in philosophy in 1836. In the following year he published the first volume of his famous work *Essai sur la métaphysique d'Aristote*, to which in 1846 he added a supplementary volume. This work not only criticizes and comments on the theories of Aristotle and the Peripatetics, but also deduces from them a modern philosophical system. In 1838 he received the degree of doctor, and became professor of philosophy at Rennes. From 1840 he was inspector-general of public libraries, and in 1860 became inspector-general in the department of higher education. He was also a member of the Academy, and of the Academy of Moral and Political Science, and curator of the Department of Antiquities at the Louvre (from 1870). He died in Paris on the 18th of May 1900. In philosophy, he was one of the school of Cousin, with whom, however, he was at issue in many important

points. The act of consciousness, according to him, is the basis of all knowledge. These acts of consciousness are manifestations of will, which is the motive and creative power of the intellectual life. The idea of God is a cumulative intuition given by all the various faculties of the mind, in its observation of harmony in nature and in man. This theory had considerable influence on speculative philosophy in France during the later years of the 19th century.

Ravaisson's chief philosophical works are: "Les Fragments philosophiques de Hamilton" (in the *Revue des Deux Mondes*, November, 1840); *Rapport sur le stoïcisme* (1851); *La Philosophie en France au dix-neuvième siècle* (1868; 3rd ed., 1889); *Morale et métaphysique* (1893). Eminent as a philosopher, Ravaisson was also an archaeologist, and contributed articles on ancient sculpture to the *Revue Archéologique* and the *Mémoires de l'Académie des Inscriptions*. In 1871 he published a monograph on the Venus of Milo.

See Renouvier, in *L'Année philosophique* (Paris, 1868); Dawriac, "Ravaisson philosophe et critique" (*La Critique philosophique*, 1885, vol. ii.).

RAVANASTRON, an Indian stringed instrument played with a bow, used by wandering pilgrims. A Hindu tradition affirms that the musical bow was invented before 3000 B.C. by Ravanon, king of Ceylon, and that the instrument for which he invented it was named after him Ravanastron.¹ Judging from precedent, it is probable that the ravanastron of the present day has changed little, if at all, for many centuries. It consists of half a round gourd, over which is fixed a sound-board of skin or parchment; to this primitive body without incurvation is attached a neck about twice the length of the body. The strings are either one or four in number, the pegs being set in the sides of the neck. The bridge is primitive and either straight or slightly arched, so that in bowing more than one string sounds at once.

The ravanastron is regarded by some writers as the first ancestor of the violin, on account of the alleged invention of the bow for use with it. This theory can only be accepted by those who consider the bow, which after all was common to such inferior instruments as the rebec, as of paramount importance, and the structural features of the instrument itself, the box sound-chest with ribs, which have always belonged to the most artistic types of instruments, such as the cithara and the guitar-fiddle, as of secondary importance.

(K. S.)

RAVELLO, a village of Campania, Italy, in the province of Salerno, about 3 m. N.N.E. of Amalfi by road, 1227 ft. above sea-level. It commands a magnificent view. Pop. (1901) 1851. The history of Ravello cannot be traced beyond the 9th century. In the 11th it was called Rebellum, because it refused to acknowledge the sovereignty of Amalfi, and in the 13th, when at the height of its prosperity, it had 36,000 inhabitants. The Palazzo Rufolo, begun in the 11th century, has two lofty towers and beautiful Saracenic decoration in the courtyard. The ex-cathedral of S. Pantaleo, almost entirely modernized, has fine bronze doors by Barisanus of Trani (1179), and two pulpits in Cosmatesque work. The larger, supported by six columns resting on the backs of lions, was made in 1272 by Nicolaus of Foggia; the bust over the entrance to it is said to be a portrait of Sigilgaita Rufolo. The smaller, of the same date, is simpler, and has curious representations of Jonah and the whale. The parish church of S. Giovanni in Toro, spoilt by restorations in the 18th century, contains a splendid pulpit in Cosmatesque work, supported on four pillars, and the crypt some 14th-century frescoes. In front of it is the porch of the Palazzo dell' Afflitto, composed of ancient fragments. S. Maria Immacolata is another Romanesque church.

See A. Avena, *Monumenti dell' Arte Meridionale* (Naples, 1902), i. 349 sqq.

RAVEN (O.E. *hræfn*, Icel. *hræfn*, Dan. *ravn*, Du. *raaf*, Ger. *Rabe*), the largest of the birds of the order Passeres, and a member of the family Corvidae, probably the most highly developed of all birds. Quick-sighted, sagacious and bold, the raven preys on the spoils of fishers and hunters, as also on weakly

¹ An illustration appears in Sonnerat's *Voyages aux Indes orientales* (Paris, 1806), vol. i. p. 182.

animals among flocks and herds. A sentiment of veneration or superstition has from remote ages and among many races attached to it. The raven is associated with various characters of history, sacred or profane—Noah and Elijah, Odin and Flokki, the last of whom by its means discovered Iceland. It is said to have played its part in the mythology of the Red Indian; and it has often figured in prose and verse, from the time of Shakespeare to that of Poe and Dickens. Superstition has been generally succeeded by persecution, which in many districts has produced extirpation.

The raven breeds very early in the year, in England resorting to its nest, which is usually an ancient if not an ancestral structure, about the middle or towards the end of January. Therein are laid from five to seven eggs of the common Corvine coloration (see Crow), and the young are hatched before the end of February. In more northern countries the breeding season is naturally delayed, but everywhere this species is almost, if not quite, the earliest breeder. The raven measures about 26 in. in length, and has an expanse of wing considerably exceeding a yard. Its bill and feet are black, and the same may be said of its whole plumage, but the feathers of the upper parts as well as of the breast are glossy, reflecting a bright purple or steel-blue. The species (*Corvus corax*) inhabits the whole of Europe, and the northern if not the central parts of Asia; but in the latter continent its southern range is not well determined. In America it is, or used to be, found from the shores of the Polar Sea to Guatemala if not to Honduras, but is said hardly to be found of late years in the eastern part of the United States. In Africa its place is taken by three allied but well-differentiated species, two of which (*Corvus umbrinus*, readily distinguished by its brown neck, and *C. affinis*, having its superior nasal bristles upturned vertically) also occur in south-western Asia, while the third (*C. leptonyx* or *C. tingitanus*, a smaller species characterized by several slight differences) inhabits Barbary and the Atlantic Islands. Farther to the southward in the Ethiopian region three more species appear whose plumage is varied with white—*C. scapulatus*, *C. albicollis*, and *C. crassirostris*—the first two of small size, but the last rivalling the real raven in that respect. (A. N.)

RAVEN-HILL, LEONARD (1867–), English artist and illustrator, was born on the 10th of March 1867. He was educated at Bristol grammar school and the Devon county school, and studied art at Lambeth and then in Paris under MM. Bougereau and Aimé Morot. He began to exhibit at the Salon in 1887, and in the Royal Academy in 1889. In 1893 he founded, with Arnold Golsworthy, the humorous and artistic monthly *The Butterfly* (1893-94, revived in 1899-1900). He contributed to many illustrated magazines, and began to work for *Punch*, with which he was afterwards prominently associated, in 1896. He illustrated Sir Walter Besant's *East London* (1901) and J. H. Harris's *Cornish Saints and Sinners*; he published the impressions of his visit to India on the occasion of the tour of the prince and princess of Wales as *An Indian Sketch-Book* (1903); and his other published sketch-books include *Our Battalion* (1902) and *The Promenaders* (1894).

RAVENNA, a city and archiepiscopal see of Emilia, Italy, capital of the province of Ravenna, standing in a marshy plain 13 ft. above sea-level, 6 m. from the sea and 45 m. by rail east of Bologna. Pop. (1906) 35,543 (town), 67,379 (commune)—a considerable increase, as the population of 1881 was only 34,270 (commune). The industries are few, the growing of wine, breeding of silkworms, making of agricultural instruments, printing and the manufacture of laces being the chief. The town is connected with the sea by the Corsini Canal, the two small rivers Ronco and Montone no longer serving as means of communication. Ravenna has railway communication with Bologna (via Castel Bolognese), Ferrara and Rimini, and by steam tram with Forlì. At the mouth of the canal is a small harbour.

No other city in the world offers so many and such striking examples of the ecclesiastical architecture of the centuries from the 5th to the 8th. The style is commonly called Byzantine;

but some of the most striking features of the churches of Ravenna—the colonnades, the mosaics, perhaps the cupolas—are not so much Byzantine as representative of early Christian art generally. The following are the most important churches of Ravenna, arranged in the order of the dates generally attributed to them:—

Church.	Builder.	Date.
1. Metropolitan Church, or Ecclesia Ursiana, and baptistery adjoining	S. Ursus	370-390(?)
2. S. Giovanni Evangelista	Galla Placidia	425
3. S. Agata	Gemellus	about 430
4. S. Pier Crisologo (chapel)	S. Peter Chrysologus	about 450
5. S. Giovanni Battista	Baduarius	"
6. SS. Nazario e Celso	Galla Placidia	"
7. S. Pier Maggiore (now S. Francesco)	Bishop Neon (?)	about 458
8. S. Teodoro (now Santo Spirito)—A.	Theodoric (?)	493-526
9. S. Maria in Cosmodin (Arian baptistery)—A.	"	"
10. S. Martino in Coelo Aureo (now S. Apollinare Nuovo)—A.	"	"
11. S. Vitale	Julianus Argentarius	about 530
12. S. Maria Maggiore	Bishop Ecclesius	"
13. S. Apollinare in Classe	Julianus Argentarius	about 535

(The churches marked A. were originally erected for the Arian worship.)

Almost the only sacred building previous to the 5th century of which we have any record is unfortunately lost. The cathedral of Ravenna, built by S. Ursus in 370-390, which had a nave and four aisles, was destroyed in 1734-44, only the (inaccessible) crypt and the round campanile remaining from the earlier structure; there are fragments of reliefs from a pulpit erected by Archbishop Agnellus (556-569) in the interior. A rare work on the earlier church (Buonamici, *La Metropolitaniana di Ravenna*) gives details of its construction. The present cathedral contains several early Christian marble sarcophagi, a silver cross of the 6th century (that of Agnellus), and the so-called throne of the Archbishop Maximian (546-552), adorned with reliefs in ivory, which, however, was really brought to Ravenna in 1001 by John the Deacon, who recorded the fact in his Venetian chronicle, as a present from the Doge Pietro Orseolo to the Emperor Otho III.

The period from the transference of the imperial residence to Ravenna to the death of Valentinian III. (404-455) was the first period of great building activity in Ravenna, when the archiepiscopal see of Ravenna attained great importance. It was to it that we owe the erection of the Basilica Petriana at Classe (396-425), which has entirely disappeared, of the churches of S. Giovanni Evangelista (425), of S. Agata (425-432), of the chapel of S. Pier Crisologo (433-440), of the tomb of Galla Placidia (440), the church of S. Pier Maggiore (now S. Francesco) (433-458), the baptistery of Neon (449-458). S. Giovanni Battista and S. Croce.

Rivoira, in the book cited below, shows that many of the characteristic architectural details can be traced back to a classical and in particular a Roman origin, and were not derived from the East, e.g. the use of blind arches as an external decoration, and of brick cornices with the points of the bricks projecting like the teeth of a saw, the use of pulvini (cushions) above the capitals of columns and under the spring of an arch, &c. &c., the use of round arches springing direct from these cushions, spherical pendentives, &c.

Of this group of churches, S. Giovanni Evangelista, erected by Galla Placidia in fulfilment of a vow made on her voyage from Constantinople, has been entirely rebuilt, though the columns are ancient (the Corinthian capitals are probably from a classical building), and the crypt may be original. The Gothic portal is fine, and the church contains a mosaic pavement of 1213 with curious representations and some frescoes by Giotto, painted during a visit to Dante between 1317 and 1320. S. Agata was almost entirely rebuilt in 1476-94. The

chapel of S. Pier Crisologo in the archiepiscopal palace preserves its original mosaics, and so also does the tomb of Galla Placidia (SS. Nazario e Celso), a small structure in the form of a Latin cross with a dome (in which, as in the baptistery of Neon, the old cathedral, &c., the constructional use of amphorae is noteworthy), with a plain brick exterior, and rich mosaics on a dark blue ground within. The sarcophagus of Galla Placidia has, like the two others that stand here, been despoiled of its contents. The altar, like that at S. Vitale, is made of thin slabs of alabaster, behind which lamps were intended to be placed.

S. Francesco, as it has been called since 1261, when it came into the possession of the Franciscans, has been almost entirely modernized, except for the crypt and campanile (11th century). The baptistery adjacent to the cathedral was, according to Ricci, originally part of the Roman baths, converted to a Christian baptistery by the Archbishop Neon (449-452), though according to other authorities it is a Christian building dating from before A.D. 396. It is an octagon, with a dome; in the interior are two arcades one above the other. The mosaics of the 5th century, in the dome, are the earliest and perhaps the finest at Ravenna for their splendid decorative effect and rich colouring, and are less stiff and conventional than the later mosaics.

Of S. Giovanni Battista, also erected in this period, hardly anything remains after the restoration of 1683, and S. Croce has been overtaken by a similar fate.

After the death of Valentinian III. the activity in building for which Ravenna had been so remarkable suffered a check; but the reign of Theodoric (493-526) marks another era of magnificence. In the eastern part of the city he built for himself a large palace, which probably occupied about a sixth of the space now enclosed within the city walls, or nearly the whole of the rectangle enclosed by Strada di Porta Alberoni on the south, Strada Nuova di Porta Serrata on the west and the line of the city walls on the north and east. There still remains close to the first-named street and fronting the Corso Garibaldi a high wall built of square Roman bricks, with pillars and arched recesses in the upper portion, which goes by the name of Palazzo di Teodorico. Freeman, on account of the Romanesque character of the architecture, thought it probable that it really belongs to the time of the Lombard kings, and his opinion is shared by Ricci and Rivoira, who consider it to be a guardhouse erected by the exarchs, recent explorations having made it clear that it was an addition to the palace, while mosaic pavements and an atrium once surrounded by arcades really belonging to the latter were found in 1870 behind S. Apollinare Nuovo and in 1908 behind the so-called Palazzo at a lower level and a different orientation. A mosaic in the church of S. Apollinare Nuovo gives some faint idea of the palace. A more memorable and clearly authentic monument of Theodoric is furnished by his tomb, a massive mausoleum which stands still perfect outside the walls near the north-east corner of the city. It is circular internally and decagonal externally, in two storeys, built of marble blocks, and surmounted by an enormous monolith, brought from the quarries of Istria and weighing more than 300 tons. The plan is no doubt derived from that of a Roman tomb. In this mausoleum Theodoric was buried, but his body was cast forth from it, perhaps during the troublous times of the siege of Ravenna by the imperial troops, and the Rotunda (as it is now generally called) was converted into a church dedicated to the Virgin.

S. Apollinare Nuovo, the most important basilica in the town, was built by Theodoric to be the largest of Arian churches, and originally called S. Martino in Coelo Aureo (a name which it lost in the 9th century). The exterior is uninteresting, and the church lost both atrium and apse in the 16th century. The interior has twenty-four columns of marble (from Constantinople according to some, from Rome according to others), with almost uniform capitals. The walls of the nave are adorned with mosaics of the 6th century; the scenes from the New Testament above the windows date from the time of Theodoric, while the

somewhat stiff processions below, of virgins on one side and of saints on the other, are substitutions of the latter half of the 6th century for representations which probably contained some allusion to Arianism or episodes in the life of Theodoric (so Ricci). The mosaics have been in parts much restored; but the earlier ones still show, like those which preceded them in Ravenna, classical forms, variety of treatment and freedom of colouring, while the processions are monotonous and inferior in execution, intended rather to produce a decorative effect than beauty of form. The pulpit appears to be of Byzantine origin (Rivoira). The campanile (850-878) is circular, and has perhaps the earliest example of the use of disks of coloured majolica as a decoration. This, like the other campanili of Ravenna, is later than the church to which it belongs. Those of the cathedral of S. Apollinare in Classe, S. Maria Maggiore and S. Agata, also circular, probably belong also to the 9th century, while the two square campanili of S. Giovanni Evangelista and S. Francesco probably belong to the early 11th century. The other churches erected by Theodoric are: S. Teodoro (or S. Spirito), erected by Theodoric for the Arian bishops, but entirely modified: the baptistery of this church (afterwards the oratory of S. Maria in Cosmedin) formed out of the octagonal hall of a Roman bath (?)—unless it is an originally Christian building—with mosaics of the 6th century imitating those of the baptistery of Neon, and freely restored; S. Maria Maggiore, founded by the Archbishop Ecclesius (521-534), but almost entirely rebuilt; and S. Vittore, which has suffered a similar fate. To the same period probably belong a few columns of the so-called Basilica of Heracles in the Piazza Vittorio Emanuele, with capitals like those of S. Apollinare in Classe.

The impulse given by Theodoric was continued by his successors, and during the regency of Amalasantha and the reigns of Theodatus and Vitiges (526-539), S. Vitale and S. Apollinare in Classe were constructed by Julius Argentarius contemporaneously with S. Lorenzo in Milan and the cathedral of Parenzo—also S. Michele in Africisco, nothing of the original structure of which now exists. The former, well restored by Ricci in 1898-1900 (except for the dome with its baroque frescoes which has not been altered), is a regular octagon, with a vestibule, originally flanked by two towers on the west, a choir added on the east, triangular outside and circular within; it is surrounded within by two galleries interrupted at the presbytery, and supported by eight large pillars, the intervals between which are occupied by open exedrae. The mosaics of the choir (547) are due to Justinian, and, though inferior in style, are remarkable for their splendour of colouring and the gorgeous dresses of the persons represented, and also for their historical interest, especially the scenes representing the emperor and the empress Theodora presenting offerings. The marble screens of the altar are wonderfully finely carved. The marble mosaic pavement (11th century) is very effective. Remains of the original marble wall lining and stucco decoration also exist. The capitals are, in the lower order, the characteristic funnel-shaped rectangular Byzantine capitals, some of them with open work, bearing cushions; this is a type probably derived from the cushion itself, and developed in the East about the second half of the 5th century.

The architecture of S. Vitale (for plan see ARCHITECTURE, sect. *Early Christian*), according to Rivoira, was inspired not by Byzantium, where similar churches—S. Sofia and SS. Sergio and Bacco—are slightly later in date, but by the churches of Salonica (A.D. 495), while the plan is derived from a Christian baptistery, or from such a building as the so-called temple of Minerva Medica at Rome.

S. Apollinare in Classe, erected at the same time outside the walls of Classis, and now standing by itself in the lonely marshes, is the largest basilica existing at Ravenna. It has a nave and aisles with a closed vestibule on the west, and a fine round campanile of the 9th (?) century. The exterior brick walls are divided by shallow arches and pilasters, as in other churches of Ravenna. It has twenty-four columns of Carystian (cipollino) marble, with capitals probably of Byzantine work with swelling

acanthus leaves; but the rest of the church is due to native architects. The lofty presbytery and the crypt under it belong to the 12th century. The walls of the interior were stripped of their marble panelling by Sigismondo Malatesta in 1449, for the adornment of his church at Rimini. The apse has mosaics of the 6th and 7th centuries. The 18th-century series of portraits of the archbishops of Ravenna is no doubt copied from an earlier original. There are a number of fine carved sarcophagi in the church (5th to 8th century). The building activity of the Gothic kings was continued by Justinian, to whose time we owe the completion of S. Vitale and S. Apollinare in Classe, and some of the mosaics in S. Appollinare Nuovo.

The buildings of a subsequent period are of minor importance, but the basilica of S. Maria in Porto near the ancient harbour (1096 sqq.), a basilica with open roof, with frescoes by masters of the Rimini school, may be noticed. The massive concrete substructures of the campanile are attributed to an old lighthouse. The tomb of Dante, who died at Ravenna in 1321, is close to S. Francesco; it is a square-domed structure, with a relief by Pietro Lombardo (1482) representing the poet, and a sarcophagus below, in an urn within which lie the poet's remains. Close by is a small court with early Christian sarcophagi, containing the remains of the Braccioforte family. The secularized monastery of Classe, in the town, built by the monks of S. Apollinare in Classe in 155 sqq. as a refuge from the malaria, which prevailed at Classe itself, with fine 17th-century cloisters, contains the important museum, which has Roman and Byzantine antiquities, inscriptions, sculptures, jewelry, &c.—including the possible remains of a suit of gold armour of Theodoric—and a collection of Italian woodcuts; also the library with rare MSS. and incunabula (among the former the best extant MS. of Aristophanes). The Accademia, close by, has a few pictures by local masters, e.g. N. Rondinelli (end of 15th century), of no great importance, and a fine recumbent statue of Guidarello Guidarelli, a condottiero of Ravenna, and a partisan of Caesar Borgia (d. 1501), by Tullio Lombardo (?) or Severo da Ravenna (?).

In the Piazza Vittorio Emanuele are two granite columns erected by the Venetians, in 1483, with statues of SS. Apollinaris and Vitalis. The cloisters of S. Maria di Porto erected in the town in the 16th century (owing to malaria, as in the case of those of Classe), and of S. Vitale, are pleasing 16th-century structures. The 15th-century castle in the north-east corner of the town erected by the Venetians is a picturesque brick building. The famous *pineto* or pinewood of Ravenna, which already existed in Odoacer's time, and has been sung by poets since Dante, lies some 5 m. south of Ravenna.

History.—Strabo mentions a tradition that Ravenna was founded by Thessalians, who afterwards, finding themselves pressed by the Etrurians, called in their Umbrian neighbours and eventually departed, leaving the city to their allies. Pliny, on the other hand, calls it Sabine. Throughout the valley of the Po the Gauls took the place of the Etrurians as a conquering power; but Ravenna may possibly have retained its Umbrian character until, about the year 191 B.C., by the conquest of the Boii, the whole of this region passed definitely under the dominion of Rome. Either as a colonia or a municipium, Ravenna remained for more than two centuries an inconsiderable city of Gallia Cisalpina, chiefly noticeable as the place in which Caesar during his ten years' command in Gaul frequently resorted in order to confer with his friends from Rome, and from which he started for his advance into Italy. At length under Augustus it suddenly rose into importance, when that emperor selected it as the station for his fleet on "the upper sea." Two hundred and fifty ships, said Dion (in a lost passage quoted by Jordanes), could ride at anchor in its harbour. At the same time Augustus conducted a branch of the Po (the fossa Augusta) through the city into the sea. It also became important for the export of timber from the Alps. Strabo, writing probably a few years after Ravenna had been thus selected as a naval arsenal, gives us a description of its appearance which certainly corresponds more closely with modern Venice than with modern

Ravenna. "It is the largest of all the cities built in the lagoons, but entirely composed of wooden houses, penetrated in all directions by canals, wherefore bridges and boats are needed for the wayfarer. At the flow of the tide a large part of the sea comes sweeping into it; and thus, while all the muddy deposit of the rivers is swept away, the malaria is at the same time removed, and by this means the city enjoys so good a sanitary reputation that the government has fixed on it as a place for the reception and training of gladiators." On the other hand, good water was proverbially difficult to obtain at Ravenna—dearer than wine, says Martial, who has two epigrams on the subject. Trajan, however, built an aqueduct nearly 20 miles long, which was restored by Theodoric in 503. Of this some traces still exist in the bed of the Ronco above Ravenna. Flies and frogs were also complained of, and Sidonius, writing in the 5th century, complains bitterly of the "feculent gruel" (*cloacalis puls*) which filled the canals of the city, and gave forth fetid odours when stirred by the poles of the bargemen. The port of Ravenna, situated about 3 miles from the city, was named Classis. A long line of houses called Caesarea connected it with Ravenna, and in process of time there was such a continuous series of buildings that the three towns seemed like one. It was a municipium under the Empire, as the inscriptions show, but it seems to have had magistrates rather suited to a *vicus* or village, its importance being due entirely to the naval station (cf. the state of things at *Mediolanum*, Milan). It had large guilds of *fabri* (smiths and carpenters) and *centonarii* (firemen).

Of Roman Ravenna nothing remains above ground, though a little has been found by excavation, including a mosaic pavement at Classe near S. Severo (Ricci, *op. cit.* p. 50). Among the tombs many of the poorer under the Empire were simply formed of amphorae, in which the body was placed. A prehistoric station was found in 1894 at S. Zaccaria near Ravenna, belonging to a Terramare (E. Brizio in *Notizie degli Scavi*, 1896, 85). In A.D. 339 it is spoken of as having previously been the chief town of Picenum, but having recently been assigned to Aemilia. It was connected with Ariminum, 33 miles to the south by the coast road, the Via Popillia, which ran on north to Hatria, and joined the road between Patavium and Altinum at Ad Portum.

The great historical importance of Ravenna begins early in the 5th century, when Honorius, alarmed by the progress of Alaric in the north of Italy, transferred his court hither. From this date (404) to the fall of the Western Empire in 476 Ravenna was the chief residence of the Roman emperors. Here Stilicho was slain; here Honorius and his sister Placidia caressed and quarrelled; here Valentinian III. spent the greater part of his life; here Majorian was proclaimed; here the little Romulus donned his purple robe; here in the pinewood¹ outside the city his uncle Paulus received his decisive defeat from Odoacer. Through all these changes Ravenna maintained its character as an impregnable "city in the sea," not easily to be attacked even by a naval power on account of the shallowness and devious nature of the channels by which it had to be approached. Odoacer, like the emperors who had gone before him, made Ravenna his chief place of residence, and here he shut himself up when Theodoric the Ostrogoth had invaded Italy and defeated him in two battles. Theodoric's siege of Ravenna lasted for three years (489–492), and was marked by one bloody encounter in the pinewood on the east of it. The Ostrogoth collected a fleet and established a severe blockade, which at length caused Odoacer to surrender the city. The terms, arranged through the intervention of John, archbishop of Ravenna, were not observed by

¹ The great pinewood to the east of the city, which is still one of the great glories of Ravenna, must therefore have been in existence already in the 5th century. Byron's description,

"[The] immemorial wood

Rooted where once the Adrian wave flowed o'er," is probably true; but there is no evidence that it was in historic time that this change took place. It may be conjectured that the *Pineta* grew on a large peninsula somewhat resembling the Lido of Venice.

Theodoric, who, ten days after his entry into the city, slew his rival at a banquet in the palace of the Laurel Grove (March 15, 493). Ravenna was Theodoric's chief place of residence, and his reign (493-526) may be considered the time of its greatest splendour.

Nine years after the death of Theodoric Justinian sent an army to destroy the Gothic monarchy and restore Italy to the empire. Long after the Goths had lost Rome they still clung to Ravenna, till at length, weary of the feebleness of their own king, Vitiges, and struck with admiration of their heroic conqueror, they offered to transfer their allegiance to Belisarius on condition of his assuming the diadem of the Western Empire. Belisarius dallied with the proposal until he had obtained an entrance within the walls of the capital, and proclaimed his inviolable fidelity to Justinian. Thus in the year 539 was Ravenna re-united to the Roman empire. Its connexion with that empire—or, in other words, its dependence upon Constantinople—lasted for more than 200 years, during which period, under the rule of Narses and his successors the exarchs, Ravenna was the seat of Byzantine dominion in Italy. In 728 the Lombard king Luitprand took and destroyed the suburb Classis; about 752 the city itself fell into the hands of his successor Aistulf, from whom a few years after it was wrested by Pippin, king of the Franks. By this time the alteration of the coast-line and the filling up of the lagoons had probably commenced, and no historical importance attaches to its subsequent fortunes. It formed part of the Frankish king's donation to the pope in the middle of the 8th century, though the archbishops, as a fact, retained almost independent power. It was an independent republic, generally taking the Guelph side in the 13th century, subject to rulers of the house of Polentani in the 14th, Venetian in the 15th (1441), and papal again in the 16th,—Pope Julius II. having succeeded in wresting it from the hands of the Venetians. St Romuald and St Peter Damian were both natives of Ravenna. From this time (1500) down to our own days, except for the interruptions caused by the wars of the French Revolution, Ravenna continued subject to the papal see and was governed by a cardinal legate. In 1849 Garibaldi's wife Anita, who had accompanied him on his retreat from Rome, succumbed to fatigue in the marshes near Ravenna. In 1859 it was one of the first cities to give its vote in favour of Italian unity, and it has since then formed a part of the kingdom of Italy.

Charles the Great carried off the brazen statue of Theodoric and the marble columns of his palace to his own palace at Aix-la-Chapelle. More than five centuries later (1320) Dante became the guest of Guido Novello di Polenta, lord of Ravenna, and here he died on the 14th September of the following year. The marble urn containing the body of the poet still rests at Ravenna, where what Byron calls "a little cupola more neat than solemn" has been erected over it. In 1512 (see below) the French army under Gaston de Foix fought a fierce battle with the Spanish, Venetian, and papal troops on the banks of the Ronco about two miles from Ravenna. The French were victorious, but Gaston fell in the act of pursuing the enemy. His death is commemorated by the Colonna dei Francesi erected on the spot where he fell. Lord Byron resided at Ravenna for eighteen months in 1820-21, attracted by the charms of the Countess Guiccioli.

AUTHORITIES.—The most important authority for the history of Ravenna is Bishop Agnellus, who wrote, about 840, the *Liber Pontificalis Ecclesie Ravennatis*. The best edition is that by Holder-Egger in the *Monumenta Germaniæ Historica* (1878). See also E. Bormann, in *Corpus Inscript. Latin.* xi. (Berlin, 1888), p. 1 sqq.; G. T. Rivoira, *Origini dell' Architettura Lombarda*, I. (Rome, 1901); C. Ricci, *Ravenna* (Bergamo, 1902). To the careful restorations of the last named the buildings of Ravenna owe much. (T. H.; T. As.)

Battle of 1512.—This battle, one of the principal events of the long Italian wars of Charles VIII., Louis XII., and Francis I. of France, is, like Marignano, interesting in a tactical sense, from the fact that the feudalism of the past and the expert soldiery of the future were strangely mingled. It arose out of the attempt of the Spanish and Italian forces to relieve

Ravenna, besieged by Gaston de Foix, duke of Nemours. The most celebrated captains of these wars were present on either side—under Gaston de Foix were Bayard, Yves d'Allègre, La Palisse; and under Cardona the Spanish viceroy of Naples, Pedro Navarro the great engineer, and Pescara the originator of the Spanish tactical system. After some preliminary manœuvres the two armies drew up face to face on the left bank of the Roneo, the Spanish left and the French right resting on this river. The Spaniards were entrenched, with their heavy artillery distributed along the front, but, thanks to Navarro, they had a more mobile artillery in the shape of 200 *arquebuses à croc* mounted in groups upon carts, after the German fashion, and this was held ready to move wherever its services might be needed. The left wing was composed of the papal contingent, 6000 infantry and 800 gendarmes under Fabrizio Colonna; the centre, of half the Spanish contingent, 4000 infantry and 600 lancers under the viceroy; the right, of 1000 light horse under Pescara. Behind the centre was the rest of the Spanish contingent, 600 lancers and 4000 infantry. On the other side the right wing was commanded by the duke of Ferrara, who had like Navarro organized a mobile field artillery (the artillery material of this prince was thought to be the best conditioned in Europe). It consisted besides of 800 French gendarmes under Louis de Brézé and 5000 German landsknechts under Jakob Empser. In the centre were 8000 French infantry (the ancestors of the later Picardie and Piedmont regiments) under the seigneur de Molart, and 5000 Italian infantry. On the left were the light horse. A reserve of 600 gendarmes under La Palisse was behind the centre. The battle opened with a prolonged cannonade from the Spanish lines. For three hours the professional regiments of all sorts in the French lines rivalled one another in enduring the fire unmoved, the forerunners of the military systems of to-day, landsknechts, Picardie and Piedmont, showing the feudal gendarmerie that they too were men of honour. There was no lying down. The captains placed themselves in the front, and in the centre 38 out of 40 of them were struck down. Molart and Empser, drinking each other's health in the midst of the cannonade, were killed by the same shot. Sheltered behind the entrenchments, the Spaniards scarcely suffered, for they were lithe active troops accustomed to lie down and spring up from the ground. But after three hours, Pescara's light horse having meantime been driven in by the superior light horse of the enemy, the artillery-loving duke of Ferrara conceived the brilliant plan of taking his mobile field-guns to the extreme right of the enemy. This he did, and so came in sight of the prone masses of the Spaniards. Disciplined troops as they were, they resisted the temptation to escape Ferrara's fire by breaking out to the front; but the whole Spanish line was *enfiladed*, and on the left of it the papal troops, who were by no means of the same quality, filled up the ditch in front of their breastworks and charged forward, followed by all the gendarmerie. Once in the plain they were charged by the French gendarmes under Gaston himself, as well as by the landsknechts, and driven back. The advantage of position being thus lost, the Spanish infantry rose and flung itself on the attackers; the landsknechts and the French bands were disordered by the fury of the counterstroke, being unaccustomed to deal with the swift, leaping, and crouching attack of swordsmen with bucklers. But La Palisse's reserve wheeled in upon the rear of the Spaniards, and they retreated to the entrenchments as fast as they had advanced. The papal infantry, the gendarmes, and the light horse had already vanished from the field in disorder; but the Spanish regulars were of different mettle, and it was only after a long struggle that the landsknechts and the French bands broke into the entrenchments. A captain of landsknechts, Fabian by name, holding his long pike crosswise, brought it down with all his force upon the opposing spears, and at the cost of his life made a narrow gap through which the French broke into the mass of the enemy. Still the conflict continued, but at last La Palisse, with all the gendarmerie still in hand, rode completely round the entrenchments and charged the Spaniards' rear again. This was the

end, but the remnant of the Spanish infantry retreated in order along the river causeway, keeping the pursuers at bay with their arquebuses. Gaston de Foix, recklessly charging into the midst of them, was killed. (C. F. A.)

RAVENNA, EXARCHATE OF, the official name of that part of Italy which remained in the allegiance of the Roman emperors at Constantinople from the closing years of the 6th to the middle of the 8th century. The civil and military head of these possessions, the exarch (*q.v.*), was stationed at Ravenna. The territory round the town, from the southern border of the modern Venetia to the beginning of the Pentapolis at Rimini, was under his direct administration and formed in a limited sense the exarchate. The other provinces were governed by dukes and *magistri militum*, titles which were generally, but not always, borne by the same person. But as all were subject to his authority, they were included in the exarchate of Ravenna, which was therefore another name for the province of Italy. The borders of these dominions varied according to the fortunes of the imperial authority in its long struggle with the Lombards. Sicily formed a separate government. Corsica and Sardinia belonged to the exarchate of Africa. The reorganization of the province of Italy into the exarchate was forced on the emperors by the Lombard invasion, which began in 568, and their permanent settlement. The Lombards thrust a wedge into Italy. Its base was in Venetia, and its point was advanced to the Tiber. From the early days of the conquest they spread to the south, and established the duchies of Spoletum and Beneventum in the modern kingdom of Naples. They may thus be said to have hollowed out the imperial, or Byzantine, possessions in Italy, the interior being under their power, and the coast remaining to the imperial officers. This illustration, however, is subject to two serious exceptions. As the Lombards spread they came into possession of many parts of the coast. Then a belt of imperial territory stretching from Rimini on the Adriatic, S.W. to the mouth of the Tiber, and including the duchies of Perugia and Rome, served to unite the immediate territory of Ravenna with the duchy of Naples, and to separate the two bodies under Lombard dominion, the kingdom in the north, and the southern duchies Spoletum and Beneventum. The organization of the exarchate is placed by modern investigators under the reign of the emperor Maurice (582-602), when the imperial government began to recognize the necessity of providing for a new and a long struggle. At the end of the 6th century the exarchate included Istria; the maritime part of Venetia as distinct from the interior which was in the hands of the Lombard kings at Pavia; the exarchate proper, or territory around Ravenna on the eastern side of the Apennines, to which was added Calabria, which at that period meant the heel and not the toe of the boot; the Pentapolis, or coast from Rimini to Ancona with the interior as far as the mountains; the duchy of Rome, or belt of territory connecting the Pentapolis with the western coast, the coast of Naples, with Bruttium the toe of the boot, the modern Calabria, and Liguria, or the Riviera of Genoa. The Piedmont, Lombardy, mainland of Venetia, Tuscany and the interior of Naples belonged to the Lombards. The advance of these barbarians was for a time checked during the anarchy which followed the death of Alboin, and was subject to other suspensions. The superior organization of the imperial government enabled it to regain lost territory and delay complete ruin. In 590 the empire regained much of Venetia. But these revivals were not permanent. The superiority of the empire was a mechanical one, and during the two centuries or so that the exarchate lasted it lost ground. In 640 the Ligurian seacoast fell under the power of the Lombards, and ceased to be an imperial province. About a century later the exarchate had been greatly reduced, though the imperial officials endeavoured to conceal the fact by retaining and transferring names when the reality of possession was lost. About 740 it consisted of Istria, Venetia (the maritime portion of which was ceasing to be a province and was becoming a protected state, the forerunner

of the future republic of Venice), Ferrara, Ravenna (the exarchate in the limited sense), Pentapolis, Perusia, Rome, the coast of Naples and Calabria (in the sense of the toe and not the heel of the boot) which was being overrun by the Lombards of the duchy of Beneventum, which with Spoletum held the interior. In Rome the pope was the real master. These fragments of the "province of Italy," as it was when reconquered by Justinian, were almost all lost either to the Lombards, who finally conquered Ravenna itself about 750, or by the revolt of the pope, who separated from the empire on account of the iconoclastic reforms. The intervention of Pippin the Carolingian, who was called in by the popes to protect them against the Lombards and the Eastern emperors alike, made a revival of the exarchate impossible. It disappeared, and the small remnants of the imperial possessions on the mainland, Naples and Calabria, passed under the authority of the "patricius" of Sicily, and when Sicily was conquered by the Arabs in the 10th century were erected into the themes of Calabria and Langobardia. Istria was attached to Dalmatia.

In its internal history the exarchate was subject to the influences which were everywhere, in central and western Europe at least, leading to the subdivision of sovereignty and the establishment of feudalism. Step by step, and in spite of the efforts of the emperors at Constantinople, the great imperial officials became landowners, the owners of land—kinsmen or at least associates of these officials—intruded on the imperial administration, while the necessity for providing for the defence of the imperial territories against the Lombards led to the formation of local militias, who at first were attached to the imperial regiments, but gradually became independent. These armed men formed the *exercitus romane militie*, who were the forerunners of the free armed burghers of the Italian cities of the middle ages. The *exercitus* of Rome was divided into *scholae*, and had a chief or *patronus*, and its banner. Other cities of the exarchate were organized on the same model. Diehl is of opinion that the *exercitus* was formed of the ancient "possessores," or landowners and free townsmen, who were of a less rank than the *ordo senatorius*. The great landowners who were developing into feudal lords, and the smaller freemen who were becoming independent burghers, broke the imperial administration to pieces, and prepared the way for the final ruin of the exarchate.

See *Études sur l'administration Byzantine dans l'exarchat de Ravenne* (568-751), by Charles Diehl (Paris, 1888).

RAVENSBURG, a town of Germany, in the kingdom of Württemberg, pleasantly situated amid vine-clad hills on the river Schussen, 12 m. N. of Friedrichshafen on the lake of Constance, by the railway of Ulm. Pop. (1905) 14,614, the great majority of whom are Roman Catholics. Its aspect is medieval; it still retains its walls and nine picturesque towers, the most prominent of which, dating from the 15th century, is known as the "Mehlsack," or sack of flour. The town hall is a handsome 15th-century building. The manufactures include linen, cotton, embroidered muslins, pottery, glass and playing-cards. The fruit market is important, and there is trade in cattle, grain and timber. Ravensburg was founded in the 11th century by the Guelphs, and in their ancestral castle on the Veitsburg, which was partially restored in 1892. The Saxon duke, Henry the Lion, was born. In 1180 the town passed to the Hohenstaufens, and a century later it became a free town of the Empire. In the 15th century it was a flourishing commercial place, its chief industry being the manufacture of paper. Annexed to Bavaria from 1803 to 1810, it was ceded to Württemberg in the latter year.

See Hafner, *Geschichte von Ravensburg* (Ravensburg, 1887).

RAVENSROFT, EDWARD (fl. 1671-1697), English dramatist, belonged to an ancient Flintshire family. He was entered at the Middle Temple, but devoted his attention mainly to literature. Among his pieces are *Mamamouchi, or The Citizen turned Gentleman* (Dorset Garden, 1671, pr. 1675); *The Careless Lovers* (Dorset Garden, 1673, pr. 1673); a comedy

of intrigue; *Scaramouch a Philosopher, Harlequin a Schoolboy, Bravo a Merchant and Magician* (Theatre Royal, 1677); *English Lawyer* (Theatre Royal, 1678), an adaptation of George Ruggle's Latin play of *Ignoramus*, presented before James I. at Cambridge in March 1615; *The London Cuckold* (Dorset Garden, 1683), which became a stock piece, but was struck out of the repertory by Garrick in 1751; and *The Italian Husband* (Lincoln's Inn Fields, 1697). He wrote in all twelve plays, in which he adapted freely from Molière and others, confessing on one occasion that he "but winnowed Shakespeare's corn." He ventured to decry the heroic drama, and Dryden retaliated by satirizing his *Mamamouchi*, a foolish adaptation from Molière's *Bourgeois Gentilhomme* and *Monsieur de Pourceaugnac*, in the prologue to the *Assignment* (Dryden, *Works*, ed. Scott, iv. 345 seq.).

RAVI, a river of India, one of the "Five Rivers" of the Punjab. It rises in the Kulu subdivision of Kangra district, flows through Chamba state, and enters British territory again in Gurdaspur district. At Madhupur the head works of the Bari Doab canal draw off a large portion of its waters. Thence it flows through the plains of the Punjab, passing within a mile of Lahore, and finally falls into the Chenab after a course of about 450 m.

RAVINE, a deep, narrow gorge, cleft or valley in a mountain, worn by the violent rush of water, whence the name, which comes through Fr. from Lat. *rapina*, violent robbery or plunder (*rapere*, to seize). The doublet "ravin" or "raven," robbery, greed, has given place to the more learned form "rapine," but is still seen in "ravenous," greedy, voracious.

RAWALPINDI, a town of British India, which gives its name to a district and a division in the Punjab. The town is situated on the north bank of the little river Leh, 1726 ft. above the sea, 111 m. E. by S. of Peshawar, and 1443 m. N.W. of Calcutta. Pop. (1901) 87,688. It is chiefly notable as the largest military station in India, and the key to the British system of defence upon the North-West Frontier. Railways radiate to Peshawar, Kohat, and the Malakand Pass, and a road runs to the Abbotabad frontier. It is also the starting-point of the cart-road to the hill-station of Murree and of the route into Kashmir. It is protected by a strong chain of forts, connected by the Circular Road. It is the headquarters of the second division of the northern army with a strong force of all arms, and contains an arsenal. Besides the locomotive works of the North-Western railway, there are gas-works, a tent factory, an iron foundry, and a brewery. An annual horse fair is held in April.

The DISTRICT OF RAWALPINDI has an area of 2010 sq. m., Attock having been separated from it and formed into a separate district in 1904. It is situated on the southern slopes of the north-western extremities of the Himalayas, including large mountain tracts with rich valleys traversed by mountain torrents. It contains the Murree hills with the sanatorium of that name, the chief hill-station in the Punjab. The Indus and the Jhelum are the chief rivers, and the climate is noted for its healthiness. The principal crops are wheat, barley, maize, millets, and pulses. The district is traversed by the main line of the North-Western railway, crossing the Indus at Attock, and also by a branch towards the Indus at Kushalgarh. The population in 1901 was 558,699, showing an increase of 4.7% in the decade.

The DIVISION OF RAWALPINDI lies in the north-west of the Punjab. It consists of the five districts of Gujrat, Attock, Shahpur, Jhelum, and Rawalpindi. The total area is 15,736 sq. m. and the population in 1901 was 2,799,360.

RÄWENDIS, a Persian sect that took its name from a town Rāwend near Isfahan. Its origin is unknown, but they held ultra-Shiite doctrines (see SHIITES). Under the year 158 (A.D. 775) Tabarī says that a man of the Rāwendis, called al-Ablaq (because he was leprous), asserted that the spirit that was in Jesus was in 'Alī, then in the imāms one after the other to Ibrahīm ibn Maḥommed, and that thus these were gods. Asad ibn 'Abdallah, then governor of Khorasan, put many of them to

death. Under the year 135 (A.D. 752-3) the historian again mentions a rising of the Rāwendis of Talaqān, and its suppression. Under 141 (A.D. 758-9) he gives a fuller account of them. They believed in metempsychosis, or the transmigration of souls, and asserted that the spirit of Adam was in Othman ibn Nāhik, that the Lord who fed them and gave them drink was Abu Ja'far ul-Manšūr, and that al-Haitham ibn Moawiyā was Gabriel. Accordingly they came to the palace of Manšūr in Hashimīya and began to hail him as Lord. Manšūr, however, secured their chiefs and threw them into prison. By means of a mock funeral they succeeded in reaching the prison and delivering their leaders. They then turned in wrath against Manšūr and almost succeeded in capturing him, but were defeated and slain by al-Haitham. (G. W. T.)

RAWITSCH (Polish *Ravicz*), a town of Germany, in the Prussian province of Posen, lying near the Silesian frontier, 37 m. N. of Breslau, at the junction of railways to Posen and Liegnitz. Pop. (1905) 11,403. It contains a handsome Protestant church and a medieval town hall. The principal industry is the manufacture of snuff and cigars, and for the former it enjoys a considerable reputation. Trade is carried on in grain, wool, cattle, hides, and timber. Rawitsch was founded by Protestant refugees from Silesia during the Thirty Years' War. It passed to Prussia at the second partition of Poland in 1793.

RAWLINSON, GEORGE (1812-1902), English scholar and historian, was born at Chadlington, Oxfordshire, on the 23rd November 1812, being the younger brother of Sir Henry Rawlinson (*q.v.*). Having taken his degree at Oxford (from Trinity College) in 1838, he was elected to a fellowship at Exeter College in 1840, of which from 1842 to 1846 he was fellow and tutor. He was ordained in 1841; was Bampton lecturer in 1859, and Camden professor of ancient history from 1861 to 1889. In 1872 he was appointed canon of Canterbury, and after 1888 he was rector of All Hallows, Lombard Street. In 1873 he was appointed proctor in Convocation for the Chapter of Canterbury. He married Louisa, daughter of Sir R. A. Chermiside, in 1846. His chief publications are his translation of the *History of Herodotus* (in collaboration with Sir Henry Rawlinson and Sir Gardner Wilkinson), 1858-60; *The Five Great Monarchies of the Ancient Eastern World*, 1862-67; *The Sixth Great Oriental Monarchy* (Parthian), 1873; *The Seventh Great Oriental Monarchy* (Sassanian), 1875; *Manual of Ancient History*, 1869; *Historical Illustrations of the Old Testament*, 1871; *The Origin of Nations*, 1877; *History of Ancient Egypt*, 1881; *Egypt and Babylon*, 1885; *History of Phoenicia*, 1889; *Parthia*, 1893; *Memoir of Major-General Sir H. C. Rawlinson*, 1898. He was a contributor to the *Speaker's Commentary*, the *Pulpit Commentary*, Smith's *Dictionary of the Bible*, and various similar publications; and he was the author of the article "Herodotus" in the 9th edition of the *Ency. Brit.* He died on the 7th of October 1902.

RAWLINSON, SIR HENRY CRESWICKE (1810-1895), English soldier and orientalist, was born at Chadlington, Oxfordshire, on the 11th of April 1810. In 1827 he went to India as cadet under the East India Company; and after six years' life with his regiment as subaltern, during which time he had become proficient in the Persian language, he was sent to Persia in company with some other English officers to drill and reorganize the Shah's troops. It was at this time that he was first attracted to the study of inscriptions, more particularly those in the hitherto undeciphered cuneiform character. In the course of the two years during which he was in its immediate neighbourhood he transcribed as much as he was able of the great cuneiform inscription at Behistun (*q.v.*); but the friction between the Persian court and the British government ended in the departure of the British officers.

He was appointed political agent at Kandahar in 1840. In that capacity he served for three years, his political labours being as meritorious as was his gallantry during various engagements in the course of the Afghan War; for these he was rewarded by the distinction of C.B. in 1844. A fortunate chance, by which

he became personally known to the governor-general, led to his being appointed, at his own desire, as political agent in Turkish Arabia; thus he was enabled to settle in Bagdad, where he devoted much time to the cuneiform studies which attracted him. He was now able, under considerable difficulties and with no small personal risk, to make a complete transcript of the Behistun inscription, which he was also successful in deciphering and interpreting. Having collected a large amount of invaluable information on this and kindred topics, in addition to much geographical knowledge gained in the prosecution of various explorations (including visits with Layard to the ruins of Nineveh), he returned to England on leave of absence in 1849. He remained at home for two years, published in 1851 his memoir on the Behistun inscription, and was promoted to the rank of lieutenant-colonel. He disposed of his valuable collection of Babylonian, Sabacan, and Sassanian antiquities to the trustees of the British Museum, who also made him a considerable grant to enable him to carry on the Assyrian and Babylonian excavations initiated by Layard. In 1851 he returned to Bagdad. The excavations were carried on under his direction with valuable results, among the most important being the discovery of material that greatly contributed to the final decipherment and interpretation of the cuneiform character. An accident with which he met in 1855 hastened his determination to return to England, and in that year he resigned his post in the East India Company. On his return to England the distinction of K.C.B. was conferred upon him, and he was appointed a crown director of the East India Company. The remaining forty years of his life were full of activity—political, diplomatic, and scientific—and were mainly spent in London. In 1858 he was appointed a member of the first India Council, but resigned in 1859 on being sent to Persia as envoy extraordinary and minister plenipotentiary. The latter post he held only for a year, owing to his dissatisfaction with circumstances connected with his official position there. Previously he had sat in Parliament as M.P. for Reigate from February to September 1858; he sat again as M.P. for Frome, 1865–68. He was appointed to the Council of India again in 1868, and continued to serve upon it until his death. He was a strong advocate of the forward policy in Afghanistan, and counselled the retention of Kandahar. His views were more particularly expressed in *England and Russia in the East*, 1875. He was a trustee of the British Museum from 1876 till his death. He was created G.C.B. in 1889, and a Baronet in 1891; was president of the Geographical Society from 1874 to 1875, and of the Asiatic Society from 1878 to 1881; and received honorary degrees at Oxford, Cambridge, and Edinburgh. He married, in September 1862, Louisa Caroline Harcourt Seymour, who bore him two sons and died in 1889. He died in London on the 5th of March 1895. His published works include (apart from minor contributions to the publications of learned societies) four volumes of cuneiform inscriptions, published under his direction between 1870 and 1884 by the trustees of the British Museum; *The Persian Cuneiform Inscription at Behistun*, 1846–51, and *Outline of the History of Assyria*, 1852, both reprinted from the Asiatic Society's journals; *A Commentary on the Cuneiform Inscriptions of Babylon and Assyria*, 1850; *Notes on the Early History of Babylonia*, 1854; *England and Russia in the East*, 1875. He contributed to the *Encyclopædia Britannica* (9th edition) the articles on Bagdad, the Euphrates and Kurdistan, and several other articles dealing with the East; and assisted in editing a translation of Herodotus by his brother, Canon George Rawlinson.

See G. Rawlinson, *Memoir of Henry Creswicke Rawlinson* (1898).

RAWLINSON, RICHARD (1690–1755), English antiquary and divine, was a younger son of Sir Thomas Rawlinson (1647–1708), lord mayor of London in 1705–6, and a brother of Thomas Rawlinson (1681–1725), the bibliophile. Born on the 3rd of January 1690, he was educated at St Paul's school, at Eton, and at St John's College, Oxford. In 1716 he was ordained, but as he was a nonjuror and a Jacobite the ceremony was performed by a nonjuring bishop, Jeremy Collier. Rawlinson then

travelled in England and on the continent of Europe, where he passed several years, making collections of manuscripts, coins and curiosities. In 1728 he became a bishop among the non-jurors, but he hardly ever appears to have discharged episcopal functions, preferring to pass his time in collecting books and manuscripts, pictures and curiosities. He died at Islington on the 6th of April 1755. Rawlinson left his manuscripts, his curiosities, and some other property to the Bodleian Library; he endowed a professorship of Anglo-Saxon at Oxford, and was a benefactor to St John's College.

RAWLINSON, SIR ROBERT (1810–1898), English engineer and sanitarian, was born at Bristol on the 28th of February 1810. His father was a mason and builder at Chorley, Lancashire, and he himself began his engineering education by working in a stonemason's yard. In 1831 he obtained employment under Jesse Hartley in the engineer's office at the Liverpool docks, and for four years from 1836 he was engaged under Robert Stephenson as assistant resident engineer for the Blisworth section of what is now the London & North-Western main line from London to the North. Returning to Liverpool, he spent some years as assistant-surveyor to the corporation, and then in 1844 accepted an engineering post on the Bridgewater Canal. Three years later he returned to Liverpool, to superintend the design and construction of the famous brick-arched ceiling in the St George's Hall, in succession to his friend H. L. Elmes. During this period Rawlinson's reputation as a sanitarian had been growing, and when the Public Health Act was passed in 1848 he was appointed one of the first inspectors under it. He inspected many of the chief towns of England, and his reports on the sanitary conditions he found brought him in many cases into great unpopularity with the municipal rulers. Early in 1855 popular feeling was so aroused by the waste of life that was going on among the British troops in the Crimea through disease, and by the mismanagement of the campaign, that the Aberdeen ministry was forced to resign. Lord Palmerston, who then became prime minister, sent a sanitary commission, consisting of Rawlinson and two medical members (Dr John Sutherland and Dr H. Gavin), with full powers from the War Office, to do whatever it thought would lead to better hygienic conditions in camp and hospital. The commission reached Constantinople in March, and, by insisting on what now seem the most obvious precautions, succeeded within a few weeks in reducing the death-rate in the Levantine hospitals from 42 to 2½%. Passing on to the Crimea, it effected a similar improvement there, and by the end of the year the health of the whole British army in the field was even better than it enjoyed at home. Rawlinson's next great public service, for which he was made C.B. in 1865, was in connexion with the distress caused in Lancashire by the collapse of the cotton-manufacturing industry consequent on the American Civil War. In 1863 it was suggested that, in order to provide employment for the starving operatives, the government should start works of "utility, profit and ornament," and Rawlinson being sent to make an official investigation into the question, reported, after visiting nearly 100 towns, that 1½ million sterling might be advantageously expended in providing water-supply and drainage, forming streets, &c., in those places. The result was that the Treasury was authorized to advance £1,200,000 (the amount was afterwards increased) at 3½% for carrying out such works, which proved of enormous public benefit. In 1866 he acted as chairman of the Royal Commission on the Pollution of Rivers, and a few years later was appointed chief engineering inspector to the Local Government Board; on retiring from this position in 1888 he was promoted to be K.C.B. In 1894 he served as president of the Institution of Civil Engineers. He died in London on the 31st of May 1898.

RAWMARSH, an urban district in the Rotherham parliamentary division of the West Riding of Yorkshire, England, 7½ m. N.E. of Sheffield by the Midland railway. Pop. (1891) 11,983; (1901) 14,587. It is situated on the ridge of a hill above the valley of the Don. The church of St Lawrence was rebuilt

in 1839 with the exception of the Norman tower. Rawmarsh has large iron-works, steel rolling-mills and potteries, and there are collieries in the neighbourhood. At the time of the Conquest the manor was granted to Walter d'Eyncourt, and in the 12th century it was divided among the three daughters of his tenant Ralph Paganel, who is supposed to have been the founder of the church.

RAWTENSTALL, a municipal borough in the Rossendale parliamentary division of Lancashire, England, 17½ m. N. by W. from Manchester by the Lancashire & Yorkshire railway. Pop. (1901) 31,053. This town is a modern creation of the cotton industry; at the beginning of the 19th century it was a secluded village in the wild hilly district of Rossendale Forest. The cotton and woollen industries employ the majority of the inhabitants, and there are stone quarries in the neighbourhood. The town was incorporated in 1891, and the corporation consists of a mayor, 6 aldermen and 18 councillors. Area, 9535 acres.

RAY (Lat. *raia*). The rays (*Batoidei*) together with the sharks (*Selachioidei*) form the suborder *Plagiostomi* of Elasmobranch fishes, and are divided into six families (see *ICHTHYOLOGY*).

The first family, *Pristidae*, contains only the saw-fishes (*Pristis*), of which five species are known, from tropical and sub-

tropical seas. They frequent especially estuaries and river-mouths, and in some cases make their way over a hundred miles from the sea. Although saw-fishes possess all the essential characteristics of the rays proper, they retain the elongate form of the body of sharks, the tail being excessively muscular and the sole organ of locomotion. The "saw" (fig. 1) is a flat prolongation of the snout, with an endoskeleton which consists of three to five cartilaginous tubes; these are the rostral processes of the cranial cartilage and are found in all rays, though commonly much shorter. The integument of the saw is hard, covered with shagreen; and a series of strong teeth, sharp in front and flat behind, are embedded in it, in alveolar sockets, on each side. The saw is a formidable weapon of offence, by means of which the fish tears pieces of flesh off the body of its victim, or rips open its abdomen to feed on the intestines. The teeth proper, with which the mouth is armed, are extremely small and obtuse, and unsuitable for wounding or seizing animals. Saw-fishes are abundant in the

specimens with saws 6 ft. long and 1 ft. broad at the base being common.

The rays of the second family, *Rhinobatidae*, bear a strong resemblance to the saw-fishes, but lack the saw. Their teeth are consequently more developed, flat, obtuse, and adapted for crushing hard-shelled marine animals. There are about twenty known species, from tropical and subtropical seas.

The third family, *Torpedinidae*, includes the electric rays. For the peculiar organ (fig. 2) by which the electricity is produced, see *ICHTHYOLOGY*. The fish uses this power voluntarily either to defend itself or to stun or kill the smaller animals on

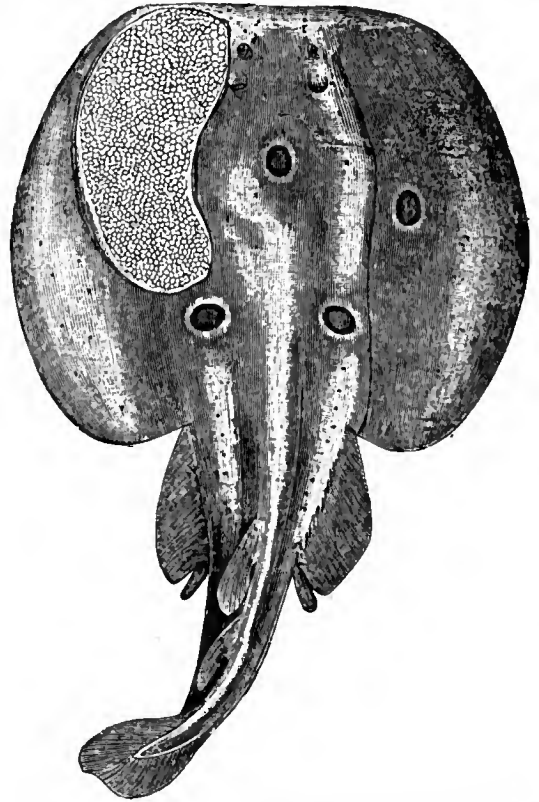

FIG. 2.—*Torpedo narce* (Mediterranean). A portion of the skin on the left side has been removed to show the electric organ.

which it feeds. To receive the shock, the object must complete the galvanic circuit by communicating with the fish at two distinct points, either directly or through the medium of some conducting body. The electric currents created in these fishes exercise all the other known powers of electricity: they render the needle magnetic, decompose chemical compounds and emit the spark. The dorsal surface of the electric organ is positive, the ventral negative. Shocks from a large healthy fish will temporarily paralyse the arms of a strong man. The species of the genus *Torpedo* are distributed over the coasts of the Atlantic, Pacific and Indian Ocean, and at least one reaches the coasts of Great Britain (*T. hebetans*). On the west coast of North America *T. californica* occurs, while on the Atlantic coast there is found the black crampfish (*T. occidentalis*). This latter is said to reach a weight of 200 lb, but such gigantic specimens are scarce, and prefer sandy ground at some distance from the shore, where they are not disturbed by the agitation of the surface-water. Seven genera with about fifteen species have been described, mostly from the warmer seas. All the rays of this family have, like electric fishes generally, a smooth and naked body.

The fourth family, *Raiidae*, comprises the skates and rays proper, or *Raia*. More than thirty species are known, chiefly from the temperate seas of both hemispheres, but much more numerous from the northern than the southern. A few species descend to a depth of nearly 600 fathoms, without, however, essentially differing from their surface congeners. Rays, as is

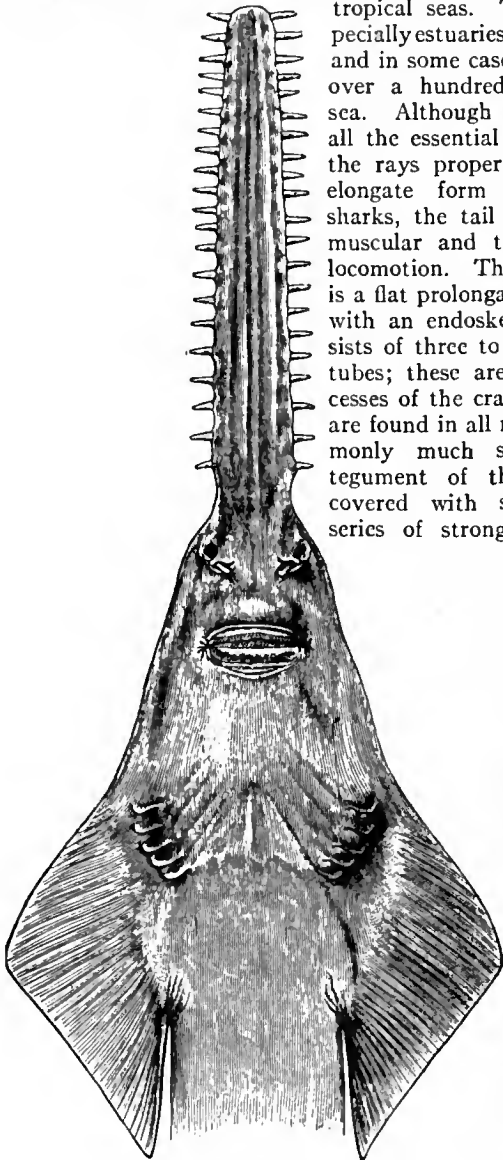

FIG. 1.—*Pristis perrotletii*.

tropics; in their stomachs pieces of intestines and fragments of cuttle-fish have been found. They grow to a large size,

indicated by their shape, are bottom-fishes, living on flat sandy ground, generally at no great distance from the coast or the surface. They lead a sedentary life, progressing, like the flat-fishes, by an undulatory motion of the greatly extended pectoral fins, the thin slender tail having lost the function of an organ of locomotion, and acting merely as a rudder. They are carnivorous and feed exclusively on molluscs, crustaceans and fishes. Some of the species possess a much larger and more pointed snout than the others, and are popularly distinguished as "skates." The following are known as inhabitants of the British seas:—(a) short-snouted species: (1) the thornback (*R. clavata*), (2) the homelyn or spotted ray (*R. maculata*), (3) the starry ray (*R. radiata*), (4) the cuckoo or sandy ray (*R. circularis*); (b) long-snouted species: (5) the common skate (*R. batis*), (6) the flapper skate or jumboskate (*R. macrorhynchus*), (7) the burton skate (*R. alba*), (8) and (9) the shagreen skates (*R. oxyrhynchus* and *R. fullonica*). A few deep-sea species are known, including *R. abyssicola* from 1588 fathoms off the coast of British Columbia. Most of the skates and rays are eaten, except during the breeding season; and even the young of the former are esteemed as food. The skates attain to a much larger size than the rays, viz. to a width of 6 ft. and a weight of 400 and 500 lb.

The members of the fifth family, Trygonidae or sting-rays, are distinguished from the rays proper by having the vertical fins replaced by a strong spine attached to the upper side of the tail. Some fifty species are known, which inhabit tropical more than temperate seas, some species being found in great tropical rivers over 1000 m. from the sea. The spine is barbed on the sides and is a most effective weapon of defence; by lashing the tail in every direction the sting-rays can inflict dangerous or at least extremely painful wounds. The danger arises from the lacerated nature of the wound rather than from any specially poisonous property of the mucus inoculated. Generally only one or two spines are developed. Sting-rays attain to about the same size as the skates and are eaten on the coasts of the Mediterranean and elsewhere. One species (*Trygon pastinaca*) is not rarely found in the North Atlantic and extends northwards to the coasts of Ireland, England and Norway.

The rays of the sixth and last family, Myllobatidae, are popularly known under various names, such as "devil-fishes," "sea-devils" and "eagle-rays." In them the dilatation of the body, or rather the development of the pectoral fins, is carried to an extreme, whilst the tail is very thin and sometimes long like a whip-cord (fig. 3). Caudal spines are generally present and

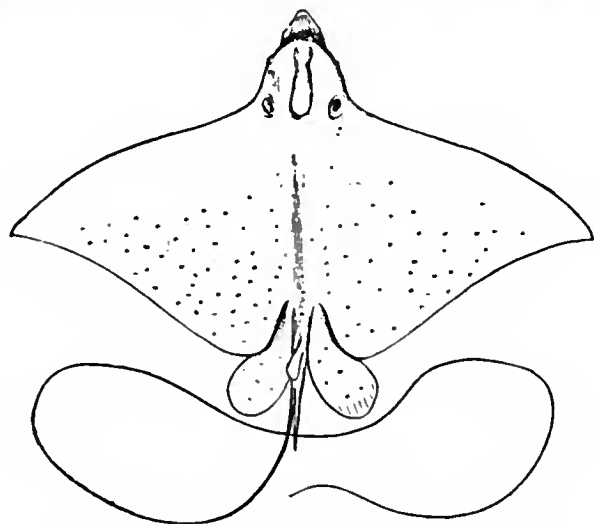

FIG. 3.—*Actobatis narinari* (Indo-Pacific Ocean).

similar to those of the sting-rays. In the enormous "sea-devils," sometimes classed as a separate family (Mobulidae), the anterior part of the pectoral fin is detached and forms a "cephalic" lobe or pair of lobes in front of the snout. The dentition consists of

perfectly flat molars, adapted for crushing hard substances. In some of the eagle-rays the molars are large and tessellated (fig. 4),

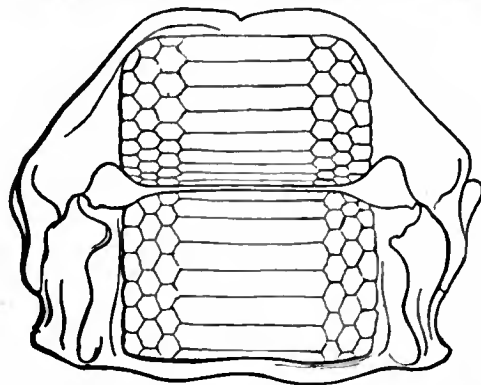

FIG. 4.—Jaws of an Eagle-Ray, *Myliobatis aquila*.

in others extremely small. Of the twenty-seven species which are known, from tropical and temperate seas, the majority attain a very large and some an enormous size: one mentioned by Risso, which was taken at Messina, weighed 1250 lb. A foetus taken from the uterus of the mother (all eagle-rays are viviparous), captured at Jamaica and preserved in the British Museum, is 5 ft. broad and weighed 20 lb. The mother measured 15 ft. in width and as many in length, and was between 3 and 4 ft. thick. At Jamaica, where these rays are well known under the name of "devil-fishes," they are frequently attacked for sport's sake, but their capture is uncertain and sometimes attended with danger. The eagle-ray of the Mediterranean and Atlantic (*Myliobatis aquila*) is occasionally found off the British coasts.

(A. C. G.; J. G. K.)

RAY (or WRAY, as he wrote his name till 1670), JOHN (1628–1705), sometimes called the father of English natural history, was the son of the blacksmith of Black Notley near Braintree in Essex, where he was born on the 29th of November 1628, or, according to other authorities, some months earlier. From Braintree school he was sent at the age of sixteen to Catharine Hall, Cambridge, whence he removed to Trinity College after about one year and three-quarters. His tutor at Trinity was Dr James Duport (1606–1679), regius professor of Greek, and his intimate friend and fellow-pupil the celebrated Isaac Barrow. Ray was chosen minor fellow of Trinity in 1649, and in due course became a major fellow on proceeding to the master's degree. He held many college offices, becoming successively lecturer in Greek (1651), mathematics (1653), and humanity (1655), praelector (1657), junior dean (1657), and college steward (1659 and 1660); and according to the habit of the time, he was accustomed to preach in his college chapel and also at Great St Mary's before the university, long before he took holy orders. Among his sermons preached before his ordination, which was not till the 23rd of December 1660, were the famous discourses on *The Wisdom of God in the Creation*, and on the *Chaos, Deluge and Dissolution of the World*. Ray's reputation was high also as a tutor; and he communicated his own passion for natural history to several pupils, of whom Francis Willughby is by far the most famous.

Ray's quiet college life closed when he found himself unable to subscribe to the Act of Uniformity of 1661, and was obliged to give up his fellowship in 1662, the year after Isaac Newton had entered the college. We are told by Dr Derham in his *Life of Ray* that the reason of his refusal "was not (as some have imagined) his having taken the 'Solemn League and Covenant,' for that he never did, and often declared that he ever thought it an unlawful oath; but he said he could not declare for those that had taken the oath that no obligation lay upon them, but feared there might." From this time onwards he seems to have depended chiefly on the bounty of his pupil Willughby, who made Ray his constant companion while he lived, and at his death left him £60 a year, with the charge of educating his two sons.

In the spring of 1663 Ray started together with Willughby and two other pupils on a tour through Europe, from which he returned in March 1666, parting from Willughby at Montpellier, whence the latter continued his journey into Spain. He had previously in three different journeys (1658, 1661, 1662) travelled through the greater part of Great Britain, and selections from his private notes of these journeys were edited by George Scott in 1760, under the title of *Mr Ray's Itineraries*. Ray himself published an account of his foreign travel in 1673, entitled *Observations topographical, moral, and physiological, made on a Journey through part of the Low Countries, Germany, Italy, and France*. From this tour Ray and Willughby returned laden with collections, on which they meant to base complete systematic descriptions of the animal and vegetable kingdoms. Willughby undertook the former part, but, dying in 1672, left only an ornithology and ichthyology, in themselves vast, for Ray to edit; while the latter used the botanical collections for the groundwork of his *Methodus plantarum nova* (1682), and his great *Historia generalis plantarum* (3 vols., 1686, 1688, 1704). The plants gathered on his British tours had already been described in his *Catalogus plantarum Angliae* (1670), which work is the basis of all later English floras.

In 1667 Ray was elected a fellow of the Royal Society, and in 1669 he published in conjunction with Willughby his first paper in the *Philosophical Transactions* on "Experiments concerning the Motion of Sap in Trees." They demonstrated the ascent of the sap through the wood of the tree, and supposed the sap to "precipitate a kind of white coagulum or jelly, which may be well conceived to be the part which every year between bark and tree turns to wood and of which the leaves and fruits are made." Immediately after his admission into the Royal Society he was induced by Bishop John Wilkins to translate his *Real Character* into Latin, and it seems he actually completed a translation, which, however, remained in manuscript; his *Methodus plantarum nova* was in fact undertaken as a part of Wilkins's great classificatory scheme.

In 1673 Ray married Margaret Oakley of Launton (Oxford); in 1676 he went to Sutton Coldfield, and in 1677 to Falborne Hall in Essex. Finally, in 1679, he removed to Black Notley, where he afterwards remained. His life there was quiet and uneventful, but embittered by bodily weakness and chronic sores. He occupied himself in writing books and in keeping up a wide scientific correspondence, and lived, in spite of his infirmities, to the age of seventy-six, dying at Black Notley on the 17th of January 1705. The Ray Society, for the publication of works on natural history, was founded in his honour in 1844.

Ray's first book, the *Catalogus plantarum circa Cantabrigiam nascentium* (1660, followed by appendices in 1663 and 1685), was written in conjunction with his "amicissimus et individuus comes," John Nid. The plants, 626 in number, are enumerated alphabetically, but a system of classification differing little from Caspar Bauhin's is sketched at the end of the book; and the notes contain many curious references to other parts of natural history. The stations of the plants are minutely described; and Cambridge students still gather some of their rarer plants in the copses or chalk-pits where he found them. The book shows signs of his indebtedness to Joachim Jung of Hamburg, who had died in 1657, leaving his writings unpublished; but a MS. copy of some of them was sent to Ray by Samuel Hartlib in 1660. Jung invented or gave precision to many technical terms which Ray and others at once made use of in their descriptions, and which are now classical; and his notions of what constitutes a specific distinction and what characters are valueless as such seem to have been adopted with little change by Ray. The first two editions of the *Catalogus plantarum Angliae* (1670, 1677) were likewise arranged alphabetically; but in the *Synopsis stirpium Britannicarum* (1690, 1696, also re-edited by Dillenius, 1724, and by Hill, 1760) Ray applied the scheme of classification which he had by that time elaborated in the *Methodus* and the *Historia plantarum*. The *Methodus plantarum nova* (1682) was largely based on the works of Caesalpinus and Jung, and still more on that of Robert Morison of Oxford. The greatest merit of this book is the use of the number of cotyledons as a basis of classification; though it must be remembered that the difference between the monocotyledonous and dicotyledonous embryo was detected by Nehemiah Grew. After dividing plants into flowerless and flowering, Ray says, "Floriferas dividemus in Dicotyledones, quarum semina sata binis foliis anomalis, seminal-

ibus dictis, quae cotyledonorum usum praestant, e terra exeunt, vel in binos saltem lobos dividuntur, quamvis eos supra terram foliorum specie non efferunt; et Monocotyledones, quae nec folia bina seminalia efferunt nec lobos binos conduunt. Haec divisio ad arbores etiam extendi potest; siquidem Palmae et congeneres hoc respectu eodem modo a reliquis arboribus differunt quo Monocotyledones a reliquis herbis." But a serious blemish was his persistent separation of trees from herbs, a distinction whose falsity had been exposed by Jung and others, but to which Ray tried to give scientific foundation by denying the existence of buds in the latter. At this time he based his classification, like Caesalpinus, chiefly upon the fruit, and he distinguished several natural groups, such as the grasses, *Labiatae*, *Umbelliferae* and *Papilionaceae*. The classification of the *Methodus* was extended and improved in the *Historia plantarum*, but was disfigured by a large class of *Anomaliae*, to include forms that the other orders did not easily admit, and by the separation of the cereals from other grasses. This vast book enumerates and describes all the plants known to the author or described by his predecessors, to the number, according to Adanson, of 18,625 species. In the first volume a chapter "De plantis in genere" contains an account of all the anatomical and physiological knowledge of the time regarding plants, with the recent speculations and discoveries of Caesalpinus, Grew, Malpighi and Jung; and Cuvier and Dupetit Thouars, declaring that it was this chapter which gave acceptance and authority to these authors' works, say that "the best monument that could be erected to the memory of Ray would be the republication of this part of his work separately." The *Stirpium Europaeorum extra Britannias nascentium Sylloge* (1694) is a much amplified edition of the catalogue of plants collected on his own European tour. In the preface to this book he first clearly admitted the doctrine of the sexuality of plants, which, however, he had no share in establishing. Here also begins his long controversy with Rivinus (Augustus Quirinus Bachmann) which chiefly turned upon Ray's indefensible separation of ligneous from herbaceous plants, and also upon what he conceived to be the misleading reliance that Rivinus placed on the characters of the corolla. But in the second edition of his *Methodus* (1703) he followed Rivinus and J. P. de Tournefort in taking the flower instead of the fruit as his basis of classification: he was no longer a fructificist but a corollist.

Besides editing his friend Willughby's books, Ray wrote several zoological works of his own, including *Synopsis methodica Animalium Quadrupedum et Serpentinae Generis* (1693), that is to say, both mammals and reptiles, and *Synopsis methodica Avium et Piscium* (1713); the latter was published posthumously, as was also the more important *Historia Insectorum* (1710), which embodied a great mass of Willughby's notes.

Most of Ray's minor works were the outcome of his faculty for carefully amassing facts; for instance, his *Collection of English Proverbs* (1670), his *Collection of Out-of-the-way English Words* (1674), his *Collection of Curious Travels and Voyages* (1693), and his *Dictionarium trilingue* (1675, 5th edition as *Nomenclator classicus*, 1706). The last was written for the use of Willughby's sons, his pupils; it passed through many editions, and is still useful for its careful identifications of plants and animals mentioned by Greek and Latin writers. But Ray's influence and reputation have depended largely upon his two books entitled *The Wisdom of God manifested in the Works of the Creation* (1691), and *Miscellaneous Discourses concerning the Dissolution and Changes of the World* (1692). The latter includes three essays on "The Primitive Chaos and Creation of the World," "The General Deluge, its Causes and Effects," and "The Dissolution of the World and Future Conflagrations." The germ of these works was contained in sermons preached long before in Cambridge. Both books obtained immediate popularity, and the former, at least, was translated into several languages. In *The Wisdom of God, &c.*, Ray recites innumerable examples of the perfection of organic mechanism, the multitude and variety of living creatures, the minuteness and usefulness of their parts, and many, if not most, of the familiar examples of purposive adaptation and design in nature were suggested by him, such as the structure of the eye, the hollowness of the bones, the camel's stomach and the hedgehog's armour.

AUTHORITIES.—*Select Remains, Itineraries and Life*, by Dr Derham, edited by George Scott, 1740; notice by Sir J. E. Smith in Rees's *Cyclopaedia*; notice by Cuvier and A. Dupetit Thouars in the *Biographie universelle*; all these were collected under the title *Memorials of Ray*, and edited (with the addition of a complete catalogue of his works) by Dr Edwin Lankester, 8vo (Ray Society), 1846; *Correspondence* (with Willughby, Martin Lister, Dr Robinson, Petiver, Derham, Sir Hans Sloane and others), edited by Dr Derham, 1718; *Selections*, with additions, edited by Lankester (Ray Society), 1848. For accounts of Ray's system of classification, see Cuvier, *Leçons hist. s. Sci. Nat.*, p. 488; Sprengel, *Gesch. d. Botanik*, ii. p. 40; Sachs, *Gesch. d. Botanik*; also Whewell, *Hist. Ind. Sci.*, iii. p. 332 (ed. 1847), and Wood, art. "Classification" in Rees's *Cyclopaedia*. (D. W. T.)

RAYAH (Arabic *ra'iyah*, peasants, subjects, flock, herd, *ra'a*, to pasture, cf. "ryot," an Indo-Persian variant of the same word), the name given to the non-Moslem subjects of a

Mahommedan ruler; all who pay the *haraj* or poll-tax levied on unbelievers. Five classes of rayahs existed under Turkish rule,—(1) the Greek, or *Roum milleti*; (2) the Armenian, or *Emeni milleti*; (3) the Catholic Armenians—*eremeni gatoliki milleti*; (4) the Latin Christians, or *Roum gatoliki milleti*; and (5) the Jews, or *ichondi milleti*. The name rayah is most commonly used of the peasants, but it does not apply only to the agricultural populations. It depended on status, fixed by religious faith.

RAYLEIGH, JOHN WILLIAM STRUTT, 3rd baron (1842–), English physicist, was born in Essex on the 12th of November 1842, being the son of the 2nd baron.¹ Going to Trinity College, Cambridge, he graduated as senior wrangler in 1865, and obtained the first Smith's prize of the year, the second being gained by Professor Alfred Marshall. He married in 1871 a sister of Mr A. J. Balfour, and succeeded to the title in 1873. From 1879 to 1884 he was Cavendish professor of experimental physics in the university of Cambridge, in succession to Clerk Maxwell; and in 1887 he accepted the post of professor of natural philosophy at the Royal Institution of Great Britain, which he resigned in 1905. His early mathematical and physical papers, written under the name of J. W. Strutt, made him known over Europe; and his powers rapidly matured until, at the death of Clerk Maxwell, he stood at the head of British physicists, Sir George Stokes and Lord Kelvin alone excepted. The special feature of his work is its extreme accuracy and definiteness; he combines the highest mathematical acumen with refinement of experimental skill, so that the idea of ranking him as higher in one department than another does not arise. His experimental investigations are carried out with plain and usually home-made apparatus, the accessories being crude and rough, but the essentials thoughtfully designed so as to compass in the simplest and most perfect manner the special end in view. A great part of his theoretical work consists in resurveying things supposed superficially to be already known, and elaborating their theory into precision and completeness. In this way he has gone over a great portion of the field of physics, and in many cases has either said the last word for the time being, or else started new and fruitful developments. Possessing an immense range of knowledge, he has filled up lacunae in nearly every part of physics, by experiment, by calculation, and by clear accurate thought. The following branches have especially felt his influence:—chemical physics, capillarity and viscosity, theory of gases, flow of liquids, photography, optics, colour vision, wave theory, electric and magnetic problems, electrical measurements, elasticity, sound and hydrodynamics. The numerous scientific memoirs in which his original work is set forth were collected under his own editorship in four large volumes, the last of which was published in 1903. His most extensive single work is a book on *Sound*, which, in the second edition, has become a treatise on vibrations in general. His familiarity with the methods of mathematical analysis and a certain refinement of taste in their application have resulted in great beauty of form. His papers are often difficult to read, but never diffuse or tedious; his mathematical treatment is never needlessly abstruse, for when his analysis is complicated it is only so because the subject-matter is complicated. Of discoveries superficially sensational there are few or none to record, and the weight of his work is for the most part to be appreciated only by professed physicists. One remarkable discovery, however, of general interest, was the outcome of a long series of delicate weighings and minute experimental care in the determination of the relative density of nitrogen gas—undertaken in order to determine the atomic weight of nitrogen—namely, the discovery of argon, the first of a series of new substances, chemically inert, which occur, some only in excessively minute quantities, as constituents of the

¹ The barony was created at George IV.'s coronation in 1821 for the wife of Joseph Holden Strutt, M.P. for Maldon (1790–1826) and Okehampton (1826–1830), who had done great service during the French War as colonel of the Essex militia. He died in 1845, his wife, the baroness, predeceasing him in 1836. Their son (d. 1873) was the 2nd baron.

earth's atmosphere. Lord Rayleigh had an interest in abnormal psychological investigations, and became a member and vice-president of the Society for Psychical Research. He was one of the original members of the Order of Merit, instituted in connexion with the coronation of King Edward VII. In 1904 he was awarded a Nobel prize, and at the end of 1905 he became president of the Royal Society, of which he had been elected a fellow in 1873, and had acted as secretary from 1885 to 1896. He remained president till 1908, in which year he was chosen to succeed the 8th duke of Devonshire as chancellor of Cambridge University.

For a popular but authentic account of some of Lord Rayleigh's scientific work and discoveries, see an article by Sir Oliver Lodge in the *National Review* for September 1898.

RAYMOND, HENRY JARVIS (1820–1869), American journalist, was born near the village of Lima, Livingston county, New York, on the 24th of January 1820. He graduated from the university of Vermont in 1840. After assisting Horace Greeley (*q.v.*) in the conduct of more than one newspaper, Raymond in 1851 formed the firm of Raymond, Jones & Co., and the first issue of the *New York Times* appeared on the 18th of September 1851; of this journal Raymond was editor and chief proprietor until his death. Raymond was a member of the New York Assembly in 1850 and 1851, and in the latter year was speaker. He supported the views of the radical anti-slavery wing of the Whig party in the North. His nomination over Greeley on the Whig ticket for lieutenant-governor in 1854 led to the dissolution of the famous political "firm" of Seward, Weed and Greeley. Raymond was elected, and served in 1854–56. He took a prominent part in the formation of the Republican party, and drafted the famous "Address to the People" adopted by the Republican convention which met in Pittsburg on the 22nd of February 1856. In 1862 he was again a member, and speaker, of the New York Assembly. During the Civil War he supported Lincoln's policy in general, though deprecating his delays, and he was among the first to urge the adoption of a broad and liberal attitude in dealing with the people of the South. In 1865 he was a delegate to the National Republican Convention, and was made a member, and chairman, of the Republican National Committee. He was a member of the National House of Representatives in 1865–67, and on the 22nd of December 1865 he ably attacked Thaddeus Stevens's theory of the "dead" states, and, agreeing with the President, argued that the states were never out of the Union, inasmuch as the ordinances of secession were null. In consequence of this, of his prominence in the Loyalist (or National Union) Convention at Philadelphia in August 1866, and of his authorship of the "Address and Declaration of Principles," issued by the convention, he lost favour with his party. He was removed from the chairmanship of the Republican National Committee in 1866, and in 1867 his nomination as minister to Austria, which he had already refused, was rejected by the Senate. He retired from public life in 1867 and devoted his time to newspaper work until his death in New York city on the 18th of June 1869. Raymond was an able and polished public speaker; one of his best known speeches was a greeting to Kossuth, whose cause he warmly defended. But his great work was in elevating the style and general tone of American journalism. He published several books, including a biography of President Lincoln—*The Life and Public Services of Abraham Lincoln* (1865), which in substance originally appeared as *A History of the Administration of President Lincoln* (1864).

See Augustus Maverick, *Henry J. Raymond and the New York Press for Thirty Years* (Hartford, Conn., 1870); and "Extracts from the Journal of Henry J. Raymond," edited by his son, Henry H. Raymond, in *Scribner's Monthly*, vols. xix. and xx. (New York, 1879–80).

RAYMOND OF SABUNDE, or **SABIENDE** (fl. 1434), Spanish scholar, was a teacher of medicine and philosophy and finally regius professor of theology at Toulouse. His *Liber naturae sive creaturarum, &c.* (written 1434–36), marks an important stage in the history of Natural Theology. The book was directed against the position then generally held, that reason and faith,

philosophy and theology were antithetical and irreconcilable. Raymond declares that the book of Nature and the Bible are both Divine revelations, the one general and immediate, the other specific and mediate. The *Editio Princeps* of the book, which found many imitators, is undated but probably belongs to 1484; there are many subsequent editions, one by J. F. von Seidel as late as 1852. In 1595 the *Prologus* was put on the Index for its declaration that the Bible is the only source of revealed truth. Montaigne (*Essays*, bk. ii. ch. xii., "An Apologie of Raymond Sebond") tells how he translated the book into French and found "the conceits of the author to be excellent, the contexture of his work well followed, and his project full of pietie. . . . His drift is bold, and his scope adventurous, for he undertaketh by humane and naturall reasons, to establish and verifie all the articles of Christian religion against Atheists."

See D. Beulet, *Un Inconnu célèbre: recherches historiques et critiques sur Raymond de Sabunde* (Paris, 1875).

RAYMUND, prince of Antioch (1099-1149), was the son of William VI., count of Poitou. On the death of Bohemund II. of Antioch (*q.v.*), the principality devolved upon his daughter, Constance, a child of some three years of age (1130). Fulk, the king of Jerusalem, and, as such, guardian of Antioch, was concerned to find a husband for her, and sent envoys to England to offer her hand to Raymund, who was then at the court of Henry I. Raymund accepted the offer, and stealing in disguise through southern Italy, for fear of apprehension by Roger of Sicily, who claimed the inheritance of Antioch as cousin of Bohemund I., he reached Antioch in 1135. Here he was married to Constance by the patriarch, but not until he had done him homage and fealty. The marriage excited the indignation of Alice, the mother of Constance, who had been led by the patriarch to think that it was she whom Raymund desired to wed; and the new prince had thus to face the enmity of the princess dowager and her party. In 1137 he had also to face the advent of the eastern emperor, John Comnenus, who had come south partly to recover Cilicia from Leo, the prince of Armenia, but partly, also, to assert his rights over Antioch. Raymund was forced to do homage, and even to promise to cede his principality as soon as he was recompensed by a new fief, which John promised to carve for him in the Mahomedan territory to the east of Antioch. The expedition of 1138, in which Raymund joined with John, and which was to conquer this territory, naturally proved a failure: Raymund was not anxious to help the emperor to acquire new territories, when their acquisition only meant for him the loss of Antioch; and John had to return unsuccessful to Byzantium, after vainly demanding from Raymund the surrender of the citadel of Antioch. There followed a struggle between Raymund and the patriarch. Raymund was annoyed by the homage which he had been forced to pay to the patriarch in 1135; and the dubious validity of the patriarch's election offered a handle for opposition. Eventually Raymund triumphed, and the patriarch was deposed (1139). In 1142 John Comnenus returned to the attack; but Raymund refused to recognize or renew his previous submission; and John, though he ravaged the neighbourhood of Antioch, was unable to effect anything against him. When, however, Raymund demanded from Manuel, who had succeeded John in 1143, the cession of some of the Cilician towns, he found that he had met his match. Manuel forced him to a humiliating visit to Constantinople, during which he renewed his oath of homage and promised to receive a Greek patriarch. The last event of importance in Raymund's life was the visit to Antioch in 1148 of Louis VII. and his wife Eleanor, Raymund's niece. Raymund sought to prevent Louis from going south to Jerusalem, and to induce him to stay in Antioch and help in the conquest of Aleppo and Caesarea. Perhaps for this end he acquired an influence over his niece, which was by some interpreted as a guilty intimacy. At any rate Louis hastily left Antioch, and Raymund was balked in his plans. In 1149 he fell in battle during an expedition against Nureddin. Raymund is described by William of Tyre (the main authority for his career) as handsome and affable; pre-eminent in the use of arms and military experi-

ence; *litteratorum, licet ipse illiteratus esset, cultor* (he caused the *Chanson des chéliefs* to be composed); a regular churchman and a faithful husband; but headstrong, irascible and unreasonable, with too great a passion for gambling (hk. xiv. c. xxi.).

For his career see Rey, in the *Revue de l'orient latin*, vol. iv. (E. BR.)

RAYMUND OF TOULOUSE (sometimes also called Raymund of St Giles, after a town to the south of Nimes), count of Provence, one of the leaders of the first Crusade. According to an Armenian authority, he had lost an eye on a pilgrimage to Jerusalem before the first Crusade; but the statement probably rests on the fact that he was one-eyed, *vir monoculus*. He is also recorded to have fought against the Moors in Spain before 1096; and it is certain that he was the first of the princes of the West to take the cross after Pope Urban's sermon at Clermont. The oldest and the richest of the crusading princes, the count of Provence started, at the end of October 1096, with a large company, which included his wife, his son, and Adhemar, bishop of Puy, the Papal Legate. His march lay by Ragusa and Scutari to Durazzo, whence he struck eastward, along the route also used by Bohemund, to Constantinople. At the end of April 1097 he was with difficulty induced to take a somewhat negative oath of fealty to Alexius; for the obstinacy which was one of his characteristics, coupled perhaps with some hope of acquiring new territories, made him reluctant to submit like the other crusaders to Alexius. He was present at Nicaea and Dorylaeum; but he first showed his hand in October 1097, when, as the army neared Antioch, and a rumour was spread that Antioch had been deserted by the Turks, he sent a detachment in advance to occupy the city—an action which presaged his future difficulties with Bohemund, the would-be prince of Antioch. In the siege of Antioch (which was far from having been deserted) Raymund played his part. When the city was taken by Bohemund (June 1098), the count garrisoned the *palatium Cassiani* (the palace of the emir, Yagi Sian) and the tower over the Bridge Gate. He lay ill during the second siege of Antioch by Kerbogha; but in his camp a great spiritualistic activity culminated in the discovery of the Holy Lance by the Provençals. The miracle stimulated the crusaders to defeat Kerbogha: the Lance itself, discovered by the Provençals and carried henceforward by their count, became a valuable asset in Raymund's favour; and he began to put difficulties in the way of Bohemund's retention of Antioch, obstinately alleging the oath to Alexius, and refusing to surrender the positions in the city which he had occupied. A struggle thus arose between the Provençals and the Normans, partly with regard to the genuineness of the Lance, which the Normans naturally doubted, and partly with regard to the possession of Antioch—the real issue at stake. Raymund was the first of the princes to leave Antioch, moving southward in the autumn of 1098 to the siege of Marra, but leaving a detachment of his troops in Antioch. With Bohemund left behind in Antioch; with the possession of the Holy Lance to give him prestige; and with the wealth which he had at his disposal, the count of Provence now definitely began to figure as the leader of the Crusade. If he could have consented to leave Bohemund in possession of Antioch and push southward, he might have achieved much. But he could not stomach the greatness of Bohemund; and when the Normans turned his troops out of Antioch in January 1099, he marched from Marra (which had been captured in December 1098) into the emirate of Tripoli, and began the siege of Arca (February 1099), evidently with the idea of founding a power in Tripoli which would check the expansion of Bohemund's principality to the south. The siege of Arca was protracted; and the selfish policy of the count, which thus deferred the march to Jerusalem, lost him all support from the mass of the crusaders. A wave of indignation in the ranks, and the inducements which the emir of Tripoli offered to the other princes, forced Raymund to desist from the siege (May 1098), and to march southwards to Jerusalem. After the capture of Jerusalem, Raymund was offered, but refused, the advocacy of the Holy Sepulchre. He alleged his reluctance to rule in the city in which Christ had suffered:

it is perhaps permissible to suspect that he hankered for the principality of Tripoli and the renewal of hostilities with Bohemund. As at Antioch, so at Jerusalem, he fell into strife with the new ruler; and it was only with difficulty that Godfrey was able to secure from him the possession of the Tower of David, which he had originally occupied. The grasping nature of Raymund again appeared after the battle of Ascalon, when his eagerness to occupy Ascalon for himself prevented it from being occupied at all; while Godfrey also blamed him for the failure of his army to capture Arsuf. It almost seems as if the count could not appear without becoming a centre of storms; and when he went north, in the winter of 1099-1100, his first act was one of hostility against Bohemund, from whom he helped to wrest Laodicea. From Laodicea he went to Constantinople, where he fraternized with Alexius, the great enemy of his own enemy Bohemund. Joining in the ill-fated Crusade which followed in the wake of the First, he was successful in escaping from the *débâcle*, and returning to Constantinople. In 1102 he came by sea from Constantinople to Antioch, where he was imprisoned by Tancred, regent of Antioch during the captivity of Bohemund, and only dismissed upon promising not to attempt any conquests in the country between Antioch and Acre. He broke his promise, attacking and capturing Tortosa, and beginning to build a castle for the reduction of Tripoli (on the *Mons Peregrinus*). In this policy he was aided by Alexius, who was naturally willing to see the erection of a tributary county of Tripoli to the south of Bohemund's principality. In 1105 Raymund died. He was succeeded by his nephew William, who in 1109, with the aid of Baldwin I., captured the town and definitely established the county of Tripoli. William was ousted in the same year by Raymund's eldest son Bertrand; and the county continued in the possession of his house during the 12th century.¹

Raymund of Toulouse represents the Provençal element in the first Crusade, as Bohemund represents the Norman, and Godfrey and Baldwin the Lotharingian. Religiosity, obstinacy and greed seem curiously blended in his composition. The first quality appears in the episode of the Lance, and in his renunciation of the advocacy of Jerusalem: the second appears in the whole of his attitude to Bohemund: the third appears again and again, whenever the progress of the Crusades brought any new conquest. If in temperament he is the least attractive among the princes of the first Crusade, he was yet one of its foremost leaders, and he left his mark upon history in the foundation of the county of Tripoli.

Raymund of Agiles, a clerk in the Provençal army, gives the history of the first Crusade from his master's point of view. For a modern account of Count Raymund's part in the crusading movement, one may refer to Röhrich's works (see CRUSADES). (E. BR.)

RAYMUND OF TRIPOLI, the most famous of the descendants of Raymund of Toulouse, was a great-grandson of his eldest son Bertrand: his mother was Hodierna, a daughter of Baldwin II., and through her he was closely connected with the kings of Jerusalem. He became count of Tripoli in 1152, on the assassination of his father. In 1164 he was captured by Nur-eddin, and was only released in 1172 after a captivity of eight years. In 1174 he claimed the regency on behalf of Baldwin IV. (at once a minor and a leper), in virtue of his close relationship; and the claim was acknowledged. After two years the regency seems to have passed to Reginald of Châtillon; but Raymund, who had married the heiress of the county of Tiberias, continued to figure in the affairs of the kingdom. His great ability procured him enemies; for two years, 1180-1182, Baldwin IV. was induced by evil advisers to exclude him from his territories. But as Saladin grew more threatening, Raymund grew more indispensable; and in 1184 he became regent for Baldwin V., on condition that, if the king died before his majority, his successor should be determined by the great powers of the West. Raymund conducted the regency with skill, securing a truce from

Saladin in 1185; but when Baldwin V. died, in 1186, all went wrong. Raymund summoned an assembly of the barons to Naplous to deliberate on the situation; but while they deliberated, the supporters of Guy de Lusignan (the husband of Baldwin IV.'s sister, Sibylla) acted, and had him crowned, in defiance of the stipulation under which Raymund had become regent. The rest of the barons came over to Guy; and Raymund, left in isolation, retired to Tiberias and negotiated a truce for himself with Saladin. His ambiguous position led contemporaries to accuse him of treasonable correspondence with Saladin; but his loyalty to the Christian cause was nobly shown in 1187, when he reconciled himself to Guy, and aided him in the battle of Hattin, which was engaged, however, in the teeth of his earnest advice. He escaped from the battle wounded, and ultimately retired to Tripoli, where he died (1187).

In the corrupt society of the latter days of the kingdom of Jerusalem, Raymund showed himself at least as disinterested as any other man, and certainly more capable than the rest of his contemporaries. He might have saved Jerusalem, if Jerusalem could have been saved; but his was the *vox clamantis in deserto*. "He is worthy of the throne," wrote a contemporary Arabic chronicler: "he seems destined for it by nature, who has given him pre-eminent wisdom and courage." (E. BR.)

RAYNAL, GUILLAUME THOMAS FRANÇOIS (1713-1796), French writer, was born at Saint-Geniez in Rouergue on the 12th of April 1713. He was educated at the Jesuit school of Pézenas, and received priest's orders, but he was dismissed for unexplained reasons from the parish of Saint-Sulpice, Paris, to which he was attached, and thenceforward he devoted himself to society and literature. The Abbé Raynal wrote for the *Mercur de France*, and compiled a series of popular but superficial works, which he published and sold himself. These—*L'Histoire du stathoudéral* (The Hague, 1748), *L'Histoire du parlement d'Angleterre* (London, 1748), *Anecdotes historiques* (Amsterdam, 3 vols., 1753)—gained for him access to the salons of Mme. Geoffrin, Helvétius, and the baron d'Holbach. He had the assistance of various members of the *philosophe* coteries in his most important work, *L'Histoire philosophique et politique des établissements et du commerce des Européens dans les deux Indes* (Amsterdam, 4 vols., 1770). Diderot indeed is credited with a third of this work, which was characterized by Voltaire as "du réchauffé avec de la déclamation." The other chief collaborators were Pechméja, Holbach, Paulze, the farmer-general of taxes, the Abbé Martin, and Alexandre Deleyre. To this piecemeal method of composition, in which narrative alternated with tirades on political and social questions, was added the further disadvantage of the lack of exact information, which, owing to the dearth of documents, could only have been gained by personal investigation. The "philosophic" declamations perhaps constituted its chief interest for the general public, and its significance as a contribution to democratic propaganda. The *Histoire* went through many editions, being revised and augmented from time to time by Raynal; it was translated into the principal European languages, and appeared in various abridgments. Its introduction into France was forbidden in 1779; the book was burned by the public executioner, and an order was given for the arrest of the author, whose name had not appeared in the first edition, but was printed on the title page of the Geneva edition of 1780. Raynal escaped to Spa, and thence to Berlin, where he was coolly received by Frederick the Great, in spite of his connexion with the *philosophe* party. At St Petersburg he met with a more cordial reception from Catherine II., and in 1787 he was permitted to return to France, though not to Paris. He showed generosity in assigning a considerable income to be divided annually among the peasant proprietors of upper Guienne. He was elected by Marseilles to the States-general, but refused to sit on the score of age. Raynal now realized the impossibility of a peaceful revolution, and, in terror of the proceedings for which the writings of himself and his friends had prepared the way, he sent to the Constituent Assembly an address, which was read on the 31st of May 1791, deprecating the violence of its reforms. This address is said

¹ For the future history of the county, see under RAYMUND OF TRIPOLI and BOHEMUND IV.

by Sainte-Beuve (*Nouveaux lundis*, xi.) to have been composed chiefly by Clermont Tonnerre and Pierre V. Malouet, and it was regarded, even by moderate men, as ill-timed. The published *Lettre de l'abbé Raynal à l'Assemblée nationale* (10th Dec. 1790) was really the work of the comte de Guibert. During the Terror Raynal lived in retirement at Passy and at Montlhéry. On the establishment of the Directory in 1795 he became a member of the newly organized Institute of France. He died in the next year on the 6th of March at Chaillot.

A detailed bibliography of his works and of those falsely attributed to him will be found in Quérard's *La France littéraire*, and the same author's *Supercheries dévoilées*. The biography by A. Jay, prefixed to Peuchet's edition (Paris, 10 vols, 1820-1821) of the *Histoire . . . des Indes*, is of small value. To this edition Peuchet added two supplementary volumes on colonial development from 1785 to 1824. See also the anonymous *Raynal démasqué* (1791); Cherhal Montréal, *Éloge . . . de G. T. Raynal* (an. IV.); a notice in the *Moniteur* (5 vendémiaire, an. V.); B. Lunet, *Biographie de l'abbé Raynal* (Rodez, 1866); and J. Morley, *Diderot* (1891).

RAYNALD OF CHÂTILLON (d. 1187), a knight in the service of Constance, princess of Antioch, whom she chose for her husband in 1153, four years after the death of her first husband, Raymund (*q.v.*). One of Raynald's first acts was a brutal assault on the patriarch of Antioch; while two years later he made an unjustifiable attack on Cyprus, in the course of which the island was ravaged. The act brought its punishment in 1159, when he had to humiliate himself before the emperor Manuel, doing homage and promising to accept a Greek patriarch; and when Manuel came to Antioch in the same year, and was visited there by Baldwin III., Raynald led his horse into the city. Later in the year he was captured by the Mahommedans, during a plundering raid against the Syrian and Armenian peasants of the neighbourhood of Marash, and confined at Aleppo. His captivity lasted seventeen years. Released in 1176, he married Stephanie, the widow of Humphrey of Toron, and heiress of Krak and Mont Royal, to the S.E. of the Dead Sea—fortresses which controlled the trade-routes between Egypt and Damascus, and gave him access to the Red Sea. In November 1177, at the head of the army of the kingdom, he won a victory over Saladin, who only escaped with difficulty from the pursuit. But in 1181 the temptation of the caravans which passed by his fortress proved too strong, and in spite of a truce between Saladin and Baldwin IV. he began to plunder. Saladin demanded reparations from Baldwin IV. Baldwin could only reply that he was unable to coerce his unruly vassal. The result was a new outbreak of war between Saladin and the Latin kingdom (1182). In the course of the hostilities Raynald launched ships on the Red Sea, partly for buccaneering, partly, it seems, with the design of attacking Mecca, and of challenging Mahommedanism in its own holy place. His ships were captured by one of Saladin's officers; and at the end of the year Saladin himself attacked Raynald in his fortress of Krak, at a time when a number of guests were assembled to celebrate the marriage of his stepson, Humphrey of Toron. The siege was raised, however, by Count Raymund of Tripoli; and till 1186 Raynald was quiet. In that year he espoused the cause of Sibylla and Guy de Lusignan against Count Raymund, and his influence contributed to the recognition of Guy as king of Jerusalem. His policy at this crisis was not conceived in the best interests of the kingdom; and a step which he took at the end of the year was positively fatal. Hearing of a rich caravan, in which the sister of Saladin was travelling, he swooped down from his fortress upon it. Thus, for the second time, he broke a truce between the kingdom and Saladin. Guy could not extort from him the satisfaction which Saladin demanded: Raynald replied that he was lord in his lands, and that he had no peace with Saladin to respect. Saladin swore that Raynald should perish if ever he took him prisoner; and next year he was able to fulfil his oath. He invaded the kingdom, and, at the battle of Hittin, Raynald along with King Guy and many others fell into his hands. They were brought to his tent; and Saladin, after rebuking Raynald strongly for his treachery, offered him his life if he would become a Mahommedan. He refused, and

Saladin either slew him with his own hands or caused him to be slain (for accounts differ) in the presence of his companions.

The death of Raynald caused him to be regarded as a martyr; his life only shows him to have been a brigand of great capacity. He is the apotheosis of the feudal liberty which the barons of the Holy Land vindicated for themselves; and he shows, in his reckless brigandage, the worst side of their character. Stevenson, *Crusades in the East* (Cambridge, 1907), takes a most favourable view of Raynald's career: cf. especially pp. 240-241. But his whole life seems to indicate a self-willed and selfish temper. (E. BR.)

RAYNAUD'S DISEASE, a malady first described by P. Edouard Raynaud in 1862 in a paper on "Local Asphyxia and Symmetrical Gangrene of the Extremities." The condition is said to be of central nervous origin, and cold, fright, or emotional disturbances are predisposing causes. It is a disease of childhood or early adult life, and females are more frequently affected than males. Raynaud attributed the symptoms to an arrest of the passage of blood to the affected parts, and considered this due to a spasm of the arterioles. If the spasm be sufficiently prolonged and intense to completely close the arterial channels gangrene of the part may be the result.

The local symptoms are divided into three well-marked stages. The first is *local syncope*, in which the affected parts become temporarily bloodless, white, cold, and anaesthetic. The condition is familiar in what is termed a "dead finger," and is usually bilateral. After a variable time the circulation may become restored with a tingling sensation, or the disease may progress to the second stage, that of *local asphyxia*. In this condition some part of the body, usually a finger, toe, or the whole hand or foot, becomes painful to the touch and is noticed to be dusky in colour, or bluish-purple or even mottled, and the surface is cold. This discoloration may deepen until the skin is almost black, the tactile sense being lost. After several hours the pain may subside, the attack of lividity pass off, and warmth return to the skin. Such attacks of local asphyxia may return every day for a time. Sometimes severe abdominal pain is present, accompanied by haematuria. The frequency of haematuria in this connexion was first noticed by Hutchinson in 1871. In the third stage, that of *local gangrene*, the involved areas assume a black and shrivelled appearance, livid streaks marking the course of the arteries; blebs may form containing bloody fluid. The degree of destruction varies from the detachment of a patch of soft tissue down to the loss of even a whole limb, the part becoming separated by a line of demarcation as in senile gangrene.

In Raynaud's disease the patients have been noticed to be very susceptible to cold and low temperatures; every effort should be made to keep the extremities warm; woollen underclothing and stockings should be worn, and the activity of the circulation roused by douches and exercise; by these means an attack may be prevented. Should local asphyxia have taken place, one of the best treatments to lessen pain and obtain the return of the natural colour is the application of the constant current. Sir T. Barlow directs its application, the limb being placed in a bath of warm salt and water. Cushing's method of inducing active hyperaemia has been attended with much success. This treatment is only applicable when the vascular spasm affects the extremities, and consists in the artificial constriction of the limb by the application of a tourniquet or Esmarch's bandage for a few minutes daily. This is followed by hyperaemia and increased surface temperature, and affords much relief to the pain of the stage of asphyxia. Drugs which dilate the peripheral vessels, such as amyl nitrite and trinitrine, have also been recommended. When gangrene occurs in the affected part it should be well wrapped in absorbent cotton and kept dry, and all active treatment should cease until a line of demarcation has formed and the gangrenous portion separated. The disease tends towards recovery with more or less loss of tissue if the stage of gangrene has been reached.

RAYNOUARD, FRANÇOIS JUSTE MARIE (1761-1836), French dramatist and *savant*, was born at Brignoles (Provence), on the 8th of September 1761. He was educated for the bar

and practised at Draguignan. In 1791 he went to Paris as deputy to the Legislative Assembly, but after the fall of the Girondists, to whose party he was attached, he had to go into hiding. He was, however, discovered and imprisoned in Paris. During his imprisonment he wrote his play *Caton d'Utique* (1794). *Eléonore de Bavières* and *Les Templiers* were accepted by the Comédie Française. *Les Templiers* was produced in 1805, and, in spite of the protests of Geoffroy, had a great success. Raynouard was admitted to the Academy in 1807, and from 1817 to 1826 he was perpetual secretary. He wrote other plays, in one of which, *Les États de Blois* (acted 1810), he gave offence to Napoleon by his freedom of speech, but, realizing that the public taste had changed and that the romanticists were to triumph, he abandoned the stage and gave himself up to linguistic studies. He was admitted to the Academy of Inscriptions in 1815. His researches into the Provençal dialect were somewhat inexact, but his enthusiasm and perseverance promoted the study of the subject. His chief works are *Choix de poésies originales des troubadours* (6 vols., 1816-1821), of which the sixth volume, *Grammaire comparée des langues de l'Europe latine dans leurs rapports avec la langue des troubadours* (1821), was separately published; *Lexique roman* (6 vols., 1838-1844). He spent the last years of his life at Passy, where he died on the 27th of October 1836.

RAZGRAD, the capital of the department of Razgrad, Bulgaria, on the river Bieli-Lom, 40 m. S.E. of the Danubian port of Rustchuk by the Varna-Rustchuk railway. Pop. (1906) 13,783, about one-third being Moslems. The railway station is at Inebekchi, 2 m. N. Razgrad possesses a fine mosque, built by Ibrahim Pasha in 1614. Many Turkish families emigrated after the Russo-Turkish War of 1877, but since then the population has again increased, and the town has a thriving agricultural and general trade. Carpet-weaving and viticulture are important local industries. On the 13th of June 1810 and the 14th of August 1877 Razgrad was the scene of battles between the Turks and Russians.

RAZIN, STEPHEN TIMOFEEVICH (d. 1671), Cossack hetman and rebel, whose parentage and date and place of birth are unknown. We first hear of him in 1661 on a diplomatic mission from the Don Cossacks to the Kalmuck Tatars, and in the same year we meet him on a pilgrimage of a thousand miles to the great Solovetsky monastery on the White Sea "for the benefit of his soul." After that all trace of him is lost for six years, when he reappears as the leader of a robber community established at Panshinskoe, among the marshes between the rivers Tishina and Ilovlya, from whence he levied blackmail on all vessels passing up and down the Volga. His first considerable exploit was to destroy the "great water caravan" consisting of the treasury-barges and the barges of the patriarch and the wealthy merchants of Moscow. He then sailed down the Volga with a fleet of thirty-five galleys, capturing the more important forts on his way and devastating the country. At the beginning of 1668 he defeated the voivode Jakov Bezobrazov, sent against him from Astrakhan, and in the spring embarked on a predatory expedition into Persia which lasted for eighteen months. Sailing into the Caspian, he ravaged the Persian coasts from Derbend to Baku, massacred the inhabitants of the great emporium of Resht, and in the spring of 1669 established himself on the isle of Suina, off which, in July, he annihilated a Persian fleet sent against him. Stenka,¹ as he was generally called, had now become a potentate with whom princes did not disdain to treat. In August 1669 he reappeared at Astrakhan, and accepted a fresh offer of pardon from the tsar there; the common people were fascinated by his adventures. The semi-Asiatic kingdom of Astrakhan, where the whole atmosphere was predatory and nine-tenths of the population were nomadic, was the natural milieu for such a rebellion as Stenka Razin's. In 1670 Razin, while ostensibly on his way to report himself at the Cossack headquarters on the Don, openly rebelled against the government, captured Cherkask, Tsaritsyn and other places, and on the 24th of June burst into Astrakhan itself. After massacring

¹ Steevy.

all who opposed him, and giving the rich bazaars of the city over to pillage, he converted Astrakhan into a Cossack republic, dividing the population into thousands, hundreds and tens, with their proper officers, all of whom were appointed by a *vyecha* or general assembly, whose first act was to proclaim Stephen Timofeevich their *gosudar* (sovereign). After a three weeks' carnival of blood and debauchery Razin quitted Astrakhan with two hundred barges full of troops to establish the Cossack republic along the whole length of the Volga, as a preliminary step towards advancing against Moscow. Saratov and Samara were captured, but Simbirsk defied all efforts, and after two bloody encounters close at hand on the banks of the Sviyaga (October 1st and 4th), Razin was ultimately routed and fled down the Volga, leaving the bulk of his followers to be extirpated by the victors. But the rebellion was by no means over. The emissaries of Razin, armed with inflammatory proclamations, had stirred up the inhabitants of the modern governments of Nizhniy-Novgorod, Tambov and Penza, and penetrated even so far as Moscow and Great Novgorod. It was not difficult to revolt the oppressed population by the promise of deliverance from their yoke. Razin proclaimed that his object was to root out the boyars and all officials, to level all ranks and dignities, and establish Cossackdom, with its corollary of absolute equality, throughout Muscovy. Even at the beginning of 1671 the issue of the struggle was doubtful. Eight battles had been fought before the insurrection showed signs of weakening, and it continued for six months after Razin had received his quietus. At Simbirsk his prestige had been shattered. Even his own settlements at Saratov and Samara refused to open their gates to him, and the Don Cossacks, hearing that the patriarch of Moscow had anathematized Stenka, also declared against him. In 1671 he was captured at Kagalnik, his last fortress, and carried to Moscow, where, on the 6th of June, after bravely enduring unspcakable torments, he was quartered alive.

See N. I. Kostomarov, *The Rebellion of Stenka Razin* (Rus.) (2nd ed., Petersburg, 1859); S. M. Solovev, *History of Russia* (Rus.), vol. ii. (Petersburg, 1895, &c.); R. N. Bain, *The First Romanovs* (London, 1905). (R. N. B.)

RAZOR (O.F. *rasor*, mod. *rasoir*, from *raser*, to scrape, or Late Lat. *rasare*, frequentative of *radere*, to scrape), a sharp-edged cutting instrument, used for shaving the hair and beard. The typical razor consists of a blade, usually curving slightly backward, folding into a handle, to which it is fastened by a tang and rivet. The back of the blade is thick and the sides are hollowed or slope to the fine edge (see CUTLERY). In modern times various forms of safety-razor have been invented, in which the blade fits into a fixed handle with a toothed or comb-like shield which protects the face from cutting.

RAZORBILL, or RAZOR-BILLED AUK, known also on many parts of the British coasts as the Marrot, Murre, Scout, Tinker or Willock—names which it, however, shares with the GUILLEMOT (*q.v.*) and to some extent with the PUFFIN (*q.v.*)—a common sea-bird of the North Atlantic,¹ resorting in vast numbers to certain rocky cliffs for the purpose of breeding, and returning to deeper waters for the rest of the year. It is the *Alca torda* of Linnaeus² and most modern authors, congeneric with the GAREFOWL (*q.v.*), if not with the true Guillemots, between which two forms it is intermediate—differing from the former in its small size and retaining the power of flight, which that extinct species had lost, and from the latter in its peculiarly-shaped bill, which is vertically enlarged, compressed, and deeply furrowed, as well as in its elongated, wedge-shaped tail. A fine white line, running

¹ Schlegel (*Mus. des Pays-Bas, Urinatores*, p. 14) records an example from Japan; but this must be in error.

² The word *Alca* is simply the Latinized form of this bird's common Teutonic name, *Alk*, of which Auk is the English modification. It must therefore be held to be the type of the Linnaean genus *Alca*, though some systematists on indefensible grounds have removed it thence, making it the sole member of a genus named by Leach, after Aldrovandus (*Ornithologia*, bk. xix. chap. xlix.), *Utamania*—an extraordinary word, that seems to have originated in some mistake from the no less extraordinary *Vuttamaria*, given by Belon (*Observations*, i. c. xi.) as the Cretan name of some diving bird, which could not have been the present species.

on each side from the base of the culmen to the eye, is in the adult bird in breeding-apparel (with rare exceptions) a further characteristic. Otherwise the appearance of all these birds may be briefly described in the same words—head, breast and upper parts generally of a deep glossy black, and the lower parts and tip of the secondaries of a pure white, while the various changes of plumage dependent on age or season are alike in all. In habits the razorbill closely agrees with the true guillemots, laying its single egg (which is not, however, subject to the same variety of coloration as in the guillemot) on the ledges of cliffs, but it is said as a rule to occupy higher elevations, and when not breeding to keep farther out to sea. On the east side of the Atlantic the Razorbill has its breeding stations from the North Cape to Brittany, besides several in the Baltic, while in winter it passes much farther to the southward, and is sometimes numerous in the Bay of Gibraltar, occasionally entering the Mediterranean, but apparently never extending east of Sicily or Malta. On the west side of the Atlantic it breeds from 70° N. lat. on the eastern shore of Baffin's Bay to Cape Farewell, and again on the coast of America from Labrador and Newfoundland to the Bay of Fundy, while in winter it reaches Long Island. (A. N.)

RAZZIA (an adaptation of the Algerian Arabic *ghāzīah*, from *ghasw*, to make war), a foray or raid made by African Moslems. As used by the Arabs, the word denotes a military expedition against rebels or infidels, and razzias were made largely for punishment of hostile tribes or for the capture of slaves. English writers in the early years of the 19th century used the form *ghrazzie*, and Dixon Denham in his *Travels* (1826) styles the raiding force itself the *ghrazzie*. The modern English form is copied from the French, while the Portuguese variant is *gazia*, *gaziva*.

RE, the Egyptian solar god, one of the most important figures in the Pantheon. See EGYPT, section *Egyptian Religion*.

RÉ, ÎLE DE, an island of western France, belonging to the department of Charente-Inférieure, from the nearest mainland point of which it is distant about 2 m. The island has an area of nearly 33 sq. m., with a breadth varying from 1 to 4½ m. and a length of 15 m. It is separated from the coast of Vendée on the N. by the Pertuis Breton, some 6 m. broad, and from the island of Oléron on the S. by the Pertuis D'Antioche, 7½ m. broad. The coast facing the Atlantic is rocky and inhospitable, but there are numerous harbours on the landward side, of which the busiest is La Flotte. Towards the north-west extremity of the island there is a deep indentation, the Fier d'Ars, which leaves an isthmus only 230 ft. wide, strengthened by a breakwater. The north coast is fringed by dunes and by the salt-marshes which are the chief source of livelihood for the inhabitants. Some of them are employed in fishing, oyster-cultivation and the collection of seaweed for manure; the island has corn-lands and vineyards, the latter covering about half its surface, and produces good figs and pears. Apart from its orchards it is now woodless, though once covered by forests. There are two cantons, St Martin (pop. in 1906, 8362) and Ars-en-Ré (pop. 4711) forming part of the arrondissement of La Rochelle. St Martin, the capital, which has a secure harbour and trade in wine, brandy, salt, &c., was fortified by Vauban in 1681 and used to be the dépôt for convicts on their way to New Caledonia. In 1627 it repulsed an English force after a siege of three months.

READE, CHARLES (1814–1884), English novelist and dramatist, the son of an Oxfordshire squire, was born at Ipsden, Oxfordshire, on the 8th of June 1814. He entered Magdalen College, Oxford, proceeded B.A. in 1835, and became a fellow of his college. He was subsequently dean of arts, and vice-president of Magdalen College, taking his degree of D.C.L. in 1847. His name was entered at Lincoln's Inn in 1836; he was elected Vinerian Fellow in 1842, and was called to the bar in 1843. He kept his fellowship at Magdalen all his life, but after taking his degree he spent the greater part of his time in London. He began his literary career as a dramatist, and it was his own wish that the word "dramatist" should stand first in the description of his occupations on his tombstone. He was dramatist first and novelist afterwards, not merely chrono-

logically but in his aims as an author, always having an eye to stage-effect in scene and situation as well as in dialogue. His first comedy, *The Ladies' Battle*, appeared at the Olympic Theatre in May 1851. It was followed by *Angelo* (1851), *A Village Tale* (1852), *The Lost Husband* (1852), and *Gold* (1853). But Reade's reputation was made by the two-act comedy, *Masks and Faces*, in which he collaborated with Tom Taylor. It was produced in November 1852, and later was expanded into three acts. By the advice of the actress, Laura Seymour, he turned the play into a prose story which appeared in 1853 as *Peg Woffington*. He followed this up in the same year with *Christie Johnstone*, a close study of Scottish fisher folk, an extraordinary *tour de force* for the son of an English squire, whether we consider the dialect or the skill with which he enters into alien habits of thought. In 1854 he produced, in conjunction with Tom Taylor, *Two Loves and a Life*, and *The King's Rival*; and, unaided, *The Courier of Lyons*—well known under its later title, *The Lyons Mail*—and *Peregrine Pickle*. In the next year appeared *Art*, afterwards known as *Nance Oldfield*.

He made his name as a novelist in 1856, when he produced *It's Never Too Late to Mend*, a novel written with the purpose of reforming abuses in prison discipline and the treatment of criminals. He described prison life with a fidelity which becomes at times tedious and revolting; but the power of the descriptions was undeniable, and the interest was profound. The truth of some of his details was challenged, and the novelist defended himself with vigour against attempts to rebut his contentions. Five minor novels followed in quick succession,—*The Course of True Love never did run Smooth* (1857), *Jack of all Trades* (1858), *The Autobiography of a Thief* (1858), *Love Me Little, Love Me Long* (1859), and *White Lies* (1860), dramatized as *The Double Marriage*. Then appeared, in 1861, his masterpiece, *The Cloister and the Hearth*, relating the adventures of the father of Erasmus. He had dealt with the subject two years before in a short story in *Once a Week*, but, seeing its capabilities, expanded it; and the work is now recognized as one of the finest historical novels in existence. Returning from the 15th century to modern English life, he next produced another startling novel with a purpose, *Hard Cash* (1863), in which he strove to direct attention to the abuses of private lunatic asylums. Three more such novels, in two of which at least the moral purpose, though fully kept in view, was not allowed to obstruct the flow of incident, were afterwards undertaken,—*Foul Play* (1869), in which he exposed the iniquities of ship-knackers, and paved the way for the labours of Samuel Plimsoll; *Put Yourself in his Place* (1870), in which he grappled with the tyrannous outrages of trades-unions; and *A Woman-Hater* (1877), in which he exposed the degrading conditions of village life. *The Wandering Heir* (1875), of which he also wrote a version for the stage, was suggested by the Tichborne trial. Outside the line of these moral and occasional works Reade produced three elaborate studies of character,—*Griffith Gaunt* (1866), *A Terrible Temptation* (1871), *A Simpleton* (1873). The first of these was in his own opinion the best of his novels, and his own opinion was probably right. He was wrong, however, in his own conception of his powers as a dramatist. At intervals throughout his literary career he sought to gratify his dramatic ambition, hiring a theatre and engaging a company for the representation of his own plays. An example of his persistency was seen in the case of *Foul Play*. He wrote this in 1869 in combination with Mr Dion Boucicault with a view to stage adaptation. The play was more or less a failure; but he produced another version alone in 1877, under the title of *A Scuttled Ship*, and the failure was pronounced. His greatest success as a dramatist attended his last attempt—*Drink*—an adaptation of Zola's *L'Assommoir*, produced in 1879. In that year his friend Laura Seymour, who had kept house for him since 1854, died. Reade's health failed from that time, and he died on the 11th of April 1884, leaving behind him a completed novel, *A Perilous Secret*, which showed no falling off in the arts of weaving a complicated plot and devising thrilling situations.

Reade was an amateur of the violin, and among his works is an essay on Cremona violins with the title, *A Lost Art Revived*.

It was characteristic of Reade's open and combative nature that he admitted the public freely to the secrets of his method of composition. He spoke about his method in his prefaces; he introduced himself into one of his novels—"Dr Rolfe" in *A Terrible Temptation*; and by his will he left his workshop and his accumulation of materials open for inspection for two years after his death. He had collected an enormous mass of materials for his study of human nature, from personal observation, from newspapers, books of travel, blue-books of commissions of inquiry, from miscellaneous reading. This vast collection was classified and arranged in huge ledgers and notebooks. He had planned a great work on "the wisdom and folly of nations," dealing with social, political and domestic details, and it was chiefly for this that his collection was destined, but in passing he found the materials useful as a store of incidents and suggestions. A collector of the kind was bound to be systematic, otherwise his collection would have fallen into confusion, and Reade's collection contains many curiosities in classification and tabulation. On the value of this method for his art there has been much discussion, the prevalent opinion being that his imagination was overwhelmed and stifled by it. He himself maintained the contrary; and it must be admitted that a priori critics have not rightly understood the use that he made of his laboriously collected facts. He did not merely shovel the contents of his notebooks into his novels; they served rather as an atmosphere of reality in which he worked, so that his novels were like pictures painted in the open air. His imagination worked freely among them and was quickened rather than impeded by their suggestions of things suited to the purpose in hand; and it is probably to his close and constant contact with facts, acting on an imagination naturally fertile, that we owe his marvellous abundance of incident. Even in his novels of character there is no meditative and analytic stagnation; the development of character is shown through a rapid unceasing progression of significant facts. This rapidity of movement was perhaps partly the result of his dramatic studies; it was probably in writing for the stage that he learned the value of keeping the attention of his readers incessantly on the alert. The hankering after stage effect, while it saved him from dullness, often betrayed him into rough exaggeration, especially in his comic scenes. But the gravest defect in his work is a defect of temper. His view of human life, especially of the life of women, is almost brutal; his knowledge of frailties and vices is obtruded with repellent force; and he cannot, with all his skill as a story-teller, be numbered among the great artists who warm the heart and help to improve the conduct. But as a moral satirist, which was the function he professed over and above that of a story-teller, he did good service, both indirectly in his novels and directly in his own name.

See Charles L. Reade and Compton Reade, *Charles Reade, a Memoir* (2 vols., 1887); A. C. Swinburne, *Miscellanies* (1886); and some recollections by John Coleman, *Charles Reade as I knew him* (1903).

READING, a municipal, county and parliamentary borough and the county town of Berkshire, England, 36 m. W. by S. of London by the Great Western railway. Pop. (1901) 72,217. It is an important junction on the Great Western system, and has communication southward by a joint line of the South-Western and South-Eastern and Chatham companies. The Kennet and Avon canal, to Bath and Bristol, and the Thames, afford it extensive connexions by water. It lies in the flat valley of the Thames on the south (right) bank, where the Kennet joins the main river. The population more than doubled in the last thirty years of the 19th century, and the town is of modern appearance. All the ancient churches are much restored and in part rebuilt. Greyfriars church, formerly monastic, was completed early in the 14th century; and after the dissolution of the monasteries served successively as a town hall, a workhouse and a gaol, being restored to its proper use

in 1864. St Mary's is said to have been rebuilt in 1551 from the remains of a nunnery founded by Ælfthryth in expiation of the murder of her stepson Edward the Martyr. St Lawrence's is a large Perpendicular building, and St Giles's, in various styles, was much damaged during the siege of the town in 1643 by the parliamentary forces, and is almost wholly rebuilt. A Benedictine abbey was founded at Reading in 1121 by Henry I., and became one of the richest in England, with a church among the largest in the country. Its founder was buried here, but his monument was destroyed in the time of Edward VI. The church was the scene of John of Gaunt's marriage to Blanche of Lancaster in 1359. By Henry VIII. the abbey was converted into a royal palace, and was so used until its destruction during the civil wars of the 17th century. Little remains of the foundation; only a gateway and a fragment of the great hall, the meeting-place of several parliaments, are of importance. The greater part of the site is occupied by public gardens.

The educational establishments are important. The site of an ancient hospice of St John is occupied by the University Extension College. It was opened in 1892, is affiliated to Oxford University, and has accommodation for 600 students, of both sexes, giving instruction in every main branch of higher university education, agriculture, &c. The grammar school, founded in 1485, occupies modern buildings and ranks among the lesser public schools. Archbishop Laud was educated here, and became a generous benefactor of the school. There are also a blue-coat school (1656), and other charitable schools of early foundation. The municipal museum, besides an art gallery and other exhibits, includes a fine collection of Romano-British relics from Silchester, the famous site not far distant in Hampshire. Besides the public grounds on the site of the abbey there may be mentioned Prospect Park of 131 acres, purchased by the Corporation, and Palmer Park, presented by a member of the firm of Huntley & Palmer, together with extensive recreation grounds.

The industry for which Reading is chiefly famous is the biscuit manufacture, the principal establishment for which is that of Messrs Huntley & Palmer, employing about 5000 hands. In the town and its vicinity are large seed warehouses and testing-grounds. There are also iron foundries, engineering works and factories for agricultural implements, and manufactures of tin boxes, sauces, velvet and silk, and sacking, together with riverside boat-building yards. Reading gives title to a suffragan bishopric in the diocese of Oxford. The parliamentary borough returns one member. The municipal borough is under a mayor, 10 aldermen and 30 councillors. Area, 5876 acres.

Reading (Redinges, Rading, Redding) early became a place of importance. In 871 the Danes encamped here between the Thames and the Kennet, and in 1006 it was burned by Sweyn. It consisted of only thirty houses at the time of the Domesday Survey. There is some reason to think that a fortification existed there before the Conquest, and Stephen probably built a masonry castle which Henry II. destroyed. On the foundation of Reading abbey the town, hitherto demesne of the crown, was granted to the abbey by Henry I. Henceforth, until the 16th century, the chief feature of its history was the struggle as to rights and privileges. This was carried on between the abbey and the merchant gild which claimed to have existed in the time of the Confessor, and the chief officer of which was from the 15th century styled warder or mayor.

A 16th-century account of the gild merchant shows that many trades were then carried on, but Leland says the town "chiefly stoneth by clothing." The story of Thomas Cole, written by Deloney (d. c. 1600) and purporting to refer to the reign of Henry I., indicates that the industry was carried on at an early date. Archbishop Laud was the son of a Reading clothier. By the 17th century the trade was beginning to decline; the bequest of Kendrick "the Phoenix of worthy Benefactors" did little to revive it, and it was greatly injured by the Civil War. In the 18th century the chief trade was in malt. The first town charter is that given by Henry III. (1253) on behalf of the "burgesses in the Gild Merchant," which was confirmed and

amplified by succeeding sovereigns. The governing charter until 1835 was that of Charles I. (1639) incorporating the town under the title of the mayor, aldermen and burgesses. Reading returned two members to parliament from 1295 to 1885, when it was deprived of one; until 1832 the Scot-and-Lot franchise was used. The town surrendered to the parliamentary troops, after a siege, in 1643; it was occupied subsequently by the forces of both parties: in 1688 a skirmish took place in the town between some Irish soldiers of James II. and the troops of William of Orange. The market, chiefly held on Saturday, can be traced to the reign of Henry III.; four fairs granted by the charter of 1562 are still held, that on the 25th of July dating originally from a grant of Henry II. to Reading abbey.

See C. Coates, *History of Reading* (1806); *Victoria County History, Berks.*

READING, a city and the county-seat of Berks county, Pennsylvania, U.S.A., in the S.E. part of the state, on the E. bank of the Schuylkill river, and about 58 m. N.W. of Philadelphia. Pop. (1880) 43,278; (1890) 58,661; (1900) 78,961, of whom 5940 were foreign-born; (1910, census) 96,071. Reading is served by the Pennsylvania and the Philadelphia & Reading railways, by the Schuylkill Canal, which carries freight to Philadelphia, and by electric railways to several villages in Berks county. The city occupies an irregular tract of land gradually descending from the base of Mt. Penn westward to the Schuylkill river, and therefore possesses excellent drainage facilities. The river, which is unnavigable and winding at this point, forms the western boundary of the city for more than 4 m., and is spanned by three public bridges and a number of railway bridges. Neversink Mountain (878 ft. high), lying to the S. of the city, and Mt. Penn (800 ft.), are pleasure resorts in the neighbourhood. On the neighbouring mountains are several summer hotels and sanatoria. Within the city is Penn Common, containing 50 acres, reserved by the Penns for the use of the town when it was first laid out, and since 1878 used as a public park. Mineral Spring Park, containing 63 acres, lies on the outskirts of the city. Other parks are maintained by the street railway companies. In Penn Common are a monument erected to the "First Defenders," to commemorate the fact that the "Ringgold Light Infantry," the first volunteer company to report at Washington for service in the Civil War, came from this city; a monument to President McKinley, and one to the volunteer fire companies of the city. Among interesting landmarks are the Federal Inn (1763), in which President Washington was entertained in 1794, and which has been used as a banking house since 1814; the old county gaol (1770), used as such until 1848; and the site of the "Hessian Camp," where some of the prisoners captured during the War of Independence were confined. Charitable institutions are numerous; among them are the Reading Hospital (1867), St Joseph's Hospital (1873), Homoeopathic Hospital (1891), the Home for Widows and Single Women (1875), the Hope Rescue Mission (1897) for homeless men, the Home for Friendless Children (1888), St Catharine's Female Orphan Asylum (1872), St Paul's Orphan Asylum for Boys, and the House of the Good Shepherd (1889). Other institutions are the public library, which from 1808 to 1898 was a subscription library; the Berks County Law Library; the Berks County Historical Society; and the Harmonie Maennerchor, organized in 1847 and one of the oldest singing societies in the United States.

Lying within the rich agricultural region of the Lebanon and Schuylkill valleys and near vast fields of anthracite coal and iron ore, Reading possesses unusual business and industrial advantages. The chief industry is the manufacture of iron and steel. There are large shops of the Philadelphia & Reading railway here. The total value of factory products in 1905 was \$30,848,175 (in 1900 it had been \$32,682,061), and the most important of these were the products of steel-works and rolling-mills; the products of railway repair shops; foundry and machine-shop products; hardware, hosiery and knitted goods; cigars and cigarettes, and felt hats. Other

important manufactures are bicycles, brick and other clay products, brooms, brushes, and cotton and woollen goods.

Reading was surveyed and laid out as a town in 1748, in accordance with the plans of Thomas and Richard Penn, sons of William Penn, and was named Reading after the county town of Berkshire, England. The first settlers were mostly Germans, but the direction of municipal affairs until the outbreak of the War of Independence was in the hands of the English-speaking inhabitants. As the latter were largely of Loyalist sympathies during the war, the control of the local government then fell into the hands of the German inhabitants. German was long used in Reading; Pennsylvania German (or "Dutch") is still spoken in the surrounding country; and several German periodicals are published in the city, including among them the weekly *Adler* since 1796. During the War of Independence Reading was an inland depôt for supplies for the American army, and prisoners of war were sent here in large numbers. The development of the town dates from the opening in 1824 of the Schuylkill Canal, from Reading to Philadelphia. This was followed in 1828 by the Union Canal, running westward to Lebanon and Middletown, and in 1838 by the entrance into Reading of the Philadelphia & Reading railway. The establishment of these means of communication hastened the development of the natural resources of the region, and Reading early became an industrial centre. A system of water-works, established in 1821, was acquired by the municipality in 1865. Reading was incorporated as a borough in 1783, and was chartered as a city in 1847.

See M. L. Montgomery, *History of Reading, Pennsylvania, and the Anniversary Proceedings of the Sesqui-Centennial* (Reading, 1898).

READING BEDS, in geology, a series of marine and estuarine beds consisting of variegated plastic clays and bright-coloured sands, which form, with the Woolwich beds, a subdivision of the Lower Eocene (see WOOLWICH AND READING BEDS).

READYMONEY, SIR COWASJI JEHANGIR (1812-1878), "the Peabody of Bombay." Early in the 18th century three Parsee brothers moved from Nowsari, near Surat, in Gujarat, to Bombay, and became the pioneers of a lucrative trade with China. They gained the sobriquet of "Readymoney," which they adopted as a surname. Only Hirji Jewanji Readymoney left issue, two daughters, the elder of whom married a Banaji, and the younger a Dady Sett. The son of the former, Jehangir Hirji, married Mirbae, the daughter of the latter, and was made the heir not only of his grandfather, but of his two granduncles. The younger of their two sons was Cowasji Jehangir. His only English education was at the then well-known school kept by Serjeant Sykes in the Fort of Bombay. At the age of 15 he entered the firm of Duncan, Gibb & Co. as "godown keeper," or warehouse clerk. In 1837 he was promoted to the responsible and lucrative appointment of "guarantee broker" to two of the leading European firms of Bombay. In 1846 he was able to begin trading on his own account. He was made a J.P. for the town and island of Bombay, and a member of the board of conservancy; and in 1866 was appointed a commissioner of income tax, his tactful management being largely responsible for the fact that this tax, then new to Bombay and unpopular, was levied with unexpected financial success. He was made C.S.I. in 1871; and in 1872 he was created a Knight Bachelor of the United Kingdom, and his statue, by T. Woolner, R. A., was erected in the town hall. His donations to the institutions of Bombay amounted to close on £200,000. His health broke down in 1871, and he died in 1878, being succeeded by his son, Sir J. Cowasji Jehangir [Readymoney], who was created a Knight Bachelor in 1895, and a Baronet in 1908.

See J. Cowasji Jehangir, *Sir Cowasji Jehangir Readymoney* (1890). (M. M. BU.)

REAGAN, JOHN HENNINGER (1818-1905), American politician, was born in Sevier county, Tennessee, on the 8th of October 1818. He removed to Texas in 1839, was deputy surveyor of public lands in 1839-1843, was admitted to the bar in 1846, was a member of the state House of Representatives

in 1847-1848, served as district judge in 1852-1857, and in 1857-1861 was a representative in Congress. His political views were determined by the ultra-democratic influence of Andrew Jackson and the state-sovereignty philosophy of John C. Calhoun. In 1861 he was a member of the Texas secession convention, served in the Confederate provisional Congress, and on the 6th of March was appointed postmaster-general in President Davis's cabinet. He served in this capacity throughout the war, and for a short time before its close was also acting secretary of the treasury. He was captured with the Davis party on the 10th of May 1865, and was imprisoned in Fort Warren, Boston Harbour, until the following October. While in prison he wrote the "Fort Warren letter" (August 11th), in which he urged the people of Texas to recognize their defeat, grant civil rights to the freedmen, and try to conciliate the North. From 1875 to 1887, when he entered the U.S. Senate, he was again a representative in Congress, and from 1877 almost continuously to the close of his service he was chairman of the Committee on Commerce, in which capacity he had a prominent part in securing the passage of the Interstate Commerce Act of 1887. He was a member of the state constitutional convention of 1876. In state politics his sympathies were with the Radicals. In 1891, believing that his first duty was to his state, he resigned from the Senate to accept the chairmanship of the newly established state railway commission. In 1901 he retired from public service. From 1899 until his death he was president of the Texas State Historical Association. He died at his home, near Palestine, Texas, on the 6th of March 1905.

See his *Memoirs; with Special Reference to Secession and the Civil War* (New York, 1906), edited by W. F. McCaleb.

REALGAR, a mineral species consisting of arsenic monosulphide (AsS) and occurring as monoclinic crystals of a bright red colour. There is a perfect cleavage parallel to the plane of symmetry (*r* in fig.). The lustre is resinous, and the streak

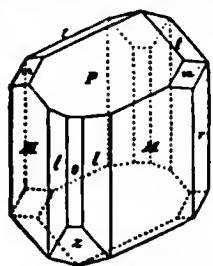

has the same colour as the crystals, namely, orange-red to aurora-red. The hardness is $1\frac{1}{2}$ -2 and the specific gravity 3.55. On exposure to light the crystals crumble to a yellow powder. The name realgar is of Arabic origin, and was used by the alchemists; the substance was known to Theophrastus under the name *Σανδαράκη*, and to Pliny as *Sandaracha*. The mineral usually occurs in association with the yellow arsenic sulphide, orpiment.

Good crystals are found with ores of silver and lead in the mineral veins of Felsőbánya, near Nagy-Bánya, Kapnik-Bánya and Nagyág, near Déva, in Hungary; with blende in the white crystalline dolomite of the Binnenthal in Switzerland; and in a bed of sandy clay at Mercur in Utah. It is deposited by the solfataras near Naples and by the hot springs of the Yellowstone National Park. Realgar has been used as a pigment and in pyrotechny for producing a brilliant white fire; but it is now replaced by the artificially prepared compound.

The other native arsenic sulphide, As₂S₃, known as orpiment (Lat. *auripigmentum*, meaning "golden paint"), occurs as foliated masses of a lemon-yellow colour, the foliation being parallel to a direction of perfect cleavage. It is sectile and soft (H. = $1\frac{1}{2}$ -2), and has a specific gravity 3.4. Distinctly developed crystals are rare; they have usually been considered to be orthorhombic and isomorphous with stibnite (Sb₂S₃), but it is probable that they are really monoclinic. Orpiment is extensively mined near Julamerk in Asiatic Turkey. (L. J. S.)

REALISM (from Low Lat. *realis*, appertaining to *res*, things, as opposed to ideas and imaginations), a philosophical term used in two opposite senses. The older of these is the scholastic doctrine, traceable back to Socrates, that universals have a more "real" existence than things. Universals are, in scholastic language, *ante res*, *in rebus* and *post res*. Behind all numerous types of chairs there is in the mind the ideal chair of which particular chairs are mere copies. In the most extreme form realism denies that anything exists in any sense except

universals. It is opposed to nominalism (*q.v.*) and conceptualism (*q.v.*). For the history of the doctrine, see SCHOLASTICISM. Realism in this sense has been called "an assertion of the rights of the subject" (cf. the Protagorean maxim, "Man is the measure of all things"). The modern application of the term is to the opposing doctrine that there is a reality apart from its presentation to consciousness. In this sense it is opposed to idealism (*q.v.*), whether the purely subjective or that more comprehensive idealism which makes subject and object mutually interdependent. In its crude form it is known as "Natural" or "Naive" Realism. It appears, however, in more complex forms, e.g. as Ideal Realism (or Real Idealism), which combines epistemological idealism with realism in metaphysics. Again, Kant distinguishes "empirical" realism, which maintains the existence of things in space independent of consciousness, from "transcendental" realism, which ascribes absolute reality to time and space.

In literature and art "realism" again is opposed to "idealism" in various senses. The realist is (1) he who deliberately declines to select his subjects from the beautiful or harmonious, and, more especially, describes ugly things and brings out details of an unsavoury sort; (2) he who deals with individuals, not types; (3) most properly, he who strives to represent the facts exactly as they are.

REALM, the dominions of a king, a kingdom. The O.Fr. *reaume* (mod. *royaume*) was the form first adopted in English, and the modern spelling does not appear fixed till the beginning of the 17th century. The word must be referred to a supposed Med. Lat. *regalimen*, from *regalis*, of or belonging to a *rex*, king.

REAL PROPERTY. The land law of England and of countries whose law is based upon that of England stands in a peculiar position, which can be understood only by an outline of its history.

History.—Such terms as "fee" or "homage" carry us back into feudal times. Rights of common and distress are based upon still older institutions, forming the very basis of primitive law. The conception of tenure is the fundamental ground of distinction between real and personal estate, the former only being strictly entitled to the name of estate (*q.v.*). The division into real and personal is coincident to a great extent with that into immovable and movable, generally used by systems of law founded on the Roman (see PERSONAL PROPERTY.) That it is not entirely coincident is due to the influence of the Roman law itself. The Greeks and the Romans of the republic were essentially nations of citizens; the Teutons were essentially a nation of land-folk; the Roman empire bridged the gulf between the two. It is probable that the English land law was produced by the action of the policy adopted in the lower empire, finally developed into feudalism, upon the previously existing course of Teutonic custom. The distinguishing features of the Teutonic system were enjoyment in common and the absence of private ownership, except to a limited extent. The principal features of the old English land law before the Conquest, from which the modern law has developed, were (1) liberty of alienation, either by will or *inter vivos*, of such land as could be alienated, chiefly, if not entirely, bockland, subject always to the limits fixed by the *hoc*; (2) publicity of transfer by enrolment in the shire-book or church-book; (3) equal partition of the estate of a deceased among the sons, and failing sons among the daughters; (4) cultivation to a great extent by persons in various degrees of serfdom, owing money or labour rents; (5) variety of custom, tending to become uniform, through the application of the same principles in the local courts; (6) subjection of land to the *trinoda necessitas*, a burden imposed for the purpose of defence of the realm. The rudiments of the conceptions of tenure and of the crown as lord paramount were found in the old English system, and *lænland* was an anticipation of the limited interests which afterwards became of such importance.¹ The connexion of political privileges with the ownership

¹ The name has not remained as in Germany and Denmark. A fief is still *Lehen* in Germany, *Lehn* in Denmark.

of land is not peculiar to the pre-Conquest or any other period. It runs through the whole of English history.

The elements of feudalism so far existed in England under the Anglo-Saxon and Danish kings as to make it easy to introduce it in full at the Norman Conquest. What the Norman Conquest did was not to change all at once allodial into feudal tenure, but to complete the association of territorial with personal dependence in a state of society already prepared for it.¹ "Nulle terre sans seigneur" was one of the fundamental axioms of feudalism. There might be any number of infeudations and subinfeudations to mesne lords, but the chain of seignory was complete, depending in the last resort upon the king as lord paramount. Land was not owned by free owners owing only necessary militia duties to the state, but was held of the king by military service of a more onerous nature. The folkland became the king's land; the soldier was a landowner instead of the landowner being a soldier. Free owners tended to become tenants of the lord, the township to be lost in the manor.² The common land became in law the waste of the manor, its enjoyment resting upon a presumed grant by the lord. On the other hand, the whole of England did not become manorial; the conflict between the township and the manor resulted in a compromise, the result of which affects English tenure to this day. But it was a compromise much to the advantage of the privileged class, for in England more than in any other country the land law is the law of the nobility and not of the people. One reason of this is that, as England was never so completely feudalized as were some of the European continental states, the burden of feudalism was not so severely felt, and has led to less agitation for reform.

The land forfeited to the Conqueror was regranted by him to be held by military service due to the king, not to the mesne lord as in European continental feudalism. In 1086 at the council of Salisbury all the landholders swore fealty to the crown. In the full vigour of feudalism the inhabitants of England were either free or not free. The free inhabitants held their lands either by free tenure (*liberum tenementum*, franktenement) or by a tenure which was originally that of a non-free inhabitant, but attached to land in the possession of a free man. Franktenement was either military tenure, called also tenure in knight service or chivalry (including barony, the highest tenure known to the law, grand serjeanty and the special forms of escuage, castle-guard, cornage and others) or socage (including burgage and petit serjeanty), or frankalmoign (*libera elemosyna*) or divine service, by which ecclesiastical corporations generally held their land.³ The non-free inhabitants were in Domesday Book *servi*, *cotarii* or *bordarii*, later *nativi* or *villani*, the last name being applied to both free men and serfs. All these were in a more or less dependent condition. The free tenures all exist at the present day, though, as will appear later, the military tenures have shrunk into the unimportant and exceptional tenure of grand serjeanty. The non-free tenures are to a certain extent represented by copyhold. The most important difference between the military and socage tenures was the mode of descent. Whether or not a feudal benefice was originally hereditary, it had certainly become so at the time of the Conquest, and it descended to the eldest son. This applied at once in England to land held by military service as far as regarded the capital fief. The descent of socage lands or lands other than the capital fief for some time followed the old pre-Conquest rule of descent. Thus in the so-called "Laws of Henry I." the lands other than the capital fief, and in Glanvill, who wrote in the time of Henry II., socage lands, if anciently partible (*antiquitus divisum*), were divided among all the sons equally. But by the time of Bracton (Henry III.) the course of descent of lands held by military service had so far

prevailed that, though it was a question of fact whether the land was partible or not, if there was no evidence either way descent to the eldest son was presumed. Relics of the old custom still remain in the case of gavelkind. The military tenant was subject to the feudal incidents, from which the tenant in socage was exempt. These incidents, especially wardship and marriage, were often oppressive. Alienation of lands by will, except in a few favoured districts, became impossible; alienation *inter vivos* was restrained in one direction in the interests of the heir, in another in the interests of the lord. At the time of Glanvill a tenant had a greater power of alienation over land which he had purchased (*terra acquietata*) than over land which he had inherited. But by the time of Bracton the heir had ceased to have any interest in either kind of land. The lords were more successful. It was enacted by Magna Carta that a free man should not give or sell so much of his land as to leave an amount insufficient to perform his services to his lord. In spite of this provision, the rights of the lords were continually diminished by subinfeudation until the passing of the Statute of *Quia Emptores*. Alienation by a tenant in chief of the crown without licence was a ground of forfeiture until 1 Edw. III. st. 2, c. 12, by which a fine was substituted. The modes of conveyance at this time were only two, feoffment with livery of seisin for corporeal hereditaments, grant for incorporeal hereditaments. Livery of seisin, though public, was not officially recorded like the old English transfer of property. The influence of local custom upon the land law must have become weakened after the circuits of the judges of the King's Court were established by Henry II. Jurisdiction over litigation touching the freehold was taken away from the lord's courts by 15 Ric. II. c. 12.

The common law as far as it dealt with real estate had in the main assumed its present aspect by the reign of Henry III. The changes which have been made since that date have been chiefly due to the action of equity and legislation, the latter sometimes interpreted by the courts in a manner very different from the intention of parliament. The most important influence of equity has been exercised in mortgage and trusts in the doctrine of specific performance of contracts concerning real estate, and in relief from forfeiture for breach of covenant.

History of Real Estate Legislation.—The reign of Edward I. is notable for three leading statutes, all passed in the interests of the superior lords. The Statute of Mortmain (7 Edw. I. st. 2, c. 13) is the first of a long series directed against the acquisition of land by religious and charitable corporations. The statute *De Donis Conditionalibus* (13 Edw. I. c. 1) forbade the alienation of estates granted to a man and the heirs of his body, which before the statute became on the birth of an heir at once alienable (except in the case of gifts in frankmarriage), and so the lord lost his escheat. The statute *Quia Emptores* (18 Edw. I. c. 1) preserved those rights of the lords which were up to that time subject to be defeated by subinfeudation, by enacting that in any alienation of lands the alienee should hold them of the same lord of the fee as the alienor.⁴ Since 1290 it has been impossible to create an estate in fee-simple to be held of a mesne lord, or to reserve a rent upon a grant of an estate in fee (unless in the form of a rent-charge), or to create a new manor. The statute, however, does not bind the crown. The practical effect of the statute was to make the transfer of land thenceforward more of a commercial and less of a feudal transaction. The writ of *elegit* was introduced by the Statute of Westminster II. in 1285 as a creditor's remedy over real estate. It has, however, been considerably modified by subsequent legislation. From 1290 to the reign of Henry VIII., there is no statute of the first importance dealing with real estate. The reign of Henry VIII., like the reign of Edward I., is signalized by three acts, the effects of which continue to this day. The one which has had the most lasting influence in law is the Statute of Uses, 27 Hen. VIII. c. 10 (see CONVEYANCING; TRUST). The Statute of Uses was intended to provide against secrecy of sales of land, and as a necessary sequel to it an act of the same

⁴ Tenants in chief of the crown were liable to a fine on alienation until 12 Car. II. c. 24.

¹ "The relation of vassalage, originally personal, became annexed to the tenure of land" (Palgrave, *Rise and Progress of the English Commonwealth*, vol. i. p. 505).

² It is a disputed point whether the manor organization existed before the Conquest; but its full development seems to have been later than that event.

³ Frankalmoign was not always regarded as a distinct tenure. Thus Littleton (§ 118) says that all that is not tenure in chivalry is tenure in socage.

year (27 Hen. VIII. c. 16) enacted that all bargains and sales of land should be duly enrolled. Bargain and sale was a form of equitable transfer which had for some purposes superseded the common law feoffment. It applied only to estates of inheritance and not to terms of years. The unforeseen effect of 27 Hen. VIII. c. 16 was to establish as the ordinary form of conveyance until 1841 the conveyance by lease and release.¹ Uses having become legal estate by the Statute of Uses, and therefore no longer devisable, 32 Hen. VIII. c. 1 (explained by 34 & 35 Hen. VIII. c. 5) was passed to remedy this inconvenience. It is still law as to wills made before 1838 (see WILL). In the reign of Elizabeth the acts of 13 Eliz. c. 5 and 27 Eliz. c. 4 avoided fraudulent conveyances as against all parties and voluntary conveyances as against subsequent purchasers for valuable consideration. Early in the reign of Charles II. the act of 1661 (12 Car. II. c. 24) turned all the feudal tenures (with the exception of frankalmoign and grand serjeanty) into tenure by free and common socage and abolished the feudal incidents. The Statute of Frauds (29 Car. II. c. 3) contained provisions that certain leases and assignments, and that all agreements and trusts relating to land, should be in writing (see FRAUD). The land registries of Middlesex and Yorkshire date from the reign of Anne (see LAND REGISTRATION). Devises of land for charitable purposes were forbidden by the Mortmain Act (9 Geo. II. c. 36). In the next reign the first general Inclosure Act was passed, 41 Geo. III. c. 109 (see COMMONS). In the reign of William IV. were passed the Prescription, Limitation and Tithe Commutation Acts; fines and recoveries were abolished and simpler modes of conveyance substituted by 3 & 4 Will. IV. c. 74; and the laws of inheritance and dower were amended by 3 & 4 Will. IV. cc. 105, 106. In the reign of Victoria there was a vast mass of legislation dealing with real estate in almost every conceivable aspect. At the immediate beginning of the reign stands the Wills Act. The transfer of real estate was simplified by 8 & 9 Vict. c. 106 and by the Conveyancing Acts of 1881 and 1882. Additional powers of dealing with settled estates were given by the Settled Estates Act 1856, later by the Settled Estates Act 1877, and the Settled Land Act 1882. Succession duty was levied for the first time on freeholds in 1853. The strictness of the Mortmain Act has been relaxed in favour of gifts and sales to public institutions of various kinds, such as schools, parks and museums. The period of limitation was shortened for most purposes from twenty to twelve years by the Real Property Limitation Act 1874. Several acts were passed dealing with the enfranchisement and commutation of copyholds and the preservation of commons and open spaces. The Naturalization Act 1870 enabled aliens to hold and transfer land in England. The Felony Act 1870, abolished forfeiture of real estate on conviction for felony. The Agricultural Holdings Acts 1883 and 1900, and other acts, gave the tenant of a tenancy within the acts a general right to compensation for improvements, substituted a year's notice to quit for the six months' notice previously necessary, enlarged the tenant's right to fixtures, and limited the amount of distress. By the Intestate Estates Act 1884 the law of escheat was extended to incorporeal hereditaments and equitable estates. Among other subjects which have been dealt with by legislation in the 19th century may be mentioned land transfer, registration, mortgage, partition, excambion, fixtures, taking of land in execution, declaration of title and apportionment. Hardly a year passes in which the land law is not altered to a greater or less degree.

Real estate at the present day is either legal or equitable, a difference resting mainly upon historical grounds. The following observations apply in general to both kinds of estate. The usual classification of interests in real estate regards either the extent, the time or the mode of enjoyment. The division according to the extent is in the first instance into corporeal and incorporeal hereditaments, a division based upon the Roman law division of *res* into *corporales* and *incorporales*, and open to the same objection,

¹ From the reign of Edward IV. at latest up to the Fines and Recoveries Act of 1833 fines and recoveries were also recognized as a means of conveyance. They are so regarded in the Statute of Uses.

that it is unscientific as co-ordinating subjects of rights with the rights themselves.² Corporeal hereditaments, says Blackstone, "consist of such as affect the senses, such as may be seen and handled by the body; incorporeal are not the objects of sensation, can neither be seen nor handled, are creatures of the mind, and exist only in contemplation." Corporeal hereditaments are all necessarily freehold;³ an interest in land less than freehold, such as a term of years, is personalty only. There was no room for such an interest in the feudal gradation of tenure; it was regarded as a mere personal contract and was incapable of the incidents of tenure. By the Conveyancing Act 1881 the residue of a long term of years could in certain cases be enlarged into the fee-simple. A copyhold is in strict law only a tenancy at the will of the lord. Estates of freehold are either estates for life or in fee (called also estates of inheritance), the latter being in fee-tail or in fee-simple. An estate for life may be either for the life of the tenant or for the life of another person, the latter called an estate *pur autre vie*. The former kind of estate includes estates of dower and curtesy. An estate in fee is called a fee simply, an obvious sign of its feudal origin. Estates tail are either general or special, the latter being in tail male or (rarely) in tail female. There may also be a quasi-entail of an estate *pur autre vie*. An estate in fee-simple is the largest estate known to English law. Its ordinary incidents are an oath of fealty (never exacted), escheat, and (in a manor) suit of the court baron, and occasionally a small quit-rent and relief. All these are obviously relics of the once important feudal incidents. Incorporeal hereditaments consist chiefly, if not wholly, of rights *in alieno solo*. They are divided by Joshua Williams (*Real Property*, pt. ii.) into (1) reversions, remainders and executory interests, (2) hereditaments purely incorporeal, the last being either appendant, appurtenant or in gross. Examples are profits *a prendre* (such as rights of common), easements (such as rights of way),⁴ seigniories, advowsons, rents, tithes, titles of honour, offices, franchises. Before 1845 corporeal hereditaments were said to lie in livery, incorporeal in grant. But by the Real Property Act 1845 all corporeal hereditaments are, as regards the conveyance of the immediate freehold thereof, to be deemed to lie in grant as well as in livery. With regard to the time of enjoyment, estates are either in possession or in expectancy—that is, in reversion or remainder or executory interests (see REMAINDER). With regard to the mode of enjoyment, estates are either joint, in common, in coparcenary or in severalty.

Exceptional Tenures.—It has been already stated that there are still to be found survivals of the old pre-Conquest customary law. They are found both in the tenure and in the conveyance of land. The only customs of which judicial notice is taken are gavelkind (*q.v.*) and borough-English (*q.v.*). Any other local customs, as in manors, must be proved by evidence. The tenures of frankalmoign and grand serjeanty were specially preserved by 12 Car. II. c. 24.

Title.—This is the name given to the mode of acquisition of rights over real estate. Title may arise either by alienation, voluntary or involuntary, or by succession. Voluntary alienation is either *inter vivos* or by will. The former branch is practically synonymous with conveyance, whether by way of sale, settlement, mortgage or otherwise. As a general rule alienation of real estate *inter vivos* must be by deed since 8 & 9 Vict. c. 106. Since that act a deed of grant has superseded the old forms of feoffment and lease and release. Considerable alterations in the direction of shortness and simplicity have been made in the law of transfer of real estate by the Conveyancing Acts 1881, 1882 and the Land Transfer Acts 1875 and 1897. The word "grant" is no longer necessary for a conveyance, nor are the old words of limitation "heirs" and "heirs of the body." It is sufficient to use the words "in fee-simple," "in tail," "in tail male," "in tail female." Many provisions usually inserted in deeds, such as covenants for title by a beneficial owner and powers of appointment of new trustees, obtain statutory sanction. Forms of mortgage, conveyance and settlement are appended to the act. The Solicitors' Remuneration Act 1881 was passed as a necessary sequel to the Conveyancing Act, and the remuneration of solicitors now stands upon a different and more satisfactory basis. For acquisition by will and succession, see WILL; INHERITANCE. Involuntary alienation is by bankruptcy (*q.v.*) and by other means of enforcing the rights of creditors over land, such as distress or execution. It may also arise by the exercise by the state of its right of eminent domain for public purposes, as under the Lands Clauses and other acts.⁵

² In spite of this objection the division is adopted by the legislature; see, for instance, the Intestate Estates Act 1884.

³ In the category of corporeal hereditaments are also included certain accessories to corporeal hereditaments proper, such as growing crops, fixtures, title-deeds, &c.

⁴ It should be noticed that an easement in gross cannot exist.

⁵ The right of the state to contribution from land for revenue purposes and to stamp duties on deeds perhaps falls under this head. These imposts are really involuntary alienations of part of the profit of the land.

Restraints on Alienation.—The alienation of real estate may be subject to almost any conditions, provided that such conditions do not contravene the law. As a general rule there can be no restrictions upon the alienation of an estate in fee-simple; the two ideas are incompatible. In the case, however, of a married woman a restraint on anticipation is allowed within certain limits (see RESTRAINT). In another direction the imposition of a course of devolution upon property is forbidden by the law against perpetuities (see PERPETUITY), while the accumulation of income is also forbidden with a few exceptions. Certain persons are by the general policy of the law disabled from exercising full proprietary rights, such as convicts, infants and lunatics.

Procedure.—In some cases rights attaching to real estate are protected by peculiar remedies. At an early period it became more convenient to try the right to the possession of, rather than the right to the property in, real estate. Possessory tended to supersede proprietary remedies, from their great simplicity and elasticity. The general mode of trying the right to both property and possession was from the time of Henry II. the real action, the form called "writ of right" (after Magna Carta gradually confined to the court of common pleas) being used to determine the property, that called "assise of novel disseisin" being the general means by which the possession was tried. About the reign of Elizabeth the action of ejectment became the ordinary form of possessory remedy. Real actions existed until the Real Property Limitation Act 1833, by which they were finally abolished, with the exception of writ of right of dower, writ of dower *unde nihil habet, quare impedit* and ejectment. Of these *quare impedit (q.v.)* appears to be the only one now in use. The assise of novel disseisin, the action of ejectment in both its original and its reformed stage, and finally the action for the recovery of land in use since the Judicature Acts are all historically connected as gradual developments of the possessory action. There are certain matters affecting real estate over which the court of chancery formerly had exclusive jurisdiction, in most cases because the principles on which the court acted had been the creation of equity. The Judicature Act 1873 assigned to the chancery division of the high court of justice all causes and matters for (*inter alia*) the redemption or foreclosure of mortgages, the raising of portions or other charges on land, the sale and distribution of the proceeds of property subject to any lien or charge, the specific performance of contracts between vendors and purchasers of real estates, including contracts for leases, the partition or sale of real estates, and the wardship of infants and the care of infants' estates. In the case of rent a summary mode of remedy by act of the creditor still exists (see DISTRESS, RENT).

Ireland.—The law of real estate in Ireland is the English law, which finally superseded the native law in James I.'s reign, as modified by subsequent legislation. The main difference is in the law of landlord and tenant, modified by the various land acts (see IRELAND) and the operation of the Irish Land Commission.

United States.—The law of real estate in the United States is the law of England modified to suit a different state of circumstances. The main point of difference is that in the United States the occupiers of land are generally wholly or in part owners, not tenants, as in England. This is to a great extent the effect of the homestead laws (see HOMESTEAD AND EXEMPTION LAWS). The traces of the feudal origin of the law are, as might be expected, considerably less prominent than in England. Thus estates tail are practically obsolete; in some states they are specially forbidden by the state constitutions. The law of descent is the same in real and personal estate. Manors do not exist, except in the state of New York, where they were created by the crown in colonial days (Bouvier, *Law Dict.*, "Manor"). Registration of deeds is general. In some states forms of deed are prescribed by statute. Conveyancing is for the most part simpler than in England. The holding of real estate by religious or charitable corporations is generally restricted by the act creating them rather than by anything like the English law of mortmain. Perpetuities are forbidden in most states. The right of eminent domain is at once acknowledged and limited by the Constitution of the United States. By art. 5 of the Amendments private property is not to be taken for public use without just compensation. A similar provision is found in many of the state constitutions. By an Act of Congress of 9th April 1866, c. 31, all citizens of the United States have the same right in every state and Territory as is enjoyed by white citizens thereof to inherit, purchase, lease, sell, hold and convey real and personal property. In most states aliens may hold land; but in some states they cannot do so without becoming naturalized or at least filing in the specified manner a declaration of intention to become naturalized.

International Law.—The law of the place where real estate is situated (*lex loci rei sitae*) governs its tenure and transfer. The laws of England and of the United States are more strict on this point than the laws of most other countries. They require that the formalities of the *locus rei sitae* must be observed, even if not necessary to be observed in the place where the contract was made. The *lex loci rei sitae* determines what is to be considered real estate. A foreign court cannot as a general rule pass title to land situated in another country. The English and United States courts of equity have to a certain extent avoided the inconvenience which this in-

ability to deal with land out of the jurisdiction sometimes causes by the use of the theory that equity acts upon the conscience of the party and not upon the title to the foreign land. Thus in the leading case of *Penn. v. Lord Baltimore* in 1750 (1 Vesey, 444) the court of chancery on this ground decreed specific performance of articles for settling the boundaries of the provinces of Pennsylvania and Maryland. The difficulty always arises that, although the court professes to act upon the conscience, it must indirectly act upon the property, and that it cannot carry its decision into execution without the aid of the local tribunals.

REAM (either through Du. *riem*, or O.Fr. *rayme, reyme*, mod. *rame*, Med. Lat. *risma*, from Arabic *rizmah*, bale or bundle), a certain quantity of paper, viz. 20 quires containing 24 sheets each or 480 sheets; a "printer's ream" contains 21½ quires or 516 sheets. The word owes its introduction into Europe to the Moors, who were the originators of the paper manufactured in Spain. Its original meaning was simply bundle, applied either to paper or clothes.

REAPING (from O.E. *ripan, rypan*, probably allied to "ripe," mature, *i.e.* "fit for reaping"); the cognate forms are found in other languages), the action of cutting ripe grain crops. Till the invention of the reaping machine, which came into practical use only about the middle of the 19th century, sickles and scythes were the sole reaping implements. Of the two the sickle is the more ancient, and indeed there is some reason to conclude that its use is coeval with the cultivation of grain crops. Among the remains of the later Stone period in Great Britain and on the European continent curved flint knives have occasionally been found, the form of which has led to the suggestion that they were used as sickles. Sickles of bronze occur quite commonly among remains of the early inhabitants of Europe. Some of these are deeply curved hooks, flat on the under side, and with a strengthening ridge or back on the upper surface, while others are small curved knives, in form like the ordinary hedge-bill. Among the ancient Egyptians toothed or serrated sickles of both bronze and iron were used. Ancient Roman drawings show that both the scythe and the sickle were known to that people, and Pliny makes the distinction plain.¹ Although both implements have lost much of their importance since the general introduction of mowing and reaping machinery, they are still used very extensively, especially in those countries like France where small agricultural holdings prevail. The principal modern forms are the toothed hook, the scythe book, the Hainault scythe and the common scythe.

The toothed hook, which was in general use till towards the middle of the 19th century, consisted of a narrow-bladed curved hook, having on its cutting edge a series of fine close-set serratures cut like file-teeth, with their edges inclined towards the heft or handle. The curve is that known to mathematicians as the "cissoid," where tangents at any point form equal angles with lines drawn to the middle of the handle; it has been called the "curve of least exertion" because experience has shown that it tires out the arm of the worker less than any other curve. Sickles were formerly made of iron edged with steel; but in recent times they came to be made of cast steel entirely. Towards the middle of the 19th century the toothed hook was gradually supplanted by the scythe hook or smooth-edged sickle, a somewhat heavier and broader-bladed implement, having an ordinary knife edge. Both these implements were intended for "shearing" handful by handful, the crop being held in the left hand and cut with the tool held in the right. A heavy smooth-edged sickle is used for "bagging" or "clouting,"—an operation in which the hook is struck against the straw, the left hand being used to gather and carry along the cut swath. The Hainault scythe is an implement intermediate between the scythe and the sickle, being worked with one hand, and the motion is entirely a swinging or bagging one. The implement consists of a short scythe blade mounted on a vertical handle, and in using it the reaper collects the grain with a crook, which holds the straw together till it receives the cutting stroke of the instrument. The Hainault scythe was extensively used in Belgium. The common hay sickle consists of a slightly curved broad blade varying in length from 28 to 46 in., mounted on a bent, or sometimes straight, wooden sned or snathe, to which two handles are attached at such distances

¹ "Of the sickle there are two varieties, the Italian, which is the shorter and can be handled among brushwood, and the two-handed Gallic sickle, which makes quicker work of it when employed on their [the Gauls'] extensive domains; for there they cut their grass only in the middle, and pass over the shorter blades. The Italian mowers cut with the right hand only" (*H. N.* xviii. 67).

as enable the workman, with an easy stoop, to swing the scythe blade along the ground, the cutting edge being slightly elevated to keep it clear of the inequalities of the surface. The grain-reaping scythe is similar, but provided with a cradle or short gathering rake attached to the heel and following the direction of the blade for about 12 in. The object of this attachment is to gather the stalks as they are cut and lay them in regular swaths against the line of still-standing corn. The reaping scythe, instead of a long sned, has frequently two helves, the right hand branching from the left or main helve and the two handles placed about 2 ft. apart. The best scythe blades are made from rolled sheets of steel, riveted to a back frame of iron, which gives strength and rigidity to the blade. On the continent of Europe it is still common to mould and hammer the whole blade out of a single piece of steel, but such scythes are difficult to keep keen of edge. There is a great demand for scythes in Russia, chiefly supplied from the German empire and Austria. The principal manufacturing centre of scythes and sickles in the United Kingdom is Sheffield.

It was not until the beginning of the 19th century that any attempt was made to invent a reaping machine on anything like the lines that have been adopted since. In 1826 the Rev. Patrick Bell of Carmylie in Fifeshire brought out the first successful machine. He had worked at the making of it when a young man on his father's farm, and the principle he adopted, that of a series of scissors fastened on the "knife-board," was followed for a long time. There had been many trials during the thirty or forty years before his time both in this country and in America, but his invention was the first practical success.

After many modifications, however, the present or recent form of the common reaper was evolved by C. H. McCormick in America in 1831. A truck or carriage is carried on two travelling wheels some 30 to 36 in. high, with spuds or teeth on the circumference to make them "bite" the ground and thus give motion to the machinery without skidding; two horses are yoked in front with a pole between, with martingale and surcingle belts as part of their harness, to ease the backing of the machine by the horses; the knife-board is fixed out at right angles to the side of the carriage and in front, while the knives consist of a series of triangular "sections" on a bar which travels backwards and forwards in slots in the "fingers," as the dividing teeth are called. The motion was given to the knives by a connecting rod and crank driven by suitable gearing from the truck wheels. The cutting was thus done by a straight shearing action and not by clipping like scissors as in Bell's machine.

There were many modifications tried before the favourite form was ultimately adopted: thus the horses were yoked behind the truck or carriage of the machine so that they pushed it before them; a revolving web of cloth was placed behind the knives so as to deliver the cut corn in a continuous swathe at the side; revolving "sails" or "rakes" pushed the standing grain against the knives as the machine advanced—some of which arrangements have been revived in our modern string-binders—and so on.

In the early days—from about 1860 to 1870—machines were fitted with a tilting board behind the cutting bar which caught the corn as it fell, and it was held there until enough for a sheaf was gathered, when the load was "tilted" off by a suitable rake handled by a man who sat and worked the tilting board simultaneously with his foot and dropped the corn, to be lifted and tied into a sheaf by hand afterwards. The same machine was generally used for mowing (grass) by an interchange of parts, and the "combined" reaper and mower was in common use in the 'seventies and 'eighties. Later, various devices were adopted to do the tilting or sheafing mechanically, and the self end-delivery and self side-delivery have long been in use whereby through the adoption of revolving rakes on frames the sheaf-lots are delivered in sizes ready for tying up by hand. The subsequent tying or binding was done variously in different parts of the country. In the south of England it was customary for five men to make bands, lift the sheaf-lot, place in the band and tie, and leave the sheaf lying on the ground to be set up afterwards, the gang of five being expected to keep up on a reaper cutting round the four sides of a field. In the north and in Scotland the cutting was only done on one side at a time, the

machine riding back empty, and three boys made the bands ("straps"), three women lifted the lots and laid them on the bands, and three men bound the sheaves and set up in stooks. Thus three gangs of three each were required to keep a machine going, and only about five acres per day could be reaped in this way.

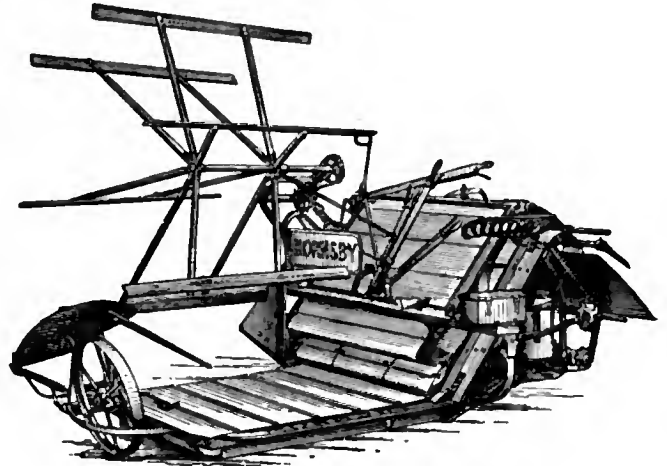

FIG. 1.—The Hornsby String-binder.

The development of the modern binder to reduce all this labour has been a very gradual process. There was no great difficulty in cutting the corn and delivering the stuff, but the tying of it into sheaves was the problem to be solved. As early as 1858 Marsh in America designed and carried out an arrangement whereby the cut grain crop was caught on revolving webs of canvas and carried up on to a table, where two men stood who made bands of its own material and bound it into sheaves as it fell in front of them, dropping the sheaves off on to the ground as made, while the machine travelled along. The invention of a tying apparatus was the next advance, and in the 'seventies the American firm of Walter A. Wood & Co. brought out an arrangement for tying the sheaves up with wire. So slow and expensive had been the process of evolution, however, that it was reported at the time that the above firm had spent £20,000 in invention and experiment before they had even a wire-binder fit to put on the market.

Binding with string, however, was the aim of all, and it was reserved for J. F. Appleby, an English inventor, to hit on the arrangement now in use, or which was the prototype of all the knot-tyers now to be met with in different varieties of

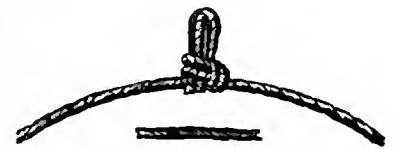

FIG. 2.—The Hornsby Knot as tied by the String-binder.

the string-binder throughout the world.

While the string-binder is now in universal use in Great Britain, the British Colonies, America and all countries where farming and farm work are advanced, and hand labour is only followed where peasant-farming or small farming obtains, it must be noted that in certain regions the system of reaping or harvesting of corn crops has developed a good deal beyond this. In Australia and some of the hotter districts in the west of the United States the "stripper" is in use, an implement which carries long grooved teeth which are passed through the standing grain crop and strip off the heads, leaving the straw standing. The heads are passed backwards to a thrashing (rubbing) arrangement, which separates the corn from the chobs, chaff, &c., and the grain is sacked up straight away. The sacks are dropped off the machine as the work proceeds and are picked up by wagon for transport afterwards. It is a significant fact that strippers worked by hand, though pushed through the crop by oxen, were in use on the plains of Gaul in the first

century of our era, though this system seems to have been lost sight of till re-invented by the Australians.

Again, in the Western states of America, where the climate is not hot and dry enough for stripping purposes, the method followed is to cut the straw as short as possible—just below the heads—and these fall on to a travelling canvas and are carried up into a thrasher and the grain separated and sacked as the work proceeds. An immense combined implement is used for this reaping and thrashing purpose, taking a width of up to 40 ft. of crop at a time, and being propelled by a 50-horse-power traction engine running on broad roller-wheels, though smaller machines pulled by, say, 20 horses are also common. Sometimes the "heading" only is carried out, and the cut heads carried on a canvas up into a wagon travelled alongside, and then carted away for subsequent thrashing, the "header" thus being the form of reaper adopted also in the Western states of America. In these regions, as in many other places on the prairies in general, the straw is of no value, and therefore the whole is set fire to and burned off, thus returning a certain amount of fertility to the soil in the ashes.

In the normal and ordinary system of reaping with the string-binder in Great Britain the rule is to "open up" a field by cutting "roads" round it: that is, a headland or roadway is mowed by the scythe and tied up by hand. Then the string-binder is started to cut around and continued till a finish is made at the centre of the field. Sometimes the crop is partly lodged and can only be cut on three sides of the field, and the binder is "slipped" past the fourth side. It is customary in some parts to yoke three horses to the machine and keep these at work all day with an interval for the midday meal only, but a better plan is to allow two men and four horses to each, and

stackyard, where they are built up sheaf by sheaf into round or oblong stacks: that is, they are stored until required for thrashing or foddering purposes. The drying may be a tedious affair, and wet weather in harvest time is a national disaster from the spoiling of the corn, both grain and straw.

The tremendous development in labour-saving in the matter of reaping the corn crops is well exemplified in a comparison of harvesting with the hand hook or sickle as compared with the string-binder. With hand-reaping six men (or women) cut the corn and laid it on the bands in sheaf-lots: one man came behind and tied the sheaves and set them up in stooks. Thus a gang of seven worked together and harvested about two acres per day. With the binder three or four men handle say twelve or fourteen acres daily: in other words, there is only one-tenth of the manual labour required now in reaping that was necessary only a generation ago, for the string-binder has revolutionized farming as a whole, and given the nations cheap bread. (P. McC.)

REAR, the back or hind portion of anything, particularly a military or naval term for that part of a force which is placed last in order, in opposition to "van." As the last word, shortened from "van-guard," is an aphetic form of Fr. *avant*, in front, Lat. *ab ante*, so "rear" is an aphetic form of "arrear," O. Fr. *arere*, mod. *arriere*, Med. Lat. *ad retro*, to the back, backward. From this word must be distinguished the verb "to rear," used in two main senses: of a horse, to stand up on its hind legs, and to raise up or lift, of the construction of a building or of the breeding and bringing to maturity of domestic or

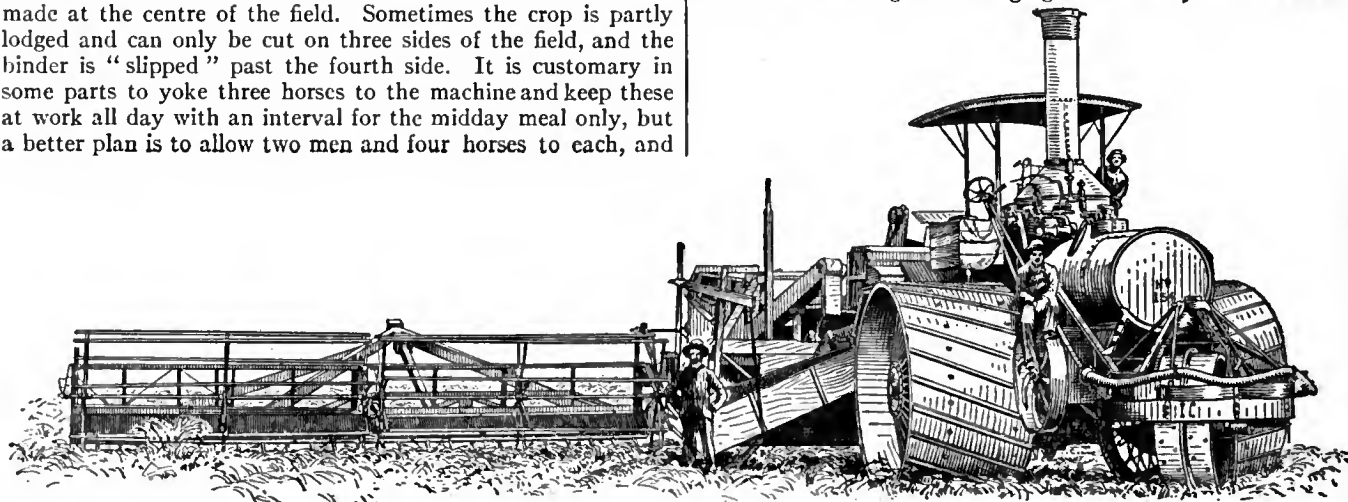

FIG. 3.—American Header and Thrasher.

put one couple on and one couple off for meals and resting alternately. By this means the binder is kept going continuously without any stoppage for perhaps 14 hours daily in fine harvest weather. With a six-foot cutting width an acre per hour is fair work, but some have exceeded that, especially with wider cutting widths. A ball of twine weighing 3 to 4 lb is the usual requisite per acre for binding the sheaves, and it ought to be of Manilla hemp: "sizal" fibre (derived from the American agaves and named after the port on the coast of Yucatan) is not so strong and good, though cheaper. Good twine is desirable, as otherwise frequent breakages leave many sheaves in a loose state.

The sheaves are dropped off on to the ground as tied, but some farmers use the "sheaf-carrier," which catches these as they are shot out from the binding apparatus, and dumps them in lots of six or so—sufficient to make a stook or shock. The stooking—that is, the setting up of the sheaves on end to dry—is a separate operation, and from two to three men can set up an ordinary good crop as fast as the binder can cut it. In this work the sheaves are set with their butts wide apart and the heads leaning against one another like the two legs of the letter A: a full-sized stook or "threave" is 24 sheaves—a relic of the days when the crop was all hand-reaped by piecework at so much per threave—but in practice now seldom more than 6 sheaves (3 each side) are put to each stook. When sufficiently dried or "fielded" the sheaves are then carried by cart or wagon to the

other animals, often used also of young children. The O.E. *ræran*, of which it is the modern representative, is a doublet of the Scandinavian *reisa*, which has given English "raise," both being causative verb forms of "rise."

REAR VAULT (Fr. *arrière voussure*), the term in architecture employed for the vault of the internal hood of a doorway or window to which a splay has been given on the reveal; sometimes the vaulting surface is terminated by a small rib known as the scoinson rib (*q.v.*), and a further development is given by angle shafts carrying this rib, known as scoinson shafts.

REASON (Lat. *ratio*, through French *raison*), in philosophy, the faculty or process of drawing logical inferences. Thus we speak of man as essentially a rational animal, it being implied that man differs from all other animals in that he can consciously draw inferences from premises. It is, however, exceedingly difficult in this respect to draw an absolute distinction between men and animals, observation of which undoubtedly suggests that the latter have a certain power of making inferences. Between the higher animals and the lower types of mankind the distinction is so hard to draw that many psychologists argue that the difference is one of degree rather than of kind (see also **INSTINCT**). There can be little doubt, however, that inference by man differs from that of the brute creation in respect of self-consciousness, and, though there can be no doubt that some animals dream, it is difficult to find evidence for the presence of ideal images in the minds of

any but the highest animals. In the nature of the case satisfactory conclusions as to the rationality which may be predicated of animals are impossible.

The term "reason" is also used in several narrower senses. Thus reason is opposed to sensation, perception, feeling, desire, as the faculty (the existence of which is denied by empiricists) by which fundamental truths are intuitively apprehended. These fundamental truths are the causes or "reasons" (ἀρχαί) of all derivative facts. With Kant, reason (*Vernunft*) is the power of synthesizing into unity, by means of comprehensive principles, the concepts provided by the intellect (*Verstand*). The reason which gives a priori principles Kant calls "Pure Reason" (cf. the *Kritik der reinen Vernunft*), as distinguished from the "Practical Reason" (*praktische Vernunft*) which is specially concerned with the performance of particular actions. In formal logic the drawing of inferences (frequently called "ratiocination," from Lat. *ratiocinari*, to use the reasoning faculty) is classified from Aristotle downwards as deductive (from generals to particulars) and inductive (from particulars to generals); see LOGIC, INDUCTION, SYLLOGISM. In theology, reason, as distinguished from faith, is the human intelligence exercised upon religious truth whether by way of discovery or by way of explanation. The limits within which the reason may be used have been laid down differently in different churches and periods of thought: on the whole, modern Christianity, especially in the Protestant churches, tends to allow to reason a wide field, reserving, however, as the sphere of faith the ultimate (supernatural) truths of theology.

The Greek words for reason are *νοῦς* and *λόγος*, both vaguely used. In Aristotle the *λόγος* of a thing is its definition, including its formal cause, while the ultimate principles of a science are *ἀρχαί*, the "reasons" (in a common modern sense) which explain all its particular facts.¹ *Νοῦς* in Plato and Aristotle is used both widely for all the meanings which "reason" can have, and strictly for the faculty which apprehends intuitively. Thus, in the *Republic*, *νοῦς* is the faculty which apprehends necessary truth, while *δόξα* (opinion) is concerned with phenomena.

For the Stoic and Neoplatonic uses of *λόγος*, as also for those of Philo Judaeus and the Fathers, see LOGOS.

RÉAUMUR, RENÉ ANTOINE FERCHAULT DE (1683–1757), French man of science, was born on the 28th of February 1683 at La Rochelle and received his early education there. He was taught philosophy in the Jesuits' college at Poitiers, and in 1699 went to Bourges to study civil law and mathematics under the charge of an uncle, canon of La Sainte-Chapelle. In 1703 he came to Paris, where he continued the study of mathematics and physics, and in 1708, at the early age of twenty-four, was elected a member of the Académie des Sciences. From this time onwards for nearly half a century hardly a year passed in which the *Mémoires de l'Académie* did not contain at least one paper by Réaumur. At first his attention was occupied by mathematical studies, especially in geometry. In 1710 he was appointed to the charge of a great government work—the official description of the useful arts and manufactures—which led him to many practical researches that resulted in the establishment of manufactures new to France and the revival of neglected industries. For discoveries regarding iron and steel he was awarded a pension of 12,000 livres; but, being content with his ample private income, he requested that the money should be secured to the Académie des Sciences for the furtherance of experiments on improved industrial processes. In 1731 he became interested in meteorology, and invented the thermometer scale which bears his name. In 1735 family arrangements obliged him to accept the post of commander and intendant of the royal and military order of Saint-Louis; he discharged his duties with scrupulous attention, but declined the emoluments. He took great delight in the systematic study of natural history. His friends often called him the

¹ The Schoolmen's distinction of *ratio cognoscendi* (a reason for acknowledging a fact) and *ratio essendi* (a reason for the existence of this fact).

Pliny of the 18th century. He loved retirement and lived much at his country residences, at one of which, La Bermondière (Maine), he met with a fall from horseback, the effects of which proved fatal on the 17th of October 1757. He bequeathed his manuscripts, which filled 138 portfolios, and his natural history collections to the Académie des Sciences.

Réaumur's scientific papers deal with nearly all branches of science; his first, in 1708, was on a general problem in geometry; his last, in 1756, on the forms of birds' nests. He proved experimentally the fact that the strength of a rope is less than the sum of the strengths of its separate strands. He examined and reported on the auriferous rivers, the turquoise mines, the forests and the fossil beds of France. He devised the method of tinning iron that is still employed, and investigated the differences between iron and steel, correctly showing that the amount of carbon (sulphur in the language of the old chemistry) is greatest in cast iron, less in steel, and least in wrought iron. His book on this subject (1722) was translated into English and German. The thermometer by which he is now best remembered was constructed on the principle of taking the freezing-point of water as 0°, and graduating the tube into degrees each of which was one-thousandth of the volume contained by the bulb and tube up to the zero mark. It was an accident dependent on the dilatibility of the particular quality of alcohol employed which made the boiling-point of water 80°; and mercurial thermometers the stems of which are graduated into eighty equal parts between the freezing- and boiling-points of water are *not* Réaumur thermometers in anything but name.

Réaumur wrote much on natural history. Early in life he described the locomotor system of the Echinodermata, and showed that the supposed vulgar error of Crustaceans replacing their lost limbs was an actual fact. In 1710 he wrote a paper on the possibility of spiders being used to produce silk, which was so celebrated at the time that the Chinese emperor Kang-he caused a translation of it to be made. He treated also of botanical and agricultural matters, and devised processes for preserving birds and eggs. He elaborated a system of artificial incubation, and made important observations on the digestion of carnivorous and gaminivorous birds. His greatest work is the *Mémoires pour servir à l'histoire des insectes*, 6 vols., with 267 plates (Amsterdam, 1734–42). It describes the appearance, habits and locality of all the known insects except the beetles, and is a marvel of patient and accurate observation. Among other important facts stated in this work are the experiments which enabled Réaumur to prove the correctness of Peyssonel's hypothesis, that corals are animals and not plants.

REBAB, or **RABAB** (Persian *rubāb*;² Arabic *rabāb*, *rabāba*;³ Sp. *rabé*, *rabé*,⁴ *rabél*, *arrabel*, *arrabil*;⁵ Fr. *rubèbe*; It. *rubeba*), an ancient stringed instrument, having a body either pear-shaped or boat-shaped and the characteristics of vaulted back and the absence of neck; also a generic modern Arabic term applied by the Mahomedans of northern Africa to various stringed instruments played with a bow.

As the rebab exercised a very considerable influence on the history of stringed instruments in Europe, and was undoubtedly the means through which the bow was introduced to the West, it is necessary to examine its construction before deciding whether it may be accepted as the ancestor of the violin in deference to the claim made for it by certain modern writers.⁶

² F. Rückert, *Grammatik, Poetik und Rhetorik der Perser, nach dem 7^{ten} Bande des Heftes Kolzum* (Gotha, 1874), p. 80. This translation of the introduction to the *Seven Seas* contains a reference to musical instruments; the one translated *Laute* (lute) is rendered in Persian *rubāb*, a point ascertained through the courteous assistance of Mr A. G. Ellis, of the Oriental Department, British Museum.

³ Al-Farabi, 10th century, translation into Latin by J. G. Kosegarten, *Alii Ispahenensis Liber. Cantilenarum . . . arabice editur adjectaque translatione adnotationibusque* (Greifswald, 1840), vol. i. pp. 36, 41, 105, 109, &c.

⁴ See poem by Juan Ruiz, archipreste de Hita, 14th century, from MS. in library of the cathedral at Toledo, quoted by Mariano Soriano Fuertes, *Hist. de la Musica española* (Madrid), vol. i. p. 105.

⁵ From the Arabic treatise of Mahamud Ibrain Axalchi, MS. No. 69, Escorial.

⁶ See F. J. Fétis, *Antoine Stradivari . . . Précédé de recherches historiques et critiques sur l'origine et les transformations des instru-*

The two principal forms of rebab with which we are concerned as prototypes of European instruments of the middle ages are: (1) the long and narrow boat-shaped rebab, which may be traced back to Persia in the 8th century B.C., and is still in use in that country; and (2) the lute-shaped rebab, with rudimentary neck consisting of the gradual narrowing of the body, which has the outline of a longitudinal section of a pear. This variety became very popular in medieval Europe under the names of rebec, gigue, geige and lyra; the archetype has been traced back to 1000 B.C. The most characteristic feature in the construction of the rebab, and of all instruments derived from it, was the body, composed of a back originally scooped out of a solid piece of wood, to which was glued without the intermediary of ribs (an important structural feature of the violin) a flat sound-board of parchment or thin wood.

The *rebab-esh-sha'er*, or "poet's rebab," had a body consisting of an almost rectangular box covered with parchment and supported on an iron foot; the instrument was held like the modern violoncello. No evidence has yet been brought forward that the *rebab-esh-sha'er* was in use among the Arabs who conquered Spain in the 8th century; if the instrument was indeed ever introduced into Spain it has left no trace.

The bowed instruments of the middle ages fall naturally into two distinct classes, according to the principles observed in construction. One is the type having a body formed on the model of a Greek or a Roman cithara, from which it was evolved by the addition of a neck and finger-board (see GUITAR and GUITAR-FIDDLE). Instruments of this type were at all times recognized as superior and belonging to the realm of art, whereas type 2, derived from the Eastern rebab, never attained to any artistic development, and at the time when the first type had nearly reached its apogee the second was placed beyond the pale of art.

According to Al-Farabi, the rebab had either one string, two strings or four, obtained by doubling these two; they were tuned most often in minor thirds or in major thirds.¹ The Arab scholar Ash-Shakandi, who flourished in Spain about A.D. 1200, states that the rebab had been known for centuries in Spain, but was not mentioned on account of its want of artistic merit. Juan Ruiz, archipreste de Hita, in his enumeration² of the musical instruments in use in his day (14th century), mentions two rebabs, and speaks of *il ravé gritador con su alla nota* and *il rabé morisco*; the "shrill rebab" (or rather rebec) "with its high note" is thus quoted somewhat contemptuously already in the 14th century.

The history of the origin of the rebab had until now not gone back beyond the 7th century A.D., and has been a matter of conjecture founded on the word *rubāb* or *rūbāb*, which is of Persian origin, and on the statement that the Arabs themselves declare they obtained the instrument from the Persians. Recent archaeological discoveries, however, provide abundant evidence of archetypes of both pear-shaped and boat-shaped rebabs in high antiquity. We have at present no clue to the name of the archetype, but it is clear that the el-Oud or lute of the Arabs and the wide pear-shaped rebab were practically one and the same instrument, until the advent of the bow, which had probably also been made known to the Arabs through the Persians, since their word for the bow, *hamān*, is borrowed from the Persian, but at what date is unknown. Al-Farabi does not mention the bow,³ and his chapter on the *rabāba* does not deal with the construction of the instrument so much as with the production of sound and the divisions of the scale.

As far as is known at present, the archetype of the rebab and lute family is the instrument shown in fig. 1. The terra-cotta figure of the musician discovered in Egypt (1905-6) by Professor Flinders Petrie during the course of excavations in the cemetery of Goshen⁴ is Greek work of the post-Mycenaean age; it was

found in surroundings assigned to the XXth Dynasty (c. 1000 B.C.), and shows the earliest pear-shaped instrument yet discovered. This statuette clearly establishes the origin of the instruments named by some *lyra*,⁵ by others (including the present writer) rebab or rebec, common all over western Europe from the 11th century, whose main characteristic is an almost entire absence of neck. Two terra-cotta statuettes of musicians playing upon ancient Persian rebabs (see fig. 2) have been excavated from the



FIG. 1.—Prototype of Lute—Pear-shaped Rebab. 1000 B.C. Discovered by Professor Flinders Petrie in the cemetery at Goshen.



FIG. 2.—Boat-shaped Rebab. 789 B.C. From J. de Morgan, *Délégation en Perse*, by permission of Ernest Leroux.

Tell at Suza⁶ amongst objects referred to the reign of Shutruk-Nakhounta, who was king of Elam c. 789 B.C. The pear-shaped instrument, wide at the base and elongated to form a neck, with the head bent back at right angles and the strings plucked by the fingers,—the lute of the 6th century A.D.,—is seen first on a frieze from Afghanistan, forming one of the risers of steps to the top of Jamal-Garhi. These sculptures, preserved at the British Museum, are assigned to the 2nd or 3rd century, and are said to show traces of classical influence. The same instrument is found engraved on a Sassanian silver dish in the British Museum,⁷ of workmanship assigned to a period not later than the 7th century A.D., but probably earlier, as well as on other dishes of similar origin; one in the Hermitage, St Petersburg, was found at Irbid in 1880, on which Eros is depicted playing the lute and riding on a lion.⁸ A third, found at Perm, forms part of Count Stroganov's collection.⁹

Excavations carried out in ancient Khotan¹⁰ or Ilchi (Turkestan, on the caravan route to Kashgar) have brought to light further evidence of the ubiquity of the rebab type in Asia. In addition to the two principal types of rebab (fig. 3) mentioned above there is also to be found the spoon-shaped instrument with no neck and large round head (fig. 4), sometimes seen in European medieval sculptures and MSS. of the 11th and 12th centuries.¹¹

The pear-shaped rebab or lute appears also among the celebrated paintings in the Buddhist cave temples of Ajanta,¹² assigned to the 6th century A.D. A later example at the British Museum, a fragment of a dish found at Rhajes or Ray,¹³ in northern Persia,

⁵ See Laurent Grillet, *Les ancêtres du violon, &c.* (Paris, 1901), tome i. p. 29. "Portail occidental de l'église de Moissac," 12th century.

⁶ See *Délégation en Perse*, by J. de Morgan (Paris, 1900), vol. i. pl. 8, Nos. 8 and 9, text, pp. 130 and 131.

⁷ See Ormonde M. Dalton, *The Treasures of the Oxus*, catalogue of the Franks bequest to the British Museum, 1905, pl. xxvi. No. 190.

⁸ See for an illustration and description, *Comptes rendus de la commission impériale d'archéologie pour l'année 1881* (St Petersburg, 1883), text, p. 53, and atlas of the same date, pl. ii. No. 10.

⁹ See J. R. Aspelin, *Antiquités du nord*, p. 141, No. 608.

¹⁰ See *Ancient Khotan*, a detailed report of archaeological explorations in Chinese Turkestan, carried out by H.M. Indian government, by Marc Aurel Stein (Oxford, Clarendon Press, 1907), vol. ii. pl. xlv. Nos. 70011k, 70011d (spoon-shaped rebab), pl. xliii. Nos. 70028 and 70091.

¹¹ See, for instance, Psalter of Labeo Notker, 10th century, Bibl. Stift St Gallen, on the top of left-hand gable pillar. Illustration in Kathleen Schlesinger, *The Instruments of the Orchestra* (London, 1910), part ii., "Precursors," pl. iv. p. 154.

¹² See reproductions by John Griffiths (London, 1896), vol. ii. pl. 105, cave I., 10, e.

¹³ Brit. Mus., Ceramic Gallery, case A, Henderson Bequest, 1891.

ments à archet (Paris, 1856); Edward Heron Allen, *Violin-making as it was and is* (London, 1884); E. J. Payne, article "Violin" in *Grove's Dictionary of Music* (1st ed.). See also *The Instruments of the Orchestra* (London, 1910), part ii., "Precursors of the Violin Family," by Kathleen Schlesinger, where the evolution of the violin is traced from the cithara of the Greeks.

¹ See J. P. N. Land's paper, "Recherches sur l'histoire de la gamme arabe," *VI. Intern. Orient. Congress*, part ii. (Leiden, 1884) (Brit. Mus. press-mark, acad. 8806), p. 130, and also p. 56.

² See Mariano Soriano Fuertes, *loc. cit.*

³ The copy of Farabi's MS., used for their translations by Kosegarten and Land, *Escorial*, No. 911, dates from the middle of the 12th century. See Michael Casiri, *Bibl. Arab. Hisp.*, vol. i. p. 347, and Forkel, *Allgemeine Literatur der Musik* (Leipzig, 1792), p. 487; also R. G. Kiesewetter, *Die Musik der Araber nach Originalquellen dargestellt* (Leipzig, 1842), p. 64 and preface. Another MS. copy of Al-Farabi, in the Bibliotheca Ambrosiana in Milan, is described by Hammer von Purgstall in the *Bibliotheca Italiana*, tom. xciv. (Milan, 1839), p. 44; cf. preface in Kiesewetter, p. viii.

⁴ Excavations carried out by the Brit. School of Archaeology in Egypt and by the Egyptian Research Account. See "Hyksos and Israelite Cities," by W. M. Flinders Petrie and J. Garrow Duncan, *Mem. Brit. Sch. of Arch.*, 1906.

destroyed by Jenghiz Khan in the 13th century, has the four pegs in the side of the head. Finally, we find the instrument on the



From Marc. Aurel. Stein, *Ancient Khotan*, by permission of the Clarendon Press.
FIG. 3.—Pear-shaped rebab, from Khotan.



FIG. 4.—Spoon-shaped rebab, from Khotan.

doorway of the Hôpital du Moristan¹ (Cairo), carved work of the 13th century.

In all these examples it is noteworthy that the strings are vibrated by plucking them with the fingers, *not by means of the bow*, the use of which, in conjunction with those structural features, constitutes the violation of an acoustic principle, and therefore accounts for the failure of the instrument as Rebab and its successful development as Lute. There are, however, two early examples of bowed rebabs of Byzantine origin to be cited. A pear-shaped rebab, held like a violoncello and played by means of a very long and slender bow, is carved on one of the reliefs of an ivory casket of Italo-Byzantine work of the 8th or 9th century, belonging to the Carrand Collection, Florence (see REBEC). Another bowed instrument, of still earlier date, is to be seen among the wonderful mural paintings of the necropolis and monastery of Baouft,² assigned to the 8th century at the latest, but probably dating from the 6th or 7th.

The examination of all these representations of the rebab, ranging from 1000 B.C. to the 13th century A.D., tends to show that the instrument had its origin in the East, and was widely distributed over Asia Minor, India and Persia before the 6th century A.D. Similar archaeological documents of the middle ages suggest the possibility that we are not indebted to the Arabs alone for the introduction of the rebab and bow and of the lute into Europe by way of Spain, early in the 8th century, but that they had probably already made their way into southern and central Europe from the East through the influence of the Byzantine Empire and of the Christian East generally.

It is clear also that the instruments of the rebab type were at first twanged with the fingers, and the bow was apparently not invented for the rebab but only applied to it. All arguments in favour of including the rebab among the ancestors of the violin on the score of the bow lose their force, and as the rebab possessed no structural feature in common with the violin the question may be considered settled negatively.

For the European development of the rebab, see REBEC. (K. S.)

REBATE (Fr. *rabat*, from *rabattre*, to beat back), a term used in commerce, banking, &c. In banking, a rebate is an allowance made to a drawee taking up a bill of exchange before it is due. This allowance is the interest on the unexpired period of the bill, and in practice may be either a fixed or arbitrary rate; more often it is $\frac{1}{2}\%$, about the usual bank deposit rate. In commerce, rebate is sometimes used to mean a discount allowed for prompt payment; it is often equivalent to drawback, *i.e.* the repayment of part of the duty on imported goods when such goods are subsequently exported in their original or in another form. By the Customs Consolidation Act, 1853, a rebate or deduction is allowed at the custom-house from the fixed duties on certain kinds of goods, on account of damage or loss sustained in warehouses.

¹ See Prisse d'Avignes, *L'Art arabe d'après les monuments du Caire du viii^e au xviii^e siècle* (Paris, 1877). The unnumbered plates are to be identified by the list given at the beginning of the work.

² For the illustration, see Jean Clédat, "Le monastère et la nécropole de Baouft," *Mém. de l'Inst. fr. d'archéol. orient. du Caire*, tome xii., 1904. Chapelle, xviii. pl. lxi. (2). Descriptive text, p. 92. See also article "Baouft" by the same author, descriptive of the paintings in F. Cabrol's *Dict. d'arch. chrét. et de liturgie* (Paris, 1907), fasc. xii. B., p. 250b.

REBEC, or **REBECK** (Med. Fr. *rubèbe*, *rebelle*, *rebec*, *gigue*; Ger. *Rubeba*, *Rebek*, *Geige*, *Lyra*; Ital. *ribeba*, *ribeca*, *lyra*; Sp. *rabel*, *rabeca*, *ravé*, *rabé*), a medieval stringed instrument played with a bow, derived from the Oriental rebab. Like the rebab (*q.v.*), the rebec assumed at first one of two forms—the pear-shaped body with a wide base, strung with three strings, or the long, narrow pear- or boat-shaped body with two strings and, in addition, the other Oriental characteristics of the rebab, *i.e.* the vaulted back, the absence of ribs and pegs set in the back of the head. Except for the addition of a fingerboard, what is now recognised as the rebec underwent no structural development and never entered the domain of art. When the guitar-fiddle and the oval vielle with five strings made their appearance in Europe, apparently during the 11th century, a number of hybrids combining characteristics of both types of construction spread rapidly over western Europe.

A spoon-shaped instrument, in most cases without neck, the head being joined directly to the wide shoulders of the body, must not be confounded with these hybrids; the compass and capabilities of the instrument, which sometimes had but one single string, must have been extremely limited. What the name of the instrument was in the various ages is not known, but it may be classed with the rebab and rebec, from which it only differs in the outline of the body. The present writer discovered an Oriental archetype on a small terra-cotta figure³ in the style of the Gandhāra school, unearthed at Yōtkan on the site of the ancient Khotan. The round head is fastened directly to the shoulders, the three strings are thrown into relief by deep indentations, the bridge tail-piece has three notches. The instrument (assigned to some period between the 5th and 8th centuries A.D.) may be compared with the European medieval type, such, for instance, as the bowed spoon-shaped rebec on the capital of the left pillar in the miniature⁴ of King David and his musicians, belonging to the 10th-century psalter of Labeo Notker at St Gallen; also with the musicians' *lyra* on the western doorway of the church at Moissan;⁵ and with the British Museum Add. MS. 17333, in which several of these spoon-shaped, neckless instruments are to be found.

The pear-shaped rebec with wide base was in all probability introduced into Europe through the Byzantine Empire, and the narrow boat-shaped by the Moors by way of Spain. The first of these types is represented on one of the sides of an ivory casket of Italo-Byzantine workmanship preserved among the Carrand Collection⁶ in the Palazzo del Podesta in Florence. It belongs to the same group as the Veroli casket at the South Kensington Museum, all of which are assigned to the 9th century at the latest.

The pear-shaped rebec on the ivory casket, although like all rebecs it had no separate neck, was elongated to form one, and terminated in a lozenge-shaped head all in one piece with back and neck, the soundboard being cut to the same outline and glued to the back. There were four strings to these rebecs, of which there are many examples in English MSS. from the 11th century. One of the best known, sometimes described as the Anglo-Saxon *fythele*, is the one played by Jeduthun in the usual illustration of King David and his musicians prefaced to the Psalms in an Anglo-Saxon psalter (Cotton MS., Tib. C. VI., Brit. Mus.). Other examples are to be found in a Latin psalter illuminated by an English artist at the beginning of the 12th century (Lansd., 383, Brit. Mus.), in which the rebec has but one string and resembles the *lyra teutonica* mentioned above.⁷

Medieval documentary evidence points to the fact that the long boat-shaped rebec had survived in Spain and spread by way of France over western Europe. The much-quoted 14th-century

³ See Marc. Aurel. Stein, *Ancient Khotan: Detailed Report of the Archaeological Explorations in Chinese Turkestan carried out by H.M. Indian Government* (Clarendon Press, 1907), vol. i. pl. xlvi. No. Y0011d.

⁴ See Laurent Grillet, *Les ancêtres du violon* (Paris, 1901), vol. i. p. 29. The author calls these instruments *lyra*, which is a synonym of rebab.

⁵ See Kathleen Schlesinger, *The Instruments of the Orchestra*, part ii., "Precursors of the Violin Family" (London, 1910), pl. iv. p. 154. The spoon-shaped instrument with a long neck on pl. v. (9th century) must be referred to the pandoura family.

⁶ The casket has been reproduced by A. Venturi in *Gallerie Naz. Ital.*, vol. iii., 1897, p. 263; and *L'Arte*, vol. i. 1896, p. 24.

⁷ See also English psalters of the 13th century in the British Museum, Lansd. MS., 420, and Arundel, 157, fol. 71b.

poem by Juan Ruiz, archipreste de Hita,¹ containing an enumeration of the musical instruments of his day, includes *el ravé grilador con su alta nota* (the shrill rebec with its high note) and *el ravé morisco*. By a process of deduction we have no difficulty in identifying the long, narrow, boat-shaped instrument as *el ravé morisco*, since the instrument has survived almost unchanged among the Arabs of the present day² from the 13th century, and probably from the early centuries of our era. The shrill rebec (*el ravé grilador*) with thinner strings was the pear-shaped instrument. In the magnificent MS. known as the *Cantigas di Santa Maria*, assigned to the 13th century,³ there are three of those boat-shaped rebecs played with a bow and one twanged by the fingers; they have finger-boards and two strings, and are held like the violoncello. Rebabs of this type, but without bows, were in use in ancient Persia, c. 789 B.C., as is demonstrated by some little terra-cotta figures of musicians unearthed in a *tell* at Suza.⁴ Two of the instruments, held, however, like the violin, are unmistakably the archetypes of this rebec.

The rebec did not escape the general tendency so noticeable in Europe from the 12th to the 15th century towards the ornamentation of musical instruments with grotesque heads. The socket of the chaunter of the bagpipe, the heads of the cittern and gittern, the mandoline and the rebec, were all alike decorated with grotesque human or animal heads, which in England became proverbial as *cittern-heads*.

The boat-shaped rebec survived as the *sordino* or *pochette*,⁵ an instrument widely used by dancing masters until the 19th century, when it was abandoned for the kit, a diminutive violin. The *pochette*, as its name in French and also in German (*Taschengeige*) indicates, was small enough to be carried in the pocket; it measured from 15 to 18 in. and was played with a correspondingly small bow. The 15th- and 16th-century rebec or *geige*, as the pear-shaped variety was called in Germany (*gigue* in France), is figured by Sebastian Virdung;⁶ there were three strings tuned to G, D, A, and it had a finger-board cut in one piece with the sound-board in some cases and forming a step. Some writers consider that the addition of the finger-board constituted the difference between the *geige* and the rebec. Facts hardly support this theory, since the *lyra teutonica* in the 9th or 11th century already had a finger-board, and Farabi, the Arabic scholar of the 10th century, who was equally familiar with the Greek, Persian and Arabic musical systems, distinctly states that the rebab was also known as the *lyra*. The modern Greek rebec with three strings is to this day played by rustic musicians under the name of *lyra*. Moreover, in Germany, bowed instruments of all kinds were at first known as *geige*, in contradistinction to those whose strings were plucked, classed together as *cytharas* or some word derived from it, the most modern example of which is the zither. With the rise of the viols and later of the violin, which represent the most perfect type of construction for stringed instruments, the rebec tribe, inferior in every respect and without artistic merit, was gradually relegated beyond the pale,⁷ and by the 18th century had fallen into disuse except in certain rural districts, where for outdoor music, their shrill, penetrating tone continues to endear them to itinerant and village musicians. (K. S.)

¹ See Mariano Soriano Fuertes, *Historia de la Musica española* (Madrid, 1855), vol. i. p. 105. Aymeric du Peyrac, in his *Vita Caroli Magni* (13th century), mentions the rebec; see Du Cange, *Glossarium*, s.v. "Baudosa." Hieronymus of Moravia mentions the rubebe, and states that it has three strings, whereas the *vielle* had five (MS. Fonds Latin, No. 16 [663 actuel.], Paris Bibl. Nat.). In the *Minne Regel* ("Rules of the Minnesingers"), 1404, line 415: "Noch dan quinterna, gyge, videle, lyra, rubeba"; see *Der Minne Regel von Eberhardus Cercne aus Minden*, 1404, edited by Franz Xaver Woeber (Vienna, 1861), p. 24.

² For an illustration see Carl Engel, *Researches into the History of the Violin Family*, and E. Heron-Allen, *The Violin, and how to make it*.

³ Edward Buhle is of opinion that the miniatures in these MSS. are the work of a 14th-century artist. See *Die Musik-instrumente in den Minaturhandschriften des Mittelalters* (Leipzig, 1903).

⁴ See J. de Morgan, *La Délégation en Perse* (Paris, 1900), vol. i. pl. viii., Nos. 8 and 9.

⁵ There is a *pochette* in the Galpin Collection, c. 1700; for an illustration see Kathleen Schlesinger, *The Instruments of the Orchestra*, part ii., "Precursors of the Violin Family," p. 201, fig. 158.

⁶ *Musica getutsch und ausgezogen*, Basel, 1511, reprinted in *Publikationen d. Ges. f. Musikforschung*, Berlin, 1883, Bd. xi.

⁷ Antoine Vidal in *La Lutherie et les luthiers*, to show the contempt with which the rebec was viewed in France in the 15th century, quotes from the charges of King Charles VIII., 1483, where the following entry occurs: "On donna sur son ordre 35 sols à une poure insensée qui jouoit du rebec." The lieutenant of Paris, in March 27, 1628, issued the following order: "Faisant défence à tous musiciens de jouer dans les cabarets et mauvais lieux des dessus, basses ou autres parties de violon ains seulement du rebec." A well-known passage in Chaucer testifies to a similar contempt in 14th-century England: "Brother, quod he, here woneth an old rebekke," &c. (*Freres Tale*, 7156).

REBECCA RIOTS, the name given to some disturbances which occurred in 1843 in the counties of Pembroke, Carmarthen, Glamorgan, Cardigan and Radnor, after a slight outbreak of the same nature four years previously. During a period of exceptional distress the rioting was caused mainly by the heavy charges at the toll-gates on the public roads in South Wales, and the rioters took as their motto the words in Genesis xxiv. 60, "And they blessed Rebekah, and said unto her, Thou art our sister, be thou the mother of thousands of millions, and let thy seed possess the gate of those which hate them." Many of the rioters were disguised as women and were on horseback; each band was led by a captain called "Rebecca," his followers being known as "her daughters." They destroyed not only the gates but also the toll-houses, and the work was carried out suddenly and at night, but usually without violence to the toll-keepers, who were allowed to depart with their belongings. Emboldened by success, a large band of rioters marched into the town of Carmarthen on the 10th of June and attacked the workhouse, but on this occasion they were dispersed by a troop of cavalry which had hurried from Cardiff. The Rebeccaites soon became more violent and dangerous. They turned their attention to other grievances, real or fancied, connected with the system of land-holding, the administration of justice and other matters, and a state of terrorism quickly prevailed in the district. Under these circumstances the government despatched a large number of soldiers and a strong body of London police to South Wales, and the disorder was soon at an end. In October a commission was sent down to inquire into the causes of the riots. It was found that the grievances had a genuine basis; measures of relief were introduced, and South Wales was relieved from the burden of toll-gates, while the few rioters who were captured were only lightly punished.

REBELLION, the act or continuance in act of a rebel or rebels (Lat. *rebellio*, *rebellis*, a compound of *re-*, against, and *bellum*, war). A rebel is one who engages in armed resistance to the government to which he owes allegiance. For the distinction between Civil War and Rebellion, see **WAR**, **LAW** OF. Where individuals as distinguished from groups of men are concerned the character of rebel is easier to determine. That the alleged act of war was done by order of another cannot be in principle an excuse for a subject or citizen of any state taking arms against it. Under the rules of war adopted at the Hague in 1907, moreover, any excuse for doing so is removed by the provision that a belligerent is forbidden to compel nationals of the hostile party to take part in operations of war against their own country, "even if they were in the belligerent's service before the commencement of the war" (art. 123). In the case of *R. v. Louw*, known as the "Calvinia Flogging case" (Supreme Court of the Cape Colony, Feb. 18, 1904), the question of the validity of the excuse of acting under orders contrary to allegiance was discussed in an uncertain spirit, and in a previous case, the *Moritz* case, tried before the Treason Court at Mafeking (Nov. 7, 1901), the court held that insurgent nationals "who had joined the burghers must be placed on the same footing as burghers fighting against us." There may be special circumstances operating to qualify the application of a principle, but the above stated principle, as such, must be regarded as the only legal basis of argument on the subject. (T. BA.)

REBUS (Lat. *rebus*, "by things"), a sort of riddle consisting of the representation of some sentence or thing by means of pictures or words, or a combination of both. Rebuses first became popular in France, where they were at first called *rébus de Picardie*, that province, according to G. Ménage (1613-1692), having been the scene of their origin, which he found in the satires written by the students and young clerks on the foibles of the day under the title "*De rebus quae geruntur*." Camden mentions an instance of this kind of wit in a gallant who expressed his love to a woman named Rose Hill by painting in the border of his gown a rose, a hill, an eye, a loaf and a well; this, in the style of the rebus, reads "Rose Hill I love well." This kind of wit was happily ridiculed by Ben Jonson in the humorous description of Abel Druggers' device in the *Alchemist* and by

the *Spectator* in the device of Jack of Newberry. The name is also applied to arrangements of words in which the position of the several vocables is to be taken into account in divining the meaning. Thus "I understand you undertake to overthrow my undertaking" makes the rebus

stand I	take you	to throw	taking my;
------------	-------------	-------------	---------------

or in French

pir un	vent vient	venir d'un
-----------	---------------	---------------

may be read "un soupir vient souvent d'un souvenir." A still simpler French rebus is expressed by the two letters *G a*, which may be read, *J'ai grand appétit (G grand, a petit)*. "Rebus" (or "allusive arms"), in heraldry, is a coat of arms which bears an allusion to the name of the person,—as three castles for Castleton, three cups for Butler, three conies for Coningsby.

RÉCAMIER, JEANNE FRANÇOISE JULIE ADÉLAÏDE (1777-1849), a famous Frenchwoman in the literary and political circles of the early 19th century, was born on the 4th of December 1777 at Lyons. Her maiden name was Bernard. She was married at fifteen to the banker Jacques Récamier (d. 1830), who was more than old enough to be her father. Beautiful, accomplished, with a real love for literature, she possessed at the same time a temperament which protected her from scandal, and from the early days of the consulate to almost the end of the July monarchy her salon in Paris was one of the chief resorts of literary and political society that pretended to fashion. The *habitués* of her house included many former royalists, with others, such as Bernadotte and General Moreau, more or less disaffected to the government. This circumstance, together with her refusal to act as lady-in-waiting to the Empress Josephine and her friendship for Madame de Staël, brought her under suspicion. It was through Madame de Staël that Madame Récamier became acquainted with Benjamin Constant, whose singular political tergiversations during the last days of the empire and the first of the restoration have been attributed to her persuasions. Madame Récamier was eventually exiled from Paris by Napoleon's orders. After a short stay at Lyons she proceeded to Rome, and finally to Naples, where she was on exceedingly good terms with Murat and his wife, who were then intriguing with the Bourbons. She persuaded Constant to plead the claims of Murat in a memorandum addressed to the congress of Vienna, and also induced him to take up a decided attitude in opposition to Napoleon during the Hundred Days. Her husband had sustained heavy losses in 1805, and she visited Madame de Staël at Coppet in Switzerland. There was a project for her divorce, in order that she might marry Prince Augustus of Prussia, but though her husband was willing it was not arranged. In her later days she lost most of the rest of her fortune; but she continued to receive visitors at the Abbaye-aux-Bois, the old Paris convent to which she retired in 1814. Here Chateaubriand was a constant visitor, and in a manner master of the house; but even in old age, ill-health and reduced circumstances Madame Récamier never lost her attraction. She seems to have been incapable of any serious attachment, and although she numbered among her admirers Mathieu de Montmorency, Lucien Bonaparte, Prince Augustus of Prussia, Ballanche, J. J. Ampère and Constant, none of them obtained over her so great an influence as did Chateaubriand, though she suffered much from his imperious temper. If she had any genuine affection, it seems to have been for Prosper de Barante, whom she met at Coppet. She died in Paris on the 11th of May 1849.

There are well-known portraits of her by Louis David in the galleries of the Louvre, and by François Gérard in the possession of the préfecture of the Seine. In 1859 *Souvenirs et correspondances tirés des papiers de Madame Récamier* was edited by Mme Lenormant. See Mme Lenormant's *Madame Récamier, les amis de sa jeunesse et sa correspondance intime* (1872); Mme Mohl, *Madame Récamier*, with a sketch of the history of society in France (1829 and 1862); also Guizot in the *Revue des deux mondes* for December 1859 and February 1873; H. Noel Williams, *Madame Récamier*

and her Friends (London, 1901); E. Herriott (Engl. trans., by Alys Hallard), *Madame Récamier et ses amis* (1904) (elaborate and exhaustive).

RECANATI, a city of the Marches, Italy, in the province of Macerata, 8 m. direct N.N.E. of the city of that name. Pop. (1901) 14,590 (town), 16,389 (commune). It has a station on the railway 17½ m. S. of Ancona, and distant 4½ m. from the town, which is built on a hill, 931 ft. above the sea, and retains portions of its 15th-century walls and gateways. It was the birthplace of the poet Leopardi (1798-1837), whose monument adorns the principal piazza and whose family has collected in the town a very interesting museum of Leopardiana; it also contains fine old mansions of the Leopardi, Mazzagalli, Massucci and Carradori in the main street, and a Gothic cathedral, built towards the close of the 14th century and dedicated to S Flavianus, patriarch of Constantinople. The churches of S Maria sopra Mercanti and San Domenico contain characteristic examples of the work of Lorenzo Lotto, as also does the new municipal palace, with a fine old battlemented tower, while the palace of Cardinal Venier has a fine Renaissance loggia by Giuliano da Maiano, who was probably responsible for the designs for the portals of S Agostino and S Domenico. The older buildings of the town are noteworthy for the curious terra-cotta work which adorns the majority of them.

Recanati appears as a strong castle in the 10th century or earlier. Round this gathered a community whose petty wars with Osimo (*Auximum*) called for the interference of Innocent III. in 1198. From Frederick II. it obtained the right of having a port on the Adriatic; and by Gregory IX. it was made a city and the seat of the bishopric transferred from Osimo. This oscillation between Guelf and Ghibelline continued characteristic of Recanati. Urban IV. abolished the "city" and bishopric; Nicholas IV. restored them. John XXII. again, in 1320, removed the bishopric and placed the city under interdict. The interdict was withdrawn in 1328 on payment of a heavy fine, but the bishopric remained in abeyance till 1357. Gregory XII., who on his deposition by the council of Constance was made papal legate of the sees of Macerata and Recanati, died in this city in 1417. The assistance rendered by Recanati to the popes in their struggles with the Sforza seems to have exhausted its resources, and it began to decline. Considerable damage was done by the earthquake of 1741; and the French, who were twice in possession of the city in 1797, pillaged it in 1799.

RECEIPT (M.E. *receite*, derived through Fr. from Lat. *recepta*, participle of *recipere*, to receive), in law, an acknowledgment in writing that a sum of money or other valuable considered has been received by the person signing the acknowledgment in discharge of a debt or other obligation. Such a receipt is prima facie evidence only of payment, and it may be shown, for example, that it was signed by mistake, or obtained by fraud or misrepresentation. By the Stamp Act of 1891, which repealed and re-enacted other acts, a duty of 1d. is imposed on every receipt or form of writing discharging a debt of £2 or upwards; the payment of the duty is denoted by affixing a penny stamp to the document, and the cancelling of the same by the person giving the receipt. By § 103 if a person gives a receipt, liable to duty, not duly stamped, or refuses to give a receipt, liable to duty, duly stamped or, on payment to the amount of £2 or upward, gives a receipt for a less sum than £2 or divides the amount paid with intent to evade the duty, he is liable to a fine of £10. A receipt not duly stamped may be stamped at the Inland Revenue Office within fourteen days on payment of a fine of £5 or within one month on payment of £10.

RECEIVER, in English law, an officer or manager appointed by a court to administer property for its protection, to receive rent or other income and to pay authorized outgoing. Receivers may be either appointed *pendente lite* or by way of equitable execution, e.g. for the purpose of enabling a judgment creditor to obtain payment of his debt, when the position of the real estate is such that ordinary execution will not reach it. Formerly receivers were appointed only by the court of chancery, but by the Judicature Act 1873 it is now within the power of all

divisions of the High Court to appoint receivers. Their powers and duties are exhaustively set by Kerr, *On Receivers* (5th ed., 1905), who classifies the cases in which they may be appointed under the following heads: (a) infants; (b) executors and trustees; (c) pending litigation as to probate; (d) mortgagor and mortgagee; (e) debtor and creditor; (f) public companies; (g) vendor and purchaser; (h) covenantor and covenantee; (i) tenant for life and remainderman; (j) partners; (k) lunacy; (l) tenants in common; (m) possession under legal title, and (n) other cases. The appointment of receivers is entirely within the discretion of the courts, and the power may be exercised "in all cases in which it shall appear just and convenient." Application for a receiver is usually made by motion, and the court will appoint the fittest person, without regard to who may propose him, the appointment of a receiver being for the benefit of all parties. Under the Conveyancing Act 1881, when a mortgagee has become entitled to exercise his powers of sale, he may, by writing under his hand, appoint such person as he think fit to be receiver. In bankruptcy practice a receiver, termed official receiver, is an officer of the court who in this capacity takes possession on the making of a receiving order, of all a debtor's assets. He is also an officer of the Board of Trade with the duty of taking cognisance of the conduct of the debtor and administering his estates (see BANKRUPTCY).

Receiver-general is the title given to a chief receiver, more especially as applied to the collection of public revenue. The title survived in the Inland Revenue up to 1801, but it is now only used as the designation of an officer of the duchy court of Lancaster, who receives the revenues, &c., of the duchy.

RECEPT (from Lat. *recipere*, to take back), a philosophical term, used by Romanes (*Mental Evolution of Man*, ii. 36, 37), on the analogy of "concept and percept," for mental images assumed to be produced by the simple repetition of percepts. The process is supposed to be the gradual elimination of elements in which the percepts disagree, and the emphasizing of those in which they agree. Thus the final residuum is a unity in difference. Recepts are, in fact, "spontaneous associations, formed unintentionally as what may be termed unperceived abstractions," i.e. what are generally known as "generic images."

RECESS (Lat. *recessus*, a going back, withdrawal, from *recedere*, to withdraw), a term particularly used of a cessation of work or relief from duty, e.g. of the periods during the life of a parliament when it is not sitting. The word is also applied to an indentation in a line, especially of a small alcove sunk in the wall of a room. A particular use is the historical one for the acts and decrees of the Imperial Diet, the *recessus Imperii*, and also for those of the Hansatic League. According to Du Cange (s.v. *Recessus*) the reason for the use of this word was that these decrees, &c. (*codex deliberationum*), were written out *antequam a conventibus recedant proceres congregati*.

RECHABITES, or SONS OF RECHAB, a sort of religious order among the Israelites in some respects analogous to the NAZARITES (q.v.), with whom they shared the rule of abstinence from wine. They also eschewed the luxuries and pursuits of settled life, and lived in tents, refusing to sow grain as well as to plant vineyards. They represent a protest against the contemporary Canaanite civilization and a reaction towards the simplicity of life which was felt more strongly in Judah or to the east of the Jordan than in the northern kingdom of Israel. Their "father," or founder, was that Jehonadab or Jonadab, son of Rechab, who encouraged Jehu to abolish the Tyrian Baal-worship (2 Kings x.). The order founded by Jehonadab must from its constitution have soon become a sort of hereditary clan, and as such the "house of Rechab" appears in Judah after the fall of the northern kingdom and continued to observe the ordinance of Jehonadab till the approach of Nebuchadrezzar drove them for protection into Jerusalem (Jer. xxxv.). Jeremiah promised them as a reward of their obedience that they should never lack a man to represent them (as a priest) before Yahweh, whence perhaps the later Jewish tradition that the Rechabites intermarried with the Levites and so entered the temple service.

Later references to them probably indicate that the term was used as meaning merely ascetes (Euseb., *H. E.* ii. 23), the particular form of asceticism (q.v.) being less essential. One may compare the modern society of total abstainers known as the "Rechabites." In 1 Chron. ii. 55 the "house of Rechab" is associated with the KENITES (q.v.) as a family of scribes. Their origin is ascribed to Hammath (conceivably the Naphtalite city, Josh. xix. 35), but in 1 Chron. iv. 12 Rechab (so the LXX) is of Calebite descent.

RECHBERG - ROTHENLÖWEN, JOHANN BERNHARD, COUNT (1806-1899), Austrian statesman, was the second son of the Bavarian statesman Count Aloys von Rechberg-Rothenslöwen (1766-1840). Johann Bernhard was destined for the Bavarian public service, his elder brother being a hereditary member of the Upper House in the parliament of Württemberg. He was educated at the universities of Strassburg and Munich, but he incurred the displeasure of King Louis I. by the part he played as second in a duel, and in 1828 he transferred himself to the Austrian diplomatic service. After being attached to the embassies in Berlin, London and Brussels, he was appointed envoy at Stockholm (1841) and at Rio de Janeiro (1843). Returning to Europe in 1847, on the outbreak of the revolution of 1848 in Vienna he was of great service to Prince Metternich, whom he accompanied and assisted in his flight to England. In July 1848 he was appointed Austrian plenipotentiary in the German federal diet at Frankfort, in 1851 became Austrian *internuncius* at Constantinople, and in 1853 Radetzky's civilian colleague in the government of Lombardo-Venetia. In 1855 he returned to Frankfort as Austrian representative and president of the federal diet. As a pupil of Metternich he would have wished to preserve the good understanding with Prussia which seemed the necessary foundation for a conservative policy; he was, however, made the instrument for the anti-Prussian policy of Buol; this brought about constant disputes with Bismarck, at that time Prussian envoy at the diet, which were sharpened by Rechberg's choleric temper, and on one occasion nearly led to a duel. Bismarck, however, always expressed a high appreciation of his character and abilities. In May 1859, on the eve of the war with Italy, he was appointed Austrian minister of foreign affairs and minister president, surrendering the latter post to the archduke Rainer in the following year.

The five years during which Rechberg held the portfolio of foreign affairs covered the war with Italy and France, the insurrection in Poland, the attempted reform of the German Confederation through the Frankfort *Fürstentag*, and the Austro-Prussian war with Denmark. After the defeat of Magenta Rechberg accompanied the emperor to Italy, and he had to meet the crisis caused by a war for which he was not responsible. He began the concessions to Hungary and in the Polish question, and was responsible for the adhesion of Austria to the alliance of the Western Powers. In the German question Rechberg's policy was one of compromise. To the project of the *Fürstentag* he was altogether opposed. The project had been suggested to the emperor Francis Joseph by his son-in-law, the hereditary prince of Turn and Taxis, and by a pamphlet of Julius Fröbel, and the preliminary arrangements were made without Rechberg being informed. When at last he was told, he tendered his resignation, which was not accepted, and he accompanied the emperor to the abortive meeting at Frankfort (August 1863). The attempt made by Rechberg at the subsequent ministerial conference at Nuremberg to establish a German league without Prussia was equally unsuccessful, and he now returned to the policy, which in opposition to Schmerling he had throughout advocated, of a peaceful arrangement between Prussia and Austria as the indispensable preliminary to a reform of the Confederation.

At this juncture the death of King Frederick VII. of Denmark (15th of November 1863) opened up the whole Schleswig-Holstein question (q.v.). In the diplomatic duel that followed Rechberg was no match for Bismarck. It suited Austrian policy to act in concert with Prussia against Denmark; but Rechberg well knew that Bismarck was aiming at the annexation of the duchies. He attempted to guard against this by laying

down as a condition of the alliance that the duchies should only be separated from Denmark by common consent of the two German powers. Bismarck, however, insisted that the question of the ultimate destination of the duchies should be left open; and, when he backed his argument with the threat that unless Austria accepted his proposal Prussia would act alone, Rechberg gave way. His action was made the object of violent attacks in the Austrian Lower House (28-30 January 1864), and when the war was victoriously concluded and Prussia's designs on the duchies had become evident, public opinion turned more and more against him, demanding that Austria should support the duke of Augustenburg even at the risk of war. Rechberg yielded so far as to assure the duke's representative at Vienna that Austria was determined to place him in possession of the duchies, but only on condition that he did not sign away any of his sovereign rights to Prussia. The outcome of this was that the duke refused the terms offered by King William and Bismarck.

On the 22nd of August there was a meeting of the emperor Francis Joseph and King William at Schönbrunn, both Rechberg and Bismarck being present. Rechberg himself was in favour of allowing Prussia to annex the duchies, on condition that Prussia should guarantee Austria's possession of Venice and the Adriatic coast. On the first point no agreement was reached; but the principles of an Austro-Prussian alliance in the event of a French invasion of Italy were agreed upon. This latter proposal was, however, received with violent opposition in the ministry, where Rechberg's influence had long been overshadowed by that of Schmerling; public opinion, utterly distrustful of Prussian promises, was also greatly excited; and on the 27th of October Rechberg handed in his resignation, receiving at the same time the order of the Golden Fleece from the emperor as a sign of special favour. He had been made an hereditary member of the Upper House of the *Reichsrat* in 1861, and as late as 1879 continued occasionally to take part in debates. He died at his château of Kettenhof near Vienna on the 26th of February 1899. He had married, in 1834, Barbara Jones, eldest daughter of the 6th Viscount Ranelagh, by whom he had one son, Count Louis (b. 1835).

See the biography by Franz Ilwof in *Allgemeine Deutsche Biographie*, B. 53. *Nachträge* (Leipzig, 1907).

RECIDIVISM (from Fr. *récidiver*, to relapse and fall again into the same fault, or repeat the same offence as one committed before), a modern expression for "habitual crime." The recidivist is now universally known to exist in all civilized countries as one who has adopted wrong-doing and law-breaking as a profession. His persistency is ceaseless and inextinguishable by the ordinary methods of combating crime. Penal justice as generally exercised is unavailing, and is little better than an automatic machine which draws in a vast number within its wheels and casts them out again practically unchanged in character to qualify again for the ineffective treatment. This dangerous contingent is for ever on the move, into prison and out of it and in again; a large proportion of it, the criminal residuum, the very essence of the criminality of a country, resists all processes devised for its regeneration and cure. Nothing will mend it; neither severity nor kindness, neither the most irksome restraints nor the philanthropic methods of moral and educational persuasion. This failure has encouraged some ardent reformers to recommend the system of indefinite imprisonment or the indeterminate sentence, by which the enemy once caught is kept perpetually or for a lengthy period, and thus rendered innocuous. Habitual offenders, it is argued, should be detained as hostages until they are willing to lay down their arms and consent to make no further attempt to attack or injure society. The theory is sound and has been adopted in part in several countries, especially in the United States.

It was not until 1909 that the system of preventive detention was put into operation in the United Kingdom, when, by the Prevention of Crime Act 1908, power was given to the courts to pass on habitual criminals a sentence of preventive detention

in addition to one of penal servitude. This further period may range within limits of from five to ten years, according to the discretion of the court. The English system is hardly more than tentative at present; the machinery is admittedly capable of improvement. The charge of being an habitual criminal has to be inserted in the indictment on which the offender is to be tried, and this cannot be done without the consent of the director of public prosecutions and after certain notice has been given to the officer of the court trying the prisoner and to the offender himself. The decision to charge a prisoner with being an habitual criminal has hitherto rested on the local police authorities, and it has been felt that a more even and a more general application of such a drastic method of treatment would result if the decision were transferred to one authority, and some such reform was foreshadowed by the Home Secretary in a speech in the House of Commons on prison reform on the 20th of July 1910.

RECIFE, or **PERNAMBUCO**, a city and seaport of Brazil, capital of the state of Pernambuco, in 8° 3' S. and 34° 55' W., near the extreme eastern point of South America. Pop. (1904 estimate) 186,000. Recife is frequently called the "Venice of America"; it is at the mouths of the rivers Beberibe and Capibaribe which unite to form a small lagoon or bay inside the sea beach. In the angle between the two rivers is the delta island of Antonio Vaz. The city is built on the southern extremity of the sandy sea beach, on the island of Antonio Vaz, and on the mainland to the westward, the river channels being crossed by numerous bridges. With the exception of the hills on which Olinda is built about 5 m. northward, the surrounding country is low and flat, the general elevation averaging 10 ft. As the tide rises about 6 ft., the general level of the city and neighbouring coast, which is wet and swampy to the southward, is too low to be generally healthy, and Pernambuco has a high death-rate (52½ per 1000 in 1904), with malaria as one of the principal causes of death. The climate is hot, although agreeably tempered by the S.E. trade winds; the temperature ranges from an absolute minimum of 61° to an absolute maximum of 99° (1904). The rainfall (1904) is 75.3 in. The three principal parishes of the city are known as São José do Recife, occupying the sandy peninsula or beach north of the outlet of the united rivers; Santo Antonio, on the island of Antonio Vaz, which was called Mauritania or Mauritzstad during the Dutch occupation; and Boa Vista, on the mainland to the westward, which is the most modern and the most rapidly growing part. The first is the oldest and most crowded section, and is now devoted chiefly to the commercial and financial interests of the port; here are the custom house, merchants' exchange (Praça do Commercio), shipping offices, banks and wholesale houses. Santo Antonio dates from the Dutch occupation. Prince Maurice of Nassau, when governor-general, built here his private residence (Fribourg House) and made it his capital. Its business edifices and residences are largely of Dutch architecture, with many storeys and steep roofs. The older part of Boa Vista dates from the 17th century. Recife has few public squares or gardens, and its streets are not usually well cared for. The older buildings are of the Portuguese type, usually plain, low and heavy, constructed of broken stone and mortar, and plastered and coloured on the outside. The city has gas and electric illumination, street and suburban railways, drainage and a public water supply drawn from a small tributary of the Beberibe about 7 m. to the N.W., in the direction of Caxangá. Among its notable public buildings and institutions are the old government palace in Santo Antonio built upon the foundations of the official residence of Prince Maurice of Nassau, with a pretty garden attached; a theatre facing upon the Praça da Republica, dating from the second empire; the palace of the Provincial Assembly in Boa Vista, built in 1860-66, surmounted by a high dome; the municipal palace, or prefecture, on Rua do Imperador, with the public library (Biblioteca Publica) occupying its third floor and containing about 30,000 volumes; the Gymnasium, a large plain building of two floors standing near the legislative palace; the Pedro II. hospital

built between 1847 and 1861; a large penitentiary, insane asylum, orphans' asylum, and beggars' asylum; a law school, artisans' school (Lyceu de Artes e Officios), and archaeological institute; a normal school and school of engineering; and war and naval arsenals. One of the most attractive churches is that of Nossa Senhora da Penha, surmounted by two slender spires and a dome.

The port of Recife is one of the most important of Brazil, on account of its proximity to Europe and its convenience for vessels passing around the east shoulder of the continent. It is the landing-place for two transatlantic and one coastwise cable lines. Its harbour consists of an outer and inner anchorage, the former an open roadstead, which are separated by a remarkable stone reef running parallel with the shore-line, leaving an inside passage 400 to 500 ft. wide. The entrance to the inner anchorage, which has a depth of about 20 ft., is opposite Fort Brum in the northern part of the city, and is marked by a small Dutch fort (Picão) and a lighthouse at the northern extremity of the reef. This remarkable natural breakwater, which is about 50 ft. wide on top and has been repaired with masonry in some places, covers a considerable part of the coast-line in this part of Brazil. It is not a coral reef, as is sometimes stated, but is a consolidated ancient beach, now as hard and firm as stone.¹ In 1910 contractors were at work on improvements to the port to cost about £1,666,000, under a decree of the 3rd of December 1908. The exports include sugar, rum, cotton, hides, skins, rubber, wax, fibres, dyewoods, cacáu, mandioca flour, pineapples and other fruits. Pernambuco is the principal sugar-producing state of Brazil, and Recife is therefore an important centre for this product. Its railway communications with the interior are good, and include the Sul de Pernambuco, Recife and São Francisco, Central de Pernambuco, and the Recife to Limoeiro lines, the first three now being under the management of the Great Western of Brazil Co. There are also suburban lines to Olinda and Caxangá, the latter providing communication with some of the prettiest suburbs about the city.

Recife was settled about 1535, when Duarte Coelho Pereira landed there to take possession of the captaincy granted him by the Portuguese crown. The site of Coelho's capital was Olinda, but Recife remained its port and did not become an independent *villa* (town) until 1710. Down to the close of the 18th century, when Rio de Janeiro became important, Recife was the second city of Brazil, and for a time its most important port. It was captured and plundered in 1595 by the English privateer James Lancaster. It was also captured by the Dutch in 1630 and remained in their possession till 1654, during which time the island of Antonio Vaz was occupied and the town greatly improved. At the end of the Dutch War the capital was removed from Olinda to Recife, where it has since remained.

RECIPE, a statement of the materials and ingredients used in the making and preparation of a dish for cooking, a receipt. This is the principal current use, which was first applied to medieval prescriptions from the custom of placing the word, meaning "take this" (imperative of Lat. *recipere*, to receive), often abbreviated R or ℞, at the head of the formula.

RECIPROCITY (Lat. *reciprocus*, returning back the same way, alternating, probably from *re* back and *pro* forward), the condition or state of being reciprocal, *i.e.* where there is give and take, mutual influence or correspondence between two parties, persons or things. In a more particular sense, reciprocity is a special arrangement between two nations under which the citizens of each obtain advantages or privileges in their trading relations with the other. This meaning of reciprocity, however, bears a different interpretation in European and in American usage. In the former, reciprocity between two nations usually means little more than the extension by one to the other of most favoured nation treatment, *i.e.* such advantages as it extends to any third country (see **COMMERCIAL TREATIES**).

¹ See J. C. Branner's *The Stone Reefs of Brazil* (Bul. Comp. Zool., Harvard Univ., xlv., Cambridge, 1904).

But in the United States reciprocity is the term applied to the concessions or arrangements made between that country and another without reference to any third country. Thus in the United States there are a maximum and minimum tariff, the rates of the maximum tariff being enforced on the goods of those countries which have no reciprocity treaty with the United States, and the rates of the minimum on certain products of those countries which have by a reciprocity treaty given special advantages or concessions to certain products of the United States.

RECITAL (from Lat. *recitare*, to read out, particularly of a public document), an account or repetition of the details of some act, proceeding, fact, &c., particularly, in law, that part of a legal document, such as a lease, which contains a statement of certain facts, *e.g.* the purport for which the deed is made. In music, the word is used of an instrumental performance given by a single person, and also of a performance of the works of a single composer.

RECKLINGHAUSEN, a town of Germany, in the Prussian province of Westphalia, 22 m. by rail N.W. of Dortmund on the railway to Münster. Pop. (1905) 44,396. In the neighbourhood are extensive coal-mines and brick-works, and the industries embrace the manufacture of linen, beer, spirits and tobacco.

The county of Recklinghausen belonged to the archbishopric of Cologne until 1803, when it passed to the duke of Arenberg. It was known as the Vest Recklinghausen. In 1810 it was divided by Napoleon between the grand duchy of Berg and France, but was, in 1815, restored to the duke of Arenberg as a fief under Prussian sovereignty.

See Ritz, *Die ältere Geschichte des Veste und der Stadt Recklinghausen* (Erzen, 1904).

RECLAMATION OF LAND. The boundaries between sea and land are perennially changing. In many sheltered bays and estuaries the sea is receding, while along other portions of the sea-coast it is continuously encroaching. The same causes operate to produce both results: the rivers carry down with them detritus and sediment from the higher ground; the sea, aided by wind and tide, is always eroding exposed portions of the seaboard; and even such lesser influences as rain and frost assist in disintegrating cliffs composed of softer strata.

The main object of reclaiming land from the sea is to increase the area of ground available for cultivation. Land which has been raised by accretion nearly to high-water level can be shut off from the sea by works of a simple and inexpensive nature, and the fresh alluvial soil thus obtained is generally very fertile.

Accretion in estuaries takes place very slowly under ordinary conditions. Although at any one time the sheltered areas may be large and the deposit of silt fairly rapid, not much permanent accretion will take place owing to the frequent shifting of the channels. Directly, however, a fixed channel is secured by longitudinal embankments or training walls, accretion progresses rapidly and uninterruptedly by the deposit of sediment in the slack-water behind the embankments and at the sides of the estuary; and this is especially the case if the training works are raised to the level of high water, for this has the effect of restricting the greater part of the scour of tide and fresh-water discharge to the one fixed channel. The rate of accretion varies with the shelter of the site and the amount of sediment carried by the water; but by degrees the foreshores, in the upper portion and at the sides of the embanked estuary, are raised sufficiently for samphire to make its appearance, and, later on, a coarse grass. Ultimately the time arrives when the water may be altogether excluded by the construction of enclosing embankments; these must be raised above the level of the highest tide, and should have a flat slope on the exposed side, protected, in proportion to exposure and depth of water, against the face with clay, sods, fascines or stone pitching.

In the intermediate stages of the process outlined above much may be done to promote the growth of accretion, or warping as it is termed, and to ensure the fertility of the reclaimed land. The deposit of warp is accelerated by anything which tends to reduce the flow and consequent scour of the ebb-tide over the

foreshore: thus considerable advantage will accrue from placing rows of faggots or sods across the lines of flow; and banks, enclosing the higher portions of the foreshore, may often be constructed so as materially to increase the period of stagnation, near high tide, of the silt-bearing water upon the lower adjacent foreshore. The light, fertilizing alluvium only deposits in shallow water at high tide, and where there are no tidal currents. The final enclosure, therefore, should not be effected until this deposit has taken place. The enclosing works, also, should be so carried out that increasing shelter may favour the deposits of this alluvium during construction. A final and rapid deposit can sometimes be effected by making sluices in the banks: the turbid water is admitted near high tide, and retained until the whole of its silt has been deposited, the clear water being allowed to escape slowly towards low tide. Premature enclosure must be guarded against; it is more difficult, the cost greater, the reclaimed land is less fertile and, being lower, less easy to drain.

The practice of reclaiming land in British estuaries is a very ancient one. The Romans effected reclamations in the Fen districts; the enclosing of Sunk Island in the Humber was begun in the 17th century, and now produces an annual revenue of something like £10,000; large reclamations in the Dee estuary took place in the 18th century; and, in recent times, works have been carried out in the estuaries of the Seine, the Ribble and the Tees.

In the reclamation of land adjoining the sea-coast, sites where accretion is taking place are obviously the most suitable. Marsh lands adjoining the sea, and more or less subject to inundation at high tides, can be permanently reclaimed by embankments; but these, unless there is protection from sand dunes or a shingle beach, require to be stronger, higher, with a less steeply inclined and better protected slope than is required in estuaries. The width of the bank will generally prevent percolation of water at the base; but if there is any danger of infiltration, owing to unsuitability of material, a central core of puddled clay or a row of sheet-piling should be employed. Waves overtopping the bank will quickly cause a breach, and produce disastrous results; the height of the bank must, therefore, be calculated to meet the case of the severest on-shore gale coinciding with the highest spring tide. Undermining, caused by the recoil of waves on the beach, is liable to occur in exposed sites; this may be prevented by a line of sheet-piling along the outer toe of the bank.

Sea-coast embankments should not generally be constructed farther down the foreshore than half-tide level, as the cost of construction and maintenance would increase out of all proportion to the additional area obtained. It is, as a rule, more economical to reclaim a large area at one time, instead of enclosing it gradually in sections, as the cost varies with the length of embankment; it is, however, more difficult to effect the final closing of a bank, where a large area is thus reclaimed, on account of the greater volume of tidal-water flowing in and out of the contracted opening. The final closing of a reclamation embankment is best accomplished by leaving a fairly wide aperture, and by gradually raising a level bank across its entire length. The enclosed area may be left full of water to the height of the unfinished bank, or the tide-water may be allowed to escape and enter again by sluices in the finished sections. The embankments in Holland are closed by sinking long fascine mattresses across the opening; these are weighted with clay and stone, and effectually withstand the scour through the gap; the two terminal slopes of the finished sections are similarly protected.

There are many examples of sea-coast reclamation: Romney marsh was enclosed long ago by the Dymchurch wall (see fig. 1), and a large portion of Holland has been reclaimed from the sea by embankments (see fig. 2); the reclamation bank for the Hodbarrow iron mines (see fig. 3) illustrates the use of puddled clay to prevent infiltration.

The repair of a breach effected in a completed reclamation embankment is a more difficult task than that of closing the

final gap during construction; this is owing to the channel or gully scoured out upon the opening of the breach. When a

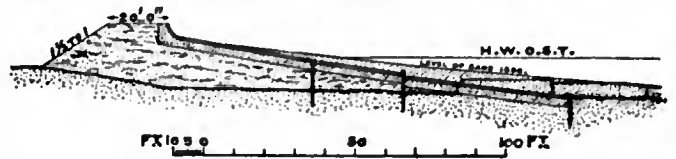

FIG. 1.—Sea-wall at Dymchurch.

breach occurs which cannot be closed in a single tide, the formation of an over-deep gully may to some extent be prevented

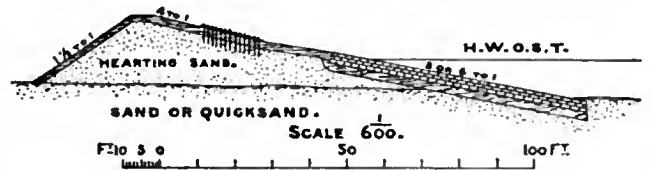

FIG. 2.—Dutch Reclamation Embankment.

by enlarging the opening. Breaches in embankments have been closed by sinking barges across the gap, by piling and planking

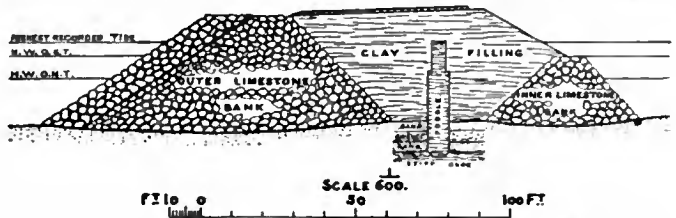

FIG. 3.—Reclamation Bank for the Hodbarrow Iron Mines.

up, by lowering sliding panels between frames erected to receive them, and by making an inset wall or bank round the breach. By the last-mentioned method the new connecting bank can be formed on solid ground, and the necessary width of opening obtained to obviate excessive scour during the influx and efflux of the tide over the bank while it is being raised.

The gradual drying of reclaimed land lowers the surface some two or three feet; the land therefore becomes more liable to inundation after reclamation than before. Accordingly, it is most important to prevent breaching of the bank by promptly repairing any damage caused by storms; and if a breach should occur, it must be closed at the earliest possible opportunity.

The protection of the coast-line from encroachment by the sea is a matter of considerable importance and great difficulty: the more rapid the erosion, the more exposed must be the site; and, consequently, the more costly will be the construction and maintenance of protective works. These are of two kinds: sea-walls or banks, and groynes.

Upright sea-walls with some batter on the face have been constructed along the frontage of many sea-side towns, with the double purpose of making a promenade or drive, and of affording protection to the town. A very sloping and also a curved batter breaks the stroke of the wave by facilitating its rising up the face of the wall, but the force of the recoil is correspondingly augmented. A wall with a vertical face offers more direct opposition to a wave, minimizes the tendency to rise, and consequently the recoil; while a stepped face tends to break up both the ascending and recoiling wave in proportion to the recession of the steps, but there is a corresponding liability to displacement of the blocks composing the wall. The concrete sea-walls erected in front of Hove, Margate, and the north cliff at Scarborough (see figs. 4, 5, 6) exhibit straight, stepped, and curved forms of batter. The curvature of the last-named wall, though diverting the coil at its base, did not prevent erosion of the shale bed on which it was founded, and a protective apron in front of the toe had to be added subsequently.

The Beaconsfield sea-wall at Bridlington (see fig. 7) is stepped and slightly curved; it has a stone face with concrete backing,

strengthened at intervals by counterforts. The thickness of the wall varies from 11 ft. 6 in. at the base to 3 ft. at the top, and is

had to be protected from undermining at the toe with piles and planks, and an apron of concrete or pitching, laid on fascines, extending down the foreshore. For the parts above high-water mark a short paved slope, with moderate protection at the toe, has been found sufficient. The top face of these slopes is reflexed so as to protect the esplanade from surf during storms.

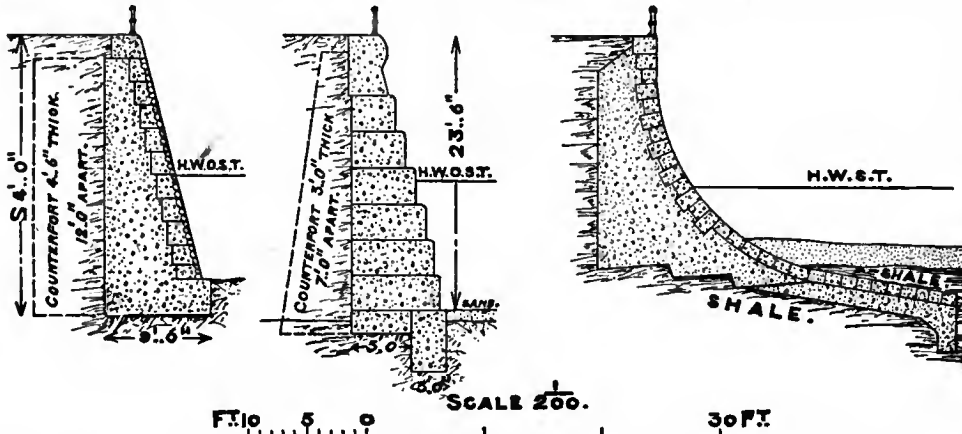

FIG. 4.—Sea-wall at Hove. FIG. 5.—Sea-wall at Margate. FIG. 6.—Sea-wall at Scarborough.

surmounted by a dressed cornice and coping; the length is 340 yards. The work was constructed, in 1888, at a cost of £10,000, or £29, 8s. per lineal yard.

Walls with almost vertical faces, or slightly stepped, appear to be the best. Unless, however, the foreshore consists of hard rock, or a raised beach maintained by groynes, a wall of this kind should be protected by an apron, in order to prevent the

Sea-walls are very costly and, while temporarily resisting, do not diminish, but actually increase, the erosive action of the sea. In short, sea-walls are a most unsatisfactory type of protective work.

The protection afforded to the coast by groynes is based on a totally different principle, which may be summarized as that of promoting natural accretion by the construction of artificial shelter. Along most coasts there is a littoral drift of sand or shingle; by means of groynes, projecting from the coast-line down the beach, this drift may be intercepted so as to produce accretion to the foreshore, where previously there has been constant erosion. The problem, however, of coast protection by this method presents difficulties. Littoral drift is the product of erosion, and the fate of a large portion of this drift is to be deposited in deep water. Any scheme, therefore, of stopping erosion altogether by means of groynes would be purely chimerical; in the same way, partial failure of groynes, from lack of drift and inability to stop wastage, must be expected in many localities. Another difficulty may be illustrated by the action of such natural projections as Dungeness: this point, by completely arresting the easterly drift of shingle, causes a rapid accretion to the beach on the one side, but a corresponding denudation on the other. The old type of high groyne, erected at Cromer and Hastings, has produced the same undesirable result; moreover, the general effect of groyning certain portions of the foreshore is to render the adjacent unprotected portions more liable to erosion. Nevertheless, the benefit which may be derived locally from suitable groyning is very great. The timber groynes erected between Lancing and Shoreham raised the shingle beach sufficiently to cause high-water mark to recede 85 ft. seawards in the course of a few years.

The eroding action of the river Scheldt in front of Blankenberghe has been arrested by carrying out groynes at right angles to the coast-line, and down to below low water (see

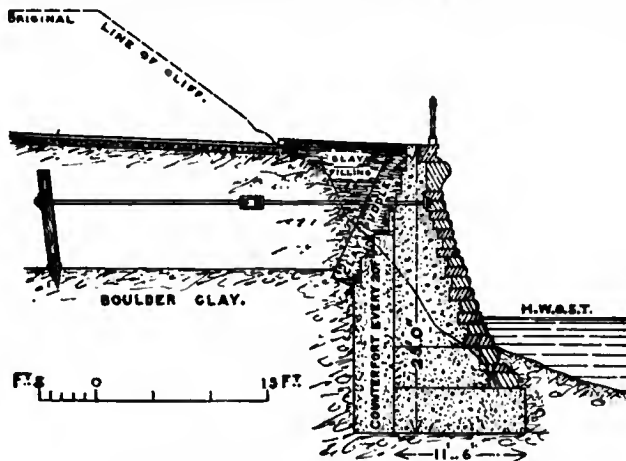

FIG. 7.—Sea-wall at Bridlington.

destructive undermining to which such forms of wall are necessarily liable.

Where the coast is fringed with sand dunes, and the beach protected from erosion by a regular series of groynes, as at Ostend (Belgium), the sand dunes, or an embankment for a promenade in front of them, may be sufficiently protected by a simple slope, paved with brickwork or masonry, and having a maximum inclination of two to one. The paving requires to be laid on a bed of clay, rubble or concrete. Parts of the sea bank at Ostend

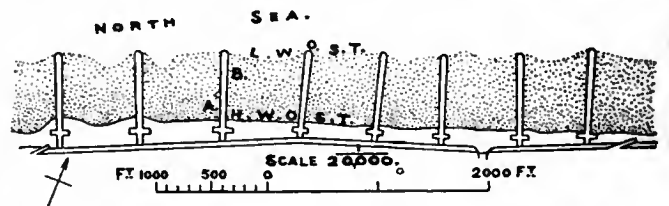

FIG. 9.—Groynes on North Sea coast at Blankenberghe.

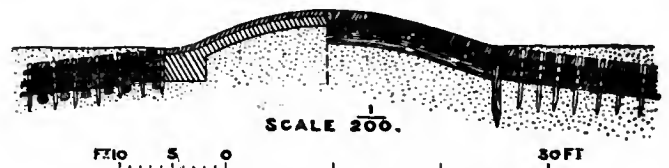

FIG. 10.—Sections of Groynes at Blankenberghe.

figs. 9, 10). These, on the average, are about 820 ft. long and 680 ft. apart: they are made wide, with a curved top raised only slightly above the beach, so as to minimize the scour from currents and wave action, and facilitate the ever

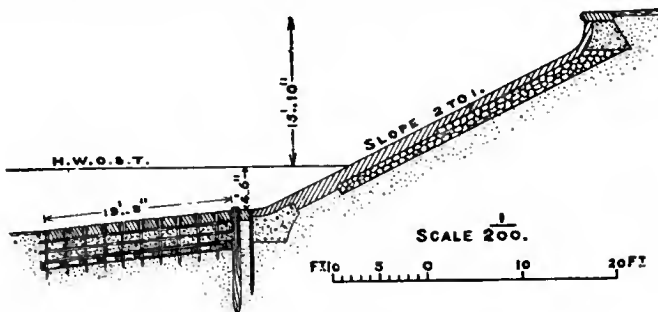

FIG. 8.—Sea Embankment at Ostend.

(see fig. 8) have been carried out beyond high-water mark to gain a strip of land for the esplanade; and these portions have

distribution of drift over the protected area. They are constructed with a foundation of fascines and concrete, faced with brickwork or stone pitching. The result has been the formation of a gently sloping beach which reduces wave action; such loss, too, as is still occasioned by storms is speedily made good by natural accretion in moderate weather. The Blankenberghe groynes are too expensive a type for ordinary use. The beach at Bridlington, which rests on boulder clay, was rapidly disappearing owing to the increased scour due to the sea-walls. Accordingly, groynes (see figs. 11, 12) made

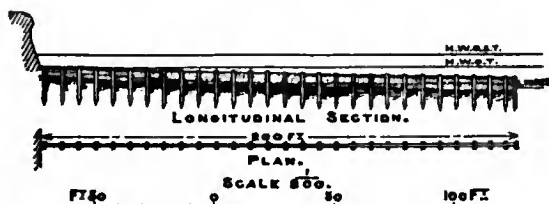

FIG. 11.—Groyne at Bridlington.

of 14 ft. × 9 in. × 9 in. pitch-pine piles, and 11 in. × 4 in. planking, were erected along the foreshore. The piles originally projected about 6 ft.; but, to prevent heaping up of sand to windward with denudation to leeward, the planking was never raised more than two strakes above sand-level, fresh planks being added as the sand rose. The south-easterly gales are said to be the most erosive here, and prevalent during the winter months; on this account the groynes were given an inclination of 10° south of east, that is 10° from the perpendicular. It may be doubted whether this was the best angle, but the result has been very satisfactory. The cost of construction was from 12s. 3d. to 18s. per lineal foot.



FIG. 12.—Enlarged cross-section of Groynes.

The sand-banks at the entrance to Poole Harbour have been protected by groynes (see fig. 13) inclined at slightly varying

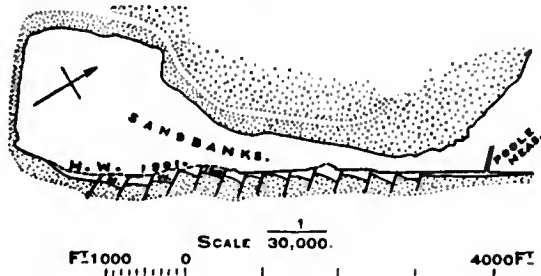

FIG. 13.—Groyne for Protecting the Sand-banks enclosing Poole Harbour.

angles, some yielding better results than others. This is a good example of the important work which may be accomplished by groyning. Unprotected, a breach would soon have been effected in these sand-banks; with a double entrance to the bay the present deep channel would have silted up, and Poole Harbour would have been practically destroyed.

It is evident that the efficacy of groynes in collecting drift is proportionate to the distance which they can be carried out seawards, and that they should always be extended to low-water mark; whilst, by raising them only slightly above the beach, the accumulation of drift to leeward is promoted, the passage of drift over the obstruction being facilitated and the scour of the waves diminished. By this means, and by gradually raising and extending the groynes as the drift accumulates, the general elevation of the beach can be secured. Drift generally travels in both directions along a coast, veering with the wind; thus the prevailing wind determines the preponderating travel of the drift. Groynes are usually con-

structed at right angles to the shore, but it is believed that increased benefit may be obtained by slightly inclining them to leeward of the prevailing wind. Some engineers have advocated the extension of groynes below low-water mark; and as wood when permanently submerged is specially liable, even when creosoted, to be attacked by the *teredo* and *limoria*, the use of reinforced or ferro-concrete has been suggested as the most suitable material for submarine groyning. These suggestions, however, and many other current theories on groyning, require to be demonstrated by repeated experiments.

For a useful bibliography of the subject see British Parliamentary Reports, *Coast Erosion and the Reclamation of Tidal Lands*, Cd. 3684, Appendix No. X. pp. 146-158. (L. W. V.-H.)

RECLUS, JEAN JACQUES ELISÉE (1830-1905), French geographer, was born at Sainte-Foy la Grande (Gironde), on the 15th of March 1830. He was the second son of a Protestant pastor, who had a family of twelve children, several of whom acquired some celebrity either as men of letters, politicians or members of the learned professions. His education, begun in Rhenish Prussia, was continued in the Protestant college of Montauban, and completed at the university of Berlin, where he followed a long course of geography under Karl Ritter. Withdrawing from France in consequence of the events of December 1851, he spent the next six years (1852-57) visiting the British Isles, the United States, Central America, and Colombia. On his return to Paris he contributed to the *Revue des deux mondes*, the *Tour du monde* and other periodicals a large number of articles embodying the results of his geographical work. Among other works at this period was an excellent short book, *Histoire d'un ruisseau*, in which he traces the development of a great river from source to mouth. In 1867-68 he published *La Terre; description des phénomènes de la vie du globe*, in two volumes. During the siege of Paris, Reclus shared in the aerostatic operations conducted by M. Nadar, and also served in the National Guard, while as a member of the Association Nationale des Travailleurs he published in the *Cri du Peuple* a hostile manifesto against the government of Versailles in connexion with the Communist rising of the 18th of March 1871. Continuing to serve in the National Guard, now in open revolt, he was taken prisoner on the 5th of April, and on the 16th of November sentenced to transportation for life; but, largely at the instance of influential deputations from England, the sentence was commuted in January 1872 to perpetual banishment. Thereupon, after a short visit to Italy, he settled at Clarens, in Switzerland, where he resumed his literary labours, and, after producing the *Histoire d'une montagne* (a companion to *Histoire d'un ruisseau*), wrote nearly the whole of his great work, *La Nouvelle Géographie universelle, la terre et les hommes*, 19 vols. (1875-94). This is a stupendous compilation, profusely illustrated with maps, plans, and engravings, and was crowned with the gold medal of the Paris Geographical Society in 1892. An English edition appeared simultaneously, also in 19 vols., the first four by E. G. Ravenstein, the rest by A. H. Keane. Extreme accuracy and brilliant exposition form the leading characteristics of all Reclus's writings, which thus possess permanent literary and scientific value. In 1882 Reclus initiated the "Anti-Marriage Movement," in accordance with which he allowed his two daughters to marry without any civil or religious sanction whatever. This step caused no little embarrassment to many of his well-wishers, and was followed by government prosecutions, instituted in the High Court of Lyons, against the anarchists, members of the International Association, of which Reclus and Prince Kropotkin were designated as the two chief organizers. The prince was arrested and condemned to five years' imprisonment, but Reclus, being resident in Switzerland, escaped. After 1892 he filled the chair of comparative geography in the university of Brussels, and contributed several important memoirs to French, German and English scientific journals. Among these may be mentioned "The Progress of Mankind" (*Contemp. Rev.*, 1896); "Attila de Gerando" (*Rev. Géograph.*, 1898); "A great Globe" (*Geograph. Journ.*, 1898); "L'Extrême-Orient" (*Bul. Antwerp Geo. Soc.*,

1898), a thoughtful study of the political geography of the Far East and its possible changes; "La Perse" (*Bul. Soc. Neuchâteloise*, 1899); "La Phénicie et les Phéniciens" (*ibid.*, 1900); *La Chine et la diplomatie européenne* ("L'Humanité nouvelle" series, 1900); *L'Enseignement de la géographie* (Inst. Géograph. de Bruxelles, No. 5, 1901). Shortly before his death Reclus had completed *L'Homme et la terre*, in which he set the crown on his previous greater works by considering man in his development relative to geographical environment. Reclus died at Thourout, near Bruges, on the 4th of July 1905.

RECOGNIZANCE (from Lat. *recognoscere*, to acknowledge), a term of English law usually employed to describe an obligation of record, entered into before some court or magistrate duly authorized, whereby the party bound acknowledges (recognizes) that he owes a personal debt to the Crown, with a defeasance, *i.e.* subject to a condition that the obligation to pay shall be avoided if he shall do some particular act—as if he shall appear at the assizes, keep the peace, or the like. The system of taking recognizances in favour of the Crown at an early date superseded the common law practice as to pledges and main-prize (see *re Nottingham Corporation*, 1897, 2 Q.B. 502, 514).

Blackstone's definition extends the term recognizance to bonds in favour of private persons. But at present it is rarely if ever used in this sense. Recognizances are now used almost solely with reference to criminal proceedings. In the Court of Chancery it was the practice to require recognizances from the guardian of a ward of court that the ward should not marry or leave the country with the privity of the guardian and without the leave of the court. The security given by a receiver appointed by the High Court is still in the form of a recognizance acknowledging a debt to named officers of the court, and securing it on the real and personal estate of the receiver.

By an act of 1360 (34 Edw. III. c. 1), extended to Ireland by Poyning's Act, and by the terms of the commission of the peace, justices of the peace have jurisdiction to cause to come before them or any one of them "all those who to any one or more of our people concerning their bodies or the firing of their houses have used threats to find sufficient security for the peace or their good behaviour towards us and our people; and if they shall refuse to find such security, then there in our prisons until they shall find such security to cause to be safely kept." The security taken is by recognizance of the party and his sureties, which can be forfeited on conviction of any offence which is a breach of the conditions of the recognizance.

The procedure under the act of 1360 and the commission is usually described as exhibiting articles of the peace or swearing the peace. The High Court (King's Bench Division) has the same power as justices in quarter sessions. This procedure is in practice superseded in England, so far as concerns courts of summary jurisdiction, by an equivalent but more modern procedure (42 & 43 Vict. c. 49, s. 25). Recognizances ordered under these enactments cannot be forfeited or as it is termed estreated without an order of court made upon proof of breach of the conditions, or of a conviction involving such breach. The procedure for estreats is governed by the Levy of Fines Acts 1822 and 1833, and by 16 & 17 Vict. c. 30, s. 2.

There is also a general jurisdiction on conviction of misdemeanour to put the offender under recognizances to keep the peace and (or) be of good behaviour in addition to or in substitution for other punishment. This power is specifically applied by the Criminal Law Consolidation Acts of 1861 to all indictable misdemeanours punishable under these acts, and power is given to put persons convicted of any felony (not capital) punishable under the acts under a recognizance to keep the peace. On refusal to enter into recognizances as above, the court may order imprisonment for the refusal, limited in cases within the acts of 1861 to twelve months, and in cases within the act of 1879 to six months.

The recognizances above described may be described as a form of punishment or a judicial security for good conduct. Recognizances are, however, most used with reference to proceedings before conviction and judgment. In preliminary inquiries into indictable offences the inquiring justices take recognizances to ensure the attendance of the accused if liberated during any adjournment, and on committal for trial take the recognizances of the accused (if allowed bail) to attend the court of trial and take his trial, and of the prosecutor and the witnesses for the prosecution or defence to attend and prosecute or give evidence. As to witnesses this power was first given in 1554 (1 Ph. & M. c. 13). The procedure

is regulated by the Indictable Offences Act 1848 (11 & 12 Vict. c. 42) as amended in 1867 (30 & 31 Vict. c. 35) and the forms of recognizance are scheduled to the act of 1848. In the case of inquisitions of murder or manslaughter taken before a coroner a similar procedure is followed (Coroners Act 1887, 50 & 51 Vict. c. 71, s. 5). The recognizances taken are returnable under penalty to the court of trial, which orders their estreat in the event of breach of the conditions.

Similar powers as to the recognizances of persons prosecuted summarily are given by the Summary Jurisdiction Acts 1848 and 1879; and in the event of appeals to quarter sessions or by special case to the High Court from courts of summary jurisdiction, recognizances or security are required from the appellant (42 & 43 Vict. c. 49, ss. 31, 33). On the transfer of indictments from inferior to superior courts recognizances to pay the costs on conviction are also required (Crown Office Rules, 1906). In certain cases the police have authority to give bail to accused persons on their entering into a recognizance; and governors of prisons are allowed to release prisoners on bail on compliance with the terms on which it is allowed by the committing justices.

By the Land Charges Act 1900 (63 & 64 Vict. c. 26, s. 2 (1)) a recognizance, whether obtained or entered into on behalf of the Crown or otherwise, does not operate as a charge on land or on any interest on land or on the unpaid purchase money for any land, unless a writ or order for the purpose of enforcing it is registered under s. 5 of the Land Charges, &c., Act 1888 (51 & 52 Vict. c. 51) in the office of the Land Registry. This enactment is clearly applicable to receivers' recognizances, *supra*; and on purchases of land search is made for registered recognizances and an official certificate can be obtained affirming or negating the existence of a registered entry (Conveyancing Act 1882, s. 2). By s. 30 of the Bankruptcy Act 1883, a discharge in bankruptcy does not release the debtor from debts on a recognizance unless the Treasury certifies in writing its consent to the discharge.

By ss. 32, 34 of the Forgery Act 1861, it is made felony to forge recognizances, and to acknowledge them in the name of another without lawful authority is also felony (24 & 25 Vict. c. 98).

In Scotland the place of recognizances is filled by cautions; a caution in "law-burrows" corresponds very nearly to a recognizance to keep the peace.

In the United States recognizances are used for much the same purposes as in England. (W. F. C.)

RECONNAISSANCE (from Fr. *reconnaître*, to recognize, Lat. *recognoscere*), a military term denoting the reconnoitring or examination of an enemy's position or movements, or of a tract of ground. Reconnaissances naturally vary indefinitely according to the purposes for which they are undertaken. A topographical reconnaissance is practically a survey of a tract of country or route, comprising both a map and a report as to its advantages and disadvantages. All reconnoitring work of this character is done by officers with small patrols, escorts or assistants. Strategical reconnaissance is performed by contact squadrons, which send forward officers and patrols to find the enemy. Tactical reconnaissance falls to the lot of troops of all arms, whether in contact with the enemy or for self-protection. A reconnaissance by a large force of all arms with the idea of provoking an enemy into showing his hand, if necessary by fighting, is called a reconnaissance in force.

RECORD (Lat. *recordari*, to recall to mind, from *cor*, heart or mind), a verb or noun used in various senses, all derived from the original one of preserving something permanently in memory. In this article, however, we are only concerned with documentary records, or archives. In its accurate sense a record is a document regularly drawn up for a legal or administrative purpose and preserved in proper custody to perpetuate the memory of the transaction described in it; for the most part it forms a link in a complicated process, and unless the connexion between it and the other documents making up the process has been preserved, a portion of its meaning will have perished. The first care, therefore, of the custodian of records should be to preserve this connexion, where it exists. In the majority of countries a previous task awaits him; it has been his duty to collect and arrange his documents. There are few countries in which records have not passed through a period of neglect; each office of state has kept or rather neglected its own papers; each court of justice has been the keeper of its own records; the student has been paralysed by a multitude of repositories among which he vainly sought the documents he required. To this stage two systems have succeeded; the system of centralization both of records and of

staff; and the system under which the records are left in local repositories and the staff is centralized. There are of course countries which cannot be brought under either of these formulae. But for the most part it will be found that the second system has prevailed; there are a central office for records of state, provincial offices for legal records and those of local administration, town offices for municipal records, and a staff of archivists depending more or less strictly upon the central office. In England the first system has been preferred; almost all the records that can be collected have been gathered into the central office. In the future, indeed, it is inevitable that collections of administrative records should grow up for each county; but there is at present no means of ensuring their arrangement and preservation. Many towns possess old and valuable collections of municipal archives, and over these also the central office has no control. It would be absurd to affirm that such control is needed for the preservation of the documents; but it is a curious fact that the English government, which has centralized records more freely than any other, should have refrained from establishing any system of administration for records in general. The following article is intended to give a full account of the administration and nature of the records of Great Britain, and brief notices of those of other countries concerning which information is obtainable. It may be noticed that the directory of the learned world published by Trübner at Strassburg under the title *Minerva* will be found a useful guide to the situation and staff of repositories of records.

England.

The most important repository of English records is the Public Record Office, Chancery Lane, London, established under the Act 1 & 2 Vict., c. 94. The head of the office is the Master of the Rolls for the time being; and the staff consists of the deputy-keeper, secretary, assistant-keepers and clerks, with a subordinate staff.

Until the establishment of this office, the records of the various courts of law and government offices were stored in separate places, mostly of an unsuitable nature, whose contents were inaccessible and unknown. The Tower of London contained the records of the Chancery, which were kept in fair order; the records of the Exchequer were scattered in many places, chiefly unsuitable; and other collections were almost as unfortunately bestowed: the only attempt to provide a special place of custody was made in the 17th century, when the State Paper Office was set up as a place of deposit for the papers of the secretaries of state. From time to time efforts were made, chiefly by means of committees of the House of Lords, to procure reforms in the custody of documents whose value was well understood. In the reign of Queen Anne, an attempt was made by Thomas Rymer to publish in the *Foedera* such documents as could be found bearing upon foreign politics; and this drew fresh attention to the question of custody. In 1731 the disastrous fire in the Cottonian Library produced a committee of the House of Commons and another report. But it was not until 1800 that any serious steps were taken. In that year a committee of the House of Commons presented a valuable report dealing with all the public records in repositories in England and Scotland. The result of this committee was the appointing of a royal commission charged with the arrangement and publication of the public records and the control of all public repositories. This commission was renewed from year to year and did not expire until 1837. It fell partly because of internal dissensions, but principally owing to gross extravagance and almost complete neglect of its duty, so far as the arrangement and custody of the records was concerned. The publications sanctioned by it are often badly designed and badly executed; but their most prominent characteristic was their expense. To this commission succeeded the Public Record Office, whose constitution has already been described. The first duty of the new office was the establishment of a central repository into which the scattered collections of records could be gathered; and the preparation of manuscript inventories of the documents so obtained. In 1851 the construction of the central repository was begun; and with the completion of each portion of it further groups of records were brought in. At first only those collections specified in the act of parliament were dealt with; but in 1852 the State Paper Office was placed under the control of the Master of the Rolls, and its contents removed to the Public Record Office. Other government departments in turn transferred to the same keeping papers not in current use; and at present the only important collections of papers not so treated are those of the India Office and the Privy Council Office, which are still kept apart.

The publications of the Record Office are of three kinds: reports, lists and indexes, and calendars. The reports are the annual

reports of the Deputy Keeper, and now deal merely with the administrative work of the office; up to 1889 they also contained, in the form of appendices, inventories and detailed descriptions of various classes of records. In the present article these reports are referred to by number. The lists and indexes are either inventories of special classes with more or less detail, or indexes to the contents of certain documents grouped for that purpose; they are here cited by their number. The calendars are volumes containing full abstracts intended to make the consultation of the original document unnecessary except for critical purposes; they are equipped with full indexes. The contents of the Record Office are classified for the most part under the collections in which they were found. For a general account of the whole, see S. R. Scargill-Bird's *Handbook to the Public Records* (3rd ed. 1908). No student can afford to neglect C. Gross's *Sources and Literature of English History from the Earliest Times to about 1485*, which contains much information as to books and articles based upon English records.

We may now turn to the documents themselves, under the following heads:—

EXCHEQUER RECORDS.—The records of the administrative and judicial sides of the Exchequer (*q.v.*) are here described under its several divisions.

(1) **UPPER EXCHEQUER, OR EXCHEQUER OF AUDIT.**—(a) *Lord Treasurer's Remembrancer's Office*, or office of final audit. The result of the final audit is recorded in duplicate on the *Pipe* and *Chancellor's Rolls*. These consist of a solitary (*Pipe*) roll for 31 Henry I., and a duplicate series extending from 2 Henry II. to 2 William IV. The Record Commission has printed the following rolls: *Pipe Rolls*, 31 Henry I., 2-4 Henry II., 1 Richard I.; *Chancellor's Rolls*, 3 John. The *Pipe Roll Society* has printed the *Pipe Rolls* for 5-24 Henry II.

Foreign Rolls or Rolls of Accounts.—These contain the records of the preliminary audit of accounts other than county accounts of the sheriffs; they run from 42 Edward III. to modern times; closely connected with them are the *Enrolled Accounts*, which deal with the more important accountants separately. It should be noted that the final audit is not recorded upon either *Foreign Rolls* or *Enrolled Accounts*, but must be sought on the *Pipe Roll*, unless the accountant is found to be quit or to have a balance due to him. The Record Office has published a classified list (No. XI.) of the Foreign and Enrolled Accounts taken from all the foregoing rolls of audit, but omitting the accounts of Customs and Subsidies.

Declared Accounts.—A list (No. II.) of these records with an introduction has been published by the Record Office. The series begins in the 16th century, and from the 17th century is fairly complete.

Originalia Rolls (20 Henry III. to 1837), or extracts from the Chancery Rolls communicated to the Exchequer for its information and guidance. Latin abstracts of the rolls from Henry III. to Edward III. were printed by the Record Commission as *Abbreviatio Rotulorum Originalium* (2 vols. folio).

Lord Treasurer's Remembrancer's Memoranda Rolls.—These contain the letters received and issued by the Exchequer and notes of the general business of the department. They run from 1 Henry III. to 1848. Edward Jones's *Index to the Records* contains a few scattered references to them; and many extracts will be found in the notes to Thomas Madox's *History of the Exchequer*.

Judicial.—The only judicial proceedings on the *Lord Treasurer's Remembrancer's* side are in cases connected directly with the revenue. These are enrolled upon the *Memoranda Rolls*; and for the period 35 Charles II. to William IV. there are Order Books.

(b) *King's Remembrancer's Office*, or office of preliminary audit. The most important financial records of this branch of the Exchequer are the class known as "Exchequer K. R. accounts, &c.," which comprise vouchers and audited accounts of expenditure. Of similar accounts relating to receipts, the Escheator's accounts have been listed in the 10th Report; but the inquisitions there described as filed with the accounts as vouchers are now kept separately, and are described with the *Chancery Inquisitions* in the calendars. Accounts and vouchers relating to *Subsidies* and *Customs* are at present only described in manuscript (see below under SPECIAL COLLECTIONS).

King's Remembrancer's Memoranda Rolls (1 Henry III. to 13 Victoria).—These run parallel with those of the Lord Treasurer and to a large extent contain the same matter. Adam Martin's *Index to Exchequer Records* contains a certain number of references to them.

In the reign of Edward VI., returns were made into the Exchequer by commissioners appointed to take inventories of *Church Goods*. Volumes of these for several counties are being published by the Alcuin Club (see Mély et Bishop, *Bibliographie générale des inventaires imprimés*, vol. i. p. 245).

Judicial.—The court of Exchequer on the King's Remembrancer's side was a court of equity held before the lord treasurer, the chancellor of the exchequer and the barons. The usual records of a court of equity, Bills and Answers, Decrees and Orders, Affidavits and other subsidiary documents exist for it. Martin's *Index to Exchequer Records* contains references to the Decrees and Orders.

Of the proceedings under *special commissions* issuing from this court a descriptive catalogue (Elizabeth to Victoria) has been published in the 38th Report. *Depositions* taken by commission (Elizabeth to George III.) are catalogued in the Reports 38-42. A catalogue of the later depositions exists in manuscript.

(2) LOWER EXCHEQUER, or EXCHEQUER OF RECEIPT.—The principal financial records of this department are the *Receipt* and *Issue Rolls* showing the payments made to and by the Exchequer. The former consist of an exceptional roll for 14 John and a series from Henry III. to George III. The latter run from Henry III. to Edward IV. and from Elizabeth to George III. A translation of the issue rolls (2) for 44 Edward III. was published by F. Devon; who also published a volume of extracts from the issue rolls of the reign of James I., and another volume of extracts from the rolls for the period 41 Henry III. to 39 Henry VI. The other records of this department are very numerous.

(3) EXCHEQUER OF PLEAS.—The barons of the Exchequer without the lord treasurer had a court of their own, where process took place by common law. A list of the Plea Rolls of this court (20 Henry III. to 1855) will be found at p. 64 of the Record Office *List of Plea Rolls* (No. IV.). A partial index to the tithe-suits on these rolls is contained in the 2nd Report.

(4) EXCHEQUER OF THE JEWS.—Suits between Jews, or in which Jews were concerned, were tried before a special subordinate court. The Plea Rolls (3 Henry III. to 4 Edward I.) are listed in the Record Office *List of Plea Rolls*. For specimens see *Select Pleas, Starrs and Records of the Jewish Exchequer*, edited for the Selden Society and the Jewish Historical Society of England by J. M. Rigg.

(5) FIRST FRUITS AND TENTHS.—After the breach with Rome, the crown obtained a new source of revenue in the first fruits due to the pope from every holder of a benefice upon appointment, and from the tenths payable during his tenure of it. For a few years under Henry VIII. a special office administered this revenue. At the accession of Mary the business was transferred to a department of the Exchequer. The principal records are the following: *Bishop's Certificates of Institutions to Benefices*; *Composition books* giving the names of incumbents and the sums paid by them in lieu of first fruits; and documents relating to the valuation of livings. The most important entries touching valuation were printed by John Ecton in the *Liber Decimarum* (1711), which has passed through many editions under the titles of *Thesaurus Rerum Ecclesiasticarum* and *Liber Regis*. The first fruits and tenths are now transferred to Queen Anne's Bounty, and are managed by that office.

(6) VALOR ECCLESIASTICUS.—In 26 Henry VIII. a commission was issued for a valuation of all ecclesiastical property. The returns were made into the Exchequer and consist of eighteen volumes and three portfolios of rolls. Of these abstracts were made in three volumes known as *Liber Valorum* or *King's Books*, and a portion was copied in two volumes known as *Liber Regis*. The original returns for the diocese of Ely, most of that of London and part of those of Salisbury, Lincoln, Durham and York are not now known to exist, and are very imperfectly represented by the abstracts and copies mentioned above. From these materials the Record Commission compiled six volumes folio known as the *Valor Ecclesiasticus* provided with maps and indexes. The introduction and general map were published later (1834) in a separate octavo volume; but some copies were struck off in folio and inserted into Vol. I., which was published in 1810.

(7) COURT OF AUGMENTATIONS.—This office was instituted to administer the property of the suppressed monasteries and the revenues of the duchy of Cornwall. The records consist of the muniments of the suppressed houses taken over with them and of documents connected with their actual seizure and subsequent administration (for the former, see SPECIAL COLLECTIONS below; the latter are in great part calendared in the *Letters and Papers relating to the Reign of Henry VIII.*).

There was also a judicial side of the office, in which the proceedings were by bill and answer. In 38 Henry VIII. this court absorbed an earlier one known as the Court of General Surveyors of the King's Lands, which had been set up in 33 Henry VIII. A calendar of the decrees of the court will be found in the 30th Report. The court of augmentations was merged in the Exchequer in 1 Mary.

CHANCERY.—The records of the chancery are here treated in two divisions, administrative and judicial.

(1) *Chancery Administrative*.—These are either enrolments of letters issued under the great seal, documents forming part of the process of issuing such letters, or documents drawn up for the information of the chancery.

Enrolments.—The *Charter Rolls* (1 John to 8 Henry VIII.) contain the enrolments of the most formal letters. The Record Commission published one volume folio containing a transcript of the rolls for the reign of John; and a badly designed and executed calendar entitled *Calendarium Rotulorum Chartarum*. The Record Office has published three volumes of a complete calendar of the Charter Rolls from 11 Henry III. The *Patent Rolls* (3 John to the present day) contain enrolments of less formal letters addressed generally. The Record Commission published one volume folio containing a transcript of the rolls for the reign of John, with a valuable itinerary of that king. The Record Office has also printed in full

the rolls for the period 1-16 Henry III. From this point over 30 volumes of a Calendar have been published, and the remaining gaps in the series are being closed. For these gaps the Record Commission's *Calendarium Rotulorum Patentium* is still useful, but only refers to a small proportion of the matter on the rolls. The rolls for the reign of Henry VIII. are calendared in the *Letters and Papers of Henry VIII.* The *Close Rolls* (6 John to the present time) contain the enrolments of letters directed to specified persons and also enrolments of deeds made according to statute or for safe custody. The Record Commission published two volumes folio containing a transcript of the rolls for the period from 6 John to 11 Henry III. The Record Office has also published several volumes of rolls for the reign of Henry III. From the reign of Edward I. eighteen volumes of a calendar have appeared. The *Fine Rolls* (1 John to 23 Charles I.) contain the record of judicial writs issued under the great seal with a note of the fine or fee paid; also of letters of appointment to offices and letters relating to the administration of the feudal incidents of tenure. The Record Commission published a transcript of the rolls for the reign of John under the title *Rotuli de Oblatis et Finibus*; for the reign of Henry III. they also published two volumes of *Excerpta e Rotulis Finium* consisting of the entries relating to the feudal incidents. There were also other rolls containing letters issued under the great seal relating to special countries and subjects. The most important of these are here mentioned. *French Rolls, Gascon Rolls, and Norman Rolls* deal with the affairs of the English dominions in France and with relations with that country. A catalogue of many of the entries on these rolls down to the reign of Edward IV. was published by Thomas Carte in two volumes folio. Of the *French Rolls* (16 Edward III. to 26 Charles II.) those for the reign of Henry V. are briefly calendared in the 44th Report; and those for the reign of Henry VI. in the 48th Report. Of the *Gascon Rolls* (38 Henry III. to 7 Edward IV.) the earlier rolls have been printed in full in the *Documents inédits* published by the French government under the care of M.M. Francisque-Michel and Bémont. Of the broken series of *Norman Rolls* (1 John to 10 Henry V.) those for the reign of John and that for 5 Henry V. have been printed in full in one volume by the Record Commission; to the remainder a calendar will be found in the 41st Report. The books here mentioned deal with some rolls now placed in other classes.

Other rolls contain letters under the great seal relating to Ireland, Scotland and Wales. Of these the Record Commission printed the *Scottish Rolls* (19 Edward I. to 8 Henry VIII.) in full, omitting the numerous letters of protection contained in them. For the *Welsh and Irish Rolls* there is only a very partial calendar in Ayloff's *Calendar of Ancient Charters*. The *Roman and Almain Rolls* have been used in *Foedera*, and many entries from the other chancery rolls will be found there. The *Liberate Rolls* (2 John to 14 Henry VI.) contain the enrolments of writs for the issue of money out of the Exchequer. The rolls for 2-4 John have been printed in full by the Record Commission.

Documents forming Part of the Process of issuing Letters under the Great Seal.—These are known as *Chancery warrants*, and consist of *Privy Seals, Signed bills* and other documents forming steps in the process. Series I. of these documents extends to the end of the reign of Richard III., and Series II. to the end of the reign of Henry VIII.; Series III. ends with the reign of Anne, and Series IV. with that of William IV., while Series V. is still in progress. Series I. and II. are arranged in chronological order (Series I. being also classified); the remainder are in monthly bundles. The warrants for the reign of Henry VIII. are calendared in the *Letters and Papers of Henry VIII.*; those for the first seven years of Charles I. are calendared in the 43rd Report. With these may be placed the *Inquisitiones ad quod damnum*. Of these the Record Office has published a descriptive list (Nos. XVII. and XXII.) for the period 28 Henry III. to 2 Richard III.

Documents drawn up for the Information of the Chancery.—The most important of these are the inquiries held under writs issued from the chancery. The first series of these (Henry III. to Richard III.) is now arranged in three classes, *Inquisitiones Post Mortem* including analogous documents relating to the feudal tenure of land, *Criminal Inquisitiones* and *Miscellaneous Inquisitiones*. The Record Office has published three volumes of a calendar of *Inquisitiones Post Mortem*. The Record Commission calendars refer to the old arrangements of these inquiries into two series, known as *Inquisitiones Post Mortem &c.* and *Inquisitiones ad quod damnum &c.*, a distinction of title which concealed the identity of the documents described. Both calendars contain many inaccuracies and omit much useful information. To supply some of these defects for the period Henry III. to Edward I. the Record Office published the *Calendarium Genealogicum*, but this work does not attempt to deal with the lands mentioned in the inquiries. In the second series of these inquiries the three classes of inquisitions are all placed together. One volume of a calendar to the *Inquisitiones Post Mortem* for the reign of Henry VII. has appeared. *Certificates of Gilds* are returns made under the statute of 12 Richard II. Those in English have been printed by J. and L. Toulmin Smith for the Early English Text Society. *Charitable Uses*: a list (No. X.) of all inquisitions and decrees of commissioners

appointed under two statutes of Elizabeth to examine and rectify abuses of charitable bequests has been published by the Record Office. *Forests (Chancery)* contain perambulations and proceedings before the justices in eyre of the forest. The perambulations for certain counties have been printed by G. J. Turner in *Select Pleas of the Forest* (Selden Society).

Scottish Documents.—Five rolls relating to the policy of Edward I. towards Scotland. The first two contain the proceedings touching the claims to the crown of Scotland and are printed in *Foedera*, vol. ii. p. 762 (Record edition); the remaining three, known as *Ragman Rolls*, contain in triplicate the submissions of the Scottish nobility to Edward I., and were printed by the Bannatyne Club in 1834. Other chancery documents relating to Scotland are described in J. Bain's *Calendar of Documents relating to Scotland*. Most of these together with the earlier Forest proceedings are included in the *Miscellanea of the Chancery*, which contains numerous other detached documents and rolls. Many of those relating to foreign affairs are printed in the *Foedera*.

(2) *Chancery Judicial.*—These may be divided into *Proceedings*, or Bills and Answers, &c., filed by the parties; *Decrees and Orders* of the court; and *Affidavits* and other documents connected with the course of the action. The series known as *Early Chancery Proceedings* (Richard II. to Philip and Mary), comprising documents of all three classes, is arranged roughly in chronological order. The Record Office has published three volumes of a descriptive list (Nos. XII., XVI. and XX.) of the whole of this series; and the first two bundles have been printed in full in the Record Commission's *Calendar of Proceedings in Chancery, Elizabeth*; other specimens are printed in *Select Pleas of the Chancery* (Selden Society), edited by W. P. Baildon. For the reign of Elizabeth the Proceedings are arranged alphabetically under the plaintiff's name in two series. Series I. is calendared in the Record Commission volumes already mentioned for Series II.; the Record Office has published a descriptive list (Nos. VII. and VIII.) covering the years 1558-1621. To the Bills and Answers of the reign of Charles II. Messrs Phillimore and Fry have published in the *Index Library* of the British Record Society an index taken from Topham's manuscript index in the Record Office. The same society has reproduced in an alphabetical form an index to the proceedings in Reynardson's division for the years 1694-1714. These last indexes contain only the surnames of the parties, without reference to the nature of the suit. *Decrees and Orders* (36 Henry VIII. to the present time) are the entry-books of the orders of the court; with them may be classed the *Reports and Certificates* of the masters and chief clerks. The *Affidavits, &c.*, date from 1611.

The chancellor formerly had a common law jurisdiction relating to certain matters touching feudal incidents and tenures, to repeals of letters patent, and to actions upon recognizances acknowledged in chancery or concerning officers of the court. No printed means of referring to these records exist.

COURT OF KING'S BENCH.—The principal records of this court are the rolls recording its proceedings and judgments, of which classified lists are given in the Record Office List of Plea Rolls (No. IV.), under the following heads. *Curia Regis Rolls* (5 Richard I. to 56 Henry III.) include all the rolls of the king's court with the exception of a few *Eyre Rolls*. Of these the Record Commission printed those for 6, 9, to Richard I. and 1 John; and also published in the *Abbreviatio Placitorum* certain abstracts from a portion of the pleas on these rolls made in the 17th century. For specimens see Selden Society volumes, *Select Civil Pleas*, edited by W. P. Baildon, and *Select Pleas of the Crown*, edited by F. W. Maitland, who has also edited for the Pipe Roll Society four rolls of the reign of Richard I. From the end of the reign of Henry III. the rolls of the king's bench and those of the common pleas (see below) have been separated. The former, named *Coram Rege Rolls* (1 Edward I. to 13 William III.), divide from 1 Anne into two portions, *Judgment Rolls*, containing pleas between private persons, and *Crown Rolls*, containing crown business. References to some pleas on the *Coram Rege Rolls* will be found in the *Abbreviatio Placitorum*; the complete roll for 25 Edward I. has been printed by the British Record Society.

Assize Rolls, &c.—Under this head are grouped rolls containing the proceedings before justices in eyre, of assize, of oyer and terminer, of gaol delivery (a few) and before justices sent on special commission. References to some of these will be found in the *Abbreviatio Placitorum*; and specimens in the Selden Society volumes already mentioned. The *Eyre Roll* for Gloucestershire, 5 Henry III., has been published by F. W. Maitland. The pleadings taken under writs of *Quo Warranto* during the period Edward I. to Edward III. were published by the Record Commission. For specimens of *Coroners Rolls* (Henry III. to Henry VI.) see the Selden Society's volume edited by C. Gross. *Baga de Secretis* (since 17 Ed. IV.) contains the proceedings in trials for treason or felony held before the court of king's bench or special commissioners. An inventory and calendar will be found in the 3rd, 4th and 5th reports.

COURT OF COMMON PLEAS.—The Plea Rolls of this court, known as *De Banco Rolls*, run from 1 Edward I., before which date pleas before justices of the common bench form part of the *Curia Regis*

Rolls, to 24 Henry VII., from which date the Plea Rolls are known as *Common Rolls*. But in 25 Elizabeth all common recoveries and enrolments of deeds were transferred to a new roll called the *Recovery Roll*, the series of which extends to 1837. In the Year Books edited for the Rolls Series by L. O. Pike, and those edited for the Selden Society by F. W. Maitland, the cases reported have, when possible, been traced on to the *De Banco Rolls* and extracts from those rolls printed. *Feet of Fines* (up to 1835) are the official part of the triplicate document constituting the complete fine. Those for the period 7 Richard I. to 16 John have been printed by the Record Commission for the counties Bedfordshire to Dorset in alphabetical order. Four volumes printed for the Pipe Roll Society cover the years down to 10 Richard I. for all counties. The feet of fines are arranged in counties year by year up to the reign of Henry VIII. Afterwards they are arranged term by term in counties. *Notes of Fines* (since Edward I.) are the records of an earlier stage in the procedure; *Concords of Fines* (since 1559) form another stage; but to neither of these are there printed means of reference.

COURT OF STAR CHAMBER.—The relation between the king's council sitting as a judicial body and the Court of Star Chamber set up by the act of 3 Henry VII., c. 1, is matter of controversy. The records of this court are nearly all of later date than this act. They consist of Bills, Answers, Depositions and similar documents, with a very few Decrees and Orders. The Record Office has published a descriptive list (No. XIII.) of a portion of these records; for specimens see Selden Society, *Select Cases in the Star Chamber, 1477-1509*, edited by I. S. Leadam.

COURT OF REQUESTS.—The origin of this court and the manner in which it died out at the time of the Civil War are alike uncertain. The records that remain are of two kinds, *Proceedings and Books*. Of the former the Record Office has published a descriptive list (No. XXI.); and specimens will be found in *Select Cases in the Court of Requests*, edited for the Selden Society by I. S. Leadam. The *Books* contain among other matters the Decrees and Orders of the court.

PARLIAMENTARY RECORDS.—The proceedings of parliament were recorded either on a roll prepared for each session, or on detached documents and petitions made up into sessional files. The files have now disappeared, although transcripts of some still exist, and in many cases their constituents can be traced among the *Ancient Petitions* (see below under SPECIAL COLLECTIONS). The rolls known as *Parliament Rolls* form a broken series, 18 Edward I. to 48-49 Victoria. The rolls for Edward I. and Edward II. are among the Exchequer records, and the remainder are in the chancery. Of these rolls and files, and of certain pleadings found in the records of the King's Remembrancer, the Record Commission published what was meant to be a complete reprint. But the editors relied partly upon transcripts and partly upon original documents, and it is often difficult to determine the sources from which they drew. So prepared, the *Rolls of Parliament* (6 vols.) cover the period from 6 Edward I. to 1 Mary. The roll for 33 Edward I., unknown to them, has been edited (Rolls Series, vol. 98) by F. W. Maitland, with a valuable introduction and appendices; rolls for 18 Edward I. and 12 Edward II. are printed in H. Coles' *Documents Illustrative of English History*. The *Parliament Roll* includes enrolments of statutes among its contents. But from Edward I. to Edward IV. the statutes after receiving the royal assent were also enrolled upon the *Statute Roll* (chancery), of which only six rolls now remain. From these rolls and other sources the Record Commission prepared the volumes known as *Statutes of the Realm* on principles described in the introduction to that work. Unfortunately the editors made use of early printed texts, and translations based upon the inferior texts contained in *Exchequer K.R. Miscellaneous Books* 9, 10 and 11, and so diminished the value of their work. The *Statutes of the Realm* extend to the end of the reign of Queen Anne. Since then public general acts have been published in many forms; private acts ceased to be enrolled upon the *Parliament Rolls* during the 16th century; the originals are preserved in the House of Lords. The Record Office contains detached documents relating to parliamentary proceeding known as *Exchequer Parliamentary* and *Chancery Parliamentary*, but neither class has yet taken a final form.

STATE PAPERS.—This class contains the documents belonging to the offices of the secretaries of state, formerly deposited in the place of custody called the State Paper Office. This office was established about the year 1578, but the first attempt to arrange its contents seems to have been due to Sir Thomas Wilson, who in the reign of James I. divided the papers into two classes, *Domestic* and *Foreign*, to which at a later date the class of *Colonial Papers* was added. These series all come to an end at the year 1782, at which date the modern history of the office of Secretary of State begins.

Domestic.—Calendars of these papers have been published for the period 1547-1676, with special volumes dealing with the papers of the *Committee for Advance of Money* (1642-1656), and of the *Committee for Compounding* (1643-1660). Another series of volumes begins with the year 1689, and a third extends from 1760 to 1775; these last are called *Home Office Papers*, but are in no way different

in character from the *State Papers Domestic*. The *Domestic Papers* relating exclusively to Ireland have been calendared under the title of *State Papers, Ireland*, for the years 1509-1601 and 1603-1665, with a special volume dealing with the papers concerning *Adventurers for Land*. From 1670 these papers are calendared in the *Domestic* volumes.

Scotland.—Originally there were in the State Paper Office two sets of papers relating to Scotland, *State Papers Domestic, Border Papers*, containing papers concerning the Council of the North and the Wardens of the Marches; and *State Papers Foreign, Scotland*, before the union of the two crowns. The first calendar of these was a *Calendar of State Papers, Scotland, 1500-1603*, containing brief notes of all the *State Papers Foreign, Scotland*, and of many of the *Border Papers* which were removed from their places without any record of the removal. Next came the *Calendar of State Papers Foreign*, in which were included apparently all the *Border Papers* for the period covered which had escaped the previous raid; notes, however, were made of the papers so taken. Out of the original 75 volumes of *Border Papers* only 36 remained. At a later date the papers drawn for the Foreign Calendar were restored and now form the first 19 volumes of the series, while the 36 volumes originally remaining have now become the final 23. At the same time the *State Papers Foreign, Scotland*, were annexed, and became *State Papers Domestic, Scotland*. In their present arrangement the *Border Papers* have been calendared in the following volumes: vols. 1-19 in the *State Papers Foreign 1547-1560*; vols. 20-42 in the Scottish General Register Office *Calendar of Border Papers 1560-1603*. The *State Papers Domestic, Scotland*, from 1547 onwards, are being fully calendared in the Scottish General Register Office *Calendar of Scottish Papers* with other material. Those from 1509 to 1547 are dealt with in the *Letters and Papers of Henry VIII.* (see below, SPECIAL COLLECTIONS). A list of these three Classes has been published (No. III.).

Foreign.—Calendars of the *State Papers Foreign* have been published for the period 1547-1580. A few of these papers are also calendared in the first volume of the *State Papers Spanish* (see below under SPAIN). The Record Office has published a list of the *State Papers Foreign* (No. XIX.).

Colonial.—These papers are calendared in two sets, an "East Indies" (1513-1634, which has been continued to 1639 by the India Office in Miss E. B. Sainsbury's *Court Minutes of the East India Company*) and an "America and West Indies" (1574-1693, in progress).

DEPARTMENTAL RECORDS.—From time to time all the government departments, with the exception of the India Office, deposit such papers as they wish to preserve in the Public Record Office; thus the *Treasury, Home Office, Foreign Office, Colonial Office, Admiralty, War Office, Local Government Board and Board of Trade* have all placed important papers in the care of the Master of the Rolls. A calendar of the earlier Treasury Papers, which extends from 1660 to 1668 and 1720 to 1745 has been published; also a list of the Admiralty Records (No. XVII.). For each department a limiting date is fixed from time to time; documents before that time are open to students; later ones are only accessible under special conditions.

SUBORDINATE AND INDEPENDENT JURISDICTIONS.—*Palatinate of Durham*.—For the earlier records see G. T. Lapsley's *County Palatine of Durham* (Harvard Historical Series, vol. viii.), pp. 327-337. The letters sent out from the bishops' *chancery* are enrolled on the *Cursitors' Records*, Nos. 29 to 184. They are calendared in Reports 31 to 37 and 40. One of the registers (Bishop Kellawe's) has been printed in full in the Rolls series (No. 62) with additions from the register of Bishop Bury. The *Cursitors' Records* also include seven bundles of *Inquisitions Post Mortem* (Nos. 164-180), calendared in the 44th Report; and a volume (No. 2) contains transcripts of similar documents, calendared in the 45th Report. The records of the *Exchequer* of Durham, though deposited in the Public Record Office, are treated as the private records of the Ecclesiastical Commission, and are only accessible with a special permit. To the *judicial* records the only printed means of reference is the list of *Judgment Rolls* (20 Henry VII. to 7-8 Victoria) in the Record Office list of Plea Rolls (No. IV.).

Palatinate of Chester.—The letters sent out from the *chancery* are enrolled upon the *Chester Recognizance Rolls* (1 Edward II. to 34 Charles II. with a few rolls down to 1 William IV.) calendared in Reports 36-37 and 39. The financial records of the *Exchequer* of Chester are listed among the Ministers' Accounts (List No. V.) of the county of Chester. The *Inquisitions post Mortem* and *ad quod damnium* (Edward III. to Charles I.) are indexed in the 25th report. The *judicial* records consist of Pleas in the Exchequer, a court of equity. Its records are *Bills and Answers* (Henry VIII. to George IV.), calendared in the 25th Report up to Philip and Mary; and *Decrees and Orders*. The court of the justices of Chester was at common law; its *Plea Rolls* (44 Henry III. to 1 William IV.), with a separate series for Flint (from 12 Edward I.) are listed among the Plea Rolls (List No. IV.). The *Deeds, Inquisitions and Writs of Dower* upon these rolls for the period Henry III. to Henry VIII. are calendared in the 26th-30th Reports without an index. The *Assize Rolls* for the counties of Chester and Flint and for the

honour of Macclesfield are listed among the other assize rolls (List No. IV.).

Wales.—The following are the principal records of the principality of Wales: *Ministers' Accounts* and *Court Rolls*, including those of the principality and of the honours and manors of the Lords Marchers, listed in Lists Nos. V. and VI. Of the *judicial* records of the Great Sessions of Wales, set up by the act 34 & 35 Henry VIII., c. 26, the *Plea Rolls* are listed in the list of Plea Rolls (No. IV.). For an account of the Court of the Marches in Wales, see C. A. Skeel's *The Council in the Marches of Wales*.

The Duchy and Palatinate of Lancaster.—The duchy of Lancaster comprises all the estates of the duke of Lancaster; the palatinate is limited to the county of Lancaster. The records of the palatinate, transferred to the Public Record Office from Lancaster castle, related to the county and are either *enrolments of writs* or of a *judicial* nature. The records of the duchy, transferred from the office of the duchy at Westminster, include similar records and others dealing with the manorial and financial records of all the estates within and without the county. For the *Duchy Records* see the detailed list (No. XIV.), where the means of reference to this collection are fully described. Of the *Palatinate Records* the enrolments of writs are classified as *Patent* and *Close Rolls*. The former, a broken series from 5 John of Gaunt to 21 Henry VII., are calendared in the 40th Report; the latter (in 3 rolls, a broken series, 11 Henry IV. to 9 Edward IV.) in the 37th Report; but certain enrolments of the palatinate are among the duchy records. The *judicial* records of the *chancery* are not calendared; but the proceedings by way of appeal from that court to the Duchy Chamber at Westminster are dealt with in the duchy list. Proceedings under common law include *Plea Rolls* (2 Henry IV. to 11 Victoria) listed in the list of Plea Rolls (No. IV.); and for criminal proceedings there are palatinate *Assize Rolls* (Henry VI. to 6 Victoria), of which there is a list in the same place. But certain rolls which were among the Duchy Records will be found apart at pages 139-140 of the same list.

Bishopric of Ely.—The act 1 & 2 Victoria, c. 94, places the records of this palatinate under the charge of the Master of the Rolls. They have never been removed to the Record Office, but remain at Ely with the episcopal records, where they can be inspected. A valuable descriptive list has been published by Alfred Gibbons for private circulation.

SPECIAL COLLECTIONS.—For the classification of the records hitherto described the knowledge preserved of their origin and purpose has been used. There exist, however, masses of records where this path is now inaccessible; these have been formed by putting together records of a similar nature either in ignorance of their history or without regarding it; the justification of this course of action must be found in the special circumstances of each case. These collections are as follows:—

Ministers' Accounts are the accounts of bailiffs, receivers, and other officers managing estates, including, first, those of the duchy of Lancaster; second, accounts of crown lands filed as vouchers in the King's Remembrancer's Office; third, accounts of monastic and other lands seized by the crown, or acquired by it by purchase, inheritance or marriage. A list of these accounts has been published by the Record Office (Nos. V. and VIII.) covering the period down to 1485. For the accounts of the duchy of Lancaster a list will be found in the 45th Report, extending to the reign of George III.

Court Rolls are records of the proceedings and profits of manorial and other private courts coming from the same sources as the Ministers' Accounts, and closely connected with them. For a list see Record Office, *Lists and Indexes*, No. VI.; and for specimens *Select Pleas in Manorial Courts*, edited for the Selden Society by F. W. Maitland.

Ancient Deeds.—In this collection are placed all documents which appear to have formed part of a title to land, some original royal charters and other analogous records. There are five series, A, B, C, D, and E, distinguished by their former place of custody. Documents too large for the ordinary method of packing have a double letter, e.g. A.A., and to those bearing fine seals the letter S is added, e.g. AS or AAS. There are thus in all fifteen classes. The A classes are derived from the *Treasury of Receipt*, or Chapter House at Westminster, and are largely monastic; the B classes are from the court of *Augmentations*; the C classes are *chancery* deeds, probably deposited as exhibits in suits or for enrolments; the D classes are from the King's Remembrancer's office; and the E classes are from the *Land Revenue* office. In 1907 five volumes of a descriptive catalogue had been published by the Record Office.

Ancient Correspondence consists of documents which in form are rather of the nature of a letter than a writ or petition. Most of them were found detached in the chancery records, but similar documents from other sources have been added. The introduction to the Record Office List (No. XV.) contains some account of the formation of the class, and the list gives references to printed collections based upon these documents. Vol. 53 contains letters of the Cely Family and is published (Camden Society, 3rd series, vol. i.).

Ancient Petitions.—The history of the formation of this class

is obscure; an account of it is in the Record Office Index to the class (No. 1.); but see also the Introduction to F. W. Maitland's *Memoranda de Parlamento* (Rolls Series, vol. 98), in which volume a number of these petitions are printed in full.

Diplomatic Documents.—In the Chapter House at Westminster was a collection of treaties and other documents connected with foreign affairs, and to these have been added other similar documents found there. Of these there is a descriptive list in the 45th and 49th Reports. A collection of so-called *Diplomatic Documents* from the chancery forms part of the *Chancery Miscellanea*.

Letters and Papers, Foreign and Domestic, of the Reign of Henry VIII.—This great collection of materials for the reign of Henry VIII. (Calendar of 20 volumes in 30) at present extends to the year 1547, and is intended to contain abstracts of all documents bearing upon that reign in the Record Office, the British Museum and other collections. Record Office documents dealt with in this Calendar have sometimes been left in their original place of custody and sometimes transferred to a series of bound volumes known as *Letters and Papers, Henry VIII.* References will be found in the Calendar to a previous series of *State Papers of the Reign of Henry VIII.*, printed by a Royal Commission for printing State Papers.

Miscellaneous Books.—The many books and registers preserved in the Record Office will be found described in the Handbook. The following have been printed:—

EXCHEQUER KING'S REMEMBRANCER

Vol. 2. *The Red Book of the Exchequer* (Rolls Series, No. 99).

Vol. 3. *Book of Aids*. (See *Feudal Aids*, published by Record Office.)

Vol. 4. *Book of Knight's Fees*. (See *Feudal Aids*.)

Vols. 5 & 6. *Testa de Nevill*; printed by the Record Commission.

Vol. 12. *Liber Niger Parvus*, printed by Thomas Hearne.

Vols. 13 & 14. *Taxatio Ecclesiastica*; printed by the Record Commission.

Vol. 17. A 16th-century transcript of an abstract of *Kirkby's Quest* for certain counties; used in *Feudal Aids*.

Vol. 24. Chartulary of Malmesbury Abbey (Rolls Series, No. 72).

Vol. 28. Chartulary of Ramsey Abbey (Rolls Series, No. 79).

Vol. 32. *The Book of Common Prayer* deposited under the Act of Uniformity.

Vols. 35 & 36. Accounts of the voyages of Martin Frobisher (Hakluyt's Voyages).

EXCHEQUER TREASURY OF RECEIPT

Domesday Book.—Indexes and supplementary matter were printed by the Record Commission. Since then facsimiles of the text for each county have been issued.

Miscellaneous Books.

Vols. 16–55. Certificates of Musters. (See *Letters and Papers of the Reign of Henry VIII.*)

Vol. 69. Extents of Knights' Fees in the Honour of Richmond; printed in Gale's *Registrum Honoris de Richmond*.

Vol. 87. Abstracts of *Placita Coram Rege*, &c.; printed in *Abbreuiatio Placitorum* (Record Commission).

Vol. 92. Statutes of the Order of the Garter. Cf. J. Anstis, *Register of the Order of the Garter*.

EXCHEQUER AUGMENTATION OFFICE

Vol. 57. *Rentals and Custumals of Battle Abbey* (Camden Society, Series 2, vol. 41).

Vols. 170–184. Copies of Leases. Indexed in 49th Report.

Vols. 495–515. Inventories of Church Goods. For details of those printed, see Mély et Bishop, *Bibliographie Générale des Inventaires Imprimés*.

The following accounts of other collections of records are necessarily less detailed:—

PRIVY COUNCIL OFFICE.—The registers of the Privy Council are still preserved in that office, with the exception of a few volumes which have strayed into other places. J. R. Dasent has edited for the Master of the Rolls a series of volumes containing *The Acts of the Privy Council*, from 1542 to 1604. *The Proceedings and Ordinances of the Privy Council, 10 Rich. II.—33 Henry VIII.*, edited for the Record Commission by Sir N. Harris Nicolas, are from documents in the Cotton MSS. and from transcripts made by Rymer from documents then at the Pells Office.

INDIA OFFICE.—The records of the India Office are preserved there. Complete printed lists exist for the whole collection, and the following documents have been published: *The First Letter Book of the East India Company*, edited by Sir G. Birdwood and W. Foster; *Letters received by the East India Company from its Servants in the East*, edited by F. C. Danvers and W. Foster (6 vols.). The records in India may be mentioned here. Each presidency and each province keeps its own; and this is the case also with the smaller subdivisions. No printed lists appear to exist for any of the collections. The following volumes have been published: *Letters, Despatches and other Papers of the Foreign Department of the Government of India, 1772–85*, edited by G. W. Forrest (3 vols.,

Calcutta); *Bengal 1756–1757*, edited by S. C. Hill (3 vols. 1905); and *Old Fort William*, edited by C. R. Wilson (3 vols., 1906–7).

Ireland.

The Public Record Office of Ireland was established in 1867 by the Act 30 & 31 Vict. c. 70, when the records of the various courts of law, all wills proved in Ireland, and certain financial records, were collected into one building. The State Paper Office remains a separate, though subordinate, department in one of the towers of Dublin Castle, whence the papers are only transferred to the Record Office by special order. The Deputy Keeper of the Irish Record Office publishes yearly reports with appendices. The most important calendar published in these is that of *Fiants* or warrants for the issue of letters under the Great Seal, Henry VIII. to Elizabeth, contained in Reports 7–9, 11–13, 15–18, with indices for each reign. A calendar of the *Deeds of Christ Church, Dublin*, is contained in the 20th, 23rd, 24th and 27th Reports. The *Wills* of the diocese of Dublin, down to the year 1800, are indexed under the names of the testators in the 26th and 30th Reports. The series of *Proclamations* by the lord lieutenant and council, and by the crown, which is among the records in the Record Tower of Dublin Castle, is catalogued in the 23rd and 24th Reports. Of the *financial* records very little has been published. In the 33rd Report there is a good account of the Books of the *Treasury* and *Accounting Departments* from the reign of Henry VIII. Scattered entries from the *Pipe Rolls* (13 Henry III.—33 Edward I.) are printed in the 33rd and 35th–38th Reports. Before the establishment of the Record Office the Irish Record Commission published a Latin calendar of the *Patent and Close Rolls* from Henry II. to Henry VII., and an incomplete calendar in English for the years 5–35 Henry VIII. Under the authority of the Master of the Rolls a calendar was published for the period Henry VIII. to Elizabeth, upon which some severe comments will be found in J. T. Gilbert's *The History . . . of the Public Records of Ireland*.

An English calendar for the reign of James I. was published by the Record Commission; and a calendar for the years 1–8 Charles I., under the authority of the Master of the Rolls. Two large folio volumes entitled *Liber Hibernie* should here be mentioned. The history and contents of this astounding work can be gathered from its introduction, and from an index to it in the 9th Report. *Inquisitiones post mortem* and *on attainder*, for the provinces of Leinster and Ulster only, are dealt with in the Record Commission's *Inquisitionum in officio Potulorum Cancellarie Hibernie asservatarum Repertorium*. Of strictly *judicial* records the Record Office has published one volume of an admirable calendar of the *Justiciary Rolls* (1295–1303).

Scotland.

The records of the kingdom are deposited in several places in Edinburgh. The principal repository is the General Register House, at present governed by the Act 42 & 43 Vict. c. 44. But certain records of the chancery and all the records of the court of teinds are in separate repositories. A general account of these records is given in M. Livingstone's *Guide to the Public Records of Scotland deposited in H.M. General Register House, Edinburgh*, with appendices describing those contained in other repositories.

Parliamentary.—The Record Commission of Great Britain published *The Acts of the Parliament of Scotland* (1124–1707), a text derived from many sources described in the introductory volume; *The Acts of the Lords Auditors of Causes and Complaints* (1466–1494), being the proceedings of the parliamentary committee for hearing petitions; and *The Acts of the Lords of Council* (1478–1495), being proceedings of a similar body.

Privy Council.—The register of the Privy Council of Scotland from 1545 is in course of publication at the General Register House.

Exchequer.—The Exchequer Rolls, corresponding to the Great Roll of the English Exchequer, are being printed in full from 1264 at the General Register House; and the accounts of the *Treasurer of Scotland* from 1473 are being published at the same office.

Chancery.—The enrolments of letters issued under the Great Seal of Scotland are contained in twelve rolls and a series of volumes. The Record Commission printed these registers in full for the period 1306–1424; and the General Register House is continuing the publication in an abridged form.

Court of Chancery.—Only the enrolments of letters under the Great Seal are transferred to the General Register House; the remainder are preserved in the court of chancery. The most important of these are the *Retours to Chancery*. To these the only printed means of reference is the *Inquisitionum ad capellam Domini Regis retornatarum abbreviatio* (16th and 17th centuries), published by the Record Commission.

Local Records.

To deal with the municipal and local records of Great Britain in any detail is quite impossible in this article. Fortunately the admirable work of C. Gross, entitled *The Bibliography of Municipal History* (Harvard Historical Studies), contains a complete account of the work done on municipal records up to 1897; while the *Report of the Committee appointed to inquire as to the existing arrangements for the collection and custody of local records* (1902) affords a complete view of the questions dealt with by it.

Private Collections.—The publications of the Historical Manuscripts Commission are in most cases the only printed means of reference to private muniments. The 17th Report of the Commission contains an index to all the collections of papers so far dealt with by them.

Wills.—Up to the date of the Probate Act (20 & 21 Vict. c. 77) the proving of wills was under ecclesiastical jurisdiction, and the wills themselves were scattered among peculiar courts—courts of the various bishops, and the prerogative court of Canterbury. By the passing of the act a general registry was established at Somerset House, to which were transferred all the wills of the prerogative court of Canterbury and of many of the other registries. But even at the present time there remains much confusion and uncertainty as to the place of deposit of the wills of any particular court; and for accurate information on this point the inquirer must be referred to the *Handbook to the Ancient Courts of Probate and Depositories of Wills*, by G. W. Marshall.

British Colonies.

For the British colonies the most important records, historically speaking, are the Colonial Office papers deposited in the Public Record Office, London; and those colonies which have published the records relating to their history have usually gone to that source. In *New South Wales*, however, there is in the Colonial Secretary's office at Sydney a collection of records dating from 1789, which are included in the volumes published by that State. *Cape Colony* possesses records dating from 1652; G. McCall Theal, historiographer of the colony, has also published important series of volumes of documents drawn from the Public Record Office and other European sources. *Canada* has recently centralized its records, of which a large part so far consists of transcripts made in Europe. For an account see E. C. Burnett's *List of printed guides to and descriptions of Archives and other repositories of Historical Manuscripts* (American Historical Manuscripts Commission Report, 1897). The Dominion Archivist submits yearly to the Minister for Agriculture a report, in which (in Appendices) are given many lists and accounts of records.

European Countries.

In dealing with Great Britain it has seemed desirable to give some account of publications dealing with the contents of the repositories described. In the remainder of the article this will not be attempted. For the most part the books mentioned are in themselves bibliographies and guides, and do not contain even abstracts or descriptions of actual documents. It is scarcely necessary to explain that much of the following information is based on the work of Langlois and Stein.

AUSTRIA AND HUNGARY.—The records of Austria-Hungary, Bohemia, and the other states under the same government, are still preserved locally. There are repositories of government records at Vienna, Budapest and Prague, and ten provincial places of deposit. Even at Vienna there is nothing resembling the English Public Record Office; the *Kaiserliches und königliches Haus-, Hof- und Staatsarchiv* contains the papers of the imperial family and the records of imperial administration and of that of foreign affairs. Of other departmental papers those at the Ministry of War are the most important. There is no complete inventory of all these records. At Budapest since 1875 have been collected the archives of Hungary, Transylvania, Croatia and the government of Fiume: for an account of the records in this and other Hungarian and Transylvanian repositories see Fr. Zimmermann's *Über Archiv in Ungarn; ein Führer durch ungarländische und siebenbürgische Archive*.

BELGIUM.—The records are numerous and valuable.

State Records comprise all those of the central governments, of the modern kingdom, of the governments preceding it and of the various states such as Brabant, Flanders, Gueldres and Hainaut out of which Belgium was formed. They are preserved partly at Brussels as *General Records of the Kingdom* and partly in provincial repositories. Thus at Ghent are archives of the county of Flanders, at Liège of the principality of that name and of the duchy of Limburg, at Mons of the county of Hainaut, at Bruges of the liberty of Bruges and other jurisdictions of eastern Flanders; at Namur, Arlon, Hasselt and Tournai are repositories of less importance: at the same time the repository at Brussels contains many records of the same kind as those in the provincial offices and is the chief one of the country; the collection there has been formed from various collections in Belgium combined with records restored by the Austrian government and other acquisitions.

Archives Provinciales, the records of provincial administrations since 1794, are placed in the chief towns of each province: each collection falls into three periods, French (1794-1814), Dutch (1814-1830) and Belgian.

Municipal Archives.—The most important are those of Antwerp, Bruges, Ghent, Malines, Mons, Tournai and Ypres.

The best book of general bibliographical reference for Belgian records is Pirenne's *Bibliographie de l'histoire de Belgique*.

DENMARK.—At Copenhagen there has been, since 1889, a central Record office (*Rigsarchiv*) containing all the previously existing

collections of records, and receiving those of the various ministries and offices. There are also repositories there, and at Odense and Viborg, for local records, municipal and others. The central office is publishing a series of inventories of documents in its charge.

FRANCE.—The best general work is *Les Archives de l'histoire de France*, by Langlois and Stein. The administration of the records is attached to the Ministry of Public Instruction, acting through a commission and inspectors.

Archives Nationales, in the Hôtel Soubise at Paris, are divided into three sections, *Historique, Administrative et Domaniale* and *Legislative et Judiciaire*, each including subsections distinguished by letters or groups of letters. The classification is by subject, not necessarily by origin or function; but some of the classes, e.g. the archives of the *Trésor des Chartes*, the *Parliament of Paris* and the *Châtelet*, represent real groups of records with a common history.

Archives des Ministères.—In theory the *Archives Nationales* should receive all government office records, except those in current use: actually several offices retain their own. Thus the Ministry of Foreign Affairs keeps its archives, divided into *Correspondance politique* and *Mémoires et Documents*: it also publishes series of *Inventaires analytiques des Archives du Ministère des Affaires étrangères*, and *Recueils des instructions données aux ambassadeurs et ministres de France depuis les traités de Westphalie jusqu'à la Révolution française*. The Ministries of War and the Marine likewise possess and administer their own archives.

Archives Départementales.—Each department possesses a special office for the custody of its records, which are in many cases of great importance, consisting partly of the records of the ancient provincial governments, private documents seized at the Revolution, muniments of religious houses, &c., and partly of modern administrative records. A system of uniform classification by subjects has been applied to these, coupled with a rule that documents having a common history and origin are not to be separated; it is understood that the intelligence of the archivists in charge has enabled them to disobey neither of these regulations. For a general view of the arrangement and contents of departmental repositories see *Etat général par fonds des archives départementales, ancien régime et période révolutionnaire* (1903), and the *Inventaires Sommaires* for the several departments. For the publication of local societies see *Manuel de bibliographie de l'histoire*, by Ch. V. Langlois, (1901) p. 385 seq.

Archives Municipales et Communales: the value of these arises largely from their having had an undisturbed history: inventories of most of the collections exist in print. (See Langlois and Stein, *op. cit.* pp. 278-442.)

Archives Hospitalières form an important body of records, for the most part undisturbed. For their classification, and a list of the repositories of them, see Langlois and Stein, p. 443 seq.; the many other places in France where records exist are mentioned in the same work; note, however, that the archives of the Bastille are now in the *Bibliothèque de l'Arsenal* at Paris. There are in the English Public Record Office seventy-three volumes of transcripts from French archives, taken partly from the *Archives Nationales* (Letters of Henrietta Maria, &c.) and partly from *Archives Départementales*. The Record Office *Calendar of Documents, France*, edited by J. H. Round, containing early monastic charters, is based on these.

GERMANY.—Unfortunately lists of German State archives (*Geheimes Archiv*) are not published. Repositories are very numerous: for their localities, see the *Hand- und Addressbuch der deutschen Archive* of C. A. H. Burkhardt (2nd ed., 1887). In Prussia, besides the central repository at Berlin, there are sixteen provincial ones of importance. The other kingdoms and states forming part of the German empire have each their repository, not always at the capital. Some account of their contents will be found in Langlois and Stein (*op. cit.*) and in Fr. von Löher's *Archivlehre. Grundzüge der Geschichte, Aufgaben und Einrichtung unserer Archive:* for the publication of State Records see Dahlmann-Waitz, *Quellenkunde zur deutschen Geschichte;* and for Prussian archives in particular R. Koser's *Über den gegenwärtigen Stand der archivalischen Forschung in Preussen* (1900). For the numerous and valuable records of German towns reference may be made to the works already mentioned. Many of the towns, e.g. Cologne, publish volumes drawn from their archives, and even include in them documents from other sources. Of special interest to English students is Konstantin Höhlbaum's work upon the Hanse towns. The Record Office has a volume of transcripts from German archives.

HOLLAND.—There is one repository for each of the eleven states. That at the Hague, for south Holland, serves also as a central repository for the whole kingdom. This collection occupies a special building, and includes the records of Foreign Affairs, classed under the countries to which they relate, and certain documents acquired from the collection of Sir Thomas Phillips. There are many printed and manuscript lists, and access to the documents is easy. This is also the case with the other provincial archives, of which the most important are those at Arnheim.

Hertogenbosch, Groningen, Haarlem, Maastricht, Middelburg and Utrecht.

Town archives are for the most part well preserved. Printed inventories generally exist, and in some cases, e.g. at Doesburg, the archives contain information as to the relations between the Hanse and England in the 14th century.

Dutch repositories have no administrative inter-connexion. Each archivist reports yearly to the archivist-in-chief of the kingdom, and since 1878 these *Verslagen omtrent Rijks oude Archieven* have been printed.

The English Public Record Office has four volumes of transcripts from Dutch archives.

ITALY.—The administration of the public records of the kingdom is attached to the Ministry of the Interior, for which office Signor Vazio published (1883) his *Relazione sugli archivi di stato italiani*. There are seventeen repositories, representing the ancient divisions of the kingdom. The most important are the following:—

Florence, containing records of the foreign correspondence of the dukes of Tuscany and the Florentine republic.

Genoa, records of the republic.

Milan, records of the duchy, in particular the registers called *L'Archivio Pontificio*.

Modena, records of the family of Este.

Naples, in particular the *Cancellaria Angioina*, records of the Angevin kings of Naples, containing documents relative to their extensive dominions in Provence, Anjou and elsewhere, for a bibliographical account of which see *Les Archives angevines de Naples; études sur les registres du Roi Charles I^{er}*, by Paul Durrieu. Naples also possesses the important *Archivio Farnesiano*, mainly records of the duke of Parma, brought there by Charles I. of Bourbon on his accession to the throne of the Two Sicilies in 1735.

Palermo, the records of the island of Sicily.

Rome, the most important records of the *Archivio di Stato* are those relating to the papal government which were not transferred to the Vatican in 1871.

Turin, the archives of the house of Savoy, especially the letters from envoys at foreign courts, a series of very important reports.

Venice, the convent *dei Frari* contains probably the most interesting collection of records in Italy. Rawdon Brown, G. Cavendish Bentinck, and H. F. Brown have edited many of the principal documents relating to England in the *State Papers: Venetian* (Record Office), which are still in progress. The Record Office also possesses two hundred and ten volumes of transcripts from Venetian archives, mostly the reports and correspondence of ambassadors, together with Rawdon Brown's large collection of similar materials, mainly originals or early copies (see Report 46).

The Vatican.—For the history of the papal archives the work of H. Bresslau, *Handbuch der Urkundenlehre für Deutschland und Italien* (Leipzig, 1889), may be consulted. The best English account is contained in an article in the *American Historical Review* (October 1896), by C. H. Haskins. But certain of the prefaces to the Record Office Calendar mentioned below may be consulted; and the description given by Langlois and Stein (*op. cit.*) is useful. The Vatican archives have been open to students only since the year 1881. The chief portion of the collection is that called the *Archivio Segreto*, which may be divided into two heads, the original *Archivio Segreto* and the archives added to it from Avignon, from the castle of St Angelo and from special offices such as the Consistory, *Dataria Apostolica*, *Rota*, *Secretaria Brevium*, *Signatura Gratiae*, *Penitentiary*, and *Master of the Ceremonies*. The records of the congregations of the Index, the Holy Office and the Propaganda are not usually accessible to students.

Since 1881 the importance of the archives has attracted to Rome many bands of students. Most European governments have arranged for the publication of records dealing with their own countries. The classes of documents that have received most attention are the *Regesta*, or registers of bulls and briefs, issued by the papal chancery; the *Supplicationes*, or petitions; and the *Nuntiaturae*, or despatches received from the nuncios and instructions sent to them. An account of the numerous publications will be found in the works already mentioned. Here it is only possible to mention the English publications. The Record Office in London has published one volume of *Petitions*, 1342-1417, and a Calendar from the *Regesta*, which covers the period 1198-1431. The French government is publishing a complete Calendar of the *Regesta* up to the end of the 13th century. There are in the English Public Record Office one hundred and sixty-two volumes of transcripts from the Vatican archives arranged in two series.

NORWAY.—The records of Norway are preserved at Christiania, and include a collection of papers of Christian II., king of Denmark. For the contents of the collection, see *Diplomatarium Norvegicum*, by Lange and Unger (1849-1891); and *Norske Rigsregistranter tildeels i uddrag*, dealing with the 16th and 17th centuries.

PORTUGAL.—Portuguese royal records are in the monastery of São Bento at Lisbon. The collection suffered much during the earthquake of 1755. It includes the registers of the Chancery since the 13th century, and a large number of documents subsidiary to them. In addition to this repository there are collections at the various ministries; from the records of the Ministry for Foreign

Affairs, Borges de Castro, and afterwards Justice Biker, published their *Collecção dos Tratados . . . entre a Corona de Portugal e as mais potências*. There are three volumes of transcripts from Portuguese records in the English Public Record Office.

RUSSIA.—The records of the Russian government are distributed in various repositories in Moscow and St Petersburg. At the former are preserved the records of the foreign relations of Russia down to 1801; permission to use them can be obtained from the Minister for Foreign Affairs: there are no printed lists, but many in manuscript. At Moscow are also preserved the records of the Ministry of Justice. In vol. xlv. of the *Revue historique* (1890) there is an article by J.-J. Chemko and L.-M. Balfoul on *Les Archives de l'empire russe à Moscou*. The records of government offices at St Petersburg are not open to students. There are minor repositories at various provincial capitals, and the records of the Grand Duchy of Finland are at Helsingfors. There are three volumes of transcripts from Russian records at the English Public Record Office.

SPAIN.—The nearest approach to a central Record Office for Spain is the *Archivo General Central*, established by a royal ordinance of 1858 at Alcalá de Henares, near Madrid. The collection there includes, in addition to the general administrative records of the kingdom, valuable historical matter concerning the Inquisition, the Jesuits, and other subjects. There is also at Madrid a repository known as the *Archivo Histórico Nacional*, which contains the archives of crown lands and suppressed monasteries, with a printed inventory. The remaining records are distributed locally in separate repositories containing the archives of the old kingdoms. Those of Castile are partly at Simancas and partly at Alcalá de Henares. Those of Aragon are at Barcelona in the Palacio de los Condes. Those of Navarre are at Pamplona and difficult of access. The remainder are of small importance.

In addition to these there are two collections requiring notice, the *Archivo general de Indias* at Seville and the papers of the *Consulado del Mar* at Bilbao.

The English Public Record Office is publishing a Calendar of the papers relating to England in Spanish and other connected archives. The introduction to the first volume, edited by C. Bergenroth, contains a sketch of the records used by him; and the series, under the successive editorship of Bergenroth, Don Pasquale de Gayangos and Major Martin Hume, now extends from the reign of Henry VIII. to the year 1603. The Record Office possesses sixty-five volumes of transcript from Spanish archives.

SWEDEN.—The archives have not yet been centralized, and large collections exist at the various ministries. The most important records, however, are the Royal Archives (*Rigsarchivet*), preserved in the island of Riddarholmen, Stockholm. A great many publications have been based on these: there are for instance an inventory, *Middlelanden fran Svenska Rigsarchivet*; a work bearing generally on Scandinavian history, *Handlingar rörande Scandinaviens historia*; and the *Diplomatarium Suecicum*, which is still in progress. The English Record Office has seven volumes of transcripts from the Stockholm archives, with a report.

Private collections are numerous and valuable, and a society for exploring and publishing such records is supported by the state.

SWITZERLAND.—The Swiss records are of two kinds: records of the confederation, and records of the several cantons. The first are in the *Bundes-Archiv* at Berne, and date from 1798; see *General Repertorium der Acten des helvetischen Centralarchivs in Bern, 1798-1803*, and *Schweizerisches Urkunden-Register*, by B. Hübner, vol. ii. (Berne, 1877). The Cantonal records, some of them of very early date, are at the chief town of each canton, and for the most part are provided with manuscript inventories. For those of Geneva, see also *Les Archives de Genève*, edited by F. Turrettini and A. C. Grivel (1877). For the records of the Abbey of St Gall, see *Urkundenbuch der Abtei St Gallen*, edited by H. Wartmann (1863-1882); and for those of Zürich, *Urkundenbuch der Stadt und Landschaft Zürich*, by P. Schweizer and E. Escher (1889-1892).

There are in the English Public Record Office five volumes of transcripts from the *Bundes-Archiv*.

UNITED STATES OF AMERICA

The records, among which transcripts made in England, France, and Holland hold an important place, may be divided into: *Federal*, kept at Washington; those in *private collections*; and *State Records* at the various state capitals. The publication and care of all these are often the work of private bodies subsidized or recognized by government. Thus, although *Federal archives* are now centralized under the charge of the head of the division of Manuscripts in the Library of Congress, which office is acquiring important collections of the papers of former presidents, and may also have transferred to it departmental records not in current use, publication of guides is the concern of the historical section of the Carnegie Institution and of the Archives Commission of the Historical Association. The same association explores *private collections* through its Historical Manuscripts Commission; and numerous societies publish *state records*. Some states, however, have themselves published American and European documents relating to their history; and mention must be made of the large series of *American Archives* and *State Papers* published from 1832 onwards by Congress.

The best guide for Federal records is the work of Leland and Valentine; for a general bibliographical work of reference see E. C. Burnett's *List of Printed Guides* . . . (Historical MSS. Commission Report, 1897).

EXTRAVAGANTIA

In various ways records are apt to wander from their proper custody and to lose their legal character. But in spite of this loss the historian is bound to pursue them either into the hands of private collectors or on to the shelves of some museum. No attempt can be made to discuss private collections or the manuscripts of foreign libraries. Even among English libraries it must be sufficient to mention the British Museum as the principal destination of wandering records. Of the collections in that library the most important to the student of records are the *Coltonian*, the *Harleian* and the *Lansdowne*, all catalogued by the Record Commission; the *Additional*, catalogued from time to time as fresh matter accrues; the *Egerton*, catalogued with the *Additional*; the *Sloane* and the *Stowe*, both catalogued. No distinction is made between documents that have been technically "records" and others. The whole collection is divided technically into *Manuscripts*, by which are meant volumes, and *Charters and Rolls*, meaning detached documents. To the latter class an *Index locorum*, compiled by H. F. Ellis and F. B. Bickley, has been printed. (C. G. CR.)

RECORDE, ROBERT (c. 1510–1558), Welsh physician and mathematician, was descended from a respectable family of Tenby in Wales. He entered the university of Oxford about 1525, and was elected fellow of All Souls' College in 1531. Having adopted medicine as a profession, he went to Cambridge, where he took the degree of M.D. in 1545. He afterwards returned to Oxford, where he publicly taught mathematics, as he had done prior to his going to Cambridge. It appears that he afterwards went to London, and acted as physician to Edward VI. and to Queen Mary, to whom some of his books are dedicated. He died in the King's Bench prison, Southwark, where he was confined for debt, in 1558.

Recorde published several works upon mathematical subjects, chiefly in the form of dialogue between master and scholar, viz.:—*The Grounde of Artes, teachinge the Worke and Practise of Arithmetike, both in whole numbers and fractions* (1540); *The Pathway to Knowledge, containing the First Principles of Geometry . . . bothe for the use of Instrumentes Geometricall and Astronomical, and also for Projection of Plattes* (London, 1551); *The Castle of Knowledge, containing the Explication of the Sphere both Celestiall and Materiall, &c.* (London, 1556); *The Whelstone of Witte, which is the second part of Arithmetike, containing the Extraxtion of Rootes, the Cossike Practise, with the Rules of Equation, and the Woorkes of Surde Numbers* (London, 1557). This was the first English book on algebra. He wrote also a medical work, *The Urinal of Physic* (1548), frequently reprinted. Sherburne states that Recorde also published *Cosmographiae isagoge*, and that he wrote a book *De Arte faciendi Horologium* and another *De Usu Globorum et de Statu temporum*. Recorde's chief contributions to the progress of algebra were in the way of systematizing its notation (see ALGEBRA, *History*).

RECORDER, in its original sense, one who sets down or records. Hence applied to a person with legal knowledge who was appointed by the mayor and aldermen to "record" or keep in mind the proceedings of their court, as well as the customs of the city. The word is now chiefly used of the principal legal officer of a city or borough having a separate court of quarter sessions. He must be a barrister of five years' standing, appointed by the crown and holding office during good behaviour, and receiving "such yearly salary, not exceeding that stated in the petition on which the grant of a separate court of quarter sessions was made," as the sovereign directs (Municipal Corporations Act 1882, s. 163). The recorder holds, once in every quarter of a year, or oftener, if he thinks fit, a court of quarter sessions in and for the borough. He is sole judge of the court, "having cognizance of all crimes, offences, and matters cognizable by courts of quarter sessions for counties in England," except that he may not allow or levy any borough rate, or grant licences (s. 165). He is not eligible to serve in parliament for the borough, or to be an alderman or councillor, or stipendiary magistrate for the borough, though he may be revising barrister and is eligible to serve in Parliament except for the borough. He may be appointed recorder for two or more boroughs conjointly. He may, in case of sickness or unavoidable absence, appoint in writing a barrister of five years' standing to act as deputy

recorder for him. A recorder is *ex officio* a justice for the borough.

The recorder of London is judge of the lord mayor's court, and one of the commissioners of the central criminal court. His salary is £4000 a year. He is appointed by the lord mayor and aldermen, but by the Local Government Act 1888, s. 42, sub-s. 14, after the vacancy next after the beginning of the act, no recorder may exercise any judicial function unless he is appointed by the sovereign to exercise such function. See QUARTER SESSIONS, COURT OF.

RECORDER, FIPPLE FLUTE or ENGLISH FLUTE (Fr. *flûte-à-bec*, *flûte douce*, *flûte anglaise* or *flûte à neuf trous*; Ger. *Block- or Plockflöte*, *Schnabelflöte*, *Langflöte*; Ital. *flauto dolce*, *flauto diritto*), a medieval flute, blown by means of a whistle mouthpiece and held vertically in front of the performer like a clarinet. The recorder only survives in the now almost obsolete flageolet and in the so-called penny-whistle. The recorder consisted of a wooden tube, which was at first cylindrical or nearly so, but became, as the instrument developed and improved, an inverted cone. The whistle mouthpiece has been traced in almost prehistoric times in Egypt and other Oriental countries. The principle of the whistle mouthpiece is based on that of the simplest flutes without embouchure, like the Egyptian *nay*, with this modification, that, in order to facilitate the production of sound, the air current, instead of being directed through ambient air to the sharp edge of the tube (or the lateral embouchure in the modern flute), is blown through a chink directly into a narrow channel. This channel is so constructed within the mouthpiece that the stream of air impinges with force against the sharp edge of a lip or fipple cut into the pipe below the channel. This throws the air current into the state of vibration required in order to generate sound-waves in the main column of air within the tube. The inverted cone of the bore has the effect of softening the tone of the recorder still further, earning for it the name of *flûte douce*. Being so easy to play, the recorder always enjoyed great popularity in all countries until the greater possibilities of the transverse flute turned the tide against it. The want of character which distinguishes the timbre of the whistle-flute is due to the paucity of harmonic overtones in the clang. The recorder had seven holes in front and one at the back for the thumb. As long as the tube was made in one piece the lowest hole stopped by the little finger was generally made in duplicate to serve equally well for right- and left-handed players, the unused hole being stopped with wax. Being an open pipe, the recorder could overblow the octave and even the two following harmonics (*i.e.* the twelfth and second octave). The holes produced the diatonic scale, and by means of harmonics and cross-fingering the second and part of a third octave were obtained.

The recorder is described and figured by Sebastian Virdung, Martin Agricola and Ottmar Luscinius in the 16th century, and by Michael Praetorius and Marin Mersenne in the 17th century. Praetorius mentions eight different sizes ranging from the small flute two octaves above the cornetto to the great bass. The lowest notes of the large flutes were provided with keys enclosed in perforated wooden or brass cases, which served to protect the mechanism, as yet somewhat primitive; the keys usually had double touch pieces to suit right- or left-handed players.

There are at least two fine sets of recorders extant: one is preserved in the Germanisches Museum at Nuremberg, consisting of eight flutes in a case and dating from the 17th century; the other is the Chester set of four 18th-century instruments, which are fully described and illustrated in a paper by Joseph C. Bridge.¹

The recorder has been immortalized by Shakespeare in the famous scene in *Hamlet* (II. 3), which has been treated from the musical point of view in an excellent and carefully written article by Christopher Welch, the author of an equally valuable paper, "The Literature of the Recorder."²

The small whistle-pipe used to accompany the tabor (Fr. *galoubet*; Ger. *Stamentienpfeiff* or *Schwegel*), which had but three holes, belongs to the same family as the recorder, but from its association with the tabor it acquired distinctive characteristics (see PIPE AND TABOR). (K. S.)

¹ "The Chester Recorders" in *Proc. Mus. Assoc.*, London, 1901.

² "Hamlet and the Recorder," *ibid.*, 1902 and 1898.

RECTOR (Lat. for "ruler," "guide," &c., from *regere*, "rule"), a title given to the bearers of certain ecclesiastical and academical offices. In the Roman empire, after Constantine, the title *rector* was borne by governors of provinces subordinate to the prefects or exarchs. In the middle ages it was given to certain secular officials, e.g. the podestas of some Italian towns, but more especially to the heads of the universities, the representatives and rulers of the *universitas magistrorum et scholarium*, elected usually for a very short time. After the humanistic movement of the Renaissance the style *rector* was also given to the chief masters of schools containing several classes, and in some parts of Germany (e.g. Saxony, Württemberg) it is still thus used instead of the more modern title of *Director*. Rector is also still the title of the heads of the Scottish universities (Lord Rector), who are elected for three years, and of the German universities (*Rector Magnificus*), in which the office is held for a year by a representative of each faculty in turn. In those German universities where the rectorship is held by the sovereign (*Rector Magnificentissimus*), the acting head is known as *Prorector*. "Rector" is also the title of the heads of Exeter and Lincoln Colleges, Oxford. The heads of all Jesuit colleges are "rectors."

As an ecclesiastical title *rector* was once loosely used for rulers of the Church generally, whether bishops, abbots or parish priests (see Du Cange, *Rectores ecclesiarum*). The *Rectores Apostolici Patrimonii* were clerics of the Roman Curia charged with the duty of looking after the interests of the patrimony of St Peter. The ecclesiastical title *rector*, however, became ultimately confined in certain parts of Europe (Poland, Spain and notably England) to the office of a priest having a cure of souls. In its English use it is thus synonymous with "curate" in the sense used in the Prayer Book. In the middle ages a large number of rectories were held by religious houses, which drew the bulk of the tithes and appointed vicars to do the work. Hence the modern distinction in England between rectors and vicars. A rector is incumbent of a benefice never held under a monastery, and he receives all the tithes; a vicar (i.e. of an ancient benefice) draws only such tithes as were left to the benefice by the religious house which held it. On the suppression of the monasteries the "great tithes" were often bestowed by the crown on laymen, who, as owning the rectorial tithes, were and are known as "lay rectors." It follows that, rectories being usually richer than vicarages, the style of "rector" is in England slightly more dignified than that of "vicar." In the American Protestant Episcopal Church the incumbents of churches are called rectors.

RECUSANT (from Lat. *recusare*, to refuse), the name, in English history, given in the 16th and 17th centuries to those persons who persisted in refusing to attend the services of the English Church, and particularly to those of the Roman Catholic faith (see ROMAN CATHOLIC CHURCH, § *English Law*).

REDAN, in fortification, a work of V-shape presenting a salient angle towards the expected attack. The gorge (rear) of a redan is open. When unsupported by other works, it has the disadvantage that its fire is divergent and but few guns can be brought to bear directly towards the front. Further, both its faces are usually open to enfilade. Redans were therefore almost always used in conjunction with other works, one of the most common forms being the "lines of redans" used as field works. These consisted of lengths of plain trenches facing the front, with redans at intervals along the line. In the present day the term redan is loosely applied to works merely possessing saliency, as in the case of the celebrated bastions Nos. 3 and 2 at Sevastopol in 1854-55, usually called the "Redan" and "Little Redan" respectively (see CRIMEAN WAR). The "Redan" was a large work of irregular outline, generally resembling a redan, but having the salient angle blunted or rounded off and the side faces broken into several minor fronts so as to obtain a field of fire in many directions. (See FORTIFICATION AND SIEGECRAFT.)

RED BANK, a borough of Monmouth county, New Jersey, U.S.A., on an estuary known as Navesink river, at the head of

navigation, about 6 m. W. of the Atlantic Ocean, and about 25 m. S. of New York City. Pop. (1905) 6263; (1910) 7398. Red Bank is served by the Central of New Jersey and the Pennsylvania railways, and by steamboats to New York, and is connected with the neighbouring towns by electric lines. It is a residential suburb of New York City and a summer resort. In the winter ice-boating is a popular amusement, and Red Bank has fish and oyster industries of some importance.

The name Red Bank was applied to this locality as early as 1734, and in 1781 there were several buildings within the limits of the present borough. Red Bank was incorporated as a town in 1870 and became a borough in 1908. Near Red Bank was established in 1843 the North American phalanx, a Fourierite community, with a capital of about \$8000 and 112 members, on about 673 acres; it was financially the most successful and the longest lived of the Fourierist phalansteries in America, but broke up in 1855 because of internal dissensions, following a fire which destroyed the mills.¹

REDBREAST,² or ROBIN, perhaps the favourite among English birds because of its pleasing colour, its sagacity and fearlessness of man, and its cheerful song, even in winter. In July and August the hedgerows of the southern counties of England are beset with redbreasts, not in flocks, but each individual keeping its own distance from the next³—all, however, on their way to cross the Channel. On the European continent the migration is still more marked, and the redbreast on its autumnal and vernal passages is the object of bird-catchers, since its value as a delicacy has long been recognized. Even those redbreasts which stay in Britain during the winter are subject to a migratory movement. The first sharp frost makes them change their habitation, and a heavy fall of snow drives them towards the homesteads for food. The redbreast exhibits a curious uncertainty of temperament in regard to its nesting habits. At times it will place the utmost confidence in man, and at times show the greatest jealousy. The nest is usually built of moss and dead leaves, with a moderate lining of hair. In this are laid from five to seven white eggs, sprinkled or blotched with light red.

Besides the British Islands, the redbreast (*Motacilla rubecula* of Linnaeus and the *Erithacus rubecula* of modern authors) is generally dispersed over the continent of Europe, and is in winter found in the oases of the Sahara. Its eastern limits are not well determined. In northern Persia it is replaced by a nearly allied form, *Erithacus hyrcanus*, distinguishable by its

¹ The borough of Red Bank should be distinguished from a place of the same name in Gloucester county, New Jersey, about 6 m. below Camden, on the Delaware river, nearly opposite the mouth of the Schuylkill river, which was the site of Fort Mercer in the American War of Independence. Fort Mercer, with Fort Mifflin (nearly opposite it on an island in the Delaware), prevented the co-operation of the British navy with the army which had occupied Philadelphia in September. On the 22nd of October Fort Mercer, held by 600 men under Col. Christopher Greene (1737-1781), was unsuccessfully attacked by a force of about 2500 men, mostly Hessians, under Col. Carl Emil Kurt von Donop, the Hessians losing about 400 men, including Donop, who was mortally wounded. The British naval force was prevented by the "Pennsylvania navy" under John Hazelwood (c. 1726-1800) from taking part in the attack; two British ships were destroyed; and the fire from the American vessels added to the discomfiture of the Hessians. On the 15th of November Fort Mifflin was destroyed after a five days' bombardment from batteries on the Pennsylvania shore and from British vessels in the rear; and on the 20th Fort Mercer was abandoned before Cornwallis's approach and was destroyed by the British. Philadelphia was then put in touch with Admiral Howe's fleet and with New York City. Near Red Bank a monument to Christopher Greene was erected in 1829.

² English colonists in distant lands have applied the common nickname of the redbreast to other birds that are not immediately allied to it. The ordinary "robin" of North America is a thrush, *Turdus migratorius* (see FIELDFARE), and one of the bluebirds of the same continent, *Sialia sialis*, is in ordinary speech the blue "robin"; the Australian and Pacific "robins" of the genus *Petroeca* are of doubtful affinity and have not all even the red breast; the Cape "robin" is *Cossophya caffra*, the Indian "robin" *Thamnobia* and the New Zealand "robin" *Miro*.

³ It is a very old saying that *Unum arbutum non alit duos erithacos*—One bush does not harbour two redbreasts.

more ruddy hues, while in northern China and Japan another species, *E. akahige*, is found of which the sexes differ somewhat in plumage—the cock having a blackish band below his red breast and greyish-black flanks, while the hen closely resembles the familiar British species—but both cock and hen have the tail of chestnut-red. The genus *Eriihacus*, as well as that containing the other birds to which the name "robin" has been applied, with the doubtful exception of *Petroeca*, belong to the sub-family Turdinae, of the thrushes (*q.v.*).

REDCAR, a watering-place in the Cleveland parliamentary division of the North Riding of Yorkshire, England, 8 m. N.E. of Middlesbrough, on a branch of the North-Eastern railway. Pop. of urban district (including the township of Coatham, 1901) 7695. Its long range of firm sands from Tees mouth to Saltburn, a distance of 10 m., has made it a popular summer resort. Race meetings are held here on Whit Monday and Tuesday, and in August. Redcar is close to the Cleveland iron-working district of which the centre is Middlesbrough, and is in great favour with the large industrial population of that district.

REDDITCH, a town in the eastern parliamentary division of Worcestershire, England, situated on an eminence near the Warwickshire border, 15½ m. S. of Birmingham by the Midland railway. Pop. of urban district (1901) 13,493. It is the centre of a district producing needles and fish-hooks. There are also motor-engineering works. The town possesses a literary and scientific institute (1850). In the modern church of St Stephen (1854) are preserved tiles from the former Cistercian abbey of Bordesley, founded in 1138, of which the site may be traced at Bordesley Park, 2 m. N.

REDESDALE, JOHN FREEMAN-MITFORD, BARON (1748–1830), English lawyer and politician, younger son of John Mitford (d. 1761) and brother of the historian William Mitford, was born in London on the 18th of August 1748. Having become a barrister of the Inner Temple in 1777, he wrote *A Treatise on the Pleadings in Suits in the Court of Chancery by English Bill*, a work of great value, which has been reprinted several times in England and America. In 1788 Mitford became member of parliament for the borough of Beerlston in Devon, and in 1791 he introduced the important bill for the relief of Roman Catholics, which was passed into law. In 1793 he succeeded Sir John Scott, afterwards Lord Eldon, as solicitor-general for England, becoming attorney-general six years later, when he was returned to parliament as member for East Looe, in Cornwall. In February 1801 Sir John Mitford (as he was now) was chosen speaker of the House of Commons. Exactly a year later, he was appointed lord chancellor of Ireland and was created a peer of the United Kingdom as Baron Redesdale. Being an outspoken opponent of Roman Catholic emancipation, Redesdale was unpopular in Ireland. In February 1806 he was dismissed on the formation of the ministry of Fox and Lord Grenville. Although Redesdale declined to return to official life, he was an active member of the House of Lords both on its political and its judicial sides. In 1813 he secured the passing of acts for the relief of insolvent debtors, and later he was an opponent of the repeal of the Test and Corporation Acts and of other popular measures of reform. Redesdale, who was a fellow of the Royal Society and a member of three commissions on the public records, died on the 16th of January 1830. In 1803 he married Frances (d. 1817), daughter of John, 2nd earl of Egmont. He took the additional name of Freeman in 1809 on succeeding to the estates of Thomas Edwards Freeman.

His only son, John Thomas Freeman Mitford (1805–1886), succeeded to the title. In 1851 he was chosen chairman of committees in the House of Lords, a position which he retained until his death, and in 1877 he was created earl of Redesdale. His chief interest was reserved for ecclesiastical questions, and he won some repute as a Protestant controversialist. He assisted to revive Convocation in 1853; was an active opponent of the disestablishment of the Irish Church; and engaged in controversy with Cardinal Manning on the subject of com-

munion in both kinds. On his death, on the 2nd of May 1886, his titles became extinct. He wrote *Thoughts on English Prosody and Translations from Horace*, and *Further Thoughts on English Prosody* (Oxford, 1859), in addition to various pamphlets on ecclesiastical topics.

The earl bequeathed his estates to his kinsman, Algernon Bertram Freeman-Mitford (b. 1837), a great-grandson of William Mitford. He had been in the diplomatic service from 1858 to 1873, and had been secretary to the Office of Works from 1874 to 1886. From 1892 to 1895 he was member of parliament for the Stratford-on-Avon division of Warwickshire, and he was created Baron Redesdale in 1902. He was well known for his writings on Japan, *Tales of Old Japan* (1871), *The Attaché at Peking* (1900), &c.

See O. J. Burke, *History of the Lord Chancellors of Ireland* (Dublin, 1879); J. R. O'Flanagan, *Lives of the Lord Chancellors of Ireland* (1879); Sir J. Barrington, *Personal Sketches of His Own Times* (1869); Sir S. E. Brydges, *Autobiography* (1834); and C. Abbot, Lord Colchester, *Diary and Correspondence* (London, 1861).

REDFERN, a municipality of Cumberland county, New South Wales, Australia, adjoining the city of Sydney on the S.S.W. Pop. (1901) 24,282. It is a busy manufacturing centre, having numerous ironworks, coach factories, boot factories, printing works, iron and brass foundries, soap factories and extensive railway works.

REDGRAVE, RICHARD (1804–1888), English artist, was born at Pimlico on the 30th of April 1804, and worked at first as a designer. He became a student in the Royal Academy Schools in 1826, and was elected an Associate in 1840 and an Academician in 1851 (retired, 1882). His "Gulliver on the Farmer's Table" (1837) made his reputation as a painter. He began in 1847 a connexion with the Government Art Schools which lasted for a long term of years, and among other posts he held those of inspector-general of art in the Science and Art Department, and art director of the South Kensington Museum. He was greatly instrumental in the establishment of this institution, and he claimed the credit of having secured the Sheepshanks and Ellison gifts for the nation. He was also surveyor of the royal pictures. He was offered, but declined, a knighthood in 1869. Redgrave was an assiduous painter of landscape and genre; his best pictures being "Country Cousins" (1848) and "The Return of Olivia" (1848), both in the national collection, "The Sempstress" (1844), "Well Spring in the Forest" (1865). He died on the 14th of December 1888.

See the *Memoir* by F. M. Redgrave, 1891.

REDLANDS, a city of San Bernardino county, in southern California, U.S.A., 67 m. (by rail) E. of Los Angeles. Pop. (1900) 4797; (1910) 10,449. It is served by the Southern Pacific and the Atchison, Topeka & Santa Fé railways and by interurban electric lines. The city lies at an altitude of 1350–1600 ft. at the eastern end of the San Bernardino Valley, surrounded on three sides by mountains. To the east Grayback (11,725 ft.) and San Bernardino (11,600 ft.), to the south-east San Jacinto (10,805 ft.), and to the north-west Cajon Pass (4119 ft.) and San Antonio, of Old Baldy (10,142 ft.), are conspicuous landmarks. The city is a well-known tourist and health resort, with beautiful drives. Canyon Crest Park (Smiley Heights) contains about 300 acres, and Prospect Park 50 acres. The city has the A. K. Smiley Public Library, the gift of A. K. Smiley, and is the seat of the University of Redlands (Baptist; co-educational), incorporated in 1907 and opened in 1909. Redlands is one of the most famous orange-growing and shipping centres of California; it also ships other citrus fruits, olive oil, barley, wheat and stone. Olive oil and jam, marmalade and preserved fruits are manufactured. There are electric power plants in the mountains (three in Mill Creek Canyon and two in Santa Ana Canyon). A settlement called Lugonia was established within the limits of the present city in 1874, but Redlands dates from 1887, when it was settled by people from New England, and was chartered as a city.

REDMOND, JOHN EDWARD (1851–), Irish politician, son of W. A. Redmond, M.P., was born at Waterford in 1851.

He was educated at Trinity College, Dublin, and was called to the bar at Gray's Inn in 1886, and subsequently to the Irish bar, though he never practised. He was a clerk in the vote office of the House of Commons before he entered parliament in 1881 as member for New Ross. From 1885 to 1891 he represented North Wexford. As party whip he rendered great service to the Irish members by his thorough grasp of the procedure of the House. At the time of the rupture of the Irish party consequent on the Parnell scandals, Redmond was the most eloquent member of the minority who continued to recognize his leadership, and in 1891 he became the accredited leader of the Parnellites. In 1900 the two Nationalist parties were amalgamated under his leadership. He contested Cork unsuccessfully in 1891, but was elected for Waterford, where he was re-elected in 1906. (For the political events under his leadership of the Irish parliamentary party up to 1910, see IRELAND: *History*; ENGLISH HISTORY and allied articles.)

REDON, a town of western France, capital of an arrondissement in the department of Ille-et-Vilaine, 45 m. S.S.W. of Rennes by rail. Pop. (1906) 5170. Redon is situated on the right bank of the Vilaine, above the confluence of the Oust and on the canal from Nantes to Brest. The Church of St Sauveur, formerly belonging to an abbey, has a Romanesque central tower, square in form but with rounded angles. A fine tower of the 14th century with a stone spire stands isolated from the church, from which it was separated owing to the destruction of part of the nave by fire in 1782. The choir, with ambulatory and radiating chapels, forms one of the most remarkable examples of 13th-century architecture in Brittany. The abbey has been converted into an ecclesiastical college. Some 16th-century timbered houses have interesting carvings. The industries include the manufacture of emery and polish, agricultural implements and boat-building, tanning, brewing and flour-milling. The port is accessible at high tides for vessels of 600 to 700 tons. Redon grew up round a monastery founded in the first half of the 9th century. In the 14th century Jean de Tréal, one of the abbots, surrounded the town with walls, of which a remnant is still to be seen.

REDONDA, an island in the British West Indies. It is a dependency of Antigua, and lies 25 m. S.W. of it, in 25° 6' N. and 61° 35' W. Pop. (1901) 120. It is a rocky mountain, rising abruptly from the sea to a height of 1000 ft., and has an area of $\frac{1}{2}$ sq. m. It is valuable for its phosphate of alumina (discovered in 1865), of which 7000 tons are exported every year to the United States.

REDONDELA, a town of north-western Spain, in the province of Pontevedra; 7 m. N.E. of Vigo, in a bend of the Vigo estuary, and at the junction of the Tuy-Vigo and Vigo-Pontevedra railways. Pop. (1900) 10,843. The river is only accessible for small coasting vessels; it is the headquarters of a prosperous fishing industry. In the neighbourhood are ruins of several medieval castles, and the fine hall of the Marquess Vega de Armijo.

REDOUBT (Fr. *redoute*, from Med. Lat. *reductus*, a place of retreat, refuge, *reducere*, lead back, retire; the intrusive *b* is due to the O. Fr. *redoubter*, to fear, Lat. *dubitare*, to doubt), a term in fortification for a small closed work of plain trace, generally used in conjunction with lines of infantry trenches (see FORTIFICATION AND SIEGECRAFT). The term "reduit" (Fr. *réduit*), often confused with "redoubt," is only used for a keep or interior refuge for the garrison of a larger work, corresponding, on a small scale, to the citadel of a fortress.

RED RIVER, the name of two American rivers, one emptying into the Mississippi near its mouth, and the other emptying into Lake Winnipeg.

1. The Red river, sometimes called the Red River of Louisiana, is the southernmost of the large tributaries of the Mississippi. It rises in northern Texas, in the northern part of the Staked Plains, or Llano Estacado, flows E. by S. in Texas, between Texas and Oklahoma, and to Fulton, in south-western Arkansas, there turns S.E. and continues in a general south-easterly direction through Louisiana to the bank of the Mississippi,

where it discharges partly into the Mississippi and partly into the Atchafalaya. Its length is estimated at 1200 m. or more; its drainage basin has an area of at least 90,000 sq. m.; and its discharge ranges from 3500 cub. ft. to 180,000 cub. ft. per second. It is somewhat saline in its upper course, and in its middle and lower course is laden with a reddish silt from which it takes its name. From an elevation on the Staked Plains of about 2450 ft., the river plunges into a canyon which is about 60 m. long and has nearly perpendicular walls of sandstone and gypsum formation 500 to 800 ft. high. Immediately below the canyon the river spreads out over a broad and sandy bed and flows for about 500 m. through a semi-arid plain. It narrows on entering the alluvial bottom lands, through which it pursues a sluggish and meandering course for the last 600 m. At high stages, from December to June, it is continually shifting its channel in this part of its course, by eroding one bank and making deposits on the other, and as the upper portion is densely wooded the falling trees, unless removed, become an obstruction to navigation. In 1828 the trees which the river had felled formed the great "Red River raft" extending from Loggy Bayou, 65 m. below Shreveport, Louisiana, to Hurricane Bluffs, 27 m. above Shreveport. Congress began in that year to make appropriations for the removal of the raft, and by 1841 Henry M. Shreve had opened a channel. The river was neglected from 1857 to 1872 and another raft, 32 m. in length, formed above Shreveport. A channel was opened through this in 1872-73, and the complete removal of the obstruction a few years later so improved the drainage that a large tract of waste land was reclaimed. In its course through Louisiana the river has built up a flood-plain with silt deposits more rapidly than its tributaries, with the result that numerous lakes and bayous have been formed on either side, and Cypress Bayou was so flooded that boats plied between Shreveport, Louisiana and Jefferson, Texas, 45 m. apart; but with the improvement of the river these lakes have become shallow or dry. For the improvement of navigation here not only the removal of snags is necessary, but there must be dredging, closure of outlets, building of levees to narrow and deepen the channel, and revetment works to protect the banks. The cost of these works has been great (up to July 1909 more than \$2,360,000 below Fulton, Arkansas, and more than \$215,000 above Fulton), but they have rendered the river navigable, except at very low stages, by vessels drawing 3 ft. of water from its mouth to Fulton, Arkansas, a distance of 508.6 m., and at the highest stages,¹ in March and April, it is navigable to Denison, Texas, 292 m. farther up. The Ouachita and Black (one river), which is the principal tributary of the Red, joins it near its mouth and is navigable at high stages to Arkadelphia, Arkansas; and in 1910 a system of nine locks with movable dams was under construction by the Federal government for the purpose of securing a channel 6½ ft. deep at all stages to a point 10 m. above Camden, Arkansas, a distance of 360 m.

During the Civil War, in March and April 1864, Major-General Nathaniel P. Banks conducted a combined military and naval expedition up the Red river in an attempt to open a Federal highway to Texas, but on the 8th of April the vanguard of his army was repulsed with heavy loss at Sabine Cross-Roads by the Confederates under Lieutenant-General Richard Taylor and the expedition was abandoned; the gunboats commanded by D. D. Porter were held above Alexandria by the lowness of the river, but it was flooded by a hurriedly built dam, and they escaped.

See R. B. Marcy and G. B. McClellan, *Exploration of the Red River of Louisiana* (Washington, 1853), and the annual *Reports* of the Chief of Engineers of the U.S. Army.

2. The Red river, commonly called the Red River of the North, rises in the lake region of western Minnesota, not far from the headwaters of the Mississippi, flows north between Minnesota and North Dakota, continues northward through the Canadian province of Manitoba, and discharges into Lake Winnipeg. It has cut a gorge 20-50 ft. deep through clay deposits through-

¹ The range between low water and high water at Fulton is 35.65 ft.

out the greater part of its course; it drains a region that is famous for the production of wheat; and much water power has been developed on its tributaries. The United States government has improved its channel from the international boundary to Breckenridge, Minnesota, a distance of 395.5 m., and occasionally the water reaches a height which permits small steamboats to ascend its S.W. branch to Lake Traverse and from there to descend the Minnesota river to the Mississippi.

RED RIVER SETTLEMENT, a Scottish colony founded in 1811 near the present city of Winnipeg by a philanthropic Scottish nobleman, Lord Selkirk, who at that time controlled the Hudson's Bay Company. Quarrels soon arose with the French and half-breed *employés* of the North-West Fur Company, and were fostered by its officials. On June 19, 1816, in a fight between the rivals, Governor Semple of the Hudson's Bay Company and twenty of his twenty-seven attendants were killed, an affair known as the Battle of Seven Oaks. New settlers were sent by Selkirk, and founded the village of Kildonan, now part of Winnipeg. In 1821 the rival companies united, and in 1836 repurchased from Selkirk's heirs all rights to the territory. In 1821 and in 1835 two forts, known as Lower and Upper Fort Garry, were built to command the junction of the Red and Assiniboine rivers, and around them grew up a mixed population of Scots, French and Indians. The purchase in 1869 of the territorial rights of the Company by the Dominion of Canada led to a rebellion, and the setting up of a provisional government under Louis Riel, which was dispersed by a force of British regulars under Colonel (later Lord) Wolseley.

See CANADA (*History*); also George Bryce, *Remarkable History of the Hudson's Bay Company* (1900).

REDRUTH, a market town in the Camborne parliamentary division of Cornwall, England, 17 m. E.N.E. of Penzance, on the Great Western railway. Pop. of urban district (1901) 10,451. It lies high, on the northward slope of the central elevation of the county, with bare rocky moors to the south. It is the chief mining town in Cornwall, and the bulk of the population is engaged in the tin mines or at the numerous tin-streaming works. The parish church of St Uny, of which only the tower is ancient (Perpendicular), stands outside the town to the west, at the foot of a rugged hill named Carn Brea. On the summit of this hill, besides a monument (1836) to Lord de Dunstanville and a small ancient castle, various prehistoric remains are traceable. A museum attached to the science and art schools and a miners' hospital are notable institutions in Redruth. A large quantity of the tin is sold by public auction at the mining exchange, the sales being known as tin-ticketings. There are manufactures of safety fuses, breweries, iron foundries and railway works. Tramways serve the neighbouring mines and the small port of Portreath on the north coast.

RED SEA, a narrow strip of water extending S.S.E. from Suez to the Strait of Bab el-Mandeb in a nearly straight line, and separating the coasts of Arabia from those of Egypt, Nubia and Abyssinia. Its total length is about 1,200 m., and its breadth varies from about 250 m. in the southern half to 130 m. in 27° 45' N., where it divides into two parts, the Gulf of Suez and the Gulf of Akaba, separated from each other by the peninsula of Sinai.

The Gulf of Suez is shallow, and slopes regularly down to the northern extremity of the Red Sea basin, which has a maximum depth of 640 fathoms, and then over a shoal of 60 fathoms goes down to 1,200 fathoms in 22° 7' N. The Gulf of Akaba is separated from the Red Sea by a submarine bank only 70 fathoms from the surface, and in 28° 39' N. and 34° 43' E. it attains the depth of 700 fathoms. South of the 1,200-fathom depression a ridge rises to 500 fathoms in the latitude of Jidda, and south of this again a similar depression goes down to 1,100 fathoms. Throughout this northern part, *i.e.* to the banks of Suakin and Farsan in 20° N., the 100-fathom line keeps to a belt of coral reef close inshore, but in lower latitudes the shallow coral region, 300 m. long and 70 to 80 m. across, extends farther and farther seaward, until in the latitude of Hodeda the deep channel (marked by the 100-fathom line) is

only 20 m. broad, all the rest of the area being dangerous to navigation, even for small vessels. In the middle of the gradually narrowing channel three depressions are known to exist; soundings in two of these are: 1,110 fathoms in 20° N. and 800 fathoms in 16° N., a little to the north of Massawa. To the north-west of the volcanic island of Zebayir the depth is less than 500 fathoms; the bottom of the channel rises to the 100-fathom line at Hanish Island (also volcanic), then shoals to 45 fathoms, and sinks again in about the latitude of Mokha in a narrow channel which curves westward round the island of Perim (depth 170 fathoms), to lose itself in the Indian Ocean. This western channel is 16 m. wide in the Strait of Bab el-Mandeb; the eastern channel of the strait is 2 m. broad and 16 fathoms deep.

Murray estimates the total area at 158,750 sq. m., and its volume at 67,700 cub. m., giving a mean depth of 375 fathoms. Karstens gives the area at 448,810 sq. kilometres (130,424 sq. geographical m.) and the volume at 206,901 cub. kilometres (32,413 cub. geographical m.), which gives a mean depth of 252 fathoms. Both these computations, however, were made before the date of the Austrian exploring expeditions (1896-98). Bludau's measurements give the total area draining to the Red Sea at about 255,000 sq. geographical m. Krümmel's more recent calculations (see OCEAN) give values somewhat higher than those of Karstens.

The Red Sea is formed by a line of fracture, probably dating from Pliocene times, crossing the centre of a dome of Archean rocks, on both flanks of which, in Egypt and Arabia, rest Secondary and Tertiary deposits. The granite rocks forming the core of the dome appear at the surface on the Red Sea coast, at the western end of the transverse line of heights crossing Nejd. Along the line of fracture traces of volcanic activity are frequent; a group of volcanic islands occurs in 14° N., and on Jebel Teir, farther north, a volcano has only recently become extinct. The margin of the Red Sea itself consists, on the Arabian side, of a strip of low plain backed by ranges of barren hills of coral and sand formation, and here and there by mountains of considerable height. The greater elevations are for the most part formed of limestones, except in the south, where they are largely volcanic. The coasts of the Gulf of Akaba are steep, with numerous coral reefs on both sides. On the African side there are in the north wide stretches of desert plain, which towards the south rise to elevated tablelands, and ultimately to the mountains of Abyssinia. The shores of the Red Sea are little indented; good harbours are almost wanting in the desert regions of the north, while in the south the chief inlets are at Massawa, and at Kamaran, almost directly opposite. Coral formations are abundant; immense reefs, both barrier and fringing, skirt both coasts, often enclosing wide channels between the reef and the land. The reefs on the eastern side are the more extensive; they occur in places as much as 25 m. from the land. It has long been known that the whole Red Sea area is undergoing gradual elevation, and much has been done in recent years in investigating the levels of raised beaches found in different localities.

In the northern part, down to almost 19° N., the prevailing winds are north and north-west. The middle region, to 14°-16° N., has variable winds in an area of low barometric pressure, while in the southern Red Sea south-east and east winds prevail. From June to August the north-west wind blows over the entire area; in September it retreats again as far as 16° N., south of which the winds are for a time variable. In the Gulf of Suez the westerly, or "Egyptian," wind occurs frequently during winter, sometimes blowing with violence, and generally accompanied by fog and clouds of dust. Strong north-north-east winds prevail in the Gulf of Akaba during the greater part of the year; they are weakest in April and May, sometimes giving place at that season to southerly breezes. The high temperature and great relative humidity make the summer climate of the Red Sea one of the most disagreeable in the world.

The mean annual temperature of the surface waters near the head is 77° F.; it rises to 80° in about 22° N., to 84° in 16° N., and drops again to 82° at the Strait of Bab el-Mandeb. Daily variations of temperature are observable to a depth of over 50 fathoms. Temperature is, on the whole, higher near the Arabian than the Egyptian side, but it everywhere diminishes with increase of depth and latitude, down to 380 fathoms from the surface; below this depth a uniform constant temperature of 70.7° F. is observed throughout. In the Gulf of Suez temperature is relatively low, falling rapidly from south to north. The waters of the Gulf of Akaba are warmer towards the Arabian than the Sinai coasts; a uniform temperature of 70.2° is observed at all depths below 270 fathoms.

The salinity of the waters is relatively great, the highest recorded being 42.7 per mille (Gulf of Suez), and the lowest 36.2 (Perim harbour). The distribution is, speaking generally, the opposite to that of temperature; salinity increases from the surface downwards, and from the south northwards, and it is greater towards the western than the eastern side. This statement holds good for the Gulf of Suez, in which the water is much saltier than in the open sea; but in the Gulf of Akaba the distribution is exceedingly uniform, nowhere differing much from an average of 40.6 per mille.

The movements of the waters are of great irregularity and complexity, rendering navigation difficult and dangerous. Two features stand out with special distinctness: the exchange of water between the Red Sea and the Indian Ocean, and the tidal streams of the Gulf of Suez. From the observations of salinity it is inferred that a surface current flows inwards to the Red Sea in the eastern channel of the Strait of Bab el-Mandeb, while a current of very salt water flows outward to the Indian Ocean, through the western channel, at a depth of 50 to 100 fathoms from the surface. In the Gulfs of Suez and Akaba, almost the only part of the Red Sea in which tidal phenomena are well developed, a sharply defined tidal circulation is found. Elsewhere the surface movements at least are controlled by the prevailing winds, which give rise in places to complex "transverse" currents, and near the coast are modified by the channels enclosed by the coral reefs. During the prevalence of the north and north-west winds the surface level of the northern part of the Red Sea is depressed by as much as 2 ft. The great evaporation going on from the surface probably causes a slow vertical circulation in the depth, the saltier colder waters sinking, and ultimately escaping to the Indian Ocean. Extensive collections of the deposits forming the bed were made by the expeditions of the Austrian ship "Pola" (1896 and 1898). These were analysed by Dr K. Natterer, whose conclusions, however, have been disputed by a number of other investigators. The zoological collections of the "Pola" expeditions show that certain well-defined districts are extremely rich in plankton, while others are correspondingly poor; and it appears that the latter occur in districts surrounded by currents of relatively low temperature, while the richer parts are where the movements of water are blocked by irregularities in the coast-line.

AUTHORITIES.—A. Issel, *Morfologia e genesi del Mar Rosso. Saggio di Paleogeografia, Congresso Geogr. Ital.* (Florence, 1899); "Die Korallenriffe der Sinai-Halbinsel," *Abhandl. Math.-phys. Gesell. Wiss.*, vol. xiv. (Leipzig, 1888); *Meteorological Charts of the Red Sea* (Meteorological Office, 1895); *Report of the Voyage of the Russian Corvette "Vitzia"* (1889); "Berichte der Commission für oceanographische Forschungen," 6th series, 1898 in vol. LXV. of the *Denkschriften der K.K. Akademie der Wissenschaften* (Vienna); also various notes and preliminary reports in the *Sitzungsberichte* of the Vienna Academy of Sciences; *Report of the Voyage of H.M.S. "Challenger."* "Oceanic Circulation," p. 30; J. Hann, *Klimatologie* (1897), vol. iii. p. 76. (H. N. D.)

REDSHANK, the usual name of a bird—the *Scolopax calidris* of Linnaeus and *Totanus calidris* of modern authors—so called in English from the colour of the bare part of its legs, which, being also long, are conspicuous as it flies or runs. In suitable localities it is abundant throughout the greater part of Europe and Asia, from Iceland to China, mostly retiring to the southward for the winter, though a considerable number remain during that season along the coasts and estuaries of some of the more northern countries. Before the great changes effected by drainage in England it was a common species in many districts, but at the present day there are very few to which it can resort for the purpose of reproduction. The body of the redshank is as big as a snipe's, but its longer neck, wings and legs make it appear a much larger bird. Above, the general colour is greyish-drab, freckled with black, except the lower part of the back and a conspicuous band on each wing, which are white, while the flight-quills are black, thus producing a very harmonious effect. In the breeding season the back and breast are mottled with dark brown, but in winter the latter is white. The nest is generally concealed in a tuft of rushes or grass, a little removed from the wettest parts of the swamp whence the bird gets its sustenance, and contains four eggs, usually of a rather warmly tinted brown with blackish spots or blotches; but no brief description can be given that would point out their differences from the eggs of other birds, more or less akin, among which, those of the lapwing (*q.v.*) especially, they are taken and find a ready sale.

The name Redshank, prefixed by some epithet as Black, Dusky or Spotted, has also been applied to a larger but allied species—

the *Totanus fuscus* of ornithologists. This is a much less common bird, and in Great Britain as well as the greater part of Europe it only occurs on its passage to or from its breeding-grounds, which are usually found south of the Arctic Circle, and differ much from those of its congeners—the spot chosen for the nest being nearly always in the midst of forests and, though not in the thickest part of them, often with trees on all sides, generally where a fire has cleared the undergrowth, and mostly at some distance from water. This peculiar habit was first ascertained by Wolley in Lapland in 1853 and the following year. The breeding-dress this bird assumes is also very remarkable, and seems (as is suggested) to have some correlation with the burnt and blackened surface interspersed with white stones or tufts of lichen on which its nest is made—for the head, neck, shoulders and lower parts are of a deep black, contrasting vividly with the pure white of the back and rump, while the legs become of an intense crimson. At other times of the year the plumage is very similar to that of the common redshank, and the legs are of the same light orange-red. (A. N.)

REDSTART, a bird well known in Great Britain, in many parts of which it is called firetail—a name of almost the same meaning, since "start" is from the Anglo-Saxon *steort*, a tail. This beautiful bird, *Ruticilla phoenicurus*, returns to England about the middle or towards the end of April, and at once takes up its abode in gardens, orchards and about old buildings, when its curious habit of flirting at nearly every change of position its brightly-coloured tail, together with the pure white forehead, the black throat, and bright bay breast of the cock, renders him conspicuous, even if attention be not drawn by his lively though intermittent song. The hen is much more plainly attired; but the characteristic colouring and action of the tail pertain to her equally as to her mate. The nest is almost always placed in a hole of a tree or building, and contains from five to seven eggs of a delicate greenish blue, occasionally sprinkled with faint red spots. The young on assuming their feathers present a great resemblance to those of the redbreast (*q.v.*) at the same age; but the red tail, though of duller hue than in the adult, forms even at this early age an easy means of distinguishing them. The redstart breeds regularly in all the counties of England and Wales. It also reaches the extreme north of Scotland; but in Ireland it is very rare. It appears throughout the whole of Europe in summer, and is known to winter in the interior of Africa. Several very nearly allied forms occur in Asia; and one, *R. aurora*, in Japan.

A congeneric species which has received the name of black redstart, *Ruticilla litys*,¹ is very common throughout the greater part of the continent of Europe, where, from its partiality for gardens in towns and villages, it is often better known than the preceding species. It yearly occurs in certain parts of England, chiefly along or near the south coast, and curiously enough during the autumn and winter, since it is in central Europe only a summer visitor, and it has by no means the high northern range of *R. phoenicurus*. The males of the black redstart seem to be more than one year in acquiring their full plumage (a rare thing in Passerine birds), and since they have been known to breed in the intermediate stage this fact has led to such birds being accounted a distinct species under the name of *R. cairii*, thereby perplexing ornithologists for a long while, though now almost all authorities agree that these birds are, in one sense, immature.

More than a dozen species of the genus *Ruticilla* have been described, and the greater number of them seem to belong to the Himalayan sub-region or its confines. One very pretty and interesting form is the *R. moussieri* of Barbary, which allies the redstart to the stone-chats (see **WHEATEAR**), and of late some authors have included it in that genus. In an opposite direction the bluetheats, apparently nearer to the redstarts than to any other type, are placed in the genus *Cyanecula*, containing two or three distinguishable forms: (1) *C. succica*, with a bright bay spot in the middle of its clear blue throat, breeding in Scandinavia, Northern Russia and Siberia, and wintering in Abyssinia and India, though rarely appearing in the intermediate countries, to the wonder of all who have studied the migration

¹The orthography of the specific term would seem to be *litis* (*Ann. Nat. History*, ser. 4, x. p. 227), a word possibly cognate with the first syllable of titlark and titmouse.

of birds; (2) *C. leucocyanea*, with a white instead of a red gular spot, a more Western form, ranging from Barbary to Germany and Holland; (3) *C. wolffii*, with its throat wholly blue—a form of comparatively rare occurrence. The first of these is a not infrequent, though very irregular, visitant to England, while the second has appeared there but seldom, and the third never, so far as is known. The redstarts with their allies mentioned in this article belong to the subfamily Turdinae of the thrushes (*q.v.*).

In America the name redstart has been bestowed upon a bird which has some curious outward resemblance, both in looks and manners, to that of the Old Country, though the two are in the opinion of some systematists nearly as widely separated from each other as truly Passerine birds well can be. The American redstart is *Setophaga ruticilla*, belonging to the purely New-World family Mniotiltidae, and to a genus which contains about a dozen species, ranging from Canada (in summer) to Bolivia. (A. N.)

RED WING, a city and the county seat of Goodhue county, Minnesota, U.S.A., on the W. bank of the Mississippi river, near the head of Lake Pepin, about 40 m. S.E. of St Paul. Pop. (1905, state census) 8149, 2138 being foreign-born; (1910) 9048. It is served by the Chicago Great Western and the Chicago, Milwaukee & St Paul railways. Red Wing is the seat of the Lutheran Ladies' Seminary (1894) and the Red Wing Theological Seminary (Lutheran, 1885), and in the vicinity is the State Training School for Boys and Girls, originally the Minnesota State Reform School. In the city are the Carnegie-Lawther library, a Federal building, a municipal theatre, the T. B. Sheldon Memorial Auditorium, in connexion with which is a School of Music, a Y.M.C.A. building, a City Hospital, St John's Hospital (1902) and an old ladies' home. Red Wing is an important wheat market and shipping point.

In 1695 Le Sueur built a post on Prairie Island, in the Mississippi, about 8 m. above the site of Red Wing, for the purpose, according to Charlevoix, of interposing a barrier between the warring Dakotas and Chippewas; and in 1727 René Boucher built on the shore of Lake Pepin a fort which, after various vicissitudes, was abandoned in 1753. An Indian village occupied the site of Red Wing probably for many years before the arrival of the first whites, two Swiss missionaries, Samuel Denton and Daniel Gavin, who maintained a mission here in 1837-46. In 1848 another mission was established by the American Board. Red Wing (named from an Indian chief) was platted in 1853 and was chartered as a city in 1857.

REDWING (Swed. *Rödvinge*, Dan. *Röddrossel*, Ger. *Rotdrossel*, Du. *Köperwiek*), a species of thrush (*q.v.*), *Turdus iliacus*, which is an abundant winter visitor to the British Islands, arriving in autumn generally about the same time as the fieldfare (*q.v.*) does. This bird has its common English name¹ from the sides of its body, its inner wing-coverts and axillaries being of a bright reddish orange, of which colour, however, there is no appearance on the wing itself while the bird is at rest, and not much is ordinarily seen while it is in flight. In other respects it is very like a song-thrush, and indeed in France and some other countries it bears the name *mauvais* or *mavis*, often given to that species in some parts of Britain; but a conspicuous white streak over the eye at once affords a ready diagnosis. The redwing breeds in Iceland, in the subalpine and arctic districts of Norway, Sweden and Finland, and thence across Northern Russia and Siberia, becoming scarce to the eastward of the Yenisei, and not extending beyond Lake Baikal. In winter it visits the whole of Europe and North Africa, occa-

¹ Many old writers assert that this bird used to be known in England as the "swinepipe"; but, except in books, this name does not seem to survive to the present day. There is no reason, however, to doubt that it was once in vogue, and the only question is how it may have arisen. If it has not been corrupted from the German *Weindrossel* or some other similar name, it may refer to the soft inward whistle which the bird often utters, resembling the sound of the pipe used by the swineherds of old when collecting the animals under their charge. Another form of the word (which may, however, be erroneous) is "windpipe." "Whindle" and "wheernerd" have also been given as old English names of this bird (*Harl. Miscellany*, 1st ed., ii. p. 558), and these may be referred to the local German *Weindrüste* and *Winset*.

sionally reaching Madeira, while to the eastward it is found at that season in Persia, and, it is said, at times in the north-western Himalayas and Kohat. Many writers have praised the song of this bird, comparing it with that of the nightingale (*q.v.*); but herein they seem to have been as much mistaken as in older times was Linnaeus, who according to S. Nilsson (*Orn. Suecica*, i. 177, note), failed to distinguish in life this species from its commoner congener *T. musicus*. Its nest and eggs a good deal resemble those of the blackbird, and have none of the special characters which distinguish those of the song-thrush. (A. N.)

REDWITZ, OSKAR, FREIHERR VON (1823-1891), German poet, was born at Lichtenau, near Ansbach, on the 28th of June 1823. Having studied at the universities of Munich and Erlangen, he was apprenticed to the law in the Bavarian State service (1846-49). He next (1849-50) studied languages and literature at Bonn, and in 1851 was appointed professor of aesthetics and of the history of literature at Vienna. In 1852, however, he gave up this post and retired to his estate of Schellenberg, near Kaiserslautern. The pious sentimentality of his romantic epic *Amaranth* (1849; 42nd ed., 1898) had already gained him enthusiastic admirers, and this work was followed, in 1850, by *Ein Märchen* and by *Gedichte* (1852) and the tragedy *Sieglinde* (1854). He next settled on his estates near Kronach, and here wrote the tragedy *Thomas Morus* (1856), the historical dramas *Philippine Welser* (1859) and *Der Zunftmeister von Nürnberg* (1860), of which the first two met with great success. Elected member of the Bavarian Second Chamber for the district in which he lived, he removed to Munich in 1862. In 1868 he published the novel *Hermann Stark, deutsches Leben*, and in 1871 *Das Lied vom neuen deutschen Reich* (which contains several hundred patriotic sonnets). In 1872 he took up his residence at Meran, but passed the last years of his life at a sanatorium for nervous disorders near Bayreuth, where he died on the 6th of July 1891.

See R. Prutz, *Die deutsche Literatur der Gegenwart* (1870), i. pp. 148 ff.; H. Keiter, *Zeitgenössische katholische Dichter Deutschlands* (1884); H. von Völderndorff, *Harmlose Plaudereien eines alten Münchener* (1892); M. M. Rabenlechner, *O. von Redwitz' religiöser Entwicklungsgang* (1897).

REED, ANDREW (1787-1862), English nonconformist divine and philanthropist, was born in London on the 27th of November 1787. He entered Hackney Independent College in 1807 and was ordained minister of New Road Chapel in 1811. About 1830 he built the larger Wycliffe Chapel, where he remained until 1861. He visited America on a deputation to the Congregational Churches in 1834 and received the degree of D.D. from Yale. Reed's name is permanently associated with a long list of philanthropic achievements, including the London Orphan Asylum, the Infant Orphan Asylum and the Reedham Orphanage, which he undertook on non-denominational lines because the governors of the other institutions had made the Anglican Catechism compulsory. Besides these he originated in 1847 an asylum for idiots at Highgate, afterwards moved to Earlswood in Surrey with a branch at Colchester, and in 1855 the Royal Hospital for Incurables at Putney. He died on the 25th of February 1862. Besides an account of his visit to America (2 vols., 1834), he compiled a hymn-book (1841), and published some sermons and books of devotion.

His second son, SIR CHARLES REED (1819-1881), was a successful typefounder and a keen supporter of popular education. As a common councillor of the city of London he developed the Guildhall Library of the City of London School. He was elected M.P. for Hackney (1868 and 1874) and for St Ives, Cornwall (1880), and served as chairman of the London School Board (1873-1881) in succession to Lord Lawrence. He was interested in antiquarian research and in philanthropic work, being an associate of George Peabody and an active worker in connexion with the Sunday School Union, the Bible Society, the Religious Tract Society and the London Missionary Society. His eldest son, Charles Edward Baines Reed (1845-1884) was

educated at Trinity College, Cambridge, and became Congregational minister at Warminster (1871) and a secretary of the British and Foreign Bible Society. He was killed by a fall in Switzerland. Sir Charles Reed's third son, Talbot Baines Reed (1852-1893), educated at the City of London School, became managing director of his father's firm, and was one of the founders and secretary of the Bibliographical Society. He is best known as the author of popular boys' books.

REED, ISAAC (1742-1807), English Shakespearian editor, son of a baker, was born on New Year's Day, 1742, in London. He was articled to a solicitor, and eventually set up as a conveyancer at Staple Inn, where he had a considerable practice. His first important work was the *Biographia dramatica* (2 vols., 1782), consisting of biographies of the dramatists and a descriptive dictionary of their plays. This book, which was an enlargement of David Erskine Baker's *Companion to the Playhouse* (2 vols., 1764), was re-edited (3 vols.) by Stephen Jones in 1811, and is a valuable authority. The original work by Baker had been based on Gerard Langbaine's *Account of the English Dramatick Poets* (1691), Giles Jacob's *Poetical Register* (1719), Thomas Whincop's "List of all the Dramatic Authors" (printed with his tragedy of *Scanderbeg*, 1747) and the MSS. of Thomas Coxeter (1689-1747), an industrious antiquary who had collected much useful material. Reed's *Notitia dramatica* (Addit. MSS. 25390-2, British Museum), supplementary to the *Biographia*, was never published. He revised Dodsley's *Collection of Old Plays* (12 vols., 1780). He also re-edited Johnson and Steevens's edition (1773) of Shakespeare. Reed's edition was published in 10 vols. (1785), and he gave great assistance to Steevens in his edition (1793). He was Steevens's literary executor, and in 1803 published another edition (21 vols.) based on Steevens's later collections. This, which is known as the first *variorum*, was re-issued ten years later. He died on the 5th of January 1807. His valuable library of theatrical literature was catalogued for sale as *Bibliotheca Reediana* (1807).

See John Nichol's *Lit. Anec. of the 18th Century* (vol. ii., 1812); and Edward Dowden, *Essays, Modern and Elizabethan*.

REED, JOSEPH (1741-1785), American politician, was born in Trenton, New Jersey, on the 27th of August 1741. He graduated at Princeton in 1757, studied law under Richard Stockton and, in 1763-65, at the Middle Temple, London, and practised in Trenton from 1765 until his removal to Philadelphia in 1770. He was president of the second Provincial Congress of Pennsylvania in 1775, was aide-de-camp and military secretary to General Washington in 1775-76, and was adjutant-general with the rank of colonel in 1776-77. He resigned his commission in the autumn of 1777, and in 1777-78 was a delegate to the Continental Congress. From December 1778 to October 1781 he was president of the state Executive Council. During his administration the proprietary rights of the Penn family were abrogated (1779), and provision was made for the gradual abolition of slavery (1780). During this time Reed led the attack on Benedict Arnold (*q.v.*) for the latter's administration of Philadelphia. Reed was elected to Congress in 1784, but died in Philadelphia on the 5th of March 1785.

The Life and Correspondence of Joseph Reed (2 vols., Philadelphia, 1874), by his grandson, William B. Reed, is based upon the family papers. It pictures Reed as an heroic patriot and statesman; George Bancroft, on the other hand, in the ninth volume (p. 229) of his *History* (1866) and in *Joseph Reed: an Historical Essay* (1867), pictures him as a trimmer of the most pronounced type. Bancroft's principal charge against Reed was based on a passage in Count Donop's diary referring to a Col. Reed protected by the British in 1776. In 1876, however, Mr W. S. Stryker discovered that the reference in the diary was really to Col. Charles Reed (1715-c. 1780). Bancroft withdrew this definite charge in the 1876 edition of his *History*, in which, however, his tone towards Joseph Reed was unchanged.

Joseph Reed's son, JOSEPH REED (1772-1846), published the *Laws of Pennsylvania* (5 vols., 1822-24), continuing the work of Charles Smith, published in 1810-12, which began with the laws of 1700. His grandson, WILLIAM BRADFORD REED (1806-1876), graduated at the university of Pennsylvania

in 1822, was a representative in the Pennsylvania legislature in 1834-35, attorney-general of the state in 1838, and a state senator in 1841. He was professor of American history in the university of Pennsylvania in 1850-56, United States minister to China in 1857-58, and in 1858 negotiated a treaty with China, proclaimed in 1860. Besides the biography of his grandfather mentioned above, he published one of Joseph Reed's wife, *Life of Esther De Berdt, afterwards Esther Reed* (1853).

W. B. Reed's brother, HENRY [HOPE] REED (1808-1854), graduated at the university of Pennsylvania in 1825, practised law in Philadelphia, and was assistant-professor of moral philosophy in the university of Pennsylvania in 1831-34 and professor of English literature and rhetoric there in 1835-54. He assisted Wordsworth in the preparation of an American edition of his poems in 1837, edited in America Christopher Wordsworth's *Memoirs of William Wordsworth* (1851) and published *Lectures on English Literature from Chaucer to Tennyson* (1855).

REED, THOMAS BRACKETT (1839-1902), American statesman, was born in Portland, Maine, on the 18th of October 1839. He graduated at Bowdoin College in 1860; was acting assistant-paymaster in the U.S. navy from April 1864 to November 1865; and in 1865 was admitted to the bar. He was a member of the Maine House of Representatives in 1868-69 and of the state Senate in 1870, was attorney-general of the state in 1870-72, and was city solicitor of Portland in 1874-77. He was a Republican member of the National House of Representatives from 1877 until 1899; was a member of the Potter Committee to investigate the disputed presidential election of 1876, and conducted the examination of Samuel J. Tilden; and he was Speaker of the House in 1889-91, and in 1895-99. He was a "strong" speaker in his control of the proceedings, and he developed an organized committee system, making the majority of the Committee on Rules consist of the speaker and chairman of the committees on ways and means and on appropriations. The "Reed Rules," drawn up by him, William McKinley and J. G. Cannon, were adopted on the 14th of February 1890; they provided that every member must vote, unless pecuniarily interested in a measure, that members present and not voting may be counted for a quorum, and that no dilatory motion be entertained by the speaker. His parliamentary methods were bitterly attacked by his political enemies, who called him "Tsar Reed." He greatly hastened the passage of the McKinley Bill in 1890, and of the Dingley Bill in 1897. His rules and methods of control of legislation were adopted by his successors in the speakership, and the power of the Rules Committee was greatly increased under Charles F. Crisp (1845-1896), Democratic speaker in 1891-1895. After the war with Spain Reed broke with the administration on the issue of imperialism. He resigned his seat in 1899 and practised law in New York City. He died in Washington on the 7th of December 1902. Reed was a remarkable personality, of whom many good stories were told, and opinions varied as to his conduct in the chair; but he was essentially a man of rugged honesty and power, whose death was a loss to American public life.

Reed's Rules were published as a parliamentary manual. He edited with others a *Library of Modern Eloquence* (10 vols., 1901). See the chapter on Reed in H. B. Fuller's *Speakers of the House* (Boston, 1909).

REED, a term applied to several distinct species of large, water-loving grasses. The common or water-reed, *Phragmites communis* (also known as *Arundo phragmites*), occurs along the margins of lakes, fens, marshes and placid streams, not only throughout Britain, but widely distributed in arctic and temperate regions. Another very important species in *Ammophila arenaria* (also known as *A. arundinacea* or *Psamma arenaria*), the sea-reed or marram-grass, a native of the sandy shores of Europe and N. Africa. Both species have been of notable geological importance, the former binding the soil and so impeding denudation, and actually converting swamp into dry land, largely by the

aid of its tall (5 to 10 ft.) close set stems. The latter species, of which the branching rootstocks may be traced 30 or even 40 ft., is of still greater importance in holding sand-dunes against the sea, and for this purpose has not only been long protected by law, but has been extensively planted on the coasts of Norfolk, Holland, Gascony, &c. Other reeds are *Calamagrostis* (various species), *Gynerium argenteum* (pampas grass), *Deyeuxia*, &c., also *Arundo Donax*, the largest European grass (6 to 12 ft. high), which is abundant in Europe. Reeds have been used from the earliest times in thatching and in other branches of construction, and also for arrows, the pipes of musical instruments, &c. Reed pens are still used in the East. Plants belonging to other orders occasionally share the name, especially the bur-reed (*Sparganium*) and the reed-mace (*Typha*), both belonging to the natural order Typhaceae. The bulrushes (*Scirpus*), belonging to the natural order Cyperaceae, are also to be distinguished.

REEDBUCK (Dutch *rietbok*), the popular name of a foxy red South African antelope (*Cervicapra arundinicum*) of medium size, with a moderately long bushy tail, a bare gland-patch behind the ear, and in the male rather short horns which bend forwards in a regular curve. There are several other species of allied African antelopes included in the genus *Cervicapra* to which the name of reedbuck is also applied, one of these ranging as far N. as Abyssinia, and another inhabiting W. Africa.

REED INSTRUMENTS (Fr. *instruments à anche*; Ger. *Blas-instrumente mit Zungen*; It. *Strumenti a ancia*), a class of wind instruments in the tubes of which sound-waves are generated by the vibrations of a reed mouthpiece. Reed instruments fall into two great classes: (1) those blown directly by the breath of the performer, who is thus able in all but a few obsolete instruments to express his emotional feelings in music; (2) those in which the wind supply is obtained by mechanical devices, such as the bag of bagpipe instruments or the bellows of such keyboard instruments as the regal, harmonium and kindred instruments.

Directly-blown reed instruments comprise the section of modern wind instruments known as the "wood wind," with the exception of flute and piccolo; they are classified according to the kind of reed vibrator of which the mouthpiece is composed. There are three kinds of reed mouthpieces: (1) the single or beating reed; (2) the double reed; (3) the free reed, all of which perform the function of sound-producer (see MOUTHPIECE and FREE REED VIBRATOR). The reed used consists of a thin tongue or strip of reed, cane or some elastic material, thinned gradually to a delicate edge. It is adapted to a resonating tube in such a manner that when it is at rest the opening at the mouthpiece end of the tube consists only of a very slight aperture or chink, which is periodically opened and closed by the pulsations of the reed when acted upon by the compressed breath of the player. This principle is common to all reed mouthpieces, and the difference in timbre is in a measure due to the manner in which the pulsations are brought about and the degree of elasticity secured.

The *double reed* consists of two blades of reed or laminae of elastic material tightly bound together by many turns of waxed silk, so that above the construction the tube has an oval section; below, where it communicates with the main bore of the instrument, the tube is strictly cylindrical. The chink here is formed by two thin walls of reed of equal elasticity (see OBOE, BASSOON). The double reed is common to the members of the oboe family, consisting, besides the oboe, of the cor anglais or tenor, of the fagotto or bassoon, and of the contra fagotto or double bassoon. The double reed mouthpiece is used besides on the sarrusophone family, instruments of brass but classed with the wood wind on account of the mouthpiece and fingering.

The *single or beating reed* consists of a single blade bevelled at the edge and placed over a table or frame communicating with the main bore of the instrument, against which it beats, causing a series of pulsations. The single reed is common to all the members of the clarinet family, consisting, besides the

clarinet, of the basset-horn or tenor, and of the bass and pedal clarinets; of the baryphone, an early bass clarinet, and of the saxophone, a metal oboe with a beating reed instead of a double reed. The ancient Greek aulos was undoubtedly used with a beating reed during some period of its history.

The *free reed* is not represented among members of the modern wood wind, and, as adapted to a directly-blown instrument, only finds application in the Chinese cheng, the prototype of the harmonium, and in the mouth organ or harmonica.

The reed in wind instruments produces a peculiar tone quality to which it has given its name; it varies in the three different kinds of mouthpieces without losing the fundamental reedy timbre. In the single reed the impact against the hard wood or vulcanite of the table against which it beats produces a sound harsh and strident in inverse proportion to the degree of elasticity possessed by the vibrating tongue. In the clarinet the reed is carefully and delicately made of cane with due regard to the interdependence of reed and clarinet tube. The strong wooden or metallic beating reeds of the early organ reed pipes must have had an unpleasantly harsh timbre, which won for them in Germany the epithet *Schnarrwerk*.

In the double reed the two delicately shaped pieces of reed vibrate against each other, producing the somewhat nasal, reedy tone of the oboe family. In the free reed compressed air is the only buffer which the vibrator encounters while swinging through the aperture, alternately closing and reopening it; hence the soft and mellow timbre which it is possible to produce by proper treatment of the free reed. Experience has shown that the best results for the double reed are obtained when it is used in conjunction with a tube of conical bore, whereas the beating reed is heard to greater advantage in instruments with cylindrical bore, one notable exception in practice being, as already mentioned, the saxophone family. The double reed adapted to a conical tube confers upon the latter the acoustic properties of the open pipe, whose wave-length is equal to that of the tube and which is capable of overblowing the octave and successive harmonics (theoretically). Either a single or a double reed adapted to a cylindrical pipe converts it for all acoustic purposes into a closed pipe, in which the whole wave-length is twice the length of the tube, a node forming at the mouthpiece end. The fundamental note of such a tube will therefore be an octave lower than that of an open pipe of the same length, and it can only overblow the uneven numbers of the harmonic series, such as the third harmonic (or twelfth above the fundamental).

In order to overblow on instruments with reed mouthpieces, greater pressure of breath must be exerted, and the vibrating length of the reed must be decreased by the action of the lips upon it. This is what occurs in instruments of the oboe and clarinet type, which are blown directly from the mouth. There are, however, cases in which the reed is concealed within the instrument out of reach of the lips, either in a capsule, as in the old instruments hautbois de Poitou and cromorne, or else in a socket, as in the chaunter and drones of the bagpipe, or, again, as in the mouthpieces of organ reed pipes. In the last (each of which gives but one fixed note) the vibrating length of the reed tongue is fixed, as is also the pressure of the compressed air supply fed to them. The result in all these cases is similar: no harmonics can be obtained, and therefore the scale of the instrument depends solely on the number of holes and keys provided, whereas, where the lips control the reed, fewer holes are necessary to produce any given compass. The chaunters of bagpipes have double reeds, but the drones are as a rule provided with beating reeds and are of cylindrical bore, a combination which, for the reason explained above, gives them a note an octave deeper in pitch, the length of pipe being equal, than would be the case if the bore were conical. In the musette, in the cornemuse used in concert with the hautbois de Poitou, and in the Neapolitan surdolina (see BAGPIPE), both chaunter and drones had double reeds.

The aulos of the ancient Greeks and tibia of the Romans consisted in the older instruments of a cylindrical tube of very narrow

bore, which facilitated the production of the harmonics. The aulos, though often erroneously translated flute, was an oboe or clarinet. Writers on musical instruments are not agreed as to which mouthpiece was in use on the aulos; the probability is that both were in use at one time or another, and that the double reed, being the most primitive and also the more adaptable, was the older contrivance. There is no sign of any suitable attachment for a beating reed on any of the pipes of ancient Greece extant, whereas among the ivory pipes recovered from the ruins of Pompeii there is a fragment which may have been a beak mouthpiece with beating reed similar to that of the modern clarinet.

The ancient Egyptians used the primitive beating reed familiarly known as "squeaker," obtained by making a slight lateral slit across a reed pipe or stem of straw, and with the knife splitting back longitudinally until a tongue was raised; the shorter the tongue the quicker the vibration and the higher the pitch. This small beating reed was then sunk some 3 or 4 in. within the main tube of the instrument; some of these reeds have been discovered in tombs by Professor Flinders Petrie.¹ It is certain that the ancient Greeks did not use the reed in this form in the aulos, for classical writers distinctly describe the effect produced on a reed by taking it into the mouth, but it is equally certain that they were acquainted with the principle of the drone.

The history of the keyboard instruments furnishes instances of the early use of reeds. In the modern English church organ the reed work is provided with beating reeds only, but in Germany, for the sake of obtaining the power of expression, a set of free-reed stops is nearly always added.² It is probable that some of the early pneumatic and hydraulic organs (see ORGAN) at the beginning of our era were provided with beating reeds in imitation of the bagpipe chaunter and drones. In the middle ages the regal (*q.v.*), a small, portable reed-organ fitted with beating reeds, was extremely popular in England and all over the continent of Europe, but more especially in Germany and Italy. (K. S.)

REEF (1) (Du. *rif*, cf. Ger. *Riff*, Swed. *ref*, &c., all from O. Nor. *rif*, *rið*), in physical geography, a narrow ridge of rock, shingle or sand culminating at or near the surface of the sea. In a transformed sense the word is used in mining of a vein or lode of gold-bearing quartz; (2) (Du. *reef*, *rif*, cf. Ger. *Reff*, Swed. *raf*, O. Nor. *rif*, possibly a transferred sense of *rif*, *rið*), a part of a sail which can be rolled or folded up, thus diminishing the amount of canvas spread to the wind. In square sails, "reefs" are taken from the top, in fore-and-aft sails from the foot.

REEL (O.E. *hréol*, glossed by the Med. Lat. *alibrum* in *Aelfric's Glossary*, c. 1050; the word is of unknown origin; it does not appear in cognate languages, and Celtic forms such as Gaelic *ruidhil* are from English), a cylinder or apparatus of cylindrical shape on which a thread or line can be wound; e.g. the small wooden cylinder with projecting rims at either end on which sewing cotton or silk is wound for immediate use, the revolving "click-reel" attached to a fishing-rod, and the open revolving framework on which thread is wound as it is spun. The name of the Scottish dance (Gaelic *righil*, *ruithil*) is probably the same word (see DANCE). In architecture, an ornamental moulding consisting of spherical-shaped bodies alternating with flat reel-shaped disks placed on edge is known as a "bead and reel" moulding.

REES, THOMAS (1777-1864), Welsh Nonconformist divine, was born at Gelligrön, Glamorgan, and educated at the Presbyterian College, Carmarthen. He entered the Unitarian ministry in 1807 at Newington Green Chapel, London, removing to Southwark 1813 and to Stamford Street, Blackfriars, in 1823. He had the degree of LL.D. of Glasgow (1819). He had a great knowledge of the history of anti-trinitarian opinion, especially during the 16th century. His scattered papers, chiefly in the *Monthly Repository* (1818-22), on such subjects as "Faustus Socinus and Francis David," "The Italian Reformation," "Memoirs of the Socini," are important. Financial troubles drove him to Spain in 1853, and he died in obscurity at Brighton on the 1st of August 1864.

Another THOMAS REES (1815-1885), a native of Pen Pontbren, Carmarthenshire, held pastorates at Aberdare (1840), Llanelly (1842), Cendl, Mon. (1849) and Swansea (1862).

¹ An illustration of one of these is given in T. L. Southgate's paper, "The Regal and its Successors," in *English Music*, 1604-1904, Music Story Series, 1906, p. 385.

² The addition dates from the very end of the 18th or the beginning of the 19th century, and is connected with the advent of the harmonium (*q.v.*).

and became chairman of the Congregational Union of England and Wales, but died just before his term of office was to begin. His *History of Protestant Nonconformity in Wales* (1861; 2nd ed. 1883) is a sound and judicious piece of work.

REEVE, CLARA (1729-1807), English novelist, daughter of William Reeve, a Suffolk clergyman, was born at Ipswich in 1729. She was an industrious writer, and produced many works in prose and verse, including a history of the *Progress of Romance* (1785); but her only eminent success was the novel of *The Old English Baron* (1777), originally published under the title of *The Champion of Virtue*. In the history of the English novel she stands midway between Walpole and Mrs. Radcliffe. She died at Ipswich on the 3rd of December 1807.

REEVE, HENRY (1813-1895), English publicist, younger son of Henry Reeve, a well-known Whig physician and writer of Norwich, and nephew of Mrs. Sarah Austin, was born at Norwich on the 9th of September 1813. He was educated at the Norwich grammar school under Edward Valpy. During his holidays he saw a good deal of the young John Stuart Mill. In 1829 he studied at Geneva and mixed in Genevese society, then very brilliant, and including the Sismondis, Huber, Bonstetten, De Candolle, Rossil, Krasinski (his most intimate friend), and Mickiewicz, whose *Paris* he translated. During a visit to London in 1831 he was introduced to Thackeray and Carlyle, while through the Austins he made the acquaintance of other men of letters. Next year, in Paris, he met Victor Hugo, Cousin, and Scott. He travelled in Italy, sat under Schelling at Munich and under Tieck at Dresden, became in 1835-36 a frequenter of Madame de Circourt's salon, and numbered among his friends Lamartine, Lacordaire, De Vigny, Thiers, Guizot, Montalembert, and De Tocqueville, of whose books, *Démocratie en Amérique* and the *Ancien régime*, he made standard translations into English. In 1837 he was made clerk of appeal and then registrar to the judicial committee of the Privy Council. From 1840 to 1855 he wrote for *The Times*, his close touch with men like Guizot, Bunsen, Lord Clarendon, and his own chief at the Privy Council Office, Charles Greville, enabling him to write with authority on foreign policy during the critical period from 1848 to the end of the Crimean War. Upon the promotion of Sir George Cornewall Lewis to the Cabinet early in 1855 Reeve was asked by Longman to edit the April number of the *Edinburgh Review*, to which his father had been one of the earliest contributors, and in the following July he became the editor. His friendship with the Orleanist leaders in France survived all vicissitudes, but he was appealed to for guidance by successive French ambassadors, and was more than once the medium of private negotiations between the English and French governments. In April 1863 he published what was perhaps the most important of his contributions to the *Edinburgh*—a searching review of Kinglake's *Crimea*; and in 1872 he brought out a selection of his *Quarterly and Edinburgh* articles on eminent Frenchmen, entitled *Royal and Republican France*. Three years later appeared the first of three instalments (1875, 1885 and 1887) of his edition of the famous *Memoirs* which Charles Greville had placed in his hands a few hours before his death in 1865. A purist in point of form and style, of the school of Macaulay and Milman, Reeve outlived his literary generation, and became eventually one of the most reactionary of old Whigs. Yet he continued to edit and upon the whole to maintain the reputation of the *Edinburgh* until his death at his seat of Foxholes, in Hants, on the 21st of October 1895. He had been elected a member of "The Club" in 1861, and was made a D.C.L. by Oxford University in 1869, a C.B. in 1871, and a corresponding member of the French Institute in 1865. A striking panegyric was pronounced upon him by his lifelong friend, the duc d'Aumale, before the Académie des Sciences in November 1895.

His *Memoirs and Letters* (2 vols., with portrait) were edited by Sir J. K. Laughton, in 1898. (T. SE.)

REEVE (O. E. *gerefa*), an English official who in early times was entrusted with the administration of a division of the country. He was the chief magistrate of a town or district.

and is the ancestor of the sheriff, the shire-reeve. In addition to the sheriff there were several kinds of reeves, and we are told in the body of laws known as the laws of Edward the Confessor that it is "multiplex nomen; greve enim dicitur de scira, de wapentagiis, de hundredis, de burgis, de villis." Thus we hear of port-reeves, burg-reeves, and tun-reeves, while the Anglo-Saxon Chronicle mentions high reeves. It was the tun-reeve or reve of the township who with four other men represented the township in the courts of the hundred and the shire. In free townships he was probably chosen by the inhabitants; in dependent townships by the lord. A little later there were manor reeves, these being elected by the villains; according to Fleta, their duties were to attend to the cultivation of the land, and to see that each villain performed his proper share of service. The reve of Chaucer's *Canterbury Tales* was doubtless a steward or bailiff, something equivalent to the grievé in Scotland to-day.

In early English the word reeve was sometimes used as a translation for the prefect or governor of Roman and Jewish times. Some authorities have thought that there is some connexion between the Anglo-Saxon *gerefa* and the German *Graf*, but Max Müller (*Lectures on the Science of Language*, 1885) is inclined to doubt this. J. M. Kemble (*Saxons in England*, 1876), who goes at length into the history of the reeve, connects the word with *rōfan* or *rēfan*, to call aloud, this making him the original of the *bannitor*, or proclaimer of the court. At the present time the word reeve is sometimes used to describe a foreman or overseer in a coal mine. It is also used in Canada for the president of a village or town council.

REEVES, JOHN SIMS (1818-1900), English vocalist, was born at Woolwich on the 26th of September 1818, and received his musical education from his father, a musician in the Royal Artillery. At the age of fourteen he had progressed so far as to be appointed organist of North Cray church, and could play the oboe, bassoon, violin, and violoncello. He

seems to have studied medicine for a year, but changed his mind when he gained his adult voice: it was at first a baritone, and he made his earliest appearance at Newcastle in 1839 in various baritone parts. He studied with Hobbs and T. Cooke, and, his voice having become a tenor, he appeared under Macready's management at Drury Lane (1841-43) in subordinate tenor parts in Purcell's *King Arthur*, *Der Freischütz*, and *Acis and Galatea*, when Handel's pastoral was mounted on the stage with Stanfield's scenery. Four years were spent in study on the Continent, under Bordogni in Paris and Mazzucato in Milan, and his *début* in Italian opera was made at the Scala as Edgardo in *Lucia*. He reappeared in London in May 1847 at a benefit concert for Vincent Wallace, and at one of the Ancient Concerts in the following month, his career on the English operatic stage beginning at Drury Lane in December 1847 in *Lucia*, under the conductorship of Hector Berlioz. In Balfe's *Maid of Honour* he created the part of Lyonnell in the same season. In 1848 he went to Her Majesty's Theatre, singing in *Linda di Chamounix*; and in the autumn of that year, at the Norwich Festival, made a great sensation in "The enemy said," from *Israel in Egypt*, a song in which the finest qualities of his ringing voice could be appreciated. From his first appearance at the Sacred Harmonic Society in the following November he was recognized as the leading English tenor; and in Costa's *Eli* and *Naaman* the tenor parts were written for him. His first Handel Festival was that of 1857, and the effect of his wonderful declamation in the Crystal Palace was a main attraction of this and of many subsequent festivals. His retirement from public life, at first announced as to take place in 1882, did not actually occur till 1891, when a farewell concert for his benefit was given at the Albert Hall. His savings were invested in an unfortunate speculation, and he was compelled to reappear in public for a number of years. He died at Worthing on the 25th of October 1900.

END OF TWENTY-SECOND VOLUME

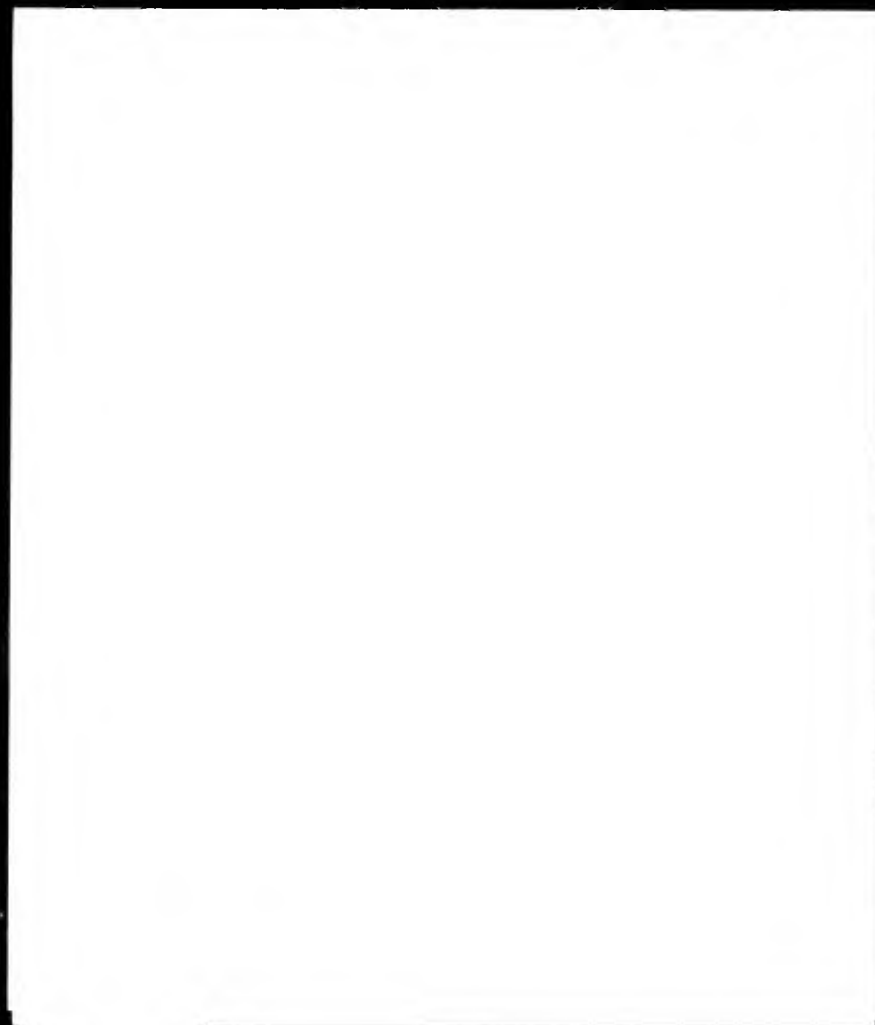

THE
ENCYCLOPÆDIA
BRITANNICA
ELEVENTH
EDITION

VOL. XXII
POL. TO REE